

FCC Information and Copyright

This equipment has been tested and found to comply with the limits of a Class B digital device, pursuant to Part 15 of the FCC Rules. These limits are designed to provide reasonable protection against harmful interference in a residential installation. This equipment generates, uses and can radiate radio frequency energy and, if not installed and used in accordance with the instructions, may cause harmful interference to radio communications. There is no guarantee that interference will not occur in a particular installation.

The vendor makes no representations or warranties with respect to the contents here and specially disclaims any implied warranties of merchantability or fitness for any purpose. Further the vendor reserves the right to revise this publication and to make changes to the contents here without obligation to notify any party beforehand.

Duplication of this publication, in part or in whole, is not allowed without first obtaining the vendor's approval in writing.

The content of this user's manual is subject to be changed without notice and we will not be responsible for any mistakes found in this user's manual. All the brand and product names are trademarks of their respective companies.

Table of Contents

Chapter 1: Introduction	1
1.1 Before You Start	1
1.2 Package Checklist	1
1.3 Motherboard Features	2
1.4 Rear Panel Connectors	3
1.5 Motherboard Layout for NF4 AM2L / NF4 AM2G	4
1.6 Motherboard Layout for NF4U AM2G	5
Chapter 2: Hardware Installation	6
2.1 Installing Central Processing Unit (CPU)	6
2.2 FAN Headers	8
2.3 Installing System Memory	9
2.4 Connectors and Slots	11
Chapter 3: Headers & Jumpers Setup	13
3.1 How to Setup Jumpers	13
3.2 Detail Settings	13
Chapter 4: NVIDIA RAID Functions	20
4.1 Operation System	20
4.2 Raid Arrays	20
4.3 How RAID Works	20
Chapter 5: Useful Help	24
5.1 Driver Installation Note	24
5.2 Award BIOS Beep Code	25
5.3 Extra Information	25
5.4 Troubleshooting	27
Chapter 6: WarpSpeeder™	28
6.1 Introduction	28
6.2 System Requirement	28
6.3 Installation	29
6.4 WarpSpeeder™	30
Appendices: SPEC In Other Language	36
German	36
France	38
Italian	40
Spanish	42
Portuguese	44
Polish	46
RUSSIAN	48
ARABIC	50
JAPANESE	52

CHAPTER 1: INTRODUCTION

1.1 BEFORE YOU START

Thank you for choosing our product. Before you start installing the motherboard, please make sure you follow the instructions below:

- Prepare a dry and stable working environment with sufficient lighting.
- Always disconnect the computer from power outlet before operation.
- Before you take the motherboard out from anti-static bag, ground yourself properly by touching any safely grounded appliance, or use grounded wrist strap to remove the static charge.
- Avoid touching the components on motherboard or the rear side of the board unless necessary. Hold the board on the edge, do not try to bend or flex the board.
- Do not leave any unfastened small parts inside the case after installation. Loose parts will cause short circuits which may damage the equipment.
- Keep the computer from dangerous area, such as heat source, humid air and water.

1.2 PACKAGE CHECKLIST

- ✦ FDD Cable X 1
- ✦ HDD Cable X 1
- ✦ Serial ATA Cable X 1
- ✦ Rear I/O Panel for ATX Case X 1
- ✦ User's Manual X 1
- ✦ Fully Setup Driver CD X 1
- ✦ USB 2.0 Cable X1 (optional)
- ✦ S/PDIF out Cable X 1 (optional)

1.3 MOTHERBOARD FEATURES

	NF4 AM2G / NF4 AM2L	NF4U AM2G
CPU	Socket AM2 AMD Athlon 64 / Athlon 64 FX / Athlon 64X2 / Sempron processors AMD 64 Architecture enables 32 and 64 bit computing Supports Hyper Transport and Cool'nQuiet	Socket AM2 AMD Athlon 64 / Athlon 64 FX / Athlon 64X2 / Sempron processors AMD 64 Architecture enables 32 and 64 bit computing Supports Hyper Transport and Cool'nQuiet
FSB	Support HyperTransport Supports up to 1000 MHz Bandwidth	Support HyperTransport Supports up to 1000 MHz Bandwidth
Chipset	nVIDIA nForce 4	nVIDIA nForce 4 Ultra
Super I/O	ITE 8712F / 8716F Provides the most commonly used legacy Super I/O functionality Low Pin Count Interface	ITE 8712F / 8716F Provides the most commonly used legacy Super I/O functionality Low Pin Count Interface
Main Memory	DIMM Slots x 4 Each DIMM supports 256/512MB & 1GB DDR2 Max Memory Capacity 4GB Dual Channel Mode DDR2 memory module Supports DDR2 400 / 533 / 667 / 800 Registered DIMM and Non-ECC DIMM is not supported	DIMM Slots x 4 Each DIMM supports 256/512MB & 1GB DDR2 Max Memory Capacity 4GB Dual Channel Mode DDR2 memory module Supports DDR2 400 / 533 / 667 / 800 Registered DIMM and Non-ECC DIMM is not supported
IDE	Integrated IDE Controller Ultra DMA 33 / 66 / 100 / 133 Bus Master Mode	Integrated IDE Controller Ultra DMA 33 / 66 / 100 / 133 Bus Master Mode
SATA	Integrated Serial ATA Controller Data transfer rates up to 1.5 Gb/s. SATA Version 1.0 specification compliant.	Integrated Serial ATA Controller Data transfer rates up to 3.0 Gb/s. SATA Version 2.0 specification compliant.
LAN	Marvell 88E3016 PHY for NF4 AM2L 10 / 100 Mb/s Auto-Negotiation Marvell 88E1116 PHY for NF4 AM2G 10 / 100 / 1000 Mb/s Auto-Negotiation	Marvell 88E1116 PHY 10 / 100 / 1000 Mb/s Auto-Negotiation
Sound	ALC 655 / 658 (optional) 6 channels audio out AC 97 Version 2.3	ALC 655 / 658 (optional) 6 channels audio out AC 97 Version 2.3
Slots	PCI slot x4 PCI Express x16 slot x1 PCI Express x 1 slot x2	PCI slot x4 PCI Express x16 slot x1 PCI Express x 1 slot x2
On Board Connector	Floppy connector x1 Printer Port connector x1	Floppy connector x1 Printer Port connector x1

NF4 AM2G / NF4 AM2L / NF4UAM2G

	IDE Connector	x2	IDE Connector	x2
	SATA Connector	x4	SATA Connector	x4
	Front Panel Connector	x1	Front Panel Connector	x1
	Front Audio Connector	x1	Front Audio Connector	x1
	CD-in Connector	x1	CD-in Connector	x1
	S/PDIF out connector	x1	S/PDIF out connector	x1
	CPU Fan header	x1	CPU Fan header	x1
	System Fan header	x3	System Fan header	x3
	Chassis open header (optional)	x1	Chassis open header (optional)	x1
	CMOS clear header	x1	CMOS clear header	x1
	USB connector	x3	USB connector	x3
	Power Connector (24pin)	x1	Power Connector (24pin)	x1
	Power Connector (4pin)	x1	Power Connector (4pin)	x1
Back Panel I/O	PS/2 Keyboard	x1	PS/2 Keyboard	x1
	PS/2 Mouse	x1	PS/2 Mouse	x1
	Serial Port	x1	Serial Port	x1
	LAN port	x1	LAN port	x1
	USB Port	x4	USB Port	x4
	Audio Jack	x3	Audio Jack	x3
Board Size	218 x 293 (mm)		218 x 293 (mm)	
Special Features	NVIDIA nTunes		NVIDIA nTunes	
	NVIDIA firewall (for NF4AM2G only)		NVIDIA firewall	
	RAID 0 / 1 / 0+1 support		RAID 0 / 1 / 0+1 / 5 support	
OS Support	Windows 2K / XP		Windows 2K / XP	
	Biostar Reserves the right to add or remove support for any OS With or without notice.		Biostar Reserves the right to add or remove support for any OS With or without notice.	

1.4 REAR PANEL CONNECTORS

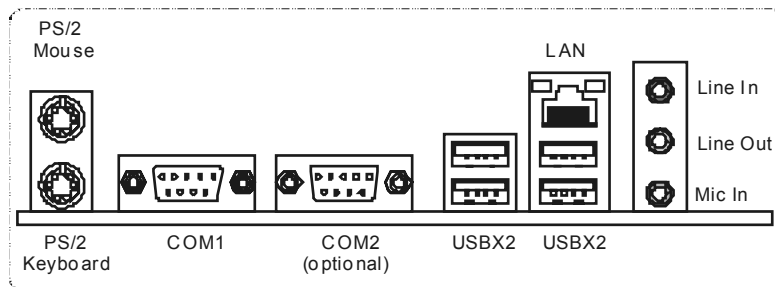

1.5 MOTHERBOARD LAYOUT FOR NF4 AM2L / NF4 AM2G

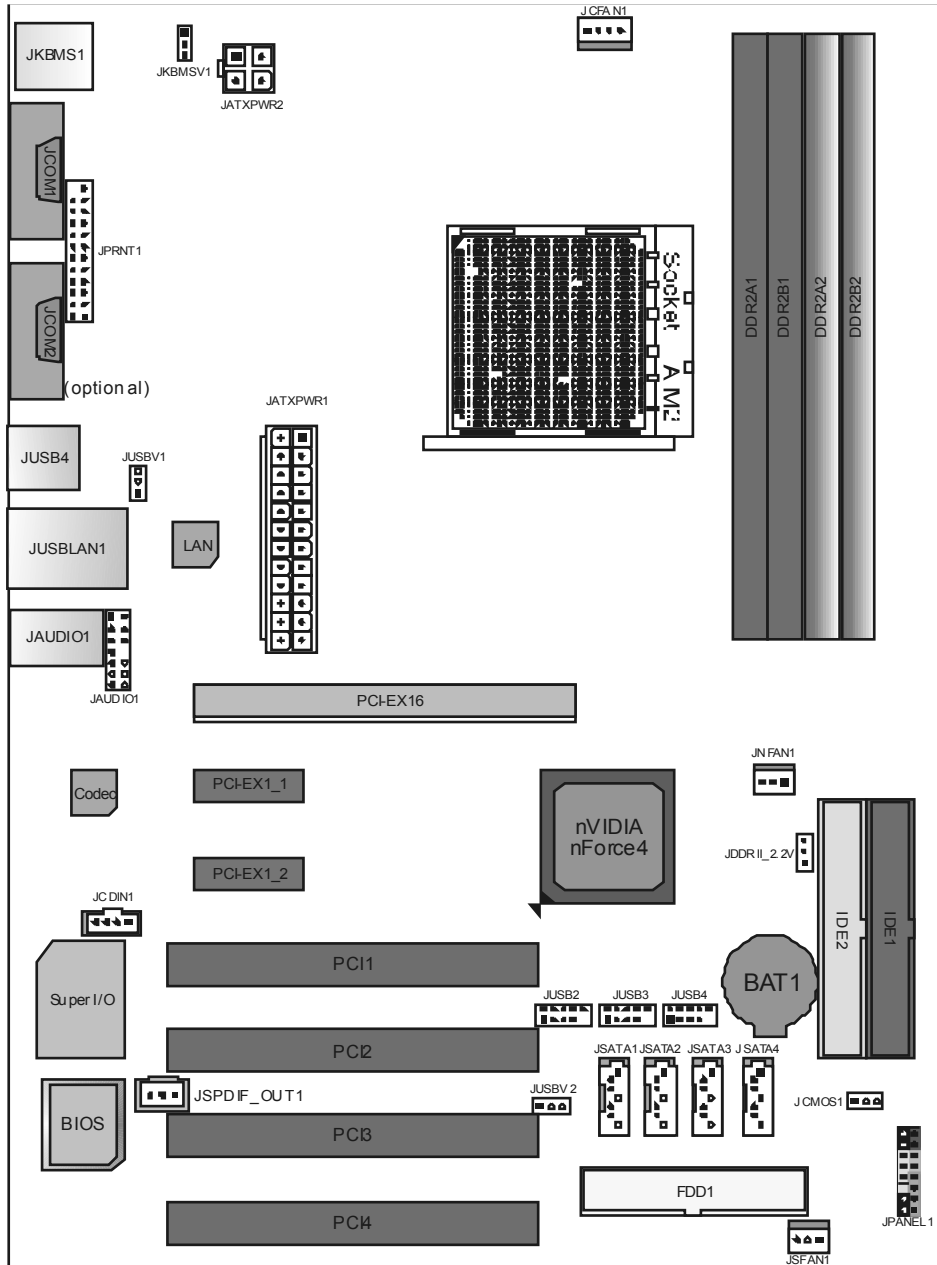

Note: ■ represents the 1st pin.

1.6 MOTHERBOARD LAYOUT FOR NF4U AM2G

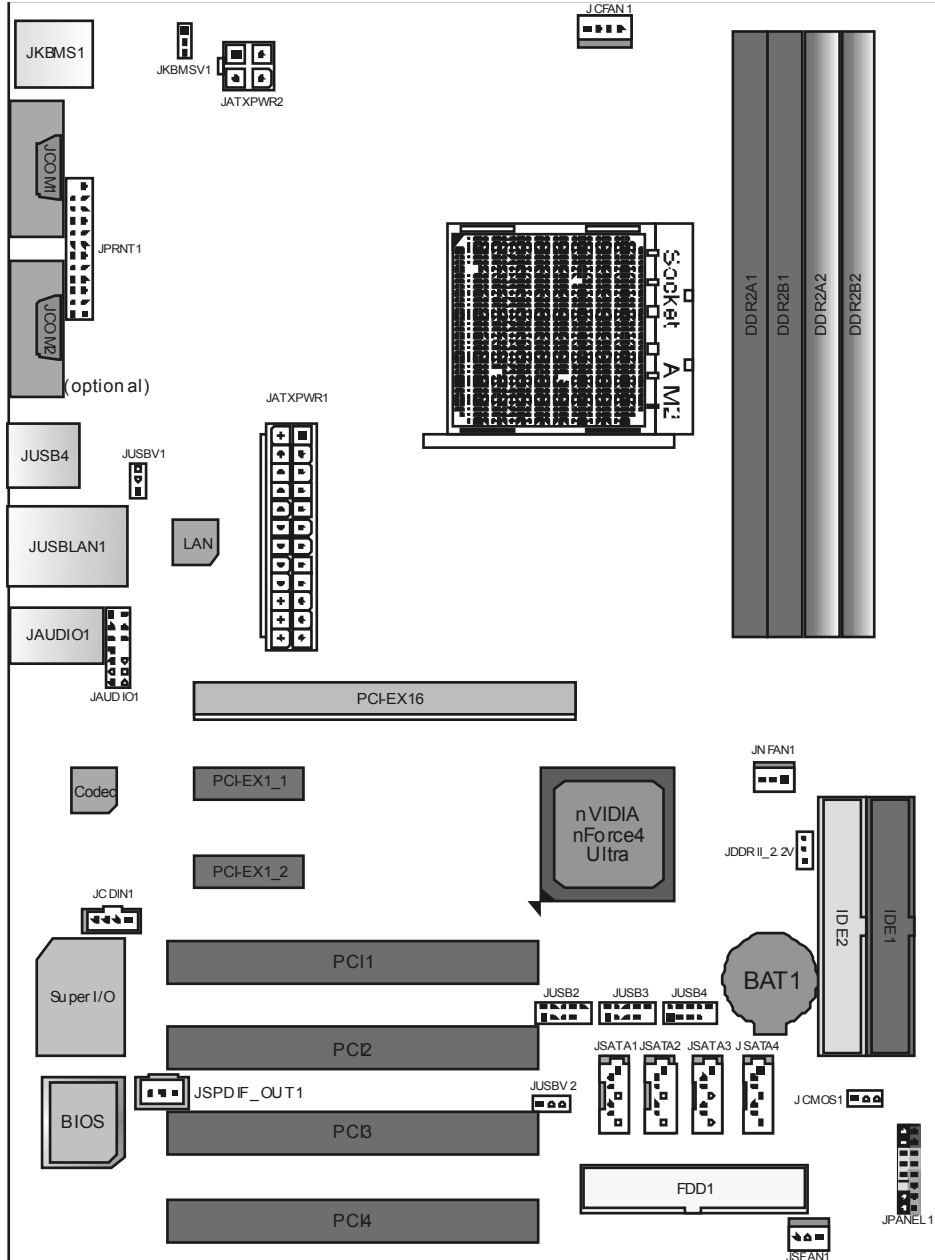

Note: ■ represents the 1st pin.

CHAPTER 2: HARDWARE INSTALLATION

2.1 INSTALLING CENTRAL PROCESSING UNIT (CPU)

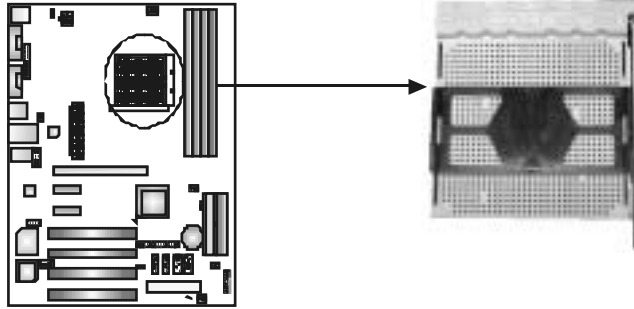

Step 1: Remove the socket protection cap.

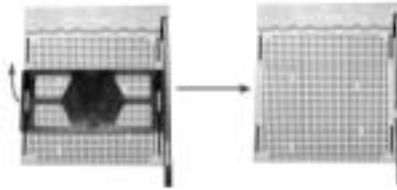

Step 2: Pull the lever toward direction A from the socket and then raise the lever up to a 90-degree angle.

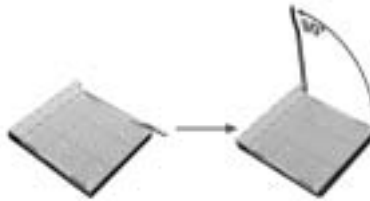

Step 3: Look for the white triangle on socket, and the gold triangle on CPU should point towards this white triangle. The CPU will fit only in the correct orientation.



NF4 AM2G / NF4 AM2L / NF4UAM2G

Step 4: Hold the CPU down firmly, and then close the lever toward direct B to complete the installation.

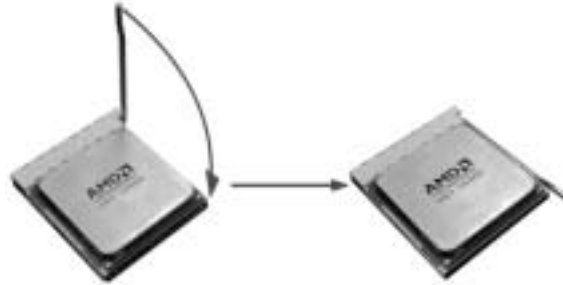

Step 5: Put the CPU Fan on the CPU and buckle it. Connect the CPU FAN power cable to the JCFAN1. This completes the installation.

2.2 FAN HEADERS

These fan headers support cooling-fans built in the computer. The fan cable and connector may be different according to the fan manufacturer. Connect the fan cable to the connector while matching the black wire to pin#1.

JCFAN1: CPU Fan Header

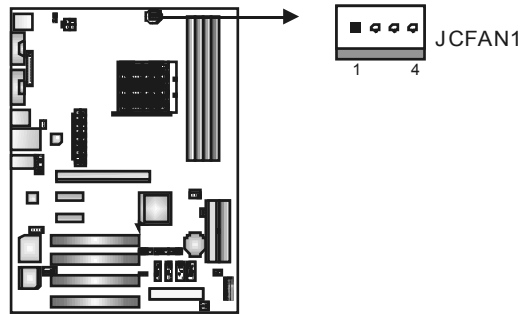

Pin	Assignment
1	Ground
2	Smart Fan Control
3	FAN RPM rate sense
4	Smart Fan Control (By Fan)

JSFAN1: System Fan Header

JNFAN1: North Bridge Fan Header

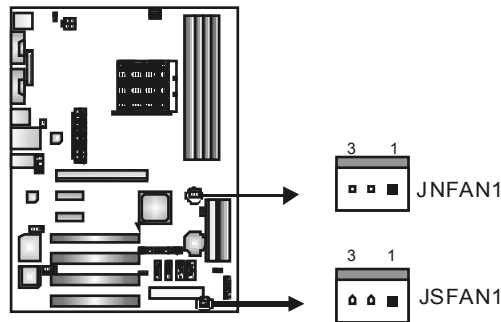

Pin	Assignment
1	Ground
2	+12V
3	FAN RPM rate sense

Note:

The JSFAN1 and JNFAN1 s support 3-pin head connector. When connecting with wires onto connectors, please note that the red wire is the positive and should be connected to pin#2, and the black wire is Ground and should be connected to GND.

2.3 INSTALLING SYSTEM MEMORY

A. Memory Modules

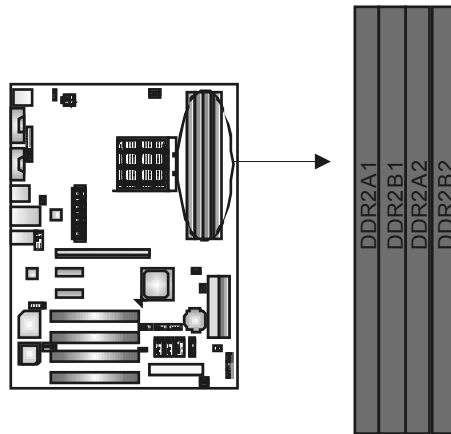

1. Unlock a DIMM slot by pressing the retaining dips outward. Align a DIMM on the slot such that the notch on the DIMM matches the break on the Slot.

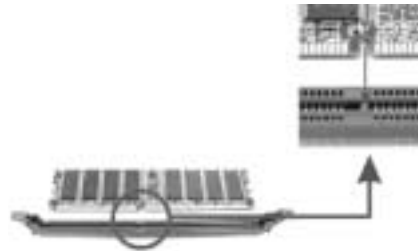

2. Insert the DIMM vertically and firmly into the slot until the retaining chip snap back in place and the DIMM is properly seated.



B. Memory Capacity

DIMM Socket Location	DDR Module	Total Memory Size
DDR2A1	256MB/512MB/1024MB	Max is 4GB.
DDR2B1	256MB/512MB/1024MB	
DDR2A2	256MB/512MB/1024MB	
DDR2B2	256MB/512MB/1024MB	

C. Dual Channel Memory installation

To trigger the Dual Channel function of the motherboard, the memory module must meet the following requirements:

Install memory module of the same density in pairs, shown in the following table.

Dual Channel Status	DDR2A1	DDR2B1	DDR2A2	DDR2B2
Enabled	O	O	X	X
Enabled	X	X	O	O
Enabled	O	O	O	O

(O means memory installed, X means memory not installed.)

The DRAM bus width of the memory module must be the same (x8 or x16)

2.4 CONNECTORS AND SLOTS

FDD1: Floppy Disk Connector

The motherboard provides a standard floppy disk connector that supports 360K, 720K, 1.2M, 1.44M and 2.88M floppy disk types. This connector supports the provided floppy drive ribbon cables.

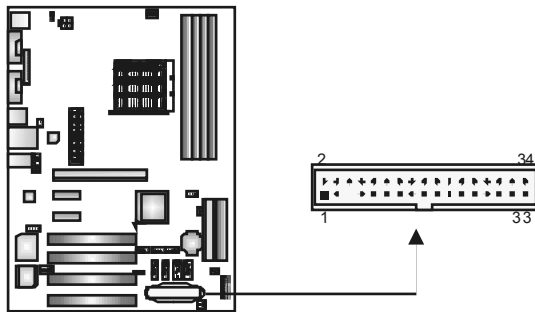

IDE1/IDE2: Hard Disk Connectors

The motherboard has a 32-bit Enhanced PCI IDE Controller that provides PIO Mode 0~4, Bus Master, and Ultra DMA 33/66/100/133 functionality. It has two HDD connectors IDE1 (primary) and IDE2 (secondary).

The IDE connectors can connect a master and a slave drive, so you can connect up to four hard disk drives. The first hard drive should always be connected to IDE1.

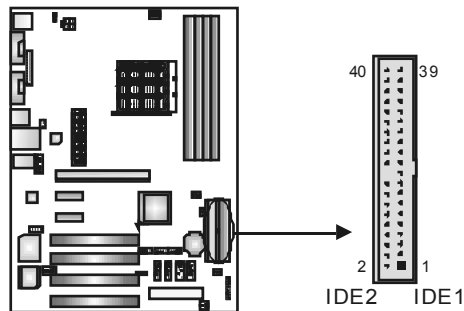

PCI-Ex16: PCI-Express x16 Slot

- PCI-Express 1.0a compliant.
- Maximum theoretical realized bandwidth of 4GB/s simultaneously per direction, for an aggregate of 8GB/s totally.

PCI-Ex1_1/PCI-Ex1_2: PCI-Express x1 slots

- PCI-Express 1.0a compliant.
- Data transfer bandwidth up to 250MB/s per direction; 500MB/s in total.
- PCI-Express supports a raw bit-rate of 2.5Gb/s on the data pins.
- 2X bandwidth over the traditional PCI architecture.

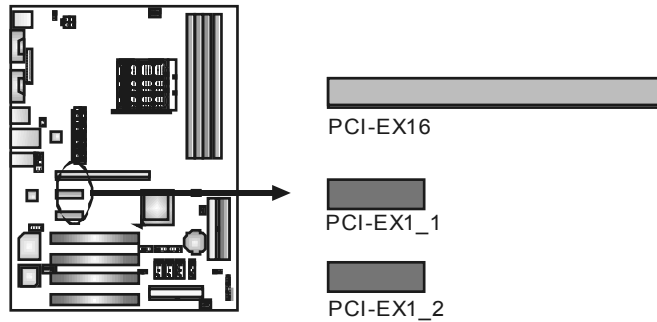

PCI1~PCI4: Peripheral Component Interconnect Slots

This motherboard is equipped with 4 standard PCI slots. PCI stands for Peripheral Component Interconnect, and it is a bus standard for expansion cards. This PCI slot is designated as 32 bits.

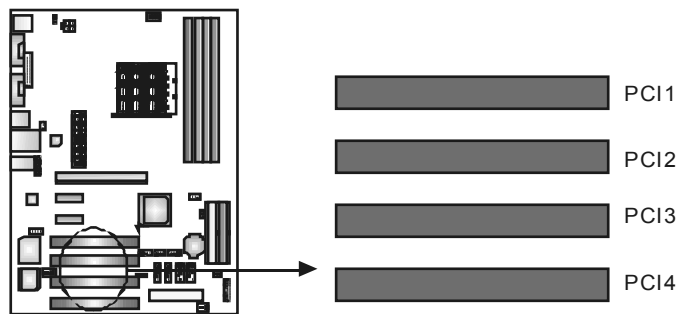

CHAPTER 3: HEADERS & JUMPERS SETUP

3.1 HOW TO SETUP JUMPERS

The illustration shows how to set up jumpers. When the jumper cap is placed on pins, the jumper is “close”, if not, that means the jumper is “open”.



3.2 DETAIL SETTINGS

JPANEL1: Front Panel Header

This 16-pin connector includes Power-on, Reset, HDD LED, Power LED, Sleep and speaker connection. It allows user to connect the PC case’s front panel switch functions.

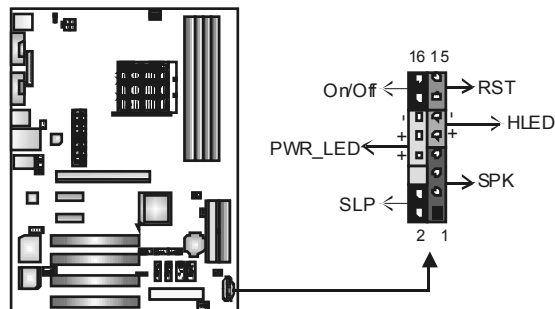

Pin	Assignment	Function	Pin	Assignment	Function
1	+5V	Speaker Connector	9	Sleep control	Sleep button
2	N/A		10	Ground	
3	N/A		11	N/A	N/A
4	Speaker	Hard drive LED	12	Power LED (+)	Power LED
5	HDD LED (+)		13	Power LED (+)	
6	HDD LED (-)	Reset button	14	Power LED (-)	Power-on button
7	Ground		15	Power button	
8	Reset control		16	Ground	

JATXPWR1: ATX Power Source Connector

This connector allows user to connect 24-pin power connector on the ATX power supply.

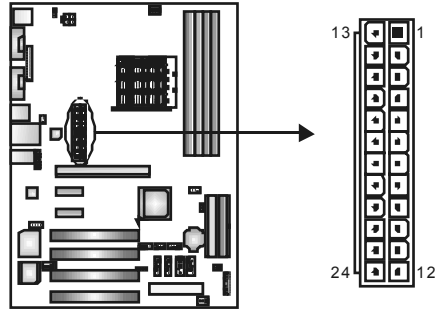

Pin	Assignment	Pin	Assignment
13	+3.3V	1	+3.3V
14	-12V	2	+3.3V
15	Ground	3	Ground
16	PS_ON	4	+5V
17	Ground	5	Ground
18	Ground	6	+5V
19	Ground	7	Ground
20	NC	8	PW_OK
21	+5V	9	Standby Voltage+5V
22	+5V	10	+12V
23	+5V	11	+12V
24	Ground	12	+3.3V

JATXPWR2: ATX Power Source Connector

By connecting this connector, it will provide +12V to CPU power circuit.

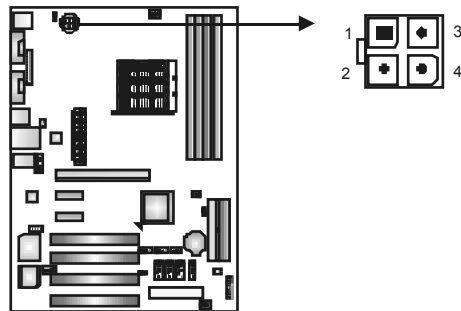

Pin	Assignment
1	+12V
2	+12V
3	Ground
4	Ground

JKBMSV1: Power Source Selection Headers for Keyboard/Mouse

Pin 1-2 Close:

JKBMSV1: +5V for PS/2 key board and mouse.

Pin 2-3 Close:

JKBMSV1: PS/2 keyboard and mouse are powered with +5V standby voltage.

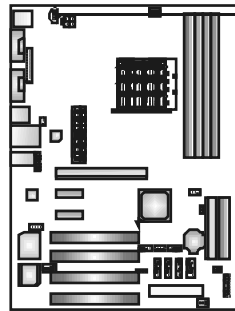

Pin 1-2 close



Pin 2-3 close

JUSB2/JUSB3/JUSB4: Headers for USB 2.0 Ports at Front Panel

This header allows user to connect additional USB cable on the PC front panel, and also can be connected with internal USB devices, like USB card reader.

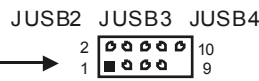
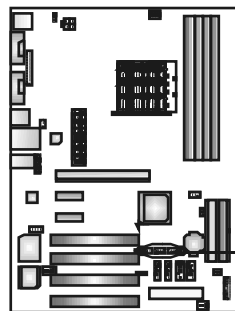

Pin	Assignment
1	+5V (fused)
2	+5V (fused)
3	USB-
4	USB-
5	USB+
6	USB+
7	Ground
8	Ground
9	Key
10	NC

JUSBV1/JUSBV2: Power Source Headers for USB Ports

Pin 1-2 Close:

JUSBV1: +5V for USB ports at JUSBLAN1.

JUSBV2: +5V for USB ports at front panel (JUSB1/JUSB2/JUSB3).

Pin 2-3 Close:

JUSBV1: USB ports at JUSBLAN1 are powered by +5V standby voltage.

JUSBV2: USB ports at front panel (JUSB1/JUSB2/JUSB3) are powered by +5V standby voltage.

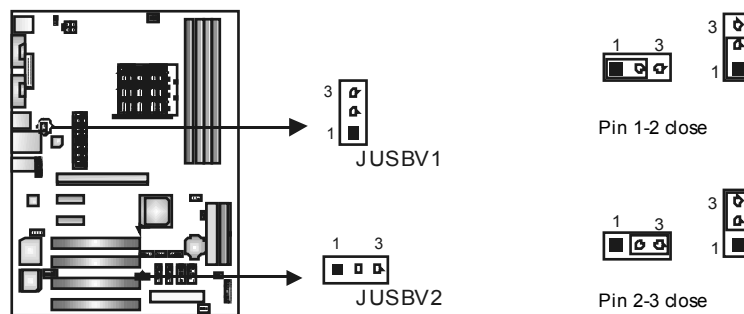

Note:

In order to support this function “Power-On system via a USB device,” “JUSBV1/ JUSBV2” jumper cap should be placed on Pin 2-3 individually.

JFAUDIO1: Front Panel Audio Header

This header allows user to connect the front audio output cable with the PC front panel. It will disable the output on back panel audio connectors.

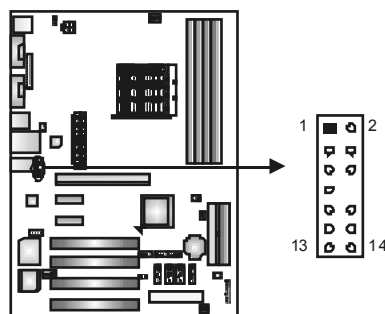

Pin	Assignment
1	Mic in/center
2	Ground
3	Mic power/Bass
4	Audio power
5	Right line out/ Speaker out Right
6	Right line out/ Speaker out Right
7	Reserved
8	Key
9	Left line out/ Speaker out Left
10	Left line out/ Speaker out Left
11	Right line in/ Rear speaker Right
12	Right line in/ Rear speaker Right
13	Left line in/ Rear speaker Left
14	Left line in/ Rear speaker Left

JCDIN1: CD-ROM Audio-in Connector

This connector allows user to connect the audio source from the variety devices, like CD-ROM, DVD-ROM, PCI sound card, PCI TV tuner card etc..

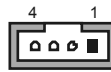
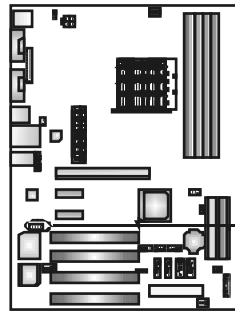

Pin	Assignment
1	Left Channel Input
2	Ground
3	Ground
4	Right Channel Input

JCMOS1: Clear CMOS Header

By placing the jumper on pin2-3, it allows user to restore the BIOS safe setting and the CMOS data, please carefully follow the procedures to avoid damaging the motherboard.

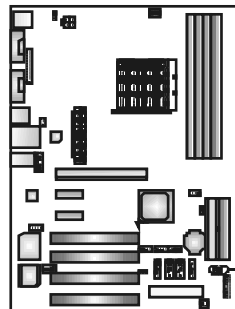

Pin 1-2 Close:
Normal Operation (default).



Pin 2-3 Close:
Clear CMOS data.

※ Clear CMOS Procedures:

1. Remove AC power line.
2. Set the jumper to "Pin 2-3 close".
3. Wait for five seconds.
4. Set the jumper to "Pin 1-2 close".
5. Power on the AC.
6. Reset your desired password or clear the CMOS data.

JSATA1~JSATA4: Serial ATA Connectors

The motherboard has a PCI to SATA Controller with 4 channels SATA interface.

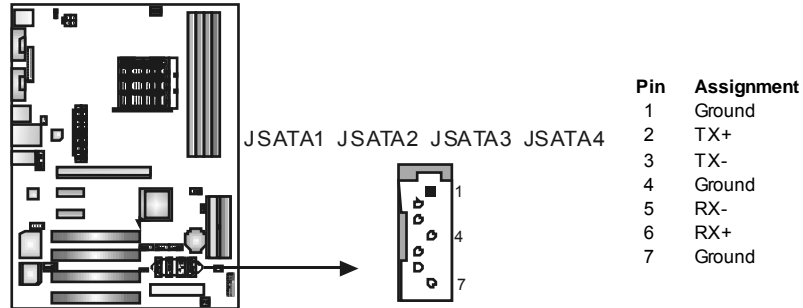

JPRNT1: Printer Port Connector

This header allows you to connector printer on the PC.

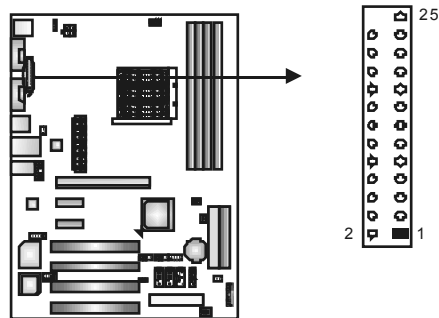

Pin	Assignment	Pin	Assignment
1	-Strobe	14	Ground
2	-ALF	15	Data 6
3	Data 0	16	Ground
4	-Error	17	Data 7
5	Data 1	18	Ground
6	-Init	19	-ACK
7	Data 2	20	Ground
8	-Scltin	21	Busy
9	Data 3	22	Ground
10	Ground	23	PE
11	Data 4	24	Ground
12	Ground	25	SCLT
13	Data 5		

Header for Memory Voltage Overclocking: JDDRII_2.2V

When processing Memory Voltage Overclocking, please place the jumper to pin1-2 Closed. The Default setting is Pin 2-3 Closed.

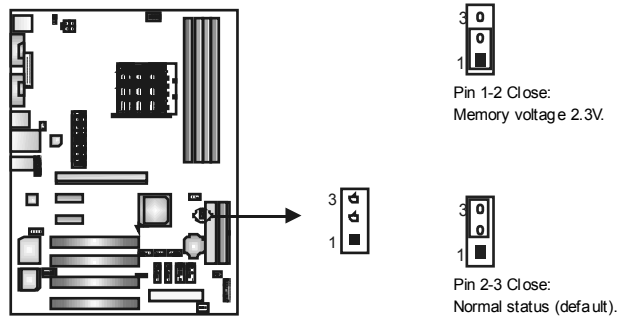

Note:

1. When “JDDRII_2.2V” jumper cap is placed on Pin 2-3, memory voltage can be manually adjusted under CMOS setup.
2. When “JDDRII_2.2V” jumper cap is placed on Pin 1-2, memory voltage will be fixed at 2.3V automatically, and can't be adjusted under COMS setup.

Before setting memory voltage overlocking, please ensure that your memory module supports up to 2.2V. (Consult your memory module supplier)

JSPDIF_OUT1: Digital Audio-out Connector

This connector allows user to connect the PCI bracket SPDIF output header.

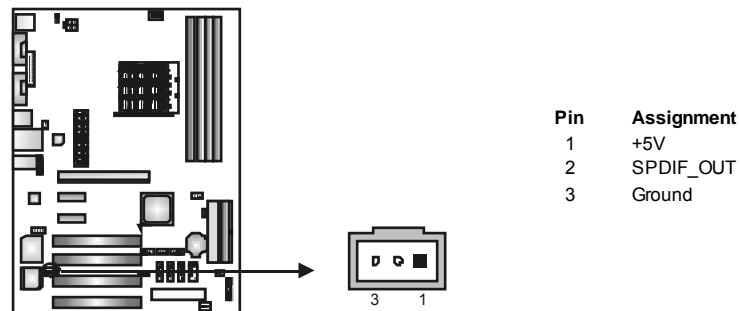

CHAPTER 4: NVIDIA RAID FUNCTIONS

4.1 OPERATION SYSTEM

- Supports Windows XP Home/Professional Edition, and Windows 2000 Professional.

4.2 RAID ARRAYS

NVRAID supports the following types of RAID arrays:

RAID 0: RAID 0 defines a disk striping scheme that improves disk read and write times for many applications.

RAID 1: RAID 1 defines techniques for mirroring data.

RAID 0+1: RAID 0+1 combines the techniques used in RAID 0 and RAID 1.

4.3 HOW RAID WORKS

RAID 0:

The controller “stripes” data across multiple drives in a RAID 0 array system. It breaks up a large file into smaller blocks and performs disk reads and writes across multiple drives in parallel. The size of each block is determined by the stripe size parameter, which you set during the creation of the RAID set based on the system environment. This technique reduces overall disk access time and offers high bandwidth.

Features and Benefits

- **Drives:** Minimum 1, and maximum is up to 6 or 8. Depending on the platform.
- **Uses:** Intended for non-critical data requiring high data throughput, or any environment that does not require fault tolerance.
- **Benefits:** provides increased data throughput, especially for large files. No capacity loss penalty for parity.
- **Drawbacks:** Does not deliver any fault tolerance. If any drive in the array fails, all data is lost.
- **Fault Tolerance:** No.

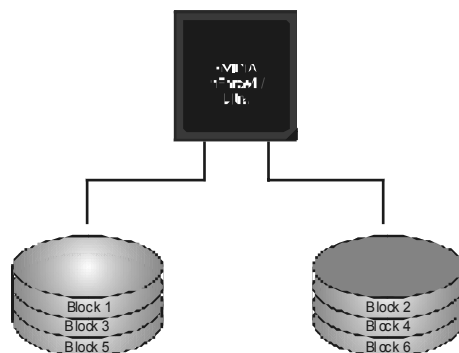

RAID 1:

Every read and write is actually carried out in parallel across 2 disk drives in a RAID 1 array system. The mirrored (backup) copy of the data can reside on the same disk or on a second redundant drive in the array. RAID 1 provides a hot-standby copy of data if the active volume or drive is corrupted or becomes unavailable because of a hardware failure.

RAID techniques can be applied for high-availability solutions, or as a form of automatic backup that eliminates tedious manual backups to more expensive and less reliable media.

Features and Benefits

- **Drives:** Minimum 2, and maximum is 2.
- **Uses:** RAID 1 is ideal for small databases or any other application that requires fault tolerance and minimal capacity.
- **Benefits:** Provides 100% data redundancy. Should one drive fail, the controller switches to the other drive.
- **Drawbacks:** Requires 2 drives for the storage space of one drive. Performance is impaired during drive rebuilds.
- **Fault Tolerance:** Yes.

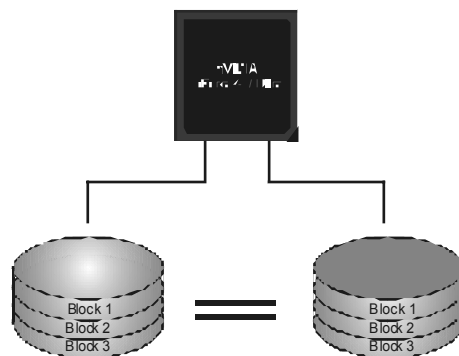

RAID 0+1:

RAID 0 drives can be mirrored using RAID 1 techniques. Resulting in a RAID 0+1 solution for improved performance plus resiliency.

Features and Benefits

- **Drives:** Minimum 4, and maximum is 6 or 8, depending on the platform.
- **Benefits:** Optimizes for both fault tolerance and performance, allowing for automatic redundancy. May be simultaneously used with other RAID levels in an array, and allows for spare disks.
- **Drawbacks:** Requires twice the available disk space for data redundancy, the same as RAID level 1.
- **Fault Tolerance:** Yes.

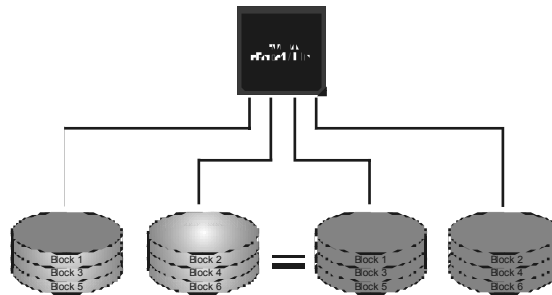

RAID 5:

RAID 5 stripes both data and parity information across three or more drives. It writes data and parity blocks across all the drives in the array. Fault tolerance is maintained by ensuring that the parity information for any given block of data is placed on a different drive from those used to store the data itself.

Features and Benefits

- **Drives: Minimum 3.**
- **Uses: RAID 5 is recommended for transaction processing and general purpose service.**
- **Benefits: An ideal combination of good performance, good fault tolerance, and high capacity and storage efficiency.**
- **Drawbacks: Individual block data transfer rate same as a single disk. Write performance can be CPU intensive.**
- **Fault Tolerance: Yes.**

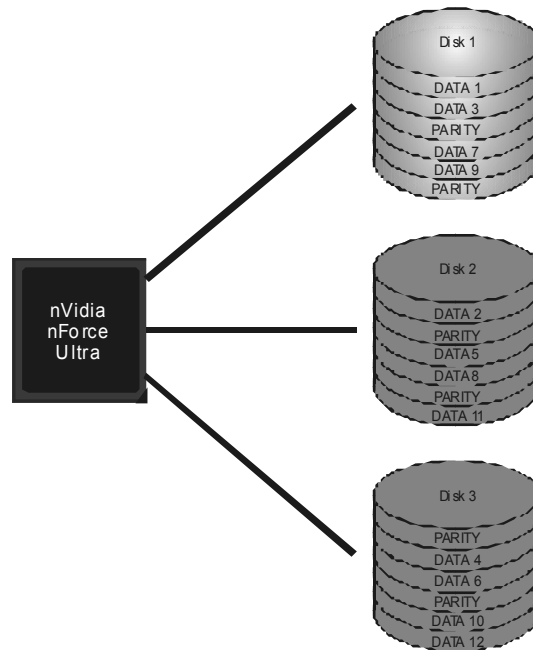

※ For more detailed setup information, please refer to the Driver CD, or go to http://www.nvidia.com/page/pg_20011106217193.html to download NVIDIA nForce Tutorial Flash.

CHAPTER 5: USEFUL HELP

5.1 DRIVER INSTALLATION NOTE

After you installed your operating system, please insert the Fully Setup Driver CD into your optical drive and install the driver for better system performance.

You will see the following window after you insert the CD

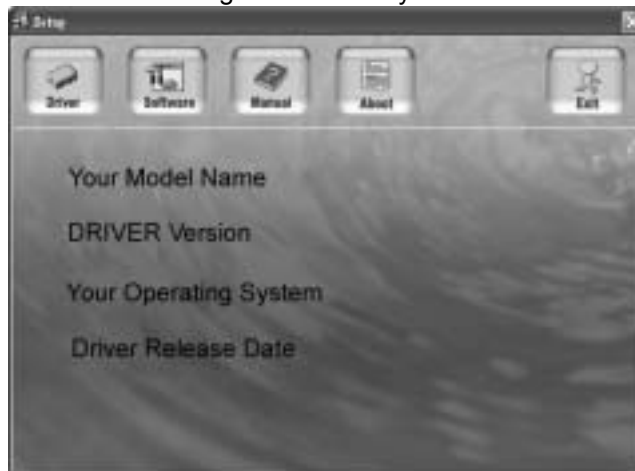

The setup guide will auto detect your motherboard and operating system.

Note:

If this window didn't show up after you insert the Driver CD, please use file browser to locate and execute the file **SETUP.EXE** under your optical drive.

A. Driver Installation

To install the driver, please click on the Driver icon. The setup guide will list the compatible driver for your motherboard and operating system. Click on each device driver to launch the installation program.

B. Software Installation

To install the software, please click on the Software icon. The setup guide will list the software available for your system, click on each software title to launch the installation program.

C. Manual

Aside from the paperback manual, we also provide manual in the Driver CD. Click on the Manual icon to browse for available manual.

Note:

You will need Acrobat Reader to open the manual file. Please download the latest version of Acrobat Reader software from <http://www.adobe.com/products/acrobat/readstep2.html>

5.2 AWARD BIOS BEEP CODE

Beep Sound	Meaning
One long beep followed by two short beeps	Video card not found or video card memory bad
High-low siren sound	CPU overheated System will shut down automatically
One Short beep when system boot-up	No error found during POST
Long beeps every other second	No DRAM detected or install

5.3 EXTRA INFORMATION

A. BIOS Update

After you fail to update BIOS or BIOS is invaded by virus, the Boot-Block function will help to restore BIOS. If the following message is shown after boot-up the system, it means the BIOS contents are corrupted.

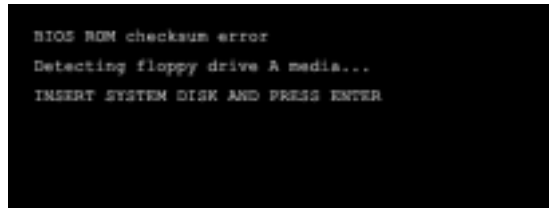

In this Case, please follow the procedure below to restore the BIOS:

1. Make a bootable floppy disk.
2. Download the Flash Utility "AWDFLASH.exe" from the Biostar website: www.biostar.com.tw
3. Confirm motherboard model and download the respectively BIOS from Biostar website.
4. Copy "AWDFLASH.exe" and respectively BIOS into floppy disk.
5. Insert the bootable disk into floppy drive and press Enter.
6. System will boot-up to DOS prompt.
7. Type "*Awdflash xxxx.bf/sn/py/r*" in DOS prompt.
(xxxx means BIOS name.)
8. System will update BIOS automatically and restart.
9. The BIOS has been recovered and will work properly.

B. CPU Overheated

If the system shutdown automatically after power on system for seconds, that means the CPU protection function has been activated.

When the CPU is over heated, the motherboard will shutdown automatically to avoid a damage of the CPU, and the system may not power on again.

In this case, please double check:

1. The CPU cooler surface is placed evenly with the CPU surface.
2. CPU fan is rotated normally.
3. CPU fan speed is fulfilling with the CPU speed.

After confirmed, please follow steps below to relief the CPU protection function.

1. Remove the power cord from power supply for seconds.
2. Wait for seconds.
3. Plug in the power cord and boot up the system.

Or you can:

1. Clear the CMOS data.
(See "Close CMOS Header: JCMOS1" section)
2. Wait for seconds.
3. Power on the system again.

5.4 TROUBLESHOOTING

Probable	Solution
<ol style="list-style-type: none"> No power to the system at all. Power light don't illuminate, fan inside power supply does not turn on. Indicator light on key board does not turn on. 	<ol style="list-style-type: none"> Make sure power cable is securely plugged in. Replace cable. Contact technical support.
System inoperative. Keyboard lights are on, power indicator lights are lit, and hard drive is spinning.	Using even pressure on both ends of the DIMM, press down firmly until the module snaps into place.
System does not boot from hard disk drive, can be booted from optical drive.	<ol style="list-style-type: none"> Check cable running from disk to disk controller board. Make sure both ends are securely plugged in; check the drive type in the standard CMOS setup. Backing up the hard drive is extremely important. All hard disks are capable of breaking down at any time.
System only boots from optical drive. Hard disk can be read and applications can be used but booting from hard disk is impossible.	<ol style="list-style-type: none"> Back up data and applications files. Reformat the hard drive. Re-install applications and data using backup disks.
Screen message says "Invalid Configuration" or "CMOS Failure."	Review system's equipment. Make sure correct information is in setup.
Cannot boot system after installing second hard drive.	<ol style="list-style-type: none"> Set master/slave jumpers correctly. Run SETUP program and select correct drive types. Call the drive manufacturers for compatibility with other drives.

CHAPTER 6: WARPSPEEDER™



6.1 INTRODUCTION

[WarpSpeeder™], a new powerful control utility, features three user-friendly functions including Overclock Manager, Overvoltage Manager, and Hardware Monitor.

With the Overclock Manager, users can easily adjust the frequency they prefer or they can get the best CPU performance with just one click. The Overvoltage Manager, on the other hand, helps to power up CPU core voltage and Memory voltage. The cool Hardware Monitor smartly indicates the temperatures, voltage and CPU fan speed as well as the chipset information. Also, in the About panel, you can get detail descriptions about BIOS model and chipsets. In addition, the frequency status of CPU, memory, AGP and PCI along with the CPU speed are synchronically shown on our main panel.

Moreover, to protect users' computer systems if the setting is not appropriate when testing and results in system fail or hang, [WarpSpeeder™] technology assures the system stability by automatically rebooting the computer and then restart to a speed that is either the original system speed or a suitable one.

6.2 SYSTEM REQUIREMENT

OS Support: Windows 98 SE, Windows Me, Windows 2000, Windows XP
DirectX: DirectX 8.1 or above. (The Windows XP operating system includes DirectX 8.1. If you use Windows XP, you do not need to install DirectX 8.1.)

6.3 INSTALLATION

1. Execute the setup execution file, and then the following dialog will pop up. Please click "Next" button and follow the default procedure to install.

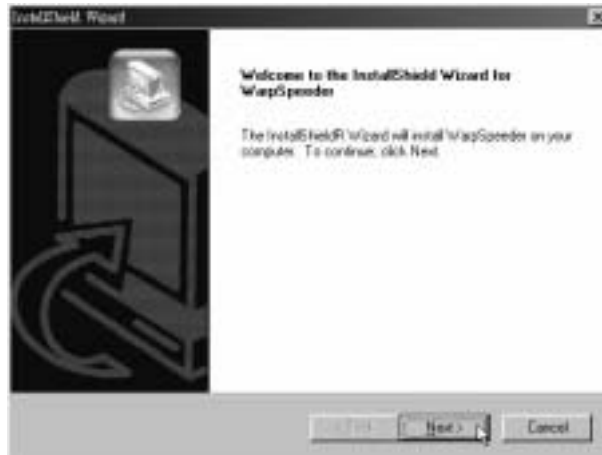

2. When you see the following dialog in setup procedure, it means setup is completed. If the "Launch the WarpSpeeder Tray Utility" checkbox is checked, the Tray Icon utility and [WarpSpeeder™] utility will be automatically and immediately launched after you click "Finish" button.



Usage:

The following figures are just only for reference, the screen printed in this user manual will change according to your motherboard on hand.

6.4 WARPSPEEDER™

1. Tray Icon:

Whenever the Tray Icon utility is launched, it will display a little tray icon on the right side of Windows Taskbar.



This utility is responsible for conveniently invoking [WarpSpeeder™] Utility. You can use the mouse by clicking the left button in order to invoke [WarpSpeeder™] directly from the little tray icon or you can right-click the little tray icon to pop up a popup menu as following figure. The “Launch Utility” item in the popup menu has the same function as mouse left-click on tray icon and “Exit” item will close Tray Icon utility if selected.



2. Main Panel

If you click the tray icon, [WarpSpeeder™] utility will be invoked. Please refer to the following figure; the utility's first window you will see is Main Panel.

Main Panel contains features as follows:

- Display the CPU Speed, CPU external dock, Memory dock, AGP dock, and PCI dock information.
- Contains About, Voltage, Overclock, and Hardware Monitor Buttons for invoking respective panels.
- With a user-friendly Status Animation, it can represent 3 overclock percentage stages:

Man walking → overclock percentage from 100% ~ 110 %

Panther running → overclock percentage from 110% ~ 120%

Car racing → overclock percentage from 120% ~ above

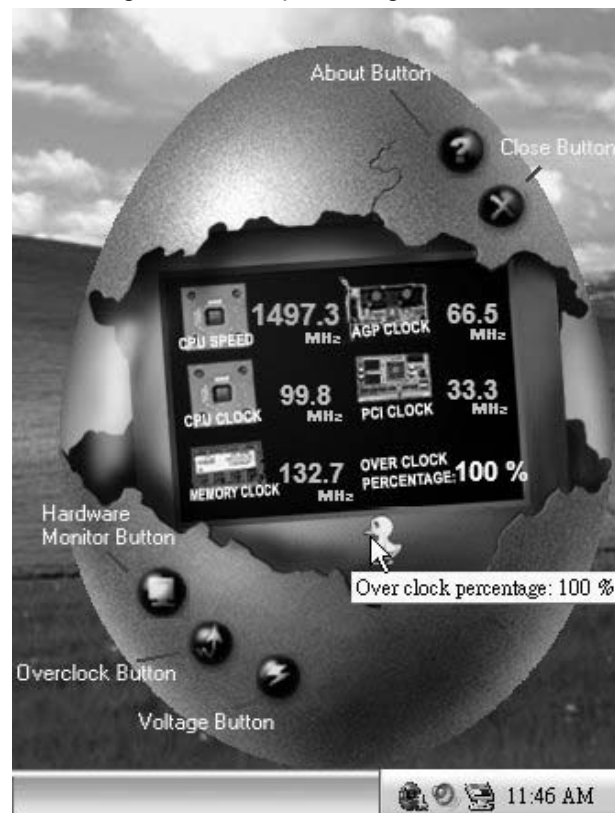

3. Voltage Panel

Click the Voltage button in Main Panel, the button will be highlighted and the Voltage Panel will slide out to up as the following figure.

In this panel, you can decide to increase CPU core voltage and Memory voltage or not. The default setting is "No". If you want to get the best performance of overlocking, we recommend you click the option "Yes".



4. Overclock Panel

Click the Overclock button in Main Panel, the button will be highlighted and the Overclock Panel will slide out to left as the following figure.

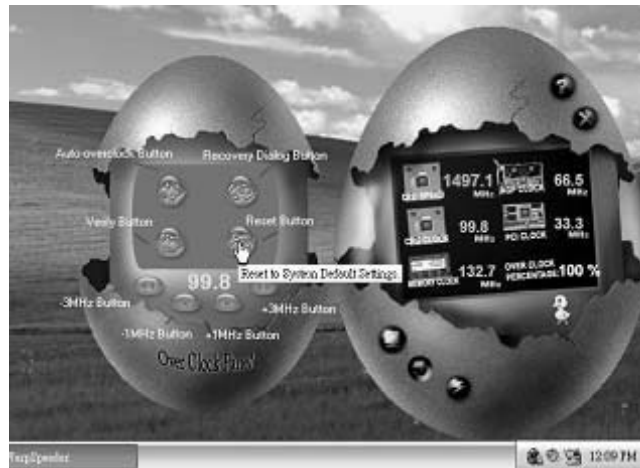

Overclock Panel contains the these features:

- “-3MHz button”, “-1MHz button”, “+1MHz button”, and “+3MHz button”:
provide user the ability to do real-time overclock adjustment.

Warning:

Manually overclock is potentially dangerous, especially when the overlocking percentage is over 110 %. We strongly recommend you verify every speed you overclock by click the Verify button. Or, you can just click Auto overclock button and let [WarpSpeeder™] automatically gets the best result for you.

- “Recovery Dialog button”: Pop up the following dialog. Let user select a restoring way if system need to do a fail-safe reboot.



- c. “Auto-overclock button”: User can click this button and [WarpSpeeder™] will set the best and stable performance and frequency automatically. [WarpSpeeder™] utility will execute a series of testing until system fail. Then system will do fail-safe reboot by using Watchdog function. After reboot, the [WarpSpeeder™] utility will restore to the hardware default setting or load the verified best and stable frequency according to the Recovery Dialog's setting.
- d. “Verify button”: User can click this button and [WarpSpeeder™] will proceed a testing for current frequency. If the testing is ok, then the current frequency will be saved into system registry. If the testing fail, system will do a fail-safe rebooting. After reboot, the [WarpSpeeder™] utility will restore to the hardware default setting or load the verified best and stable frequency according to the Recovery Dialog's setting.

Note:

Because the testing programs, invoked in Auto-overclock and Verify, include DirectDraw, Direct3D and DirectShow tests, the DirectX 8.1 or newer runtime library is required. And please make sure our display card's color depth is High color (16 bit) or True color (24/32 bit) that is required for Direct3D rendering.

5. Hardware Monitor Panel

Click the Hardware Monitor button in Main Panel, the button will be highlighted and the Hardware Monitor panel will slide out to left as the following figure.

In this panel, you can get the real-time status information of your system. The information will be refreshed every 1 second.



6. About Panel

Click the “about” button in Main Panel, the button will be highlighted and the About Panel will slide out to up as the following figure.

In this panel, you can get model name and detail information in hints of all the chipset that are related to overclocking. You can also get the mainboard’s BIOS model and the Version number of [WarpSpeeder™] utility.

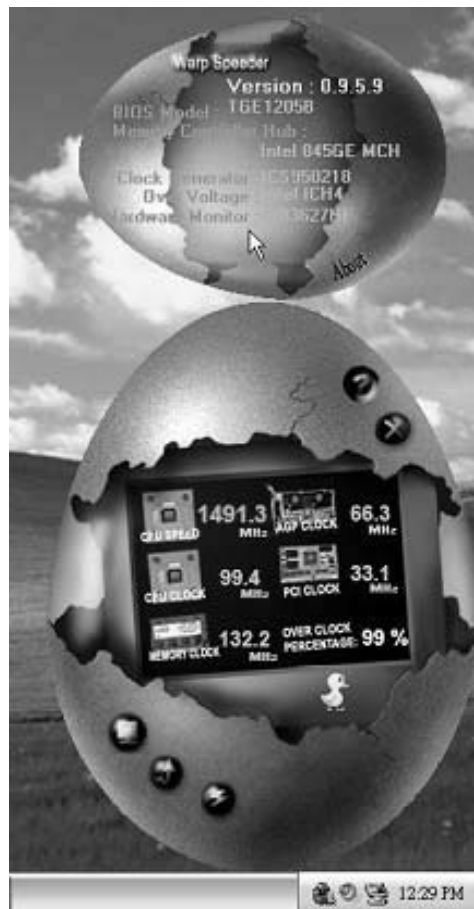

Note:

Because the overclock, overvoltage, and hardware monitor features are controlled by several separate chipset, [WarpSpeeder™] divide these features to separate panels. If one chipset is not on board, the correlative button in Main panel will be disabled, but will not interfere other panels’ functions. This property can make [WarpSpeeder™] utility more robust.

APPENDENCIES: SPEC IN OTHER LANGUAGE

GERMAN

	NF4 AM2G / NF4 AM2L	NF4U AM2G
CPU	Sockel AM2 AMD Athlon 64 / Athlon 64 FX / Athlon 64X2 / Sempron Prozessoren Die AMD 64-Architektur unterstützt eine 32-Bit- und 64-Bit-Datenverarbeitung Unterstützt Hyper Transport und Cool'n'Quiet	Sockel AM2 AMD Athlon 64 / Athlon 64 FX / Athlon 64X2 / Sempron Prozessoren Die AMD 64-Architektur unterstützt eine 32-Bit- und 64-Bit-Datenverarbeitung Unterstützt Hyper Transport und Cool'n'Quiet
FSB	Unterstützt Hyper Transport mit einer Bandbreite von bis zu 1000 MHz	Unterstützt Hyper Transport mit einer Bandbreite von bis zu 1000 MHz
Chipsatz	nVIDIA nForce 4	nVIDIA nForce 4 Ultra
Super E/A	ITE 8712F / 8716F Bietet die häufig verwendeten alten Super E/A-Funktionen. Low Pin Court-Schnittstelle	ITE 8712F / 8716F Bietet die häufig verwendeten alten Super E/A-Funktionen. Low Pin Court-Schnittstelle
Arbeitsspeicher	DDR2 DIMM-Steckplätze x 4 Jeder DIMM unterstützt 256/512MB & 1GB DDR2. Max. 4GB Arbeitsspeicher Dual-Kanal DDR2 Speichermodul Unterstützt DDR2 400 / 533 / 667 / 800 registrierte DIMMs. Nicht-ECC DIMMs werden nicht unterstützt.	DDR2 DIMM-Steckplätze x 4 Jeder DIMM unterstützt 256/512MB & 1GB DDR2. Max. 4GB Arbeitsspeicher Dual-Kanal DDR2 Speichermodul Unterstützt DDR2 400 / 533 / 667 / 800 registrierte DIMMs. Nicht-ECC DIMMs werden nicht unterstützt.
IDE	Integrierter IDE-Controller Ultra DMA 33 / 66 / 100 / 133 Bus Master-Modus	Integrierter IDE-Controller Ultra DMA 33 / 66 / 100 / 133 Bus Master-Modus
SATA	Integrierter Serial ATA-Controller Datenübertragungsraten bis zu 1.5Gb/s Konform mit der SATA-Spezifikation Version 1.0.	Integrierter Serial ATA-Controller Datenübertragungsraten bis zu 3.0Gb/s Konform mit der SATA-Spezifikation Version 2.0.
LAN	Marvell 88E3016 PHY (nur für NF4 AM2L) 10 / 100 Mb/s Auto-Negotiation Marvell 88E1116 PHY (nur für NF4 AM2G) 10 / 100 Mb/s Auto-Negotiation	Marvell 88E1116 PHY 10 / 100 Mb/s Auto-Negotiation
Audio-Codec	ALC 655 / 658 (optional) 6-Kanal-Audioausgabe AC'97 Version 2.3 S/PDIF-Ausgang	ALC 655 / 658 (optional) 6-Kanal-Audioausgabe AC'97 Version 2.3 S/PDIF-Ausgang

NF4 AM2G / NF4 AM2L / NF4UAM2G

Steckplätze	PCI-Steckplatz	x4	PCI-Steckplatz	x4
	PCI Express x16 Steckplatz	x1	PCI Express x16 Steckplatz	x1
	PCI Express x 1-Steckplatz	x2	PCI Express x 1-Steckplatz	x2
Onboard-Anschluss	Diskettenlaufwerkanschluss	x1	Diskettenlaufwerkanschluss	x1
	Druckeranschluss Anschluss	x1	Druckeranschluss Anschluss	x1
	IDE-Anschluss	x2	IDE-Anschluss	x2
	SATA-Anschluss	x4	SATA-Anschluss	x4
	Fronttafelanschluss	x1	Fronttafelanschluss	x1
	Front-Audioanschluss	x1	Front-Audioanschluss	x1
	CD-IN-Anschluss	x1	CD-IN-Anschluss	x1
	S/PDIF-Ausgangsanschluss	x1	S/PDIF-Ausgangsanschluss	x1
	CPU-Lüfter-Sockel	x1	CPU-Lüfter-Sockel	x1
	System-Lüfter-Sockel	x3	System-Lüfter-Sockel	x3
	"Gehäuse offen"-Sockel (optional)	x1	"Gehäuse offen"-Sockel (optional)	x1
	"CMOS löschen"-Sockel	x1	"CMOS löschen"-Sockel	x1
	USB-Anschluss	x3	USB-Anschluss	x3
	Stromanschluss (24-polig)	x1	Stromanschluss (24-polig)	x1
Stromanschluss (4-polig)	x1	Stromanschluss (4-polig)	x1	
Rückseiten-E/A	PS/2-Tastatur	x1	PS/2-Tastatur	x1
	PS/2-Maus	x1	PS/2-Maus	x1
	Serieller Anschluss	x1	Serieller Anschluss	x1
	LAN-Anschluss	x1	LAN-Anschluss	x1
	USB-Anschluss	x4	USB-Anschluss	x4
	Audioanschluss	x3	Audioanschluss	x3
Platinengröße	218 mm (B) X 293mm (L)		218 mm (B) X 293mm (L)	
Sonderfunktionen	NVIDIA nTunes NVIDIA Firewall (nur für NF4 AM2G) Unterstützt RAID 0 / 1/ 0+1		NVIDIA nTunes NVIDIA Firewall Unterstützt RAID 0 / 1/ 0+1 / 5	
OS-Unterstützung	Windows 2K / XP Biostar behält sich das Recht vor, ohne Ankündigung die Unterstützung für ein Betriebssystem hinzuzufügen oder zu entfernen.		Windows 2K / XP Biostar behält sich das Recht vor, ohne Ankündigung die Unterstützung für ein Betriebssystem hinzuzufügen oder zu entfernen.	

FRANCE

	NF4 AM2G / NF4 AM2L	NF4U AM2G
UC	Socket AM2 Processeurs AMD Athlon 64 / Athlon 64 FX / Athlon 64X2 / Sempron L'architecture AMD 64 permet le calcul 32 et 64 bits Prend en charge Hyper Transport et Cod'nQuiet	Socket AM2 Processeurs AMD Athlon 64 / Athlon 64 FX / Athlon 64X2 / Sempron L'architecture AMD 64 permet le calcul 32 et 64 bits Prend en charge Hyper Transport et Cod'nQuiet
Bus frontal	Prend en charge Hyper Transport jusqu'à une bande passante de 1000MHz	Prend en charge Hyper Transport jusqu'à une bande passante de 1000MHz
Chipset	nVIDIA nForce 4	nVIDIA nForce 4 Ultra
Super E/S	ITE 8712F / 8716F Fournit la fonctionnalité de Super E/S patrimoniales la plus utilisée. Interface à faible compte de broches	ITE 8712F / 8716F Fournit la fonctionnalité de Super E/S patrimoniales la plus utilisée. Interface à faible compte de broches
Mémoire principale	Fentes DDR2 DIMM x 4 Chaque DIMM prend en charge des DDR2 de 256/512 Mo et 1Go Capacité mémoire maximale de 4 Go Module de mémoire DDR2 à mode à double voie Prend en charge la DDR2 400 / 533 / 667 / 800 Les DIMM à registres et DIMM sans code correcteurs d'erreurs ne sont pas prises en charge	Fentes DDR2 DIMM x 4 Chaque DIMM prend en charge des DDR2 de 256/512 Mo et 1Go Capacité mémoire maximale de 4 Go Module de mémoire DDR2 à mode à double voie Prend en charge la DDR2 400 / 533 / 667 / 800 Les DIMM à registres et DIMM sans code correcteurs d'erreurs ne sont pas prises en charge
IDE	Contrôleur IDE intégré Mode principale de Bus Ultra DMA 33 / 66 / 100 / 133 Prend en charge le mode PIO 0~4,	Contrôleur IDE intégré Mode principale de Bus Ultra DMA 33 / 66 / 100 / 133 Prend en charge le mode PIO 0~4,
SATA	Contrôleur Serial ATA intégré : Taux de transfert jusqu'à 1.5 Go/s. Conforme à la spécification SATA Version 1.0	Contrôleur Serial ATA intégré : Taux de transfert jusqu'à 3.0 Go/s. Conforme à la spécification SATA Version 2.0
LAN	Marvell 88E3016 PHY (Seulement pour NF4 AM2L) 10 / 100 Mb/s négociation automatique Marvell 88E1116 PHY (Seulement pour NF4 AM2G) 10 / 100 / 1000 Mb/s négociation automatique	Marvell 88E1116 PHY 10 / 100 / 1000 Mb/s négociation automatique

NF4 AM2G / NF4 AM2L / NF4UAM2G

Codec audio	ALC 655 / 658 (optional) Sortie audio à 6 voies AC'97 Version 2.3 Sortie (entrée) S/PDIF	ALC 655 / 658 (optional) Sortie audio à 6 voies AC'97 Version 2.3 Sortie (entrée) S/PDIF
Fentes	Fente PCI x4 Slot PCI Express x16 x1 Slot PCI Express x 1 x2	Fente PCI x4 Slot PCI Express x16 x1 Slot PCI Express x 1 x2
Connecteur embarqué	Connecteur de disquette x1 Connecteur de Port d'imprimante x1 Connecteur IDE x2 Connecteur SATA x4 Connecteur du panneau avant x1 Connecteur Audio du panneau avant x1 Connecteur d'entrée CD x1 Connecteur de sortie S/PDIF x1 Embase de ventilateur UC x1 Embase de ventilateur système x3 Embase d'ouverture de châssis (optional) x1 Embase d'effacement CMOS x1 Connecteur USB x3 Connecteur d'alimentation (24 broches) x1 Connecteur d'alimentation (4 broches) x1	Connecteur de disquette x1 Connecteur de Port d'imprimante x1 Connecteur IDE x2 Connecteur SATA x4 Connecteur du panneau avant x1 Connecteur Audio du panneau avant x1 Connecteur d'entrée CD x1 Connecteur de sortie S/PDIF x1 Embase de ventilateur UC x1 Embase de ventilateur système x3 Embase d'ouverture de châssis (optional) x1 Embase d'effacement CMOS x1 Connecteur USB x3 Connecteur d'alimentation (24 broches) x1 Connecteur d'alimentation (4 broches) x1
E/S du panneau arrière	Clavier PS/2 x1 Souris PS/2 x1 Port série x1 Port LAN x1 Port USB x4 Fiche audio x3	Clavier PS/2 x1 Souris PS/2 x1 Port série x1 Port LAN x1 Port USB x4 Fiche audio x3
Dimensions de la carte	218 mm (l) X 293 mm (H)	218 mm (l) X 293 mm (H)
Fonctionnalités spéciales	NVIDIA nTunes Pare-feu NVIDIA (Seulement pour NF4 AM2G) Prise en charge RAID 0 / 1 / 0+1	NVIDIA nTunes Pare-feu NVIDIA Prise en charge RAID 0 / 1 / 0+1
Support SE	Windows 2K / XP Biosstar se réserve le droit d'ajouter ou de supprimer le support de SE avec ou sans préavis	Windows 2K / XP Biosstar se réserve le droit d'ajouter ou de supprimer le support de SE avec ou sans préavis

ITALIAN

	NF4 AM2G / NF4 AM2L	NF4U AM2G
CPU	Socket AM2 Processori AMD Athlon 64 / Athlon 64 FX / Athlon 64X2 / Sempron L'architettura AMD 64 abilita la computazione 32 e 64 bit Supporto di Hyper Transport e Cool'n'Quiet	Socket AM2 Processori AMD Athlon 64 / Athlon 64 FX / Athlon 64X2 / Sempron L'architettura AMD 64 abilita la computazione 32 e 64 bit Supporto di Hyper Transport e Cool'n'Quiet
FSB	Supporto di HyperTransport fino a 1000 MHz di larghezza di banda	Supporto di HyperTransport fino a 1000 MHz di larghezza di banda
Chipset	nVIDIA nForce 4	nVIDIA nForce 4 Ultra
Super I/O	ITE 8712F / 8716F Fornisce le funzionalità legacy Super I/O usate più comunemente. Interfaccia LPC (Low Pin Count)	ITE 8712F / 8716F Fornisce le funzionalità legacy Super I/O usate più comunemente. Interfaccia LPC (Low Pin Count)
Memoria principale	Alloggi DIMM DDR 2 x 4 Ciascun DIMM supporta DDR2 256/512MB e 1GB Capacità massima della memoria 4GB Modulo di memoria DDR2 a canale doppio Supporto di DDR2 400 / 533 / 667 / 800 DIMM registrati e DIMM Non-ECC non sono supportati	Alloggi DIMM DDR 2 x 4 Ciascun DIMM supporta DDR2 256/512MB e 1GB Capacità massima della memoria 4GB Modulo di memoria DDR2 a canale doppio Supporto di DDR2 400 / 533 / 667 / 800 DIMM registrati e DIMM Non-ECC non sono supportati
IDE	Controller IDE integrato Modalità Bus Master Ultra DMA 33 / 66 / 100 / 133 Supporto modalità PIO Mode 0-4	Controller IDE integrato Modalità Bus Master Ultra DMA 33 / 66 / 100 / 133 Supporto modalità PIO Mode 0-4
SATA	Controller Serial ATA integrato Velocità di trasferimento dei dati fino a 1.5 Gb/s. Compatibile specifiche SATA Versione 1.0.	Controller Serial ATA integrato Velocità di trasferimento dei dati fino a 3.0 Gb/s. Compatibile specifiche SATA Versione 2.0.
LAN	Marrell 88E3016 PHY (solo per NF4 AM2L) Negoziazione automatica 10 / 100 Mb/s Marrell 88E1116 PHY (solo per NF4 AM2G) Negoziazione automatica 10 / 100 Mb/s	Marrell 88E1116 PHY (solo per NF4 AM2G) Negoziazione automatica 10 / 100 Mb/s
Codec audio	ALC 655 / 658(optional) Uscita audio 6 canali AC'97 Versione 2.3 Output S/PDIF	ALC 655 / 658(optional) Uscita audio 6 canali AC'97 Versione 2.3 Output S/PDIF
Alloggi	Alloggio PCI x4 Alloggio PCI Express x16 x1 Alloggio PCI Express x1 x2	Alloggio PCI x4 Alloggio PCI Express x16 x1 Alloggio PCI Express x1 x2
Connettori su scheda	Connettore floppy x1 Connettore Porta stampante x1 Connettore IDE x2	Connettore floppy x1 Connettore Porta stampante x1 Connettore IDE x2

NF4 AM2G / NF4 AM2L / NF4UAM2G

	Connettore SATA	x4	Connettore SATA	x4
	Connettore pannello frontale	x1	Connettore pannello frontale	x1
	Connettore audio frontale	x1	Connettore audio frontale	x1
	Connettore CD-in	x1	Connettore CD-in	x1
	Connettore output SPDIF	x1	Connettore output SPDIF	x1
	Collettore ventolina CPU	x1	Collettore ventolina CPU	x1
	Collettore ventolina sistema	x3	Collettore ventolina sistema	x3
	Collettore apertura telaio (optional)	x1	Collettore apertura telaio (optional)	x1
	Collettore cancellazione CMOS	x1	Collettore cancellazione CMOS	x1
	Connettore USB	x3	Connettore USB	x3
	Connettore alimentazione (24 pin)	x1	Connettore alimentazione (24 pin)	x1
	Connettore alimentazione (4 pin)	x1	Connettore alimentazione (4 pin)	x1
I/O pannello posteriore	Tastiera PS/2	x1	Tastiera PS/2	x1
	Mouse PS/2	x1	Mouse PS/2	x1
	Porta seriale	x1	Porta seriale	x1
	Porta LAN	x1	Porta LAN	x1
	Porta USB	x4	Porta USB	x4
	Connettore audio	x3	Connettore audio	x3
Dimensioni scheda	218 mm (larghezza) x 293 mm (altezza)		218 mm (larghezza) x 293 mm (altezza)	
Caratteristiche speciali	nTunes NVIDIA Firewall NVIDIA (solo per NF4 AM2G) Supporto RAID 0 / 1 / 0+1		nTunes NVIDIA Firewall NVIDIA Supporto RAID 0 / 1 / 0+1 / 5	
Sistemi operativi supportati	Windows 2K / XP Biostar si riserva il diritto di aggiungere o rimuovere il supporto di qualsiasi sistema operativo senza preavviso		Windows 2K / XP Biostar si riserva il diritto di aggiungere o rimuovere il supporto di qualsiasi sistema operativo senza preavviso	

SPANISH

	NF4 AM2G / NF4 AM2L	NF4U AM2G
CPU	<p>Conector AM2</p> <p>Procesadores AMD Athlon 64 / Athlon 64 FX / Athlon 64X2 / Sempron</p> <p>La arquitectura AMD 64 permite el procesamiento de 32 y 64 bits</p> <p>Soporta las tecnologías Hyper Transport y Cool'n'Quiet</p>	<p>Conector AM2</p> <p>Procesadores AMD Athlon 64 / Athlon 64 FX / Athlon 64X2 / Sempron</p> <p>La arquitectura AMD 64 permite el procesamiento de 32 y 64 bits</p> <p>Soporta las tecnologías Hyper Transport y Cool'n'Quiet</p>
FSB	Admite HyperTransport con un ancho de banda de hasta 1000 MHz	Admite HyperTransport con un ancho de banda de hasta 1000 MHz
Conjunto de chips	nVIDIA nForce 4	nVIDIA nForce 4 Ultra
Súper E/S	<p>ITE 8712F / 8716F</p> <p>Le ofrece las funcionalidades heredadas de uso más común Súper E/S.</p> <p>Interfaz de cuenta Low Pin</p>	<p>ITE 8712F / 8716F</p> <p>Le ofrece las funcionalidades heredadas de uso más común Súper E/S.</p> <p>Interfaz de cuenta Low Pin</p>
Memoria principal	<p>Ranuras DIMM DDR2 x 4</p> <p>Cada DIMM admite DDR de 256/512MB y 1GB</p> <p>Capacidad máxima de memoria de 4GB</p> <p>Módulo de memoria DDR2 de canal Doble</p> <p>Admite DDR2 de 400 / 533 / 667 / 800</p> <p>No admite DIMM registrados o DIMM no compatibles con ECC</p>	<p>Ranuras DIMM DDR2 x 4</p> <p>Cada DIMM admite DDR de 256/512MB y 1GB</p> <p>Capacidad máxima de memoria de 4GB</p> <p>Módulo de memoria DDR2 de canal Doble</p> <p>Admite DDR2 de 400 / 533 / 667 / 800</p> <p>No admite DIMM registrados o DIMM no compatibles con ECC</p>
IDE	<p>Controlador IDE integrado</p> <p>Modo bus maestro Ultra DMA 33/ 66 / 100 / 133</p> <p>Soporte los Modos PIO 0~4,</p>	<p>Controlador IDE integrado</p> <p>Modo bus maestro Ultra DMA 33/ 66 / 100 / 133</p> <p>Soporte los Modos PIO 0~4,</p>
SATA	<p>Controlador ATA Serie Integrado</p> <p>Tasas de transferencia de hasta 1.5 Gb/s.</p> <p>Compatible con la versión SATA 1.0.</p>	<p>Controlador ATA Serie Integrado</p> <p>Tasas de transferencia de hasta 3.0 Gb/s.</p> <p>Compatible con la versión SATA 0.0.</p>
Red Local	<p>Marvell 88E3016 PHY (solamente para NF4 AM2L)</p> <p>Negociación de 10 / 100 Mb/s</p> <p>Marvell 88E1116 PHY (solamente para NF4 AM2G)</p> <p>Negociación de 10 / 100 / 1000 Mb/s</p>	<p>Marvell 88E1116 PHY</p> <p>Negociación de 10 / 100 / 1000 Mb/s</p>
Códecs de sonido	<p>ALC 655 / 658 (opcional)</p> <p>Salida desorido de 6 canales</p> <p>AC'97 Versión 2.3</p> <p>Salida S/PDIF</p>	<p>ALC 655 / 658 (opcional)</p> <p>Salida desorido de 6 canales</p> <p>AC'97 Versión 2.3</p> <p>Salida S/PDIF</p>

NF4 AM2G / NF4 AM2L / NF4UAM2G

Ranuras	Ranura PCI	X4	Ranura PCI	X4
	Ranura PCI Express x16	X1	Ranura PCI Express x16	X1
	Ranura PCI express x 1	X2	Ranura PCI express x 1	X2
Conectores en placa	Conector disco flexible	X1	Conector disco flexible	X1
	Conector Puerto de impresora	X1	Conector Puerto de impresora	X1
	Conector IDE	X2	Conector IDE	X2
	Conector SATA	X4	Conector SATA	X4
	Conector de panel frontal	X1	Conector de panel frontal	X1
	Conector de sonido frontal	X1	Conector de sonido frontal	X1
	Conector de entrada de CD	X1	Conector de entrada de CD	X1
	Conector de salida S/PDIF	X1	Conector de salida S/PDIF	X1
	Cabecera de ventilador de CPU	X1	Cabecera de ventilador de CPU	X1
	Cabecera de ventilador de sistema	X3	Cabecera de ventilador de sistema	X3
	Cabecera de chasis abierto(opcional)	X1	Cabecera de chasis abierto(opcional)	X1
	Cabecera de borrado de CMOS	X1	Cabecera de borrado de CMOS	X1
	Conector USB	X3	Conector USB	X3
	Conector de alimentación (24 patillas)	X1	Conector de alimentación (24 patillas)	X1
	Conector de alimentación (4 patillas)	X1	Conector de alimentación (4 patillas)	X1
Panel trasero de E/S	Teclado PS/2	X1	Teclado PS/2	X1
	Ratón PS/2	X1	Ratón PS/2	X1
	Puerto serie	X1	Puerto serie	X1
	Puerto de red local	X1	Puerto de red local	X1
	Puerto USB	X4	Puerto USB	X4
	Conector de sonido	X3	Conector de sonido	X3
Tamaño de la placa	218 mm. (A) X 293 Mm. (H)		218 mm. (A) X 293 Mm. (H)	
Funciones especiales	NVIDIA nTunes		NVIDIA nTunes	
	NVIDIA Firewall (solamente para NF4AM2G)		NVIDIA Firewall	
	Admite RAID 0 / 1 / 0+ 1		Admite RAID 0 / 1 / 0+ 1 / 5	
Soporte de sistema operativo	Windows 2K / XP		Windows 2K / XP	
	Bióstar se reserva el derecho de añadir o retirar el soporte de cualquier SO con o sin aviso previo		Bióstar se reserva el derecho de añadir o retirar el soporte de cualquier SO con o sin aviso previo	

PORTUGUESE

	NF4 AM2G / NF4 AM2L	NF4U AM2G
CPU	Socket AM2 Processadores AMD Athlon 64 / Athlon 64 FX / Athlon 64X2 / Sempron A arquitectura AMD 64 permite uma computação de 32 e 64 bits Suporta as tecnologias Hyper Transport e Cool'nQuiet	Socket AM2 Processadores AMD Athlon 64 / Athlon 64 FX / Athlon 64X2 / Sempron A arquitectura AMD 64 permite uma computação de 32 e 64 bits Suporta as tecnologias Hyper Transport e Cool'nQuiet
FSB	Suporta a tecnologia HyperTransport com uma largura de banda até 1000MHz	Suporta a tecnologia HyperTransport com uma largura de banda até 1000MHz
Chipset	nVIDIA nForce 4	nVIDIA nForce 4 Ultra
Especificação Super I/O	ITE 8712F / 8716F Proporciona as funcionalidades mais utilizadas em termos da especificação Super I/O. Interface LPC (Low Pin Count).	ITE 8712F / 8716F Proporciona as funcionalidades mais utilizadas em termos da especificação Super I/O. Interface LPC (Low Pin Count).
Memória principal	Ranhuras DIMM DDR2 x 4 Cada módulo DIMM suporta uma memória DDR2 de 256/512 MB & 1 GB Capacidade máxima de memória: 4 GB Módulo de memória DDR2 de canal duplo Suporta módulos DDR2 400 / 533 / 667 / 800 Os módulos DIMM registados e os DIMM Non-ECC não são suportados	Ranhuras DIMM DDR2 x 4 Cada módulo DIMM suporta uma memória DDR2 de 256/512 MB & 1 GB Capacidade máxima de memória: 4 GB Módulo de memória DDR2 de canal duplo Suporta módulos DDR2 400 / 533 / 667 / 800 Os módulos DIMM registados e os DIMM Non-ECC não são suportados
IDE	Controlador IDE integrado Modo Bus master Ultra DMA 33 / 66 / 100 / 133 Suporta o modo PIO 0~4	Controlador IDE integrado Modo Bus master Ultra DMA 33 / 66 / 100 / 133 Suporta o modo PIO 0~4
SATA	Controlador Serial ATA integrado Velocidades de transmissão de dados até 1.5 Gb/s. Compatibilidade com a especificação SATA versão 1.0.	Controlador Serial ATA integrado Velocidades de transmissão de dados até 3.0 Gb/s. Compatibilidade com a especificação SATA versão 2.0.
LAN	Marvell 88E3016 PHY (apenas para os modelos NF4 AM2L) Auto negociação de 10 / 100 Mb/s. Marvell 88E1116 PHY (apenas para os modelos NF4 AM2G) Auto negociação de 10 / 100 / 1000 Mb/s.	Marvell 88E1116 PHY Auto negociação de 10 / 100 / 1000 Mb/s.
Codec de som	ALC 655 / 658 (opcional) Saída de áudio de 6 canais AC'97 Versão 2.3 Saída S/PDIF	ALC 655 / 658 (opcional) Saída de áudio de 6 canais AC'97 Versão 2.3 Saída S/PDIF

NF4 AM2G / NF4 AM2L / NF4UAM2G

Ranhur	Ranhura PCI	x4	Ranhura PCI	x4
	Ranhura PCI Express x16	x1	Ranhura PCI Express x16	x1
	Ranhura PCI Express x 1	x2	Ranhura PCI Express x 1	x2
Conectores na placa	Conector da unidade de disquetes	x1	Conector da unidade de disquetes	x1
	Conector da para impressora	x1	Conector da para impressora	x1
	Conector IDE	x2	Conector IDE	x2
	Conector SATA	x4	Conector SATA	x4
	Conector do painel frontal	x1	Conector do painel frontal	x1
	Conector de áudio frontal	x1	Conector de áudio frontal	x1
	Conector para entrada de CDs	x1	Conector para entrada de CDs	x1
	Conector de saída S/PDIF	x1	Conector de saída S/PDIF	x1
	Conector da ventoinha da CPU	x1	Conector da ventoinha da CPU	x1
	Conector da ventoinha do sistema	x3	Conector da ventoinha do sistema	x3
	Conector para detecção da abertura do chassis	x1	Conector para detecção da abertura do chassis	x1
	Conector para limpeza do CMOS	x1	Conector para limpeza do CMOS	x1
	Conector USB	x3	Conector USB	x3
	Conector de alimentação (24 pinos)	x1	Conector de alimentação (24 pinos)	x1
	Conector de alimentação (4 pinos)	x1	Conector de alimentação (4 pinos)	x1
Entradas/Saídas no painel traseiro	Teclado PS/2	x1	Teclado PS/2	x1
	Rato PS/2	x1	Rato PS/2	x1
	Porta série	x1	Porta série	x1
	Porta LAN	x1	Porta LAN	x1
	Porta USB	x4	Porta USB	x4
	Tomada de áudio	x3	Tomada de áudio	x3
Tamanho da placa	218 mm (L) X 293 mm (A)		218 mm (L) X 293 mm (A)	
Características especiais	nTunes da NVIDIA		nTunes da NVIDIA	
	Firewall da NVIDIA (apenas para os modelos NF4 AM2G)		Firewall da NVIDIA	
	Suporta as funções RAID 0 / 1 / 0+1		Suporta as funções RAID 0 / 1 / 0+1 / 5	
Sistemas operativos suportados	Windows 2K / XP		Windows 2K / XP	
	A Biostar reserva-se o direito de adicionar ou remover suporte para qualquer sistema operativo com ou sem aviso prévio.		A Biostar reserva-se o direito de adicionar ou remover suporte para qualquer sistema operativo com ou sem aviso prévio.	

POLISH

	NF4 AM2G / NF4 AM2L	NF4U AM2G
Procesor	Socket AM2 AMD Athlon 64 / Athlon 64 FX / Procesory Athlon 64X2 / Sempron Architektura AMD 64 umożliwia przetwarzanie 32 i 64 bitowe Obsługa Hyper Transport oraz Cool'n'Quiet	Socket AM2 AMD Athlon 64 / Athlon 64 FX / Athlon 64X2 / Sempron Procesory Architektura AMD 64 umożliwia przetwarzanie 32 i 64 bitowe Obsługa Hyper Transport oraz Cool'n'Quiet
FSB	Obsługa HyperTransport oszerokości pasma do 1000 MHz	Obsługa HyperTransport oszerokości pasma do 1000 MHz
Chipset	nVIDIA nForce 4	nVIDIA nForce 4 Ultra
Pamięć główna	Gniazda DDR2 DIMM x 4 Każde gniazdo DIMM obsługuje moduły 256/512MB oraz 1GB DDR2 Maks. wielkość pamięci 4GB Moduł pamięci DDR2 z trybem podwójnego kanału Obsługa DDR2 400 / 533 / 667 / 800 Brak obsługi Registered DIMM oraz Non-ECC DIMM	Gniazda DDR2 DIMM x 4 Każde gniazdo DIMM obsługuje moduły 256/512MB oraz 1GB DDR2 Maks. wielkość pamięci 4GB Moduł pamięci DDR2 z trybem podwójnego kanału Obsługa DDR2 400 / 533 / 667 / 800 Brak obsługi Registered DIMM oraz Non-ECC DIMM
Super I/O	ITE 8712F / 8716F Zapewnia najbardziej powszechne funkcje Super I/O. Interfejs Low Pin Count	ITE 8712F / 8716F Zapewnia najbardziej powszechne funkcje Super I/O. Interfejs Low Pin Count
IDE	Zintegrowany kontroler IDE Ultra DMA 33 / 66 / 100 / 133 Tryb Bus Master obsługa PIO tryb 0~4	Zintegrowany kontroler IDE Ultra DMA 33 / 66 / 100 / 133 Tryb Bus Master obsługa PIO tryb 0~4
SATA	Zintegrowany kontroler Serial ATA Transfer danych do 1.5 Gb/s. Zgodność ze specyfikacją SATA w wersji 1.0.	Zintegrowany kontroler Serial ATA Transfer danych do 3.0 Gb/s. Zgodność ze specyfikacją SATA w wersji 2.0.
LAN	Marvell 88E3016 PHY (wyłącznie dla NF4 AM2L) 10 / 100 Mb/s oraz automatyczną negocjacją szybkości Marvell 88E1116 PHY (wyłącznie dla NF4 AM2G) 10 / 100 / 1000 Mb/s oraz automatyczną negocjacją szybkości	Marvell 88E1116 PHY 10 / 100 / 1000 Mb/s oraz automatyczną negocjacją szybkości
Kodek dźwiękowy	ALC 655 / 658 (opcja) 8 kanałowe wyjście audio AC'97 w wersji 2.3 Wyjście S/PDIF	ALC 655 / 658 (opcja) 8 kanałowe wyjście audio AC'97 w wersji 2.3 Wyjście S/PDIF

NF4 AM2G / NF4 AM2L / NF4UAM2G

Gniazda	Gniazdb PCI	x4	Gniazdb PCI	x4
	Gniazdb PCI Express x16	x1	Gniazdb PCI Express x16	x1
	Gniazdb PCI Express x 1	x2	Gniazdb PCI Express x 1	x2
Złącza wbudowane	Złącze napędu dyskiętek	x1	Złącze napędu dyskiętek	x1
	Złącze Port drukarki	x1	Złącze Port drukarki	x1
	Złącze IDE	x2	Złącze IDE	x2
	Złącze SATA	x4	Złącze SATA	x4
	Złącze panda przedniego	x1	Złącze panda przedniego	x1
	Przednie złącze audio	x1	Przednie złącze audio	x1
	Złącze wejścia CD	x1	Złącze wejścia CD	x1
	Złącze wyjścia S/PDIF	x1	Złącze wyjścia S/PDIF	x1
	Złącze główkowe wentylatora procesora	x1	Złącze główkowe wentylatora procesora	x1
	Złącze główkowe wentylatora systemowego	x3	Złącze główkowe wentylatora systemowego	x3
	Złącze główkowe otwarcia obudowy (opcja)	x1	Złącze główkowe otwarcia obudowy (opcja)	x1
	Złącze główkowe kasowania CMOS	x1	Złącze główkowe kasowania CMOS	x1
	Złącze USB	x3	Złącze USB	x3
	Złącze zasilania (24 pinowe)	x1	Złącze zasilania (24 pinowe)	x1
Złącze zasilania (4 pinowe)	x1	Złącze zasilania (4 pinowe)	x1	
Back Panel I/O	Klawiatura PS/2	x1	Klawiatura PS/2	x1
	Mysz PS/2	x1	Mysz PS/2	x1
	Port szeregowy	x1	Port szeregowy	x1
	Port LAN	x1	Port LAN	x1
	Port USB	x4	Port USB	x4
	Gniazdb audio	x3	Gniazdb audio	x3
Wymiary płyty	218mm (S) X 293 mm (W)		218mm (S) X 293 mm (W)	
Funkcje specjalne	NVIDIA nTunes.		NVIDIA nTunes.	
	NVIDIA Firewall (wyłącznie dla NF4 AM2G)		NVIDIA Firewall	
	Obsługa RAID 0 / 1 / 0+1		Obsługa RAID 0 / 1 / 0+1 / 5	
Obsługa systemu operacyjnego	Windows 2K / XP		Windows 2K / XP	
	Biostar zastrzega sobie prawo dodawania lub odwoływania obsługi dowolnego systemu operacyjnego bez powiadamiania.		Biostar zastrzega sobie prawo dodawania lub odwoływania obsługi dowolnego systemu operacyjnego bez powiadamiania.	

RUSSIAN

	NF4 AM2G / NF4 AM2L	NF4U AM2G
CPU (центральный процессор)	Гнездо AM2 Процессоры AMD Athlon 64 / Athlon 64 FX / Athlon 64X2 / Sempron Архитектура AMD 64 разрешать обработка данных на 32 и 64 бит Поддержка Hyper Transport и Cool'n'Quiet	Гнездо AM2 Процессоры AMD Athlon 64 / Athlon 64 FX / Athlon 64X2 / Sempron Архитектура AMD 64 разрешать обработка данных на 32 и 64 бит Поддержка Hyper Transport и Cool'n'Quiet
FSB	Поддержка HyperTransport с пропускной способностью до 1000 МГц	Поддержка HyperTransport с пропускной способностью до 1000 МГц
Набор микросхем	nVIDIA nForce 4	nVIDIA nForce 4 Ultra
Основная память	Слоты DDR2 DIMM x 4 Каждый модуль DIMM поддерживает 256/512 МБ & 1 ГБ DDR2 Максимальная ёмкость памяти 4 ГБ Модуль памяти с двужанальным режимом DDR2 Поддержка DDR2 400 / 533 / 667 / 800 Не поддерживает зарегистрированные модули DIMM and Non-ECC DIMM	Слоты DDR2 DIMM x 4 Каждый модуль DIMM поддерживает 256/512 МБ & 1 ГБ DDR2 Максимальная ёмкость памяти 4 ГБ Модуль памяти с двужанальным режимом DDR2 Поддержка DDR2 400 / 533 / 667 / 800 Не поддерживает зарегистрированные модули DIMM and Non-ECC DIMM
Super I/O	ITE 8712F / 8716F Обеспечивает наиболее используемые действующие функциональные возможности Super I/O. Интерфейс с низким количеством выводов	ITE 8712F / 8716F Обеспечивает наиболее используемые действующие функциональные возможности Super I/O. Интерфейс с низким количеством выводов
IDE	Встроенное устройство управления встроенными интерфейсами устройств Режим "хвояина" шины Ultra DMA 33 / 66 / 100 / 133 Поддержка режима PIO 0~4,	Встроенное устройство управления встроенными интерфейсами устройств Режим "хвояина" шины Ultra DMA 33 / 66 / 100 / 133 Поддержка режима PIO 0~4,
SATA	Встроенное последовательное устройство управления ATA скорость передачи данных до 1.5 гигабит/с. Соответствие спецификации SATA версия 1.0.	Встроенное последовательное устройство управления ATA скорость передачи данных до 3.0 гигабит/с. Соответствие спецификации SATA версия 2.0.
Локальная сеть	Marrell 88E3016 PHY (только для NF4 AM2L) Автоматическое согласование 10 / 100 Мб/с. Marrell 88E1116 PHY (только для NF4 AM2G) Автоматическое согласование 10 / 100 / 1000 Мб/с.	Marrell 88E1116 PHY Автоматическое согласование 10 / 100 / 1000 Мб/с.
Звуковой кодек	ALC655 / 658 (дополнительно) Шестиканальный звуковой выход AC'97 Версия 2.3 Вывод S/PDIF	ALC655 / 658 (дополнительно) Шестиканальный звуковой выход AC'97 Версия 2.3 Вывод S/PDIF
Слоты	Слот PCI x2	Слот PCI x2

NF4 AM2G / NF4 AM2L / NF4UAM2G

	Слот PCI Express x16	x1	Слот PCI Express x16	x1
	Слот PCI Express x 1	x1	Слот PCI Express x 1	x1
Встроенный разъем	Разъем НГМД	x1	Разъем НГМД	x1
	Разъем Порт подключения принтера	x1	Разъем Порт подключения принтера	x1
	Разъем IDE	x2	Разъем IDE	x2
	Разъем SATA	x4	Разъем SATA	x4
	Разъем на лицевой панели	x1	Разъем на лицевой панели	x1
	Входной звуковой разъем	x1	Входной звуковой разъем	x1
	Разъем ввода для CD	x1	Разъем ввода для CD	x1
	Разъем вывода для S/PDIF	x1	Разъем вывода для S/PDIF	x1
	Контактирующее приспособление вентилятора центрального процессора	x1	Контактирующее приспособление вентилятора центрального процессора	x1
	Контактирующее приспособление вентилятора системы	x3	Контактирующее приспособление вентилятора системы	x3
	Шасси открытого контактирующего приспособления (дополнительно)	x1	Шасси открытого контактирующего приспособления (дополнительно)	x1
	Открытое контактирующее приспособление CMOS	x1	Открытое контактирующее приспособление CMOS	x1
	USB-разъем	x3	USB-разъем	x3
	Разъем питания (24 вывод)	x1	Разъем питания (24 вывод)	x1
Разъем питания (4 вывод)	x1	Разъем питания (4 вывод)	x1	
Задняя панель средств ввода-вывода	Клавиатура PS/2	x1	Клавиатура PS/2	x1
	Мышь PS/2	x1	Мышь PS/2	x1
	Последовательный порт	x1	Последовательный порт	x1
	Порт LAN	x1	Порт LAN	x1
	USB-порт	x4	USB-порт	x4
	Гнездо для подключения наушников	x3	Гнездо для подключения наушников	x3
Размер панели	218 мм (Ш) X 293 мм (В)		218 мм (Ш) X 293 мм (В)	
Специальные технические характеристики	NVIDIA nTunes NVIDIA Firewall (только для NF4AM2G) Поддержка RAID 0/ 1 / 0+1		NVIDIA nTunes NVIDIA Firewall Поддержка RAID 0/ 1 / 0+1 / 5	
Поддержка OS	Windows 2K / XP Bicstar сохраняет за собой право добавлять или удалять средства обеспечения для OS с или без предварительного уведомления.		Windows 2K / XP Bicstar сохраняет за собой право добавлять или удалять средства обеспечения для OS с или без предварительного уведомления.	

ARABIC

NF4U AM2G	NF4 AM2G / NF4 AM2L	
AM2مقيس معالجات AMD Athlon 64 / Athlon 64 FX / Athlon 64X2 / Sempron إجراء العمليات لحلوية بسعة 32 و 64 بت AMD 64ت يمكن تقنية Hyper Transport و Cod'nQuiet تدعم تقنية	AM2مقيس معالجات AMD Athlon 64 / Athlon 64 FX / Athlon 64X2 / Sempron إجراء العمليات لحلوية بسعة 32 و 64 بت AMD 64ت يمكن تقنية Hyper Transport و Cod'nQuiet تدعم تقنية	وحدة لمعالجة المركبة
تردد 1000 بت يربط إلى Hyper Transport تدعم تقنية	تردد 1000 بت يربط إلى Hyper Transport تدعم تقنية	النقل الأمامي لجنبي
nVIDIA nForce 4 Ultra	nVIDIA nForce 4	مجموعة لشوايح
عدد 4 فتحة DDR2 DIMM ميغا 256/512 سعة DDR2 دعم ذاكرة من نوع DIMM تدعم كل قحة بيت و 1 جيجا بيت سعة ذاكرة قصوى 4 جيجا بايت مزوجة لفتحة DDR2 وحدة ذاكرة ميغا 400 / 533 / 667 / 800 سعة DDR2 تدعم الذاكرة من نوع بيت ECC لمسجلة وذلك لتي لا تتوافق مع DIMM لا دعم رفلق الذاكرة	عدد 4 فتحة DDR2 DIMM ميغا 256/512 سعة DDR2 دعم ذاكرة من نوع DIMM تدعم كل قحة بيت و 1 جيجا بيت سعة ذاكرة قصوى 4 جيجا بايت مزوجة لفتحة DDR2 وحدة ذاكرة ميغا 400 / 533 / 667 / 800 سعة DDR2 تدعم الذاكرة من نوع بيت ECC لمسجلة وذلك لتي لا تتوافق مع DIMM لا دعم رفلق الذاكرة	الذاكرة الرئيسية
ITE 8712F / 8716F الأكثر استخداماً Super I/O توفر وظيفة Low Pin Count Interface تدعم تقنية	ITE 8712F / 8716F الأكثر استخداماً Super I/O توفر وظيفة Low Pin Count Interface تدعم تقنية	Super I/O
متكامل IDE متحكم Ultra DMA 33 / 66 / 100 / 133 نقل بتقنية وضع رئيسي	متكامل IDE متحكم Ultra DMA 33 / 66 / 100 / 133 نقل بتقنية وضع رئيسي	منفذ IDE
متكامل Serial ATA متحكم قل البيانات بسرعات تصل إلى 3.0 جيجابايت/ثانية. الإصدار SATA مطابقة للمواصفات 2.0	متكامل Serial ATA متحكم قل البيانات بسرعات تصل إلى 1.5 جيجابايت/ثانية. الإصدار SATA مطابقة للمواصفات 1.0	SATA
Marrell 88E1116 PHY قلووس فئتي 1000 / 100/10 / 1000 / 100/10 ميجا بايت / ثلييتو	(فقط NF4 AM2L في) Marrell 88E3016 PHY قلووس فئتي 100/10 ميجا بايت / ثلييتو (فقط NF4 AM2G في) Marrell 88E1116 PHY قلووس فئتي 1000 / 100/10 ميجا بايت / ثلييتو	شبكة داخلية
(اختياري) ALC 655 / 658 قنوات لخرج الصوت 6 AC'97 من 2.3 الإصدار S/PDIF خرج	(اختياري) ALC 655 / 658 قنوات لخرج الصوت 6 AC'97 من 2.3 الإصدار S/PDIF خرج	كوديك الصوت
عدد 4 فتحة PCI عدد 1 فتحة PCI Express x 16 عدد 2 فتحة PCI Express x 1	عدد 4 فتحة PCI عدد 1 فتحة PCI Express x 16 عدد 2 فتحة PCI Express x 1	الفتحات
عدد 1 مقعد محرك أو اوص مرنة	عدد 1 مقعد محرك أو اوص مرنة	مقعد محرك أو اوص مرنة

المنافذ على سطح

NF4 AM2G / NF4 AM2L / NF4UAM2G

عدد 1	مقذ طابعة	عدد 1	مقذ طابعة	اللوحة
عدد 2	مقذ IDE	عدد 2	مقذ IDE	
عدد 4	مقذ SATA	عدد 4	مقذ SATA	
عدد 1	مقذ اللوحة الأممية	عدد 1	مقذ اللوحة الأممية	
عدد 1	مقذ الصوت الأممي	عدد 1	مقذ الصوت الأممي	
عدد 1	مقذ CD-IN	عدد 1	مقذ CD-IN	
عدد 1	مقذ خرج S/PDIF	عدد 1	مقذ خرج S/PDIF	
عدد 1	وصلة مروحة وحدة المعالجة المركزية	عدد 1	وصلة مروحة وحدة المعالجة المركزية	
عدد 3	وصلة مروحة النظم	عدد 3	وصلة مروحة النظم	
عدد 1	وصلة فتح الهيكل (اختياري)	عدد 1	وصلة فتح الهيكل (اختياري)	
عدد 1	وصلة مسح CMOS	عدد 1	وصلة مسح CMOS	
عدد 3	مقذ USB	عدد 3	مقذ USB	
عدد 1	مقذ توصيل الطاقة (24دوس)	عدد 1	مقذ توصيل الطاقة (24دوس)	
عدد 1	مقذ توصيل الطاقة (4دبليس)	عدد 1	مقذ توصيل الطاقة (4دبليس)	
عدد 1	لوحة مفاتيح PS/2	عدد 1	لوحة مفاتيح PS/2	
عدد 1	مؤس PS/2	عدد 1	مؤس PS/2	
عدد 1	مقذ تسلسلي	عدد 1	مقذ تسلسلي	منافذ دخل/خرج
عدد 1	مقذ شبكة تصل محلية	عدد 1	مقذ شبكة تصل محلية	اللوحة الخلفية
عدد 4	منافذ USB	عدد 4	منافذ USB	
عدد 3	مقيس صوت	عدد 3	مقيس صوت	
	NVIDIA nTunes		NVIDIA nTunes	
	NVIDIA Firewall		NVIDIA Firewall (فقط NF4 AM2G في)	مزيا خاصة
	RAID 0 / 1 / 0+1 / 5 تدعم تقنية		RAID 0 / 1 / 0+1 تدعم تقنية	
	218مم (عرض) X 293مم (ارتفاع)		218مم (عرض) X 293مم (ارتفاع)	حمم الوحدة
	Windows 2K / XP		Windows 2K / XP	
	بحقها في اضافة أو ازالة اعم ابي نظام تشغيل باخطل أو Biostar تحفظ بيون اخطل.		بحقها في اضافة أو ازالة اعم ابي نظام تشغيل باخطل أو Biostar تحفظ بيون اخطل.	دعم أنظمة تشغيل

JAPANESE

	NF4 AM2G / NF4 AM2L	NF4U AM2G
CPU	Socket AM2 AMDAthlon 64 / Athlon 64 FX / Athlon 64X2 / Sempron プロセッサ AMD64アーキテクチャでは、32ビットと64ビット計算が可能です ハイパートランスポートとクールアンドクワイアットをサポートします	Socket AM2 AMDAthlon 64 / Athlon 64 FX / Athlon 64X2 / Sempron プロセッサ AMD64アーキテクチャでは、32ビットと64ビット計算が可能です ハイパートランスポートとクールアンドクワイアットをサポートします
FSB	1000 MHz のバンド幅までハイパートランスポートをサポートします	1000 MHz のバンド幅までハイパートランスポートをサポートします
チップセット	nVIDIA nForce4	nVIDIA nForce4 Ultra
メインメモリ	DDR2 DIMMスロット x 4 各DIMMは 256/512MB & 1GB DDR2をサポート 最大メモリ容量4GB デュアル チャンネルモードDDR2メモリモジュール DDR2 400 / 533 / 667 / 800をサポート 登録済みDIMMと非ECC DIMMはサポートされません	DDR2 DIMMスロット x 4 各DIMMは 256/512MB & 1GB DDR2をサポート 最大メモリ容量4GB デュアル チャンネルモードDDR2メモリモジュール DDR2 400 / 533 / 667 / 800をサポート 登録済みDIMMと非ECC DIMMはサポートされません
Super I/O	ITE 8712F / 8716F もっとも一般に使用されるレガシーSuper I/O機能を採用しています。 低ピンカウントインターフェイス	ITE 8712F / 8716F もっとも一般に使用されるレガシーSuper I/O機能を採用しています。 低ピンカウントインターフェイス
IDE	統合IDEコントローラ Ultra DMA 33 / 66 / 100 / 133バスマスタモード	統合IDEコントローラ Ultra DMA 33 / 66 / 100 / 133バスマスタモード
SATA	統合シリアルATAコントローラ 最高 1.5 Gb/秒のデータ転送速度 SATAバージョン1.0仕様に準拠。	統合シリアルATAコントローラ 最高 3.0 Gb/秒のデータ転送速度 SATAバージョン2.0仕様に準拠。
LAN	Marrell 88E3016 PHY (NF4AM2L のみ) 10 / 100 Mb/秒のオートネゴシエーション Marrell 88E1116 PHY (NF4AM2G のみ) 10 / 100 / 1000Mb/秒のオートネゴシエーション	Marrell 88E1116 PHY 10 / 100 / 1000Mb/秒のオートネゴシエーション
サウンド Codec	ALC 655 / 658 (オプション) 6チャンネルオーディオアウト AC'97バージョン2.3 S/PDIF アウト	ALC 655 / 658 (オプション) 6チャンネルオーディオアウト AC'97バージョン2.3 S/PDIF アウト
スロット	PCIスロット x4 PCI Express x16スロット x1 PCI Express x 1スロット x2	PCIスロット x4 PCI Express x16スロット x1 PCI Express x 1スロット x2
オンボードコ	フロッピーコネクタ x1	フロッピーコネクタ x1

NF4 AM2G / NF4 AM2L / NF4UAM2G

ネクタ	プリンタポートコネクタ	x1	プリンタポートコネクタ	x1
	IDEコネクタ	x2	IDEコネクタ	x2
	SATAコネクタ	x4	SATAコネクタ	x4
	フロントパネルコネクタ	x1	フロントパネルコネクタ	x1
	フロントオーディオコネクタ	x1	フロントオーディオコネクタ	x1
	CDインコネクタ	x1	CDインコネクタ	x1
	S/PDIFアウトコネクタ	x1	S/PDIFアウトコネクタ	x1
	CPUファンヘッド	x1	CPUファンヘッド	x1
	システムファンヘッド	x3	システムファンヘッド	x3
	シャーシオープンヘッド(オプション)	x1	シャーシオープンヘッド(オプション)	x1
	CMOSクリアヘッド	x1	CMOSクリアヘッド	x1
	USBコネクタ	x3	USBコネクタ	x3
	電源コネクタ(24ピン)	x1	電源コネクタ(24ピン)	x1
	電源コネクタ(4ピン)	x1	電源コネクタ(4ピン)	x1
背面パネル I/O	PS/2キーボード	x1	PS/2キーボード	x1
	PS/2マウス	x1	PS/2マウス	x1
	シリアルポート	x1	シリアルポート	x1
	LANポート	x1	LANポート	x1
	USBポート	x4	USBポート	x4
	オーディオジャック	x3	オーディオジャック	x3
ボードサイズ	218 mm (幅) X 293 mm (高さ)		218 mm (幅) X 293 mm (高さ)	
特殊機能	NVIDIA nTunes		NVIDIA nTunes	
	NVIDIA Firewall (NF4AM2G のみ)		NVIDIA Firewall	
	RAID 0 / 1 / 0+1 のサポート		RAID 0 / 1 / 0+1 / 5 のサポート	
OSサポート	Windows 2K / XP		Windows 2K / XP	
	Bicstarは事前のサポートなしにOSサポートを追加または削除する権利を留保します。		Bicstarは事前のサポートなしにOSサポートを追加または削除する権利を留保します。	

2006/07/14

**NF4 AM2G / NF4 AM2L / NF4U AM2G
BIOS SETUP**

BIOS Setup	1
1 Main Menu	3
2 Standard CMOS Features.....	7
3 Advanced BIOS Features	9
4 Advanced Chipset Features.....	14
5 Integrated Peripherals.....	21
6 Power Management Setup	27
7 PnP/PCI Configurations.....	31
8 PC Health Status	34
9 Frequency/ Voltage Control	36

NF4 AM2G / NF4 AM2L / NF4U AM2G

BIOS Setup

Introduction

The purpose of this manual is to describe the settings in the Award™ BIOS Setup program on this motherboard. The Setup program allows users to modify the basic system configuration and save these settings to CMOS RAM. The power of CMOS RAM is supplied by a battery so that it retains the Setup information when the power is turned off.

Basic Input-Output System (BIOS) determines what a computer can do without accessing programs from a disk. This system controls most of the input and output devices such as keyboard, mouse, serial ports and disk drives. BIOS activates at the first stage of the booting process, loading and executing the operating system. Some additional features, such as virus and password protection or chipset fine-tuning options are also included in BIOS.

The rest of this manual will to guide you through the options and settings in BIOS Setup.

Plug and Play Support

This AWARD BIOS supports the Plug and Play Version 1.0A specification and ESCD (Extended System Configuration Data) write.

EPA Green PC Support

This AWARD BIOS supports Version 1.03 of the EPA Green PC specification.

APM Support

This AWARD BIOS supports Version 1.1&1.2 of the Advanced Power Management (APM) specification. Power management features are implemented via the System Management Interrupt (SMI). Sleep and Suspend power management modes are supported. Power to the hard disk drives and video monitors can also be managed by this AWARD BIOS.

ACPI Support

Award ACPI BIOS support Version 1.0 of Advanced Configuration and Power interface specification (ACPI). It provides ASL code for power management and device configuration capabilities as defined in the ACPI specification, developed by Microsoft, Intel and Toshiba.

PCI Bus Support

This AWARD BIOS also supports Version 2.1 of the Intel PCI (Peripheral Component Interconnect) local bus specification.

NF4 AM2G / NF4 AM2L / NF4U AM2G

DRAM Support

DDR SDRAM (Double Data Rate Synchronous DRAM) is supported.

Supported CPUs

This AWARD BIOS supports the AMD CPU.

Using Setup

Use the arrow keys to highlight items in most of the place, press <Enter> to select, use the <PgUp> and <PgDn> keys to change entries, press <F1> for help and press <Esc> to quit. The following table provides more detail about how to navigate in the Setup program by using the keyboard.

Keystroke	Function
Up arrow	Move to previous item
Down arrow	Move to next item
Left arrow	Move to the item on the left (menu bar)
Right arrow	Move to the item on the right (menu bar)
Move Enter	Move to the item you desired
PgUp key	Increase the numeric value or make changes
PgDn key	Decrease the numeric value or make changes
+ Key	Increase the numeric value or make changes
- Key	Decrease the numeric value or make changes
Esc key	Main Menu – Quit and not save changes into CMOS Status Page Setup Menu and Option Page Setup Menu – Exit Current page and return to Main Menu
F1 key	General help on Setup navigation keys
F5 key	Load previous values from CMOS
F7 key	Load the optimized defaults
F10 key	Save all the CMOS changes and exit

NF4 AM2G / NF4 AM2L / NF4U AM2G

1 Main Menu

Once you enter Award BIOS™ CMOS Setup Utility, the Main Menu will appear on the screen. The Main Menu allows you to select from several setup functions. Use the arrow keys to select among the items and press <Enter> to accept and enter the sub-menu.

Figure 1: Main Menu

!! WARNING !!

For better system performance, the BIOS firmware is being continuously updated. The BIOS information described in this manual (**Figure 1, 2, 3, 4, 5, 6, 7, 8, 9**) is for your reference only. The actual BIOS information and settings on board may be slightly different from this manual.

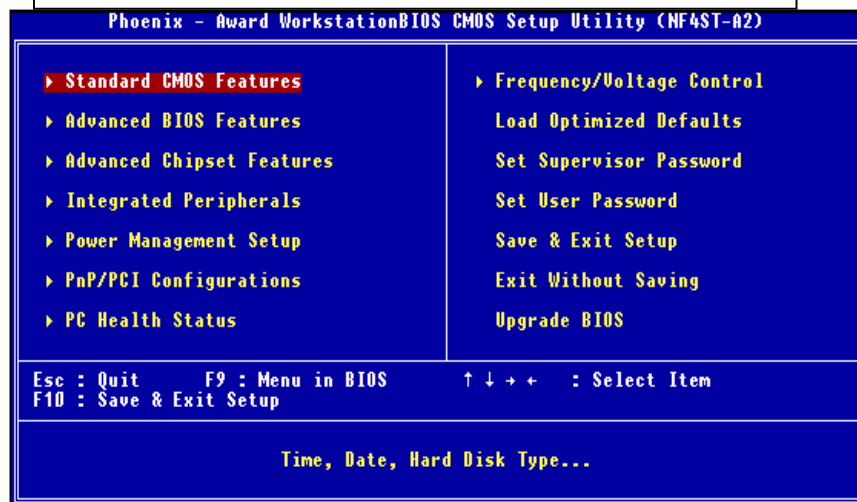

Standard CMOS Features

This submenu contains industry standard configurable options.

Advanced BIOS Features

This submenu allows you to configure advanced features of the BIOS.

Advanced Chipset Features

This submenu allows you to configure special chipset features.

NF4 AM2G / NF4 AM2L / NF4U AM2G

Integrated Peripherals

This submenu allows you to configure certain IDE hard drive options and Programmed Input/ Output features.

Power Management Setup

This submenu allows you to configure the power management features.

PnP/PCI Configurations

This submenu allows you to configure certain “Plug and Play” and PCI options.

PC Health Status

This submenu allows you to monitor the hardware of your system.

Frequency/ Voltage Control

This submenu allows you to change CPU Vcore Voltage and CPU/PCI clock. (However, we suggest you to use the default setting. Changing the voltage and clock improperly may damage the CPU or M/B!)

Load Optimized Defaults

This selection allows you to reload the BIOS when problem occurs during system booting sequence. These configurations are factory settings optimized for this system. A confirmation message will be displayed before defaults are set.



Load Optimized Defaults (Y/N)? N

NF4 AM2G / NF4 AM2L / NF4U AM2G

Set Supervisor Password

Setting the supervisor password will prohibit everyone except the supervisor from making changes using the CMOS Setup Utility. You will be prompted with to enter a password.

Enter Password:

Set User Password

If the Supervisor Password is not set, then the User Password will function in the same way as the Supervisor Password. If the Supervisor Password is set and the User Password is set, the “User” will only be able to view configurations but will not be able to change them.

Enter Password:

Save & Exit Setup

Save all configuration changes to CMOS (memory) and exit setup. Confirmation message will be displayed before proceeding.

SAVE to CMOS and EXIT (Y/N)? Y

Exit Without Saving

Abandon all changes made during the current session and exit setup. Confirmation message will be displayed before proceeding.

Quit Without Saving (Y/N)? N

NF4 AM2G / NF4 AM2L / NF4U AM2G

Upgrade BIOS

This submenu allows you to upgrade bios.

BIOS UPDATE UTILITY (Y/N)? **N**

NF4 AM2G / NF4 AM2L / NF4U AM2G

2 Standard CMOS Features

The items in Standard CMOS Setup Menu are divided into several categories. Each category includes no, one or more than one setup items. Use the arrow keys to highlight the item and then use the <PgUp> or <PgDn> keys to select the value you want in each item.

■ **Figure 2: Standard CMOS Setup**

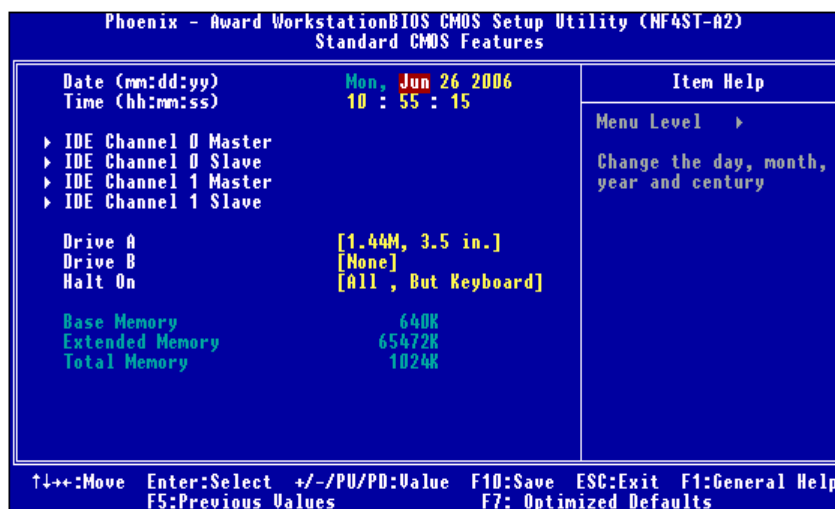

Main Menu Selections

This table shows the items and the available options on the Main Menu.

Item	Options	Description
Date	mm : dd : yy	Set the system date. Note that the 'Day' automatically changes when you set the date.
Time	hh : mm : ss	Set the system internal clock.
IDE Primary Master	Options are in its sub menu.	Press <Enter> to enter the sub menu of detailed options
IDE Primary Slave	Options are in its sub menu.	Press <Enter> to enter the sub menu of detailed options.

NF4 AM2G / NF4 AM2L / NF4U AM2G

Item	Options	Description
IDE Secondary Master	Options are in its sub menu.	Press <Enter> to enter the sub menu of detailed options.
IDE Secondary Slave	Options are in its sub menu.	Press <Enter> to enter the sub menu of detailed options.
Drive A Drive B	360K, 5.25 in 1.2M, 5.25 in 720K, 3.5 in 1.44M, 3.5 in 2.88M, 3.5 in None	Select the type of floppy disk drive installed in your system.
Video	EGA/VGA CGA 40 CGA 80 MONO	Select the default video device.
Halt On	All Errors No Errors All, but Keyboard All, but Diskette All, but Disk/ Key	Select the situation in which you want the BIOS to stop the POST process and notify you.
Base Memory	N/A	Displays the amount of conventional memory detected during boot up.
Extended Memory	N/A	Displays the amount of extended memory detected during boot up.
Total Memory	N/A	Displays the total memory available in the system.

NF4 AM2G / NF4 AM2L / NF4U AM2G

3 Advanced BIOS Features

■ Figure 3: Advanced BIOS Setup

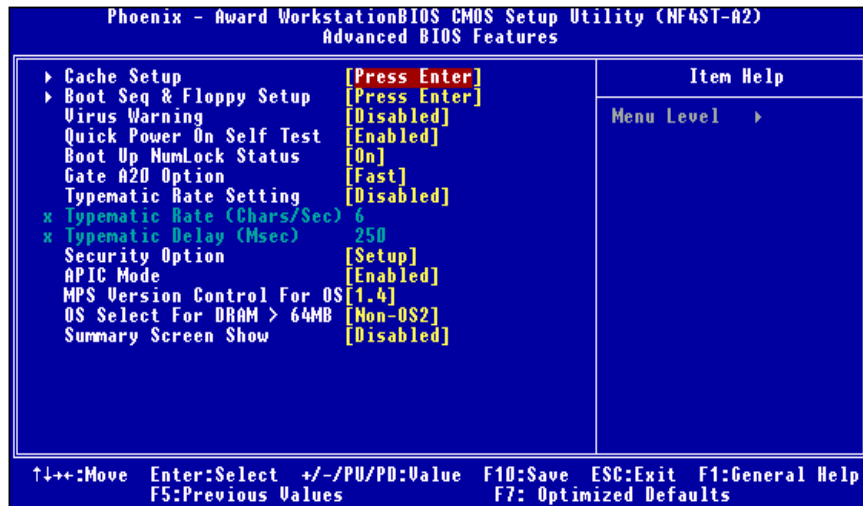

Cache Setup

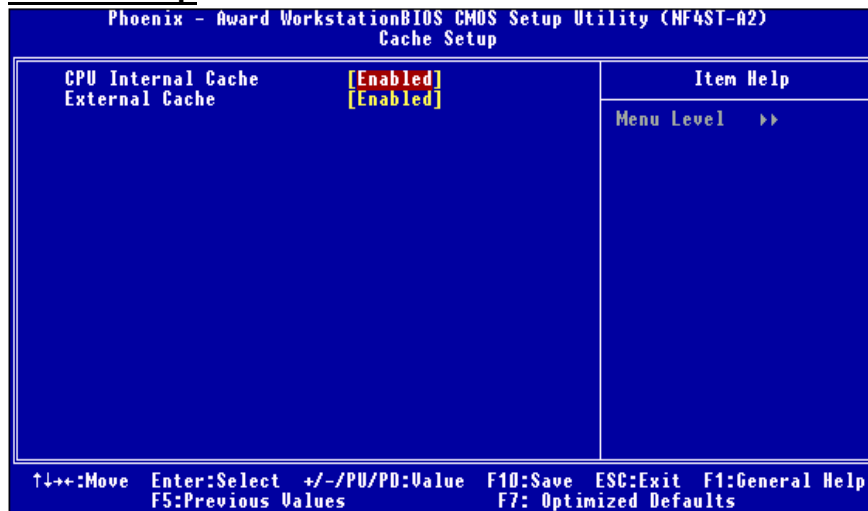

NF4 AM2G / NF4 AM2L / NF4U AM2G

CPU Internal Cache

Depending on the CPU/chipset in use, you may be able to increase memory access time with this option.

Enabled (default) Enable cache.
Disabled Disable cache.

External Cache

This option enables or disables "Level 2" secondary cache on the CPU, which may improve performance.

Enabled (default) Enable cache.
Disabled Disable cache.

Boot Seq & Floppy Setup

This item allows you to setup boot sequence & Floppy.

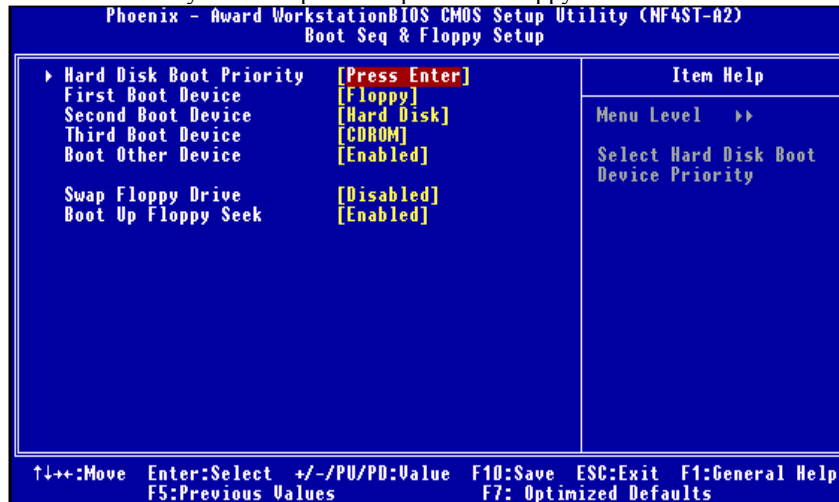

NF4 AM2G / NF4 AM2L / NF4U AM2G

Hard Disk Boot Priority

The BIOS will attempt to arrange the Hard Disk boot sequence automatically. You can change the Hard Disk booting sequence here.

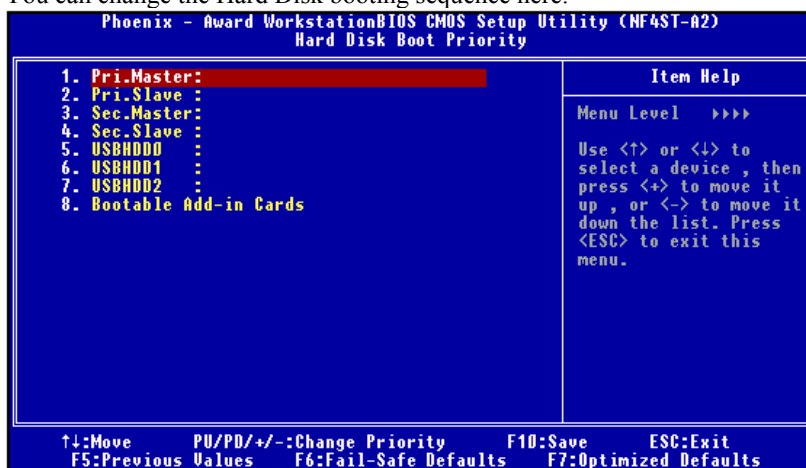

The Choices: Pri. Master, Pri. Slave, Sec. Master, Sec. Slave, USB HDD0, USB HDD1, USB HDD2, and Bootable Add-in Cards.

First/Second/Third Boot Device

The BIOS will attempt to load the operating system in this order.

The Choices: Floppy, LS120, HDD-0, SCSI, CDROM, HDD-1, HDD-2, HDD-3, ZIP100, LAN, HPT370, Disabled.

Boot Other Device

When enabled, BIOS will try to load the operating system from other device when it failed to load from the three devices above.

The Choices: Enabled (default), Disabled

Swap Floppy Drive

For systems with two floppy drives, this option allows you to swap logical drive assignments.

The Choices: Disabled (default), Enabled.

Boot Up Floppy Seek

When enabled, System will test the floppy drives to determine if they have 40 or 80 tracks during boot up. Disabling this option reduces the time it takes to boot-up.

The Choices: Enabled (default), Disabled.

NF4 AM2G / NF4 AM2L / NF4U AM2G

Virus Warning

This option allows you to choose the VIRUS Warning feature that is used to protect the IDE Hard Disk boot sector. If this function is enabled and an attempt is made to write to the boot sector, BIOS will display a warning message on the screen and sound an alarm beep.

Disabled (default) Virus protection is disabled.
Enabled Virus protection is activated.

Quick Power On Self Test

Enabling this option will cause an abridged version of the Power On Self-Test (POST) to execute after you power up the computer.

Disabled Normal POST.
Enabled (default) Enable quick POST.

Boot Up NumLock Status

Selects the NumLock State after the system switched on.

The Choices:

On (default) Numpad is number keys.
Off Numpad is arrow keys.

Gate A20 Option

Select if chipset or keyboard controller should control Gate A20.

Normal A pin in the keyboard controller controls GateA20.

Fast (default) Lets chipset control Gate A20.

Typematic Rate Setting

When a key is held down, the keystroke will repeat at a rate determined by the keyboard controller. When enabled, the typematic rate and typematic delay can be configured.

The Choices: **Disabled** (default), Enabled.

Typematic Rate (Chars/Sec)

Sets the rate at which a keystroke is repeated when you hold the key down.

The Choices: **6** (default), 8, 10, 12, 15, 20, 24, 30.

NF4 AM2G / NF4 AM2L / NF4U AM2G

Typematic Delay (Msec)

Sets the delay time after the key is held down before it begins to repeat the keystroke.

The Choices: 250 (default), 500, 750, 1000.

Security Option

This option will enable only individuals with passwords to bring the system online and/or to use the CMOS Setup Utility.

System: A password is required for the system to boot and is also required to access the Setup Utility.

Setup (default): A password is required to access the Setup Utility only.

This will only apply if passwords are set from the Setup main menu.

APIC MODE

Selecting Enabled enables APIC device mode reporting from the BIOS to the operating system.

The Choices: Enabled (default), Disabled.

MPS Version Control For OS

The BIOS supports version 1.1 and 1.4 of the Intel multiprocessor specification.

Select version supported by the operation system running on this computer.

The Choices: 1.4 (default), 1.1.

OS Select For DRAM > 64MB

A choice other than Non-OS2 is only used for OS2 systems with memory exceeding 64MB.

The Choices: Non-OS2 (default), OS2.

Summary Screen Show

This item allows you to enable/disable the summary screen. Summary screen means system configuration and PCI device listing.

The Choices: Disabled (default), Enabled.

NF4 AM2G / NF4 AM2L / NF4U AM2G

4 Advanced Chipset Features

This submenu allows you to configure the specific features of the chipset installed on your system. This chipset manage bus speeds and access to system memory resources, such as DRAM. It also coordinates communications with the PCI bus. The default settings that came with your system have been optimized and therefore should not be changed unless you are suspicious that the settings have been changed incorrectly.

■ **Figure 4: Advanced Chipset Setup**

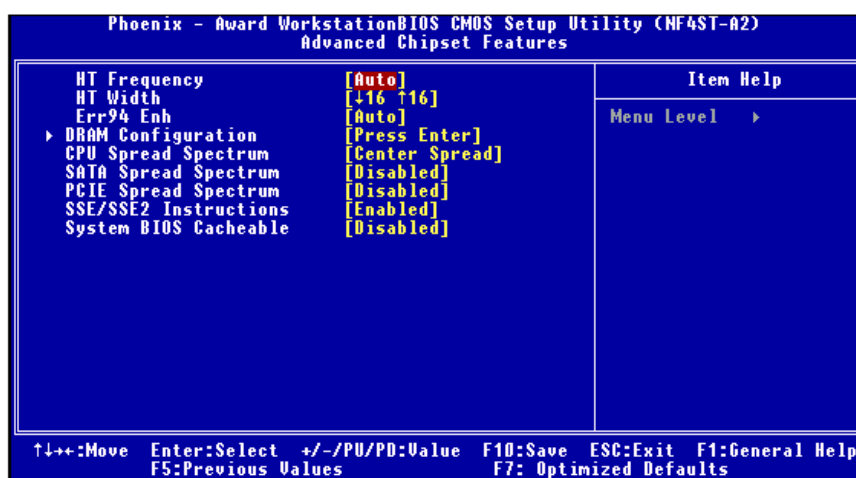

HT Frequency

This item allows you to select HT Frequency.

The Choices: Auto (Default), 1X, 2X, 3X, 4X, 5X.

HT Width

This item allows you to select HT Width.

The Choices: ↓ 16, ↑ 16 (Default), ↓ 8, ↑ 8, ↓ 8, ↑ 16, ↓ 16, ↑ 8.

Err94 Enh

This item allows you to enable/disable the “sequential Prefetch Feature” of K8 CPU.

The Choices: Auto (default), Disabled, Enabled.

DRAM Configuration

NF4 AM2G / NF4 AM2L / NF4U AM2G

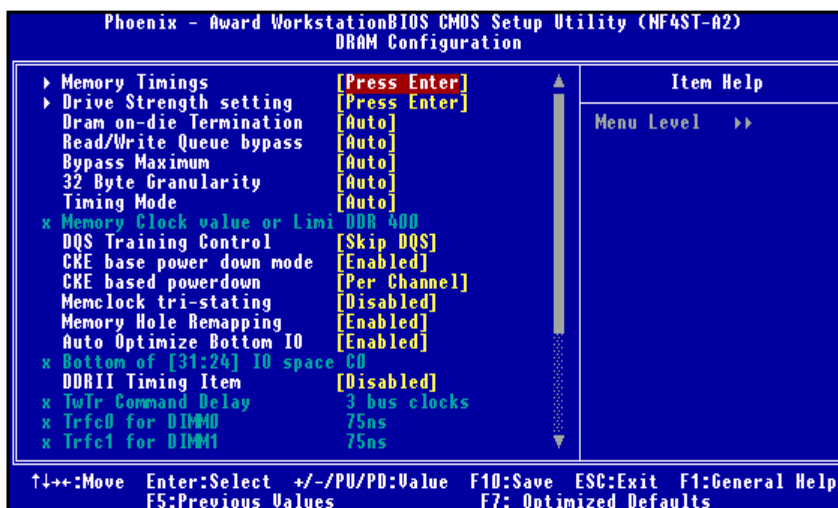

Memory Timings

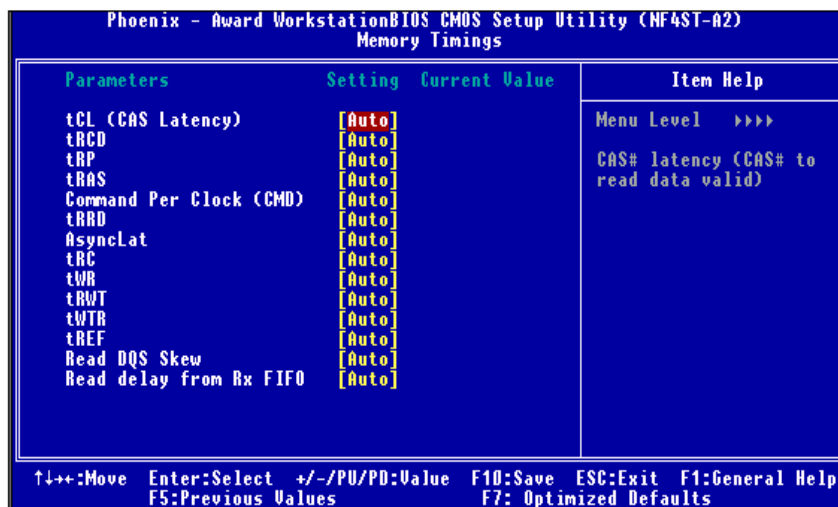

NF4 AM2G / NF4 AM2L / NF4U AM2G

tCL <CAS Latency>

The Choices: **Auto** (Default), 3 Clock, 4 Clock, 5 Clock, 6 Clock.

tRCD

The Choices: **Auto** (Default), 3 Clock, 4 Clock, 5 Clock, 6 Clock.

tRP

The Choices: **Auto** (Default), 3 Clock, 4 Clock, 5 Clock, 6 Clock.

tRAS

The Choices: **Auto** (Default), 5 Clock, 6 Clock, 7 Clock, 8 Clock, 9 Clock, 10 Clock, 11 Clock, 12 Clock, 13 Clock, 14 Clock, 15 Clock, 16 Clock, 17 Clock, 18 Clock.

Command Per Clock <CMD>

The Choices: **Auto** (Default), 1 Clock, 2 Clock.

tRRD

The Choices: **Auto** (Default), 2 Clock, 3 Clock, 4 Clock, 5 Clock

AsyncLat

The Choices: **Auto** (Default), 1ns, 2ns, 3ns, 4ns, 5ns, 6ns, 7ns, 8ns, 9ns, 10ns, 11ns, 12ns, 13ns, 14ns, 15ns.

tRC

The Choices: **Auto** (Default), 11 Clock, 12 Clock, 13 Clock, 14 Clock, 15 Clock, 16 Clock, 17 Clock, 18 Clock, 19 Clock, 20 Clock, 21 Clock, 22 Clock, 23 Clock, 24 Clock, 25 Clock, 26 Clock.

tWR

The Choices: **Auto** (Default), 3 Clock, 4 Clock, 5 Clock, 6 Clock.

tRWT

The Choices: **Auto** (Default), 2 Clock, 3 Clock, 4 Clock, 5 Clock, 6 Clock, 7 Clock, 8 Clock, 9 Clock.

tWTR

The Choices: **Auto** (Default), 1 Clock, 2 Clock, 3 Clock.

tREF

The Choices: **Auto** (Default), 7.8us, 3.9us.

Read DQS Skew

The Choices: -10/96 Clock...-1/96Clock, **Auto** (Default), +1/96Clock...+10/96 Clock,.

NF4 AM2G / NF4 AM2L / NF4U AM2G

Read delay from Rx FIFO

The Choices: Auto (Default), 0.5 Clock, 1.0 Clock, 1.5 Clock, 2.0 Clock, 2.5 Clock, 3.0 Clock, 3.5 Clock, 4.0 Clock.

Drive Strength Setting

Parameters	Setting	Current Value	Item Help
Dram driver weak mode	[Auto]		Menu Level >>>>
CKE drive strength	[Auto]		DRAM data drive strength on DRAM
CS drive strength	[Auto]		
MA drive strength	[Auto]		
MCLK drive strength	[Auto]		
MD drive strength	[Auto]		
DQS drive strength	[Auto]		

↑↓←→:Move Enter:Select +/-/PU/PD:Value F10:Save ESC:Exit F1:General Help
F5:Previous Values F7: Optimized Defaults

Dram driver weak mode

The Choices: Auto (Default), Normal, Weak.

CKE drive strength

The Choices: Auto (Default), 1.0X, 1.25X, 1.5X, 2.0X.

CS drive strength

The Choices: Auto (Default), 1.0X, 1.25X, 1.5X, 2.0X.

MA drive strength

The Choices: Auto (Default), 1.0X, 1.25X, 1.5X, 2.0X.

MCLK drive strength

The Choices: Auto (Default), 0.75X, 1.0X, 1.25X, 1.50X.

MD drive strength

The Choices: Auto (Default), 0.75X, 1.0X, 1.25X, 1.50X.

DQS drive strength

The Choices: Auto (Default), 0.75X, 1.0X, 1.25X, 1.50X.

Dram on-die Termination

The Choices: AUTO(Default), 75ohm, 150ohm, 50ohm.

NF4 AM2G / NF4 AM2L / NF4U AM2G

Read/Write Queue bypass

The Choices: **AUTO** (Default).

Bypass maximum

The Choices: **AUTO** (Default).

32 Byte Granularity

The Choices: **AUTO** (Default), 64-byte, 32-byte.

Timing Mode

The Choices: **AUTO** (Default), MaxMemCLK.

Memory Clock value or Limi

The Choices: **DDR 400** (Default).

DQS Training Control

The Choices: Perform DQS, **Skip DQS** (default).

CKE base power down mode

The Choices: **Enabled** (default), Disabled.

CKE base powerdown

The Choices: **Per Channel** (default), Per CS.

Memclock tri-stating

The Choices: **Disabled** (default), Enabled.

Memory Hole Remapping

The Choices: **Enabled** (default), Disabled.

Auto Optimize Bottom IO

The Choices: **Enabled** (default), Disabled.

Bottom of [31:24] IO space

Auto Optimize Maximal DRAM size when kernel Assigns PCI Resources
Done.

The Choices: **C0** (default).

DDRII Timing Item

The Choices: **Disabled** (default), Enabled.

TwTr Command Delay

The Choices: **3 bus clocks** (default).

NF4 AM2G / NF4 AM2L / NF4U AM2G

Trfc0 for DIMM0

The Choices: 75ns (default).

Trfc1 for DIMM1

The Choices: 75ns (default).

Trfc2 for DIMM2

The Choices: 75ns (default).

Trfc3 for DIMM3

The Choices: 75ns (default).

(Twr) Write Recovery Time

The Choices: 6 bus clocks (default).

(Trtp) Precharge Time

The Choices: 3 bus clocks (default).

(Trc) Row Cycle Time

The Choices: 26 bus clocks (default).

(Trcd)RAS# to CAS R/W Delay

The Choices: 6 clocks (default).

(Trrd) RAS to RAS Delay

This field specifies the RAS# to CAS# Delay to read/ write command to the same bank. Typically -20 Nsec.

The Choices: 5 clocks (default).

(Trp) Row Precharge Time

This field specifies the Row precharge Time. Precharge to Active or Auto-Refresh of the same bank. Typically 20-24 Nsec.

The Choices: 6 clocks (default).

(Tras) Minimum RAS Active T

The Choices: 18 bus clocks (default).

CPU Spread Spectrum

The Choices: Disable, Center Spread (default).

NF4 AM2G / NF4 AM2L / NF4U AM2G

SATA Spread Spectrum

This item allows you to disable \ enable the SATA spread spectrum function.

The Choices: Disabled (default), Down Spread.

PCIe Spread Spectrum

This item allows you to disable \ enable the SATA spread spectrum function.

The Choices: Down Spread (default), Disable.

SSE/SSE2 Instructions

The Choices: Enabled (default), Disabled.

System BIOS Cacheable

Selecting the “Disabled ” option allows caching of the system BIOS ROM at F0000h-FFFFFh which can improve system performance. However, any programs writing to this area of memory will cause conflicts and result in system errors.

The Choices: Disabled (default), Enabled.

NF4 AM2G / NF4 AM2L / NF4U AM2G

5 Integrated Peripherals

■ Figure 5. Integrated Peripherals

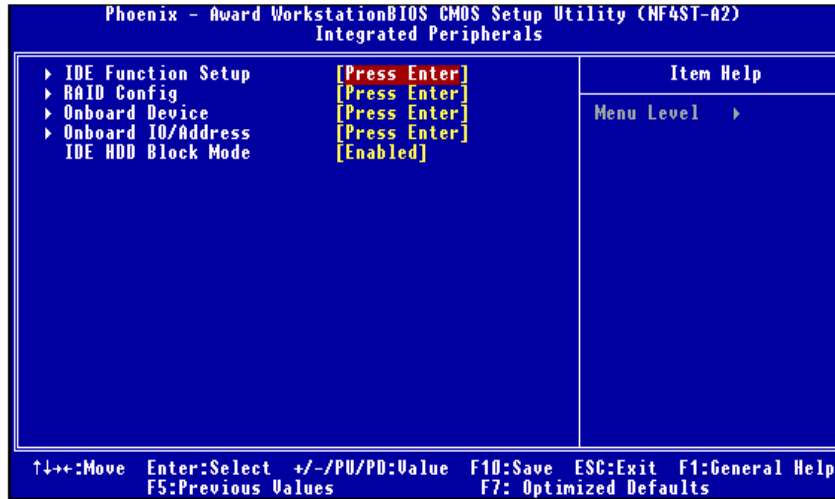

IDE Function Setup

Highlight the “Press Enter” label next to the “IDE Function Setup” label and press enter key will take you a submenu with the following options:

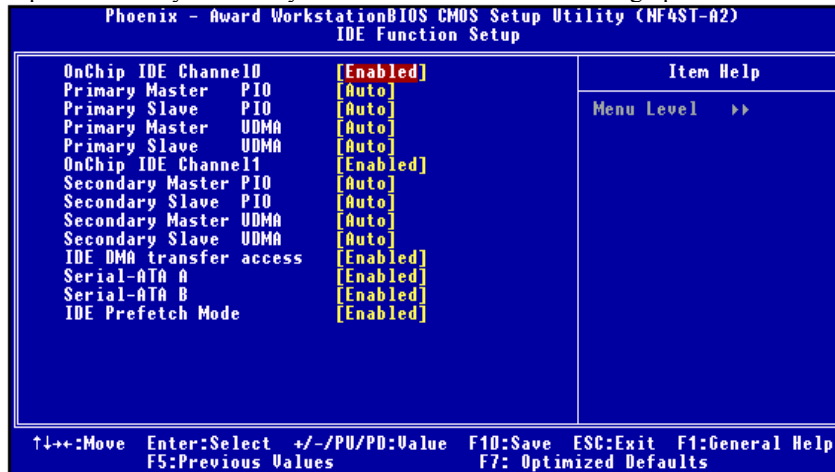

NF4 AM2G / NF4 AM2L / NF4U AM2G

On-chip IDE Channel 0/1

The motherboard chipset contains a PCI IDE interface with support for two IDE channels. Select “Enabled” to activate the first and/or second IDE interface. Select “Disabled” to deactivate an interface if you are going to install a primary and/or secondary add-in IDE interface.

The Choices: Enabled (default), Disabled.

IDE Primary/Secondary/Master/Slave PIO

The IDE PIO (Programmed Input / Output) fields let you set a PIO mode (0-4) for each of the IDE devices that the onboard IDE interface supports. Modes 0 to 4 will increase performance progressively. In Auto mode, the system automatically determines the best mode for each device.

The Choices: Auto (default), Mode0, Mode1, Mode2, Mode3, Mode4.

IDE Primary/Secondary/Master/Slave UDMA

Ultra DMA function can be implemented if it is supported by the IDE hard drives in your system. As well, your operating environment requires a DMA driver (Windows 95 or OSR2 may need a third party IDE bus master driver). If your hard drive and your system software both support Ultra DMA, select Auto to enable BIOS support.

The Choices: Auto (default), Disabled.

IDE DMA Transfer Access

This item allows you to enable or disable the IDE DMA transfer access.

The Choices: Enabled (default), Disabled.

Serial-ATA A

Enables support for Serial-ATA A.

The Choices: Enabled (default), Disabled

Serial-ATA B

Enables support for Serial-ATA B.

The Choices: Enabled (default), Disabled.

IDE Prefetch Mode

The “onboard” IDE drive interfaces supports IDE prefetch function for faster drive access. If the interface on your drive does not support prefetching, or if you install a primary and/or secondary add-in IDE interface, set this option to “Disabled”.

The Choices: Enabled (default), Disabled.

NF4 AM2G / NF4 AM2L / NF4U AM2G

RAID Config

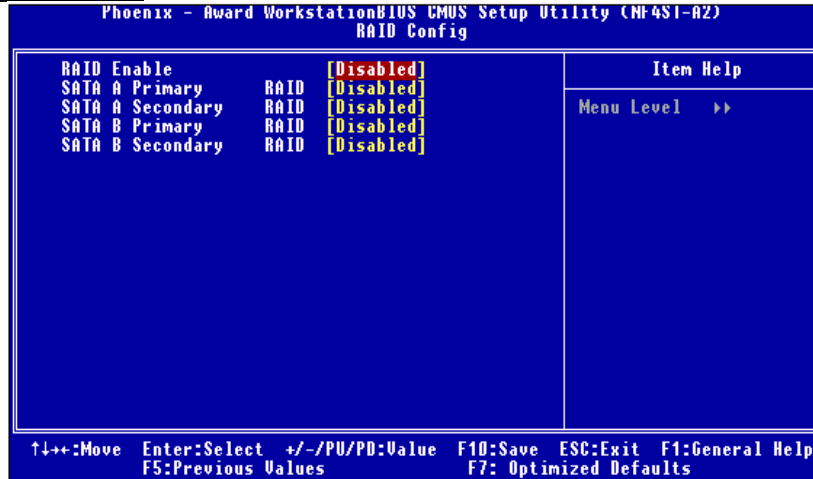

RAID Enable

This option allows you to enable or disable RAID function.

The Choices: Disabled (default), Enabled.

SATA A/B Primary/Secondary RAID

This option allows you to enable or disable SATA A Primary/Secondary RAID.

The Choices: Disabled (default), Enabled.

NF4 AM2G / NF4 AM2L / NF4U AM2G

Onboard Device

Highlight the “Press Enter” label next to the “Onboard Device” label and press the enter key will take you a submenu with the following options:

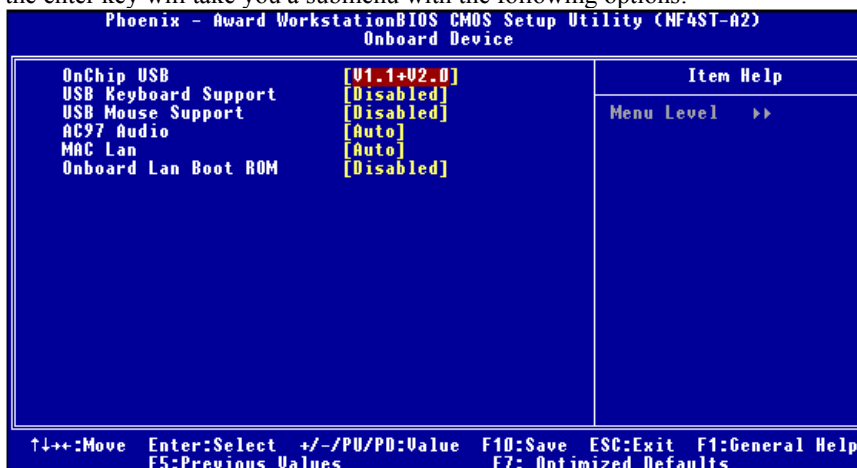

OnChip USB

This option should be enabled if your system has a USB installed on the system board. You may need to disable this feature if you add a higher performance controller.

The Choices: V1.1+V2.0 (default), Disabled, V1.1

USB Keyboard Support

This item allows you to enable or disable the USB Keyboard Legacy Support.

Enabled Enable USB Keyboard Support.

Disabled (default) Disable USB Keyboard Support.

USB Mouse Support

This item allows you to enable or disable the USB Mouse Legacy Support.

Enabled Enable USB Mouse Support.

Disabled (default) Disable USB Mouse Support.

AC97 Audio

This item allows you to enable or disable to support AC97 Audio.

The Choices: Auto (default), Disabled.

MAC LAN

This option allows you to control the onboard MAC LAN.

NF4 AM2G / NF4 AM2L / NF4U AM2G

The Choices: Auto (default), Disabled.

Onboard LAN Boot ROM

This item allows you to enable or disable the Onboard LAN Boot ROM.

The Choices: Disabled (default), Enabled.

Onboard IO/Address

Press Enter to configure the Onboard IO/Address.

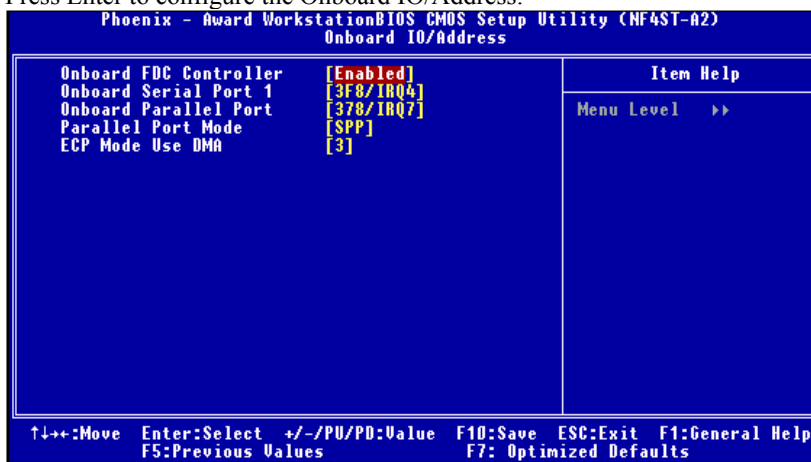

Onboard FDC Controller

Select enabled if your system has a floppy disk controller (FDC) installed on the system board and you wish to use it. If you installed another FDC or the system uses no floppy drive, select disabled in this field.

The Choices: Enabled (default), Disabled.

Onboard Serial Port 1

Select an address and corresponding interrupt for the first and second serial ports.

The Choices: 3F8/IRQ4 (default), Disabled, 2F8/IRQ3, 3E8/IRQ4, 2E8/IRQ3, Auto.

Onboard Parallel Port

This item allows you to determine access onboard parallel port controller with which I/O Address.

The Choices: 378/IRQ7 (default), 278/IRQ5, 3BC/IRQ7, Disabled.

Parallel Port Mode

This item allows you to determine how the parallel port should function. The

NF4 AM2G / NF4 AM2L / NF4U AM2G

default value is SPP.

The Choices:

SPP (default)	Using Parallel port as Standard Printer Port.
EPP	Using Parallel Port as Enhanced Parallel Port.
ECP	Using Parallel port as Extended Capabilities Port.
ECP+EPP	Using Parallel port as ECP & EPP mode.

ECP Mode Use DMA

Select a DMA Channel for the port.

The Choices: 3 (default), 1.

IDE HDD Block Mode

Block mode is also called block transfer, multiple commands, or multiple sectors read / write. If your IDE hard drive supports block mode (most new drives do), select Enabled for automatic detection of the optimal number of block mode (most new drives do), select Enabled for automatic detection of the optimal number of block read / write per sector where the drive can support.

The Choices: Enabled (default), Disabled.

NF4 AM2G / NF4 AM2L / NF4U AM2G

6 Power Management Setup

The Power Management Setup Menu allows you to configure your system to utilize energy conservation and power up/power down features.

■ Figure 6. Power Management Setup

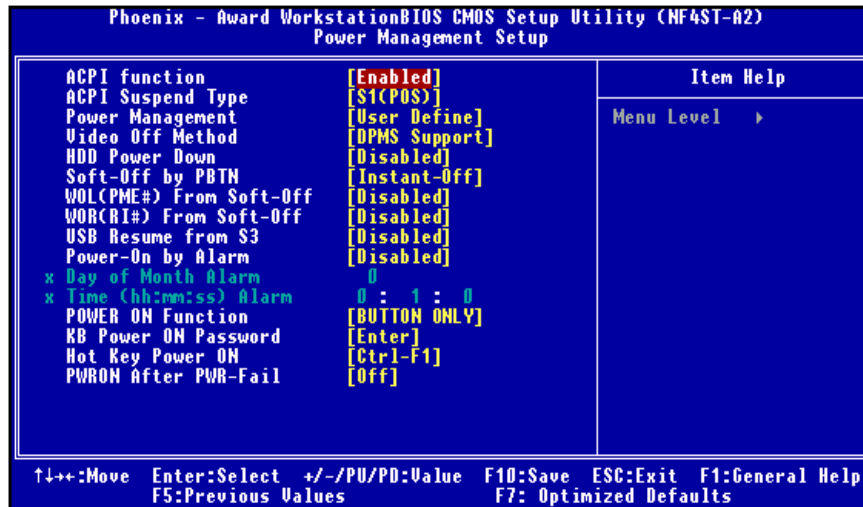

ACPI Function

This item displays the status of the Advanced Configuration and Power Management (ACPI).

The Choices: Enabled (default), Disabled.

ACPI Suspend Type

The item allows you to select the suspend type under the ACPI operating system.

The Choices: S1 (POS) (default) Power on Suspend

S3 (STR) Suspend to RAM

S1 & S3 POS+STR

NF4 AM2G / NF4 AM2L / NF4U AM2G

Power Management

This category allows you to select the power saving method and is directly related to the following modes:

1. HDD Power Down.
2. Suspend Mode.

There are three options of Power Management, three of which have fixed mode settings

Min. Power Saving

Minimum power management.

Suspend Mode = 1 hr.

HDD Power Down = 15 min

Max. Power Saving

Maximum power management only available for sl CPU's.

Suspend Mode = 1 min.

HDD Power Down = 1 min.

User Define (default)

Allow you to set each option individually.

When you choose user define, you can adjust each of the item from 1 min. to 1 hr. except for HDD Power Down which ranges from 1 min. to 15 min.

Video Off Method

This option determines the manner when the monitor goes blank.

V/H SYNC+Blank

This selection will cause the system to turn off the vertical and horizontal synchronization ports and write blanks to the video buffer.

Blank Screen

This option only writes blanks to the video buffer.

DPMS Support (default)

Initial display power management signaling.

NF4 AM2G / NF4 AM2L / NF4U AM2G

HDD Power Down

When enabled, the hard-disk drives will power down after a set time of system inactivity. All other devices remain active.

The Choices: Disabled (default), 1 Min, 2 Min, 3 Min, 4 Min, 5 Min, 6 Min, 7 Min, 8 Min, 9 Min, 10 Min, 11 Min, 12 Min, 13 Min, 14 Min, 15Min.

Soft-Off by PWR-BTN

This item determines the behavior of system power button. Instant off turn off the power immediately, and Delay 4 Sec. will require you to press and hold the power button for 4 seconds to cut off the system power.

The Choices: Delay 4 Sec, Instant-Off (default).

WOL(PME#)/ From Soft-Off

This item allows you to enable or disable Wake On LAN from Soft-Off function.

The Choices: Disabled (default), Enabled.

WOR(RI#) From Soft-Off

This item allows you to enable or disable Wake On Ring from Soft-Off function.
The Choices: Disabled (default), Enabled.

USB Resume from S3

This item allows you to wake up from S3 with USB device.

The Choices: Disabled (default), Enabled.

Power-On by Alarm

This function is for setting date and time for your computer to boot up. When enabled, you can choose the date and time to boot up the system.

The Choices: Disabled (default), Enabled.

Date (of Month) Alarm

You can choose which month the system will boot up.

Time (hh:mm:ss) Alarm

You can choose the system boot up time, input hour, minute and second to specify.

Note: If you have change the setting, you must let the system boot up until it goes to the operating system, before this function will work.

POWER ON Function

This item allows you to choose the power on method.

The Choices: Button Only (default), Password, Hot Key, Mouse/Click, Mouse Double/Click, Any Key, Keyboard 98.

NF4 AM2G / NF4 AM2L / NF4U AM2G

KB Power ON Password

Input password and press Enter to set the Keyboard power on password.

Hot Key Power ON

Choose the Hot Key combination to boot up the system.

The Choices: Ctrl-F1 (default), Ctrl-F2, Ctrl-F3, Ctrl-F4, Ctrl-F5, Ctrl-F6, Ctrl-F7, Ctrl-F8, Ctrl-F9, Ctrl-F10, Ctrl-F11, and Ctrl-F12.

POWER After PWR-Fail

This setting specifies how your system should behave after a power fail or interrupts occurs. By choosing off will leave the computer in the power off state. Choosing On will reboot the computer. Former-Sts will restore the system to the status before power failure or interrupt occurs.

The Choices: Off (default), On, Former-Sts.

NF4 AM2G / NF4 AM2L / NF4U AM2G

7 PnP/PCI Configurations

This section describes configuring the PCI bus system. PCI, or Personal Computer Interconnect, is a system which allows I/O devices to operate at speeds nearing the speed of the CPU itself uses when communicating with its own special components. This section covers some very technical items and it is strongly recommended that only experienced users should make any changes to the default settings.

■ Figure 7: PnP/PCI Configurations

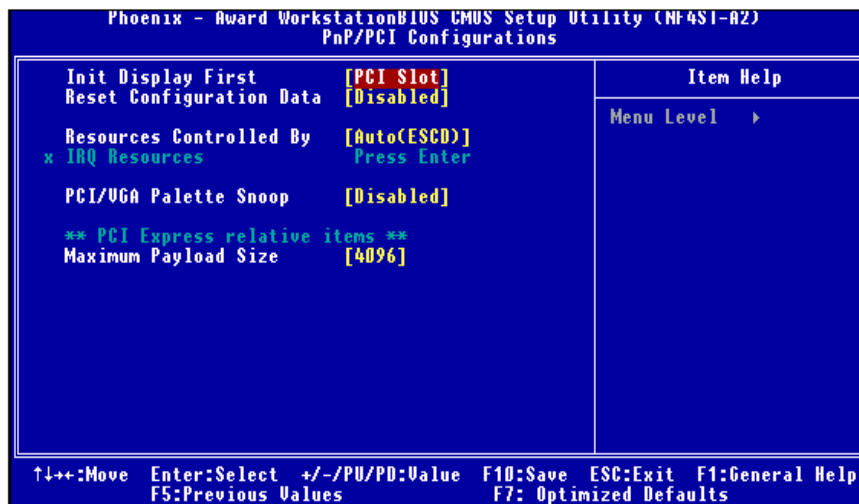

Init Display First

This item allows you to decide to active whether PCI Slot or on-chip VGA first.
The Choices: PCEx, **PCI Slot** (default).

NF4 AM2G / NF4 AM2L / NF4U AM2G

Reset Configuration Data

The system BIOS supports the PnP feature which requires the system to record which resources are assigned and protects resources from conflict.

Every peripheral device has a node, which is called ESCD. This node records which resources are assigned to it. The system needs to record and update ESCD to the memory locations. These locations are reserved in the system BIOS. If the Disabled (default) option is chosen, the system's ESCD will update only when the new configuration varies from the last one. If the Enabled option is chosen, the system is forced to update ESCDs and then is automatically set to the "Disabled" mode.

The above settings will be shown on the screen only if "Manual" is chosen for the resources controlled by function.

Legacy is the term, which signifies that a resource is assigned to the ISA Bus and provides non-PnP ISA add-on cards. PCI / ISA PnP signify that a resource is assigned to the PCI Bus or provides for ISA PnP add-on cards and peripherals.

The Choices: Disabled (default), Enabled.

Resources Controlled By

By Choosing "Auto(ESCD)" (default), the system BIOS will detect the system resources and automatically assign the relative IRQ and DMA channel for each peripheral. By Choosing "Manual", the user will need to assign IRQ & DMA for add-on cards. Be sure that there are no IRQ/DMA and I/O port conflicts.

The Choices: Auto (ESCD) (default), Manual.

IRQ Resources

This submenu will allow you to assign each system interrupt a type, depending on the type of device using the interrupt. When you press the "Press Enter" tag, you will be directed to a submenu that will allow you to configure the system interrupts. This is only configurable when "Resources Controlled By" is set to "Manual".

IRQ-3	assigned to PCI Device
IRQ-4	assigned to PCI Device
IRQ-5	assigned to PCI Device
IRQ-7	assigned to PCI Device
IRQ-9	assigned to PCI Device
IRQ-10	assigned to PCI Device
IRQ-11	assigned to PCI Device
IRQ-12	assigned to PCI Device
IRQ-14	assigned to PCI Device
IRQ-15	assigned to PCI Device

NF4 AM2G / NF4 AM2L / NF4U AM2G

PCI / VGA Palette Snoop

Some old graphic controllers need to “snoop” on the VGA palette and then map it to their display as a way to provide boot information and VGA compatibility. This item allows such snooping to take place.

The Choices: **Disabled** (default), Enabled

Maximum Payload Size

Set the maximum payload size for Transaction packets (TLP).

The Choice: **4096** (default.), 128, 256, 512, 1024, 2048.

NF4 AM2G / NF4 AM2L / NF4U AM2G

8 PC Health Status

■ Figure 8: PC Health Status

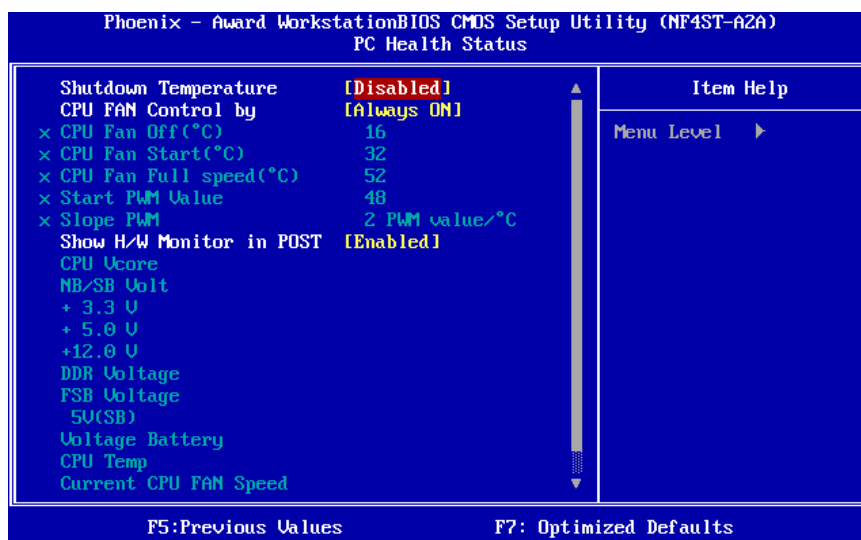

Shutdown Temperature

This item allows you to set up the CPU shutdown Temperature. This item is only effective under Windows 98 ACPI mode.

The Choices: Disabled (default) , 60°C/ 140°F, 65°C/ 149°F, 70°C/ 158°F.

CPU FAN Control by

Choose "smart" to reduce the noise caused by CPU FAN.

The Choices: Smart, Always On (default).

CPU Fan Off<°C>

If the CPU Temperature is lower than the set value, FAN will turn off.

The Choices: 16 (default).

Min= 0, Max= 127, you can key in a DEC number.

NF4 AM2G / NF4 AM2L / NF4U AM2G

CPU Fan Start<°C>

CPU fan starts to work under smart fan function when arrive this set value.

The Choices: 32 (default).

Min= 0, Max= 127, you can key in a DEC number.

CPU Fan Full speed <°C>

When CPU temperature is reach the set value, the CPU fan will work under Full Speed.

The Choices: 52 (default).

Min= 0, Max= 127, you can key in a DEC number.

Start PWM Value

When CPU temperature arrives to the set value, the CPU fan will work under Smart Fan Function mode. The range is from 0~127, with an interval of 1.

The Choices: 48 (default).

Min= 0, Max= 127, you can key in a DEC number.

Slope PWM

Increasing the value of slope PWM will raise the speed of CPU fan.

The Choices: 0 PWM Value/°C, 1 PWM Value/°C, 2 PWM Value/°C (default),

4 PWM Value/°C, 8 PWM Value/°C, 16 PWM Value/°C, 32 PWM Value/°C,

64PWM Value/°C.

Show H/W Monitor in POST

If you computer contains a monitoring system, it will show PC health status during POST stage. The item offers several different delay times.

The Choices: Enabled (default), Disabled.

CPU Vcore, NB/SB Volt, +3.3V, +5.0V, +12.0V, DDR Voltage, FSB Voltage, 5V(SB), Voltage Battery

Detect the system's voltage status automatically.

CPU Temp

This field displays the current temperature of CPU.

Current CPU FAN Speed

This field displays the current speed of CPU fan.

Current SYS FAN Speed

This field displays the current speed SYSTEM fan.

NF4 AM2G / NF4 AM2L / NF4U AM2G

9 Frequency/ Voltage Control

■ Figure 9: Frequency/ Voltage Control

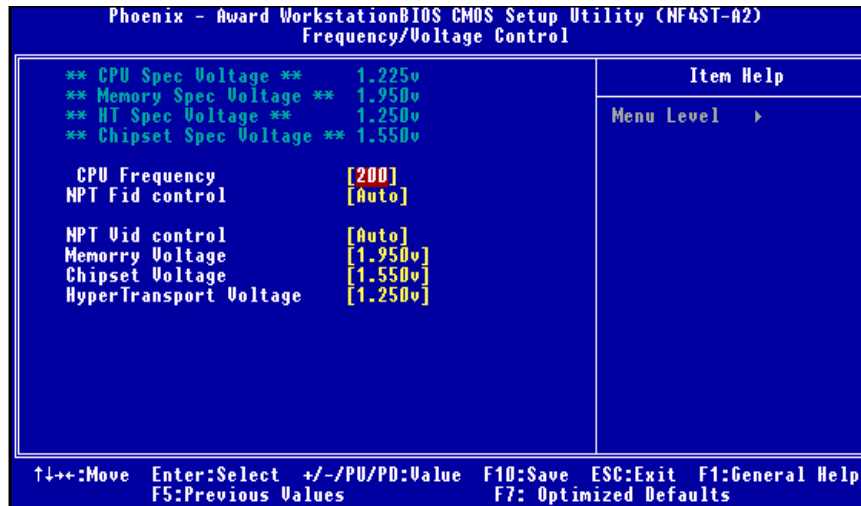

CPU Frequency

This item allows you to select the CPU Frequency.

The Choices: 200 (default).

Min= 200

Max= 300

Key in a DEC number.

NPT Fid Control

This item allows you to select NPT Fid Control.

The Choices: Auto (Default).

NPT Vid Control

This item allows you to select NPT Vid Control.

The Choices: Auto (Default).

NF4 AM2G / NF4 AM2L / NF4U AM2G

Memory Voltage

This item allows you to select DDR Voltage Regulator.

The Choices: 1.950V (Default), 2.000V, 2.050V, 2.100V.

Chipset Voltage

This item allows you to select DDR Voltage Regulator.

The Choices: 1.550V (Default), 1.600V, 1.650V, 1.700V.

HyperTransport Voltage

This item allows you to select DDR Voltage Regulator.

The Choices: 1.250V (Default), 1.300V, 1.350V, 1.500V.