

NF2S-ALH / NF2S-AED Mainboard Manual

Socket A DDR400 AGP8X
ATX Mainboard

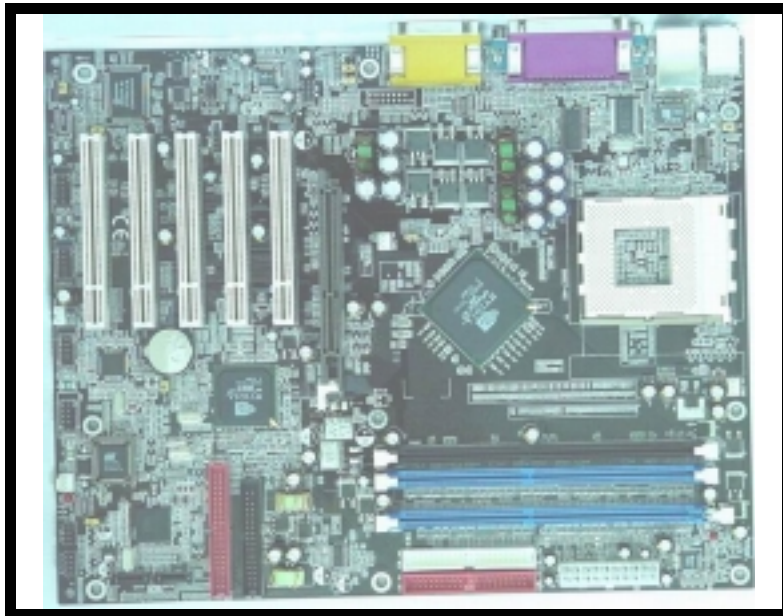

Version 1.x
UM-NF2S-ALH/AED-E1
Rev 1.0V
Creation Date: 16 May 2003

User's Notice

Copyright

This publication contains information that is protected by copyright. No part of it may be reproduced in any form or by any means or used to make any transformation adaptation without prior written permission from the copyright holders. This publication is provided for informational purposes only. The manufacturer makes no representations or warranties with respect to the contents or use of this manual and specifically disclaims any express or implied warranties of merchantability or fitness for any particular purpose. The user will assume the entire risk of the use or the results of the use of this document. The manufacturer reserves the right to revise this publication and make changes to its contents at any time, without prior notice. 2003. All Rights Reserved.

Trademarks

Microsoft®, MS-DOS®, Windows™, Windows® 95 and Windows® 98 are registered trademarks of Microsoft Corporation. Award is the registered trademark of Award Phoenix Software, Inc. AMD Duron™ and AMD Athlon™, Athlon™ XP are registered trademarks of AMD Corporation. Other trademarks and registered trademarks of products appearing in this publication are the properties of their respective holders.

Package Checklist

This package contains the following items:

NF2S-AED	NF2S-ALH
Mainboard	Mainboard
User's manual	User's manual
User's manual	User's manual
One 34-pin floppy disk drive cable	One 34-pin floppy disk drive cable
One 2-port USB cable	One 2-port USB cable
One 4 CH out cable	One 4 CH out cable
One Driver Utility CD	One Driver Utility CD
One 2-port IEEE 1394 cable	
Two Serial ATA cables	
One floppy diskette for Raid Utility	

If any of these items are damaged or missing, please contact your dealer or sales representative for assistance.

Technical Support

If you require additional information or assistance during installation please contact your dealer. Your dealer will be able to provide the latest information.

Table Of Contents

Chapter 1:- Introduction *Page 5*

1.1. Mainboard and PC 99 ATX External Connector Layout	5
1.2. Overview	6
1.2.1. The NF2S-ALH/NF2S-AED Mainboard	6
1.2.2. Mainboard Dimensions.....	6
1.2.3. Environmental Limitations.....	6
1.3. Features and Specifications	6
1.4. System Health Monitor Functions	9
1.5. System Intelligence	9

Chapter 2:- Hardware Installation *Page 10*

2.1. Installation Checklist	10
2.2. Installation Steps	11
2.3. Expansion Slots, Jumpers and Internal Connectors	12
2.4. CPU, Memory and Expansion Slots	14
2.4.1. Installation of the CPU.....	14
2.4.2. Memory Modules.....	14
2.4.3. PCI Slots.....	15
2.4.4. AGP (Accelerated Graphics Port) Slot.....	15
2.5. Internal Connectors	16
2.5.1. Floppy Disk Drive Connector	16
2.5.2. IDE Connectors.....	16
2.5.3. CPU Fan Connectors.....	16
2.5.4. ATX Power Supply Connector.....	17
2.5.5. WOL (Wake-On-LAN) Connector	17
2.5.6. CD-IN/AUX-IN Connector.....	18
2.5.7. S/PDIF Connector (only for NF2S-AED).....	18
2.5.8. USB3, USB4, USB5, USB6 Connectors.....	19
2.5.9. Front Audio Connector.....	19
2.5.10. 4-Channel OUT Connector.....	20
2.5.11. Serial ATA Connectors (only for NF2S-AED).....	21
2.5.12. IEEE 1394 Connectors (only for NF2S-AED)	21
2.6. System Panel Buttons and LED Connectors	22
2.6.1. PW: Power On / Off and External Suspend Switch Connector.....	22
2.6.2. SL: Standby LED Connector	22
2.6.3. HL: IDE HDD LED Connector.....	22
2.6.4. RS: Reset Button Connector.....	22

Table Of Contents

2.7. Speaker and Power LED Connectors	23
2.7.1. Speaker Connector (SPKR).....	23
2.7.2. Front Panel Power LED (PWR-LED).....	23
2.8. External Connectors	23
2.8.1. PS/2 Keyboard Connector	23
2.8.2. PS/2 Mouse Connector.....	23
2.8.3. Serial Port Connectors	23
2.8.4. Parallel Port Connector	24
2.8.5. Universal Serial Bus (USB) Ports.....	24
2.8.6. Game/Audio Connector.....	24
2.8.7. RJ-45 (LAN Port) Connector	24
2.9. Jumper Settings	25
2.9.1. JP1: KB/MS Power On.....	25
2.9.2. JP3: CPU FSB Mode Selection.....	25
2.9.3. JP5: Clear CMOS	25
2.9.4. JP6: Clears Password.....	26
2.9.5. JP7: SATA1 and SATA2 mode Selection (only for NF2S-AED)	26
2.9.4. JP9: CPU Temperature Setting	26

Chapter 3:- Managing The PC BIOS *Page 27*

3.1. Award BIOS CMOS Setup Utility	27
3.2. Main Menu	27
3.3. Standard CMOS Setup	28
3.4. Advanced BIOS Features	30
3.5. Advanced Chipset Features	33
3.6. Integrated Peripherals	35
3.7. Power Management Setup	38
3.8. PNP/PCI Configuration	40
3.9. PC Health Status	41
3.10. Load Fail-Safe Defaults	42
3.11. Load Optimized Defaults	42
3.11.1. Load Optimized Defaults	43
3.12. Set Supervisor Password and User Password	43
3.12.1. Set Supervisor Password.....	43
3.12.2. Set User Password.....	44
3.13. Save & Exit Setup/Exit Without Saving	45
3.13.1. Save & Exit Setup.....	45
3.13.2. Exit Without Saving	45

Introduction

Chapter 1 - Introduction

1.1. Mainboard and PC 99 ATX External Connector Layout

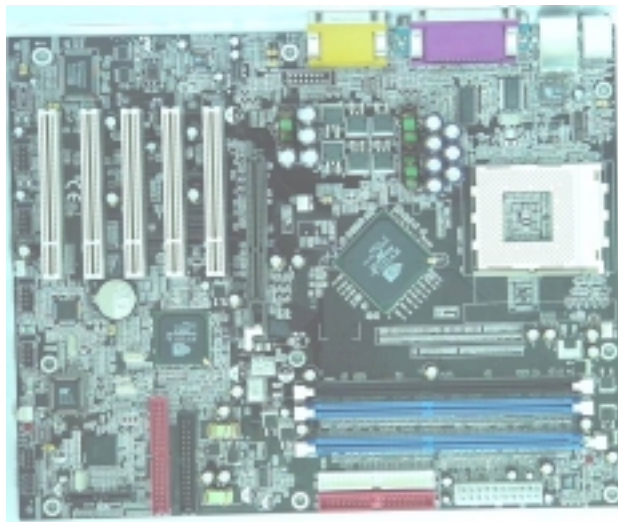

For the detailed information of jumpers and connectors of the mainboard, please see page 12 and 13.

PC 99 ATX External Connector

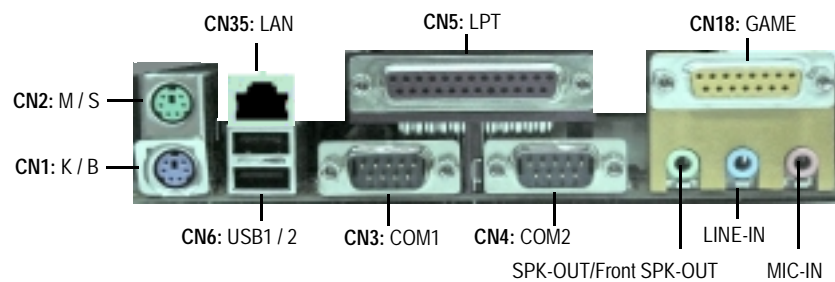

Introduction

1.2. Overview

1.2.1. The NF2S-ALH/NF2S-AED Mainboard

The mainboard is a **Socket A** DDR platform for AMD Athlon XP, Athlon and Duron processors. It supports AGP 8X, and provides three dual-channel DDR DIMM sockets (support DDR266/333/400), able to support up to 3GB memory. The supported FSB clock is 200/266/333/400 MHz. Onboard the NF2S-ALH has two IDE interfaces and NF2S-AED has three IDE interfaces, which support ATA 33/66/100/133. The NF2S-AED has two IEEE 1394 ports, and two serial ATA interfaces which support ATA 150 and RAID. Additionally, both mainboards have onboard Audio, onboard LAN and WOL connector.

1.2.2. Mainboard Dimensions

Width	305 mm
Length	244 mm

1.2.3. Environmental Limitations

Operating Temperature:	10°C to 40°C (50°F to 104°F)
Required Airflow:	50 linear feet per minute across the CPU
Storage Temperature:	-40°C to 70°C (-40°F to 158°F)
Humidity:	0 to 90% non-condensing
Altitude:	0 to 10 000 feet

1.3. Features and Specifications

Processor

The mainboard supports **Socket A** CPUs such as AMD Athlon XP, Athlon and Duron processors.

Chipsets

Northbridge:	NVIDIA nForce2 SPP
Southbridge:	NVIDIA nForce2 MCP (for NF2S-ALH) NVIDIA nForce2 MCP-T (for NF2S-AED)
I/O Chipset:	Winbond W83627HF

CPU Switching Voltage Regulator

The mainboard is equipped with a switching voltage regulator that automatically detects a DC power supply from +1.10V to +1.85V.

System Memory

The mainboard has **three** 184-pin Dual-channel DDR DIMM sockets which support 2.5V (power level) single-sided or double sided PC2100 (DDR266), PC2700 (DDR333) or PC3200 (DDR400) DDR DIMM modules. If you want to realize Dual-channel DDR, please use DIMMA1+ DIMMB1 or DIMMA1 + DIMMB2.

Introduction

Expansion Slots

The mainboard is equipped with **five** dedicated PCI slots and **one** 1.5V 8X/4X AGP slot.

Onboard Audio Feature

The mainboard supports Microsoft DirectSound/DirectSound 3D, and AC'97 6 channel (for NF2S-ALH) or Dolby 5.1 channel (for NF2S-AED). The AC'97 Co-dec is ALC650.

Onboard LAN Feature

The mainboard comes with 10/100M Onboard LAN.

Serial ATA Connectors (only for NF2S-AED)

The mainboard comes with 2 Serial ATA interface ports support ATA 150 and RAID 0, RAID 1, and RAID 0+1. It can connect up to 2 Serial ATA devices.

Word Size

Data Path:	8-bit, 16-bit, 32-bit, 64-bit, 128-bit
Address Path:	32-bit

Front Side Bus Frequency (FSB)

The Front Side Bus Frequency (FSB) clock is 200/266/333/400 MHz.

BIOS

- Award BIOS, Windows 95/98 Plug and Play (PnP) compatible
- Supports SCSI sequential boot-up
- Supports Serial ATA and RAID (for NF2S-AED only)
- 2 Mb flash ROM for easy BIOS upgrades
- Supports DMI2.0 function

Desktop Management Interface (DMI)

The mainboard comes with DMI2.0 built into the BIOS. The DMI utility in the BIOS will automatically record different information about your system configuration and store this information in the DMI pool, which is a part of the system board's Plug and Play BIOS. DMI, along with the appropriately networked software, is designed for easy inventory, maintenance and the simplified troubleshooting of computer systems.

WOL (Wake-On-LAN) Connector

The mainboard supports Wake-On-LAN functionality.

Introduction

USB2.0 Ports

USB allows data exchange between your computer and a wide range of simultaneously accessible external Plug and Play peripherals. The mainboard is equipped with **six** USB (version 2.0) connectors. USB1 and USB2 are external connectors. They can be found on the PC 99 ATX connector. The other USB connectors are internal connectors and can be used to connect other USB devices. (Cables for the internal USB 2.0 connectors are sold separately). The PIN assignment of the internal USB 2.0 connectors are follow the specifications of Intel Standard.

Connectors

- Two IDE connectors support ATA 33/66/100/133 (for NF2S-ALH)
- Three IDE connectors support ATA 33/66/100/133 (for NF2S-AED)
- Two Serial ATA connectors support ATA 150 and RAID (for NF2S-AED)
- One Floppy Drive connector supports up to two 2.88 MB floppy drives
- One power supply connector (Note: the power supply must be **300W**)
- Three fan connectors
- One CD-IN connector, one AUX-IN connector
- One WOL (Wake-On-LAN) connector
- One front audio connector
- One 4-Channel out connector
- Four internal USB2.0 port connectors (Intel type)
- One S/PDIF connector (for NF2S-AED)
- Two IEEE 1394 connectors (for NF2S-AED)

ATX Double Deck Ports (PC 99 color-coded connectors)

- Two USB2.0 ports
- Two external DB-9 serial port connectors: COM1, COM2 (UART)
- One SPP/ECP/EPP DB-25 parallel port
- One mini-DIN-6 PS/2 mouse port
- One mini-DIN-6 PS/2 keyboard port
- One Audio/GAME port
- One LAN port (RJ-45) connector
- Three audio jacks: SPK-OUT, LINE-IN and MIC-IN

PCI Bus Master IDE Controller

- PCI IDE1 and IDE2 interfaces support up to four IDE devices.
- This mainboard supports ATA 33/66/100/133 hard drives.
- PIO Mode 3, Mode 4 Enhanced IDE (data transfer rate up to 16.6MB/sec.).
- Bus mastering reduces CPU utilization during disk transfer.
- Supports ATAPI CD-ROM, LS-120 and ZIP.
- The IDE3 provides PIO mode 0-5, bus master, and Ultra DMA 66/100/133 function

Introduction

1.4. System Health Monitor Functions

The mainboard is capable of monitoring the following health conditions of your system:

1. Processor temperature. It has an overheat alarm.
2. VCORE/3.3V/5V/12V/-12V voltages and failure alarm.
3. Processor and chassis fan speeds. It has a failure alarm for these fans.
4. Read back capability that displays temperature, voltage and fan speed.

Hardware Monitoring System Utility

The mainboard comes with the Hardware Monitoring System utility contained on the CD. It is capable of monitoring the system's hardware conditions such as the temperature of the processor, voltage, and the speed of both the CPU and chassis fans. You are allowed to manually set a range to the items being monitored. If the values are over or under the set range a warning message will automatically pop up. We recommend that you use the Default Settings, which are the ideal settings that will maintain the system in a good working condition. To install this utility, please insert the CD into the CD-ROM drive. The auto run screen (Driver Utility) will automatically appear. Click the Hardware Monitoring button, choose the chipset, model number and the OS that is installed. Please refer to the CD "Readme" file for further installation instructions.

Note: Only use this utility in Windows operating systems.

1.5. System Intelligence

Dual Function Power Button

Depending on the setting in the Soft-Off By Power-Button field of the Power Management Setup, this switch allows the system to enter the Soft-Off or Suspend mode.

RTC Timer to Power-on the System

The RTC installed on the system board allows your system to automatically power-on at a set date and time.

Wake-On-LAN Ready

The Wake-On-LAN function allows the network to remotely wake up a Soft Power Down (Soft-Off) PC. Your LAN card must support the remote wakeup function. The 5V SB power source of your power supply must be at least 720mA.

ACPI Ready

The mainboard is designed to meet the ACPI (Advanced Configuration and Power Interface) specification. ACPI has energy saving features that support OS Direct Power Management (OSPM) for round the clock PC operation.

CPU Temperature Protect

The main board is also designed to have the CPU Temperature Protect function, when temperature of CPU on the mainboard is overheated the system will automatically shutdown.

Hardware Installation

Chapter 2 - Hardware Installation

2.1. Installation Checklist

The following is a checklist of all the expansion slots, jumpers and connectors that should be configured on your mainboard before you can run your PC.

Installation Checklist		
Expansion Slots and Sockets		
CPU Socket	Socket A CPUs	
DIMM Slots	Three 184-pin Dual-channel DDR DIMM Slots	
PCI Slots	Five 32-bit PCI Slots	
AGP Slot	One 1.5V 4X/8X Accelerated Graphics Port Slot	
Internal Connectors		
CN8	Floppy Drive Connector	FDC
CN9	Primary IDE	IDE1
CN10	Secondary IDE	IDE2
CN13	CPU Fan	FAN1
CN15-A	ATX Power Supply	ATX
CN16	Wake-On-LAN Connector	WOL
CN17	Power Supply Fan	FAN2
CN21	CD Audio In	CD-IN
CN27	Chassis Fan	FAN3
CN28	Tertiary IDE	IDE3 (NF2S-AED only)
CN30	Universal Serial Bus 3/4	USB3/4
CN32	Universal Serial Bus 5/6	USB5/6
CN36	Sony Phillips Digital Interface	S/PDIF (NF2S-AED only)
CN39	Front Audio Connector	Front Audio
CN45	Auxiliary In Connector	AUX-IN
CN46	4-Channel Audio Out	4CH-OUT
CN49	Serial ATA Connector 1	SATA1 (NF2S-AED only)
CN50	Serial ATA Connector 2	SATA2 (NF2S-AED only)
CN53	IEEE 1394 Connector 1	1394A1 (NF2S-AED only)
CN54	IEEE 1394 Connector 2	1394A2 (NF2S-AED only)
External Connectors		
CN1	PS/2 Keyboard Connector	K/B
CN2	PS/2 Mouse Connector	M/S
CN3	Serial Port 1	COM1
CN4	Serial Port 2	COM2

Hardware Installation

Installation Checklist (Continued)

CN5	Parallel Port	LPT
CN6	Universal Serial Port 1/2	USB1/2
CN18	Audio/GAME Port	AUDIO/GAME
CN35	RJ-45 (LAN) Connector	LAN
Speaker and Power LED Connectors		
PW	Power On/Off and Suspend Switch Connector	
SL	Standby LED Connector	
HL	HDD LED Connector	
RS	Reset Button Connector	
Speaker and Power LED Connectors		
PWR-LED	Power LED	
SPKR	Speaker Connector	
Jumpers and Switches		
JP1	KB/MS Power ON	
JP3	CUP FSB Mode Selection	
JP5	Clear CMOS	
JP6	Clear Password	
JP7	Serial ATA1/2 Mode Selection	(for NF2S-AED only)
JP9	CUP Temperature Setting	

2.2. Installation Steps

You need to complete the following installation steps before you can use your PC.

- Check and set the mainboard settings;
- Install the Central Processing Unit (CPU);
- Install the memory modules;
- Install the expansion cards;
- Connect the ribbon cables, panel wires and power supply;
- Setup the system BIOS.

Note : Before you start installing your mainboard we strongly recommend that you use a grounded anti-static mat. We further recommend that you attach an anti-static wristband, which is grounded at the same location as the mat, to your wrist.

Hardware Installation

2.3. Expansion Slots, Jumpers and Internal Connectors

NF2S-ALH Layout

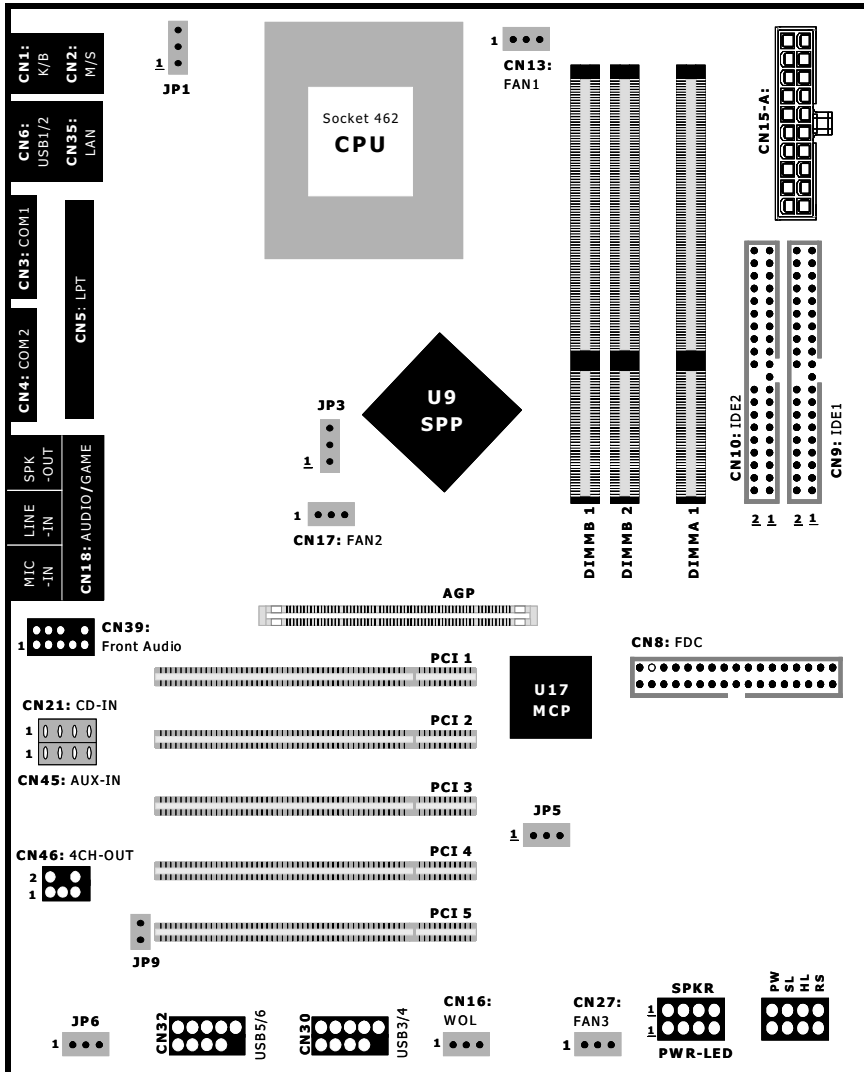

Hardware Installation

NF2S-AED Layout

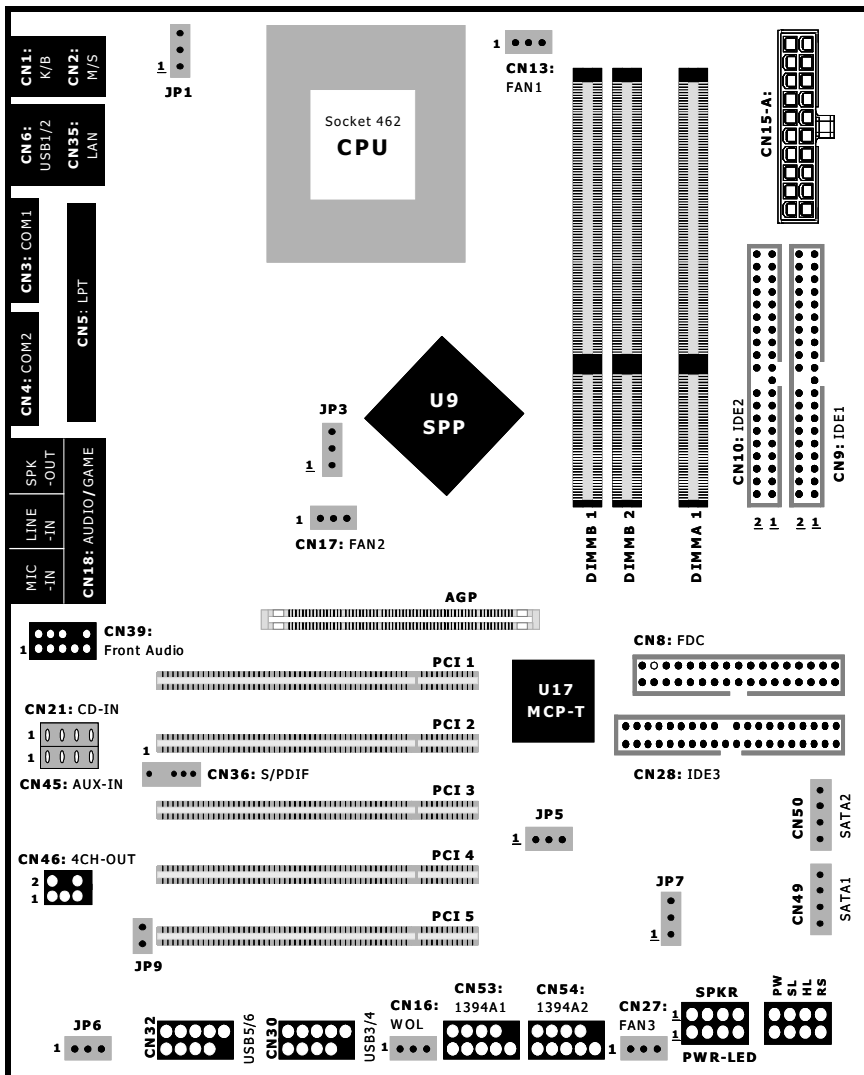

Hardware Installation

2.4. CPU, Memory and Expansion Slots

2.4.1. Installation of the CPU

To install your processor, please complete the following set of instructions:

1. Locate a small dot marked on the top of the CPU. This mark indicates Pin 1 of the CPU.
2. Locate Pin 1 for the Socket on the mainboard.
3. There is a lever on the side of the socket. First push this lever sideways and then lift it to a 90-degree angle.
4. Insert the CPU into the Socket. Please make sure that Pin 1 for the CPU is inserted into Pin 1 of the Socket.
5. When the CPU is installed correctly push the lever back into place.
6. **Install a proper heat sink with cooling fan** for proper heat dissipation. Failing to install a heat sink with cooling fan may cause overheating which will burnout your CPU and damage your mainboard.

IMPORTANT: CPU COOLING FAN

Please ensure that you have an approved heat sink with cooling fan. Without a proper heat sink with cooling fan you will damage both the mainboard and the CPU.

2.4.2. Memory Modules

The mainboard has **three** 184-pin Dual-channel DDR DIMM slots which are located on the right-hand side of the board. The maximum supported memory is 3 GB. To install the DIMM's into these slots, make sure the white lever at each side of the slot has been pulled down to an angle of approximately 45°. Make sure that the DIMM is in the correct orientation. Place the DIMM on the slot and push down firmly. The white levers will come back up and lock the module in place.

Note: If you use Dual-channel DDR and to have the dual channel function, you should select DIMMA1 + DIMMB2 DIMM slots.

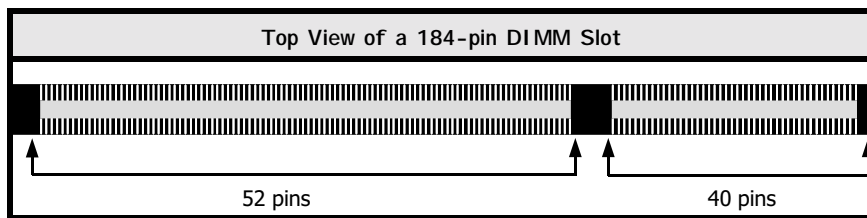

Important: The DIMM's can only be fitted into the slots in one orientation. Make sure that the DIMM's are in the correct orientation and the pins are correctly aligned before you insert them.

Hardware Installation

NOTE: "Out Of Memory" Error Message

If you have installed more than 512 MB of RAM and are running Microsoft Windows Millennium Edition, Windows 98 Second Edition, Windows 98 or Windows 95 you may experience memory problems. Two symptoms of these problems are being unable to run an MS-DOS session while you are running Windows or the computer may stop responding while Windows is starting.

There are three possible solutions to this problem:

- 1) Reduce the amount of memory Vcache uses to 512 MB or less by altering the MaxFileCache setting in the System.ini file.
- 2) Use the System Configuration Utility to reduce the amount of memory Windows uses to 512 MB or less.
- 3) Reduce the memory installed on your computer to 512 MB or less.

This problem can also occur if an Advanced Graphic Port (AGP) video adapter is used.

2.4.3. PCI Slots

The mainboard comes with **five** PCI slots. They are located on the left-hand side of the board. Both PCI and PCI expansion cards may require IRQ's. This mainboard complies with Plug and Play (PnP) specifications. Whenever a PnP compliant card is added the system will automatically be configured and the IRQ's will be assigned automatically.

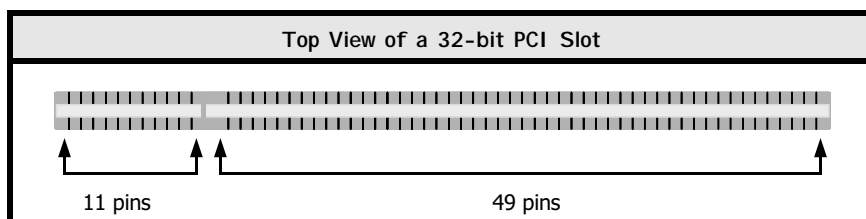

2.4.4. AGP (Accelerated Graphics Port) Slot

AGP is a dedicated bus slot. It operates at 66 MHz and transfers data at a rate up to 2133 MB/s. This allows 3D applications to run more smoothly. The mainboard comes with a **1.5V** AGP slot which is able to support 4x/8X AGP cards.

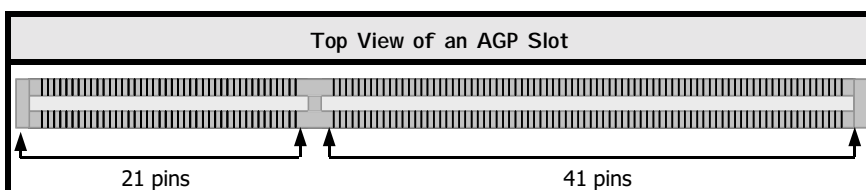

Hardware Installation

2.5. Internal Connectors

2.5.1. Floppy Disk Drive Connector

Connector: CN8 (FDC)
Type: 34 pin block

The FDC connector can support two floppy drives. It is located at right side of the mainboard. To connect, use the ribbon cable that has been provided. Make sure that the red strip is connected to Pin 1 of the connector.

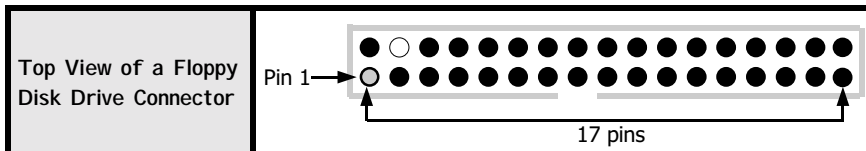

2.5.2. IDE Connectors

Connector: CN9 (IDE1)/CN10 (IDE2)/CN28(IDE3), CN28 only for NF2S-AED
Type: 40 pin block

Each IDE connector can support two IDE drives. If you install two hard drives, you need to configure the second drive to **Slave** mode in the BIOS setup. Please refer to your hard drive manual for the appropriate jumper settings.

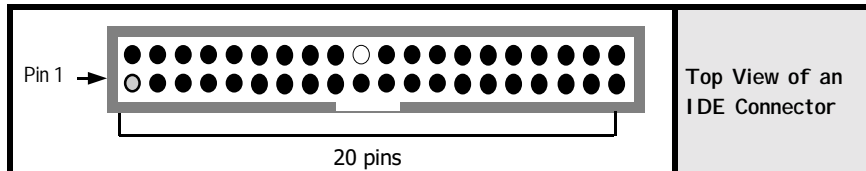

2.5.3. CPU Fan Connectors

Connector: CN13 (FAN1)/CN17 (FAN2)/CN27 (FAN3)
Type: 3 pin

The cooling fans must be connected to their respective power connectors. If you have installed the hardware-monitoring feature you will be able to monitor the rotating speed of the CPU cooling fan in your Windows operating system.

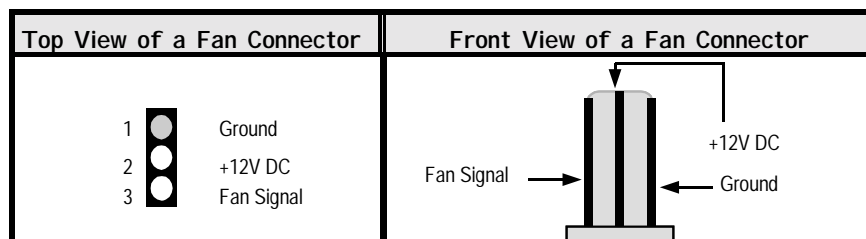

Hardware Installation

2.5.4. ATX Power Supply Connector

Connector: CN15-A

Type: 20 pin block

The mainboard comes with onboard power supply connector labeled CN15-A. CN15-A is a regular ATX power supply connector for the mainboard.

Note: The ATX power supply should be 300W so as to ensure that the mainboard work normally.

2.5.5. WOL (Wake-On-LAN) Connector

Connector: CN16 (WOL)

Type: 3 pin

The mainboard has a WOL (Wake-On-LAN) connector. This connector must be connected to a LAN card that has Wake-On-LAN (WOL) output. This connector powers up the system when a wakeup packet or signal is received through the LAN card.

ATX Power Supply Connector

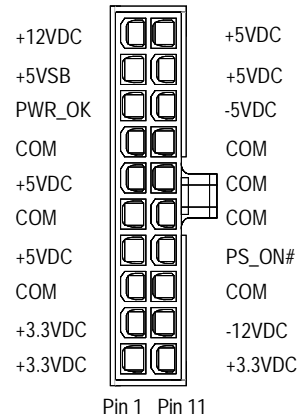

In order to use the WOL LAN card to trigger the power on the PC system, the switching power supply must have the ability to provide a driving current of at least 720 mA and be connected to a "5V standby" voltage.

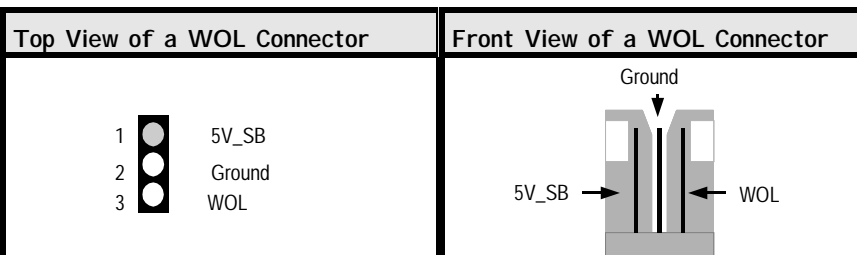

Hardware Installation

2.5.6. CD-IN/AUX-IN Connector

Connector: CN21 (CD-IN)/CN45 (AUX-IN)

Type: 4 pin un-housed

The mainboard has one CD-IN connector and one AUX-IN connector. The **CD-IN** connector is used to connect the CD ROM audio out and allows the system to receive audio input from the CD ROM. The **AUX-IN** connector allows the system to receive signals from other audio devices like a radio or tape.

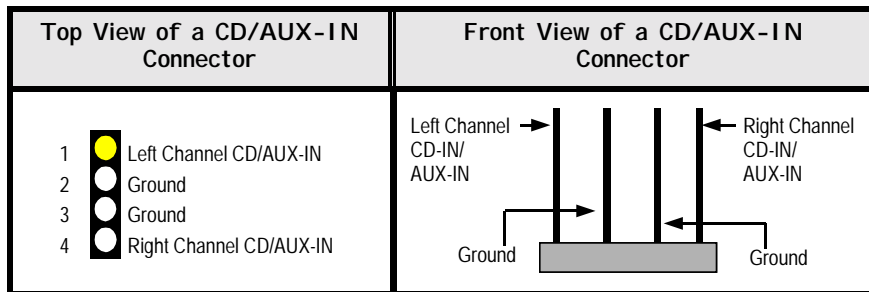

2.5.7. S/PDIF Connector (for NF2S-AED only)

Connector: CN36 (S/PDIF)

Type: 4 pin un-housed

The Sony Phillips Digital Interface, S/PDIF connector, is a digital interface that can be used to improve the quality of the sound output from your system. This connector supports Dolby 5.1 channel sound.

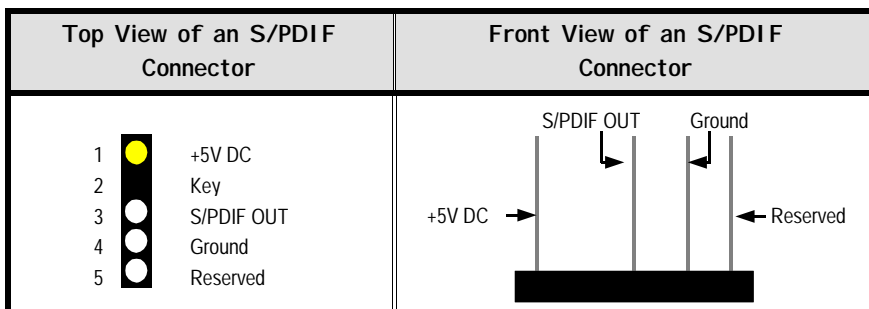

Hardware Installation

2.5.8. USB3, USB4, USB5, USB6 Connectors

Connector: CN30 (USB 3/4)/CN32 (USB 5/6)
Type: 5 pin

You already have two USB2.0 ports available, USB1 and 2 (see external connectors). The internal USB connectors allow you to add on an optional kit to expand the total number of USB ports available. The mainboard has four internal USB2.0 connectors (CN30/CN32). This enables you to use an extra four USB devices. Cable for these additional connectors needs to be purchased separately.

Note: The PIN assignment of the internal USB 2.0 connectors (CN30, CN32) are follow the specifications of Intel standard.

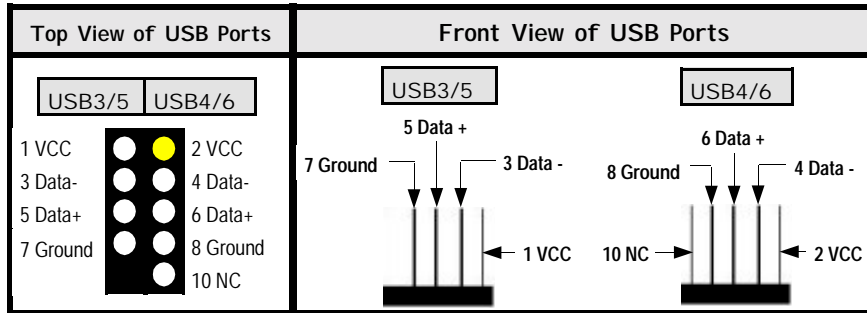

2.5.9. Front Audio Connector

Connector: CN39
Type: 10 pin

The front audio connector is an innovative development. This connector is designed to be used with a Front-Utility Panel. The utility panel was developed so that a user is able to bring the speaker out, microphone in connectors to the front of their PC. This makes things like plugging in speakers and earphones much less troublesome. If you didn't use Front Audio function, short Pin 5 and Pin 6, short Pin 9 and Pin 10.

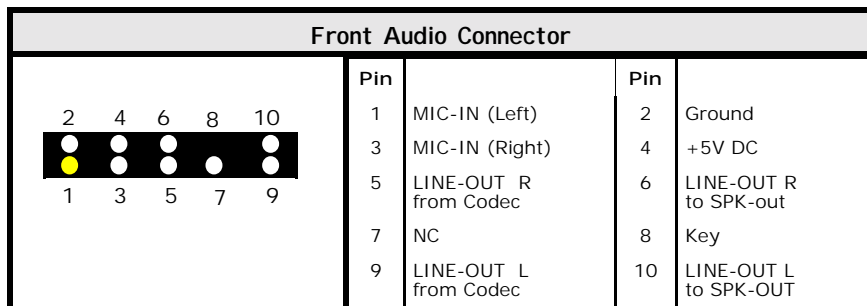





Hardware Installation

2.5.10. 4-Channel OUT Connector

Connector: CN46 (4 CH OUT)
Type: 6 pin

This mainboard has the capability of 6 channel sound surrounded function, specifically sound effect that is destined for DVD or DTS home entertainment playback. In order to fully get the sound surrounded effect, this connector has to be used together with the Audio portion of the PC 99 ATX external connector on the mainboard. Special audio cable for this connector is attached. Please refer the following drawings or schematics to have the right connection for your sound systems.

4 CH OUT Connector					
1		2	Pin		
3		4	1	Rear Left Channel	2
5		6	3	Ground	4
			5	Center	6
					Key
					LFE (WOOFER)

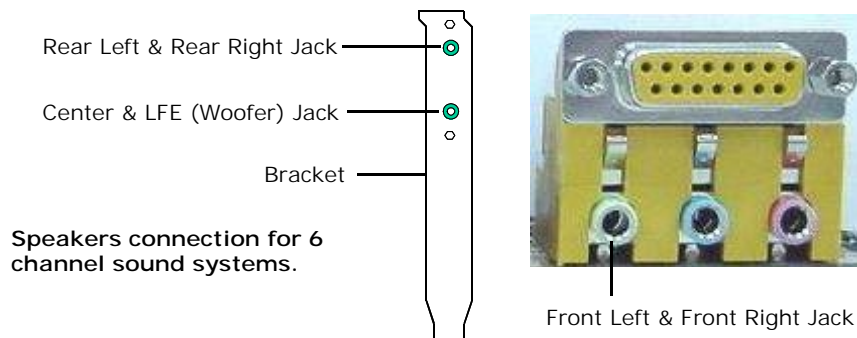
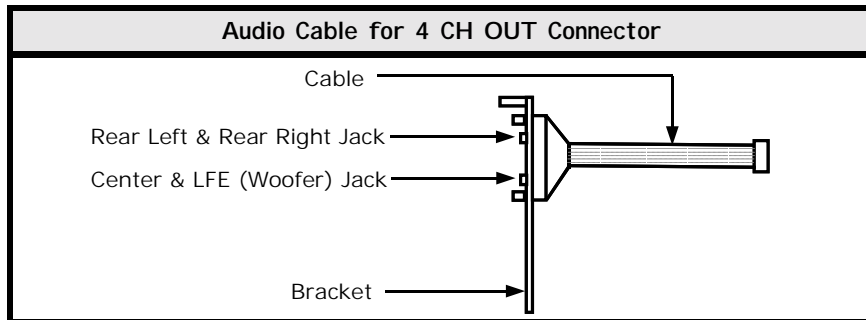

Hardware Installation

2.5.11. Serial ATA Connectors (for NF2S-AED only)

Connector: CN49 (SATA1)/CN50 (SATA2)

Type: 4 pin (SATA 1/2)

The high-speed Serial ATA interface ports support 1st generation serial ATA data rate of 150 MB/s. SATA1 and SATA2 are fully compliant with Serial ATA 1.0 specifications. Each supports RAID 0, RAID 1, RAID o+1 and can connect up to two SATA devices.

2.5.12. IEEE 1394 Connectors (for NF2S-AED only)

Connector: CN53 (1394A1)/CN54 (1394A2)

Type: 10 pin

The mainboard provides two 1394 pin headers for the use of IEEE 1394 devices.

Front IEEE 1394 Connector				
	Pin		Pin	
<div style="display: flex; justify-content: space-around; margin-bottom: 5px;"> 246810 </div>  <div style="display: flex; justify-content: space-around; margin-top: 5px;"> 13579 </div>	1	FW-TPB	2	FW-TPB#
	3	Ground	4	Ground
	5	FW-TPA	6	FW-TPA#
	7	+12V DC	8	+12V DC
	9	Ground	10	Key

Hardware Installation

2.6. System Panel Buttons and LED Connectors

The following System Panel Buttons and LED Connectors (3 x 2 pins) can be found at the bottom of the mainboard.

PW = Power On/Off and Suspend Switch Connector

SL = Standby LED Connector

HL = HDD LED Connector

RS = Reset Button Connector

RS: Reset Control

HL: +5V DC Pull Up

SL: +5VSB DC Pull UP

PW:+5V DC Pull Up

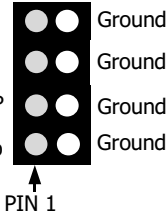

Top View of the System Panel and LED Connectors

2.6.1 PW: Power On/Off and External Suspend Switch Connector

The Power On/Off connector has two functions. It can be the Power Switch or Suspend Switch of your PC system. You can either choose "**Delay 4 Sec**" or "**Instant OFF**".

Option 1: If you choose "**Delay 4 Sec.**" In the BIOS CMOS Setup, the function of "PW" will be:

- A. When the system power is "OFF", press this switch, the system will power on.
- B. When system power is "ON", you can select two different modes: -

Mode 1: Press and hold the Power ON button for less than 4 seconds and then release it. The system will be turned into Suspend mode (turned into the GREEN mode) When the system is in the Suspend mode:

- Press the Power on button (less than 4 seconds), the system will return to Full-ON mode.
- Press and hold the Power On Button for more than 4 seconds, the system will be powered off.

Mode 2: Press and hold the Power ON button for more than 4 seconds, the system will be completely powered off.

Option 2: If you choose "**Instant OFF.**" In the BIOS CMOS Setup, the power switch will operate like a normal ON / OFF Power button.

2.6.2. SL: Standby LED Connector

When lighted, the LED indicates that the AC power is ON but your system is switched OFF. When unlighted, it indicates that either the AC power is OFF or unconnected.

2.6.3. HL: IDE HDD LED Connector

Any read and write activity by the HDD will turn this LED on.

2.6.4. RS: Reset Button Connector

If you connect this connector, you will be able to reset you computer by pressing the reset button at the front of the chassis.

Hardware Installation

2.7. Speaker and Power LED Connectors

2.7.1. Speaker Connector (SPKR)

Connect your chassis speaker to this four-pin connector. It allows you to hear systems beeps and warnings sound.

PIN 1
PIN 1

2.7.2. Front Panel Power LED (PWR-LED)

The chassis power LED connector can be connected to the four-pin connector. When you turn your system on, this LED will also be turned on.

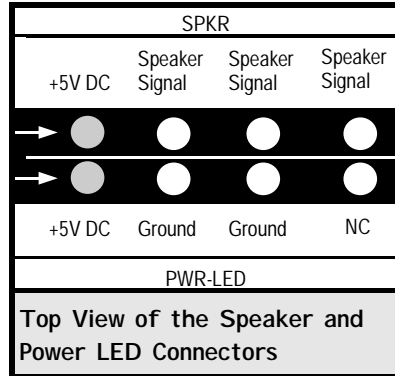

2.8. External Connectors

2.8.1. PS/2 Keyboard Connector

Connector: CN1 (K/B)
Type: 6 pin female



This connector only supports a PS/2 keyboard plug. If you have a standard AT size (large DIN) keyboard plug, you need to use a mini DIN adapter.

2.8.2. PS/2 Mouse Connector

Connector: CN2 (M/S)
Type: 6 pin female



This connector only supports a PS/2 mouse plug. If a PS/2 mouse is detected then IRQ 12 will be directed to CN2.

2.8.3. Serial Port Connectors

Connector: CN3 (COM1)/CN4 (COM2)
Type: 9 pin male

One serial port is available for a mouse and other serial devices. (I/O addresses used are 3F8H/2F8H/3E8H/2E8H and IRQ3/IRQ4, selected by CMOS setup.)

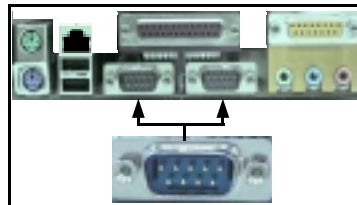

Hardware Installation

2.8.4. Parallel Port Connector

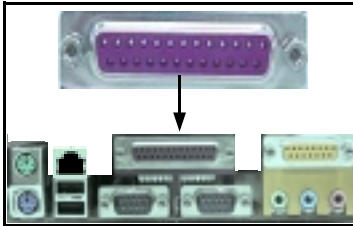

Connector: CN5 (LPT)
Type: 25 pin female.

This parallel port is used by printers which support the SPP, EPP and ECP modes IRQ7 or IRQ5 can be selected. The ECP mode will use either DMA 3 or DMA 1 (which can be selected by the BIOS setup program).

2.8.5. Universal Serial Bus (USB) Ports

Connector: CN6 (USB 1/2)
Type: 4 pin female

Two USB ports are available for connecting USB devices. The mainboard is also equipped with an expansion connector that supports two additional USB external connectors. (The USB cable is not included in the package).

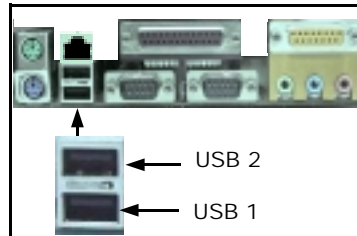

2.8.6. Audio/Game Connector

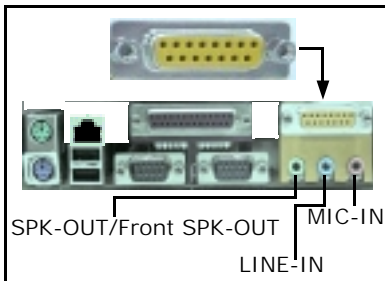

Connector: CN18
Type: 15 pin female

The Audio/Game port connector is a dual purpose connector. It can either be used to connect a joystick to the computer for game participation, or it can be used to attach an external MIDI device. All these motherboards have 3D audio interfaces onboard.

2.8.7. RJ-45 (LAN Port) Connector

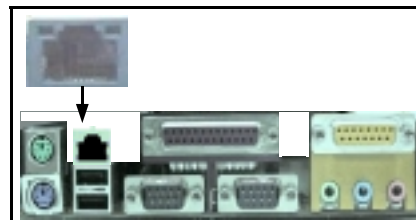

Connector: CN35 (LAN)
The mainboard comes with onboard 10/100 Mb Fast Ethernet Network. The RJ-45 connector allows you to easily connect to a Local Area Network (LAN) through a network hub.



Hardware Installation

2.9. Jumper Settings

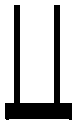
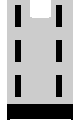
Jumpers are built on the mainboard to allow the user flexibility to configure the mainboard settings to meet their specific requirements. The mainboard comes with **six** jumpers, **five** 3-pin and **one** 2-pin jumpers. When there is no jumper cap inserted into the jumper it is called "OPEN." When a cap is inserted into the jumper it is known as a "SHORT." Below are examples of short settings or open settings on a jumper.

Two-Pin Jumper		Three-Pin Jumper		
		<div style="display: flex; justify-content: space-around;"> <div style="text-align: center;"> PIN: 1 2 3  </div> <div style="text-align: center;"> PIN: 1 2 3  </div> </div>		
Open	Short	SHORT	Pin 1/Pin 2	Pin 2/Pin 3

2.9.1. JP1: KB/MS Power On

Type: 3 pin

Default: Pin 1 and Pin 2 Short (Disabled)

Some keyboards may not follow standard specifications. If you find you are having problems with your keyboard, change the settings on Pin 2 and Pin 3. This might help you to solve the problem.

2.9.2. JP3: CPU FSB Mode Selection

Type: 3 pin

Default: Pin 1 and Pin 2 Short (User mode)

This jumper allows you to set the CPU FSB mode. To select User Mode, please short pin 1 and pin 2; To select Safe Mode, please short pin 2 and pin 3.

Note: If your computer hang while overclocking, please set JP3 to Safe mode (safe mode is fixed at 100MHz) and reboot. After rebooting, enter BIOS Setup menu to set the correct CPU FSB and reset JP3 to User mode.

2.9.3. JP5: Clear CMOS

Type: 3 pin

Default: Pin 1 and Pin 2 Short

If you have made an improper setting in the BIOS setup and your computer is not functioning, or if you have forgotten your password, you can use this jumper to clear the CMOS memory and to reconfigure your system.

To clear the CMOS, please follow these instructions:

1. Turn the system power off and unplug your computer;
2. Insert the jumper cap on Pin 2 and Pin 3 for 3 ~ 5 seconds;
3. Pull out the jumper cap and replace it on Pin 1 and Pin 2;
4. Turn your PC on and run the BIOS setup program.

Hardware Installation

2.9.4. JP6: Clear Password

Type: 3 pin
Default: Pin 1 and Pin 2 Short

If you forget your keyboard power-on password you can use JP6 to clear it from the I/O chip (where it is stored).

To clear the Keyboard power-on password, please follow these instructions:

1. Turn the system power "OFF" and unplug your computer.
2. Insert the jumper cap on Pin 2 and Pin 3 for 3 ~ 5 seconds.
3. Pull out the jumper cap and replace it on Pin 1 and Pin 2.
4. Turn your PC on and run the BIOS setup program.

2.9.5. JP7: SATA1 and SATA2 mode Selection (only for NF2S-AED)

Type: 3 pin
Default: Pin 1 and Pin 2 Short (Master/Master)

If you short Pin 1 and Pin 2, SATA1 and SATA2 both are master mode. While you short Pin 2 and Pin 3, SATA1 is master, and SATA2 is slave mode.

2.9.6. JP9: CPU Temperature Setting

Type: 2 pin
Default: Short (for 0.13u CPU)

If the CPU you are using is a 0.13u CPU, please let this jumper short. While if the CPU you are using is a 0.18u CPU, please let this jumper open.

Managing The PC BIOS

Chapter 3 - Managing the PC BIOS

3.1. Award BIOS CMOS Setup Utility

Once you have installed the mainboard you still need to setup the BIOS before you can run your PC. The EEPROM on the mainboard stores the AWARD BIOS CMOS Setup Utility, which allows you to configure your system. When you want to configure or make any changes to the configuration of your system BIOS you must run the BIOS CMOS Setup Utility.

GETTING STARTED

Every time you start your computer, the system provides you with an opportunity to run the BIOS CMOS Setup Utility. As soon as you turn on your system, press the <Delete> button to activate the BIOS CMOS Setup Utility.

If your computer finishes the POST (Power-On-Self-Test) the BIOS CMOS Setup Utility will **not be** activated. If your computer completes the POST you need to restart the system to activate the BIOS CMOS Setup Utility. To restart the system, you can either turn the power off, press the reset button on your chassis or press the <Ctrl> + <Alt> + <Delete> button. In all three cases the system will restart and, to activate the BIOS CMOS Setup Utility, you must immediately press the <Delete> button.

3.2. Main Menu

Phoenix - AwardBIOS CMOS Setup Utility	
▶ Standard CMOS Features	Load Fail-Safe Defaults
▶ Advanced BIOS Features	Load Optimized Defaults
▶ Advanced Chipset Features	Set Supervisor Password
▶ Integrated Peripherals	Set User Password
▶ Power Management Setup	Save & Exit Setup
▶ PnP/PCI Configurations	Exit Without Saving
▶ PC Health Status	
Esc : Quit	F9: Menu in BIOS
F10 : Save and Exit Setup	← ↑ ↓ → : Select Item
Time, Date, Hard Disk Type ...	

Note: BIOS software is continuously updated therefore the BIOS menus and the descriptions that are given in this manual are for reference purposes only.

Managing The PC BIOS

Navigation Keys

You will notice a legend bar at the bottom of the main menu. The keys in this legend bar show you how to navigate through the setup menus. The table below lists the control keys with their corresponding functions:

Control Key	Function
Up Arrow	Moves to the previous item.
Down Arrow	Moves to the next item.
Left Arrow	Moves to the item on the left.
Right Arrow	Moves to the item on the right.
Enter	Selects the desired item.
F1	Displays the help screen for the selected feature.
Esc key	Exits to the previous screen.
PgUp(-)/PgDn(+)	Modifies or changes the content of the highlighted item.
F5	Restores the previous CMOS values to the current page setup. This will not restore the previous values for any other pages.
F7	Loads the SETUP default values from BIOS default table, (only the current page setup will be loaded).
F10	Saves changes to the CMOS and exits the setup.

3.3. Standard CMOS Setup *(This menu is on next page)*

Date (mm : dd : yy)

Sets your system to the date that you specify (usually the current date). The format is month, day, and year. Press the right or left arrow key to move to the desired field (month, date, year). Press the PgUp or PgDn key to increment the setting, or type the desired value into the field.

Time (hh : mm : ss)

Sets your system to the time you specify (usually the current time). The format is hour, minute, second. The time format is based on the 24-hour military-time clock. For example, 1 p.m. is 13:00:00. Press the right or left arrow key to move to the desired field. Press the PgUp or PgDn key to increment the setting, or type the desired value into the field.

IDE Primary / Secondary Master / Slave

This mainboard supports four IDE Hard Drives. These fields allow you to set your Hard Drive parameters. Move the selection bar to the IDE Hard Drive you want to configure. Press the "ENTER" key. If you select "AUTO" the system BIOS will detect the HDD type automatically.

Managing The PC BIOS

Phoenix - AwardBIOS CMOS Setup Utility Standard CMOS Features		
Date (mm : dd : yy)	Thu, Aug 15, 2002	Item Help
Time (hh : mm : ss)	15 : 48 : 52	
▶ IDE Primary Master	[Maxtor 52049H4]	Menu Level ▶
▶ IDE Primary Slave	[None]	
▶ IDE Secondary Master	[None]	Change the day, month, year and century
▶ IDE Secondary Slave	[None]	
Drive A	1.44, 3.5 in	
Drive B	None	
Video	EGA/VGA	
Halt On	All Errors	
Base Memory	640K	
Extended Memory	65472K	
Total Memory	1024K	

Drive A / B

The mainboard can support up to two floppy disk drives. These two selection fields allow you to select the floppy drives that are installed on your computer. Select the correct specifications for the diskette drive(s) installed on your computer.

Diskette Drive	Type of Disk Drive	Capacity
None	No diskette drive installed	
360K 5.25 in	5-1/4 inch PC-type standard drive	360 KB
1.2M 5.25 in	5-1/4 inch AT-type high-density drive	1.2 MB
720K 3.5 in	3-1/2 inch single-sided drive	720 KB
1.44M 3.5 in	3-1/2 inch double-sided drive	1.44 MB
2.88M 3.5 in	3-1/2 inch double-sided drive	2.88 MB

Video

This field selects the type of primary video subsystem that is on your computer. The BIOS CMOS Setup Utility will automatically detect the correct video type.

Video	
EGA/VGA	Enhanced Graphics Adapter/Video Graphics Array. For EGA, VGA, EGA, SVGA or PGA monitor adapters
CGA 40	Color Graphics Adapter power up in 40 column mode
CGA 80	Color Graphics Adapter power up in 80 column mode
MONO	Monochrome adapter includes high resolution monochrome adapters

Managing The PC BIOS

Halt On

This field allows you to decide which errors, detected during the Power On Self Test (POST), will halt the system.

Base Memory / Extended Memory / Total Memory

This field displays the amount of memory detected by the system during boot up. This is a display only field. You cannot make any changes to this field.

Base Memory: Indicates the memory installed below the conventional 1MB space.

Extended Memory: Indicates the memory installed above the 1MB space.

Total Memory: Indicates the total memory installed in the PC system.

3.4. Advanced BIOS Features

Phoenix - AwardBIOS CMOS Setup Utility Advanced BIOS Features		
		Item Help
Virus Warning	[Disabled]	Menu Level ▶ Allows you to choose the VIRUS warning feature for IDE Hard disk boot sector protection. If this function is enabled and someone attempts to write data into this area, BIOS will show a warning message on screen and alarm beep.
CPU Internal Cache	[Enabled]	
External Cache	[Enabled]	
Quick Power On Self Test	[Enabled]	
First Boot Device	[Floppy]	
Second Boot Device	[HDD-0]	
Third Boot Device	[LS120]	
Boot Other Device	[Enabled]	
Swap Floppy Drive	[Disabled]	
Boot Up Floppy Seek	[Enabled]	
Boot Up NumLock Status	[On]	
Gate A20 Option	[Fast]	
Typematic Rate Setting	[Disabled]	
X Typematic Rate (Chars/Sec)	6	
X Typematic Delay (Msec)	250	
Security Option	[Setup]	
APIC Mode	[Enabled]	
X MPS Version Control For OS	[1.4]	
OS Select For DRAM > 64 MB	[Non-OS2]	
HDD S.M.A.R.T Capability	[Disabled]	
Small Logo (EPA) Show	[Enabled]	

Virus Warning

When you enable the virus warning you will receive a warning message whenever a program (specifically, a virus) attempts to write to the boot sector or the partition table of the hard disk drive. If you receive such a message you should immediately run an anti-virus program. Keep in mind that this feature only protects the boot sector and not the entire hard drive.

Note: Disk diagnostic programs that access the boot sector table can trigger the virus-warning message. If you run such a program, recommend that you first disable the virus warning.

Managing The PC BIOS

CPU Internal Cache / External Cache

Cache memory is additional memory that is much faster than conventional DRAM (system memory). CPUs from 486-type up contain internal cache memory, and most, but not all, modern PCs have an additional (external) cache memory. When the CPU requests data, the system transfers the requested data from the main DRAM into cache memory, for faster access by the CPU.

Quick Power On Self Test

If enabled the amount of time required to run the power-on self-test (POST) will decrease. A quick POST skips certain steps. We recommend that you disable quick POST. It is better to find a problem during POST than to lose data during your work.

First / Second / Third Boot Device

These fields allow you to decide the boot sequence of your bootable devices such as Floppy Drive, Hard Drive, CD ROM...etc

Boot Other Device

When this field is enabled you will be able Boot your computer from a different device, not your HDD or FDD.

Swap Floppy Drive

This field is effective only in systems with two floppy drives. When Enabled is selected physical drive B is assigned to logical drive A, and physical drive A is assigned to logical drive B.

Boot Up Floppy Seek

When enabled, the BIOS tests (seeks) floppy drives to determine whether they have 40 or 80 tracks. Only 360-KB floppy drives have 40 tracks; drives with 720 KB, 1.2 MB, and 1.44 MB capacity all have 80 tracks. Very few modern PCs have 40-track floppy drives so we therefore recommend that you set this field to Disabled to save time.

Boot Up NumLock Status

This controls the state of the NumLock key when the system boots. This field is toggled between On or Off. When it is on the numeric keypad generates numbers instead of controlling the cursor operations. When it is off the numeric keypad controls cursor operations and does not generate numbers.

Gate A20 Option

Gate A20 is a signal that gives the system access to addresses higher than A19. If you select Fast the chipset will control this signal. If you select normal a pin in the keyboard controller will control the signal.

Typematic Rate Setting

The keyboard controller determines the rate at which the keystrokes from the keyboard are repeated. If enabled the typematic rate and the typematic delay can be selected.

Managing The PC BIOS

Typematic Rate

The rate a character will repeat itself on the screen when you hold down a key.

Typematic Delay

This is the delay time (Msec) before the repetition of characters starts.

Security Option

This field allows you to select the "Setup" or "System" security option. It works concurrently with the "Set Supervisor Password" in the main menu.

When the "Setup" option is selected, you will be prompted to enter your "Password" before you can start the BIOS CMOS Setup Utility. When you select "System" option, you will be prompted to enter your password in order to load the Operating System.

*TIP: Forgot your password then clear the RTC RAM
If you happen to forget your password you can use Jumper 6 (JP6) to clear the password by erasing the CMOS Real Time Clock (RTC) Ram. Please see section 2.9.4 on page 26.*

APIC Mode

This field is used to enable or disable the APIC (Advanced Programmable Interrupt controller). Due to compliance with PC2001 design guide, the system is able to run in APIC mode. Enabling APIC mode will expand available IRQ resources for the system.

MPS Version Control for OS

This field allows you to select which MPS (Multi-Processor Specification) version to be used for the operating system. You need to select the MPS version supported by your operating system. To find out which version to use, consult the vendor of your OS.

OS Select For DRAM > 64MB

Only select OS2 if you are running an OS/2 operating system with a RAM greater than 64 Mb. Otherwise, for all other operating systems, use the default setting "Non-OS2."

HDD S.M.A.R.T Capability

You may "enable" this option if your Hard Drive supports the S.M.A.R.T technology (Self Monitoring Analysis Reporting Technology) feature. S.M.A.R.T will monitor and report your Hard Drive health status. Ask your Hard Drive vendor for more information. **NOTE: Using this feature may decrease system performance.**

Small Logo (EPA) Show

This field allows you to determine whether to show EPA settings on the right corner of the power-on screen.

Managing The PC BIOS

3.5. Advanced Chipset Features

Phoenix - AwardBIOS CMOS Setup Utility Advanced Chipset Features		
System Performance	[Optimal]	Item Help
FSB Frequency	[100 MHz]	Menu Level ▶
CPU Interface	[Optimal]	
Memory Frequency	[By SPD]	
Resulting Frequency		
Memory Timings	[Optimal]	
X T (RAS)	7	
X T (RCD)	1	
X T (RP)	1	
X CAS Latency	2.5	
FSB Spread Spectrum	[Disabled]	
AGP Spread Spectrum	[Disabled]	
AGP Aperture Size (MB)	[64M]	
AGP 8X Support	[Enabled]	
AGP Fast Write Capability	[Enabled]	
CPU Thermal-Throttling	[50.0%]	
System BIOS Cacheable	[Disabled]	
Video RAM Cacheable	[Disabled]	

System Performance

The field allows users to control the status of system performance. The default setting is Optimal. The other optional settings can be Aggressive, Turbo or Expert.

FSB Frequency

The setting for this field allows you to set the CPU FSB to match with the DIMM speed.

CPU Interface

This field allows you to select the CPU/FSB parameters for the stable or over-clocked status for the CPU. The optional settings can be Optimal or Aggressive.

Memory Frequency

This field allows you to manually select the frequency of the memory modules you are using.

Memory Timing

Selects whether DRAM timing is controlled by the SPD EEPROM on the DRAM module. Setting to By SPD enables DRAM timings to be determined by BIOS based on the configurations on the SPD. Selecting Manual allows users to configure the DRAM timings manually. Options: By SPD, Manual, High Performance.

Managing The PC BIOS

FSB Spread Spectrum

This item is used to enable or disable the FSB clock generator's Spread Spectrum feature. When overclocking the FSB, always set it to Disabled.

AGP Spread Spectrum

This item is used to enable or disable the AGP clock generator's Spread Spectrum feature. When overclocking the AGP slot, always set it to Disabled.

AGP Aperture Size

This field selects the size of the Accelerated Graphics Port (AGP) aperture. The aperture is a portion of the PCI memory address range dedicated for graphics memory address space. Host cycles that hit the aperture range are forwarded to the AGP without any translation. The default is 64MB. You may increase this memory when you need to have faster access for 3D graphics applications (e. g. games).

AGP 8X Support

This item is used to control the functionality of the AGP3.0 8X interface. Select Enabled only when your card supports this function.

AGP Fast Write Capability

This item enables or disables the AGP Fast Write feature.

CPU Thermal-Throttling

This field allows you to select the CPU Throttle rate. When the CPU temperature is too high, the onboard hardware monitoring will tell the CPU to reduce its processing speed to the throttling speed to protect the CPU. This function will not work when the CPU Warning Temperature is disabled.

System BIOS Cacheable

Selecting "Enabled" allows caching of the system BIOS ROM. This results system performance. However, if any program writes to this memory area, a system error may occur.

Video RAM Cacheable

Select Enabled allows caching of the video RAM, resulting in better system performance. However, if any program writes to this memory area, a system error may occur.

Managing The PC BIOS

3.6. Integrated Peripherals

Phoenix - AwardBIOS CMOS Setup Utility Integrated Peripherals		
OnChip IDE Channel0	[Enabled]	Item Help
Primary Master PIO	[Auto]	
Primary Slave PIO	[Auto]	
Primary Master UDMA	[Auto]	
Primary Slave UDMA	[Auto]	
OnChip IDE Channel1	[Enabled]	
Secondary Master PIO	[Auto]	
Secondary Slave PIO	[Auto]	
Secondary Master UDMA	[Auto]	
Secondary Slave UDMA	[Auto]	
IDE Prefetch Mode	[Enabled]	
Init Display First	[PCI Slot]	
OnChip USB	[V1.1+V2.0]	
USB Keyboard Support	[Disabled]	
AC97 Audio	[Auto]	
MAC Lan (nVIDIA)	[Auto]	
Machine MAC (NV) Address	[Disabled]	
X MAC (NV) Address Input	Press Enter	
OnChip 1394	[Auto]	
IDE HDD Block Mode	[Enabled]	
POWER ON Function	[BUTTON ONLY]	
KB Power ON Password	[Enter]	
Hot Key Power ON	[Ctrl-F1]	
Onboard FDC Controller	[Enabled]	
Onboard Serial Port 1	[378/IRQ4]	
Onboard Serial Port 2	[2F8/IRQ3]	
VART Mode Select	[Normal]	
Onboard Parallel Port	[378/IRQ7]	
Parallel Port Mode	[SPP]	
EPP Mode Select	[EPP1.7]	
ECP Mode Use DMA	[3]	
PWRON After PWR-Fail	[Off]	
Game Port Address	[201]	
Midi Port Address	[330]	
Midi Port IRQ	[10]	
		Menu Level ▶

OnChip IDE Channel 0/1

The chipset contains a PCI IDE interface with support for two IDE channels. To activate the primary IDE interface select Enabled. If you want to disable the onboard IDE 1 and/or 2, then select Disabled and this interface will be deactivated.

IDE Prefetch Mode

The onboard IDE drive interfaces supports IDE pre-fetching for faster drive access. If you install a primary and/or secondary add-in IDE interface which does not support pre-fetching set this field to Disabled.

Managing The PC BIOS

Primary/Secondary, Master/Slave PIO

The four IDE PIO (Programmed Input/Output) fields let you set a PIO mode (0-4) for each of the four IDE devices that the onboard IDE interface supports. Modes 0 through 4 provide successively increased performance. In Auto mode, the system automatically determines the best mode for each device.

Primary/Secondary, Master/Slave UDMA

Ultra DMA/66 implementation is possible only if your IDE hard drive supports it and the operating environment includes a DMA driver (Windows 98 OSR2 or a third-party IDE bus master driver). If your hard drive and your system software both support Ultra DMA/66, select Auto to enable BIOS support.

IDE Prefetch Mode

The onboard IDE drive interfaces support IDE prefetching, for faster drive accesses. When you install a primary and / or secondary add-in IDE interface, set this option to Disable if the interface does not support prefetching.

Init Display First

This field allows a user, with two graphics cards installed on his system, to select which graphics card will be activated first: either the PCI graphics card or the AGP graphics card. If you have only installed one graphics card the BIOS will automatically detect it and you do not need to set this field.

OnChip USB

This field allows you to enable or disable the onboard USB controller.

USB Keyboard Support

This field should only be enabled if you are using a USB keyboard. If you are not using this kind of keyboard you should disable it.

AC97 Audio

This field allows you to control the onboard AC 97 audio.

MAC Lan (nVIDIA)

Enables this field to "Auto" allows the BIOS to auto-detect the nVIDIA LAN controller.

Machine MAC (NV) Address

If you choose "Enabled" this field allows you update the MAC address manually.

MAC (NV) Address Input

Allows you to input the MAC(NV) address.

Onchip 1394 (for NF2S-AED only)

This item allows you to enable / disable the onboard IEEE 1394 controller.

IDE HDD Block Mode

Block mode is also known as block transfer, multiple commands, or multiple sector read/write. If your IDE hard drive supports block mode select "Enabled" for automatic detection of the optimal number of block read/writes per sector the drive can support.

Managing The PC BIOS

Power-on Function

This function allows you to select different ways to power on your PC system.

KB Power On Password

When you select KB Power On Password to power on the PC system in the previous field, you may enter your personal password into this field. When you are finished, you may use the password to power on your PC system.

Hot Key Power On

When you select Hot Key Power On to power on the PC system in the previous field, you may select a set of Hot Key in this field. When finished, you may use the hot key combination to power on your PC system.

Onboard FDC Controller

Select Enabled if your system has a Floppy Disk Controller (FDC) installed on the system board and you want to use it. If you install add-in FDC or the system has no floppy drive, select Disabled in this field.

Onboard Serial Port 1 / Port 2

The two fields allow you to select I / O address and corresponding interrupt for the first and second serial ports.

Parallel Port Mode

This field allows you to select an operating mode for the onboard parallel (printer) port. Select Normal, Compatible, or SPP unless you are certain your hardware and software both support one of the other available modes.

EPP Mode Select

This field allows you to choose the EPP version you want to use. We recommend that you use EPP 1.9 for the best performance but if you do you may have some connection problems so try setting it to EPP 1.7.

ECP Mode Use DMA

This item allows you to select a DMA channel for the parallel port for use during ECP.

Game Port Address

This field allows you to select the I/O address for the onboard game port. The default is 201.

Midi Port Address

This field allows you to select the I/O address for the onboard MIDI port. The default is 330.

MIDI Port IRQ

This field allows you to select the IRQ for the onboard MIDI port. The default is 10.

Managing The PC BIOS

3.7. Power Management Setup

Phoenix - AwardBIOS CMOS Setup Utility Power Management Setup		
ACPI Function	[Enabled]	Item Help
ACPI Suspend Type	[S1(POS)]	Menu Level ▶
Power Management	[User Define]	
Video Off Method	[Blank Screen]	
HDD Power Down	[Disabled]	
HDD Down In Suspend	[Disabled]	
Soft-Off by PBTN	[Instant-Off]	
WOL (RI#) From Soft-Off	[Disabled]	
Power-On by Alarm	[Disabled]	
X Time (dd:hh:mm) of Alarm	0:4:0	

ACPI function

This item allows you to enable/disable the Advanced Configuration and Power Management (ACPI).

ACPI Suspend Type

This field selects the **S1 (POS)** (Power On Suspend) suspend state mode.

Power Management

This category allows you to select the degree of power saving. The choices are shown in the table below.

Min. Power Saving	Minimum power management. Suspend Mode = 1 hr.
Max. Power Saving	Maximum power management -- ONLY AVAILABLE FOR SL CPU. Suspend Mode = 1 min.
User Defined	Allows you to set each mode individually. When not disabled, each of the ranges are from 1 min. to 1 hr. except for HDD Power Down which ranges from 1 min. to 15 min. and disable.

Video Off Method

This determines the manner in which the monitor goes blank.

V/H SYNC+Blank	This selection will cause the system to turn off the vertical and horizontal synchronization ports and write blanks to the video buffer.
Blank Screen	This option only writes blanks to the video buffer.
DPMS Support	Select this option if your monitor supports the Display Power Management Signaling (DPMS) standard of the Video Electronics Standards to select video power management values.

Managing The PC BIOS

HDD Power Down

When enabled and after the set time of system inactivity, the hard disk drive will be powered down while all other devices remain active.

Power Down in Suspend

When enabled, after the set time of system inactivity, all devices except the CPU will be shut off.

Soft-Off by PBTN

Pressing the power button for more than 4 seconds forces the system to enter the Soft-Off state when the system has "hung".

WOL (RI #) From Soft-Off

An input signal from the LAN will wake up the system from a soft off state.

Power-on by Alarm

When enabled, you can use the following two fields to select the time and date to wake up the PC system from power saving mode.

Time (hh:mm:ss) of Alarm

When RTC Alarm Resume is enabled, you can set the date and time at which the RTC (real-time clock) alarm awakens the system from Suspend mode.

Managing The PC BIOS

3.8. PNP/PCI Configuration

Phoenix - AwardBIOS CMOS Setup Utility PnP/PCI Configurations

		Item Help
Reset Configuration Data	[Disabled]	
Resources Controlled By × IRQ Resources	[Auto (ESCD)] Press Enter	Menu Level ▶ Select Yes if you are using a Plug and Play capable operating system. Select No if you need the BIOS to configure non-boot devices.
PCI/VGA Palette Snoop	[Disabled]	
Assign IRQ For VGA	[Enabled]	

Reset Configuration Data

Normally, you leave this field Disabled. If you have installed a new add-on and the system reconfiguration has caused such a serious conflict that the operating system cannot boot then select Enabled. Selecting Enabled will reset the Extended System Configuration Data (ESCD).

Resources controlled By

Award Plug and Play BIOS has the capacity to automatically configure all of the boot and Plug and Play compatible devices. However, this capability means absolutely nothing unless you are using a Plug and Play operating system such as Windows 98.

IRQ Resources

When resources are controlled manually, assign each system interrupt a type, depending on the type of device using the interrupt.

PCI/VGA Palette Snoop

Some display cards are non-standard VGA cards (such as graphics accelerators and MPEG cards) which may not display color properly on your screen. If this field is **Enabled** it may correct the problem. If you have a normal display card then leave this field **Disabled** as the default setting .

Assign IRQ For VGA/USB

A system's IRQs are limited. Sometimes you may need to use more IRQ signals for your add-on cards. BIOS allows you to disable the IRQ which is supposed to be connected to the VGA and USB ports. If you choose to disable the IRQ on the VGA or USB port, the IRQ will be released and becomes available for other devices. Please make sure that you have a USB or VGA adapter that does not need an IRQ before you select Disabled.

Managing The PC BIOS

3.9. PC Health Status

Phoenix - AwardBIOS CMOS Setup Utility PC Health Status		
CPU Warning Temperature	[Disabled]	Item Help
Current CPU Temperature	40°C/103°F	Menu Level ▶
Current CPU FAN Speed	4821 RPM	
CPUFAN1/CPUFAN2/CPUFAN3	0 RPM	
Vcore (V)	1.66 V	
+ 3.3 (V)	3.41V	
+ 5 V	4.75 V	
+ 12 V	12.09 V	
- 12 V	-12.11 V	
VBAT (V)	2.99 V	
5VSB (V)	5.26 V	
Shutdown Temperature	[Disabled]	

CPU Warning Temperature

This field allows you to select an operating temperature range for your CPU. If the CPU temperature moves out of this range, any warning mechanism you have programmed into your system will be activated.

Current CPU Temp.

This field shows the current temperature for CPU 1.

Current CPU FAN Speed

This field shows you the present CPU Cooling FAN1 speed.

Current Chassis FAN Speed

This field shows you the present CPU Cooling FAN2 speed.

Vcore

This field and the files below show you the current system voltage

Shutdown Temperature

When the system reaches a certain maximum temperature the system will automatically shutdown.

Managing The PC BIOS

3.10. Load Fail-Safe Defaults

Phoenix - AwardBIOS CMOS Setup Utility	
<ul style="list-style-type: none">▶ Standard CMOS Features▶ Advanced BIOS Features▶ Advanced Chipset Features▶ Integrated Peripherals▶ Power Management Setup▶ PNP/PCI Configuration▶ PC Health Status	<ul style="list-style-type: none">Load Fail-Safe DefaultsLoad Optimized DefaultsSet Supervisor PasswordSet User PasswordSave & Exit SetupExit Without Saving
Esc : Quit F9 : Menu in BIOS ← ↑ ↓ → : Select Item F10 : Save and Exit Setup	
Load Optimized Defaults	

When you press <Enter> in this item, you will get a confirmation dialog box with a message similar to:

Load Fail-Safe Defaults (Y/N) ? N

Pressing "Y" loads the BIOS defaults for the most stable, minimal performance system operation.

3.11. Load Optimized Defaults

Phoenix - AwardBIOS CMOS Setup Utility	
<ul style="list-style-type: none">▶ Standard CMOS Features▶ Advanced BIOS Features▶ Advanced Chipset Features▶ Integrated Peripherals▶ Power Management Setup▶ PNP/PCI Configuration▶ PC Health Status	<ul style="list-style-type: none">Load Fail-Safe DefaultsLoad Optimized DefaultsSet Supervisor PasswordSet User PasswordSave & Exit SetupExit Without Saving
Esc : Quit F9 : Menu in BIOS ← ↑ ↓ → : Select Item F10 : Save and Exit Setup	
Load Optimized Defaults	

Managing The PC BIOS

3.11.1. Load Optimized Defaults

There is CMOS memory on the mainboard that can be used to store the system settings. If you don't know how to use the Award BIOS CMOS Setup Utility to select the settings, you may use this field to load the optimized defaults which are defined in the system BIOS. **Our engineer recommends the Optimized Defaults.** If this option is selected it will give a series of parameters that will ensure the reliability and performance of your PC.

If you lose your CMOS data or you don't know how to complete the setup procedure, you may use this option to load the Optimized default values from the BIOS default table.

If the CMOS data is corrupted, or if you selected some CMOS settings and find that the PC system becomes very unstable, you should try to load the optimized default values first and then re-configure the BIOS.

3.12. Set Supervisor Password and User Password

Phoenix - AwardBIOS CMOS Setup Utility	
<ul style="list-style-type: none">▶ Standard CMOS Features▶ Advanced BIOS Features▶ Advanced Chipset Features▶ Integrated Peripherals▶ Power Management Setup▶ PNP/PCI Configuration▶ PC Health Status	<ul style="list-style-type: none">Load Fail-Safe DefaultsLoad Optimized DefaultsSet Supervisor PasswordSet User PasswordSave & Exit SetupExit Without Saving
Esc : Quit F9 : Menu in BIOS ← ↑ ↓ → : Select Item F10 : Save and Exit Setup	
Change / Set / Disable Password	

3.12.1. Set Supervisor Password

The "SUPERVISOR PASSWORD" is for you to control unauthorized access to your BIOS CMOS Setup or Booting into the your PC system. The Supervisor Password option is used together with the Security Option in section 3.5.

Managing The PC BIOS

When "Setup" is selected in the Security Option:

If you want to change any BIOS setting, you will have to key-in the Supervisor Password so that you can start the BIOS CMOS Setup Utility and change the system setting.

When "System" is selected in Security Option:

Whenever you turn on the PC, it will request the user to enter the Password in order to boot up your system. Without the correct password, the PC system will stop and the operating system will not be loaded.

3.12.2. Set User Password

The User Password can be used to check the user's authority. However, this password entry is different from the "SUPERVISOR PASSWORD". The User Password has a different function to the "Supervisor Password" and the "Security Option" setup in Section 3.5:

A. When there is the password stored in "SUPERVISOR PASSWORD"

1. When "Setup" is selected in the Security Option:

When you use the "User Password" to log into the BIOS setup program, you can only view the BIOS settings, but you cannot change them. The only setting you can change is the "User Password" and you can also select "SAVE & EXIT SETUP" and "EXIT WITHOUT SAVING" from the main menu. (If you use the Supervisor Password to log into the PC system, you will have complete rights to all the BIOS settings.

2. When "System" is selected in Security Option:

When you turn on the PC system, it will request that you enter the Password. Without the correct password, the PC system will stop and the operating system won't be loaded.

B. When there is no password stored in "SUPERVISOR PASSWORD"

1. When "Setup" is selected in Security Option:

Users can use the "User Password" to log into the BIOS setup program, and they can change any of the BIOS settings.

2. When "System" is selected in Security Option:

When you turn on your PC, you will be requested to enter the Password. Without the correct password, the PC system will stop and the operation system will not be loaded.

Managing The PC BIOS

3.13. Save & Exit Setup/Exit Without Saving

Phoenix - AwardBIOS CMOS Setup Utility	
<ul style="list-style-type: none">▶ Standard CMOS Features▶ Advanced BIOS Features▶ Advanced Chipset Features▶ Integrated Peripherals▶ Power Management Setup▶ PNP/PCI Configuration▶ PC Health Status	<ul style="list-style-type: none">Load Fail-Safe DefaultsLoad Optimized DefaultsSet Supervisor PasswordSet User PasswordSave & Exit SetupExit Without Saving
Esc : Quit F9 : Menu in BIOS ← ↑ ↓ → : Select Item F10 : Save and Exit Setup	
Save Data to CMOS & Exit SETUP / Abandon all Data & Exit SETUP	

3.13.1. Save & Exit Setup

This option will save all the setup values to CMOS RAM and exit the SETUP utility. Move the selection bar to "SAVE & EXIT SETUP" and press the "Enter" key, then type "Y" and press the "Enter" key again. The values you have entered will be saved and all the information stored in the CMOS memory.

3.13.2. Exit Without Saving

This option will exits the setup utility without saving any of the values you changed in the CMOS RAM. If you do not want to save any of the changes, or settings you selected in the BIOS SETUP utility, move the selection bar to the "EXIT WITHOUT SAVING" option. Press the "Enter" key. Then press "Y".