

NB73-BC

NB73-BL

Rev. A+
System Board
User's Manual

Copyright

This publication contains information that is protected by copyright. No part of it may be reproduced in any form or by any means or used to make any transformation/adaptation without the prior written permission from the copyright holders.

This publication is provided for informational purposes only. The manufacturer makes no representations or warranties with respect to the contents or use of this manual and specifically disclaims any express or implied warranties of merchantability or fitness for any particular purpose. The user will assume the entire risk of the use or the results of the use of this document. Further, the manufacturer reserves the right to revise this publication and make changes to its contents at any time, without obligation to notify any person or entity of such revisions or changes.

© 2002. All Rights Reserved.

Trademarks

Windows® 98 SE, Windows® ME, Windows® 2000, Windows NT® 4.0 and Windows® XP are registered trademarks of Microsoft Corporation. Intel® and Pentium® 4 are registered trademarks of Intel Corporation. Award is a registered trademark of Award Software, Inc. Other trademarks and registered trademarks of products appearing in this manual are the properties of their respective holders.

Caution

To avoid damage to the system:

- Use the correct AC input voltage range.

To reduce the risk of electric shock:

- Unplug the power cord before removing the system chassis cover for installation or servicing. After installation or servicing, cover the system chassis before plugging the power cord.

Battery:

- Danger of explosion if battery incorrectly replaced.
- Replace only with the same or equivalent type recommend by the manufacturer.
- Dispose of used batteries according to the battery manufacturer's instructions.

Joystick or MIDI port:

- Do not use any joystick or MIDI device that requires more than 10A current at 5V DC. There is a risk of fire for devices that exceed this limit.

FCC and DOC Statement on Class B

This equipment has been tested and found to comply with the limits for a Class B digital device, pursuant to Part 15 of the FCC rules. These limits are designed to provide reasonable protection against harmful interference when the equipment is operated in a residential installation. This equipment generates, uses and can radiate radio frequency energy and, if not installed and used in accordance with the instruction manual, may cause harmful interference to radio communications. However, there is no guarantee that interference will not occur in a particular installation. If this equipment does cause harmful interference to radio or television reception, which can be determined by turning the equipment off and on, the user is encouraged to try to correct the interference by one or more of the following measures:

- Reorient or relocate the receiving antenna.
- Increase the separation between the equipment and the receiver.
- Connect the equipment into an outlet on a circuit different from that to which the receiver is connected.
- Consult the dealer or an experienced radio TV technician for help.

Notice:

1. The changes or modifications not expressly approved by the party responsible for compliance could void the user's authority to operate the equipment.
2. Shielded interface cables must be used in order to comply with the emission limits.

Notice

This user's manual contains detailed information about the system board. If, in some cases, some information doesn't match those shown in the multilingual manual, the multilingual manual should always be regarded as the most updated version. The multilingual manual is included in the system board package.

To view the user's manual, insert the CD into a CD-ROM drive. The autorun screen (Mainboard Utility CD) will appear. Click the "Tools" icon then click "Manual" on the main menu.

System Board

This user's manual is for the NB73-BC and NB73-BL system boards. The only difference between these boards is the NB73-BL system board supports onboard LAN.

Table of Contents

Chapter 1 - Introduction

1.1	Features and Specifications.....	7
1.2	Hyper-Threading Technology Functionality Requirements.....	14
1.3	Package Checklist.....	14

Chapter 2 - Hardware Installation

2.1	System Board Layout	15
2.2	System Memory.....	17
2.3	Jumper Settings for Clearing CMOS Data.....	19
2.4	Jumper Settings for Selecting the CPU's Front Side Bus.....	21
2.5	Rear Panel I/O Ports.....	22
2.6	I/O Connectors.....	32

Chapter 3 - Award BIOS Setup Utility

3.1	The Basic Input/Output System.....	47
3.1.1	Standard CMOS Features.....	47
3.1.2	Advanced BIOS Features.....	53
3.1.3	Advanced Chipset Features	58
3.1.4	Integrated Peripherals.....	61
3.1.5	Power Management Setup.....	68
3.1.6	PhP/PCI Configurations.....	74
3.1.7	CPU Frequency Control.....	76
3.1.8	Load Fail-Safe Defaults.....	78
3.1.9	Load Optimized Defaults.....	78
3.1.10	Set Supervisor Password.....	79
3.1.11	Set User Password.....	79
3.1.12	Save & Exit Setup.....	80
3.1.13	Exit Without Saving.....	80
3.2	Updating the BIOS.....	81

Chapter 4 - Supported Softwares

4.1 Desktop Management Interface.....	83
4.2 Drivers, Utilities and Software Applications.....	86
4.3 Installation Notes.....	94

Appendix A - Enabling Hyper-Threading Technology

A.1 Enabling Hyper-Threading Technology.....	95
--	----

Appendix B - System Error Messages

B.1 POST Beep.....	98
B.2 Error Messages.....	98

Appendix C - Troubleshooting

C.1 Troubleshooting Checklist.....	100
------------------------------------	-----

Chapter I - Introduction

I.1 Features and Specifications

I.1.1 Features

Chipset

- Intel® 845E chipset
 - Intel® 845E Graphics Memory Controller Hub (MCH)
 - Intel® 82801DB I/O Controller Hub (ICH4)

Processor

The system board is equipped with Socket 478 for installing one of the following supported processors.

- Intel® Pentium® 4 Processor with Hyper-Threading Technology (Refer to section 1.2 for the Hyper-Threading Technology functionality requirements)
- Intel® Pentium® 4 processor (478-pin)
 - 533MHz system data bus
 - 400MHz system data bus
- Intel® Celeron® processor (478-pin)
 - 400MHz system data bus

System Memory

- Two 184-pin DDR SDRAM DIMM sockets
- 2.5V unbuffered PC1600 (DDR200) or PC2100 (DDR266) DDR SDRAM DIMM
- Supports maximum of 2GB system memory using 64Mbit, 128Mbit, 256Mbit or 512Mbit technology
 - Double-sided x16 DDR SDRAM DIMM is not supported

Density	64 Mbit		128 Mbit		256 Mbit		512 Mbit	
	X8	X16	X8	X16	X8	X16	X8	X16
Density Width	X8	X16	X8	X16	X8	X16	X8	X16
Single/Double	SS/DS	SS/DS	SS/DS	SS/DS	SS/DS	SS/DS	SS/DS	SS/DS
184-pin DDR	64/128MB	32MB/NA	128/256MB	64MB/NA	256/512MB	128MB/NA	512/1024MB	256MB/NA

Expansion Slots

The system board is equipped with 1 AGP slot and 6 PCI slots.



Important: (NB73-BL only)

Most PCI cards today are in “Master” mode and can be installed anywhere between PCI slot 1 and PCI slot 5. However, DO NOT install “Master” mode PCI cards onto PCI slot 6 because this slot only supports “Slave” mode.

The AGP slot only supports 1.5V AGP 4x (1066MB/sec. bandwidth) add-in cards. AGP is an interface designed to support high performance 3D graphics cards for 3D graphics applications. It handles large amounts of graphics data with the following features:

- Pipelined memory read and write operations that hide memory access latency.
- Demultiplexing of address and data on the bus for nearly 100 percent efficiency.

Onboard Audio Features

- 16-bit stereo full-duplex codec with independent variable sampling rate
- High quality differential CD input
- True stereo line level outputs
- 2-channel audio output

Onboard LAN Features (NB73-BL only)

- Uses Realtek RTL8100 fast ethernet controller
- Integrated IEEE 802.3, 10BASE-T and 100BASE-TX compatible PHY
- 32-bit PCI master interface
- Integrated power management functions
- Full duplex support at both 10 and 100 Mbps
- Supports IEEE 802.3u auto-negotiation
- Supports wire for management

Compatibility

- PCI 2.2 and AC '97 compliant
- Intel AGP version 2.0

Rear Panel I/O Ports (PC 99 color-coded connectors)

- 2 USB 2.0/1.1 ports
- 1 RJ45 LAN port (NB73-BL only)
- 2 NS16C550A-compatible DB-9 serial ports
- 1 DB-25 parallel port
- 1 mini-DIN-6 PS/2 mouse port
- 1 mini-DIN-6 PS/2 keyboard port
- 1 game/MIDI port
- 3 audio jacks: line-out, line-in and mic-in

I/O Connectors

- 2 connectors for 4 additional external USB 2.0/1.1 ports
- 2 internal audio connectors (CD-in and AUX-in)
- 1 S/PDIF-out connector
- 1 connector for IrDA interface
- 2 IDE connectors
- 1 floppy drive interface supports up to two 2.88MB floppy drives
- 2 ATX power supply connectors
- 1 Wake-On-LAN connector
- CPU fan, chassis fan and second fan connectors

PCI Bus Master IDE Controller

- Two PCI IDE interfaces support up to four IDE devices
- Supports ATA/33, ATA/66 and ATA/100 hard drives
- PIO Mode 4 Enhanced IDE (data transfer rate up to 14MB/sec.)
- Bus mastering reduces CPU utilization during disk transfer
- Supports ATAPI CD-ROM, LS-120 and ZIP

S/PDIF

The system board is equipped with the S/PDIF (Sony/Philips Digital Interface) digital audio interface. S/PDIF is a standard audio file transfer format that transfers digital audio signals to a device without having to be converted first to an analog format. This prevents the quality of the audio signal from degrading whenever it is converted to analog.

IrDA Interface

The system board is equipped with an IrDA connector for wireless connectivity between your computer and peripheral devices.

USB Ports

The system board supports USB 2.0 and USB 1.1 ports. USB 1.1 supports 12Mb/second bandwidth while USB 2.0 supports 480Mb/second bandwidth providing a marked improvement in device transfer speeds between your computer and a wide range of simultaneously accessible external Plug and Play peripherals.

BIOS

- Award BIOS, Windows® 98SE/2000/ME/XP Plug and Play compatible
- Supports SCSI sequential boot-up
- Flash EPROM for easy BIOS upgrades
- Supports DMI 2.0 function

Desktop Management Interface (DMI)

The system board comes with a DMI 2.0 built into the BIOS. The DMI utility in the BIOS automatically records various information about your system configuration and stores these information in the DMI pool, which is a part of the system board's Plug and Play BIOS. DMI, along with the appropriately networked software, is designed to make inventory, maintenance and troubleshooting of computer systems easier. Refer to chapter 4 for instructions on using the DMI utility.

1.1.2 Intelligence

Dual Function Power Button

Depending on the setting in the “Soft-Off By PWR-BTTN” field of the Power Management Setup, this switch will allow the system to enter the Soft-Off or Suspend mode.

Wake-On-Ring

This feature allows the system that is in the Suspend mode or Soft Power Off mode to wake-up/power-on to respond to calls coming from an external modem or respond to calls from a modem PCI card that uses the PCI PME (Power Management Event) signal to remotely wake up the PC. Refer to “Resume On Ring” (“PM Wake Up Events” field) in the Power Management Setup section in chapter 3 for more information.



Important:

If you are using a modem add-in card, the 5VSB power source of your power supply must support a minimum of $\geq 720\text{mA}$.

Wake-On-LAN

The Wake-On-LAN function is applicable only when you are using a LAN add-in card that has the same function. It allows the network to remotely wake up a Soft Power Down (Soft-Off) PC. Your LAN card must support the remote wakeup function. Refer to “Wake-On-LAN Connector” in chapter 2 and “Resume On LAN” (“PM Wake Up Events” field) in the Power Management Setup section in chapter 3 for more information.



Important:

The 5VSB power source of your power supply must support $\geq 720\text{mA}$.

Wake-On-Keyboard

This function allows you to use the keyboard to power-on the system. Refer to “Keyboard Power On” (“PM Wake Up Events” field) in the Power Management Setup section in chapter 3 for more information.

**Important:**

- *The power button will not function once a keyboard password has been set in the “KB Power On Password” field of the Integrated Peripherals submenu. You must type the correct password to power-on the system. If you forgot the password, power-off the system and remove the battery. Wait for a few seconds and install it back before powering-on the system.*
- *The 5VSB power source of your power supply must support $\geq 720\text{mA}$.*

Wake-On-USB Keyboard

The Wake-On-USB Keyboard function allows you to use a USB keyboard to wake up a system that is in the S3 (STR - Suspend To RAM) state. Refer to “USB KB Wake-Up From S3” (“PM Wake Up Events” field) in the Power Management Setup section in chapter 3 for more information.

**Important:**

- *If you are using the Wake-On-USB Keyboard function for 2 USB ports, the 5VSB power source of your power supply must support $\geq 1.5\text{A}$.*
- *If you are using the Wake-On-USB Keyboard function for 3 or more USB ports, the 5VSB power source of your power supply must support $\geq 2\text{A}$.*

RTC Timer to Power-on the System

The RTC installed on the system board allows your system to automatically power-on on the set date and time. Refer to “Resume By Alarm” (“PM Wake Up Events” field) in the Power Management Setup section in chapter 3 for more information.

ACPI STR

The system board is designed to meet the ACPI (Advanced Configuration and Power Interface) specification. ACPI has energy saving features that enables PCs to implement Power Management and Plug-and-Play with operating systems that support OS Direct Power Management. Currently, only Windows® 98SE/2000/ME/XP supports the ACPI function. ACPI when enabled in the Power Management Setup will allow you to use the Suspend to RAM function.

With the Suspend to RAM function enabled, you can power-off the system at once by pressing the power button or selecting “Standby” when you shut down Windows® 98SE/2000/ME/XP without having to go through the sometimes tiresome process of closing files, applications and operating system. This is because the system is capable of storing all programs and data files during the entire operating session into RAM (Random Access Memory) when it powers-off. The operating session will resume exactly where you left off the next time you power-on the system.

**Important:**

The 5VSB power source of your power supply must support $\geq 1A$.

AC Power Failure Recovery

When power returns after an AC power failure, you may choose to either power-on the system manually, let the system power-on automatically or return to the state where you left off before power failure occurs. Refer to “PWR Lost Resume State” in the Power Management Setup section in chapter 3 for more information.

Virus Protection

Most viruses today destroy data stored in hard drives. The system board is designed to protect the boot sector and partition table of your hard disk drive.

I.2 Hyper-Threading Technology Functionality Requirements

Enabling the functionality of Hyper-Threading Technology for your computer system requires **ALL** of the following platforms.

Components:

- CPU - an Intel® Pentium® 4 Processor with HT Technology
- Chipset - an Intel® chipset that supports HT Technology
- BIOS - a BIOS that supports HT Technology and has it enabled
- OS - an operating system that includes optimizations for HT Technology

Please refer to Appendix A for information about enabling the functionality of the Hyper-Threading Technology. For more information on Hyper-Threading Technology, go to: www.intel.com/info/hyperthreading.

I.3 Package Checklist

The system board package contains the following items:

- The system board
- A user's manual
- One IDE cable for ATA/33, ATA/66 or ATA/100 IDE drives
- One 34-pin floppy disk drive cable
- One "Main Board Utility" CD

If any of these items are missing or damaged, please contact your dealer or sales representative for assistance.

Chapter 2 - Hardware Installation

2.1 System Board Layout

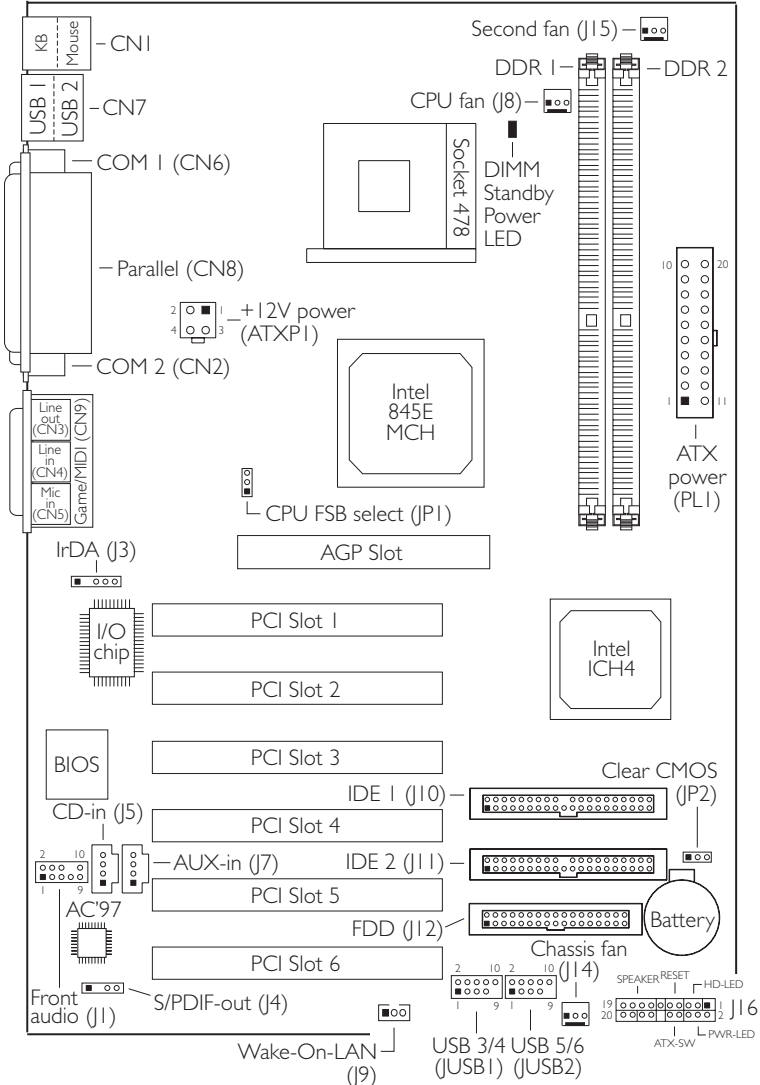

NB73-BC

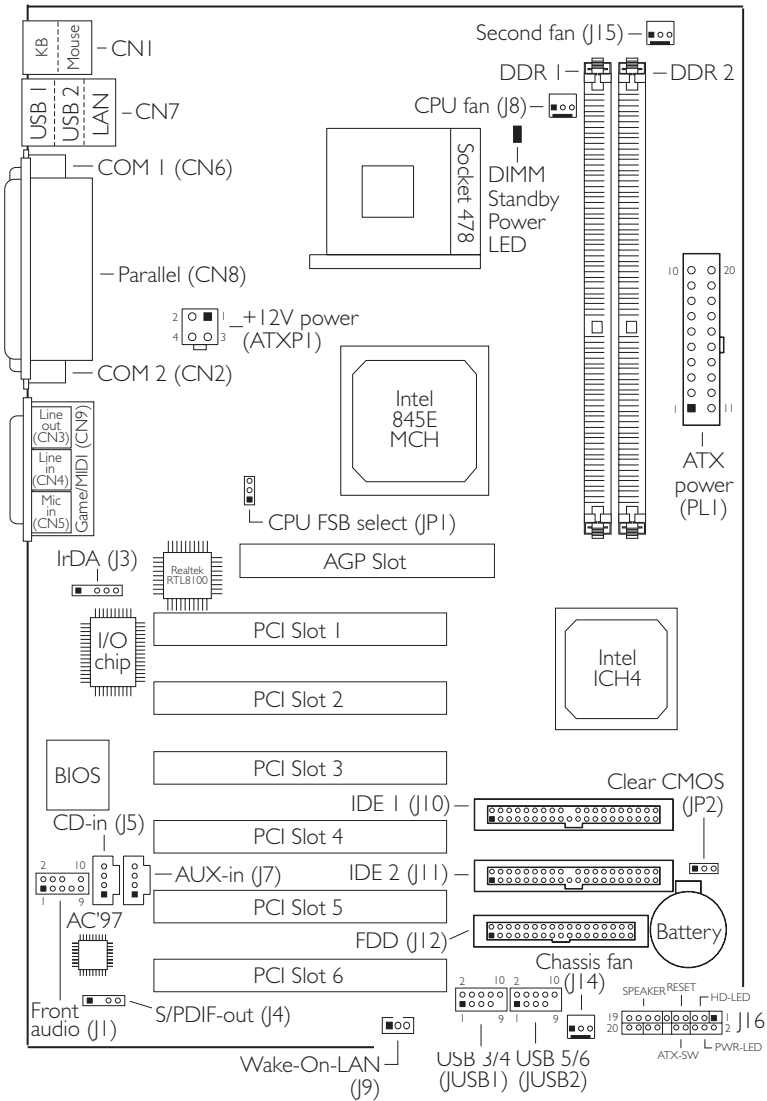

NB73-BL

(Supports onboard LAN)



Note:

The illustrations on the following pages are based on the system board that supports onboard LAN.

**Warning:**

Electrostatic discharge (ESD) can damage your system board, processor, disk drives, add-in boards, and other components. Perform the upgrade instruction procedures described at an ESD workstation only. If such a station is not available, you can provide some ESD protection by wearing an antistatic wrist strap and attaching it to a metal part of the system chassis. If a wrist strap is unavailable, establish and maintain contact with the system chassis throughout any procedures requiring ESD protection.

2.2 System Memory

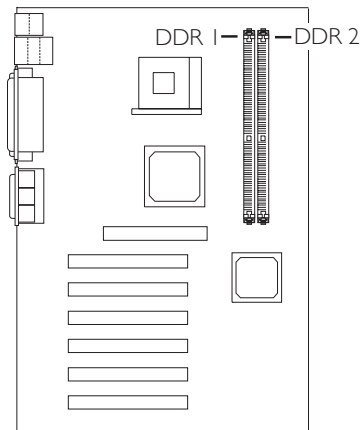

The system board is equipped with two 184-pin DDR SDRAM DIMM (Dual In-line Memory Module) sockets that support 2.5V DDR SDRAM DIMM. Double Data Rate SDRAM (DDR SDRAM) is a type of SDRAM that doubles the data rate through reading and writing at both the rising and falling edge of each clock. This effectively doubles the speed of operation therefore doubling the speed of data transfer.

Refer to chapter 1 (System Memory section) for detailed specification of the memory supported by the system board.

2.2.1 Installing the DIM Module

A DIM module simply snaps into a DIMM socket on the system board. Pin 1 of the DIM module must correspond with Pin 1 of the socket.

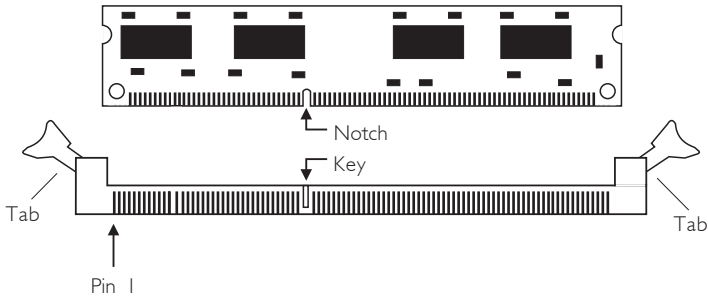

1. Pull the "tabs" which are at the ends of the socket to the side.
2. Position the DIMM above the socket with the "notch" in the module aligned with the "key" on the socket.
3. Seat the module vertically into the socket. Make sure it is completely seated. The tabs will hold the DIMM in place.

2.3 Jumper Settings for Clearing CMOS Data

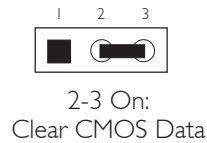
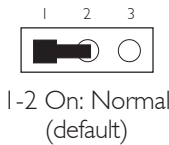
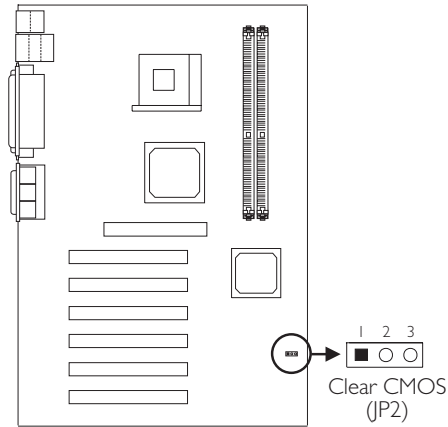

Clear CMOS Data - Jumper JP2

If you encounter the following,

- a) *CMOS data becomes corrupted.*
- b) *You forgot the supervisor or user password.*
- c) *You are unable to boot-up the computer system because the processor's ratio/clock was incorrectly set in the BIOS.*

you can reconfigure the system with the default values stored in the ROM BIOS.

To load the default values stored in the ROM BIOS, please follow the steps below.

1. Power-off the system.
2. Set JP2 pins 2 and 3 to On. Wait for a few seconds and set JP2 back to its default setting, pins 1 and 2 On.

3. Now power-on the system.

If your reason for clearing the CMOS data is due to incorrect setting of the processor's ratio/clock in the BIOS, please proceed to step 4.

4. After powering-on the system, press to enter the main menu of the BIOS.
5. Select the CPU Frequency Control submenu and press <Enter>.
6. Set the "CPU Clock Ratio" or "Clock By Slight Adjust" field to its default setting or an appropriate frequency ratio or bus clock. Refer to the CPU Frequency Control section in chapter 3 for more information.
7. Press <Esc> to return to the main menu of the BIOS setup utility. Select "Save & Exit Setup" and press <Enter>.
8. Type <Y> and press <Enter>.

2.4 Jumper Settings for Selecting the CPU's Front Side Bus

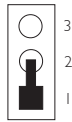
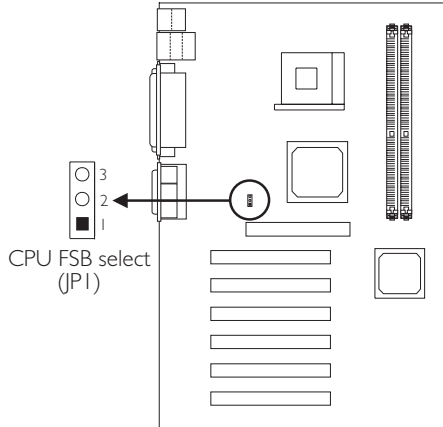

1-2 On: Auto
(default)

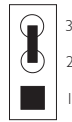

2-3 On: 100MHz

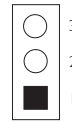

All Off: 133MHz

CPU Front Side Bus Select - Jumper JPI

This jumper is used to select the front side bus of the CPU installed on the system board.



Important:

Overclocking may result in the processor's or system's instability and is not guaranteed to provide better system performance.

2.5 Rear Panel I/O Ports

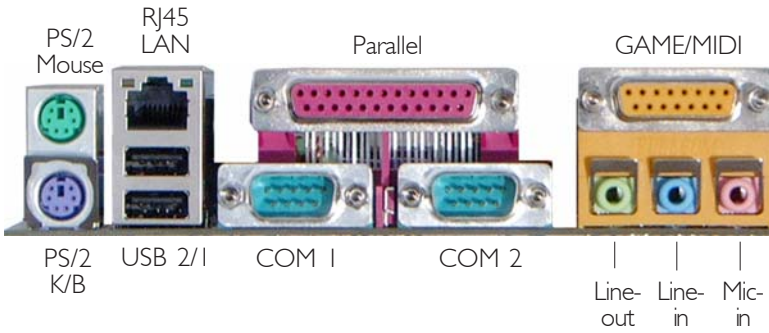

NB73-BL

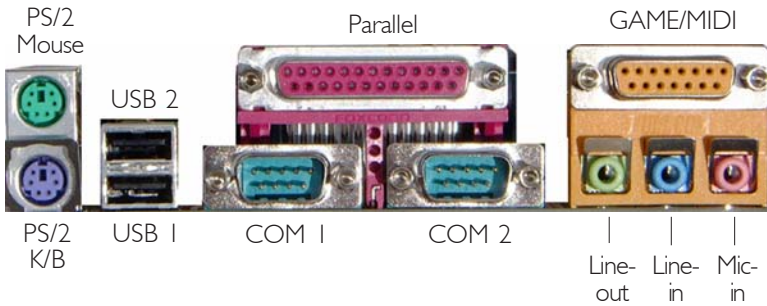

NB73-BC

2.5.1 PS/2 Mouse and PS/2 Keyboard Ports

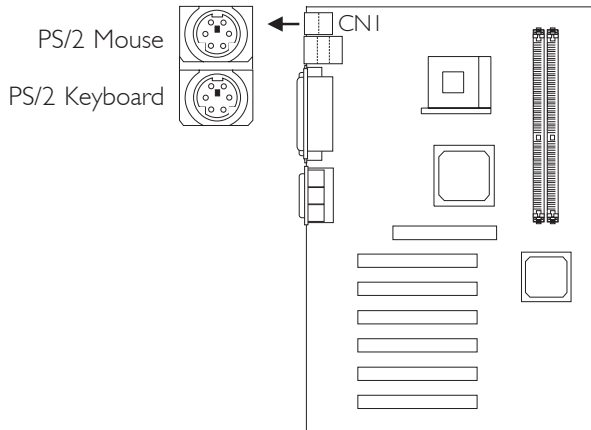

The system board is equipped with an onboard PS/2 mouse (Green) and PS/2 keyboard (Purple) ports - both at location CN1 of the ATX double deck ports of the system board. The PS/2 mouse port uses IRQ12. If a mouse is not connected to this port, the system will reserve IRQ12 for other expansion cards.

The Wake-On-Keyboard function allows you to use the keyboard to power-on the system.

To use this function:

- “Keyboard Power On” (“PM Wake Up Events” field) in the Power Management Setup of the BIOS must be set accordingly. Refer to chapter 3 for more information.



Warning:

Make sure to turn off your computer prior to connecting or disconnecting a mouse or keyboard. Failure to do so may damage the system board.

2.5.2 Universal Serial Bus Ports

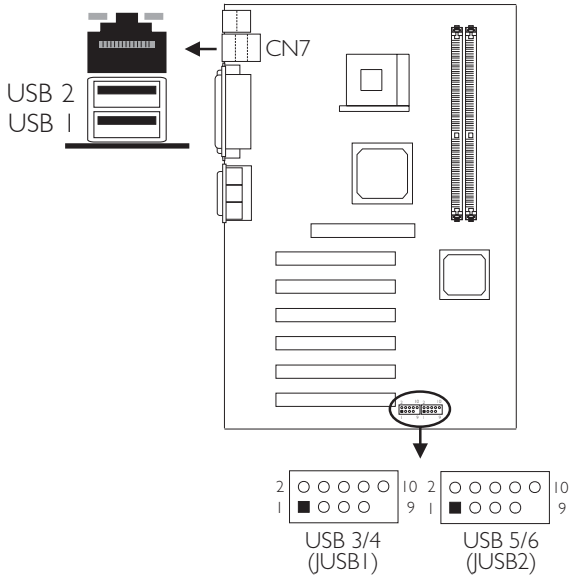

Additional USB Ports (USB 3 to USB 6)

Pin	Function	Pin	Function
1	5V_Dul	2	5V_Dul
3	Data-	4	Data-
5	Data+	6	Data+
7	Ground	8	Ground
9	Key	10	OC-

The system board supports 6 USB 2.0/1.1 ports. USB 1.1 supports 12Mb/second bandwidth while USB 2.0 supports 480Mb/second bandwidth providing a marked improvement in device transfer speeds between your computer and a wide range of simultaneously accessible external Plug and Play peripherals. You must have the proper drivers installed in your operating system to use the USB ports. Refer to your operating system's manual or documentation.

Two onboard USB 2.0/1.1 ports (CN7 - Black) are located at the ATX double deck ports of the board.

The system board is also equipped with JUSB1 and JUSB2 for connecting 4 external USB 2.0/1.1 ports. The USB 2.0/1.1 ports, which are mounted on a card-edge bracket, will be provided as an option. If you wish to use the optional USB 2.0/1.1 ports, install the card-edge bracket to the system chassis then insert the connector that is attached to the USB 2.0/1.1 port cables to JUSB1 or JUSB2. The USB ports' cable connector can be inserted only if pin 1 of the connector is aligned with pin 1 of JUSB1 or JUSB2. Now connect the interface cable connector of your USB 2.0/1.1 device to the USB 2.0/1.1 port that is on the bracket.

You can enable or disable the USB ports in the Integrated Peripherals submenu ("USB Controller" field) of the BIOS.

The Wake-On-USB Keyboard function allows you to use a USB keyboard to wake up a system that is in the S3 (STR - Suspend To RAM) state.

To use this function:

- "USB KB Wake-Up From S3" ("PM Wake Up Events" field) in the Power Management Setup submenu of the BIOS must be set to Enabled.

2.5.3 RJ45 Fast-Ethernet Port (NB73-BL only)

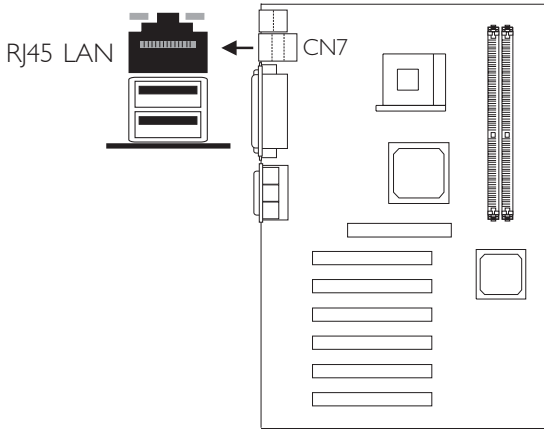

The NB73-BL system board is equipped with an onboard RJ45 fast-ethernet LAN port at location CN7 of the ATX double deck ports. It allows the system board to connect to a local area network by means of a network hub. The Realtek RTL8100 chip that controls this port can be enabled or disabled in the Integrated Peripherals submenu ("Intel OnChip PCI Device" field) of the BIOS. Refer to the Integrated Peripherals section in chapter 3 for more information.

2.5.4 Serial Ports

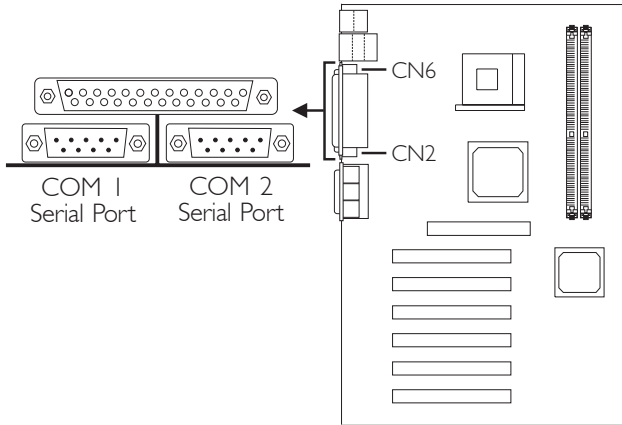

The system board is equipped with onboard serial ports (COM 1: CN6 and COM 2: CN2) - both in Teal/Turquoise color located at the ATX double deck ports of the board.

These ports are RS-232C asynchronous communication ports with 16C550A-compatible UARTs that can be used with modems, serial printers, remote display terminals, and other serial devices. You can select the port's mode in the Integrated Peripherals submenu ("Onboard Super IO Device" field) of the BIOS.

2.5.5 Parallel Port

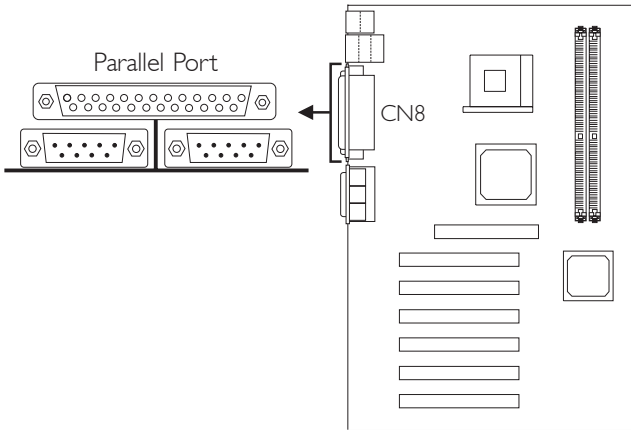

The system board has a standard parallel port (CN8 - Burgundy) located at the ATX double deck ports of the board for interfacing your PC to a parallel printer. It supports SPP, ECP, EPP and PntMode modes. You can select the port's mode in the Integrated Peripherals submenu ("Onboard Super IO Device" field) of the BIOS.

Setting	Function
SPP (Standard Parallel Port)	Allows normal speed operation but in one direction only.
ECP (Extended Capabilities Port)	Allows parallel port to operate in bidirectional mode and at a speed faster than the SPP's data transfer rate.
EPP (Enhanced Parallel Port)	Allows bidirectional parallel port operation at maximum speed.
PntMode	Allows parallel port to operate in bipolar mode.

2.5.6 Game/MIDI Port

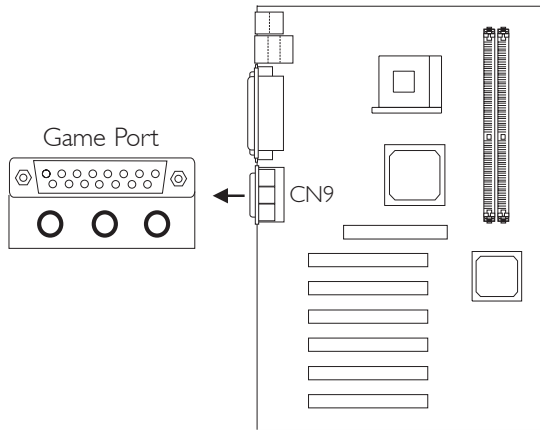

The Game/MIDI port is identical to that of a standard PC game adapter or game I/O port. Connect an analog joystick to the 15-pin D-sub connector (CN9 - Gold) located at the ATX double deck ports of the system board. This port works well with any application that is compatible with the standard PC joystick. You can configure the game port in the Integrated Peripherals submenu ("Onboard Super IO Device" field) of the BIOS.

2.5.7 Audio Jacks

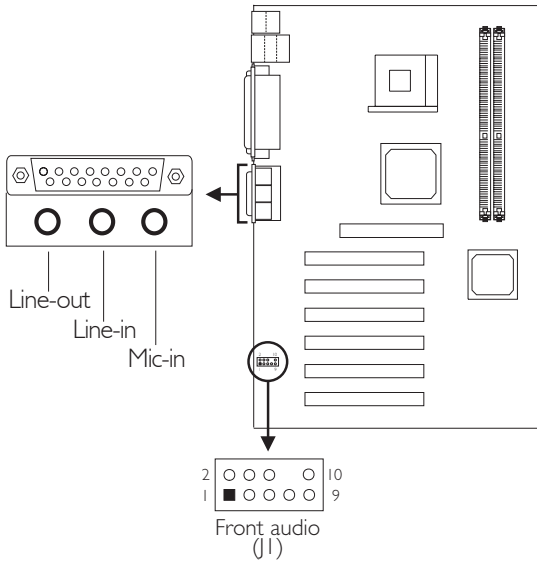

Front Audio (J1)

Pin	Function	Pin	Function
1	Mic+	2	Ground
3	Vbias	4	AuD_Vcc (Avcc)
5	AuD_R_Out	6	N. C.
7	N. C.	8	Key
9	AuD_L_Out	10	N. C.

Onboard Audio Jacks

The system board is equipped with 3 audio jacks. A jack is a one-hole connecting interface for inserting a plug.

Line-out Jack (CN3 - Lime)

This jack is used to connect external speakers for audio output from the system board.

Line-in Jack (CN4 - Light Blue)

This jack can be connected to the line-out jack of any external audio devices such as Hi-fi set, CD player, AM/FM radio tuner, synthesizer, etc. Connect a stereo cable from the line-out jack of your external device to this line-in jack.

Mic-in Jack (CN5 - Pink)

Connect a microphone to the mic-in jack.

Front Audio (J1)

J1 provides you the option of connecting another line-out and mic-in jacks.

2.6 I/O Connectors

2.6.1 Internal Audio Connectors

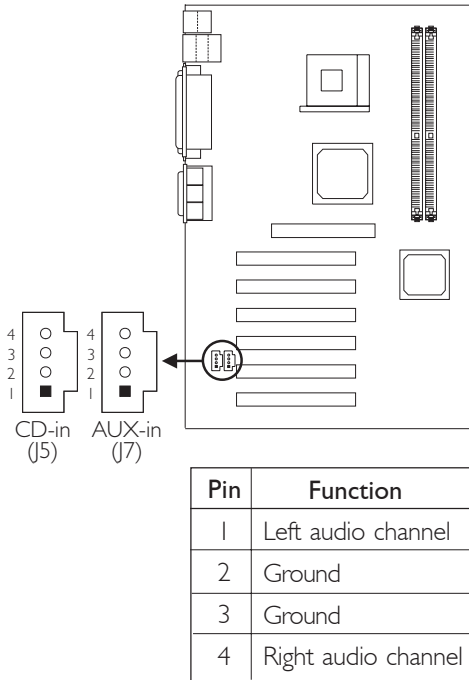

The CD-in and AUX-in connectors are used to receive audio from a CD-ROM drive, TV tuner or MPEG card.

2.6.2 S/PDIF-out Connector

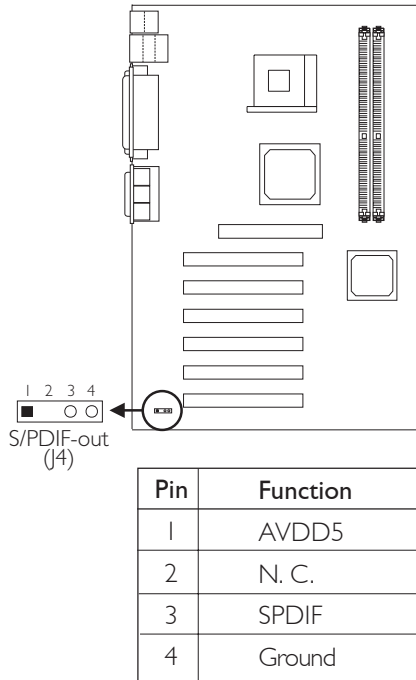

The system board is equipped with the S/PDIF (Sony/Philips Digital Interface) digital audio interface. S/PDIF is a standard audio file transfer format that transfers digital audio signals to a device without having to be converted first to an analog format. This prevents the quality of the audio signal from degrading whenever it is converted to analog.

One card-edge bracket, mounted with the S/PDIF port, will be provided as an option. Install the card-edge bracket to the system chassis then connect the audio cable connector to J4. Make sure pin 1 of the cable connector is aligned with pin 1 of J4. Now connect external speakers or a device that supports digital output to the S/PDIF port that is on the bracket.

2.6.3 Floppy Disk Drive Connector

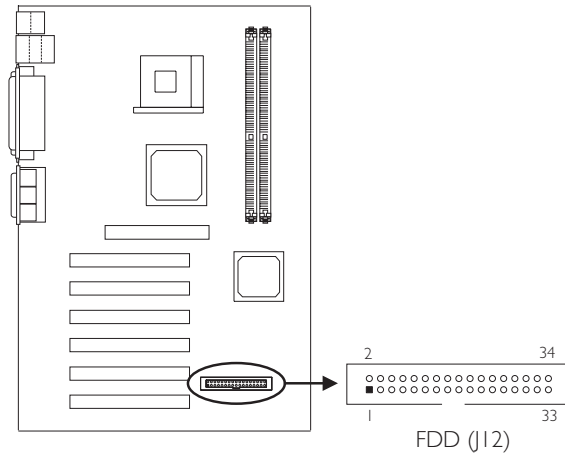

The system board is equipped with a shrouded floppy disk drive connector that supports two standard floppy disk drives. To prevent improper floppy cable installation, the shrouded floppy disk header has a keying mechanism. The 34-pin connector on the floppy cable can be placed into the header only if pin 1 of the connector is aligned with pin 1 of the header. You can enable or disable this function in the Integrated Peripherals submenu ("Onboard Super IO Device" field) of the BIOS.

Connecting the Floppy Disk Drive Cable

1. Install the 34-pin header connector of the floppy disk drive cable into the shrouded floppy disk header (J12) on the system board. The colored edge of the ribbon should be aligned with pin 1 of J12.
2. Install the other 34-pin header connector(s) into the disk drive(s). Align the colored edge of the daisy chained ribbon cable with pin 1 of the drive edge connector(s). The end-most connector should be attached to the drive you want to designate as Drive A.

2.6.4 IDE Disk Drive Connector

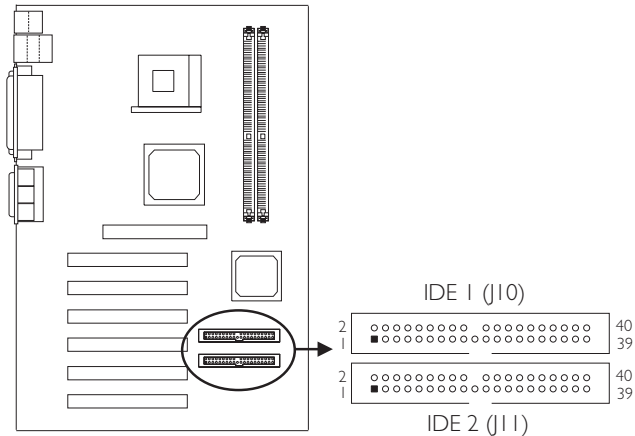

The system board is equipped with two shrouded PCI IDE headers that will interface four Enhanced IDE (Integrated Drive Electronics) disk drives. To prevent improper IDE cable installation, each shrouded PCI IDE header has a keying mechanism. The 40-pin connector on the IDE cable can be placed into the header only if pin 1 of the connector is aligned with pin 1 of the header. You can enable or disable the onboard primary or secondary IDE controller in the Integrated Peripherals submenu ("INTEL OnChip IDE Device" field) of the BIOS.

Connecting the IDE Disk Drive Cable

1. If you are connecting two IDE drives, install the 40-pin connector of the IDE cable into the primary shrouded IDE header (IDE 1 - J10). If you are adding a third or fourth IDE device, install the 40-pin connector of the other IDE cable into the secondary shrouded IDE header (IDE 2 - J11).
2. Install the other 40-pin header connector(s) into the device with the colored edge of the ribbon cable aligned with pin 1 of the drive edge connector(s).



Note:

Refer to your disk drive user's manual for information about selecting proper drive switch settings.

Adding a Second IDE Disk Drive

When using two IDE drives, one must be set as the master and the other as the slave. Follow the instructions provided by the drive manufacturer for setting the jumpers and/or switches on the drives.

The system board supports Enhanced IDE or ATA-2, ATA/33, ATA/66 or ATA/100 hard drives. We recommend that you use hard drives from the same manufacturer. In a few cases, drives from two different manufacturers will not function properly when used together. The problem lies in the hard drives, not the system board.



Important:

If you encountered problems while using an ATAPI CD-ROM drive that is set in Master mode, please set the CD-ROM drive to Slave mode. Some ATAPI CD-ROMs may not be recognized and cannot be used if incorrectly set in Master mode.

2.6.5 IrDA Connector

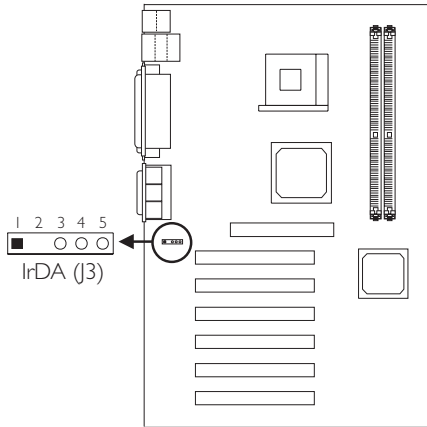

Pin	Function
1	VCC
2	N. C.
3	IRRX
4	Ground
5	IRTX

The system board is equipped with an IrDA connector for wireless connectivity between your computer and peripheral devices. The IRDA (Infrared Data Association) specification supports data transfers of 115K baud at a distance of 1 meter.

Connect your IrDA cable to connector J3 on the system board. Set “UART2 Mode Select” (“Onboard Super IO Device” field) in the Integrated Peripherals submenu of the BIOS to the type of IrDA standard supported by your device. You must have the proper drivers installed in your operating system to use this connector. Refer to your operating system’s manual or documentation.



Note:

The sequence of the pin functions on some IrDA cable may be reversed from the pin function defined on the system board. Make sure to connect the cable to the IrDA connector according to their pin functions.

2.6.6 CPU Fan Connector

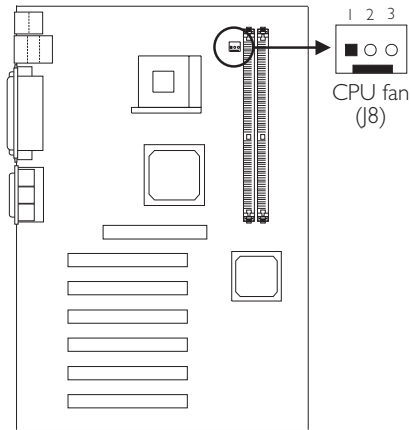

Pin	Function
1	Ground
2	Power
3	N. C.

The CPU must be kept cool by using a fan with heatsink. Connect the CPU fan to the 3-pin fan connector at location J8 on the system board.

2.6.7 Chassis Fan Connector

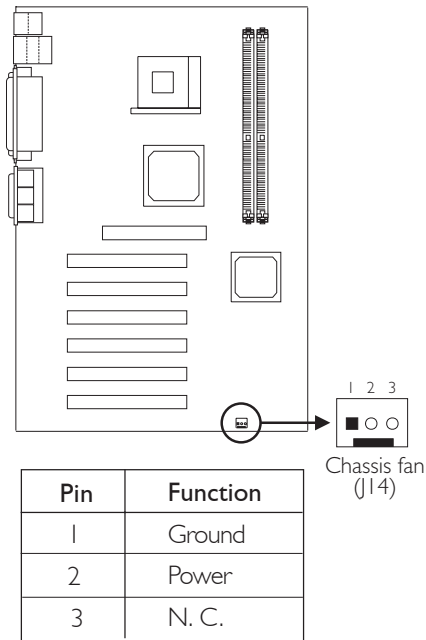

If you are installing a chassis fan in the system unit, connect the fan's connector to location J14 on the system board. The fan will provide adequate airflow throughout the chassis to prevent overheating the CPU.

2.6.8 Second Fan Connector

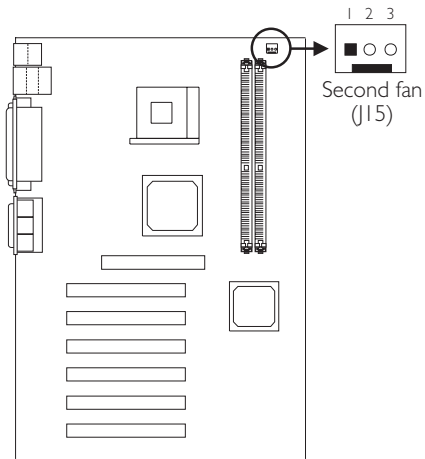

Pin	Function
1	Ground
2	Power
3	N. C.

If you are installing a second fan in the system unit, connect the fan's connector to location J15 on the system board.

2.6.9 Wake-On-LAN Connector

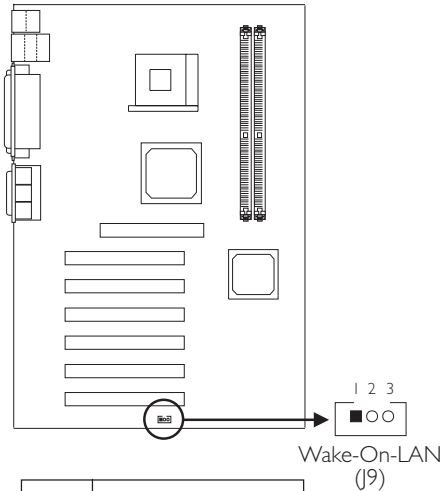

The Wake-On-LAN function is applicable only when you are using a LAN add-in card that has the same function. It will allow the network to remotely power-on a Soft Power Down (Soft-Off) PC. However, if your system is in the Suspend mode, you can power-on the system only through an IRQ or DMA interrupt.

To use the Wake-On-LAN function, you must enable the “Resume on LAN” (“PM Wake Up Events” field) in the Power Management Setup of the BIOS. Your LAN card package should include a cable. Connect one end of the cable to the wakeup header on the card and the other end to location J9 on the system board. The network will detect Magic Packet and assert a wakeup signal to power-up the system. Refer to the add-in card’s manual for details. Note: Your LAN card must support the remote wake up function.



Important:

The 5VSB power source of your power supply must support $\geq 720\text{mA}$.

2.6.10 DIMM Standby Power LED

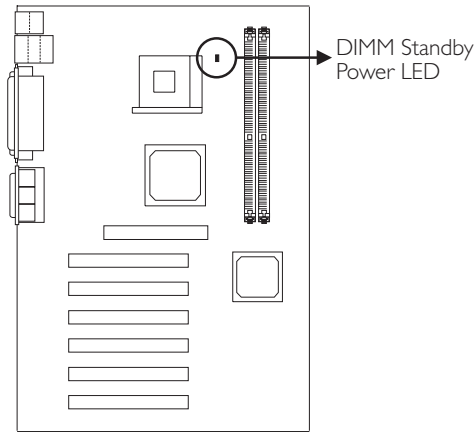

The DIMM Standby Power LED will turn red when the system's power is on or when it is in the Suspend state (Power On Suspend or Suspend to RAM). It will not light when the system is in the Soft-Off state.

**Important:**

If the DIMM Standby Power LED is lighted, you must power-off the system then turn off the power supply's switch or unplug the power cord prior to installing any memory modules.

2.6.11 Power Connectors

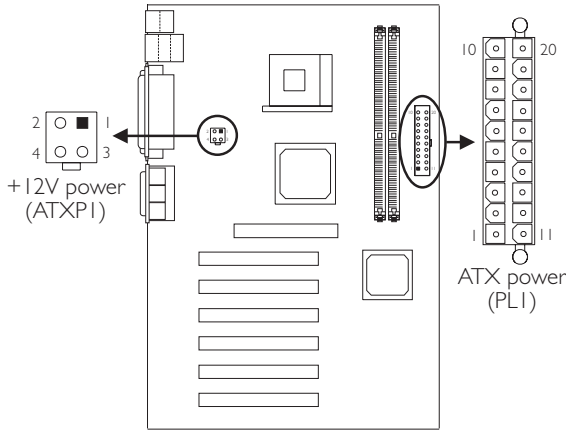

We recommend that you use a power supply that complies with the ATX12V Power Supply Design Guide Version 1.1. An ATX12V power supply has a standard 20-pin ATX main power connector and a 4-pin +12V power connector that must be inserted onto PL1 and ATXP1 connectors respectively.

The 4-pin +12V power connector enables the delivery of more +12VDC current to the processor's Voltage Regulator Module (VRM).

The system board requires a minimum of 250 Watt power supply to operate. Your system configuration (amount of memory, add-in cards, peripherals, etc.) may exceed the minimum power requirement. To ensure that adequate power is provided, use a 300 Watt (or greater) power supply.

ATX Main Power Connector

Pin	Function	Pin	Function
1	3.3V	11	3.3V
2	3.3V	12	-12V
3	Ground	13	Ground
4	+5V	14	PS-ON
5	Ground	15	Ground
6	+5V	16	Ground
7	Ground	17	Ground
8	PW-OK	18	-5V
9	5VSB	19	+5V
10	+12V	20	+5V

+12V Power Connector

Pin	Function
1	Ground
2	Ground
3	+12V
4	+12V

2.6.12 Front Panel Connectors

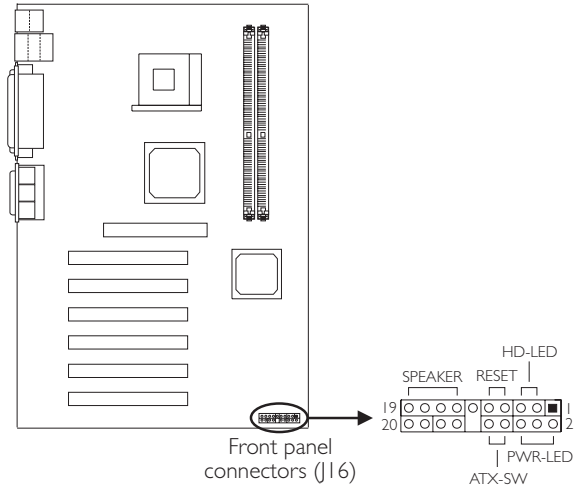

HD-LED: Primary/Secondary IDE LED

This LED will light when the hard drive is being accessed.

RESET: Reset Switch

This switch allows you to reboot without having to power off the system thus prolonging the life of the power supply or system.

SPEAKER: Speaker Connector

This connects to the speaker installed in the system chassis.

ATX-SW: ATX Power Switch

Depending on the setting in the BIOS setup, this switch is a “dual function power button” that will allow your system to enter the Soft-Off or Suspend mode. Refer to “Soft-Off By PWR-BTTN” in the Power Management Setup (Chapter 3).

PWR-LED: Power/Standby LED

When the system's power is on, this LED will light. When the system is in the S1 (POS - Power On Suspend) state, it will blink every second. When the system is in the S3 (STR - Suspend To RAM) state, it will blink every 4 seconds.

**Note:**

If a system did not boot-up and the Power/Standby LED did not light after it was powered-on, it may indicate that the CPU or memory module was not installed properly. Please make sure they are properly inserted into their corresponding socket.

	Pin	Pin Assignment
HD-LED (Primary/Secondary IDE LED)	3 5	HDD LED Power HDD
Reserved	14 16	N. C. N. C.
ATX-SW (ATX power switch)	8 10	PWRBT+ PWRBT-
Reserved	18 20	N. C. N. C.
RESET (Reset switch)	7 9	Ground H/W Reset
SPEAKER (Speaker connector)	13 15 17 19	Speaker Data N. C. Ground Speaker Power
PWR-LED (Power/Standby LED)	2 4 6	LED Power (+) LED Power (+) LED Power (-) or Standby Signal

Phoenix - AwardBIOS CMOS Setup Utility
Standard CMOS Features

		Item Help
Date (mm:dd:yy)	Fri, Oct 11 2002	Menu Level
Time (hh:mm:ss)	4 : 35 : 5	
▶ IDE Primary Master	Press Enter None	Change the day, month, year and century
▶ IDE Primary Slave	Press Enter None	
▶ IDE Secondary Master	Press Enter None	
▶ IDE Secondary Slave	Press Enter None	
Drive A	1.44M, 3.5 in.	
Drive B	None	
Video	EGA/VGA	
Halt On	All, But Keyboard	
Base Memory	640K	
Extended Memory	129024K	
Total Memory	130048K	
↑↓→← Move Enter:Select +/-/PU/PD:Value F10:Save ESC:Exit F1:General Help F5:Previous Values F6:Fail-Safe Defaults F7:Optimized Defaults		

The settings on the screen are for reference only. Your version may not be identical to this one.

3.1.1.1 Date

The date format is <day>, <month>, <date>, <year>. Day displays a day, from Sunday to Saturday. Month displays the month, from January to December. Date displays the date, from 1 to 31. Year displays the year, from 1994 to 2079.

3.1.1.2 Time

The time format is <hour>, <minute>, <second>. The time is based on the 24-hour military-time clock. For example, 1 p.m. is 13:00:00. Hour displays hours from 00 to 23. Minute displays minutes from 00 to 59. Second displays seconds from 00 to 59.

3.1.1.3 IDE Primary Master, IDE Primary Slave, IDE Secondary Master and IDE Secondary Slave

Move the cursor to the "IDE Primary Master", "IDE Primary Slave", "IDE Secondary Master" or "IDE Secondary Slave" field, then press <Enter>.

Capacity

Displays the approximate capacity of the disk drive. Usually the size is slightly greater than the size of a formatted disk given by a disk checking program.

Cylinder

This field displays the number of cylinders.

Head

This field displays the number of read/write heads.

Precomp

This field displays the number of cylinders at which to change the write timing.

Landing Zone

This field displays the number of cylinders specified as the landing zone for the read/write heads.

Sector

This field displays the number sectors per track.

3.1.1.4 Drive A and Drive B

These fields identify the types of floppy disk drives installed.

<i>None</i>	No floppy drive is installed
<i>360K, 5.25 in.</i>	5-1/4 in. standard drive; 360KB capacity
<i>1.2M, 5.25 in.</i>	5-1/4 in. AT-type high-density drive; 1.2MB capacity
<i>720K, 3.5 in.</i>	3-1/2 in. double-sided drive; 720KB capacity
<i>1.44M, 3.5 in.</i>	3-1/2 in. double-sided drive; 1.44MB capacity
<i>2.88M, 3.5 in.</i>	3-1/2 in. double-sided drive; 2.88MB capacity

3.1.1.5 Video

This field selects the type of video adapter used for the primary system monitor. Although secondary monitors are supported, you do not have to select the type. The default setting is EGA/VGA.

<i>EGA/VGA</i>	Enhanced Graphics Adapter/Video Graphics Array. For EGA, VGA, SVGA and PGA monitor adapters.
<i>CGA 40</i>	Color Graphics Adapter. Power up in 40-column mode.
<i>CGA 80</i>	Color Graphics Adapter. Power up in 80-column mode.
<i>Mono</i>	Monochrome adapter. Includes high resolution monochrome adapters.

3.1.1.6 Halt On

This field determines whether the system will stop if an error is detected during power up. The default setting is All Errors.

<i>No Errors</i>	The system boot will not stop for any errors detected.
<i>All Errors</i>	The system boot will stop whenever the BIOS detects a non-fatal error.
<i>All, But Keyboard</i>	The system boot will not stop for a keyboard error; it will stop for all other errors.
<i>All, But Diskette</i>	The system boot will not stop for a disk error; it will stop for all other errors.
<i>All, But Disk/Key</i>	The system boot will not stop for a disk or keyboard error; it will stop for all other errors.

3.1.1.7 Base Memory

Displays the amount of base (or conventional) memory installed in the system. The value of the base memory is typically 512K for systems with 512K memory installed on the motherboard or 640K for systems with 640K or more memory installed on the motherboard.

3.1.1.8 Extended Memory

Displays the amount of extended memory detected during boot-up.

3.1.1.9 Total Memory

Displays the total memory available in the system.

3.1.2 Advanced BIOS Features

The Advanced BIOS Features allows you to configure your system for basic operation. Some entries are defaults required by the system board, while others, if enabled, will improve the performance of your system or let you set some features according to your preference.

Phoenix - AwardBIOS CMOS Setup Utility
Advanced BIOS Features

		Item Help
BIOS Flash Protect	Disabled	
Virus Warning	Disabled	
CPU L1 & L2 Cache	Enabled	Menu Level
CPU Hyper-Threading	Enabled	
Quick Power On Self Test	Fast	Allows you to choose the VIRUS warning feature for IDE Hard Disk boot sector protection. If this function is enabled and someone attempt to write data into this area, BIOS will show a warning message on screen and alarm beep
First Boot Device	Floppy	
Second Boot Device	CDROM	
Third Boot Device	HDD-0	
Boot Other Device	Enabled	
Swap Floppy Drive	Disabled	
Boot Up Floppy Seek	Enabled	
Boot Up NumLock Status	On	
Typeomatic Rate Setting	Disabled	
X Typeomatic Rate (Chars/Sec)	6	
X Typeomatic Delay (Msec)	250	
Security Option	Setup	
APIC Mode	Enabled	
MPS Version Control For OS	1.4	
OS Select For DRAM > 64MB	Non-OS2	
HDD S.M.A.R.T. Capability	Disabled	
Full Screen Logo Show	Enabled	
Small Logo (EPA) Show	Enabled	

Exit F1:General Help
F7:Optimized Defaults

The screen above list all the fields available in the Advanced BIOS Features submenu, for ease of reference in this manual. In the actual CMOS setup, you have to use the scroll bar to view the fields. The settings on the screen are for reference only. Your version may not be identical to this one.

3.1.2.1 BIOS Flash Protect

Enabled This option will protect the system from unnecessary updating or flashing of the BIOS. When enabled, it secures the BIOS therefore any updates to the BIOS will not take effect.

Disabled Disables the "BIOS flash protect" function, allowing you to update or flash the BIOS any time needed.

3.1.2.2 Virus Warning

This field protects the boot sector and partition table of your hard disk drive. When this field is enabled, the Award BIOS will monitor the boot sector and partition table of the hard disk drive. If an attempt is made to write to the boot sector or partition table of the hard disk drive, the BIOS will halt the system and an error message will appear.

After seeing the error message, if necessary, you will be able to run an anti-virus program to locate and remove the problem before any damage is done.

Many disk diagnostic programs which attempt to access the boot sector table will cause the warning message to appear. If you are running such a program, we recommend that you first disable this field. Also, disable this field if you are installing or running certain operating systems like Windows® 98SE/2000/ME/XP or the operating system may not install nor work.

3.1.2.3 CPU L1 & L2 Cache

This field speeds up the memory access.

3.1.2.4 CPU Hyper-Threading (for Intel® Pentium® 4 Processor with Hyper-Threading Technology)

This field is used to enable the functionality of the Intel® Pentium® 4 Processor with Hyper-Threading Technology and will appear only when using this processor.

3.1.2.5 Quick Power On Self Test

This field speeds up Power On Self Test (POST) whenever the system is powered on. The BIOS will shorten or skip some check items during POST. To attain the shortest POST time, select "Fast".

3.1.2.6 First Boot Device, Second Boot Device, Third Boot Device and Boot Other Device

Select the drive to boot first, second and third in the "First Boot Device" "Second Boot Device" and "Third Boot Device" fields respectively. The BIOS will boot the operating system according to the sequence of the drive selected. Set "Boot Other Device" to Enabled if you wish to boot from another device.

3.1.2.7 Swap Floppy Drive

When this field is enabled and the system is booting from the floppy drive, the system will boot from drive B instead of drive A. When this field is disabled and the system is booting from the floppy drive, the system will boot from drive A. You must have two floppy drives to use this function.

3.1.2.8 Boot Up Floppy Seek

When enabled, the BIOS will check whether the floppy disk drive installed is 40 or 80 tracks. Note that the BIOS cannot distinguish between 720K, 1.2M, 1.44M and 2.88M drive types as they are all 80 tracks. When disabled, the BIOS will not search for the type of floppy disk drive by track number. Note that there will not be any warning message if the drive installed is 360KB.

3.1.2.9 Boot Up NumLock Status

This allows you to determine the default state of the numeric keypad. By default, the system boots up with NumLock on wherein the function of the numeric keypad is the number keys. When set to Off, the function of the numeric keypad is the arrow keys.

3.1.2.10 Typematic Rate Setting

Disabled Continually holding down a key on your keyboard will cause the BIOS to report that the key is down.

Enabled The BIOS will not only report that the key is down, but will first wait for a moment, and, if the key is still down, it will begin to report that the key has been depressed repeatedly. For example, you would use such a feature to accelerate cursor movements with the arrow keys. You can then select the typematic rate and typematic delay in the "Typematic Rate (Chars/Sec)" and "Typematic Delay (Msec)" fields below.

Award BIOS Setup Utility

3.1.2.11 Typematic Rate (Chars/Sec)

This field allows you to select the rate at which the keys are accelerated.

3.1.2.12 Typematic Delay (Msec)

This field allows you to select the delay between when the key was first depressed and when the acceleration begins.

3.1.2.13 Security Option

This field determines when the system will prompt for the password - everytime the system boots or only when you enter the BIOS setup. Set the password in the Set Supervisor/User Password submenu.

System The system will not boot and access to Setup will be denied unless the correct password is entered at the prompt.

Setup The system will boot, but access to Setup will be denied unless the correct password is entered at the prompt.

3.1.2.14 APIC Mode

Leave this field in its default setting.

3.1.2.15 MPS Version Control for OS

This field is used to select the MPS version that the system board is using.

3.1.2.16 OS Select for DRAM > 64MB

This field allows you to access the memory that is over 64MB in OS/2.

3.1.2.17 HDD S.M.A.R.T. Capability

The system board supports SMART (Self-Monitoring, Analysis and Reporting Technology) hard drives. SMART is a reliability prediction technology for ATA/IDE and SCSI drives. The drive will provide sufficient notice to the system or user to backup data prior to the drive's failure. The default is Disabled. If you are using hard drives that support S.M.A.R.T., set this field to Enabled. SMART is supported in ATA/33 or later hard drives.

3.1.2.18 Full Screen Logo Show

This field is applicable only if you want a particular logo to appear during system boot-up.

Enabled The logo will appear in full screen during system boot-up.

Disabled The logo will not appear during system boot-up.

3.1.2.19 Small Logo(EPA) Show

Enabled The EPA logo will appear during system boot-up.

Disabled The EPA logo will not appear during system boot-up.

3.1.3 Advanced Chipset Features

Phoenix - AwardBIOS CMOS Setup Utility
Advanced Chipset Features

		Item Help
DRAM Timing Selectable	By SPD	Menu Level
CAS Latency Time	3	
Active to Precharge Delay	7	
DRAM RAS# to CAS# Delay	3	
DRAM RAS# Precharge	3	
Memory Frequency For System BIOS Cacheable	Auto	
Video BIOS Cacheable	Disabled	
Delayed Transaction	Enabled	
AGP Aperture Size (MB)	64	
AGP 4X Mode	Enabled	
↑↓→← Move Enter:Select +/-/PU/PD: Value F10:Save ESC:Exit F1:General Help F5:Previous Values F6:Fail-Safe Defaults F7:Optimized Defaults		

The settings on the screen are for reference only. Your version may not be identical to this one.

This section gives you functions to configure the system based on the specific features of the chipset. The chipset manages bus speeds and access to system memory resources. **These items should not be altered unless necessary.** The default settings have been chosen because they provide the best operating conditions for your system. The only time you might consider making any changes would be if you discovered some incompatibility or that data was being lost while using your system.

3.1.3.1 DRAM Timing Selectable

This field is used to select the timing of the DRAM.

By SPD The EEPROM on a DIMM has SPD (Serial Presence Detect) data structure that stores information about the module such as the memory type, memory size, memory speed, etc. When this option is selected, the system will run according to the information in the EEPROM. This option is the default setting because it provides the most stable condition for the system. The “CAS Latency Time” to “DRAM RAS# Precharge” fields will show the default settings by SPD.

By User If you want better system performance other than the one “by SPD”, select “By User”. Then select the best option in the “CAS Latency Time” to “DRAM RAS# Precharge” fields.

3.1.3.2 CAS Latency Time

This field is used to select the local memory clock periods.

3.1.3.3 Active to Precharge Delay

The options are 5, 6 and 7.

3.1.3.4 DRAM RAS# to CAS# Delay

The options are 2 and 3.

3.1.3.5 DRAM RAS# Precharge

This field controls RAS# precharge (in local memory clocks).

3.1.3.6 Memory Frequency For

This field is used to select the memory clock speed of the DIMM.

3.1.3.7 System BIOS Cacheable

When this field is enabled, accesses to the system BIOS ROM addressed at F0000H-FFFFFH are cached, provided that the cache controller is enabled. The larger the range of the Cache RAM, the higher the efficiency of the system.

3.1.3.8 Video BIOS Cacheable

As with caching the system BIOS, enabling the Video BIOS cache will allow access to video BIOS addressed at C0000H to C7FFFH to be cached, if the cache controller is also enabled. The larger the range of the Cache RAM, the faster the video performance.

3.1.3.9 Delayed Transaction

When enabled, this function frees up the PCI bus for other PCI masters during the PCI-to-ISA transactions. This allows PCI and ISA buses to be used more efficiently and prevents degradation of performance on the PCI bus when ISA accesses are made.

3.1.3.10 AGP Aperture Size (MB)

This field is relevant to the memory-mapped graphics data of the AGP card installed in your system. Leave this in its default setting.

3.1.3.11 AGP 4X Mode

This field is used to enable the AGP 4x interface which transfers video data at 1066MB/sec. bandwidth thus delivering faster and better graphics to your PC. Make sure your graphics card supports the AGP 4x mode.

3.1.4 Integrated Peripherals

Phoenix - AwardBIOS CMOS Setup Utility
Integrated Peripherals

<ul style="list-style-type: none"> ▶ INTEL OnChip IDE Device Press Enter ▶ INTEL OnChip PCI Device Press Enter ▶ Onboard Super IO Device Press Enter USB Controller USB 2.0 Disabled USB Keyboard Support Disabled Init Display First AGP 	Item Help Menu Level
↑↓→← Move Enter:Select +/-/PU/PD:Value F10:Save ESC:Exit F1:General Help F5:Previous Values F6:Fail-Safe Defaults F7:Optimized Defaults	

The settings on the screen are for reference only. Your version may not be identical to this one.

3.1.4.1 INTEL OnChip IDE Device

Move the cursor to this field and press <Enter>. The following screen will appear:

Phoenix - AwardBIOS CMOS Setup Utility
INTEL OnChip IDE Device

On-Chip Primary PCI IDE Enabled IDE Primary Master PIO Auto IDE Primary Slave PIO Auto IDE Primary Master UDMA Auto IDE Primary Slave UDMA Auto On-Chip Secondary PCI IDE Enabled IDE Secondary Master PIO Auto IDE Secondary Slave PIO Auto IDE Secondary Master UDMA Auto IDE Secondary Slave UDMA Auto IDE HDD Block Mode Enabled	Item Help Menu Level
↑↓→← Move Enter:Select +/-/PU/PD:Value F10:Save ESC:Exit F1:General Help F5:Previous Values F6:Fail-Safe Defaults F7:Optimized Defaults	

The settings on the screen are for reference only. Your version may not be identical to this one.

On-Chip Primary PCI IDE and On-Chip Secondary PCI IDE

These fields allow you to enable or disable the primary and secondary IDE controller. Select Disabled if you want to add a different hard drive controller.

IDE Primary Master/Slave PIO and IDE Secondary Master/Slave PIO

PIO means Programmed Input/Output. Rather than have the BIOS issue a series of commands to effect a transfer to or from the disk drive, PIO allows the BIOS to tell the controller what it wants and then let the controller and the CPU perform the complete task by themselves. Your system supports five modes, 0 (default) to 4, which primarily differ in timing. When Auto is selected, the BIOS will select the best available mode after checking your drive.

- | | |
|-----------------|--|
| <i>Auto</i> | The BIOS will automatically set the system according to your hard disk drive's timing. |
| <i>Mode 0-4</i> | You can select a mode that matches your hard disk drive's timing. Caution: Do not use the wrong setting or you will have drive errors. |

IDE Primary Master/Slave UDMA and IDE Secondary Master/Slave UDMA

These fields allow you to set the Ultra DMA in use. When Auto is selected, the BIOS will select the best available option after checking your hard drive or CD-ROM.

- | | |
|-----------------|--|
| <i>Auto</i> | The BIOS will automatically detect the settings for you. |
| <i>Disabled</i> | The BIOS will not detect these categories. |

IDE HDD Block Mode

- | | |
|-----------------|--|
| <i>Enabled</i> | The IDE HDD uses the block mode. The system BIOS will check the hard disk drive for the maximum block size the system can transfer. The block size will depend on the type of hard disk drive. |
| <i>Disabled</i> | The IDE HDD uses the standard mode. |

3.1.4.3 Onboard Super IO Device

Move the cursor to this field and press <Enter>. The following screen will appear:

Phoenix - AwardBIOS CMOS Setup Utility		
Onboard Super IO Device		
		Item Help
KBC Input Clock	12MHz	
Onboard FDC Controller	Enabled	
Onboard Serial Port 1	3F8/IRQ4	Menu Level
Onboard Serial Port 2	2F8/IRQ3	
UART2 Mode Select	Normal	
X RxD, TxD Active	Hi,Lo	
X IR Transmission Delay	Enabled	
Onboard Parallel Port	378/IRQ7	
Parallel Port Mode	ECP+EPP	
EPP Mode Select	EPP 1.7	
ECP Mode Use DMA	3	
Game Port Address	201	
Midi Port Address	Disabled	
X Midi Port IRQ	10	
↑↓←→ Move Enter:Select +/-/PU/PD:Value F10:Save ESC:Exit F1:General Help F5:Previous Values F6:Fail-Safe Defaults F7:Optimized Defaults		

The settings on the screen are for reference only. Your version may not be identical to this one.

KBC Input Clock

This is used to select the input clock of your keyboard.

Onboard FDC Controller

- Enabled* Enables the onboard floppy disk controller:
- Disabled* Disables the onboard floppy disk controller:

Onboard Serial Port 1 and Onboard Serial Port 2

- Auto* The system will automatically select an I/O address for the onboard serial port 1 and serial port 2.
- 3F8/IRQ4, 2F8/IRQ3, 3E8/IRQ4, 2E8/IRQ3* Allows you to manually select an I/O address for the onboard serial port 1 and serial port 2.
- Disabled* Disables the onboard serial port 1 and/or serial port 2.

UART2 Mode Select

The system board supports IrDA function for wireless connectivity between your computer and peripheral devices. You may not use IrDA (J3) and the COM 2 serial port (J6) at the same time. If you are using the COM 2 serial port, make sure this field is set to Normal.

To use the IrDA function, follow the steps below.

1. Connect your IrDA cable to connector J3 on the system board.
2. Set the "UART2 Mode Select" field to the type of IrDA standard supported by your IrDA peripheral/device (IrDA or ASKIR). For better transmission of data, your IrDA peripheral device must be within a 30° angle and within a distance of 1 meter.
3. Set the "RxD, TxD Active" and "IR Transmission Delay" fields appropriately.

RxD, TxD Active

The options are Hi, Lo; Lo, Hi; Lo, Lo; and Hi, Hi.

IR Transmission Delay

If this field is Enabled, transmission of data will be slower. This is recommended when you encounter transmission problem with your device.

Onboard Parallel Port

- 378/IRQ7, 3BC/IRQ7, 278/IRQ5* Selects the I/O address and IRQ for the onboard parallel port.
- Disabled* Disables the onboard parallel port.

Parallel Port Mode

The options are SPP, EPP, ECP, ECP+EPP and PntMode. These apply to a standard specification and will depend on the type and speed of your device. Refer to your peripheral's manual for the best option.

SPP

Allows normal speed operation but in one direction only.

ECP (Extended Capabilities Port)

Allows parallel port to operate in bidirectional mode and at a speed faster than the normal mode's data transfer rate.

EPP (Enhanced Parallel Port)

Allows bidirectional parallel port operation at maximum speed.

PntMode

Allows parallel port to operate in bipolar mode.

If you selected EPP, the "EPP Mode Select" field is configurable. If you selected ECP, the "ECP Mode Use DMA" field is configurable. If you selected ECP+EPP, both "EPP Mode Select" and "ECP Mode Use DMA" are configurable.

EPP Mode Select

This is used to select the EPP mode.

ECP Mode Use DMA

This is used to select the DMA channel of the parallel port.

Game Port Address

This field is used to select the game port's address.

Midi Port Address

This field is used to select the midi port's address. If you have selected the midi port's address, you may select its IRQ in the "Midi Port IRQ" field.

Midi Port IRQ

This field is used to select the midi port's IRQ.

3.1.4.4 USB Controller

<i>All Enabled</i>	Enables all USB ports.
<i>USB 2.0 Disabled</i>	USB 2.0 is disabled; USB 1.1 is enabled.
<i>All Disabled</i>	Disables all USB ports.

3.1.4.5 USB Keyboard Support

If you are using a USB keyboard under DOS, set this field to Enabled. This field can be configured only if the "USB Controller" field is enabled.

3.1.4.6 Init Display First

This field is used to select whether to initialize the AGP or PCI first when the system boots.

<i>AGP</i>	When the system boots, it will first initialize the AGP.
<i>PCI Slot</i>	When the system boots, it will first initialize PCI.

3.1.5.3 Power Management

This field allows you to select the type (or degree) of power saving by changing the length of idle time that elapses before the HDD Power Down field is activated.

<i>Min Saving</i>	Minimum power saving time for the HDD Power Down = 15 min.
<i>Max Saving</i>	Maximum power saving time for the HDD Power Down = 1 min.
<i>User Define</i>	Allows you to set the power saving time in the "HDD Power Down" field.

3.1.5.4 Video Off Method

This determines the manner in which the monitor is blanked.

<i>V/H SYNC + Blank</i>	This selection will cause the system to turn off the vertical and horizontal synchronization ports and write blanks to the video buffer.
<i>Blank Screen</i>	This option only writes blanks to the video buffer.
<i>DPMS</i>	Initializes display power management signaling. Use this option if your video board supports it.

3.1.5.5 Video Off In Suspend

This field is used to activate the video off feature when the system enters the Suspend mode.

3.1.5.6 Suspend Mode

When the system enters the Suspend mode, the CPU and onboard peripherals will be shut off.

3.1.5.7 HDD Power Down

This is selectable only when the Power Management field is set to User Define. When the system enters the HDD Power Down mode according to the power saving time selected, the hard disk drive will be powered down while all other devices remain active.

3.1.5.8 Soft-Off by PWR-BTTN

This field allows you to select the method of powering off your system.

Hold 4 Sec. Regardless of whether the Power Management function is enabled or disabled, if the power button is pushed and released in less than 4 sec, the system enters the Suspend mode. The purpose of this function is to prevent the system from powering off in case you accidentally “hit” or pushed the power button. Push and release again in less than 4 sec to restore. Pushing the power button for more than 4 seconds will power off the system.

Instant-Off Pressing and then releasing the power button at once will immediately power off your system.

3.1.5.9 PWR Lost Resume State

Keep Off When power returns after an AC power failure, the system's power is off. You must press the Power button to power-on the system.

Turn On When power returns after an AC power failure, the system will automatically power-on.

Last State When power returns after an AC power failure, the system will return to the state where you left off before power failure occurs. If the system's power is off when AC power failure occurs, it will remain off when power returns. If the system's power is on when AC power failure occurs, the system will power-on when power returns.

USB KB Wake-Up From S3

This field, when enabled, allows you to use a USB keyboard to wake up a system that is in the S3 (STR - Suspend To RAM) state. This can be configured only if the "ACPI Suspend Type" field is set to "S3(STR)".

Resume By Alarm

Enabled When Enabled, you can set the date and time you would like the Soft Power Down (Soft-Off) PC to power-on in the "Date (of Month) Alarm" and "Time (hh:mm:ss) Alarm" fields. However, if the system is being accessed by incoming calls or the network (Resume On Ring/LAN) prior to the date and time set in these fields, the system will give priority to the incoming calls or network.

Disabled Disables the automatic power-on function. (default)

Date (of Month) Alarm

0 The system will power-on everyday according to the time set in the "Time (hh:mm:ss) Alarm" field.

1-31 Select a date you would like the system to power-on. The system will power-on on the set date, and time set in the "Time (hh:mm:ss) Alarm" field.

Time (hh:mm:ss) Alarm

This is used to set the time you would like the system to power-on. If you want the system to power-on everyday as set in the "Date (of Month) Alarm" field, the time set in this field must be later than the time of the RTC set in the Standard CMOS Features submenu.

Keyboard Power On

This field allows you to use the keyboard to power-on the system.

- Disabled* Default setting.
- Password* When this option is selected, move the cursor to the “KB Power On Password” field and press <Enter>. Enter your password. You can enter up to 5 characters. Type in exactly the same password to confirm, then press <Enter>.



Important:

The power button will not function once a keyboard password has been set in the “KB Power On Password” field. You must type the correct password to power-on the system. If you forgot the password, power-off the system and remove the battery. Wait for a few seconds and install it back before powering-on the system.

- Hot Key* When this option is selected, move the cursor to the “KB Power On Hot Key” field to select a function key you would like to use to power-on the system. The options are from Ctrl-F1 to Ctrl-F12.
- Any Key* Press any key to power-on the system.
- Keyboard 98* When this option is selected, press the “wake up” key of the Windows® 98 compatible keyboard to power-on the system.

3.1.6 PnP/PCI Configurations

This section describes configuring the PCI bus system. It covers some very technical items and it is strongly recommended that only experienced users should make any changes to the default settings.

Phoenix - AwardBIOS CMOS Setup Utility PnP/PCI Configurations		Item Help
Reset Configuration Data	Disabled	Menu Level Default is Disabled. Select Enabled to reset Extended System Configuration Data (ESCD) when you exit Setup if you have installed a new add-on and the system reconfiguration has caused such a serious conflict that the OS cannot boot.
Resources Controlled By	Auto(ESCD)	
X IRQ Resources	Press Enter	
PCI/VGA Palette Snoop	Disabled	
* PCI IRQ Assignment *		
Slot 1,5	Auto	
Onboard LAN/Slot 2,6	Auto	
Slot 3	Auto	
Slot 4	Auto	
↑↓→← Move Enter:Select +/-/PU/PD:Value F10:Save ESC:Exit F1:General Help F5:Previous Values F6:Fail-Safe Defaults F7:Optimized Defaults		

The settings on the screen are for reference only. Your version may not be identical to this one.

3.1.6.1 Reset Configuration Data

Enabled The BIOS will reset the Extended System Configuration Data (ESCD) once automatically. It will then recreate a new set of configuration data.

Disabled The BIOS will not reset the configuration data.

3.1.6.2 Resources Controlled By

The Award Plug and Play BIOS has the capability to automatically configure all of the boot and Plug and Play compatible devices.

Auto(ESCD) The system will automatically detect the settings for you.

Manual Choose the specific IRQ in the "IRQ Resources" field.

3.1.6.3 IRQ Resources

This field is used to set each system interrupt to either "PCI Device" or "Reserved".

3.1.6.4 PCI/VGA Palette Snoop

This field determines whether the MPEG ISA/VESA VGA cards can work with PCI/VGA or not.

Enabled MPEG ISA/VESA VGA cards work with PCI/VGA.

Disabled MPEG ISA/VESA VGA cards does not work with PCI/VGA.

3.1.6.5 PCI IRQ Assignment

By default, an IRQ is automatically assigned to the PCI devices that are installed in the PCI slots. If a PCI device has not been assigned an IRQ, you must manually assign an IRQ for the device. During system boot-up, you will see "NA" for the device that does not have an IRQ assigned.

3.1.7 CPU Frequency Control

CMOS Setup Utility - Copyright (C) 1984-2000 Award Software
CPU Frequency Control

CPU Clock Ratio	X 8	Item Help
Auto Detect PCI Clk	Enabled	Menu Level
Spread Spectrum Modulated	Enabled	
Clock By Slight Adjust	100MHz	
PCI/AGP Clock Adjust	Auto	
↑↓→← Move Enter:Select +/-/PU/PD:Value F10:Save ESC:Exit F1:General Help F5:Previous Values F6:Fail-Safe Defaults F7:Optimized Defaults		

The settings on the screen are for reference only. Your version may not be identical to this one.

3.1.7.1 CPU Clock Ratio

This field is used to select the frequency ratio of the processor.



Important:

The frequency ratio of some processors may have been locked by the manufacturer. If you are using this kind of processor, setting an extended ratio for the processor will have no effect. The system will instead use its factory default ratio.

3.1.7.2 Auto Detect PCI Clk

When enabled, the system will automatically send clock signals to existing PCI devices.

3.1.7.3 Spread Spectrum

Leave this field in its default setting. Do not alter this setting unless advised by an engineer or technician.

3.1.7.4 Clock By Slight Adjust

This field provides several options for selecting the external system bus clock of the processor. The available options allow you to adjust the processor's bus clock by 1MHz increment.



Important:

Selecting an external bus clock other than the default setting may result to the processor's or system's instability and are not guaranteed to provide better system performance.

If you selected an option other than the default setting and is unable to boot up the system, there are 2 methods of booting up the system and going back to its default setting.

Method 1:

Clear the CMOS data by setting JP2 to 2-3 On. All fields in the BIOS Setup will automatically be set to their default settings.

Method 2:

Press the <Insert> key and power button simultaneously, then release the power button first. Keep-on pressing the <Insert> key until the power-on screen appears. This will allow the system to boot according to the FSB of the processor. Now press the key to enter the main menu of the BIOS. Select "CPU Frequency Control" and set the "CPU Clock Ratio" or "Clock By Slight Adjust" field to its default setting or an appropriate frequency ratio or bus clock.



Note:

Use a PS/2 or AT (requires a DIN to mini DIN adapter) keyboard for method 2.

3.1.7.5 PCI/AGP Clock Adjust

This field is used to select the AGP clock. The number that appeared before the AGP clock is its corresponding PCI clock. For example, if you selected "33/66 MHz", 66MHz is the AGP clock and 33MHz is the PCI clock.

3.1.8 Load Fail-Safe Defaults

The “Load Fail-Safe Defaults” option loads the troubleshooting default values permanently stored in the ROM chips. These settings are not optimal and turn off all high performance features. You should use these values only if you have hardware problems. Highlight this option in the main menu and press <Enter>. The message below will appear:

Load Fail-Safe Defaults (Y/N)? N

If you want to proceed, type <Y> and press <Enter>. The default settings will be loaded.

3.1.9 Load Optimized Defaults

The “Load Optimized Defaults” option loads optimized settings from the BIOS ROM. Use the default values as standard values for your system. Highlight this option in the main menu and press <Enter>. The message below will appear:

Load Optimized Defaults (Y/N)? N

Type <Y> and press <Enter> to load the Setup default values.

3.1.10 Set Supervisor Password

If you want to protect your system and setup from unauthorized entry, set a supervisor's password with the "System" option selected in the Advanced BIOS Features. If you want to protect access to setup only, but not your system, set a supervisor's password with the "Setup" option selected in the Advanced BIOS Features. You will not be prompted for a password when you cold boot the system.

Use the arrow keys to highlight "Set Supervisor Password" and press <Enter>. The message below will appear:

Enter Password:

Type in the password. You are limited to eight characters. When done, the message below will appear:

Confirm Password:

You are asked to verify the password. Type in exactly the same password. If you type in a wrong password, you will be prompted to enter the correct password again. To delete or disable the password function, highlight "Set Supervisor Password" and press <Enter>, instead of typing in a new password. Press the <Esc> key to return to the main menu.

3.1.11 Set User Password

If you want another user to have access only to your system but not to setup, set a user's password with the "System" option selected in the Advanced BIOS Features. If you want a user to enter a password when trying to access setup, set a user's password with the "Setup" option selected in the Advanced BIOS Features.

Using user's password to enter Setup allows a user to access only "Set User Password" that appears in the main menu screen. Access to all other options is denied. To set, confirm, verify, disable or delete a user's password, follow the procedures described in the section "Set Supervisor Password".

3.1.12 Save & Exit Setup

When all the changes have been made, highlight “Save & Exit Setup” and press <Enter>. The message below will appear:

Save to CMOS and Exit (Y/N)? N

Type “Y” and press <Enter>. The modifications you have made will be written into the CMOS memory, and the system will reboot. You will once again see the initial diagnostics on the screen. If you wish to make additional changes to the setup, press <Ctrl> <Alt> <Esc> simultaneously or after memory testing is done.

3.1.13 Exit Without Saving

When you do not want to save the changes you have made, highlight “Exit Without Saving” and press <Enter>. The message below will appear:

Quit Without Saving (Y/N)? N

Type “Y” and press <Enter>. The system will reboot and you will once again see the initial diagnostics on the screen. If you wish to make any changes to the setup, press <Ctrl> <Alt> <Esc> simultaneously or after memory testing is done.

3.2 Updating the BIOS

To update the BIOS, you will need the new BIOS file and a flash utility, AWDFLASH.EXE. You can download them from DFI's web site or contact technical support or your sales representative.

1. Save the new BIOS file along with the flash utility AWDFLASH.EXE to a floppy disk.
2. Reboot the system and enter the Award BIOS Setup Utility to set the first boot drive to "Floppy".
3. Save the setting and reboot the system.
4. After the system booted from the floppy disk, execute the flash utility by typing AWDFLASH.EXE. The following screen will appear:

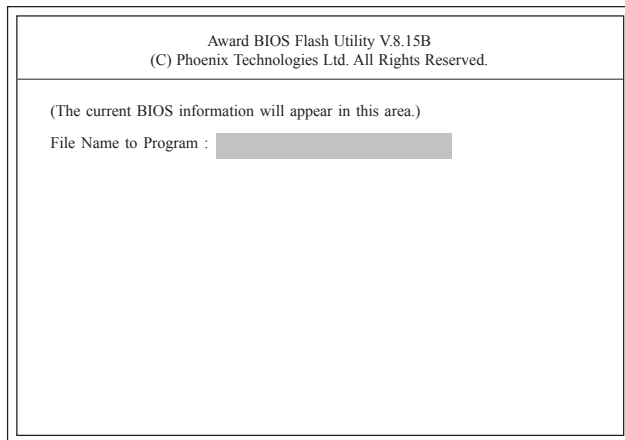

5. Type the new BIOS file name onto the gray area that is next to "File Name to Program" then press <Enter>.

6. The following will appear:

Do You Want to Save BIOS (Y/N)

This question refers to the current existing BIOS in your system. We recommend that you save the current BIOS and its flash utility; just in case you need to reinstall the BIOS. To save the current BIOS, press <Y> then enter the file name of the current BIOS. Otherwise, press <N>.

7. The following will then appear:

Press "Y" to Program or "N" to Exit

8. Press <Y> to flash the new BIOS.

Chapter 4 - Supported Software

4.1 Desktop Management Interface (DMI)

The system board comes with a DMI built into the BIOS. DMI, along with the appropriately networked software, is designed to make inventory, maintenance and troubleshooting of computer systems easier. With DMI, a network administrator or MIS engineer can remotely access some information about a particular computer system without physically going to it. Quite often a service call may be unnecessary as the problem can be solved remotely.

The DMI utility in the BIOS automatically records various information about your system configuration. Information about the type and speed of CPU, type and amount of memory for each memory slot, BIOS revision level, types of add-in PCI boards and components, certain revision numbers of hardware installed, etc. are automatically detected and stored in the DMI pool, which is a part of the system board's Plug and Play BIOS. Additional information, such as ISA based peripherals, which may not be automatically detected, can be manually recorded in the DMI pool by using the Add DMI menu. The DMI pool data is then verified or updated whenever the system hardware or setup is altered.

4.1.1 Running the DMI Utility

To run the DMI utility, type: DMICFG.EXE. You can download this utility from <ftp.dfusa.com> - /utilities/DMI directory.

The DMI utility must run in real mode with at least 180K of base memory. Memory managers like HIMEM.SYS (required by Windows) must not be installed. You may do this by using one of the 3 methods listed below.

1. Boot up from a system diskette without the AUTOEXEC.BAT and CONFIG.SYS files,
2. "REM" HIMEM.SYS in the CONFIG.SYS, or
3. Press <F5> during bootup to bypass your AUTOEXEC.BAT and CONFIG.SYS files.

4.1.2 Using the DMI Utility

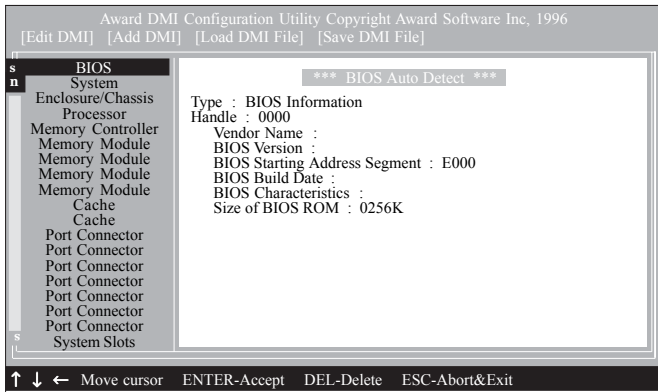

The four menus located on top of the DMI Configuration Utility screen are Edit DMI, Add DMI, Load DMI File and Save DMI File. Use the ← or → (left or right) arrow keys to select a menu from the Menu bar.

On the left side of the screen is a list of the system configuration items. Use the ↑ or ↓ (up or down) arrow keys to select an item.

The commands at the bottom of the screen will allow you to navigate through the various setup menus.

Edit DMI

1. Use the ← or → arrow keys to select the Edit DMI menu.
2. Highlight the item on the left screen that you would like to edit by using the ↑ or ↓ arrow keys, then press <Enter>.
3. The cursor will move to the screen you select allowing you to edit information. The screen will also display the auto-detected information.
4. Press <F10> to update the edited information into the flash ROM.

Add DMI

1. Use the ← or → arrow keys to select the Add DMI menu.
2. Highlight the item on the left screen that you would like to add by using the ↑ or ↓ arrow keys, then press <Enter>.
3. The cursor will move to the screen you select allowing you to enter information about the added item.
4. Press <F10> to save information into the flash ROM.

To view information about the added items, go to the Edit DMI menu.

Load DMI File

1. Use the ← or → arrow keys to select the Load DMI File menu.
2. The following message will appear:

Press [Enter] to select DMI file for load

Press <Enter>.

3. The DMI files will appear on the screen. Select the file you would like to load and press <Enter>.
4. The following message will appear:

Do you want to execute? (Y/N)

Type <Y>. All previous DMI structures will be destroyed and the new file will be saved into the flash ROM.

Save DMI File

1. Use the ← or → arrow keys to select the Save DMI File menu.
2. The following message will appear:

Press [Enter] to select DMI file for save

Press <Enter>.

3. Enter the directory and filename under which you would like the DMI file saved.

4.2 Drivers, Utilities and Software Applications

The CD that came with the system board contains drivers, utilities and software applications required to enhance the performance of the system board.

Insert the CD into a CD-ROM drive. The autorun screen (Mainboard Utility CD) will appear. If after inserting the CD, "Autorun" did not automatically start (which is, the Mainboard Utility CD screen did not appear), please go directly to the root directory of the CD and double-click "Setup".



4.2.1 Intel Chipset Software Installation Utility

The Intel Chipset Software Installation Utility is used for updating Windows® 98SE/2000/ME/XP's INF files so that the Intel chipset can be recognized and configured properly in the system.

To install the utility, please follow the steps below.

1. On the left side of the autorun screen, click the "CHIPSET" icon.
2. Click "Intel Chipset Software Installation Utility" on the main menu. The following screen will appear:

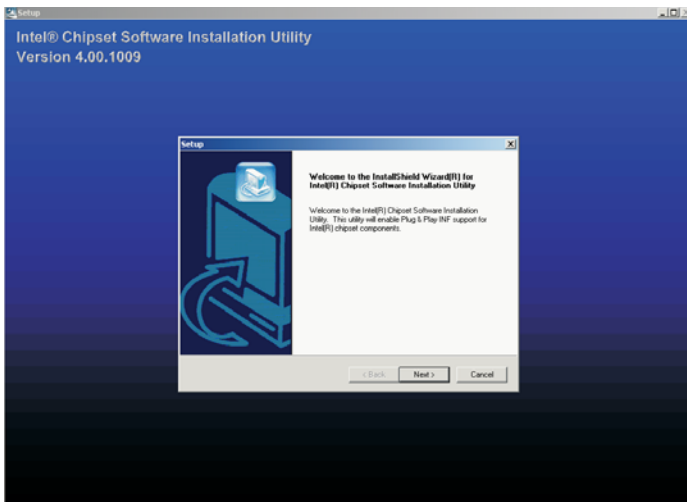

3. Follow the prompts on the screen to complete installation.
4. Reboot the system for the utility to take effect.

4.2.2 Audio Drivers

The audio drivers are supported in the following operating systems: Windows® 98 SE, Windows® ME, Windows NT® 4.0, Windows® 2000 and Windows® XP.

To install the driver, please follow the steps below.

1. On the left side of the autorun screen, click the "AUDIO" icon.
2. Click "Audio Drivers" on the main menu. The following screen will appear:

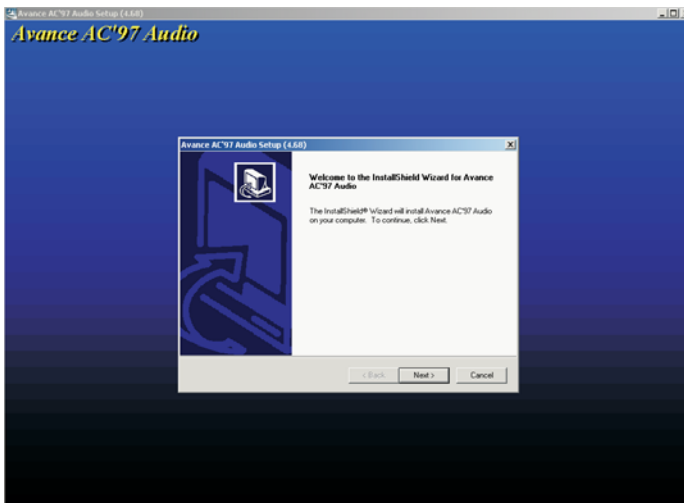

3. Follow the prompts on the screen to complete installation.
4. Reboot the system for the driver to take effect.

4.2.3 Intel USB 2.0 Drivers

If you are using a USB 2.0 device, you must install the USB 2.0 driver. The drivers are supported in the following operating systems: Windows® 98 SE, Windows® ME, Windows® 2000 and Windows® XP.

To install the driver, please follow the steps below.

1. On the left side of the autorun screen, click the "USB" icon.
2. Click "Intel USB 2.0 Drivers" on the main menu. The following screen will appear:

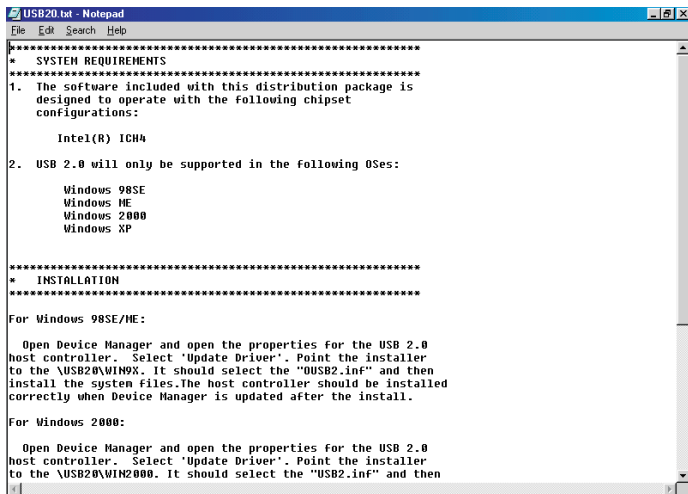

```
USB20.txt - Notepad
File Edit Search Help
*****
* SYSTEM REQUIREMENTS
*****
1. The software included with this distribution package is
designed to operate with the following chipset
configurations:

    Intel(R) ICH4

2. USB 2.0 will only be supported in the following OSes:

    Windows 98SE
    Windows ME
    Windows 2000
    Windows XP

*****
* INSTALLATION
*****
For Windows 98SE/ME:

    Open Device Manager and open the properties for the USB 2.0
    host controller. Select 'Update Driver'. Point the installer
    to the \USB20\WIN9X. It should select the "USB2.inf" and then
    install the system files. The host controller should be installed
    correctly when Device Manager is updated after the install.

For Windows 2000:

    Open Device Manager and open the properties for the USB 2.0
    host controller. Select 'Update Driver'. Point the installer
    to the \USB20\WIN2000. It should select the "USB2.inf" and then
```

3. Follow the installation instructions shown on the screen.
4. Reboot the system for the driver to take effect.

4.2.4 LAN Drivers (NB73-BL only)

The LAN drivers support autorun for the following operating systems: Windows® 98 SE, Windows® ME, Windows® 2000 and Windows® XP.

To install the driver, please follow the steps below.

1. On the left side of the autorun screen, click the “NETWORK” icon.
2. Click “LAN Drivers” on the main menu. The following screen will appear:

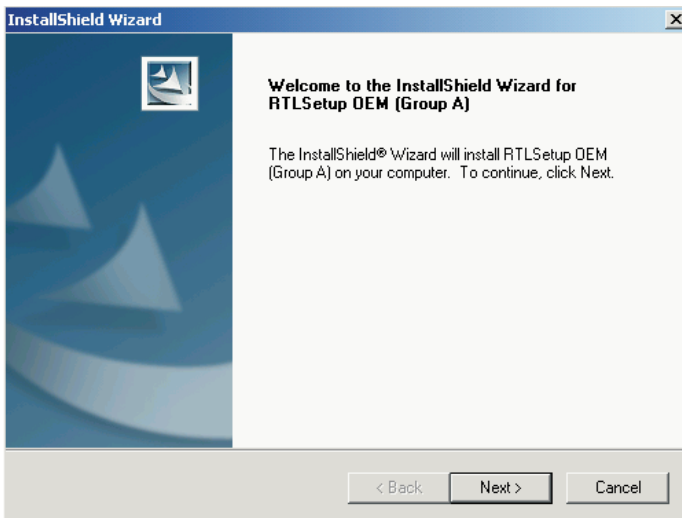

3. Follow the prompts on the screen to complete installation.
4. Reboot the system for the driver to take effect.

The LAN driver for Windows NT® 4.0 does not support “Autorun”. Once the Windows NT® 4.0 system has detected the Realtek RTL8100 fast ethernet controller, it will prompt you to install the driver. The driver is in the “Realtek_LAN\WINNT4” directory of the CD.

4.2.5 Intel Application Accelerator

The Intel® Application Accelerator is designed to improve performance of the storage subsystem and overall system performance. It delivers improved performance through several ingredient technologies (components).

To install, please follow the steps below.

1. On the left side of the autorun screen, click the “TOOLS” icon.
2. Click “Intel Application Accelerator” on the main menu. The following screen will appear:



3. Follow the prompts on the screen to complete installation.
4. Reboot the system for the driver to take effect.

4.2.6 Microsoft DirectX 8.1

To install, please follow the steps below.

1. On the left side of the autorun screen, click the "TOOLS" icon.
2. Click "Microsoft DirectX 8.1" on the main menu. The following screen will appear:

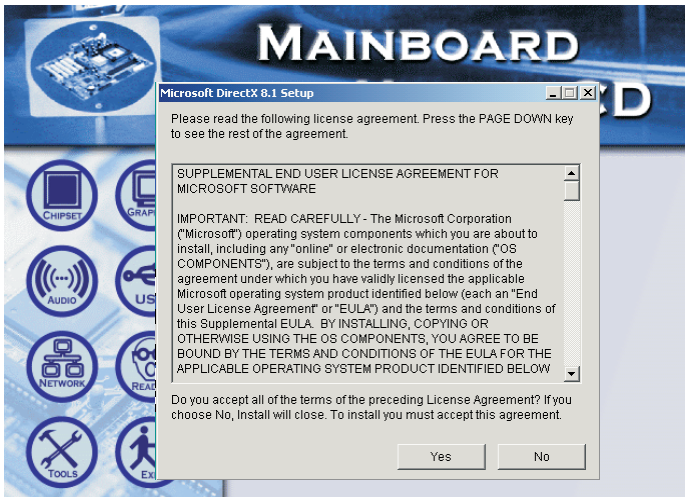

3. Click "Yes" to continue.
4. Follow the prompts on the screen to complete installation.
5. Reboot the system for the driver to take effect.



Note:

If you are using Windows® XP, you do not need to install "Microsoft DirectX 8.1" because it is already supported by the operating system..

4.2.7 McAfee VirusScan Online (English OS only)

The McAfee VirusScan Online is the most reliable and convenient way of protecting your PC from computer viruses. When you install McAfee VirusScan Online, your computer is safe because it automatically scans for viruses and checks for virus updates so that PC protection stays up-to-date.

To install, please follow the steps below.

1. On the left side of the autorun screen, click the "TOOLS" icon.
2. Click "McAfee VirusScan Online" on the main menu. The following screen will appear.



3. Click "Yes" to continue.
4. Follow the prompts on the screen to complete installation.
5. Restart the system.

4.3 Installation Notes

1. "Autorun" ONLY supports the Windows® 98 SE, Windows® ME, Windows® 2000, Windows NT® 4.0 and Windows® XP operating systems. If after inserting the CD, "Autorun" did not automatically start (which is, the Main Board Utility CD screen did not appear), please go directly to the root directory of the CD and double-click "Setup".
2. All steps or procedures to install software drivers are subject to change without notice as the softwares are occasionally updated. Please go to DFI's web site at "<http://www.dfi.com/support1/download2.asp>" for the latest version of the drivers or software applications.

Appendix A - Enabling Hyper-Threading Technology

A.1 Enabling Hyper-Threading Technology

To enable the functionality of the Hyper-Threading Technology, please follow the requirements and steps below. Basically, the following presumes that you have already installed an Intel® Pentium® 4 Processor with Hyper-Threading Technology.

1. The system requires a minimum of 300 Watt ATX 12V power supply.
2. Aside from installing a CPU fan on the Intel® Pentium® 4 Processor with Hyper-Threading Technology, make sure to install another fan (either a chassis fan or second fan). The system requires adequate airflow throughout the chassis to prevent overheating the processor.
3. The “CPU Hyper-Threading” field in the Advanced BIOS Features submenu of the Award BIOS setup will appear. Make sure this field is set to Enabled.
4. Currently, only Windows® XP supports the Hyper-Threading Technology. If this OS has been previously installed, you must **REINSTALL** it.
5. After installing Windows® XP, please check the following to ensure that the operating system has been properly installed.
 - a. Click Start, point to Settings then click Control Panel.
 - b. Double-click the System icon. The System Properties dialog box will appear.

- c. Click the General tab. The processor shown under Computer should resemble the one shown below.

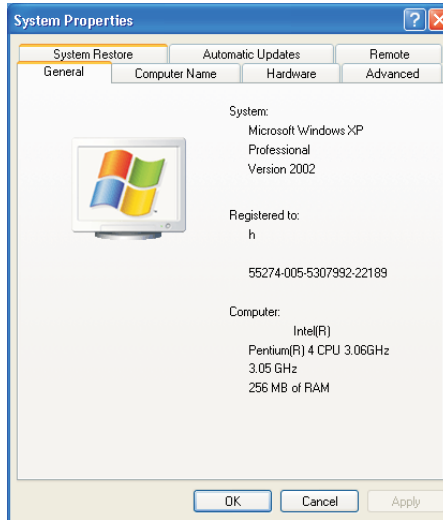

- d. Now click the Hardware tab then click Device Manager. The items shown under Computer and Processors should resemble the ones shown below.

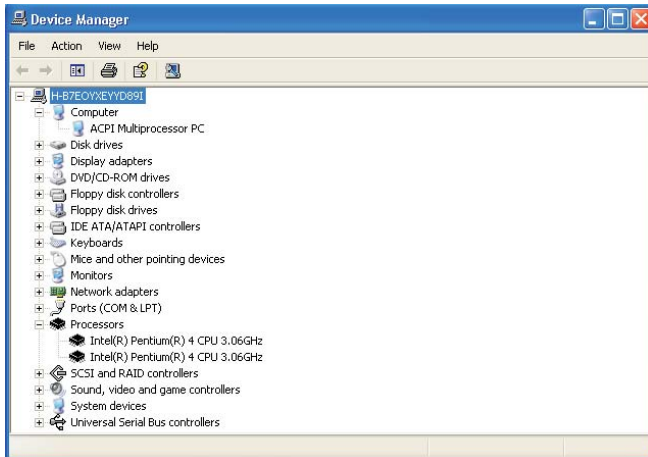

Enabling Hyper-Threading Technology

- e. Lastly, press the <Ctrl> <Alt> and keys simultaneously. The Windows Task Manager dialog box will appear. Click the Performance tab. The diagram under CPU Usage History should resemble the one shown below.

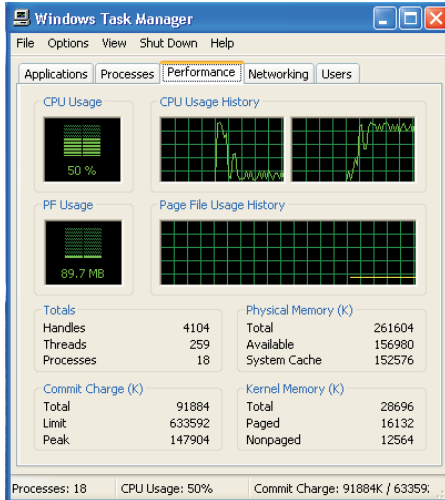

Appendix B - System Error Message

When the BIOS encounters an error that requires the user to correct something, either a beep code will sound or a message will be displayed in a box in the middle of the screen and the message, PRESS F1 TO CONTINUE, CTRL-ALT-ESC or DEL TO ENTER SETUP, will be shown in the information box at the bottom. Enter Setup to correct the error.

B.1 POST Beep

There are two kinds of beep codes in the BIOS. One code indicates that a video error has occurred and the BIOS cannot initialize the video screen to display any additional information. This beep code consists of a single long beep followed by three short beeps. The other code indicates that a DRAM error has occurred. This beep code consists of a single long beep.

B.2 Error Messages

One or more of the following messages may be displayed if the BIOS detects an error during the POST. This list indicates the error messages for all Awards BIOSes:

CMOS BATTERY HAS FAILED

The CMOS battery is no longer functional. It should be replaced.



Caution:

Danger of explosion if battery incorrectly replaced. Replace only with the same or equivalent type recommended by the manufacturer. Dispose of used batteries according to the battery manufacturer's instructions.

CMOS CHECKSUM ERROR

Checksum of CMOS is incorrect. This can indicate that CMOS has become corrupt. This error may have been caused by a weak battery. Check the battery and replace if necessary.

DISPLAY SWITCH IS SET INCORRECTLY

The display switch on the motherboard can be set to either monochrome or color. This indicates the switch is set to a different

setting than indicated in Setup. Determine which setting is correct, either turn off the system and change the jumper or enter Setup and change the VIDEO selection.

FLOPPY DISK(S) fail (80)

Unable to reset floppy subsystem.

FLOPPY DISK(S) fail (40)

Floppy type mismatch.

Hard Disk(s) fail (80)

HDD reset failed.

Hard Disk(s) fail (40)

HDD controller diagnostics failed.

Hard Disk(s) fail (20)

HDD initialization error.

Hard Disk(s) fail (10)

Unable to recalibrate fixed disk.

Hard Disk(s) fail (08)

Sector Verify failed.

Keyboard is locked out - Unlock the key

The BIOS detects that the keyboard is locked. Keyboard controller is pulled low.

Keyboard error or no keyboard present

Cannot initialize the keyboard. Make sure the keyboard is attached correctly and no keys are being pressed during the boot.

Manufacturing POST loop

System will repeat POST procedure infinitely while the keyboard controller is pull low. This is also used for the M/B burn in test at the factory.

BIOS ROM checksum error - System halted

The checksum of ROM address F0000H-FFFFFFH is bad.

Memory test fail

The BIOS reports memory test fail if the memory has error(s).

Appendix C - Troubleshooting

C.1 Troubleshooting Checklist

This chapter of the manual is designed to help you with problems that you may encounter with your personal computer. To efficiently troubleshoot your system, treat each problem individually. This is to ensure an accurate diagnosis of the problem in case a problem has multiple causes.

Some of the most common things to check when you encounter problems while using your system are listed below.

1. The power switch of each peripheral device is turned on.
2. All cables and power cords are tightly connected.
3. The electrical outlet to which your peripheral devices are connected is working. Test the outlet by plugging in a lamp or other electrical device.
4. The monitor is turned on.
5. The display's brightness and contrast controls are adjusted properly.
6. All add-in boards in the expansion slots are seated securely.
7. Any add-in board you have installed is designed for your system and is set up correctly.

Monitor/Display

If the display screen remains dark after the system is turned on:

1. Make sure that the monitor's power switch is on.
2. Check that one end of the monitor's power cord is properly attached to the monitor and the other end is plugged into a working AC outlet. If necessary, try another outlet.
3. Check that the video input cable is properly attached to the monitor and the system's display adapter.
4. Adjust the brightness of the display by turning the monitor's brightness control knob.

The picture seems to be constantly moving.

1. The monitor has lost its vertical sync. Adjust the monitor's vertical sync.
2. Move away any objects, such as another monitor or fan, that may be creating a magnetic field around the display.
3. Make sure your video card's output frequencies are supported by this monitor.

The screen seems to be constantly wavering.

1. If the monitor is close to another monitor, the adjacent monitor may need to be turned off. Fluorescent lights adjacent to the monitor may also cause screen wavering.

Power Supply

When the computer is turned on, nothing happens.

1. Check that one end of the AC power cord is plugged into a live outlet and the other end properly plugged into the back of the system.
2. Make sure that the voltage selection switch on the back panel is set for the correct type of voltage you are using.
3. The power cord may have a "short" or "open". Inspect the cord and install a new one if necessary.

Floppy Drive

The computer cannot access the floppy drive.

1. The floppy diskette may not be formatted. Format the diskette and try again.
2. The diskette may be write-protected. Use a diskette that is not write-protected.
3. You may be writing to the wrong drive. Check the path statement to make sure you are writing to the targeted drive.
4. There is not enough space left on the diskette. Use another diskette with adequate storage space.

Hard Drive

Hard disk failure.

1. Make sure the correct drive type for the hard disk drive has been entered in the BIOS.
2. If the system is configured with two hard drives, make sure the bootable (first) hard drive is configured as Master and the second hard drive is configured as Slave. The master hard drive must have an active/bootable partition.

Excessively long formatting period.

1. If your hard drive takes an excessively long period of time to format, it is likely a cable connection problem. However, if your hard drive has a large capacity, it will take a longer time to format.

Parallel Port

The parallel printer doesn't respond when you try to print.

1. Make sure that your printer is turned on and that the printer is on-line.
2. Make sure your software is configured for the right type of printer attached.
3. Verify that the onboard LPT port's I/O address and IRQ settings are configured correctly.
4. Verify that the attached device works by attaching it to a parallel port that is working and configured correctly. If it works, the printer can be assumed to be in good condition. If the printer remains inoperative, replace the printer cable and try again.

Serial Port

The serial device (modem, printer) doesn't output anything or is outputting garbled characters.

1. Make sure that the serial device's power is turned on and that the device is on-line.
2. Verify that the device is plugged into the correct serial port on the rear of the computer:
3. Verify that the attached serial device works by attaching it to a serial port that is working and configured correctly. If the serial device does not work, either the cable or the serial device has a problem. If the serial device works, the problem may be due to the onboard I/O or the address setting.
4. Make sure the COM settings and I/O address are configured correctly.

Keyboard

Nothing happens when a key on the keyboard was pressed.

1. Make sure the keyboard is properly connected.
2. Make sure there are no objects resting on the keyboard and that no keys are pressed during the booting process.

System Board

1. Make sure the add-in card is seated securely in the expansion slot. If the add-in card is loose, power off the system, re-install the card and power up the system.
2. Check the jumper settings to ensure that the jumpers are properly set.
3. Verify that all memory modules are seated securely into the memory sockets.
4. Make sure the memory modules are in the correct locations.
5. If the board fails to function, place the board on a flat surface and seat all socketed components. Gently press each component into the socket.
6. If you made changes to the BIOS settings, re-enter setup and load the BIOS defaults.