

MX36CE Online Manual

DOC. NO.: MX36CE-OL-E0210A



What's in this manual

MX36CE	1
<i>What's in this manual</i>	<i>2</i>
<i>You Must Notice</i>	<i>9</i>
<i>Before You Start</i>	<i>10</i>
<i>Overview</i>	<i>11</i>
<i>Feature Highlight.....</i>	<i>12</i>
<i>Quick Installation Procedure</i>	<i>15</i>
<i>Motherboard Map</i>	<i>16</i>
Hardware Installation.....	17
<i>About "User Upgrade Optional" and "Manufacture Upgrade Optional".....</i>	<i>18</i>
<i>JP14 Clear CMOS Data</i>	<i>19</i>
<i>CPU Installation</i>	<i>20</i>
<i>JP23 Adjust FSB/PCI Clock</i>	<i>21</i>
<i>CPU Jumper-less Design</i>	<i>25</i>
<i>CPU and Housing Fan Connector (With H/W Monitoring)</i>	<i>26</i>
<i>DIMM Socket.....</i>	<i>27</i>
<i>DDR 266(PC2100) Supported.....</i>	<i>29</i>
<i>Front Panel Connector</i>	<i>30</i>



AC Power Auto Recovery 31

ATX Power Connector 31

STBY LED 32

JP28 Keyboard/Mouse Wake-up Jumper 33

IDE and Floppy Connector 34

 SATA/133 Supported 36

IrDA Connector 37

WOL (Wake on LAN) 38

CNR (Communication and Network Riser) Expansion Slot 40

Support Realtek 10/100 Mbps LAN onboard 41

JP13 LAN Select Jumper 42

Color Coded Back Panel 43

COM2 Connector 44

 Support USB2.0 Port 45

CD Audio Connector 46



Case Open Connector 47

Game Port Bracket Supported 48

Front Audio Connector 49

Battery-less and Long Life Design 50



Hardware Monitoring.....	51
Over-current Protection.....	52
Resetable Fuse.....	53
Layout (Frequency Isolation Wall).....	54
 Vivid BIOS technology.....	55
 The noise is gone!! --- SilentTek.....	56
Driver and Utility	59
Autorun Menu from Bonus CD.....	60
Installing Windows 95.....	61
Installing Windows 98.....	62
Installing Windows 98 SE, Windows ME & Windows2000/XP.....	63
Installing VIA 4 in 1 Driver.....	64
Installing Onboard Sound Driver.....	65
Installing VGA Driver.....	66
Installing LAN Driver.....	67
Installing USB2.0 Driver.....	70
AOCconfig Utility.....	71
Installing Hardware Monitoring Utility.....	73
Phoenix-AWARD BIOS.....	74



<i>About BIOS Function Description</i>	75
<i>How To Use Phoenix-Award™ BIOS Setup Program</i>	76
<i>How To Enter BIOS Setup</i>	78
 <i>BIOS Upgrade under Windows environment</i>	79
Overclocking	81
VGA Card & Hard Disk	82
Glossary	83
AC97.....	83
ACPI (Advanced Configuration & Power Interface)	83
AGP (Accelerated Graphic Port)	83
AMR (Audio/Modem Riser).....	84
AOpen Bonus Pack CD.....	84
APM (Advanced Power Management).....	84
ATA (AT Attachment)	84
ATA/66	84
ATA/100	85
ATA/133	85
BIOS (Basic Input/Output System)	85
Bus Master IDE (DMA mode)	85



<i>CNR (Communication and Networking Riser)</i>	86
<i>CODEC (Coding and Decoding)</i>	86
<i>DIMM (Dual In Line Memory Module)</i>	86
<i>ECC (Error Checking and Correction)</i>	86
<i>EDO (Extended Data Output) Memory</i>	87
<i>EEPROM (Electronic Erasable Programmable ROM)</i>	87
<i>EPROM (Erasable Programmable ROM)</i>	87
<i>EV6 Bus</i>	87
<i>FCC DoC (Declaration of Conformity)</i>	88
<i>FC-PGA (Flip Chip-Pin Grid Array)</i>	88
<i>Flash ROM</i>	88
<i>FSB (Front Side Bus) Clock</i>	88
<i>I²C Bus</i>	88
<i>IEEE 1394</i>	89
<i>Parity Bit</i>	89
<i>PBSRAM (Pipelined Burst SRAM)</i>	90
<i>PC-100 DIMM</i>	90
<i>PC-133 DIMM</i>	90
<i>PC-1600, PC-2100 or PC-2700 DDR DRAM</i>	90



<i>PCI (Peripheral Component Interface) Bus</i>	90
<i>PDF Format</i>	91
<i>PnP (Plug and Play)</i>	91
<i>POST (Power-On Self Test)</i>	91
<i>RDRAM (Rambus DRAM)</i>	91
<i>RIMM (Rambus Inline Memory Module)</i>	92
<i>SDRAM (Synchronous DRAM)</i>	92
<i>Shadow E²PROM</i>	92
<i>SIMM (Single In Line Memory Module)</i>	92
<i>SMBus (System Management Bus)</i>	93
<i>SPD (Serial Presence Detect)</i>	93
<i>UltraATA</i>	93
<i>USB (Universal Serial Bus)</i>	94
<i>USB2.0 (Universal Serial Bus)</i>	94
<i>VCM (Virtual Channel Memory)</i>	94
<i>ZIP file</i>	94
Troubleshooting	95
Technical Support	99
Product Registration	102



How to Contact Us 103

You Must Notice



Adobe, the Adobe logo, Acrobat is trademarks of Adobe Systems Incorporated.

AMD, the AMD logo, Athlon and Duron are trademarks of Advanced Micro Devices, Inc.

Intel, the Intel logo, Intel Celeron, Pentium II, Pentium III are trademarks of Intel Corporation.

Microsoft, Windows, and Windows logo are either registered trademarks or trademarks of Microsoft Corporation in the United States and/or other countries.

All product and brand names used on this manual are used for identification purposes only and may be the registered trademarks of their respective owners.

All of the specifications and information contained in this manual are subject to change without notice. AOpen reserves the right to revise this publication and to make reasonable changes. AOpen assumes no responsibility for any errors or inaccuracies that may appear in this manual, including the products and software described in it.

This documentation is protected by copyright law. All rights are reserved.

No part of this document may be used or reproduced in any form or by any means, or stored in a database or retrieval system without prior written permission from AOpen Corporation.

Copyright® 1996-2002, AOpen Inc. All Rights Reserved.

Before You Start



This Online Manual will introduce to the user how this product is installed. All useful information will be described in later chapters. Please keep this manual carefully for future upgrades or system configuration changes. This Online Manual is saved in [PDF format](#), we recommend using Adobe Acrobat Reader 4.0 for online viewing, it is included in [Bonus CD](#) or you can get free download from [Adobe web site](#).

Although this Online Manual is optimized for screen viewing, it is still capable for hardcopy printing, you can print it by A4 paper size and set 2 pages per A4 sheet on your printer. To do so, choose **File > Page Setup** and follow the instruction of your printer driver.

Thanks for the help of saving our earth.

Overview

Thank you very much for choosing AOpen MX36CE, which is an Intel® Socket 370 motherboard based on the microATX form factor featuring VIA Apollo CLE266 chipset. As high performance chipset built in the M/B, MX36CE supports VIA C3 processors, Intel® Socket 370 series Pentium III™ and Celeron™ processors in 66/100/133MHz Front Side bus (FSB). According to different customer's requirements, this motherboard supports DDR200 (PC1600) SDRAM and DDR266 (PC2100) SDRAM up to 2GB maximum. The on-board IDE controller supports UltraATA 33/66/100/133 mode and the transfer rate up to the latest high-speed 133MB/s. Besides, on the strength of built in AC97 CODEC controller, it can bring you high quality multimedia capabilities with magic stereo surround. MX36CE also has VGA onboard, Realtek 8100BL LAN controller, one CNR slot, 3 PCI slots and 6 USB ports for you to make best use of it. Now, please enjoy all features that AOpen MX36CE brings you.

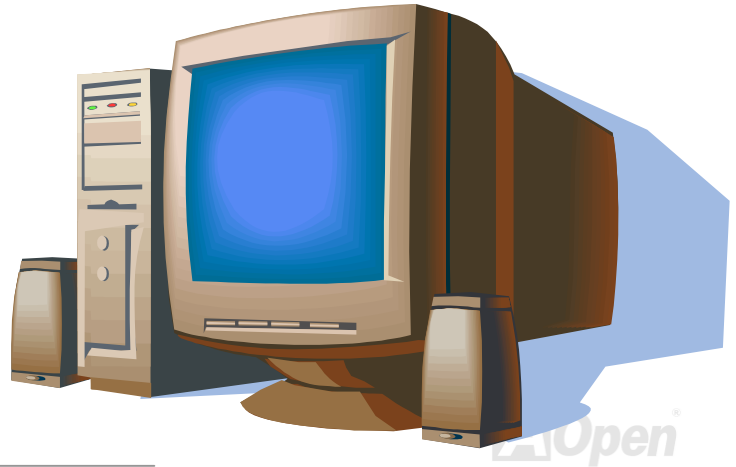

Feature Highlight

CPU

Supports Intel® Socket 370 Pentium® III Tualatin/Celeron™ 533MHz~1.2GHz+ and VIA C3 with 66/100/133MHz Front Side Bus designed for Socket 370 technology.

Chipset

The CLE266 north bridge integrates VIA's VT8653 Apollo Pro266T system controller, 128-bit graphics accelerator and flat panel interfaces into a single 548 BGA package. The north bridge VT8623 supports four banks of DDR/SDR SDRAMs up to 2GB. It also supports a high speed 8-bit 66MHz Quad Data Transfer interconnect (V-Link) to the south bridge. The CLE266 north bridge also integrates a VIA-designed 128-bit graphics accelerator into the chip. This brings mainstream graphics performance to the Value PC with leading-edge 2D, 3D and DVD video acceleration into a cost effective package. The VT8235 south bridge supports Intel and non-Intel based processor to V-Link bus bridge functionality to make a complete Microsoft PC2001-compliant PCI/LPC system. It includes IEEE 802.3 compliant 10/100 Mbps PCI bus master Ethernet MAC with standard MII interface to external PHY receiver, master mode enhanced IDE controller with dual channel DMA engine and interlaced dual channel commands, universal Serial Bus controller that is USB v2.0/1.1 and Universal HCI v2.0/1.1 compliant. It also supports keyboard controller with PS2 mouse support, Real Time Clock with 256 byte extended CMOS, Full System Management Bus (SMBus) interface and integrated bus-mastering dual full-duplex direct-sound AC97-link-compatible sound system.

Expansion Slots

Including three 32-bit / 33MHz PCI and one CNR slots. The PCI local bus throughput can be up to 132MB/s. The [Communication & Networking Riser \(CNR\)](#) slot on this model supports CNR interface for a Modem/Audio card. Of three PCI slots provided, all of them are master PCI slots with arbitration and decoding for all integrated functions and LPC bus.

Memory

Provides two 184-pin DDRAM DIMM sockets that support up to 2GB of [PC1600](#)(DDR200) and [PC2100](#)(DDR266) compliant SDRAM (Synchronous Dynamic Random Access Memory).

Ultra DMA 33/66/100/133 Enhanced IDE

Comes with an on-board PCI Bus Master IDE controller with two connectors that allow you to connect four IDE devices in two channels, supporting [Ultra DMA](#) 33/66/100/133, PIO Modes 3 and 4 and Bus Master IDE DMA Mode 5, and other Enhanced IDE devices.

On-board AC97 Sound

This motherboard uses the AC97 sound chip, which includes a complete capability of audio recording and playback system.

LAN Port

On the strength of Realtek 8100BL on board, it provides 10/100 Mbps Ethernet for office and home use.

Six USB2.0 Ports

Provides four ports on the back panel, one USB connector on the board, offering a total of six USB2.0 interface devices such as mouse, keyboard, modem, scanner, etc.



Power Management/Plug and Play

Supports the power management function that conforms to the power-saving standards of the U.S. Environmental Protection Agency (EPA) Energy Star program. It also offers Plug-and-Play, which helps save users from configuration problems, thus making to system user-friendlier.

Hardware Monitoring Management

Supports CPU or system fans status and control, temperature and voltage monitoring and alert, through the on-board hardware monitor module and [AOpen Hardware Monitoring Utility](#).

Enhanced ACPI

Fully implement the [ACPI](#) standard for Windows® 95/98/ME/NT/2000/XP series compatibility, and supports Soft-Off, STR (Suspend to RAM, S3), STD (Suspend to Disk, S4), and WOL (Wake On LAN) features.

Super Multi-I/O

Provides two high-speed UART compatible serial ports and one parallel port with EPP and ECP capabilities. UART2 can also be directed from COM2 to the Infrared Module for the wireless connections.

Quick Installation Procedure

This page gives you a quick procedure on how to install your system. Follow each step accordingly.

- 1 [Installing CPU and Fan](#)
- 2 [Installing System Memory \(DIMM\)](#)
- 3 [Connecting Front Panel Cable](#)
- 4 [Connecting IDE and Floppy Cable](#)
- 5 [Connecting ATX Power Cable](#)
- 6 [Connecting Back Panel Cable](#)
- 7 [Power-on and Load BIOS Setup Default](#)
- 8 [Setting CPU Frequency](#)
- 9 Reboot
- 10 [Installing Operating System \(such as Windows 98\)](#)
- 11 [Installing Driver and Utility](#)

Motherboard Map

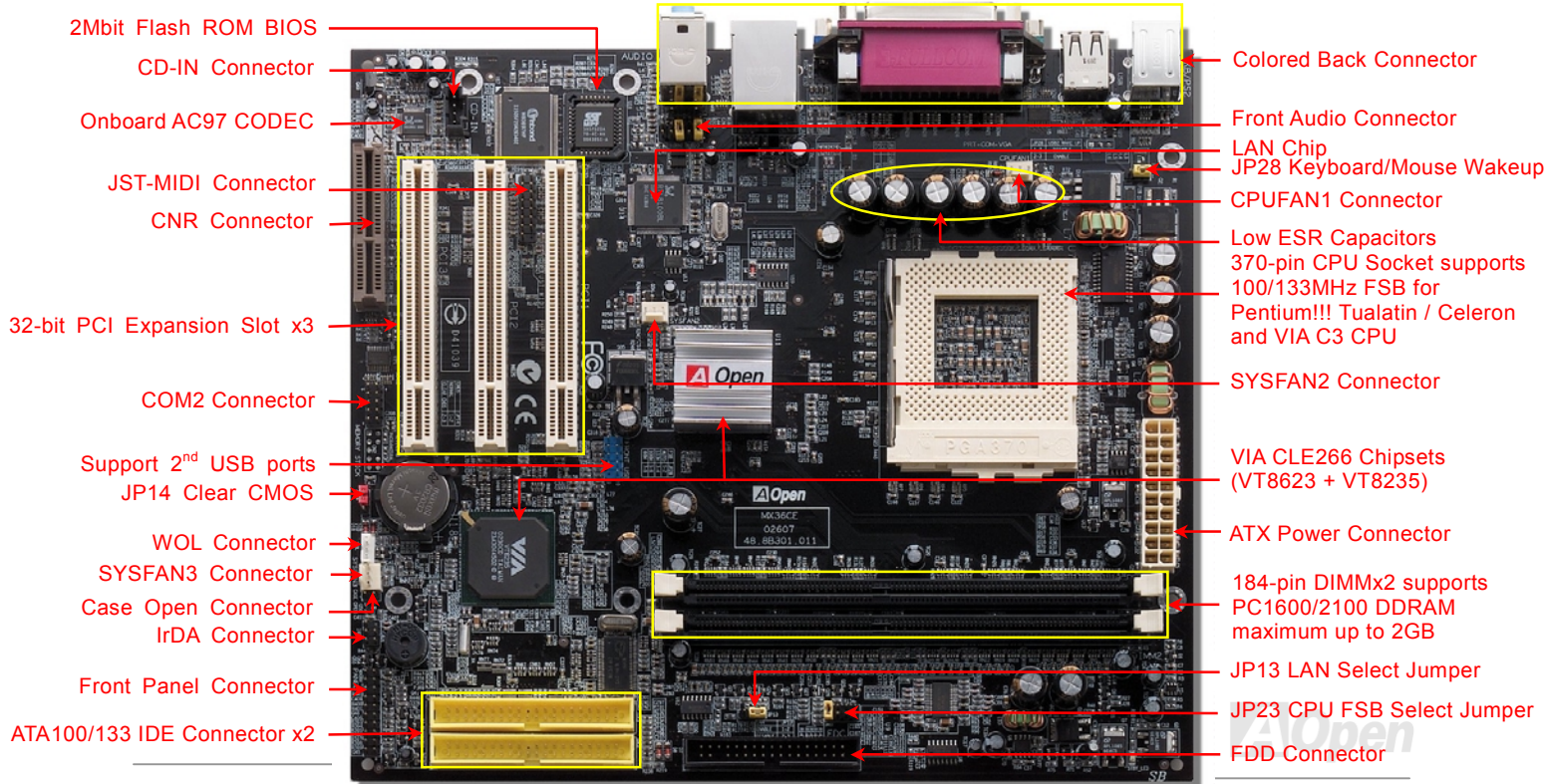

Hardware Installation

This chapter describes jumpers, connectors and hardware devices of this motherboard.



Note: *Electrostatic discharge (ESD) can damage your processor, disk drives, expansion boards, and other components. Always observe the following precautions before you install a system component.*

1. *Do not remove a component from its protective packaging until you are ready to install it.*
2. *Wear a wrist ground strap and attach it to a metal part of the system unit before handling a component. If a wrist strap is not available, maintain contact with the system unit throughout any procedure requiring ESD protection.*

About “User Upgrade Optional” and “Manufacture Upgrade Optional”...

When you read this online manual and start to assemble your computer system, you may notice that some of the functions are marked as “User Upgrade Optional” or “Manufacture Upgrade Optional”. Although all of AOpen’s motherboards have included many amazing and powerful features, sometimes not every user is familiar with these powerful features. As a result of this we define features that can be upgraded by users as “User Upgrade Optional”. You can upgrade these functions by purchasing additional devices. As for functions that cannot be upgraded by users, we define them as “Manufacture Upgrade Optional”. If need be, you can contact our local distributors or resellers to purchase “Manufacture Upgrade Optional” components, and again you are also welcome to visit our official website at english.aopen.com.tw for detail information.



JP14 Clear CMOS Data

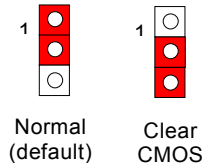
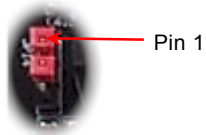
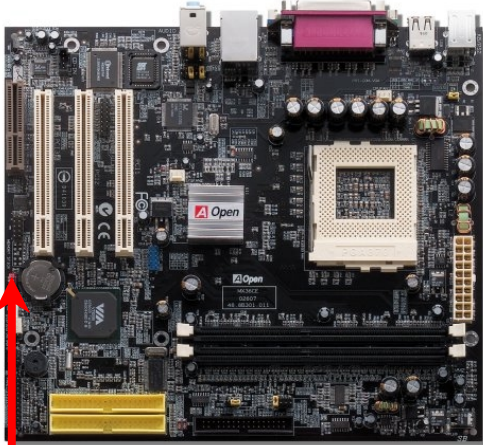

You can clear CMOS to restore system default setting. To clear the CMOS, follow the procedure below.

1. Turn off the system and unplug the AC power.
2. Remove ATX power cable from connector PWR2.
3. Locate JP14 and short pins 2-3 for a few seconds.
4. Return JP14 to its normal setting by shorting pin 1 and pin 2.
5. Connect ATX power cable back to connector PWR2.

Tip: When should I Clear CMOS?

1. Boot fail because of overclocking...
2. Forget password...
3. Troubleshooting...

CPU Installation

This motherboard supports Intel® Pentium III Tualatin / Celeron and VIA C3 Socket 370 CPU. Be careful of CPU orientation when you plug it into CPU socket.

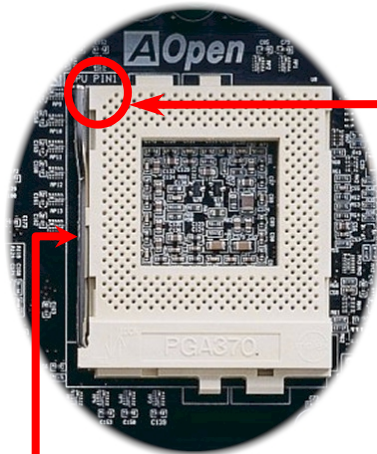

CPU socket
Lever

CPU Pin1
and cut edge

1. Pull up the CPU socket lever and up to 90-degree angle.
2. Locate Pin 1 in the socket and look for a black dot or cut edge on the CPU upper interface. Match Pin 1 and cut edge. Then insert the CPU into the socket.
3. Press down the CPU socket lever and finish CPU installation.



Note: If you do not match the CPU socket Pin 1 and CPU cut edge well, you may damage the CPU.

Note: Those pictures are for example only; they may not look the same with the motherboard you purchased.



JP23 Adjust FSB/PCI Clock

This jumper is used to specify the relationship between PCI and [FSB](#) clock. Generally speaking, if you are not an overclocker, we recommend you to set this jumper at default setting.

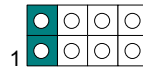
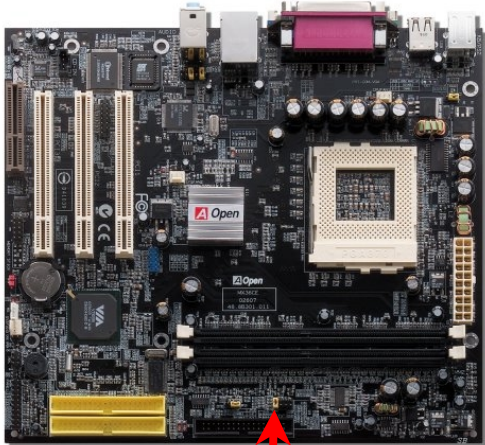

Auto Detect
(Default)

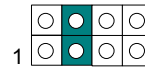

FSB=133MHz

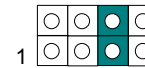

FSB=100MHz

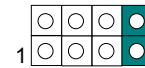

FSB=66MHz



Pin 1

PCI Clock = CPU FSB Clock / Clock Ratio

Clock Ratio	CPU (Host)	PCI	Memory
2X	66	33	PCI x2 or x3
2X (Overclocking)	75	37.5	PCI x2 or x3
3X	100	33	PCI x2 or x3 or x4
3X (Overclocking)	112	37.3	PCI x2 or x3 or x4
4X	133	33	PCI x3 or x4



Warning: VIA CLE266 chipset supports maximum 133MHz FSB, higher clock setting may cause serious system damage.

Setting CPU Frequency

BIOS Setup > Frequency/Voltage Control > CPU Host Clock (CPU/PCI)

Core Frequency = CPU FSB Clock * CPU Ratio

CPU Ratio	3x, 3.5x, 4x, 4.5x, ... 16x
CPU FSB	50~248MHz

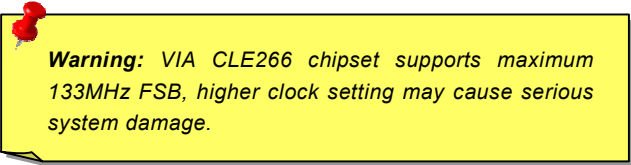

Warning: VIA CLE266 chipset supports maximum 133MHz FSB, higher clock setting may cause serious system damage.

Supported CPU Frequency

Core Frequency = CPU **FSB** Clock * CPU Ratio

CPU	CPU Core Frequency	FSB Clock	Ratio
VIA C3 733	733MHz	133MHz	5.5x
VIA C3 750	750MHz	100MHz	7.5x
VIA C3 800	800MHz	100MHz	8x
VIA C3 800	800MHz	133MHz	6x
VIA C3 866	866MHz	133MHz	6.5x
VIA C3 900	900MHz	100MHz	9x
VIA C3 933	933MHz	133MHz	7x
VIA C3 1G	1GHz	133MHz	7.5x
Celeron 800	800MHz	100MHz	8x
Celeron 900	900MHz	100MHz	9x
Celeron 1G	1GHz	100MHz	10x
Celeron 1.1G	1.1GHz	100MHz	11x
Celeron 1.2G	1.2GHz	100MHz	12x
Pentium III 800E	800MHz	100MHz	8x
Pentium III 850E	850MHz	100MHz	8.5x
Pentium III 866EB	866MHz	133MHz	6.5x
Pentium III 933EB	933MHz	133MHz	7x
Pentium III 1G	1000MHz	133MHz	7.5x
Pentium III 1.13G	1.13GHz	133MHz	8.5x
Pentium III 1.2G	1.2GHz	133MHz	9x
Pentium III 1.3G	1.3GHz	133MHz	10x

Tip: If your system hangs or fails to boot because of overclocking, simply use <Home> key to restore the default setting.



Warning: VIA CLE266 chipset supports maximum 133MHz FSB Bus, higher clock setting may cause serious system damage.

CPU Jumper-less Design

CPU VID signal and [SMBus](#) clock generator provide CPU voltage auto-detection and allow user to set the CPU frequency through [BIOS setup](#), therefore no jumpers or switches are used and the disadvantages of the Pentium based jumper-less designs are eliminated. There will be no worry of wrong CPU voltage detection.

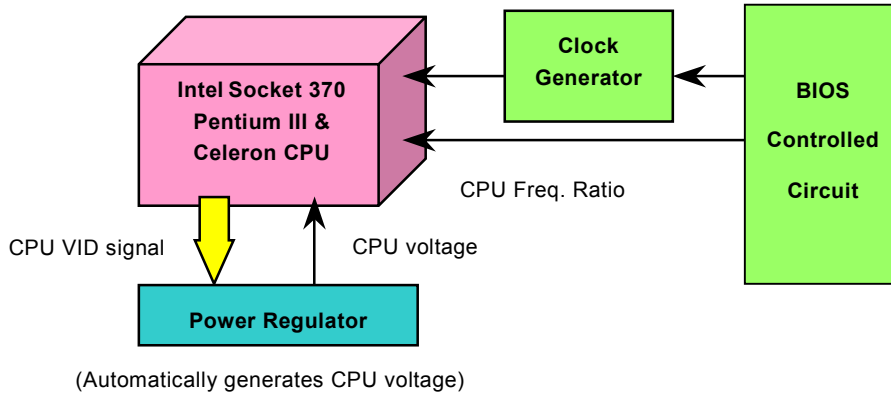

CPU and Housing Fan Connector (With H/W Monitoring)

Plug in the CPU fan cable to the 3-pin **CPUFAN1** connector. If you have chassis fan, you can also plug it on **SYSFAN2** or **SYSFAN3** connector.

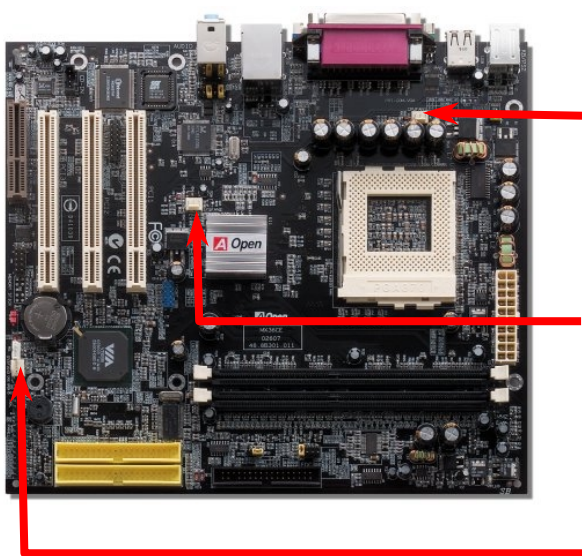

CPUFAN1



SYSFAN2



SYSFAN3

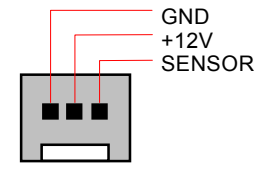

Note: Some CPU fans do not have sensor pin, so that they cannot support fan monitoring.

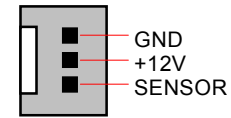

DIMM Socket

This motherboard has two 184-pin DDR [DIMM](#) sockets that allow you to install [PC1600](#) (DDR200) or [PC2100](#) (DDR266) memory up to 2GB.

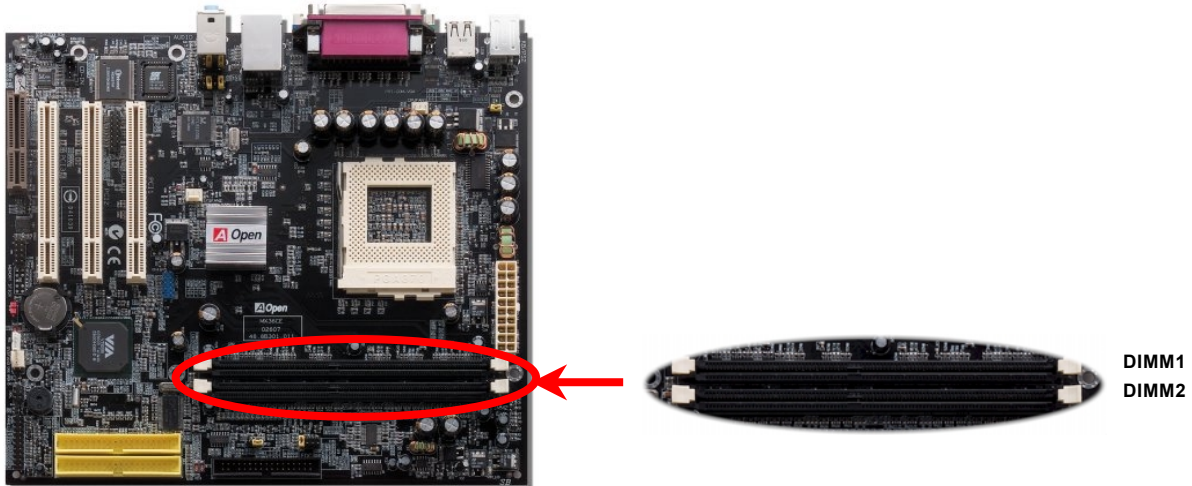

How to Install Memory Modules

Please follow the procedure as shown below to finish memory installation.

1. Make sure the DIMM module's pin face down and match the socket's size as depicted below.

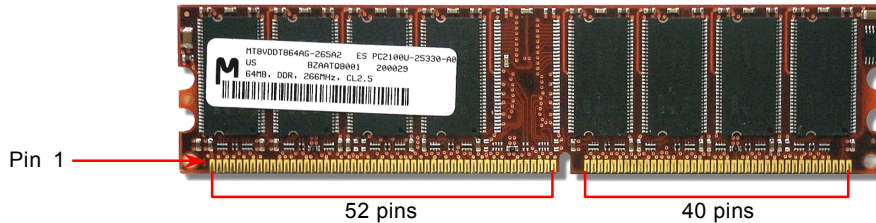

2. Insert the module straight down to the DIMM slot with both hands and press down firmly until the DIMM module is securely in place.

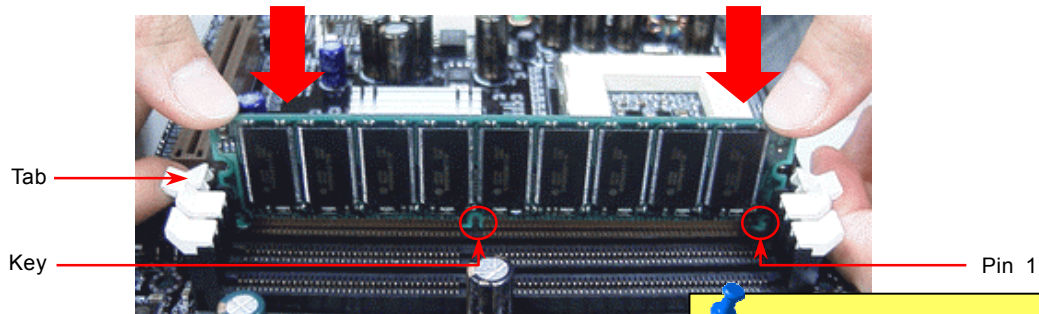

3. Repeat step 2 to finish additional DIMM modules installation.

Note: The tabs of the DIMM slot will close-up to hold the DIMM in place when the DIMM touches the slot's bottom.

DDR 266(PC2100) Supported

DDRAM utilizes the existing SDRAM infrastructure and technology while doubling the nominal bandwidth available to systems. To put it in a simple way, DDRAM is like data going along a two lane highway, while at the same time data in traditional SDRAM go along a one way street. Therefore, it is a more advanced technology that provides a great overall improvement in system performance. DDR266 (PC2100) runs two times faster than the traditional PC133 SDRAM with the speed of Front Side Bus (FSB) up to 266MHz. ($2 \times 133 = 266$). PC2100 is a new naming standard for speed of DDR 266, representing their theoretical speeds of the RAM. The theoretical transfer rate of DDR 266 (PC2100) is 2.1GB/s.

Front Panel Connector

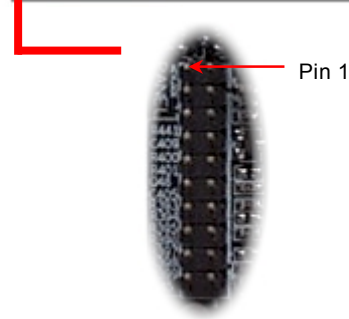
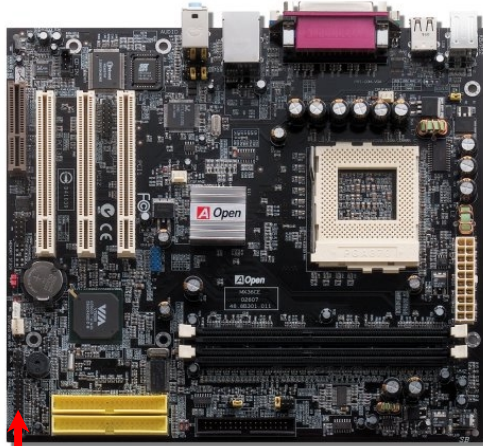

Attach the power LED, EMPI, speaker, power and reset switch connectors to the corresponding pins. If you enable "[Suspend Mode](#)" item in BIOS Setup, the ACPI & Power LED will keep flashing while the system is in suspend mode.

Locate the power switch cable from your ATX housing. It is 2-pin female connector from the housing front panel. Plug this connector to the soft-power switch connector marked **SPWR**.

Suspend Type	ACPI LED
Power on Suspend (S1)	Flashing for every 1/4 second
Suspend to RAM (S3)	Flashing for every second
Suspend to Disk (S4)	The LED will be turned off

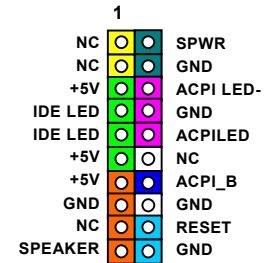
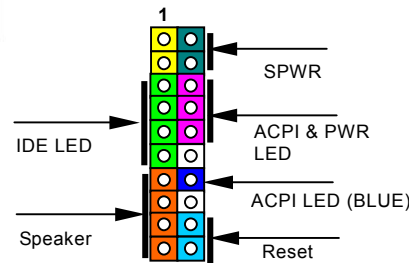





















AC Power Auto Recovery

A traditional ATX system should remain power off when AC power resumes from power failure. This design is inconvenient for a network server or workstation, without an UPS, which has to keep power-on all the time. This motherboard implements an AC Power Auto Recovery function to solve this problem.

ATX Power Connector

The ATX power supply uses 20-pin connector shown below. Make sure you plug in the right direction.

+12V			+5V
5VSB			+5V
PW-OK			-5V
COM			COM
+5V			COM
COM			COM
+5V			PS-ON
COM			COM
+3.3V			-12V
+3.3V			+3.3V

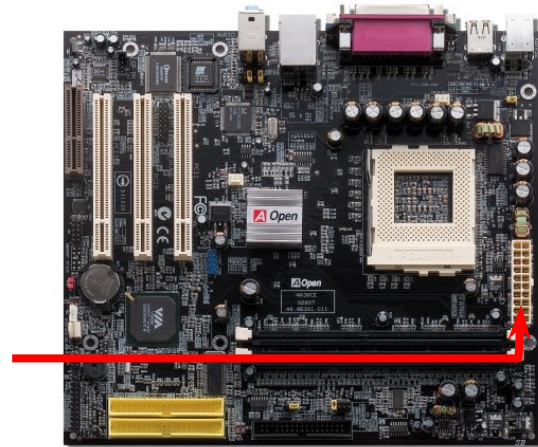
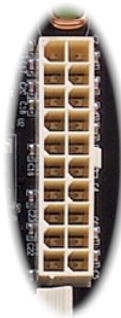

STBY LED

STBY LED is AOpen's considerate design that we aim at providing you friendly system information. The STBY LED will light up when power is provided to the motherboard. This is a convenient indication for you to check the system power status in many circumstances such as power on/off, stand-by mode and RAM power status during [Suspend to RAM mode](#).

System
Power LED

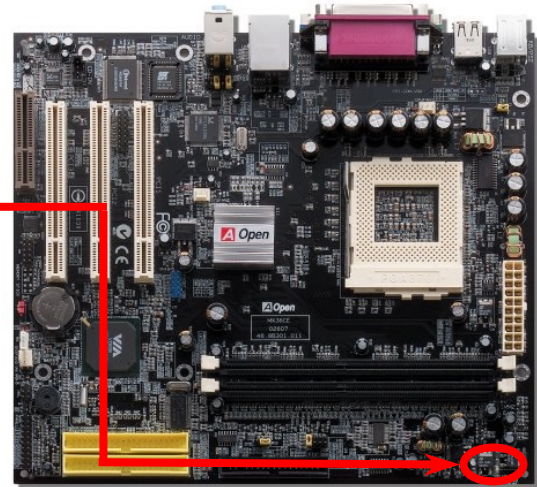

Warning: Do not install or remove the DIMM module or others devices when the STBY LED lights on.

JP28 Keyboard/Mouse Wake-up Jumper

This motherboard provides PS2 keyboard / mouse wake-up function. You can use JP28 to enable or disable this function, which could resume your system from suspend mode with keyboard or mouse. The factory default setting is set to “Disable”(1-2), and you may enable this function by setting the jumper to 2-3.

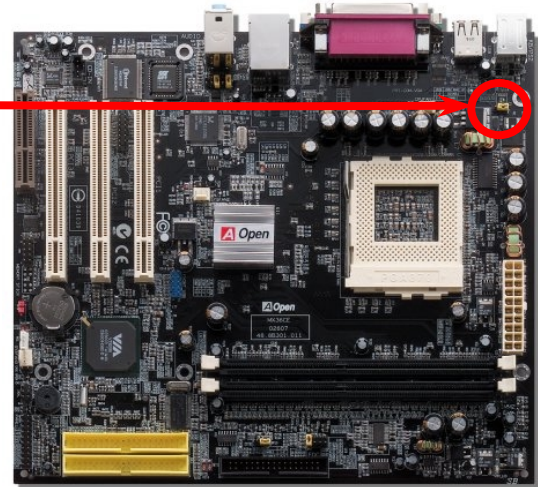
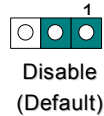

IDE and Floppy Connector

Connect 34-pin floppy cable and 40-pin IDE cable to floppy connector FDD and IDE connector. Be careful of the pin1 orientation; wrong orientation may cause system damage.

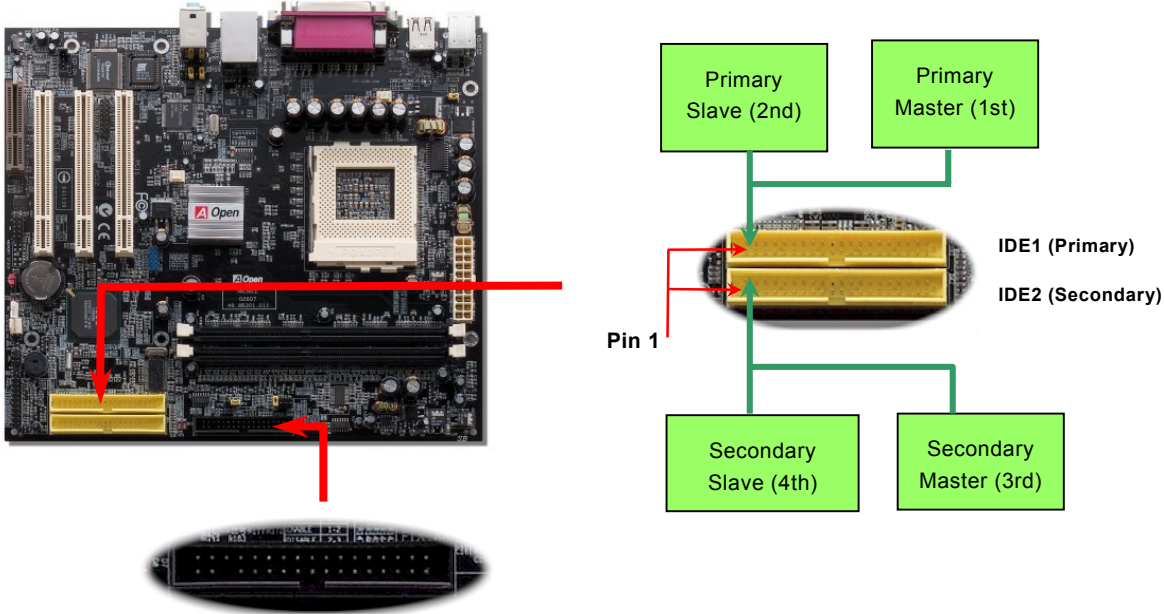

IDE1 is also known as the primary channel and IDE2 as the secondary channel. Each channel supports two IDE devices that make a total of four devices. In order to work together, the two devices on each channel must be set differently to **Master** and **Slave** mode. Either one can be the hard disk or the CDROM. The setting of master or slave mode depends on the jumper on your IDE device, so please refer to your hard disk and CDROM manuals accordingly.



Warning: *The specification of the IDE cable is a maximum of 46cm (18 inches); make sure your cable does not exceed this length.*



Tip: *For better signal quality, it is recommended to set the far end side device to master mode and follow the suggested sequence to install your new device. Please refer to above diagram.*

ATA/133 Supported



This motherboard supports [ATA66](#), [ATA100](#) or [ATA133](#) IDE devices. The following table lists the transfer rate of IDE PIO and DMA modes. The IDE bus is 16-bit, which means every transfer is two bytes. As the hard drive industry introduces faster and higher capacity hard drives, the current Ultra ATA/100 interface causes a data bottleneck between the drive and the host computer. To avoid this problem, hard disk manufacturers have introduced the new Ultra ATA-133 interface technology. Compared to traditional ATA/100, ATA/133 has up to 33 percent increase in interface speed with transfer rate of 133MB/s. ATA/133 performance is ideal for new operating systems, such as Window XP, that demand more storage space and faster data transfer rates from more responsive computing experiences.

To make good use of this new technology and enjoy its best performance, we recommend you to pair your system with a hard disk equipped with ATA/133 technology so that your system's need for speed on this motherboard can be satisfied.

Mode	Clock Period	Clock Count	Cycle Time	Data Transfer Rate
PIO mode 0	30ns	20	600ns	$(1/600\text{ns}) \times 2\text{byte} = 3.3\text{MB/s}$
PIO mode 1	30ns	13	383ns	$(1/383\text{ns}) \times 2\text{byte} = 5.2\text{MB/s}$
PIO mode 2	30ns	8	240ns	$(1/240\text{ns}) \times 2\text{byte} = 8.3\text{MB/s}$
PIO mode 3	30ns	6	180ns	$(1/180\text{ns}) \times 2\text{byte} = 11.1\text{MB/s}$
PIO mode 4	30ns	4	120ns	$(1/120\text{ns}) \times 2\text{byte} = 16.6\text{MB/s}$
DMA mode 0	30ns	16	480ns	$(1/480\text{ns}) \times 2\text{byte} = 4.16\text{MB/s}$
DMA mode 1	30ns	5	150ns	$(1/150\text{ns}) \times 2\text{byte} = 13.3\text{MB/s}$
DMA mode 2	30ns	4	120ns	$(1/120\text{ns}) \times 2\text{byte} = 16.6\text{MB/s}$
ATA 66	30ns	2	60ns	$(1/60\text{ns}) \times 2\text{byte} \times 2 = 66\text{MB/s}$
ATA 100	20ns	2	40ns	$(1/40\text{ns}) \times 2\text{byte} \times 2 = 100\text{MB/s}$
ATA 133	15ns	2	30ns	$(1/30\text{ns}) \times 2\text{byte} \times 2 = 133\text{MB/s}$

IrDA Connector

The IrDA connector can be configured to support wireless infrared module, with this module and application software such as Laplink or Windows 95 Direct Cable Connection, the user can transfer files to or from laptops, notebooks, PDA devices and printers. This connector supports HPSIR (115.2Kbps, 2 meters) and ASK-IR (56Kbps).

Install the infrared module onto the **IrDA** connector and enable the infrared function from BIOS Setup, [UART2 Mode](#), make sure to have the correct orientation when you plug in the IrDA connector.

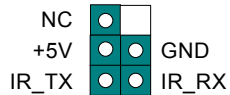

Pin 1

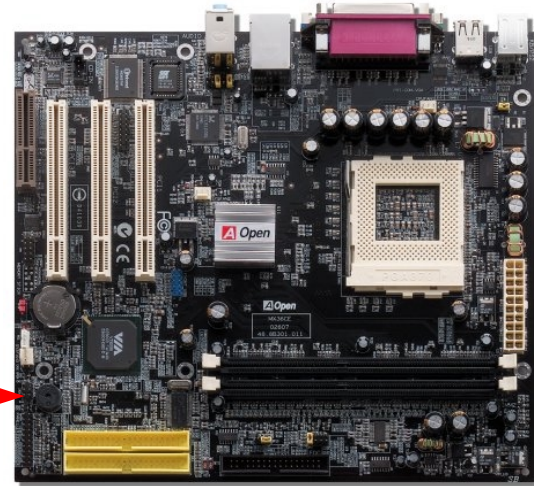
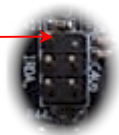

WOL (Wake on LAN)

This feature is very similar to Wake On Modem, but it goes through local area network. To use Wake On LAN function, you must have a network card with a chipset supporting this feature, and connect a cable from LAN card to motherboard WOL connector. The system identification information (probably IP address) is stored on network card and because there is a lot of traffic on the Ethernet, you need to install network management software, such as ADM, for the checking of how to wake up the system. Note that, at least 600mA ATX standby current is required to support the LAN card for this function.

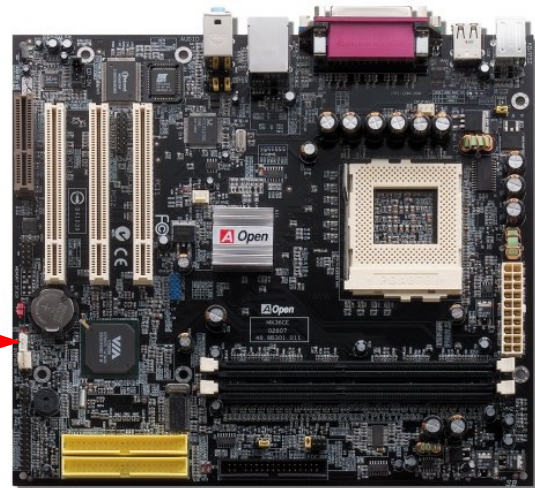
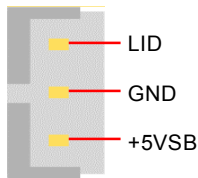

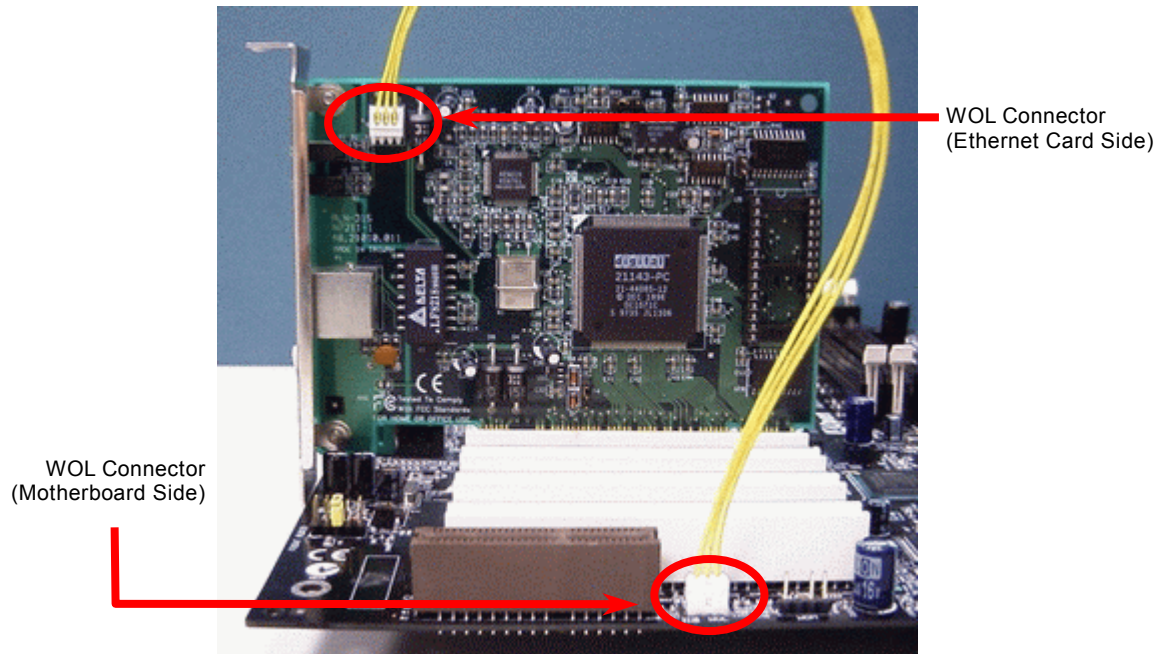

Note: This picture is for example only; it may not look exactly the same with the motherboard you purchased.



CNR (Communication and Network Riser) Expansion Slot

[CNR](#) is a riser card specification to replace the [AMR \(Audio/Modem Riser\)](#) that supports V.90 analog modem, multi-channel audio, and phone-line based networking. Owing to CPU computing power getting stronger, the digital processing job can be implemented in main chipset and share CPU power. The analogy conversion ([CODEC](#)) circuit requires a different and separate circuit design, which is put on CNR card. This motherboard implements sound CODEC on board, but reserve CNR slot for the option of modem function. Note that you can still use PCI modem card.

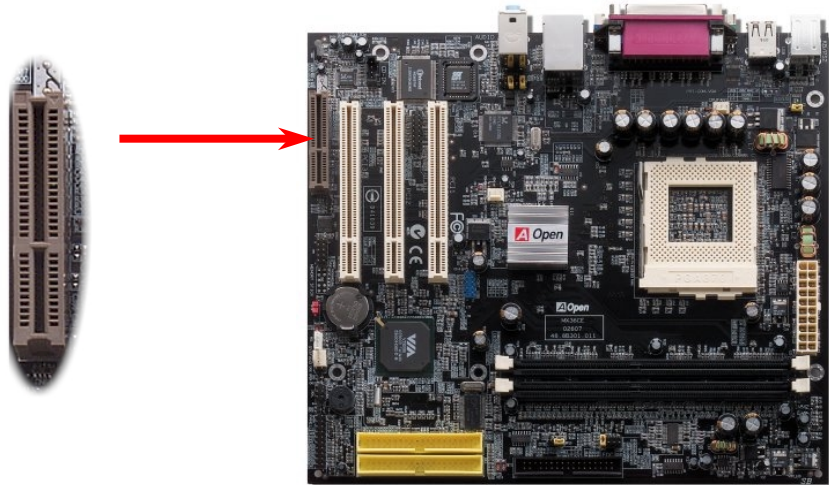

Open

Support Realtek 10/100 Mbps LAN onboard

This motherboard has a fast Ethernet controller on chip. On the strength of Realtek 10/100 LAN onboard, which is a highly-integrated Platform LAN Connect device, it provides 10/100M bps Ethernet for office and home use, the Ethernet connector is located on top of USB connectors.

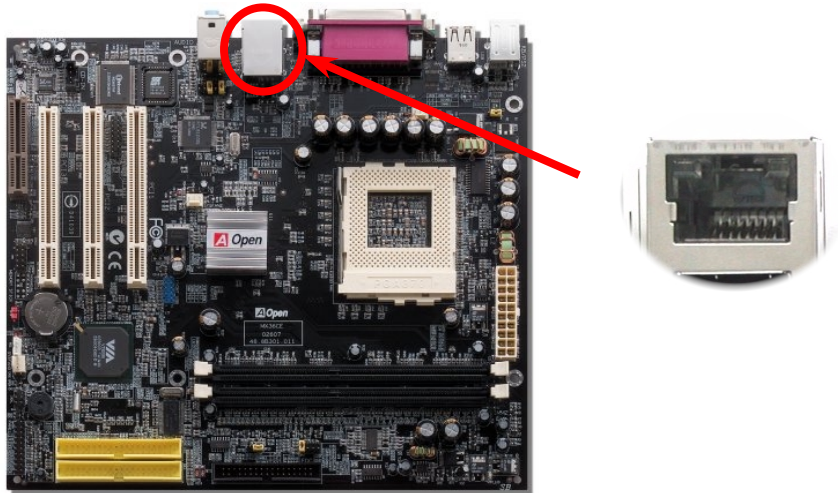

JP13 LAN Select Jumper

This jumper allows you to enable or disable the LAN onboard function by adjusting the position of yellow cap.

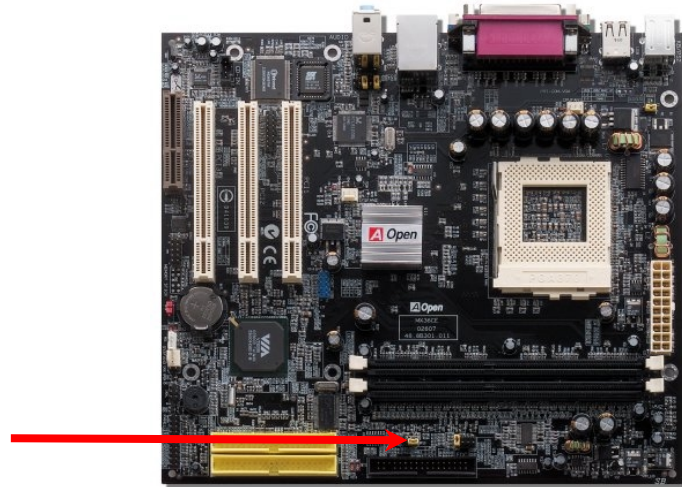
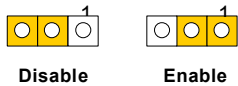

Color Coded Back Panel

The onboard I/O devices are PS/2 Keyboard, PS/2 Mouse, COM1 and 15-pin D-Sub connector, Printer, [four USB](#), AC97 sound and game ports. The view angle of drawing shown here is from the back panel of the housing.

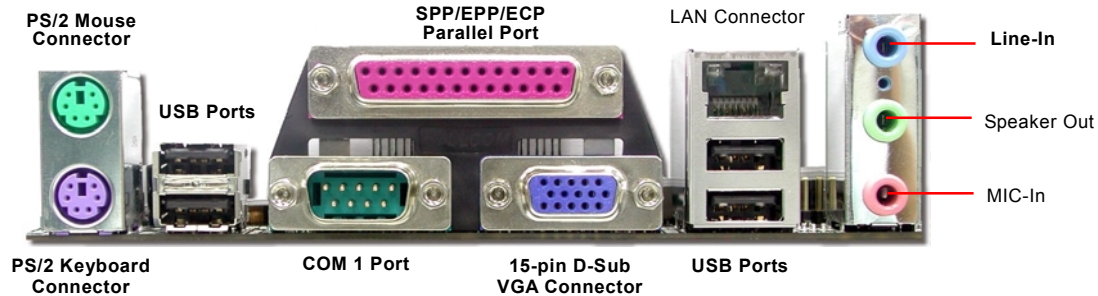

PS/2 Keyboard:	For standard keyboard, which is using a PS/2 plug.
PS/2 Mouse:	For PC-Mouse, which is using a PS/2 plug.
USB Port:	Available for connecting USB devices.
Parallel Port:	To connect with SPP/ECP/EPP printer.
COM1/COM2 Port:	To connect with pointing devices, modem or others serial devices.
VGA Connector:	To connect with PC monitor.
Speaker Out:	To External Speaker, Earphone or Amplifier.
Line-In:	Comes from the signal sources, such as CD/Tape player.
MIC-In:	From Microphone.

COM2 Connector

This motherboard provides two serial ports. One of them are on back panel connector, the other is on the middle left of the board. With proper cable, you can connect it to the back panel of chassis.

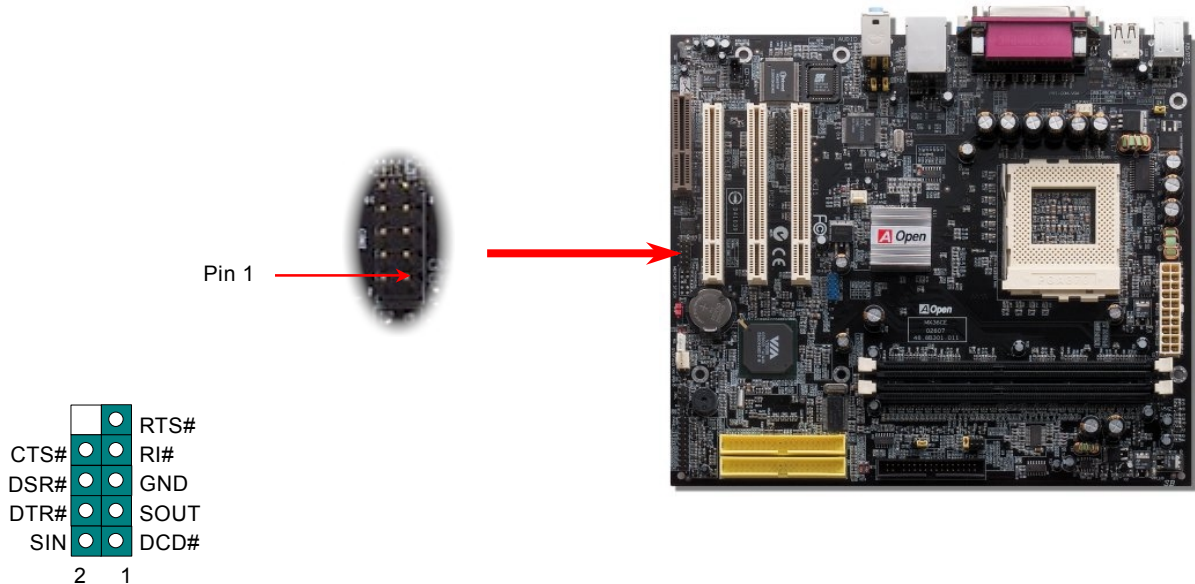

Support USB2.0 Port



This motherboard provides six [USB](#) ports to connect USB devices such as mouse, keyboard, modem, printer, etc. There are four connectors on the back panel. You can use proper cables to connect USB devices from back panel or connect USB2 header to the front panel of chassis.

Compared to traditional USB 1.0/1.1 with the speed of 12Mbps, USB 2.0 has a fancy speed up to 480 Mbps which is 40 times faster than the traditional one. Except for the speed increase, USB 2.0 supports old USB 1.0/1.1 software and peripherals, offering impressive and even better compatibility to customers. On this motherboard, all six ports support USB 2.0 function.

1	2		
+5V	●	●	+5V
SBD2-	●	●	SBD3-
SBD2+	●	●	SBD3+
GND	●	●	GND
KEY	□	●	NC
9	10		

Pin 1

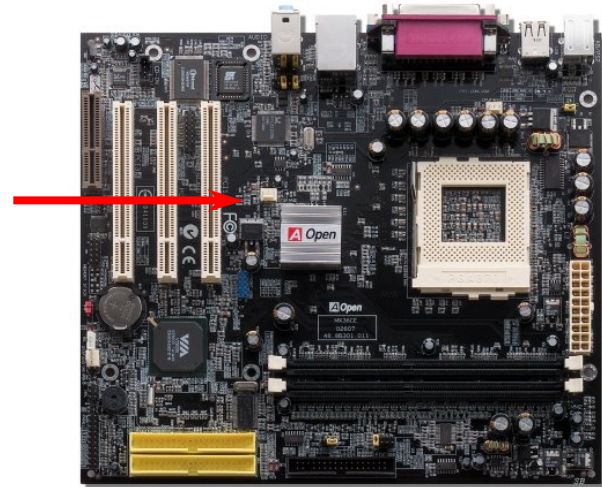
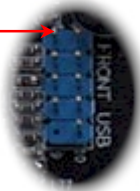

CD Audio Connector

This **black** connector is used to connect CD Audio cable from CDROM or DVD drive to onboard sound.

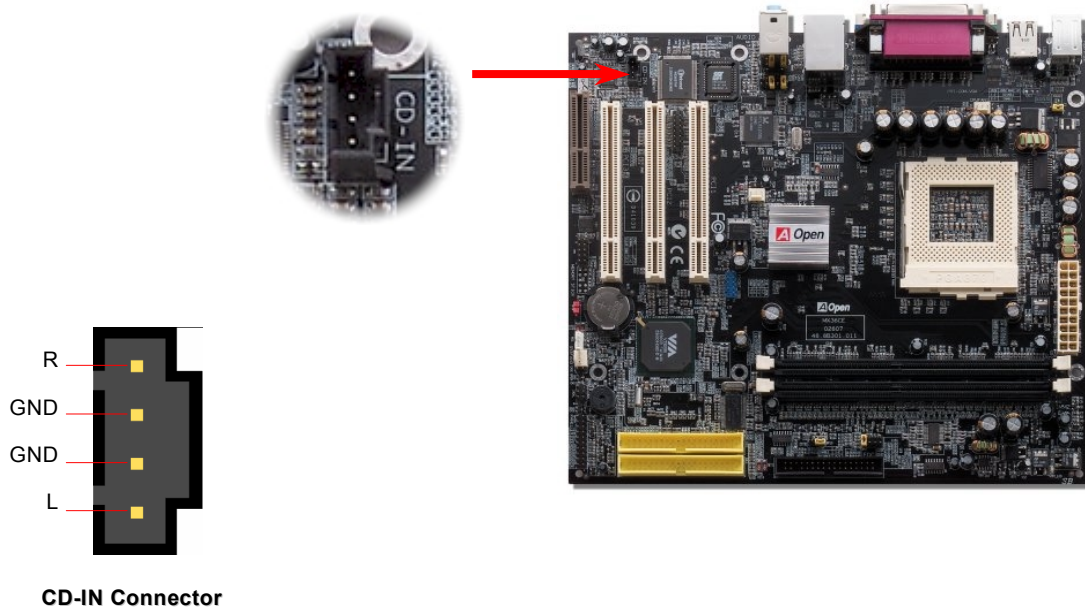

Case Open Connector

The “CASE OPEN” header provides chassis intrusion-monitoring function. To make this function works, you have to enable it in the system BIOS, connect this header to a sensor somewhere on the chassis. So, whenever the sensor is triggered by lights or by the opening of the chassis, the system will beep to inform you. Please be informed that this useful function only applies to advanced chassis, you may purchase an extra sensor, attach it on your chassis, and make a good use of this function.

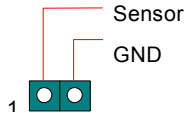

Pin 1

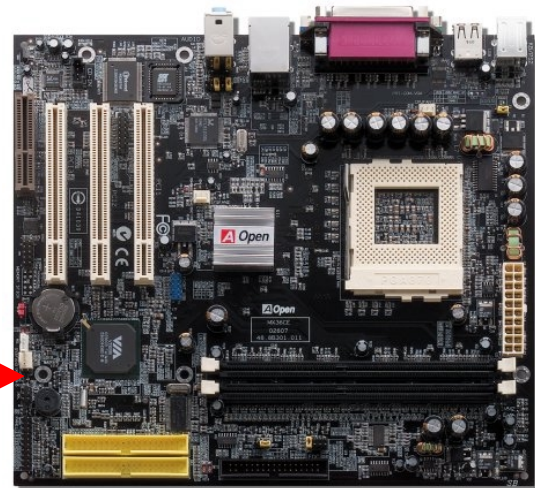

Game Port Bracket Supported

This motherboard comes with a game port (Joystick-Midi) for you to connect any midi devices or joysticks. To use this function you have to have a joystick module and connect it with a game port cable to this port on the motherboard.

Joystick Module
(User Upgrade Optional)
(This photo is for example only)

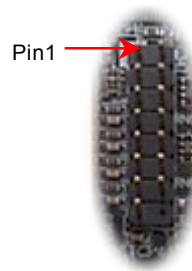
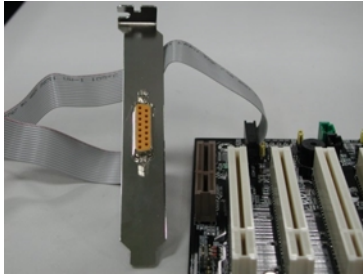

JST-MIDI Port

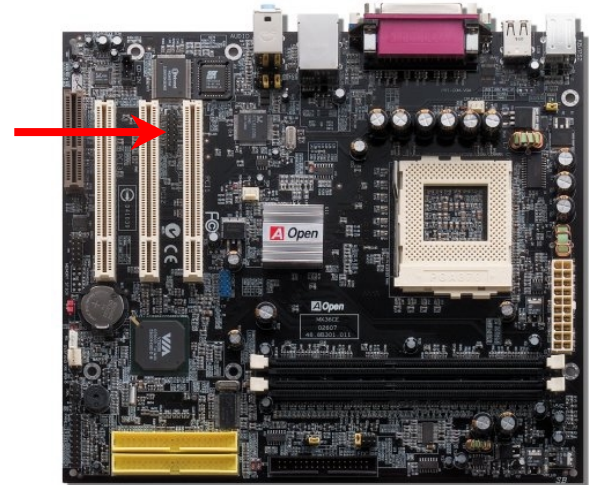

	1	
+5V	●	+5V
JAB1	●	JBB1
JACX	●	JBCX
GND	●	MIDI_TXD
GND	●	JBCY
JACY	●	JBB2
JAB2	●	MIDI_RXD
+5V	●	KEY



Front Audio Connector

If the housing is designed with an audio port on the front panel, you'll be able to connect onboard audio to front panel through this connector. Please remove the jumper cap from the front audio connector before you connect the cable. Do not remove this yellow jumper cap if your housing does not have an audio port on the front panel.

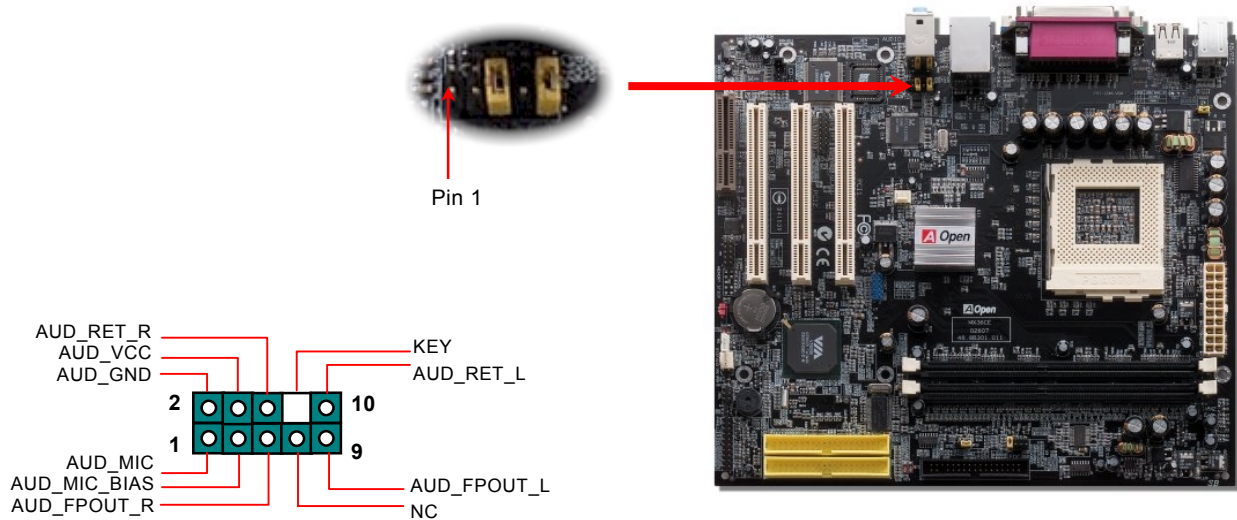

Battery-less and Long Life Design

This Motherboard implements [Flash ROM](#) and a special circuit that allows you to save your current CPU and CMOS Setup configurations without the need of a battery. The RTC (real time clock) can also keep running as long as the power cord is plugged. If you lose your CMOS data by accident, you can just reload the CMOS configurations from Flash ROM and the system will recover as usual.

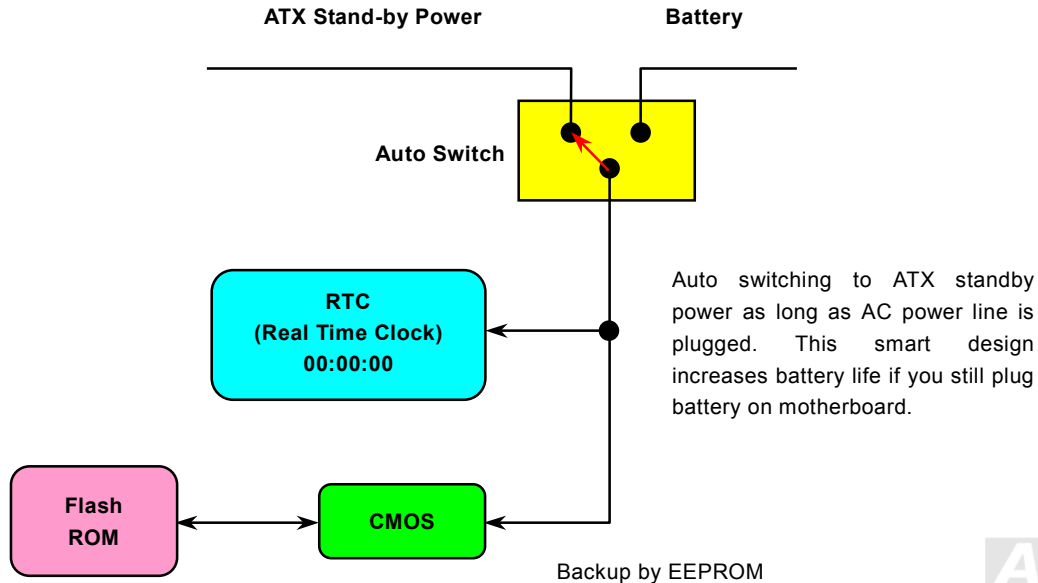

Hardware Monitoring

This motherboard implements a hardware monitoring system. As you turn on your system, this smart design will monitor your system's working voltage, fan status and CPU temperature. If any of these systems' status goes wrong, there will be an alarm through the AOpen [Hardware Monitoring Utility](#) to warn the user.

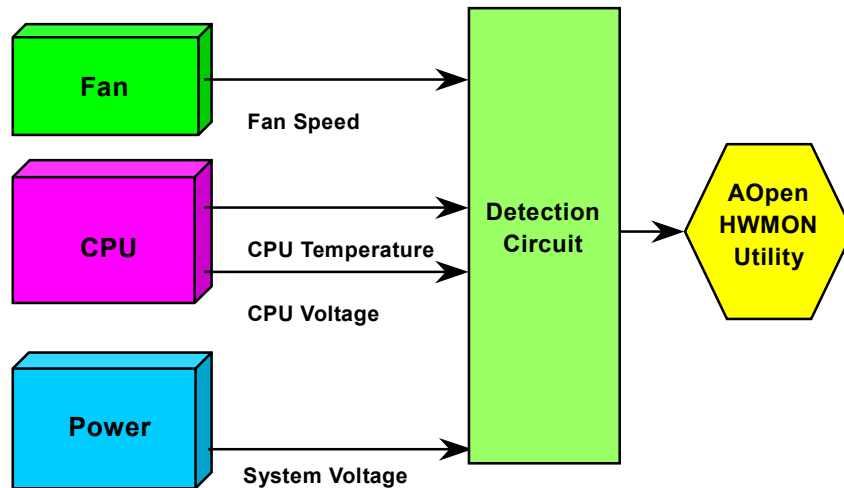

Over-current Protection

The Over Current Protection is a popular implementation on ATX 3.3V/5V/12V switching power supply. However, the new generation CPU uses different voltage with a regulator to transfer 12V to CPU voltage (for example, 2.0V), and thus makes 5V over current protection useless. This motherboard is with switching regulator onboard supporting CPU over-current protection; in conjunction with 3.3V/5V/12V power supply provide the full line over-current protection.

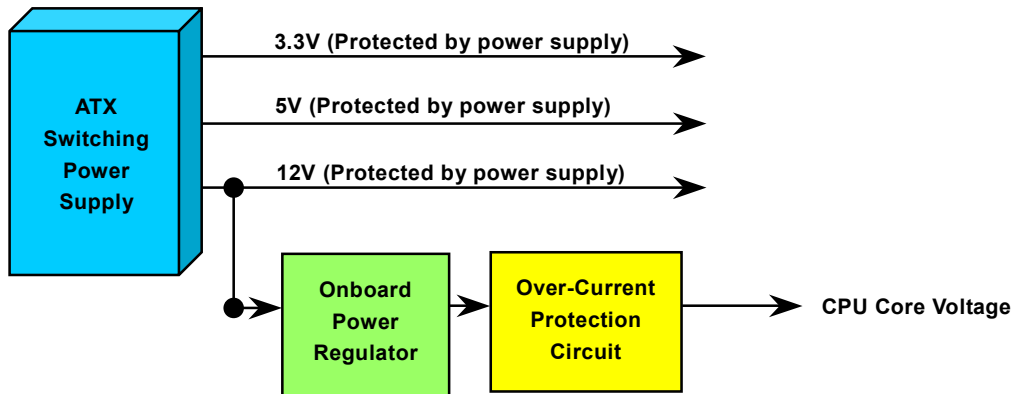

Note: Although we have implemented protection circuit and tried to prevent any human operating mistake, certain risks might still happen when CPU, memory, HDD or add-on cards installed on this motherboard is damaged due to component failure, human operating error or other unknown natural reasons. AOpen cannot guarantee that the protection circuit will always work perfectly.

AOpen

Resetable Fuse

Traditional motherboard uses fuses to prevent Keyboard and [USB](#) port from over-current or shortage. These fuses are soldered onboard that when it is broken (function to protect motherboard), user cannot replace them otherwise malfunction or damage may occur.

With expensive Resetable Fuse, the motherboard can be resumed back to normal function even after the fuse had done its protection job.

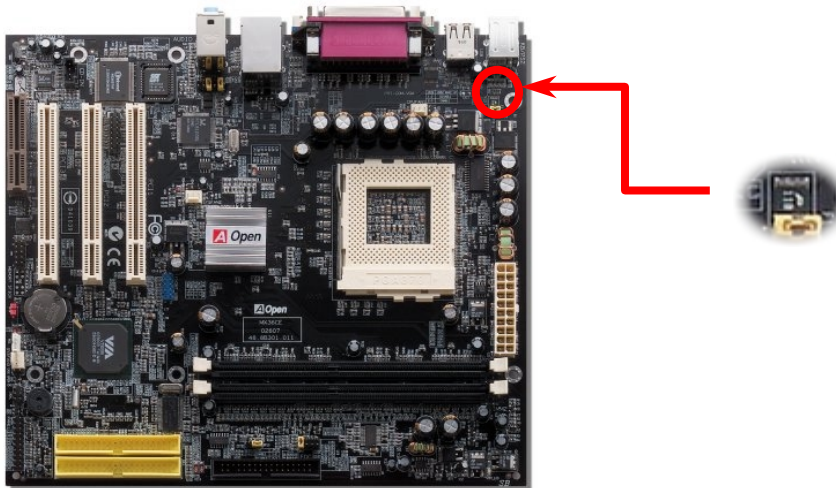

Layout (Frequency Isolation Wall)

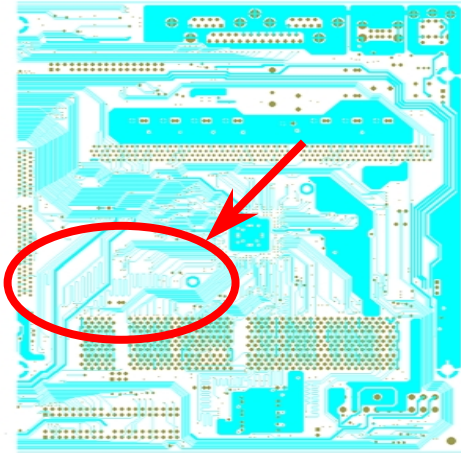

Note: This diagram is only for example; it may not look exactly the same with the motherboard you purchased.

For high frequency operation, especially overclocking, layout is the most important factor to make sure both chipset and CPU are working in stable condition. The layout of this motherboard implements AOpen's unique design called "Frequency Isolation Wall". Separating each critical portion of motherboard into regions, where each region operates in a same or similar frequency range, we can avoid cross talk and frequency interference between each region's operations and condition. The trace length and route must be calculated carefully. For example, the clock trace must be equal to length (not necessarily as short as possible) so that clock skew will be controlled within few a pico second ($1/10^{12}$ Sec)

Vivid BIOS technology



Have you been fed up with the conservative and immutable POST screen? Let's rule out the tradition idea that POST screen are stiff and frigid, and let AOpen show you the newly developed VividBIOS to experience the lively vivid colorful POST screen!

Unlike earlier graphic POST screen which could occupy the whole screen and mask text information during POST, AOpen VividBIOS deals with graphics and texts separately, and makes them running simultaneously during POST. With this innovative design, VividBios now brings you a beautiful and sleek 256 colors screen without missing any important information shown on POST screen.

In addition, the limited space of BIOS ROM is another big issue. When all of the traditional BIOS can only show space-consuming and uncompressed Bitmap, AOpen has considerably tuned the BIOS to next generation, to recognize the smaller-sized GIF format and even dynamic-showing GIF animation.



Vivid BIOS shares the same fundamental technology with Open JukeBox CD Player, you may use the same EzSkin utility to

change your Vivid BIOS screen or to download your favorite Open JukeBox skin. If you see this little logo  shown beside your model name on the BIOS download page, <http://english.aopen.com.tw/tech/download/skin>, it is assured that your motherboard supports this innovative feature!





The noise is gone!! ---- SilentTek



As the clock of CPU keeps rocketing higher and higher, it inevitably brings higher heat and system temperature in a relative way. The way we deal with this heat problem, however, is to spare no effort to add one fan after another to protect our pampered system, expecting these fans could cool down our machine as much as they could.

But at the same time, we believe that same users are affected terribly by the irritating noises of these fans while working with their PC. As a matter of fact, we do not have to get our fans running at such a high speed in most cases; on the contrary, we discovered that having your fans running at appropriate time and speed not only reduces the noise, but also consumes the least power the system needs, so as to prevent over-wasting of energy resource.

Today, AOpen is honored to bring you a new overall solution, SilentTek, to make your system quiet. To collocate with hardware circuit and the utility under Windows, SilentTek combined "Hardware-Status Monitoring", "Overheat Warning" and "Fan Speed Control" with user-friendly interfaces to provide you a perfect balance among noises, system performance and stability.

The first image you have here is the Voltage Status page. You can find current status of all voltages and set your expected margins of warning level.

In “Temp/Fan/Case” page, you may get aware of the current temperature of CPU and the heat inside chassis. Also, you can check if fans are running properly.

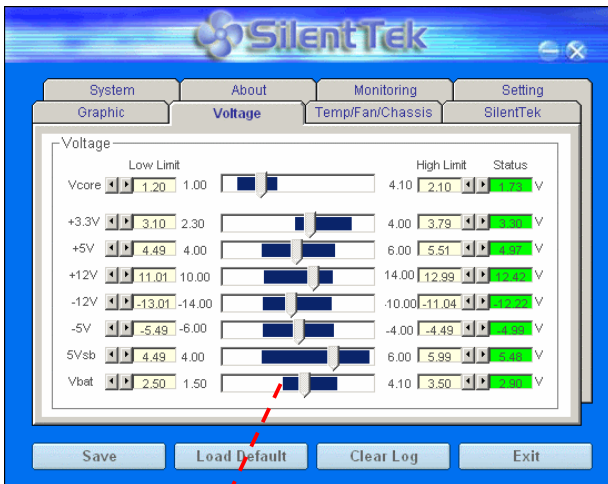

You may check your system voltage from the indicating bar here.

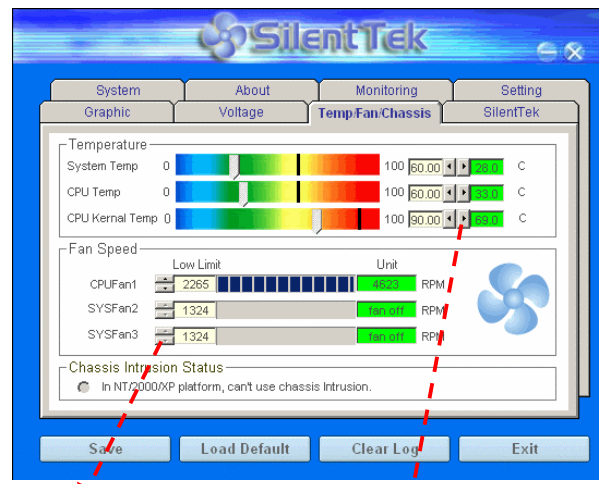

Of course, you may set your defaulted lowest margin for your fans and SilentTek would also pop up a message box to alarm you when the fan is rotating slower than this specified speed.

You may set the highest margin of your CPU and system temperature as default, and SilentTek would pop up a message box to alert you with alarm when the temperature goes beyond the specified margin.

The following page is surely the most important part of this utility. You may control the rotation speed of specific fans that you have got the options inside in this page.

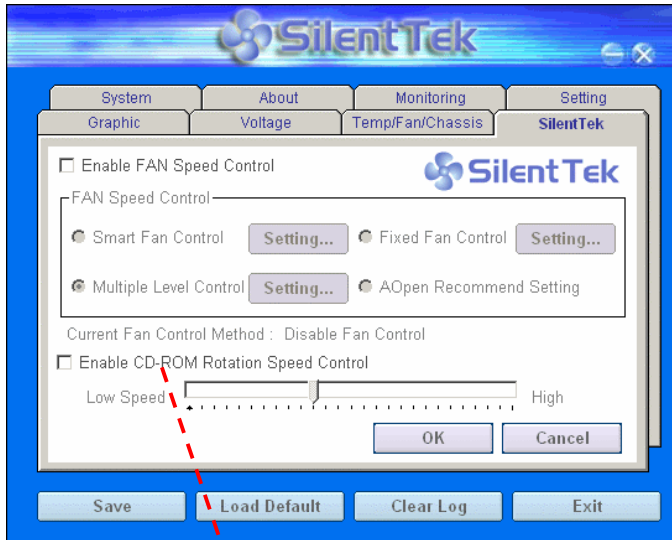

CD-ROM Rotation Speed Control: by enabling the CD-ROM Rotation Speed Control, you can adjust the rotation speed of your CD-ROM. When you set the speed to high level, the CD-ROM will work at its fastest speed and it will run at basic required speed while you set the value to low speed.

1. **Smart FAN Control:** This is the default setting of SilentTek and can be used for any branded computer housing. With a special algorithm developed by AOpen, the fan speed is automatically adjusted by the factors of CPU and ambient temperature. Ease-of-use and trouble free at your service.
2. **Fixed FAN Control:** Under this setting, a desired fan speed is set fixed when operating.
3. **Multiple Level Control:** This is the most versatile setting that allows you to set fan speed in relation to temperature. You may find that this setting fits you best.
4. **AOpen Recommend Setting:** This setting is designed specifically for AOpen housing. A series of lab tests were conducted under the real world scenario to determine optimum fan speed to reduce noise level within CPU working condition and temperature. Most of the time, the fan would remain still when CPU is not fully utilized.

Note: Due to hundreds different brands of fan on the market, inaccuracy may happen in some cases when you had your rotation speed adjusted. It is still under the criterion and please rest assured that it won't cause any problem to your system.

Driver and Utility

There are motherboard drivers and utilities in [AOpen Bonus CD](#). You don't need to install all of them to boot your system. But after you finish the hardware installation, you have to install your operation system first (such as Windows 2000) before you install any drivers or utilities. Please refer to your operation system's installation guide.

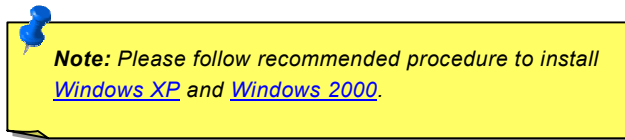

Autorun Menu from Bonus CD

You can use the autorun menu of Bonus CD. Choose the utility and driver and select model name.

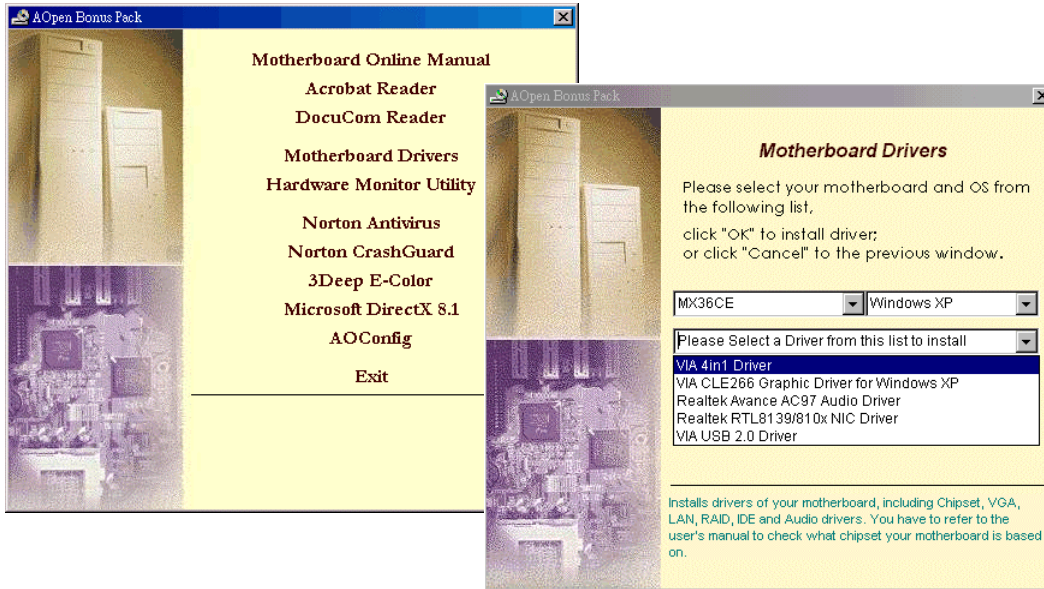

Installing Windows 95

1. Install Windows 95 OSR2 v2.1, 1212 or 1214 version and later with USB support. Otherwise, you need to install USBSUPP.EXE.
2. Install the [VIA 4 in 1 driver](#), which includes VIA AGP Vxd driver, VIA ATAPI Vendor Support driver and VIA registry (INF) program.
3. Finally, Install other add-on cards and their drivers.

Installing Windows 98

1. Enable USB Controller in BIOS Setup > Advanced Chipset Features > [OnChip USB](#), to make BIOS fully capable of controlling IRQ assignment.
2. Install Window 98 into your system.
3. Install the [VIA 4 in 1 driver](#), which includes VIA AGP Vxd driver, IRQ Routing, VIA ATAPI Vendor Support driver and VIA registry (INF) program.
4. Finally, Install other add-on cards and their drivers.

Installing Windows 98 SE, Windows ME & Windows2000/XP

If you are using Windows® 98 Second Edition, Windows® Millennium Edition or Windows® 2000/XP, you do not need to install the 4-in-1 driver as the IRQ Routing Driver and the ACPI Registry are already incorporated into the operating system. Users with Windows® 98 SE may update the VIA Registry INF and AGP drivers by installing them individually.

Please refer to [VIA Technologies Inc.](http://www.via.com/) for latest version of 4 in 1 driver:

<http://www.via.com/>

Installing VIA 4 in 1 Driver

You can install the VIA 4 in 1 driver ([IDE_Bus_master](#) (For Windows NT use), VIA ATAPI Vendor Support Driver, VIA [AGP](#), IRQ Routing Driver (For Windows 98 use), VIA Registry (INF) Driver) from the Bonus Pack CD Autorun menu.

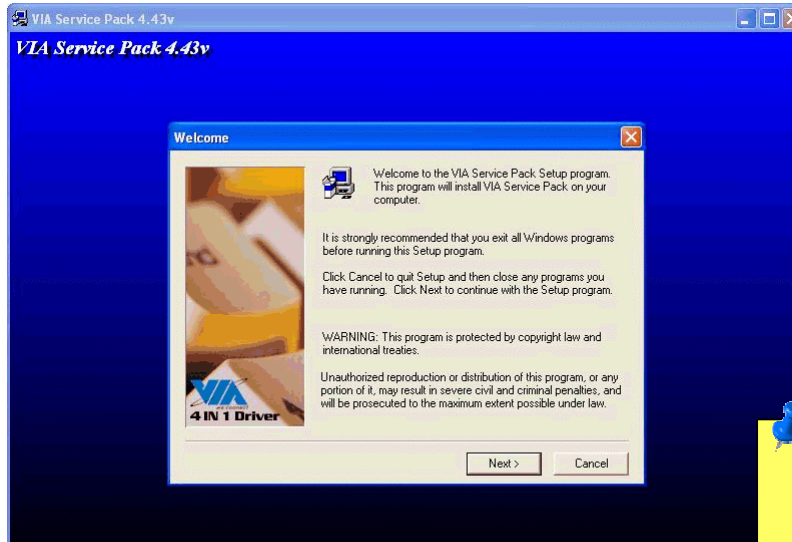

Warning: To take advantage of ATA133, it is a must to install the latest version of VIA 4in1 driver in the Bonus CD. For Windows2000, it cannot supports ATA133 even after installing the latest version of VIA 4-in-1 driver until the new release of Service-Pack 3 from Microsoft.

Note: Installing this Bus Master IDE driver may cause Suspend to Hard Drive failure.

Warning: If you want to uninstall the VIA AGP Vxd driver, please remove the AGP card driver first. Otherwise, the screen may go black when rebooting after the un-installation.

Installing Onboard Sound Driver

This motherboard comes with an [AC97 CODEC](#) and the sound controller is in VIA South Bridge chipset. You can find the audio driver from the Bonus Pack CD Autorun menu.

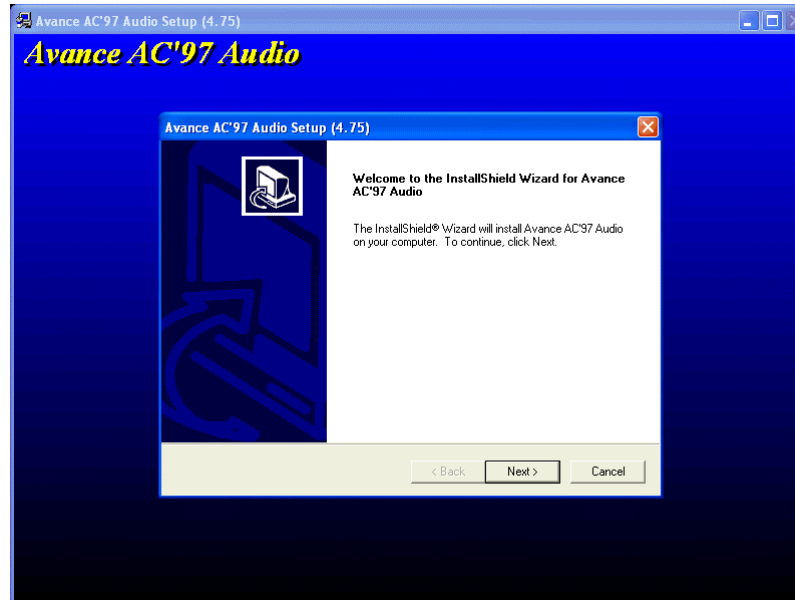

Installing VGA Driver

You can find the VIA CLE266 VGA driver from the autorun menu of Bonus Pack CD.

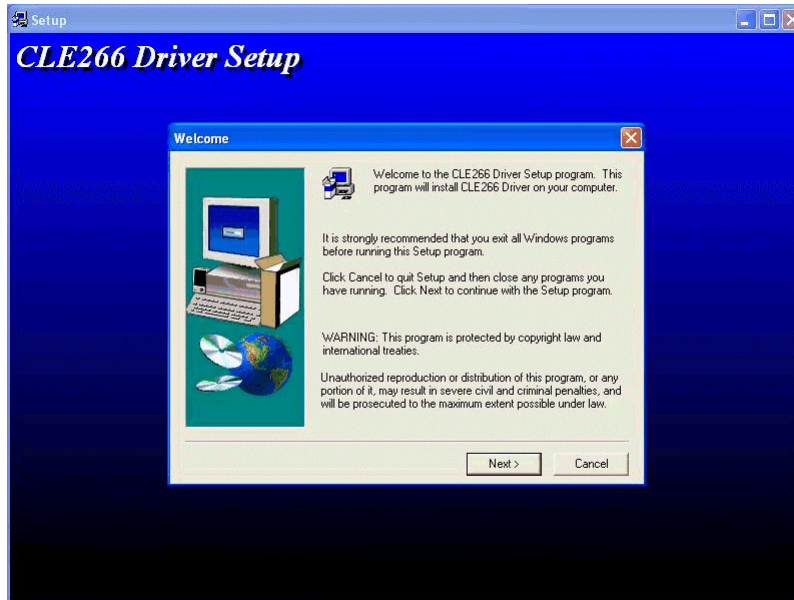

Installing LAN Driver

Introduction:

This document describes the procedure to install Windows 95 (Golden version), Win95A, OSR2, Windows NT v4.0 driver for Realtek RTL8139 PCI Fast Ethernet adapter.

[Windows 95 (Golden version), Win95A and OSR2]

Installing driver procedure on Microsoft Windows 95 :

-
1. Ask you to select which driver you want to install, select "Driver from disk provided by hardware manufacturer".
 2. Specify the setup file pathname
[CD-ROM]:\Driver\LAN\RTL8100\Windows\95\WIN95A (for Windows 95 and Win95A) or
[CD-ROM]:\Driver\LAN\RTL8100\Windows\95\W95OSR2 (for Windows 95 OSR2).
 3. Windows 95 will appear some messages to insert Windows 95 system disk to complete setup step.
 4. Windows 95 will finish the other installation procedure automatically, then you restart the system.

[Windows NT 3.5, 3.51 & 4.0]

Installing driver procedure on Microsoft Windows NT :



When you are in Windows NT :

1. In the Main group of NT, select the "Control Panel" icon.
2. In the Control Panel window, choose the "Network" icon.
3. In the Network Settings dialog box, choose the "Add Adapter" button. The Add Network Adapter dialog box appears.
4. In the list of network cards, select "<other> Requires disk from manufacturer", and then press <Enter> button.
5. Enter drive and pathname

[CD-ROM]:\Driver\LAN\RTL8100\Windows\NT (for NT 4.0) which is the path where the setup file OEMSETUP.INF is located, and then choose the OK button.

6. The screen will appear "Select Line Speed" dialog box which is provide by RTL8139.SYS driver. The default value is "auto" so that the RTL8139 PCI Fast Ethernet adapter and its driver RTL8139.SYS will auto-detect the line speed, 10 Mb or 100Mb, while the RTL8139.SYS is loading. The other values, "10" or "100", are only used when you want to forced RTL8139 PCI Fast Ethernet adapter to 10Mb or 100Mb.
7. The screen will appear "Input EthernetID" dialog box which is provide by RTL8139.SYS driver. This option is only required when you have more than one Realtek RTL8139 PCI Fast Ethernet adapters on this computer. Select "SKIP" if only one adapter is installed on this computer.
8. "Bus Location" display in next screen. Your machine contains more than one hardware bus, please select the Bus Type and Bus number on which your network adapter card is installed.
9. NT will then perform the binding process. If any additional network software options were installed, you may be prompted for specific information for these packages.
10. Restarting your system you will acquire network service.

NOTES:

*** Installing Multiple LAN Adapters:**

Enter Windows NT and follow above setup procedure step 2, in the "Network Settings" dialog box, choose the "Configure.." button. The "Input Ethernet ID" dialog box appears and input adapter's Ethernet ID. Last step to select OK and close NETWORK SETUP. Select SKIP if only one adapter is installed on this computer.

[Windows 98, Windows ME, Windows 2000 and Windows XP]

Please find the LAN driver from the Bonus Pack CD Autorun menu.

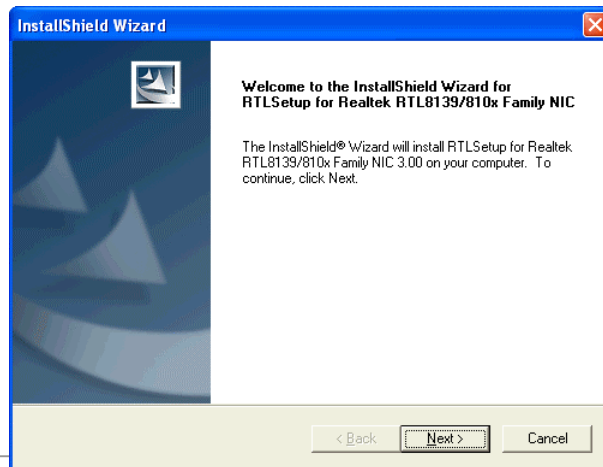

Installing USB2.0 Driver

This motherboard comes with USB2.0 function. You can install USB2.0 Driver under Windows 98SE, Windows ME, Windows 2000 and Windows XP from the Bonus Pack CD auto-run menu.

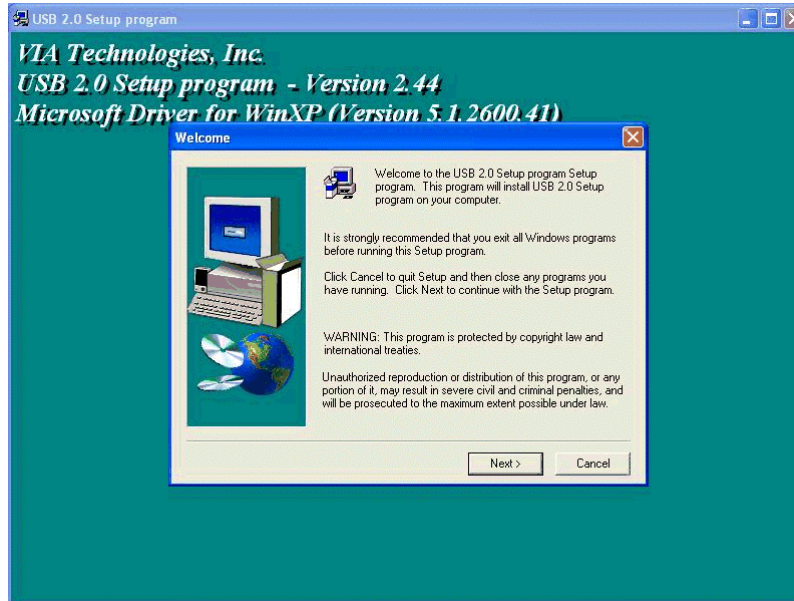

AOConfig Utility

AOpen always dedicated to provide users a much friendly computer environment. We now bring you a comprehensive system detection utility. AOConfig is a Windows based utility with user-friendly interface that allows users to obtain information of the operation system and hardware such as motherboard, CPU, memory, PCI devices and IDE devices. The powerful utility also displays the version of BIOS and firmware for your convenience of maintenance.

Moreover, AOConfig allows users to save information in *.BMP or *.TXT format which users may collect the system information in detail and send them to AOpen directly for technical support or for further diagnose of system problems.

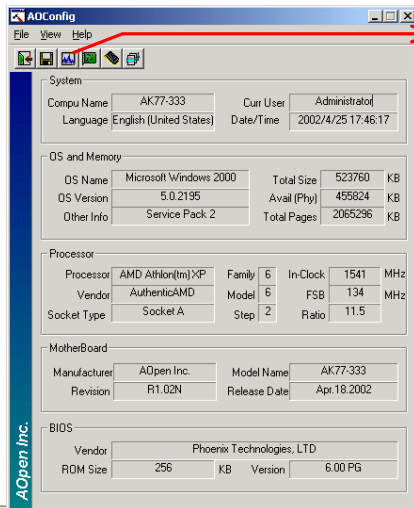

1. The system page shows the detailed information of the motherboard, operating system, processor, and BIOS version.

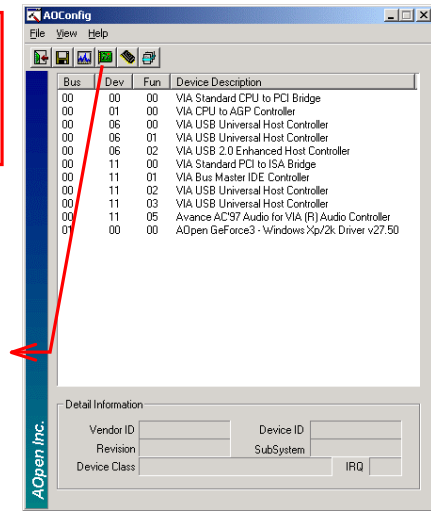

2. The PCI device page shows the configurations of all PCI devices installed in your motherboard.

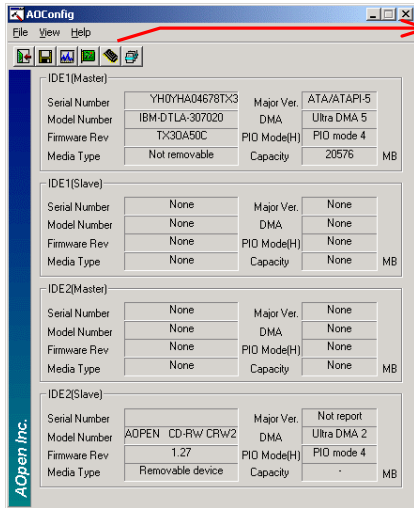

3. This page presents the IDE device information, such as serial number, manufacturer, firmware version, and capacity

4. From this page, users can obtain the technical support information of AOpen. Moreover, detailed information could be saved in .bmp or .txt format.

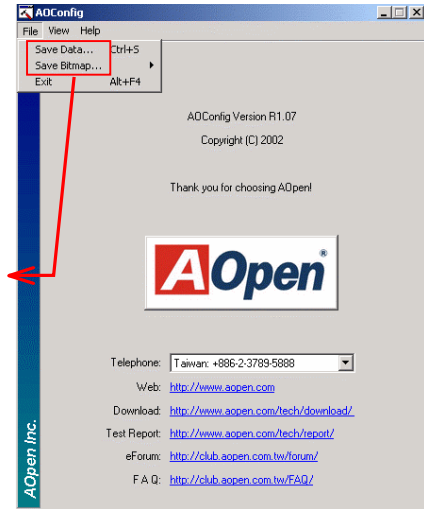

NOTE:

AOConfig can be used under Windows 98SE/ME, NT4.0/2000, or even the latest Windows XP. Please also note that AOConfig can only be operated in a system equipped with an AOpen motherboard. Before running AOConfig, all applications must be closed.

Installing Hardware Monitoring Utility

You can install Hardware Monitoring Utility to monitor CPU temperature, fans, system voltage and other useful information. The hardware monitoring function is automatically implemented by the BIOS and utility software. No hardware installation is needed.



Phoenix-AWARD BIOS

System parameters can be modified by going into [BIOS](#) Setup menu, this menu allows you to configure the system parameters and save the configuration into the 128 bytes CMOS area, (normally in the RTC chip or in the main chipset).

The Phoenix-Award BIOS™ that installed in the [Flash ROM](#) of the motherboard is a custom version of an industry standard BIOS. The BIOS provides critical low-level support for standard devices such as hard disk drives, serial and parallel ports.

Most BIOS setting of this motherboard had been optimized by AOpen's R&D engineering team. But, the default setting of BIOS still can't fine-tune the chipset controlling entire system. Hence, the rest of this chapter is intended to guide you through the process of configuring your system using setup.

Currently there are two kinds of beep sound when system fails to boot at POST. The first type of beep sound consists of a single long beep and two short beeps, indicating a video error has failed BIOS from initializing video screen for displaying any additional information. The 2nd type of beep sound is a single long beep that beeping repeatedly, signaling a DRAM error has occurred. You may look over the indicated error according to different beep significances.

[To enter to BIOS setup menu](#), press when [POST \(Power-On Self Test\)](#) screen is shown on your monitor.

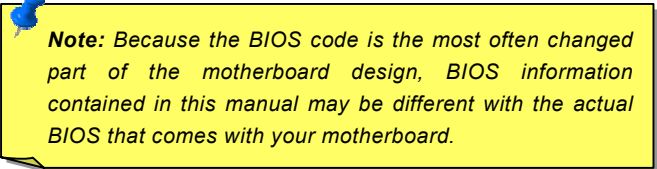

***Note:** Because the BIOS code is the most often changed part of the motherboard design, BIOS information contained in this manual may be different with the actual BIOS that comes with your motherboard.*

About BIOS Function Description...

AOpen always dedicates to give users a friendly computer system. Now, we include all function descriptions of BIOS setup program into BIOS Flash ROM. When you select one function of BIOS setup program, the function description will appear at the right side of screen. Therefore, you don't need to read this manual while you change BIOS setting.

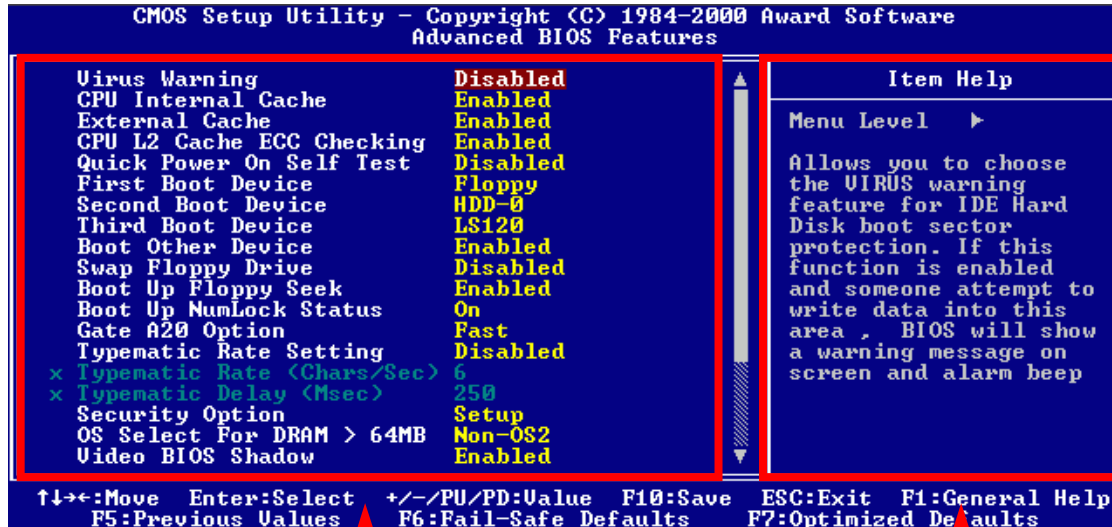

Menu Items Select Window

Item Function Description Window

How To Use Phoenix-Award™ BIOS Setup Program

Generally, you can use arrow keys to highlight items that you want to choose, then press <Enter> key to select, and use the <Page Up> and <Page Down> key to change setting values. You can also press <F1> key for help and press <Esc> key to quit Phoenix-Award™ BIOS setup program. The following table provides details about how to use keyboard in the Phoenix-Award™ BIOS setup program. By the way, all products of AOpen also provide a special function in BIOS setup; you can press <F3> key selecting you preferred menu language.

Key	Description
Page Up or +	Changing setting to next value or increase the value.
Page Down or -	Changing setting to previous value or decrease value.
Enter	Select the item.
Esc	1. In main menu: Quit and don't save any change. 2. In sub menu: Exit current menu to main menu.
Up Arrow	Highlight previous item.
Down Arrow	Highlight next item.

Key	Description
Left Arrow	Move the light bar to left side of menu.
Right Arrow	Move the light bar to right side of menu.
F1	Get menu or item help description.
F3	Changing menu language.
F5	Load previous setting value from CMOS.
F6	Load fail-save setting value from CMOS.
F7	Load turbo setting value from CMOS.
F10	Save changed setting and exit setup program.

How To Enter BIOS Setup

After you finish jumper settings and connect correct cables, power on and enter the BIOS Setup. Press during [POST \(Power-On Self Test\)](#). Choose "Load Setup Defaults" for recommended optimal performance.

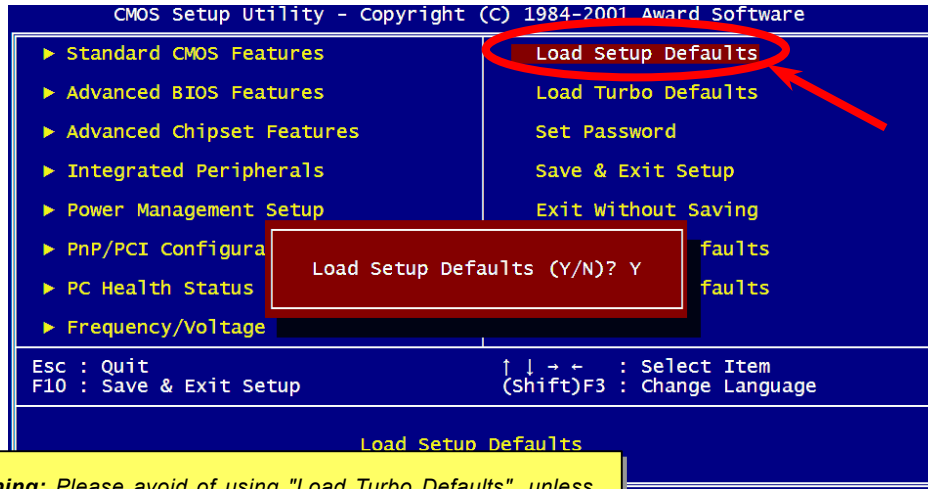

Warning: Please avoid of using "Load Turbo Defaults", unless you are sure your system components (CPU, DRAM, HDD, etc.) are good enough for turbo setting.

BIOS Upgrade under Windows environment



With outstanding R&D ability of AOpen, we now bring you a whole new BIOS Flash wizard ---- EzWinFlash. With an eye to users convenience, EzWinFlash combines the BIOS binary code and flash module together, so the only thing you have to do is just clicking on the utility you downloaded from web and let it helps you complete the flash process automatically. EzWinFlash detects your motherboard and checks the BIOS version cleverly to prevent your system from any possible failure. Moreover, EzWinFlash has been taken into consideration to go with any windows platform you might be using, no matter if you're using Windows 95/98, 98SE/ME, NT4.0/2000, or even the latest Windows XP.

In the meanwhile, in order to provide a much more user-friendly operating environment, AOpen EzWinFlash is natively designed to have multi-language function to provide easier way for users' usage in changing BIOS setting.

EzWinFlash V1.0.0 - 28 Nov, 2001, 16:54:25

Flash ROM Information		CheckSum : F1A9H		Start Flash
Flash Type	Intel E82802AB /3.3V [4Mb]	Option		
Current BIOS Information		<input type="checkbox"/> Clear PnP Area		Save BIOS
Model Name	AX3SPPlus	<input type="checkbox"/> Clear DMI Area		
BIOS Version	R1.09	<input checked="" type="checkbox"/> Clear CMOS		About
Release Date	Oct.09.2001	Language		
New BIOS Information		<input checked="" type="radio"/> English		Exit
Model Name	AX3SPPlus	<input type="radio"/> German		
BIOS Version	R1.09	<input type="radio"/> Chinese-BIG5		
Release Date	Oct.09.2001			
Message				
If you are sure to program new BIOS, please press [Start Flash] button.				

Caution: By updating your motherboard, you are taking a risk of BIOS flash failure. If your motherboard is working stable, and there are no major bugs that had been fixed by a latter BIOS revision, we recommend that you DO NOT try to upgrade your BIOS.

If you intent on upgrading, PLEASE BE SURE to get the right BIOS revision for the right motherboard model to avoid any possibility failure.

You may accomplish BIOS upgrade procedure with EzWinFlash by the following steps, and it's STRONGLY RECOMMENDED to close all the applications before you start the upgrading.

1. Download the new version of BIOS package [zip](#) file from AOpen official web site. (ex: <http://www.aopen.com>)
2. Unzip the download BIOS package (ex: WMX36CE102.ZIP) with WinZip (<http://www.winzip.com>) in Windows environment.
3. Save the unzipped files into a folder, for example, WMX36CE102.EXE & WMX36CE102.BIN.
4. Double click on the WMX36CE102.EXE, EzWinFlash will detect the model name and BIOS version of your motherboard. If you had got the wrong BIOS, you will not be allowed to proceed with the flash steps.
5. You may select preferred language in the main menu, then click [Start Flash] to start the BIOS upgrade procedure.
6. EzWinFlash will complete all the process automatically, and a dialogue box will pop up to ask you to restart Windows. You may click [YES] to reboot Windows.
7. Press at POST to [enter BIOS setup](#), choose "Load Setup Defaults", then "Save & Exit Setup". Done!

It is strongly recommended NOT to turn off the power or run any application during FLASH PROCESS.

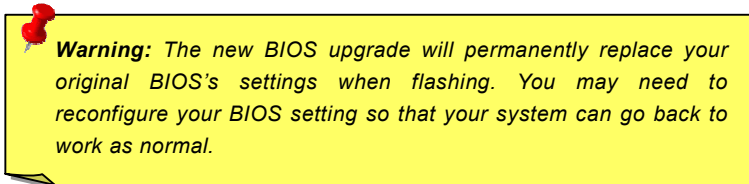

Overclocking

As a leading manufacturer in motherboard industry, AOpen always listens to what customers want and develop products to fit different user's requirements. Reliability, compatibility, leading technology and friendly features are our basic goals when designing motherboards. Other than above mentioned design criteria, there are power users who are always seeking to push the limitation of the system performance by overclocking which we call them "Overclocker".

This section is dedicated to overclockers.

This high performance motherboard is designed for maximum **533MHz** CPU bus clock. But it comes with clock generator of **992MHz (248MHz x 4)** when we design it to accommodate with future CPU bus clock. Not only that, the CPU clock ratio can be up to 24x that supports almost all of Pentium® 4 CPUs in the future and provides flexibility for overclockers.

But not guarantee. 😊



Tip: Note that overclocking may also cause thermal problem. Please make sure the cooling fan and the heatsink are capable of dissipating excessive heat that is generated by overclocking the CPU.



Warning: This product follows CPU and chipset vendor's design guideline. Any attempt to push beyond product specification is not recommended and you have to take your own risk of damaging your system or important data. Before doing overclocking, you must make sure your components are able to tolerate such abnormal setting, especially CPU, DRAMs, hard disks, and AGP VGA cards.

VGA Card & Hard Disk

VGA and HDD are key components for overclocking; for your reference, the following list has been successfully overclocked in our lab. Please note that AOpen cannot guaranty if they can be successfully overclocked again. Please check **Available Vendor List (AVL)** by linking to our official website.

VGA: <http://www.aopen.com/tech/report/overclk/mb/vga-oc.htm>

HDD: <http://www.aopen.com/tech/report/overclk/mb/hdd-oc.htm>

Glossary

AC97

Basically, AC97 specification separates sound/modem circuit to two parts, digital processor and a [CODEC](#) for analog I/O they are linked by AC97 link bus. Since digital processor can be put into motherboard main chipset, the cost of sound/modem onboard solution can be reduced.

ACPI (Advanced Configuration & Power Interface)

ACPI is the power management specification of PC97 (1997). It intends to save more power by taking full control of power management to operating system and bypass [BIOS](#). The chipset or super I/O chip needs to provide standard register interface to operating system (such as Windows 98). This is a bit similar as the [PnP](#) register interface. ACPI defines ATX momentary soft power switch to control the power state transition.

AGP (Accelerated Graphic Port)

AGP is a bus interface targeted for high-performance 3D graphic. AGP supports only memory read/write operation and single-master single-slave one-to-one only. AGP uses both rising and falling edge of the 66MHz clock, for 2X AGP, the data transfer rate is $66\text{MHz} \times 4\text{byte} \times 2 = 528\text{MB/s}$. AGP is now moving to 4X mode, $66\text{MHz} \times 4\text{byte} \times 4 = 1056\text{MB/s}$. AOpen is the first company to support 4X AGP motherboards by both AX6C (Intel 820) and MX64/AX64 (VIA 694x), started from Oct 1999.

AMR (Audio/Modem Riser)

The [CODEC](#) circuit of AC97 sound/modem solution can be put on motherboard or put on a riser card (AMR card) that connects to motherboard through AMR connector.

AOpen Bonus Pack CD

A disc bundled with AOpen motherboard, there are motherboard drivers, Acrobat Reader for [PDF](#) online manual and other useful utilities.

APM (Advanced Power Management)

Unlike [ACPI](#), BIOS controls most APM power management functions. AOpen Suspend to Hard Drive is a good example of APM power management.

ATA (AT Attachment)

ATA is the specification of diskette interface. In 80's, many software and hardware manufacturers instituted the ATA specification together. The AT is meaning International Business Machines Corporation (IBM) personal computer/AT's bus structure.

ATA/66

ATA/66 uses both rising edge and falling edge but doubles [UDMA/33](#) transfer rate. The data transfer rate is 4 times of the PIO mode 4 or DMA mode 2, 16.6MB/s x4 = 66MB/s. To use ATA/66, you need special ATA/66 IDE cable.



ATA/100

ATA/100 is a new IDE specification under developing. ATA/100 uses both rising edge and falling edge as [ATA/66](#) but clock cycle time is reduced to 40ns. The data transfer rate is $(1/40\text{ns}) \times 2 \text{ bytes} \times 2 = 100\text{MB/s}$. To use ATA/100, you need special 80-wire IDE cable, the same as ATA/66.

ATA/133

Compared to traditional ATA/100, ATA/133 has been up to 33 percent increase in interface speed with transfer rate of 133MB/s. ATA/133 performance is ideal for new operating systems, such as Window XP, that demand more storage space and faster data transfer rates from more responsive computing experiences.

BIOS (Basic Input/Output System)

BIOS is a set of assembly routine/program that reside in [EPROM](#) or [Flash ROM](#). BIOS controls Input/output devices and other hardware devices of motherboard. In general, to provide hardware independent portability, operation system and drivers is required to access BIOS without directly access hardware devices.

Bus Master IDE (DMA mode)

The traditional PIO (Programmable I/O) IDE requires the CPU to involve in all the activities of the IDE access including waiting for the mechanical events. To reduce the workload of the CPU, the bus master IDE device transfers data from/to memory without interrupting CPU, and releases CPU to operate concurrently while data is transferring between memory and IDE device. You need the bus master IDE driver and the bus master IDE HDD to support bus master IDE mode.



CNR (Communication and Networking Riser)

The CNR specification provides the PC industry the opportunity to deliver a flexible and cost reduced method of implementing LAN, home networking, DSL, USB, wireless, audio and modem subsystems widely used in today's "connected PCs". The CNR specification is an open industry specification and is supported by OEMs, IHV card manufacturers, silicon supplier and Microsoft.

CODEC (Coding and Decoding)

Normally, CODEC means a circuit that can do digital to analog conversion and also the analog to digital conversion. It is part of [AC97](#) sound/modem solution.

DIMM (Dual In Line Memory Module)

DIMM socket has total 168-pin and supports 64-bit data. It can be single or double side, the golden finger signals on each side of PCB are different, that is why it was called Dual In Line. Almost all DIMMs are made by [SDRAM](#), which operate at 3.3V. Note that some old DIMMs are made by FPM/[EDO](#) and only operate at 5V. Do not confuse them with SDRAM DIMM.

ECC (Error Checking and Correction)

The ECC mode needs 8 ECC bits for 64-bit data. Each time memory is accessed; ECC bits are updated and checked by a special algorithm. The ECC algorithm has the ability to detect double-bit error and automatically correct single-bit error while parity mode can only detect single-bit error.

EDO (Extended Data Output) Memory

The EDO DRAM technology is actually very similar to FPM (Fast Page Mode). Unlike traditional FPM that tri-states the memory output data to start the pre-charge activity, EDO DRAM holds the memory data valid until the next memory access cycle, that is similar to pipeline effect and reduces one clock state.

EEPROM (Electronic Erasable Programmable ROM)

Also known as E²PROM. Both EEPROM and [Flash ROM](#) can be re-programmed by electronic signals, but the interface technology is different. Size of EEPROM is much smaller than flash ROM.

EPROM (Erasable Programmable ROM)

Traditional motherboard stores BIOS code in EPROM. EPROM can only be erased by ultra-violet (UV) light. If BIOS has to be upgraded, you need to remove EPROM from motherboard, clear by UV light, re-program, and then insert back.

EV6 Bus

EV6 Bus in the technology of Alpha processor from Digital Equipment Corporation. EV6 bus uses both rising and falling clock edge to transfer data, similar as DDR SDRAM or ATA/66 IDE bus.

EV6 Bus Speed = CPU external bus clock x 2.

For example, 200 MHz EV6 bus is actually using 100 MHz external bus clock, but the equivalent speed is 200 MHz.

FCC DoC (Declaration of Conformity)

The DoC is component certification standard of FCC EMI regulations. This standard allows DIY component (such as motherboard) to apply DoC label separately without a shielding of housing.

FC-PGA (Flip Chip-Pin Grid Array)

FC means Flip Chip, FC-PGA is a new package of Intel for Pentium III CPU. It can plug into SKT370 socket, but require motherboard to add some signals on socket 370. That is, the motherboard needs to be redesigned. Intel is going to ship FC-PGA 370 CPU and phase out slot1 CPU.

Flash ROM

Flash ROM can be re-programmed by electronic signals. It is easier for BIOS to upgrade by a flash utility, but it is also easier to be infected by virus. Because of increase of new functions, BIOS size is increased from 64KB to 256KB (2M bit). AOpen AX5T is the first board to implement 256KB (2Mbit) Flash ROM. Now flash ROM size is moving to 4M bit on AX6C (Intel 820) and MX3W (Intel 810) motherboard. , AOpen motherboard uses EEPROM for jumper-less and battery-less design.

FSB (Front Side Bus) Clock

FSB Clock means CPU external bus clock.

CPU internal clock = CPU FSB Clock x CPU Clock Ratio

I²C Bus

See [SMBus](#).



IEEE 1394

IEEE 1394 is a low-cost digital interface originated by Apple Computer as a desktop LAN and developed by the IEEE 1394 working group. The IEEE 1394 can transport data at 100, 200 or 400 Mbps. One of the solutions to connect digital television devices together at 200 Mbps. Serial Bus Management provides overall configuration control of the serial bus in the form of optimizing arbitration timing, guarantee of adequate electrical power for all devices on the bus, assignment of isochronous channel ID, and notification of errors. There are two type of IEEE 1394 data transfer: asynchronous and isochronous. Asynchronous transport is the traditional computer memory-mapped, load and store interface. Data requests are sent to a specific address and an acknowledgment is returned. In addition to an architecture that scales with silicon technology, IEEE 1394 features a unique isochronous data channel interface. Isochronous data channels provide guaranteed data transport at a pre-determined rate. This is especially important for time-critical multimedia data where just-in-time delivery eliminates the need for costly buffering.

Parity Bit

The parity mode uses 1 parity bit for each byte, normally it is even parity mode, that is, each time the memory data is updated, parity bit will be adjusted to have even count "1" for each byte. When next time, if memory is read with odd number of "1", the parity error is occurred and this is called single bit error detection.

PBSRAM (Pipelined Burst SRAM)

For Socket 7 CPU, one burst data read requires four QWord (Quad-word, $4 \times 16 = 64$ bits). PBSRAM only needs one address decoding time and automatically sends the remaining QWords to CPU according to a predefined sequence. Normally, it is 3-1-1-1, total 6 clocks, which is faster than asynchronous SRAM. PBSRAM is often used on L2 (level 2) cache of Socket 7 CPU. Slot 1 and Socket 370 CPU do not need PBSRAM.

PC-100 DIMM

[SDRAM](#) DIMM that supports 100MHz CPU [FSB](#) bus clock.

PC-133 DIMM

[SDRAM](#) DIMM that supports 133MHz CPU [FSB](#) bus clock.

PC-1600, PC-2100 or PC-2700 DDR DRAM

Based on FSB frequency, the DDR DRAM has 200MHz, 266MHz and 333MHz three types of working frequency. Because DDR DRAM data bus is 64-bit, it provides data transfer bandwidth up to $200 \times 64 / 8 = 1600 \text{MB/s}$, $266 \times 64 / 8 = 2100 \text{MB/s}$ and $333 \times 64 / 8 = 2700 \text{MB/s}$ in these current three DDR DRAM. Therefore, the PC-1600 DDR DRAM is working with 100MHz, PC-2100 DDR DRAM is working with 133MHz and PC-2700 with 166MHz FSB frequency.

PCI (Peripheral Component Interface) Bus

Bus for the internal connection of peripheral devices, high-speed data channel between the computer and expansion card.



PDF Format

A file format for electronic document, PDF format is independent from platform, you can read PDF file under Windows, Unix, Linux, Mac ... with different PDF reader. You can also read PDF file by web browser such as IE and Netscape, note that you need to install PDF plug-in first (Included in Acrobat Reader).

PnP (Plug and Play)

The PnP specification suggests a standard register interface for both BIOS and operating system (such as Windows 95). These registers are used by BIOS and operating system to configure system resource and prevent any conflicts. PnP BIOS or operating system will automatically allocate the IRQ/DMA/Memory. Currently, almost all the PCI cards and most ISA cards are already PnP compliant.

POST (Power-On Self Test)

The BIOS self-test procedure after power-on, sometimes, it is the first or the second screen shown on your monitor during system boot.

RDRAM (Rambus DRAM)

Rambus is a memory technology that uses large burst mode data transfer. Theoretically, the data transfer should be high than [SDRAM](#). RDRAM is cascaded in channel operation. For Intel 820, only one RDRAM channel is supported, 16-bit data per channel, and this channel may have maximum 32 RDRAM devices, no matter how many [RIMM](#) sockets.



RIMM (Rambus Inline Memory Module)

184-pin memory module that supports [RDRAM](#) memory technology. A RIMM memory module may contain up to maximum of 16 RDRAM devices.

SDRAM (Synchronous DRAM)

SDRAM is one of the DRAM technologies that allow DRAM to use the same clock as the CPU host bus ([EDO](#) and FPM are asynchronous and do not have clock signal). It is similar as [PBSRAM](#) to use burst mode transfer. SDRAM comes in 64-bit 168-pin [DIMM](#) and operates at 3.3V. AOpen is the first company to support dual-SDRAM DIMMs onboard (AP5V), from Q1 1996

Shadow E²PROM

A memory space in Flash-ROM to simulate E²PROM operation, AOpen motherboard uses Shadow E²PROM for jumper-less and battery-less design

SIMM (Single In Line Memory Module)

SIMM socket is only 72-pin, and is only single side. The golden finger signals on each side of PCB are identical. That is why it was called Single In Line. SIMM is made by FPM or [EDO](#) DRAM and supports 32-bit data. SIMM had been phased out on current motherboard design.

SMBus (System Management Bus)

SMBus is also called I2C bus. It is a two-wire bus developed for component communication (especially for semiconductor IC). For example, set clock of clock generator for jumper-less motherboard. The data transfer rate of SMBus is only 100Kbit/s, it allows one host to communicate with CPU and many masters and slaves to send/receive message.

SPD (Serial Presence Detect)

SPD is a small ROM or [EEPROM](#) device resided on the [DIMM](#) or [RIMM](#). SPD stores memory module information such as DRAM timing and chip parameters. SPD can be used by [BIOS](#) to decide best timing for this DIMM or RIMM.

UltraATA

UltraATA (or, more accurately, UltraATA/33) is a protocol for transferring data between a hard disk drive through the computer's data path (or bus) to the computer's random access memory (RAM). The UltraATA/33 protocol transfers data in burst mode at a rate of 33.3MB/s, twice as fast as the previous [Direct Memory Access \(DMA\)](#) interface. UltraATA was developed as a proposed industry standard by the Quantum corporation, makes of hard disk drives, and Intel, makes of chipset that support computer bus technology. UltraATA support in your computer means that it will boot (start) and open new applications more quickly. It will help users of graphic-intensive and applications that require large amounts of access to data on the hard disk drive. UltraATA uses Cyclical Redundancy Checking (CRC), offering a new level of data protection. UltraATA uses the same 40-pin IDE interface cable as PIO and DMA.

16.6MB/s x2 = 33MB/s

16.6MB/s x4 = 66MB/s

16.6MB/s x6 = 100MB/s



USB (Universal Serial Bus)

USB is a 4-pin serial peripheral bus that is capable of cascading low/medium speed peripherals (less than 10Mbit/s) such as keyboard, mouse, joystick, scanner, printer and modem. With USB, the traditional complex cables from back panel of your PC can be eliminated.

USB2.0 (Universal Serial Bus)

Compared to traditional USB 1.0/1.1 with the speed of 12Mbps, USB 2.0 has a fancy speed up to 480 Mbps that is 40 times faster than the traditional one. Except for the speed increase, USB 2.0 supports old USB 1.0/1.1 software and peripherals, offering impressive and even better compatibility to customers.

VCM (Virtual Channel Memory)

NEC's Virtual Channel Memory (VCM) is a new DRAM core architecture that dramatically improves the memory system's ability to service multimedia requirements. VCM increases memory bus efficiency and performance of any DRAM technology by providing a set of fast static registers between the memory core and I/O pins. Using VCM technology results in reduced data access latency and reduced power consumption.

ZIP file

A compressed file format to reduce file size. To unzip file, run shareware PKUNZIP (<http://www.pkware.com/>) for DOS and other operating system or WINZIP (<http://www.winzip.com/>) for windows environment.





Troubleshooting

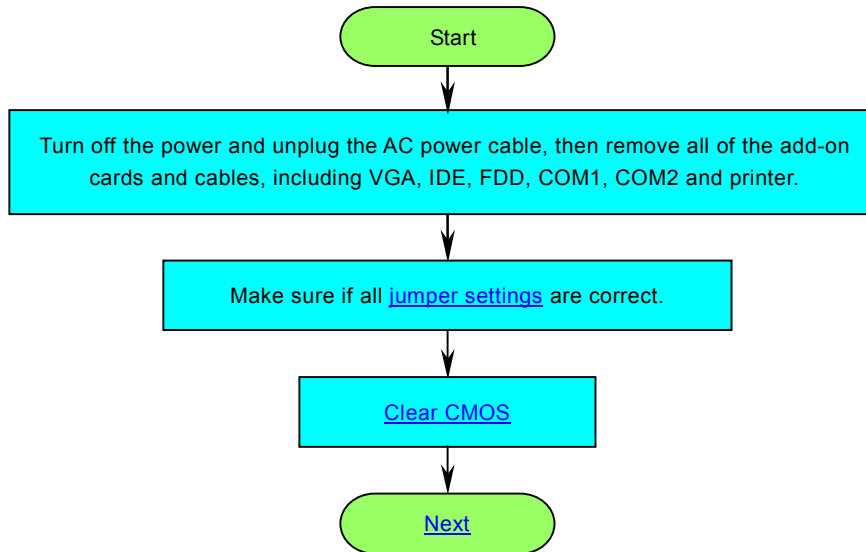

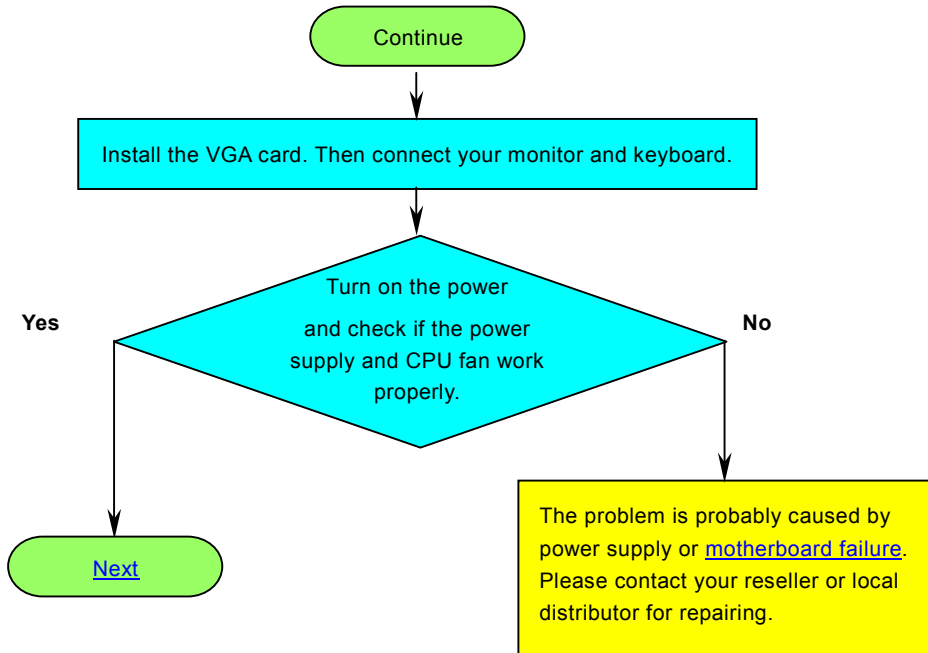

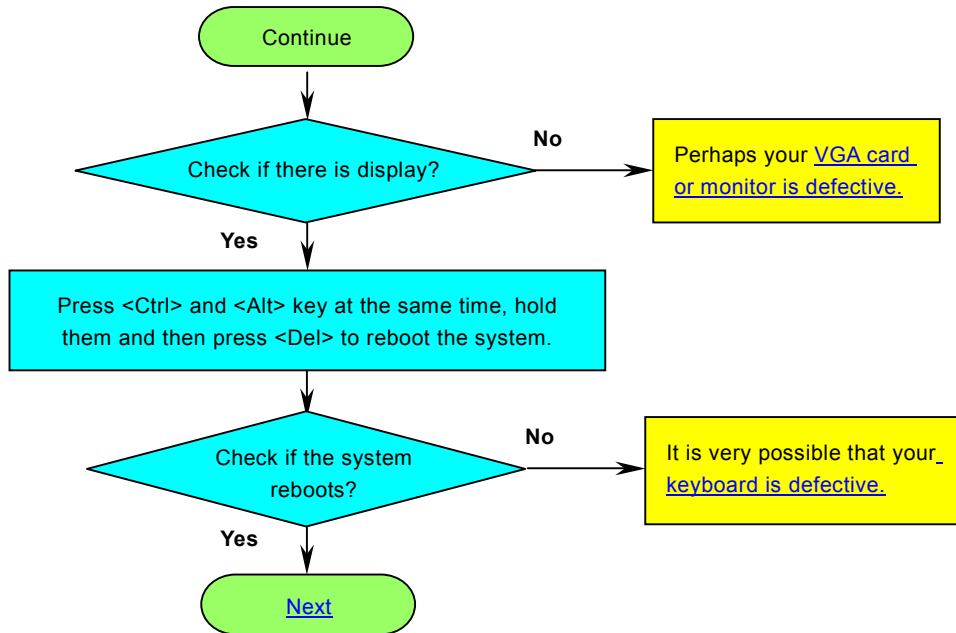

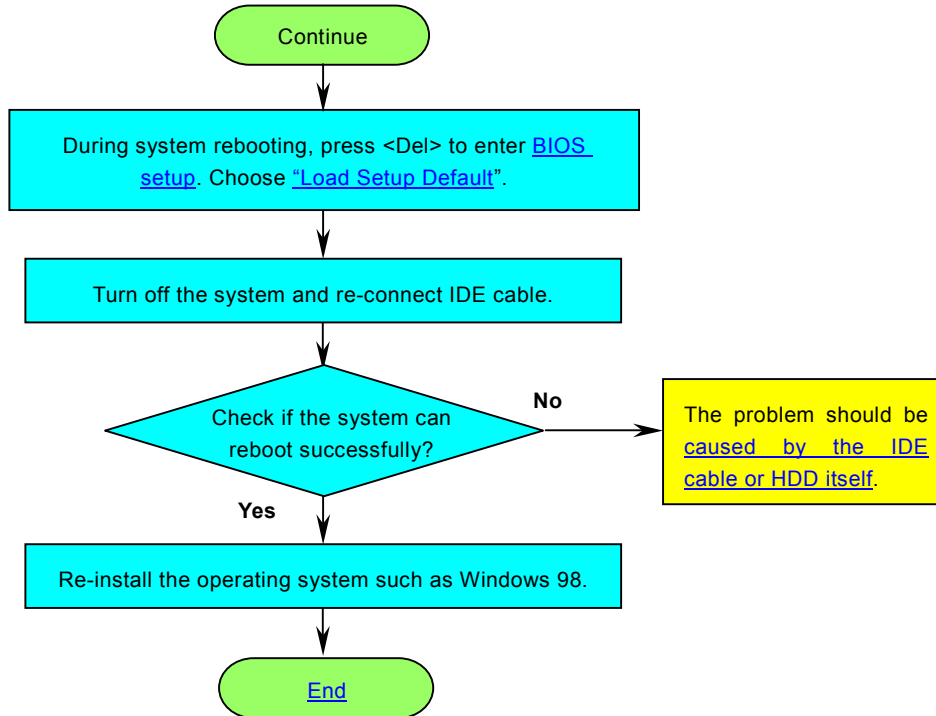



Technical Support

Dear Customer,

Thanks for choosing AOpen products. To provide the best and fastest service to our customer is our first priority. However, we receive numerous emails and phone-calls worldwide everyday, it is very hard for us to serve everyone on time. We recommend you to follow the procedures below and seek help before contact us. With your help, we can then continue to provide the best quality service to more customers.

Thanks very much for your understanding!

AOpen Technical Supporting Team

1

Online Manual: Please check the manual carefully and make sure the jumper settings and installation procedure are correct.

<http://english.aopen.com.tw/tech/download/manual/default.htm>

2

Test Report: We recommend you to choose board/card/device from the compatibility test reports for assembling your PC.

<http://english.aopen.com.tw/tech/report/default.htm>

3

FAQ: The latest FAQ (Frequently Asked Questions) may contain a solution to your problem.

<http://english.aopen.com.tw/tech/faq/default.htm>

4

Download Software: Check out this table to get the latest updated BIOS/utility and drivers.

<http://english.aopen.com.tw/tech/download/default.htm>



5

News Group: Your problem probably had been answered by our support engineer or professional users on the news group.

<http://english.aopen.com.tw/tech/newsgrp/default.htm>

6

Contact Distributors/Resellers: We sell our products through resellers and integrators. They should know your system configuration very well and should be able to solve your problem more efficiently than us. After all, their attitude of service is an important reference for you if next time you want to buy something else from them.

7

Contact Us: Please prepare detail system configuration and error symptom before contacting us. The **part number**, **serial number** and **BIOS version** are also very helpful.

Part Number and Serial Number

The Part Number and Serial number are printed on bar code label. You can find this bar code label on the outside packing or on component side of PCB. For example:

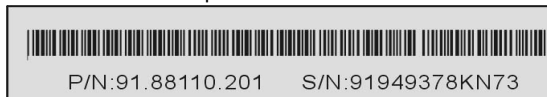

Part No.

Serial No.



Part No.

Serial No.

P/N: 91.88110.201 is part number, **S/N: 91949378KN73** is serial number.

Model name and BIOS version

Model name and BIOS version can be found on upper left corner of first boot screen ([POST](#) screen). For example:

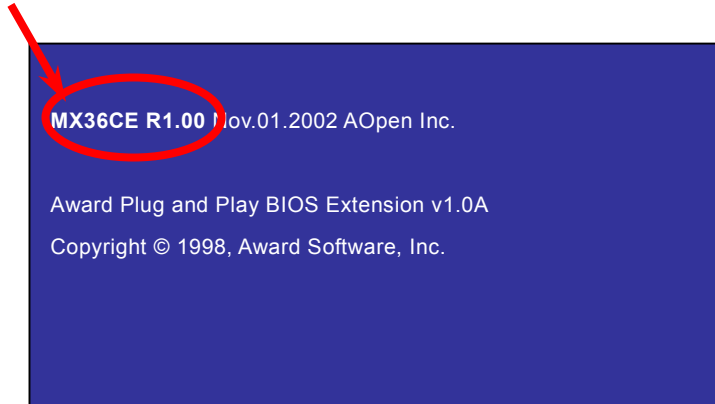

MX36CE is model name of motherboard, **R1.00** is BIOS version.



Product Registration

Club AOpen

Welcome to AOpen Inc.



Thank you for choosing AOpen product. AOpen encourages you to spend few minutes in completing the following product registration. To register your product will ensure the high quality of services from AOpen. After the registration, you will:

- Have opportunities to play online slot machine and win a prize from AOpen by accumulating your bonuses for later prize exchange.
- Be upgraded to gold membership of Club AOpen program.
- Receive email notification about product safety alerts. Its purpose is to alert consumers quickly and conveniently when products contain technical issues.
- Receive email notification about latest product's announcements.
- Be able to personalize your AOpen web pages.
- Receive e-mail notification about latest BIOS/Driver/Software release information.
- Have opportunities to participate special product promotional programs.
- Enjoy higher service priority to receive technical assistance provided by AOpen specialists worldwide.
- Be able to join the discussions of web-based news groups.

AOpen makes sure that the information you provide is encrypted, so that it cannot be read or intercepted by other people or companies. Further, AOpen will not disclose any of information you submitted under any conditions. Please consult our [online privacy policy](#) for further information on our company policy.

Note: *If registering products purchased from different dealers/retails and/or purchased on different dates, please submit a separate form for each product.*



How to Contact Us



Please do not hesitate contact us if you have any problem about our products. Any opinion will be appreciated.

Pacific Rim
AOpen Inc.
Tel: 886-2-3789-5888
Fax: 886-2-3789-5899

Europe
AOpen Computer b.v.
Tel: 31-73-645-9516
Fax: 31-73-645-9604

America
AOpen America Inc.
Tel: 1-510-498-8928
Fax: 1-510-489-1998

China
艾爾鵬國際貿易(上海)有限公司
Tel: 86-21-6225-8622
Fax: 86-21-6225-7926

Germany
AOpen Computer GmbH.
Tel: 49-1805-559191
Fax: 49-2102-157799

Japan
AOpen Japan Inc.
Tel: 81-048-290-1800
Fax: 81-048-290-1820

Web Site: <http://english.aopen.com.tw/>

E-mail: Send us email by going through the contact form below.

English <http://english.aopen.com.tw/tech/default.htm>

Japanese <http://www.aopen.co.jp/tech/default.htm>

Chinese <http://www.aopen.com.tw/tech/default.htm>

German <http://www.aopencom.de/tech/default.htm>

Simplified Chinese <http://www.aopen.com.cn/tech/default.htm>

