



User's Manual

An AMD Socket A Processor based
AGP (8X) mainboard (200/266/333MHz)
Supports PC1600/PC2100/PC2700 Memory
Modules (DDR Memory)

TRADEMARK

All products and company names are trademarks or registered trademarks of their respective holders.

These specifications are subject to change without notice.

*Manual Revision 1.0
September 23, 2002*

POST Port Frequently Asked Questions

Below is a list of some basic POST Codes, possible problems, and solutions. For more detailed information about POST Codes, refer to Appendix E in this manual.

POST CODE	Problem	Solution
FFh or CFh	<ol style="list-style-type: none">1. BIOS chip inserted incorrectly2. Incorrect BIOS update version3. Mainboard problem4. Add-on card inserted incorrectly.	<ol style="list-style-type: none">1. Reinsert the BIOS chip2. Download the correct BIOS version update from the manufacturer's Web site.3. Replace mainboard4. Remove and replace the add-on card
C1h - C5h	<ol style="list-style-type: none">1. Memory module inserted incorrectly2. Memory compatibility problem3. Memory module damaged	<ol style="list-style-type: none">1. Reinsert memory module2. Replace memory with correct type3. Replace memory module
2Dh	<ol style="list-style-type: none">1. Error occurred in VGA BIOS2. VGA card inserted incorrectly	<ol style="list-style-type: none">1. Replace VGA card2. Reinsert the VGA card
26h	Overclock error	Clear CMOS or press the insert key to power on the system
07h - 12h	<ol style="list-style-type: none">1. Init keyboard controller error2. RTC error	<ol style="list-style-type: none">1. Ensure that the keyboard and mouse are connected correctly.2. Replace the RTC battery.

Table of Contents

	<i>Page</i>
<i>Section 1</i>	<i>Introduction</i>
	Components Checklist 1-1
	<i>Overview</i>
	AMD Duron™ & Athlon™ Processors 1-2
	Accelerated Graphics Port 1-3
	Ultra ATA66/100/133 1-3
	Serial ATA (Optional) 1-4
	Hardware Monitoring 1-4
	Mainboard Form-Factor 1-5
	I/O Shield Connector 1-6
	Power-On/Off (Remote) 1-6
	System Block Diagram 1-7
<i>Section 2</i>	<i>Features</i>
	Mainboard Features 2-1
<i>Section 3</i>	<i>Installation</i>
	Mainboard Detailed Layout 3-2
	<i>Easy Installation Procedure</i>
	CPU Insertion 3-3
	Jumper Settings 3-5
	System Memory Configuration 3-6
	Device Connectors 3-8
	External Modem Ring Power On and Keyboard Power On Function (KBPO) 3-15
	STR (Suspend To RAM) Function 3-15
	CPU Overheating Protection 3-16

Section 4***Award BIOS Setup***

BIOS Instructions	4-1
Standard CMOS Setup	4-2
Advanced BIOS Features	4-3
Advanced Chipset Features	4-8
Integrated Peripherals	4-13
Power Management Setup	4-19
PNP/PCI Configuration Setup	4-24
PC Health Status	4-27
Frequency/Voltage Control	4-29
Defaults Menu	4-32
Supervisor/User Password Setting	4-32
Exit Selecting	4-34

Section 5***Driver Installation***

Easy Driver Installation	5-1
ALC650 Configuration Setup	5-2

Appendix***Appendix A***

Avance Media Player User's Guide	A-1
--	-----

Appendix B

Update Your System BIOS	B-1
-------------------------------	-----

Appendix C

EEPROM BIOS Remover	C-1
---------------------------	-----

Appendix D

GHOST 7 Quick User's Guide (Optional)	D-1
---	-----

Appendix E

POST Codes (Optional)	E-1
-----------------------------	-----

Section 1
INTRODUCTION

Package Contents

Contents	Optional Item
A. (1) Mainboard	F. (1) USB2.0 cable
B. (1) User's manual	G. (1) Game port cable
C. (1) Floppy cable or Floppy round cable	H. (1) I/O Shield
D. (1) Hard drive cable or Hard drive round cable	I. (1) Bluetooth Module
E. (1) Driver and utility	J. (1) SPD650 card
	K. (1) Serial ATA cable

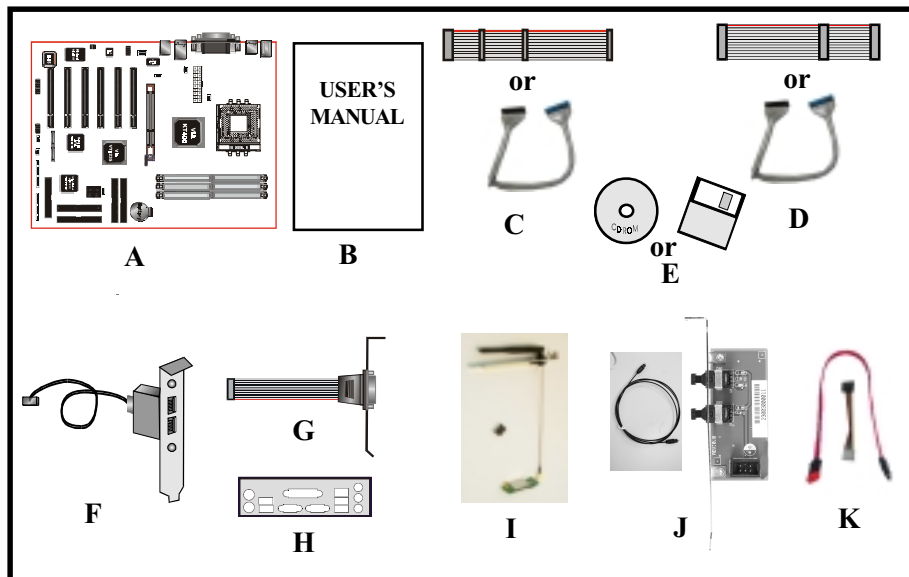

AMD Duron™ & Athlon™ Processors

The AMD Athlon™ is a seventh-generation micro architecture with an integrated L2 cache, which is powerful enough to support the bandwidth requirements of a large range of applications, hardware, graphics, and memory technologies. These processors implement advanced design techniques such as:

- ◆ Socket A (PGA 462)
- ◆ 200/266/333MHz system interface based on the Alpha™ EV6 bus protocol.
- ◆ Three out-of-order, superscalar, pipelined Multimedia Units.
- ◆ Three out-of-order, superscalar, pipelined Integer Units.
- ◆ Fixed-sized internal instruction formats (MacroOPs).
- ◆ 72-entry Instruction Control Units.
- ◆ AMD enhanced 3DNow!™ technology
- ◆ L1 and L2 caches.
- ◆ Dynamic branch prediction.

Socket A is the name for AMD's new socketed interface designed to support both AMD Duron™ and AMD Athlon™ processors. This innovation is made possible by integrating the L2 cache memory on chip with the processor. Socket A will help enable smaller enclosures, and ultimately result in a wider variety of solutions in the market.

The AMD Duron™ & Athlon™ processors in the Socket A format continue to deliver the ultimate performance for cutting-edge applications. Both bring to desktop systems running industry-standard x86 software superscalar RISC performance. Being provided in the Socket A format they are the world's most powerful x86 processors. They easily deliver the highest integer, floating-point, and 3D multimedia performance for applications running on x86 platforms around.

The AMD Duron™ processor is derived from the AMD Athlon™ processor core. It features full-speed, on-chip cache memory, a 200/266/333MHz front side system bus, and enhanced 3DNow!™ technology. Although both processors are related, there are key differences. The AMD Athlon™ processor is targeted at the performance segment, and as such will have more cache memory and higher clock speeds.

Accelerated Graphics Port (AGP or A.G.P.)

Typically, 3D graphics rendering requires a tremendous amount of memory, and demands ever increasing throughput speed as well. As 3D products for the personal computer become more and more popular, these demands will only increase. This will cause a rise in costs for both end users and manufacturers. Lowering these costs as well as improving performance is the primary motivation behind AGP. By providing a massive increase in the bandwidth available between the video card and the processor, it will assist in relieving some of these pressures for quite sometime.

The board provides the AGP 3.0 interface. The AGP interface can support external AGP slot (1.5V only) with AGP 8X/4X/2X and Fast Write Transactions. The AGP Interface Specification revision 3.0 enhances the functionality of the original AGP Interface Specification by allowing 8X data transfers (8 data samples per clock) and 1.5 volt (Power supply) operation. Supports Maximum AGP interface bandwidth 2.1GB/s. **(1.5 volt AGP Card supports only).**

Ultra ATA/66/100/133

The board provides Ultra ATA/66/100/133 Bus Master IDE controller, that support Ultra ATA/66/100/133 protocols, perfect for such demanding applications as real-time video, multimedia, and high performance operating system. A new IDE cable is required for Ultra ATA/66/100/133. This cable is an 80 conductor cable; however the connectors are, of course, backwards compatible with ATA/33.

Introduction

Serial ATA (Optional)

The evolutionary serial ATA interface replaces the standard parallel ATA physical storage interface. The serial ATA specification provides scalability and allows future enhancements to the computing platform. Serial technology overcomes performance limits of parallel interface architecture, meeting the escalating need for faster data throughput in servers and storage devices.

Serial ATA is backward compatible with current software and runs on existing architecture without modification. The serial ATA interface cable requires lower voltages and uses smaller cable connectors, providing ease of installation. You can easily upgrade storage devices that are compatible with the serial ATA interface specification. Serial ATA supports all ATA and ATAPI devices, including high capacity removable devices, optical devices, tape storage devices, and zip drives.

Serial ATA is completely software compatible with parallel ATA, requiring no modification to your operating system.

Hardware Monitoring

Hardware monitoring allows you to monitor various aspects of your systems operations and status. The features include CPU temperature, voltage and RPM of fan.

Mainboard Form-Factor

The board is designed with ATX form factor - the new industry standard of chassis. ATX form factor is essentially a Baby-AT baseboard rotated 90 degrees within the chassis enclosure and a new mounting configuration for the power supply. With these changes the processor is relocated away from the expansion slots, allowing them all to hold full length add-in cards. ATX defines a double height aperture to the rear of the chassis which can be used to host a wide range of onboard I/O. Only the size and position of this aperture is defined, allowing PC manufacturers to add new I/O features (e.g.; TV input, TV output, joystick, modem, LAN, etc.) to systems. This will help systems integrators differentiate their products in the marketplace, and better meet your needs.

- Smaller size promotes a smaller system size.
- I/O shield does not need to be retooled in an ATX 2.01 or later. The mainboard should be used in an ATX 2.01 (or later) compliant case.
- A smaller power supply can be used. High integration on mainboard reduces the system cost.

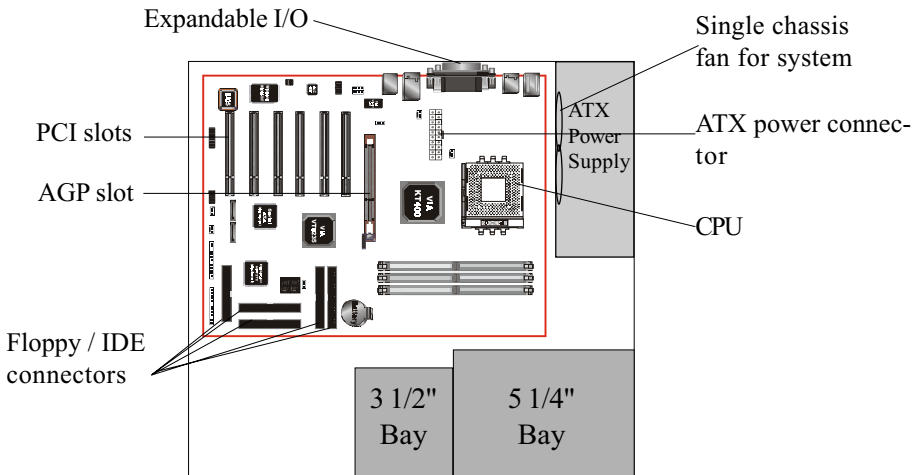

Figure 2: Summary of ATX chassis features

Introduction

I/O Shield Connector

The board is equipped with an I/O back panel. Please use the appropriate I/O shield (figure 3).

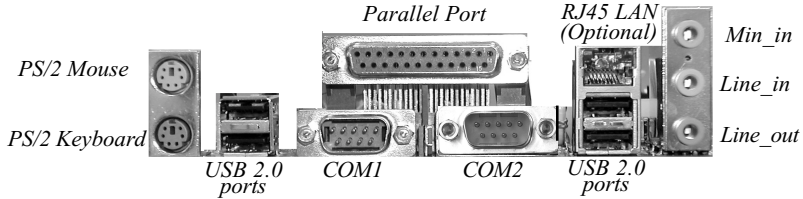

Figure 3: I/O back panel layout

Power-On/Off (Remote)

The board has a single 20-pin connector for ATX power supplies. For ATX power supplies that support the **Remote On/Off** feature, this should be connected to the systems front panel for system Power On/Off button. The systems power On/Off button should be a momentary button that is normally open.

The board has been designed with "Soft Off" function. You can turn Off the system from one of two sources: The first is the front panel Power On/Off button, and the other is the "Soft Off" function (coming from the M/B's onboard circuit controller) that can be controlled by the operating system such as Windows® 95/98/SE/ME or Windows®2000.

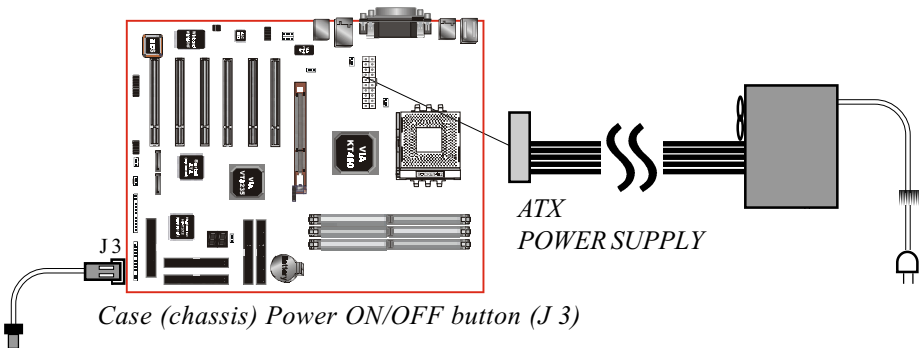

Figure 4: Simple ATX Power ON/OFF Controller

System Block Diagram

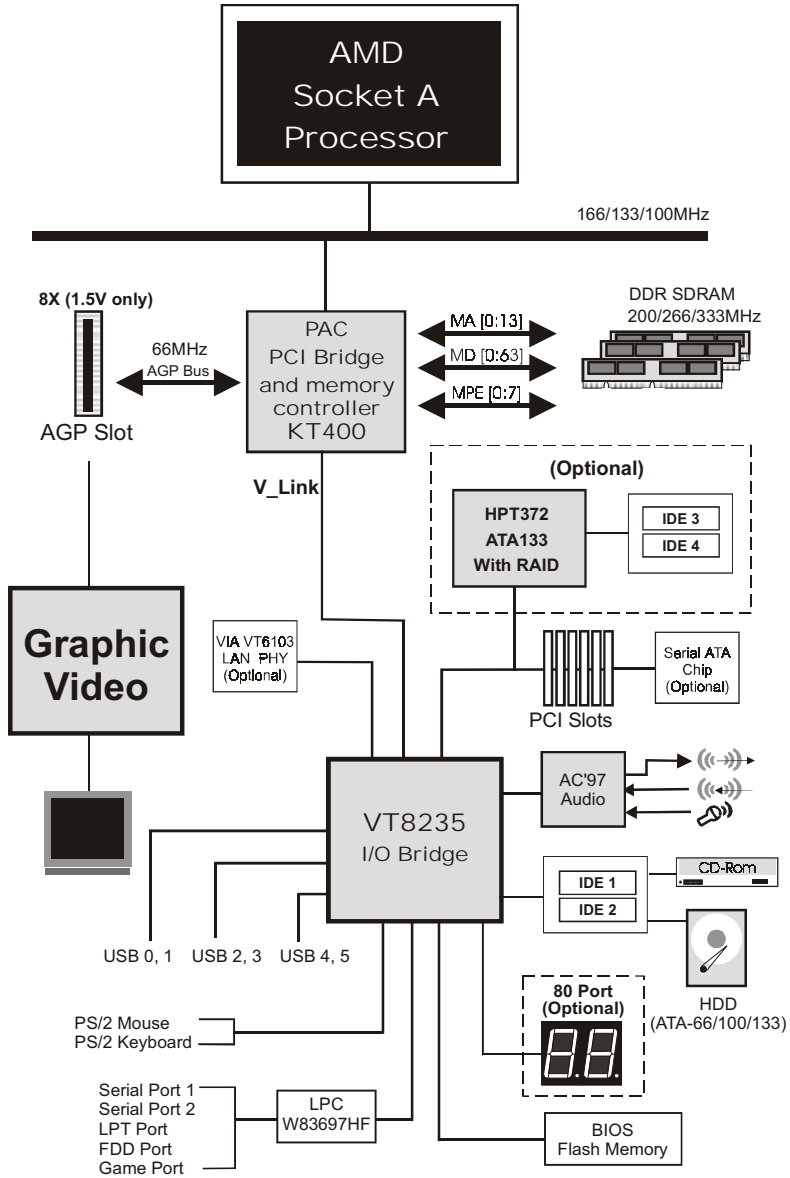

Figure 5: System Block Diagram

Mainboard Features

◆ **PROCESSOR**

- The Socket A compatible AMD Athlon™ XP processor 1500+ to 2600+, 600MHz to 1.4GHz AMD Athlon™ and AMD Duron™ Processor up to 1.3GHz

◆ **CHIPSET**

- VIA KT400 AGPset (KT400 + VT8235)

◆ **FRONT SIDE BUS**

- 200/266/333MHz

◆ **DRAM MODULE**

- 184-pin DDR DIMM x 3 for PC1600/2100/2700 Memory
- DRAM Size: 64MB to 3GB

◆ **EXPANSION SLOT**

- 32-bit PCI x 6
- 8X AGP x 1 (1.5V only)

◆ **ONBOARD I/O**

- Winbond W83697HF LPC I/O integrated with FDD, fast IR, power on function, and parallel, serial, and game ports

◆ **ONBOARD PCI / IDE**

- PCI Bus IDE Port with PIO/Ultra DMA-66/100/133 x 2 (up to 4 devices)
- Extra IDE Port by HPT372 with Ultra DMA-66/100/133 and IDE RAID x 2 (up to 4 devices) **(Optional)**

Features

◆ I/O CONNECTOR

- PS/2 mouse and keyboard
- COM1, COM2, LPT (printer)
- Line-in/out, MIC
- Game port by extra cable
- USB connector x 6 (two optional via mainboard front panel USB connector). USB supports USB 2.0 specification. The USB3 can support Bluetooth module.
- RJ-45 jack (Optional)

◆ Onboard LAN (Optional)

- Integrated 10/100MB fast Ethernet controller in chipset with external VIA VT6103 physical Layer by RJ-45 connector

◆ Serial ATA (Optional)

- Up to two Serial ATA device
- Replaces the parallel ATA interface, providing greater throughput.
- Supports current operating systems and software.
- Supports all ATA and ATAPI devices, including high capacity removable devices, optical devices, tape storage devices, and zip drives.

◆ BIOS

- Award Plug & Play BIOS

◆ Built-in AC 97 Digital Audio by Realtek ALC650 (6 channel)

- Compliant with AC97 2.2 specification
- Six-channel, slot selectable DAC (Digital Analog Converter) output for multi-channel applications
- Supports digital SPDIF function

◆ EXTENDED FUNCTION

- Supports hardware monitoring function by W83697HF
- Supports exclusive KBPO (KeyBoard Power On) function
- Supports Wake-On-LAN function

- Supports STR (Suspend To RAM) power saving function
- Supports CPU clock and ratio settings via BIOS
- Supports CPU Vcore and Memory voltage via BIOS
- Supports “Magic Health” and “Easy Boot” Function
- Supports CPU Overheating Protection Function
- 80 Port onboard design with 7-segment LED display (Optional)

◆ FORM FACTOR

- 305 mm x 245 mm ATX size

Section 3
INSTALLATION

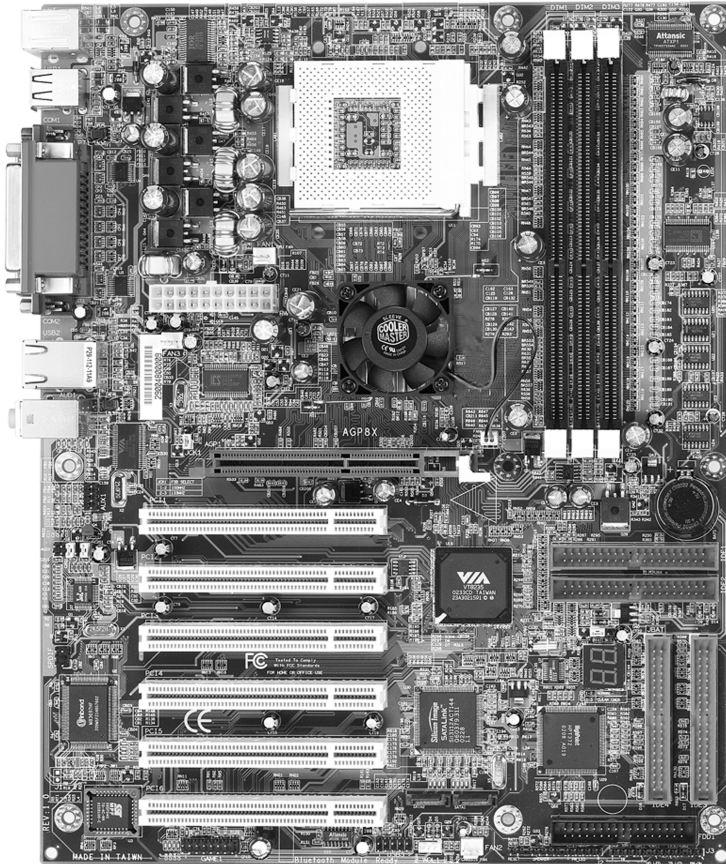

Mainboard Layout

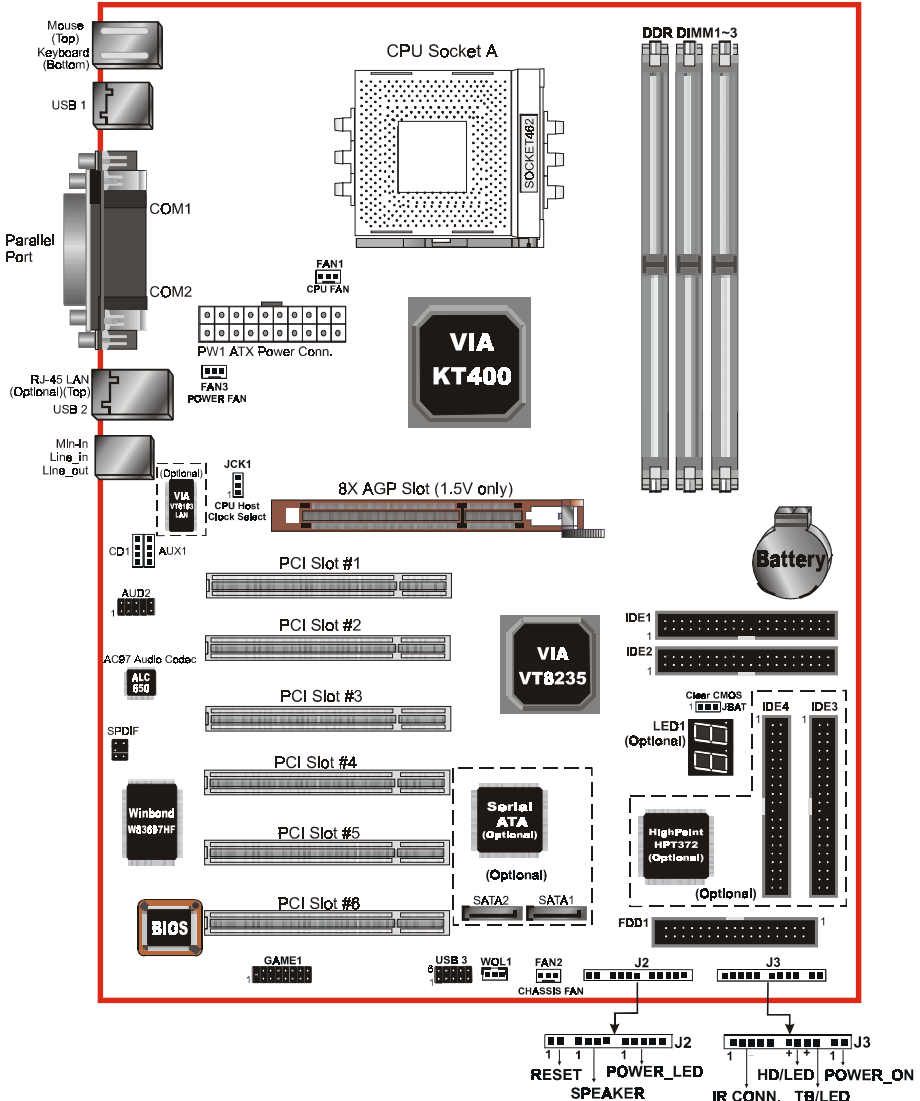

Easy Installation Procedure

The following must be completed before powering on your new system:

- 3-1. CPU Installation**
- 3-2. Jumper Settings**
- 3-3. System Memory Configuration**
- 3-4. Device Connectors**
- 3-5. External Modem Ring-in Power ON and Keyboard Power ON Functions (KBPO)**
- 3-6. STR Function**
- 3-7. CPU Overheating Protection**

Section 3-1 CPU Installation

CPU Insertion: (use AMD Athlon™ as reference)

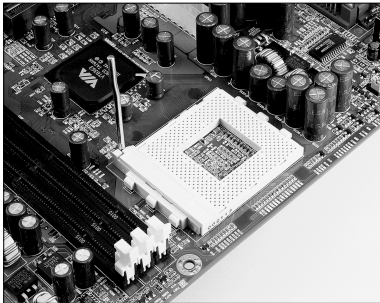

Figure 1

Step 1

Open the socket by raising the actuation lever.

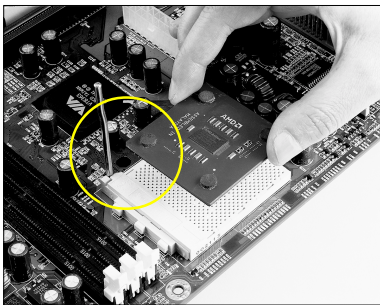

Figure 2

Step 2

Insert the processor.

Ensure proper pin 1 orientation by aligning the FC-PGA corner marking with the socket corner closest to the actuation arm tip. The pin field is keyed to prevent mis-oriented insertion. Don't force processor into socket. If it does not go in easily, check for mis-orientation and debris.

Make sure the processor is fully inserted into the socket on all sides.

Installation

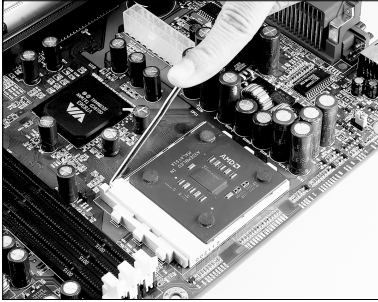

Figure 3

Step 3

Close the socket by lowering and locking the actuation lever.

Step 4

Thermal compound and qualified heatsink recommended by AMD are a must to avoid CPU overheat damage. For more information about installing your CPU, please refer to the AMD website article “Socket A AMD processor and Heatsink Installation Guide” <http://www.amd.com/products/cpg/athlon/pdf/23986.pdf>.

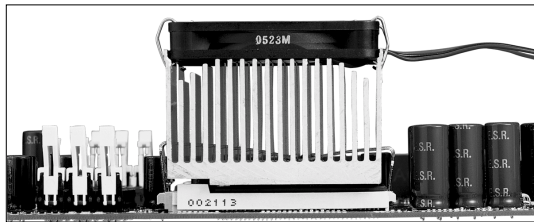
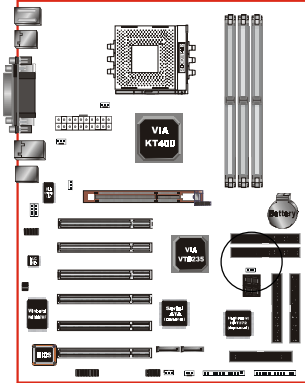

Figure 4

Section 3-2 Jumper Settings



JBAT



CMOS Clear

1-2: Normal (Default)

2-3: Clear CMOS

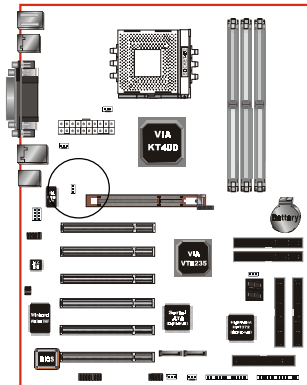

JCK1



CPU Host Clock Select

1-2: 100MHz (Default)

2-3: 133MHz

Installation

Section 3-3 System Memory Configuration

Memory Layout

The mainboard accommodates three PC1600/2100/2700 184-pin DIMMs (Dual In-line Memory Modules):

- Supports up to 3.0GB of 200/266/333MHz DDR SDRAM
- Supports up to 1GB per DIMM with maximum memory size up to 3GB (refer to Table 1)
- Supports DDR 200/266/333 unbuffered 184-pin non-ECC DDR SDRAM DIMMs
- Supports configurations defined in the JEDEC DDR DIMM specification

NOTE: Use DDR SDRAM (Double-Data-Rate Synchronous DRAM) modules only.

Figure 5 and Table 1 show several possible memory configurations.

<Figure 5>

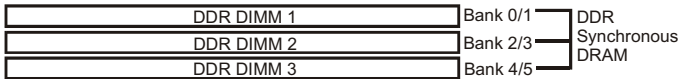

<Table 1>

Total Memory	DDR DIMM 1 (Bank 0/1)	DDR DIMM 2 (Bank 2/3)	DDR DIMM 3 (Bank 4/5)
= 1GB Maximum	DDR SDRAM* 64MB, 128MB, 256MB, 512MB, 1GB* X 1	None	None
= 2GB Maximum	DDR SDRAM* 64MB, 128MB, 256MB, 512MB, 1GB* X 1	DDR SDRAM* 64MB, 128MB, 256MB, 512MB, 1GB* X 1	None
= 3GB Maximum	DDR SDRAM* 64MB, 128MB, 256MB, 512MB, 1GB* X 1	DDR SDRAM* 64MB, 128MB, 256MB, 512MB, 1GB* X 1	DDR SDRAM* 64MB, 128MB, 256MB, 512MB, 1GB* X 1

* DDR SDRAM supports 64, 128, 256, 512MB and 1GB DIMM modules using 512Mb technology.

NOTES:

- DO NOT MIX the unbuffered and registered DDR SDRAM on DIMM1, DIMM2 and DIMM 3 socket.
- **When the FSB is 333MHz, you must to use PC2700 Memory.**
- Using non-compliant memory with higher bus speeds (overclocking) may severely compromise the integrity of the system.

DIMM Module Installation

Figure 6 displays the notch on the DDR DIMM memory module.

DIMMs have 184 pins and one notch that matches with the DDR DIMM socket. DIMM modules are installed by placing the chip firmly into the socket and pressing straight down as shown in figure 7 until the white clips close and the module fits tightly into the DIMM socket (figure 8).

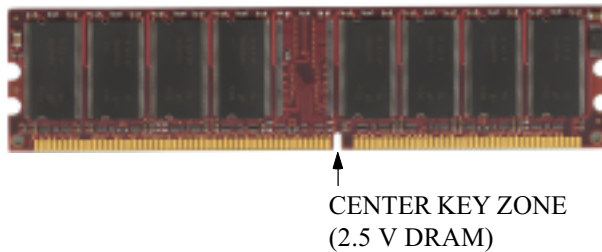

Figure 6 - DIMM notch

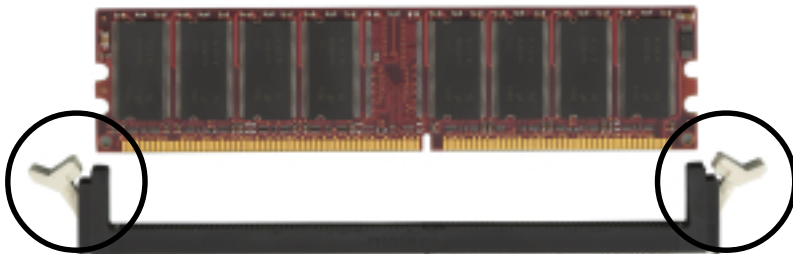

Figure 7 - DIMM module clips before installation



Figure 8 - DIMM module clip after installation

To remove the DIMM module press down the white clips and the module is released from the socket.

Installation

Section 3-4 Device Connectors

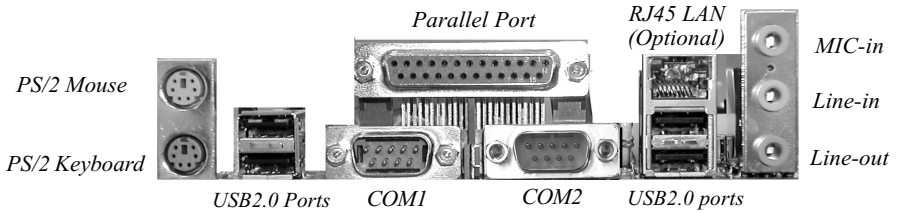
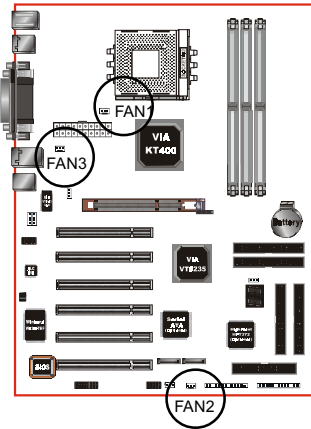

Figure 9 - I/O Ports



FAN1 / FAN2 / FAN3:

CPU/Chassis/Power Fan Power Connectors

FAN1:
CPU Fan

FAN2:
Chassis Fan

FAN3:
PW Fan

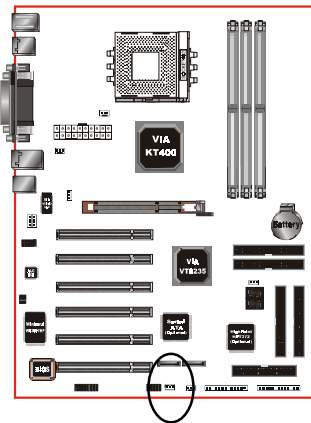
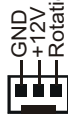

WOL1: WOL (Wake On LAN) Connector

Reserved for an NIC (Network Interface Card) to wake the system from power saving mode.

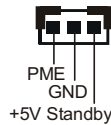

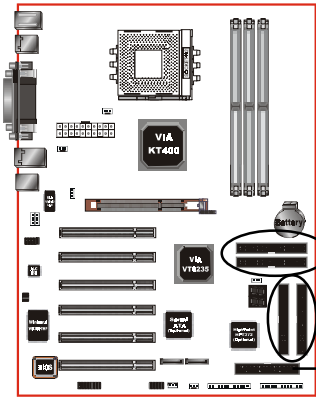

- IDE1/2:** Ultra DMA-66/100/133 Primary/Secondary IDE Connector (Blue)
- IDE3/4:** Ultra DMA-66/100/133 & RAID Primary/Secondary IDE Connector (Red) (Optional)
Supported by the HPT372 chipset
- FDD1:** Floppy Controller Connector (Black)

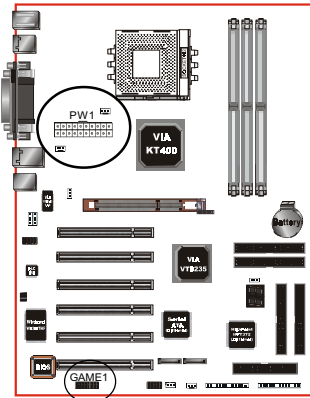

PW1: ATX Power Connector
(20-pin power connector)

GAME1: Game Port Connector

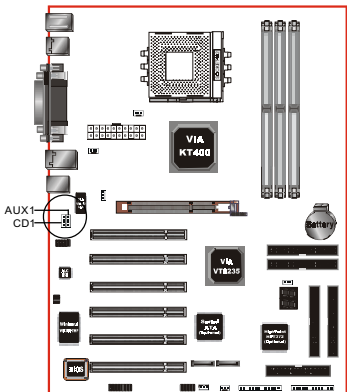

CD1: CD Audio_IN Connector



AUX1: Auxiliary Line_IN Connector



Installation

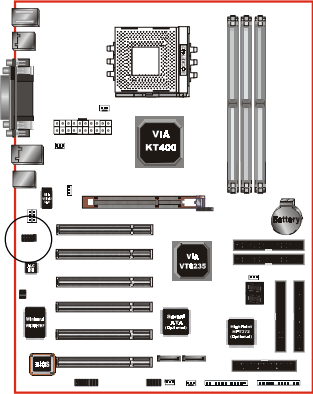

AUD2: Front Panel Audio Connector

When headphones are plugged into the front panel headphone jack, the rear panel audio output connectors are disabled.

If the front panel interface board is not connected to the front panel audio header, short pins 5 - 6 and 9 - 10 on the front panel audio header.

If these pins are not shorted, the rear panel audio connectors are inoperative.

Settings

Pins (5-6) & (9-10) Short (default): Only the Onboard Rear Audio Speaker can be used.

Pins (5-6) & (9-10) Open: Only Front Panel Audio Speaker can be used.

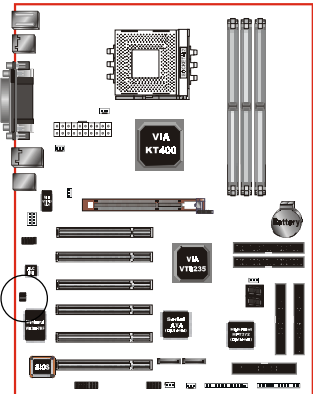
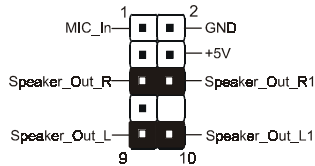

SPDIF1: Sony/Philips Digital Interface

This connector is the digital link between the mainboard and your audio devices, such as CD player, sampler or DAT recorder. It allows the digital transmission of audio data in SPDIF format.

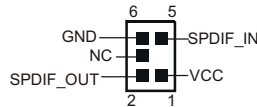

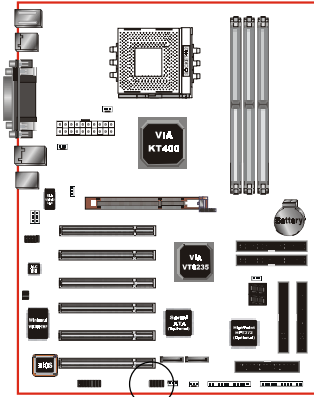

USB3: USB port header for two USB2.0 ports. The USB3 is used to connect bluetooth module for wireless connection.

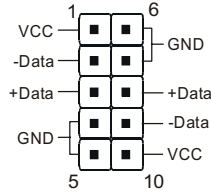

USB port header pin descriptions.

PIN#	Wire color	Signal Name	Comment
1	Red	Vcc	Cable Power
2	White	-Data	Data
3	Green	+Data	Data
4	Black	Ground	Cable Ground
5	Black	Ground	Case Ground
6	Black	Ground	Case Ground
7	Black	Ground	Cable Ground
8	Green	+Data	Data
9	White	-Data	Data
10	Red	Vcc	Cable Power

CAUTION !

Please make sure the USB cable has the same pin assignment. The different pin assignment may be caused damage of system.

If you need the USB cable, please contact our retailer.

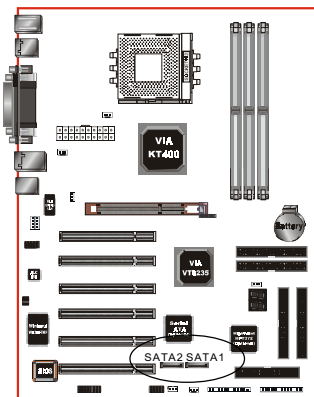

SATA1 / SATA2: (Optional)

1.5Gbps serial ATA Connectors

SATA1 and SATA2 enable you to connect two serial ATA devices that conform to the Serial ATA specification.

Serial ATA supports all ATA and ATAPI devices, including high capacity removable devices, optical devices, tape storage devices, and zip devices.

Installation

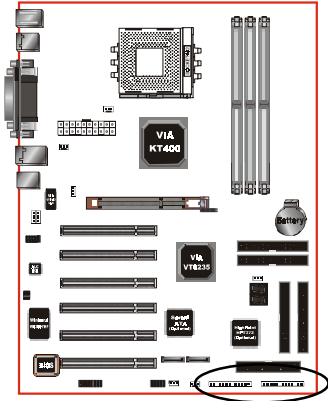

◆ Power On/Off

This is connected to the power button on the case. Using the Soft-Off by Pwr-BTTN feature, you can choose either Instant Off (turns system off immediately), or 4 sec delay (push the button for 4 seconds before the system turns off). When the system is in 4 sec delay mode, suspend mode is enabled by pushing the button momentarily.

◆ Turbo LED indicator

J3

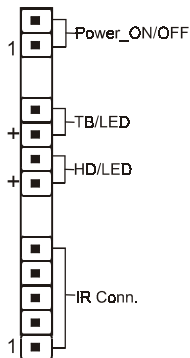

◆ IDE LED indicator

LED on when onboard PCI IDE Hard disks are being accessed.

◆ IR Connector

- | | |
|----------|---------|
| 1. VCC | 4. GND |
| 2. CIRRX | 5. IRTX |
| 3. IRRX | |

◆ Power LED

Power LED connector

- | | |
|-----------------|--------|
| 1. Power LED(+) | 4. NC |
| 2. N/C | 5. GND |
| 3. GND | |

◆ Speaker

Connect to the system's speaker for beeping

- | | |
|------------|--------|
| 1. Speaker | 3. GND |
| 2. N/C | 4. VCC |

◆ Reset

Closed to restart system.

J2

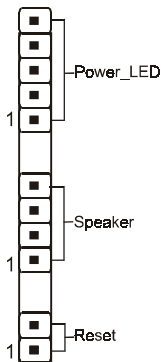

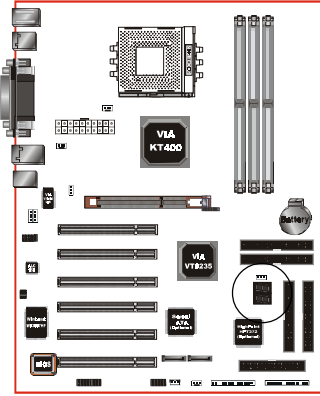

LED1: 80 Port Debug LED (Optional)



80 Port Debug 7-segment LED display (Refer to Appendix E for POST codes)

Installation

Section 3-5

External Modem Ring Power ON and Keyboard Power ON Functions (KBPO)

Modem Ring Power ON Function

The I/O chipset provides the two serial ports with the External Modem Ring-in Power ON function. Once you connect an external modem to COM1 or COM2, the mainboard enables you to turn on the system through remote and host dial-up control.

Keyboard Power ON Function

The mainboard features a keyboard power on function that enables you to turn on the power supply using a keypress. Follow these instructions to enable the Keyboard Power ON function .

Step : Use the Keyboard Power ON function (KBPO) to turn on the system by using password, or hot key combination as set in the BIOS IRQ/Event Activity Detect submenu of Power Management Setup menu. The BIOS default setting is keyboard <Ctrl> + <F1>. To power off the system, use the soft-OFF function under Windows 2000/98/95 (refer to Windows online help).

NOTES:

- Intel ATX version 2.0 specification recommends you use a power supply that supplies ≥ 1.0 A in 5 VSB. However, this mainboard supports a 5 VSB standby power supply ≥ 0.1 A (100mA).
- We recommend you use the power supply with 1.0 A in 5 VSB, which supports PCI 2.2 specification for remote power-on and wake-up functions.

3-6 STR (Suspend To RAM) Function

This mainboard supports the STR (Suspend To RAM) power management scheme by maintaining the appropriate power states in the DDR SDRAM interface signals. The power source to the DDR SDRAM must be kept active during STR (ACPI S3). Advanced Configuration Power Interface (ACPI) provides many Energy Saving Features for operating systems that support Instant ON and QuickStart™ function.

1. Use the STR functionality to save system power, you are recommended to confirm the following requirements:
 - a. Install ACPI qualified add-on cards (such as AGP, LAN, and modem cards).
 - b. In BIOS under Power Management Setup (refer to Section 4), select “ACPI Suspend Type: S3(STR)” and “USB Resume from S3: Enabled” (if you have a USB mouse or keyboard device).
 - c. Install Windows® XP/2000/ME/98SE.
 - d. Restart the system.
 - e. Open the Control Panel Power Management application, and click the Advanced tab. In the Power buttons section, select “Stand By” from the drop-down lists.
2. To enable the STR function, click the START button and choose Shut Down. In the Shut Down Windows dialog box, select the Stand By option to enter STR mode.

The following lists the differences between STR power saving mode and Green (or Suspend) mode:

- a. STR is the most advanced Power Management mode.
- b. STR cuts all the power supplied to peripherals except to memory - max. power saving.
- c. STR saves and keeps all on-screen data including any executed applications to DDR SDRAM.
- d. In STR mode, you must push the power button (connected to the onboard J3 pin), click your USB mouse buttons, or press your USB keyboard keys to wake up your system to the last display.

Installation

3-7 CPU Overheating Protection

This board has CPU Overheating Protection when the temperature of CPU is overheating. This board supports automatically shutdown (to remove power) circuit when the CPU has reached the temperature of approximately 110°C. Meanwhile the speaker will sustained beep and the system will not be to power on. This protection is designed by hardware, you don't need to do the BIOS setup.

To power on your system normally, we recommend you to confirm the following steps:

- Step1:** Unplug in the ATX power core (or turn off ATX power supply switch).
- Step2:** Please wait the beep to stop then plug in the ATX power core again (or turn on ATX power switch) to turn on your system.

Note: The CPU Overheating Protection will function only when CPU has thermal diode design.

Section 4

AWARD BIOS SETUP

Main Menu

Award's ROM BIOS provides a built-in Setup program which allows user to modify the basic system configuration and hardware parameters. The modified data is stored in a battery-backed CMOS, so that data will be retained even when the power is turned off. In general, the information saved in the CMOS RAM will stay unchanged unless there is a configuration change in the system, such as hard drive replacement or a device is added.

It is possible for the CMOS battery to fail causing CMOS data loss. If this happens you will need install a new CMOS battery and reconfigure your BIOS settings.

To enter the Setup Program :

Power on the computer and press the key during the POST (Power On Self Test). The BIOS CMOS SETUP UTILITY opens.

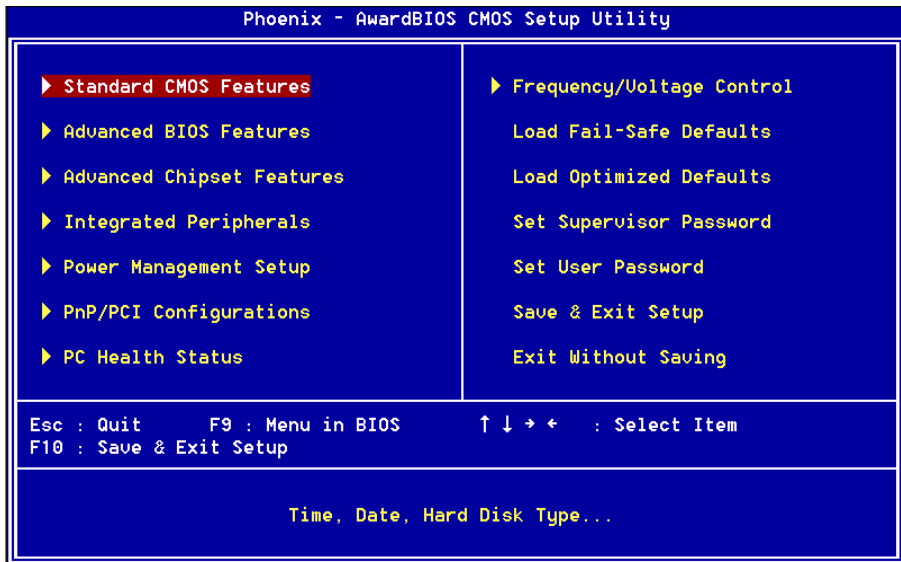

Figure 1: CMOS Setup Utility

BIOS

The main menu displays all the major selection items. Select the item you need to reconfigure. The selection is made by moving the cursor (press any direction (arrow key) to the item and pressing the 'Enter' key. An on-line help message is displayed at the bottom of the screen as the cursor is moved to various items which provides a better understanding of each function. When a selection is made, the menu of the selected item will appear so that the user can modify associated configuration parameters.

4-1 Standard CMOS Setup

Choose "STANDARD CMOS FEATURES" in the CMOS SETUP UTILITY Menu (Figure 2). Standard CMOS Features Setup allows the user to configure system settings such as the current date and time, type of hard disk drive installed, floppy drive type, and display type. Memory size is auto-detected by the BIOS and displayed for your reference. When a field is highlighted (use direction keys to move the cursor and the <Enter> key to select), the entries in the field can be changed by pressing the <PgDn> or the <PgUp> key.

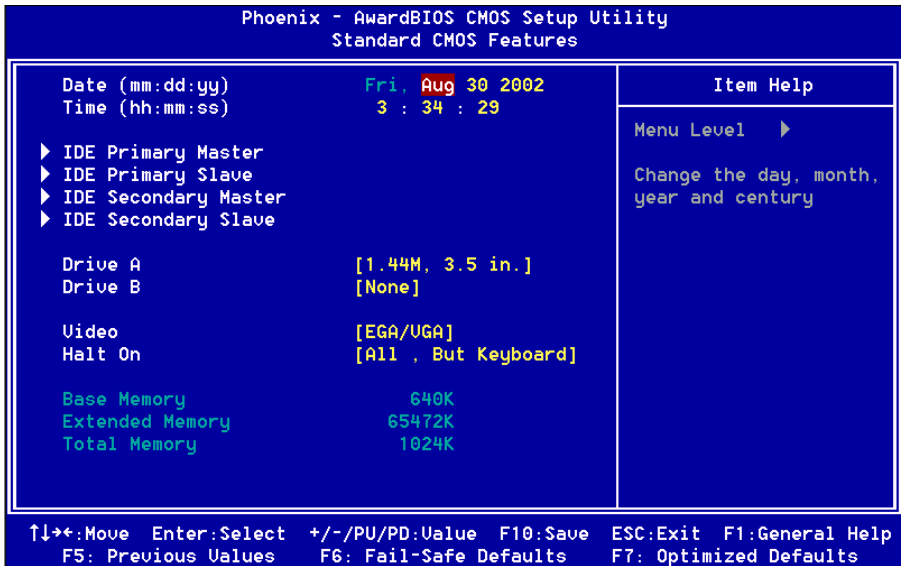

Figure 2: Standard CMOS Setup

Notes:

- If the hard disk Primary Master/Slave and Secondary Master/Slave are set to Auto, then the hard disk size and model will be auto-detected.
- The “Halt On:” field is used to determine when to halt the system by the BIOS if an error occurs.
- Floppy 3 Mode support is a mode used to support a special 3.5-inch drive used in Japan. This is a 3.5-inch disk that stores 1.2 MB. The default setting for this is disabled.

4-2 Advanced BIOS Features

Selecting the “ADVANCED BIOS FEATURES” option in the CMOS SETUP UTILITY menu allows users to change system related parameters in the displayed menu. This menu shows all of the manufacturer’s default values for the board. Pressing the [F1] key displays a help message for the selected item.

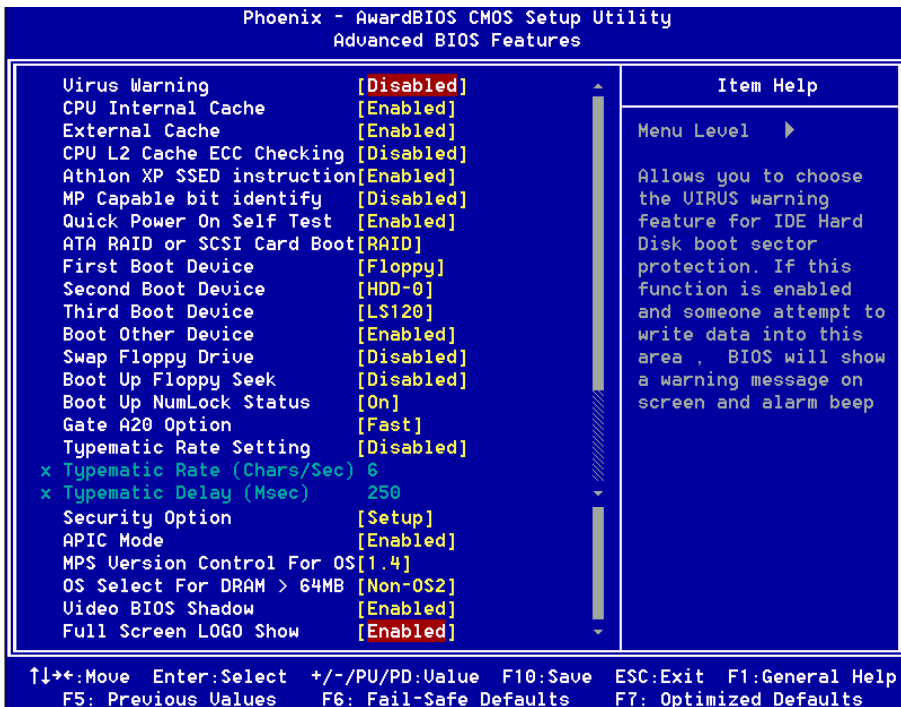

Figure 3: BIOS Features Setup

BIOS

Virus Warning

During and after system boot up, any attempt to write to the boot sector or partition table of the hard disk drive halts the system and an error message appears. You should then run an anti-virus program to locate the virus. Keep in mind that this feature protects only the boot sector, not the entire hard drive. The default is Disabled.

Enabled: Activates automatically when the system boots up causing a warning message to appear when anything attempts to access the boot sector.

Disabled: No warning message appears when anything attempts to access the boot sector.

Note: Many disk diagnostic programs that access the boot sector table can trigger the virus warning message. If you plan to run such a program, we recommend that you first disable the virus warning.

CPU Internal Cache

This controls the status of the processor's internal cache area. The default is Enabled.

Options: Enabled, Disabled.

External Cache

This controls the status of the external (L2) cache area. The default is Enabled.

Options: Enabled, Disabled.

CPU L2 Cache ECC Checking

This item allows you to enable/disable CPU L2 Cache ECC checking.

Options: Enabled, Disabled.

Athlon 4 SSE3 instruction

This item allows you to disable Athlon 4 new SSE3 instruction. The default is Enabled.

Options: Enabled, Disabled.

MP Capable bit identify

This item allows you to identify Athlon MP Processor, if this function is Enabled. The default is Disabled.

Options: Enabled, Disabled.

Quick Power On Self Test

This category speeds up the Power On Self Test (POST). The default is Enabled.

Enabled: This setting will shorten or skip of the items checked during POST.

Disabled: Normal POST.

ATA RAID & SCSI Card Boot

Setup the boot up priority either form onboard ATA RAID connector or SCSI Card, if you select SCSI as the first boot at the option below item. The default is RAID, SCSI.

Options: RAID, SCSI.

First /Second/Third/Other Boot Device

The BIOS attempts to load the operating system from the devices in the sequence selected in these items.

Options: Floppy, LS120, HDD-0, SCSI, CDROM, HDD-1, HDD-2, HDD-3, ZIP100, USB-FDD, USB-ZIP, USB-CDROM, USB-HDD, LAN, Disabled.

Boot Other Device

When enabled, the system searches all other possible locations for an operating system if it fails to find one in the devices specified under the first, second, and third boot devices. The default is Enabled.

Options: Enabled, Disabled.

Swap Floppy Drive

This will swap your physical drive letters A & B if you are using two floppy disks. The default is Disabled.

Enabled: Floppy A & B will be swapped under the O/S.

Disabled: Floppy A & B will be not swapped.

Boot Up Floppy Seek

If this item is enabled, it checks the size of the floppy disk drives at start-up time. You don't need to enable this item unless you have a legacy diskette drive with 360K capacity. The default is Disabled.

Options: Enabled, Disabled.

Boot Up NumLock Status

This controls the state of the NumLock key when the system boots. The default is On.

On: The keypad acts as a 10-key pad.

Off: The keypad acts like cursor keys.

BIOS

Gate A20 Option

This refers to the way the system addresses memory above 1 MB (extended memory). The default is Normal.

Normal: The A20 signal is controlled by the keyboard controller or chipset hardware.

Fast: The A20 signal is controlled by Port 92 or chipset specific method.

Typematic Rate Setting

This determines the keystrokes repeat rate. The default is Disabled.

Enabled: Allows typematic rate and typematic delay programming.

Disabled: The typematic rate and typematic delay will be controlled by the keyboard controller in your system.

Typematic Rate (Chars/Sec)

This is the number of characters that will be repeated by a keyboard press. The default is 6.

Options: 6 ~ 30 characters per second.

Typematic Delay (msec)

This setting controls the time between the first and the second character displayed by typematic auto-repeat. The default is 250.

Options: 250/500/750/1000 msec.

Security Option

This category allows you to limit access to the System and Setup, or just to Setup. The default is Setup.

System: The system will not boot and the access to Setup will be denied if the correct password is not entered at the prompt.

Setup: The system will boot; but the access to Setup will be denied if the incorrect password is not entered at the prompt.

APIC Mode

This item allows you to enable APIC (Advanced Programmable Interrupt Controller) functionality. APIC is an Intel chip that provides symmetric multiprocessing (SMP) for its Pentium systems. The default is Disabled.

Options: Enabled, Disabled.

MPS Version Control For OS

Specifies the Multiprocessor Specification (MPS). Version 1.4 supports multiple PCI bus configurations by incorporating extended bus definitions. Enable this for Windows NT or Linux. For older operating systems, select Version 1.1. The default is 1.4.

Options: 1.1, 1.4.

OS Select For DRAM > 64 MB

Some operating systems require special handling. Use this option only if your system has greater than 64 MB of memory. The default is Non-OS2.

OS2: Select this if you are running the OS/2 operating system with greater than 64 MB of RAM.

Non-OS2: Select this for all other operating systems and configurations.

Video BIOS Shadow

This option allows video BIOS to be copied into RAM. Video Shadowing will increase the video performance of your system.

Options: Enabled, Disabled.

Full Screen LOGO Show

This option allows you determine Full Screen LOGO display when POST.

Options: Enabled, Disabled.

BIOS

4-3 Advanced Chipset Features

Choose the “ADVANCED CHIPSET FEATURES” option in the CMOS SETUP UTILITY menu to display following menu.

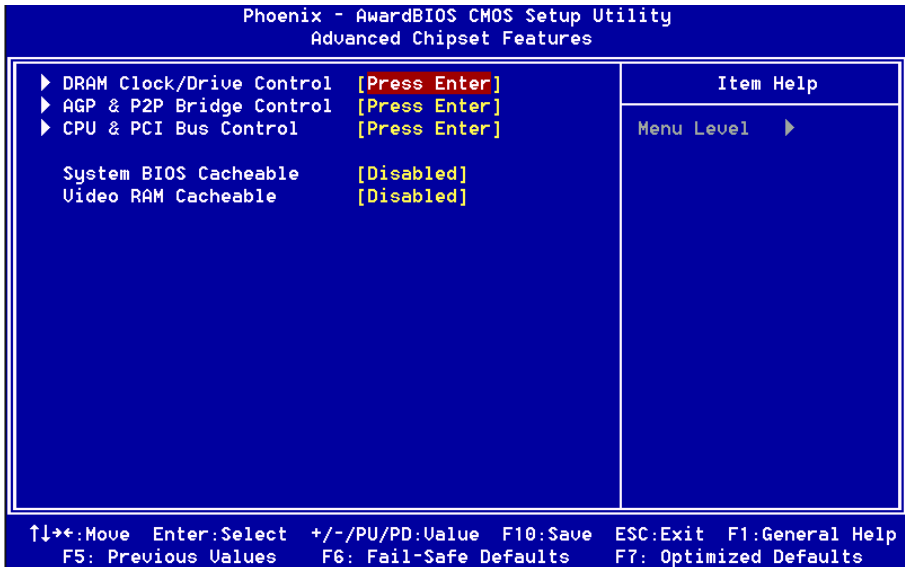

Figure 4: Chipset Features Setup

System BIOS Cacheable

This item allows the system to be cached in memory for faster execution. The default is Enabled.

Options: Disabled, Enabled.

Video RAM Cacheable

This option allows the CPU to cache read/writes of the video RAM. The default is Enabled.

Options: Disabled, Enabled.

► **DRAM Clock / Drive Control**

Scroll to DRAM Clock/Timing Control and press <Enter>. The following screen appears:

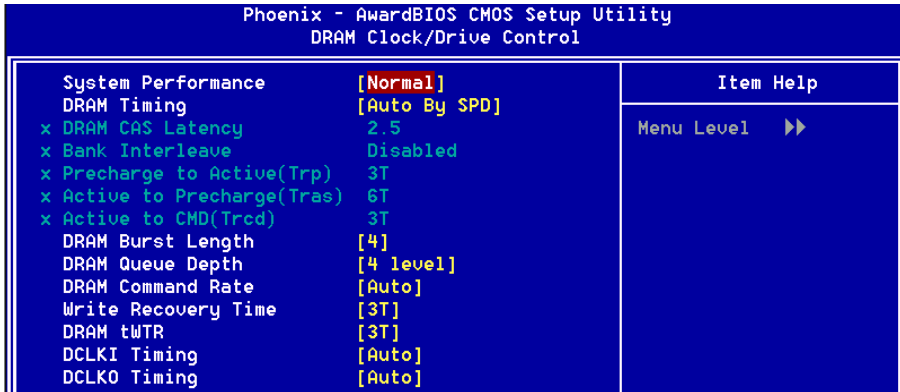

System Performance

This item will help you to configure your system performance quickly and easily.

Options: Normal, Fast, Turbo, Ultra.

Note: If you select the higher performance, compatibility problem could be occurred.

DRAM Timing

For setting DRAM Timing, By SPD is follow SDRAM Serial Presence Detect Specification.

Options: Manual, Auto by SPD.

DRAM CAS Latency

Enables you to select the CAS latency time. The value is set at the factory depending on the DRAM installed. Do not change the values in this field unless you change specifications of the installed DRAM and DRAM clock from DRAM Timing Selectable. The default is set by SPD (see ‘DRAM Timing’).

Options: 1.5, 2, 2.5, 3.

Bank Interleave

The item allows you to set how many banks of SDRAM support in your mainboard. Default is by SPD.

Options: 2 Bank, 4 Bank, Disabled.

BIOS

Precharge to Active (Trp)

This item refers to the number of cycles required to return data to its original location to close the bank or the number of cycles required to page memory before the next bank activate command can be issued. The default is by DRAM SPD.
Options: 3T, 2T.

Active to Precharge (Tras)

This item specifies the number of clock cycles needed after a bank active command before a precharge can occur (sets the minimum RAS pulse width.). The default is by DRAM SPD.
Options: 6T, 5T.

Active to CMD (Trcd)

This item sets the timing parameters for the system memory such as the CAS (Column Address Strobe) and RAS (Row Address Strobe). The default is by DRAM SPD.
Options: 3T, 2T, 4T, 5T.

DRAM Burst Length

Options: 4, 8.

DRAM Queue Depth

Options: 4 level, 2 level, 3 level.

DRAM Command Rate

Setup the timing at each cycle.
Options: 1T Command, 2T Command, Auto.

Write Recovery Time

Options: 2T , 3T.

DRAM tWTR

TWTR Timing Control
Options: 1T , 3T.

DCLKI/DCLKO Timing

Options: 0ns, 0.5ns, 1ns, 1.5ns, Auto.

► **AGP & P2P Bridge Control**

Scroll to AGP & P2P Bridge Control and press <Enter>. The following screen appears:

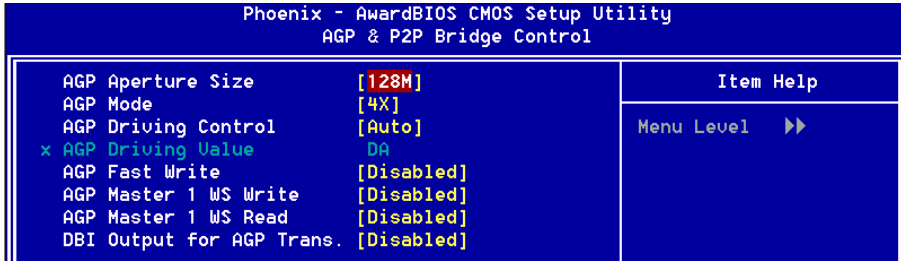

AGP Aperture Size (MB)

This item defines the size of the aperture if you use an AGP graphics adapter. It refers to a section of the PCI memory address range used for graphics memory. The default is 128 MB.

Options: 4, 8, 16, 32, 64, 128, 256 MB.

AGP Mode

Chipset AGP Mode support.

Options: 1X, 2X, 4X.

AGP Driving Control

This item allows you to adjust the AGP driving force. Choose Manual to key in a AGP Driving Value in the next selection. This field is recommended to set in **Auto** for avoiding any error in your system.

Options: Auto, Manual.

AGP Fast Write

Selecting Enabled allows to use Fast Write Protocol for 4X AGP card.

Options: Enabled, Disabled.

AGP Master 1 WS Write

When Enabled, Writes to the AGP (Accelerated Graphics Port) are executed with one wait states.

Options: Enabled, Disabled.

BIOS

AGP Master 1 WS Read

When Enabled, Reads to the AGP (Accelerated Graphics Port) are executed with one wait states.

Options: Enabled, Disabled.

DBI Output for AGP Trans.

Enables DBI output for AGP transactions.

Options: Enabled, Disabled.

▶ CPU & PCI Bus Control

Scroll to CPU & PCI Bus Control and press <Enter>. The following screen appears:

Phoenix - AwardBIOS CMOS Setup Utility	
CPU & PCI Bus Control	
PCI1 Master 0 WS Write	[Enabled]
PCI2 Master 0 WS Write	[Enabled]
PCI1 Post Write	[Enabled]
PCI2 Post Write	[Enabled]
VLink 8X Support	[Enabled]
PCI Delay Transaction	[Enabled]

Item Help
Menu Level ▶▶

PCI1/2 Master 0 WS Write

When Enabled, Writes to the PCI bus are commanded with zero wait states.

Options: Enabled, Disabled.

PCI1/2 Post Write

Enables CPU to PCI bus POST write.

Options: Enabled, Disabled.

VLink 8X Support

Enables VLink 8X support.

Options: Enabled, Disabled.

PCI Delay Transaction

The chipset has an embedded 32-bit posted write buffer to support delay transactions cycles. Select Enabled to support compliance with PCI specification version 2.2.

Options: Enabled, Disabled.

4-4 Integrated Peripherals

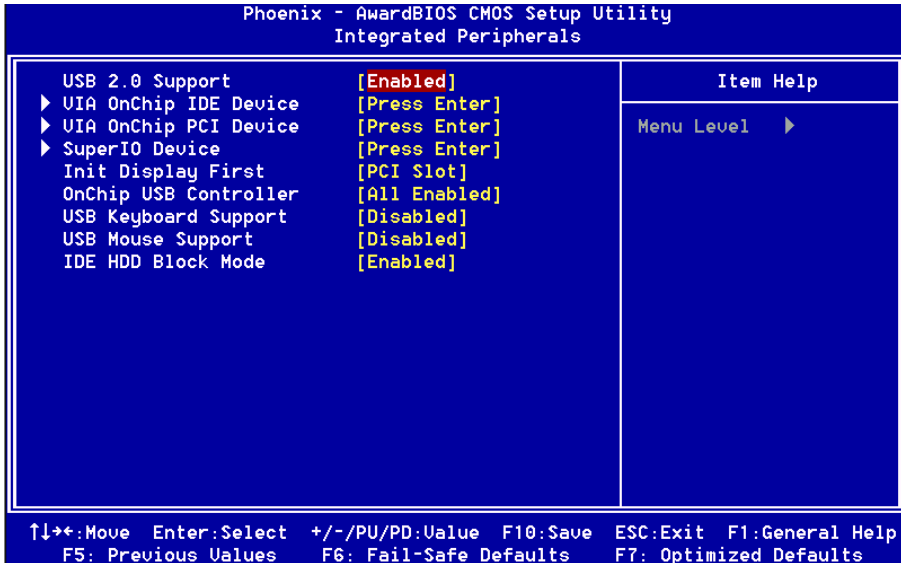

Figure 5: Integrated Peripherals

Notes:

- If you do not use the Onboard IDE connector, then you will need to set Onboard Primary PCI IDE: Disabled and Onboard Secondary PCI IDE: Disabled
- The Onboard PCI IDE cable should be equal to or less than 18 inches (45 cm.).

USB 2.0 Support

Enables the USB 2.0 support.

Options: Disabled, Enabled.

Init Display First

If two video cards are used (1 AGP and 1 PCI) this specifies which one will be the primary display adapter. The default is PCI Slot.

Options: PCI Slot, AGP.

Onchip USB Controller

Enables the USB controller.

Options: All Disabled, All Enabled, 1&2 USB port, 2&3 USB port, 1&3 USB port, 1 USB port, 2 USB port, 3 USB port.

BIOS

USB Keyboard Support

Your system contains a Universal Serial Bus (USB) controller and you have a USB keyboard Device. The default is Disabled.

Options: Enabled, Disabled.

USB Mouse Support

Your system contains a Universal Serial Bus (USB) controller and you have a USB Mouse Device. The default is Disabled.

Options: Enabled, Disabled.

IDE HDD Block Mode

Block mode is also called block transfer, multiple commands, or multiple sector read/write. If your IDE hard drive supports block mode (most new drives do), select Enabled for automatic detection of the optimal number of block read/writes per sector the drive can support.

Options: Enabled, Disabled.

► VIA OnChip IDE Device

Scroll to VIA Onchip IDE Device and press <Enter>. The following screen appears:

The screenshot shows the BIOS setup utility interface. The title bar reads "Phoenix - AwardBIOS CMOS Setup Utility" and the current screen is titled "VIA OnChip IDE Device". The settings are as follows:

VIA OnChip IDE Device		Item Help
OnChip IDE Channel0	[Enabled]	
OnChip IDE Channel1	[Enabled]	
IDE Prefetch Mode	[Enabled]	
Primary Master PIO	[Auto]	Menu Level ►►
Primary Slave PIO	[Auto]	
Secondary Master PIO	[Auto]	
Secondary Slave PIO	[Auto]	
Primary Master UDMA	[Auto]	
Primary Slave UDMA	[Auto]	
Secondary Master UDMA	[Auto]	
Secondary Slave UDMA	[Auto]	
CDROM UDMA Support	[Disabled]	

OnChip IDE Channel0/1

The integrated peripheral controller contains an IDE interface with support for two IDE channels. Select *Enabled* to activate each channel separately.

Options: Enabled, Disabled.

IDE Prefetch Mode

Selecting Enabled reduces latency between each drive read/write cycle, but may cause instability in IDE subsystems that cannot support such fast performance. If you are getting disk drive errors, try setting this value to Disabled. This field does not appear when the Internal PCI/IDE field, above, is Disabled.

Options: Enabled, Disabled.

Primary/Secondary Master/Slave PIO

The four IDE PIO (Programmed Input/Output) fields let you set a PIO mode (0-4) for each of the four IDE devices that the onboard IDE interface supports. Modes 0 through 4 provide successively increased performance. In Auto mode, the system automatically determines the best mode for each device. The default is Auto.

Options: Auto, Mode 0 ~ 4.

Primary/Secondary Master/Slave UDMA

This allows you to select the mode of operation for the Ultra DMA-33/66/100/133 implementation is possible only if your IDE hard drive supports it and the operating environment includes a DMA driver (Windows 95 OSR2 or a third-party IDE bus master driver). If your hard drive and your system software both support Ultra DMA-33/66/100/133, select Auto to enable UDMA mode by BIOS or you can select mode by manual.

Options: Auto, Disabled.

CDROM UDMA Support

This allows you to select the mode of operation for the CDROM implementation is possible only if your CDROM drive supports it and the operating environment includes a DMA driver (Windows 95 OSR2 or a third-party IDE bus master driver).

Options: Enabled, Disabled.

BIOS

▶ VIA Onchip PCI Device

Scroll to VIA Onchip PCI Device and press <Enter>. The following screen appears:

The screenshot shows the BIOS setup utility for Phoenix - AwardBIOS. The title bar reads "Phoenix - AwardBIOS CMOS Setup Utility" and "VIA OnChip PCI Device". The main menu is as follows:

		Item Help
VIA AC97 Audio	[Auto]	
AC97 Speaker At POST	[Disabled]	
Game Port Address	[201]	
Midi Port Address	[Disabled]	Menu Level ▶▶
x Midi Port IRQ	10	
VIA OnChip LAN	[Enabled]	
Onboard Lan Boot ROM	[Disabled]	
High Point IDE RAID	[Auto]	
\$i1 3112 Serial ATA	[Enabled]	
Serial ATA Mode	[RAID]	

VIA AC97 Audio

This item allows you to enable or disable the chipset family to support AC97 Audio. The system default is Enabled.

Options: Auto, Disabled.

AC97 Speaker At POST

This item allows you to decide to enable or disable AC97 Speaker At POST function. The default is Disabled.

Options: Enabled, Disabled.

Game Port Address

Select an address for the Game port.

Options: 201 (default), 209, Disabled.

Midi Port Address

Select an address for the Midi port.

Options: 290, 300, 330, Disabled (default).

Midi Port IRQ

Select an interrupt for the Midi port.

Options: 5, 10 (default).

VIA Onchip LAN (Optional)

Enables the onboard LAN feature. The default is Enabled.

Options: Enabled, Disabled.

Onboard Lan Boot ROM (Optional)

Enables and disables the onboard LAN Boot ROM. The default is Disabled.

Options: Enabled, Disabled.

High Point IDE RAID

Enables the onboard PCI device High Point IDE RAID.

Options: Auto (default), Enabled, Disabled.

Sil 3112 Serial ATA

Enables the onboard Sil 3112 serial ATA feature.

Options: Enabled, Disabled.

Serial ATA Mode

This item allows to select Serial ATA mode.

Options: IDE, RAID.

► **Super IO Chip Setup**

Scroll to Super IO Chip Setup and press <Enter>. The following screen appears:

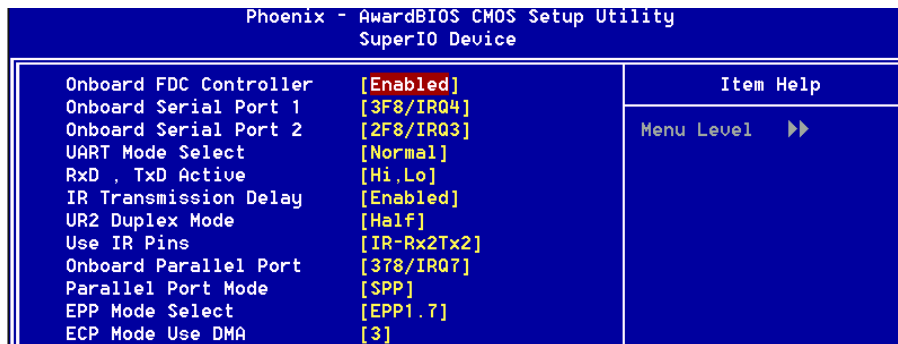

Onboard FDC Controller

Select Enabled if your system has a floppy disk controller (FDC) installed on the system board and you wish to use it. If you install and-in FDC or the system has no floppy drive, select Disabled in this field.

Options: Enabled, Disabled.

Onboard Serial Port 1/2

Select an address and corresponding interrupt for the first and second serial ports.

Options: 3F8/IRQ4, 2E8/IRQ3, 3E8/IRQ4, 2F8/IRQ3, Disabled, Auto.

BIOS

UART Mode Select

This field allows the users to configure what IR mode the 2nd serial port should use. The default is Normal.

Options: Normal, IrDA and ASKIR.

RxD, TxD Active

This field configures the receive and transmit signals generated from the IR port. The default is Hi Lo (when UART Mode Select is not set to Normal).

Options: Hi Hi, Hi Lo, Lo Hi, and Lo Lo.

IR Transmission delay

This item allows you to enable/disable IR transmission delay.

Options: Enabled, Disabled.

UR2 Duplex Mode

This item allows you to select IR half/full duplex function.

Options: Half, Full.

Use IR Pins

This item allows you to select IR transmission routes, one is RxD2, TxD2 (COM Port) and the other is IR-Rx2Tx2.

Options: IR-Rx2Tx2, RxD2, TxD2.

Onboard Parallel Port

This field allows the user to configure the LPT port.

Options: 378/IRQ7, 278/IRQ5, 3BC/IRQ7, Disabled.

Parallel Port Mode

This field allows the user to select the parallel port mode.

Options: SPP, EPP, ECP, ECP+EPP.

EPP Mode Select

This item allows you to determine the IR transfer mode of onboard I/O chip.

Options: EPP1.9, EPP1.7.

ECP Mode USE DMA

This field allows the user to select DMA1 or DMA3 for the ECP mode.

Options: DMA1, DMA3.

4-5 Power Management Setup

Choose the “POWER MANAGEMENT SETUP” in the CMOS SETUP UTILITY to display the following screen. This menu allows the user to modify the power management parameters and IRQ signals. In general, these parameters should not be changed unless it’s absolutely necessary.

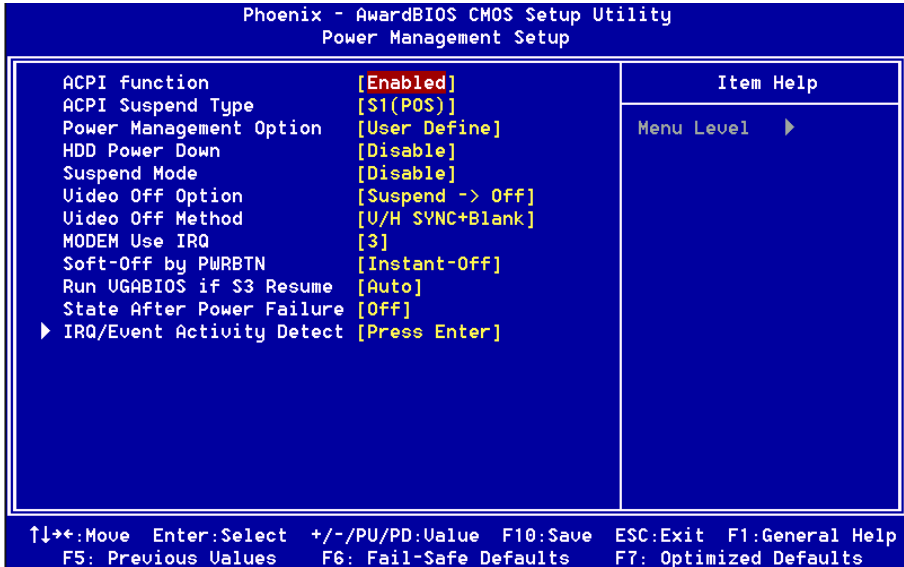

Figure 6: Power Management

ACPI Function

This option allows you to select ACPI Function. The default is Enabled.

Options: Enabled, Disabled.

ACPI Suspend Type

This item allows you to select S1(POS) or S3(STR) function.

Options: S1(POS), S3(STR), S1&S3.

Power Management Option

Use this to select your Power Management selection. The default is User define.

Max. saving: Maximum power savings. Inactivity period is 1 minute in each mode.

Min. saving: Minimum power savings. Inactivity period is 1 hour in each mode.

BIOS

User define: Allows user to define PM Timers parameters to control power saving mode.

HDD Power Down

When enabled and after the set time of system inactivity, the hard disk drive will be powered down while all other devices remain active.

Options: Enabled, 1Min ~ 15Min.

Suspend Mode

enabled and after the set time of system inactivity, all devices except the CPU will be shut off.

Options: Enabled, 1 , 2, 4 ,6, 8, 10, 20, 30, 40Min and 1Hour .

Video Off Option

When enabled, this feature allows the VGA adapter to operate in a power saving mode.

Always On: Monitor will remain on during power saving modes.

Suspend->Off: Monitor blanked when the systems enters the suspend mode.

Video Off Method

This option allows you to select how the video will be disabled by the power management. The default is V/H Sync + Blank

V/H Sync + Blank: System turns off vertical and horizontal synchronization ports and writes blanks to the video buffer.

DPMS Support: Select this option if your monitor supports the Display Power Management Signaling (DPMS) standard of the Video Electronics Standards Association (VESA). Use the software supplied for your video subsystem to select video power management values.

Blank Screen: System only writes blanks to the video buffer.

MODEM Use IRQ

Name the interrupt request (IRQ) line assigned to the modem (if any) on your system. Activity of the selected IRQ always awakens the system. Default is IRQ 3.

Options: N/A, 3, 4, 5, 7, 9, 10, 11

Soft-Off by PWRBTN

Pressing the power button for more than 4 seconds forces the system to enter the Soft-Off state when the system has “hung.” The default is Instant-off.

Options: Delay 4 Sec, Instant-Off.

Run VGABIOS if S3 Resume

This determines whether or not to enable the system to run the VGA BIOS when resuming from S3(STR) or S1&S3.

Options: Auto, Yes, No.

State After Power Failure

The system will stay of or power on after a power interrupt. The default is Off.

Off: System always stay off after a power interrupt.

On: System always power on after a power interrupt.

Auto: Stay off or power on depend on system safe shutdown or power fail.

► **IRQ/Event Activity Detect**

Scroll to IRQ/Event Activity Detect and press <Enter>. The following screen appears:

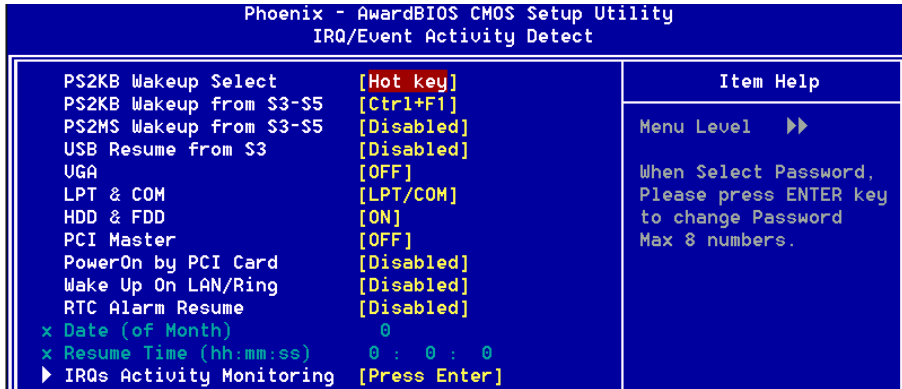

BIOS

PS2KB Wakeup Select

This item allows you to select Hot Key or Password to wake-up the system by PS2 Keyboard. When select Password, please press ENTER key to change password max 8 numbers.

Options: Hot key, Password.

PS2KB Wakeup form S3-S5

This item allows you to set a Hot Key to wake-up the system by PS2 Keyboard.

Options: Disabled, Ctrl+F1, Ctrl+F2, Ctrl+F3, Ctrl+F4, Ctrl+F5, Ctrl+F6, Ctrl+F7, Ctrl+F8, Ctrl+F9, Ctrl+F10, Ctrl+F11, Ctrl+F12, Power, Wake, Any key.

Note: Power and Wake are Windows98 Keyboard button.

PS2MS Wakeup form S3-S5

This item allows you to wake-up the system by PS2 Mouse.

Options: Enabled, Disabled.

USB Resume from S3

This item allows you to wake-up the system by USB device when you save the computer power at S3.

Options: Enabled, Disabled.

VGA

When set to On (default), any event occurring at a VGA port will awaken a system which has been powered down.

LPT & COM

When set to *On* (default), any event occurring at a COM(serial)/LPT (printer) port will awaken a system which has been powered down.

HDD & FDD

When set to *On* (default), any event occurring at a hard or floppy drive port will awaken a system which has been powered down.

PCI Master

When set to *On* (default), any event occurring to the DMA controller will awaken a system which has been powered down.

PowerOn by PCI Card

An input signal form PME on the PCI card awakens the system from a soft off state.

Wake Up On LAN/Ring

When set to *Enabled*, any event occurring to the Modem Ring / LAN will awaken a system which has been powered down.

RTC Alarm Resume

When set to *Enable rtc alarm resume*, you could set the date (of month) and timer (hh:mm:ss), any event occurring at will awaken a system which has been powered down.

► IRQs Activity Monitoring

Scroll to IRQs Activity Monitoring and press <Enter>. The following screen appears:

Phoenix - AwardBIOS CMOS Setup Utility		
IRQs Activity Monitoring		
		Item Help
Primary INTR	[ON]	
IRQ3 (COM 2)	[Enabled]	
IRQ4 (COM 1)	[Enabled]	
IRQ5 (LPT 2)	[Enabled]	Menu Level >>>
IRQ6 (Floppy Disk)	[Enabled]	
IRQ7 (LPT 1)	[Enabled]	
IRQ8 (RTC Alarm)	[Disabled]	
IRQ9 (IRQ2 Redir)	[Disabled]	
IRQ10 (Reserved)	[Disabled]	
IRQ11 (Reserved)	[Disabled]	
IRQ12 (PS/2 Mouse)	[Enabled]	
IRQ13 (Coprocessor)	[Enabled]	
IRQ14 (Hard Disk)	[Enabled]	
IRQ15 (Reserved)	[Disabled]	

Primary INTR

When set to *On* (default), any event occurring at will awaken a system which has been powered down.

IRQs 3-15

Allows you to set system to monitor IRQs 3-15 for activity to awaken system form a power management mode.

4-6 PNP/PCI Configuration

The PNP/PCI configuration program is for the user to modify the PCI/ISA IRQ signals when various PCI/ISA cards are inserted in the PCI or ISA slots.

WARNING: Conflicting IRQ's may cause the system to not find certain devices.

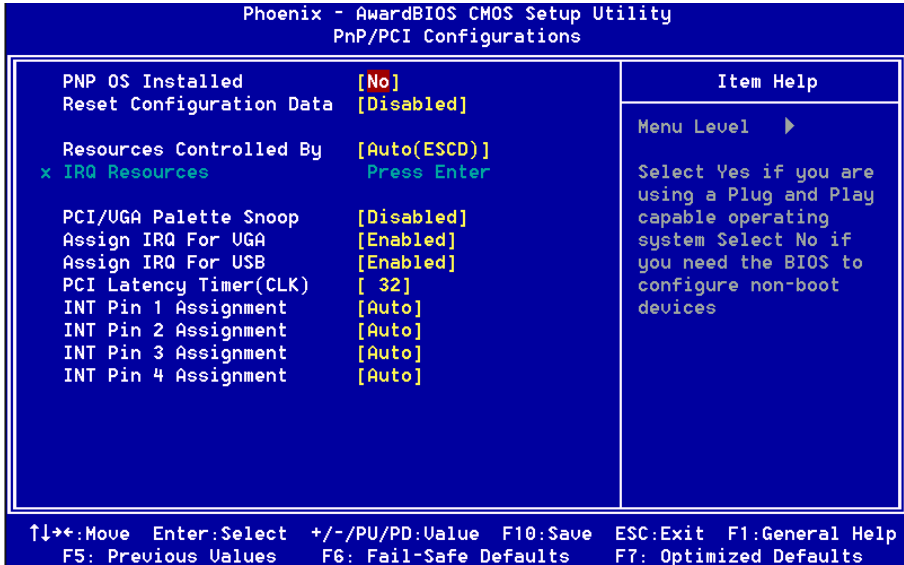

Figure 7: PNP/PCI Configuration Setup

PNP OS Installed

Do you have a PNP OS installed on your system. The default is No.

Options: Yes, No.

Reset Configuration Data

This setting allows you to clear ESCD data. The default is Disabled

Disabled:Normal Setting.

Enabled: If you have plugged in some Legacy cards to the system and they were recorded into ESCD (Extended System Configuration Data), you can set this field to Enabled in order to clear ESCD.

Resources Controlled By

Determines what controls system PNP/PCI resources. The default is Auto (ESCD).

Manual: PNP Card's resources are controlled manually. The "IRQ Resources"

field becomes available and you can set which IRQ-X and DMA-X are assigned to PCI/ISA PNP or Legacy ISA Cards.

Auto: If your ISA card and PCI cards are all PNP cards, BIOS assigns the interrupt resource automatically.

PCI/VGA Palette Snoop

This item is designed to overcome problems that can be caused by some nonstandard VGA cards. This board includes a built-in VGA system that does not require palette snooping so you must leave this item disabled.

Options: Enabled, Disabled.

Assign IRQ For VGA

This item allows BIOS to assign whether IRQ is with VGA or not. If you have not connect the VGA device. Can release the IRQ for other device. The default is Enabled.

Options: Enabled, Disabled.

Assign IRQ For USB

This item allows BIOS to assign whether IRQ is with USB or not. If you have not connect the USB device. Can release the IRQ for other device. The default is Enabled.

Options: Enabled, Disabled.

PCI Latency Timer (CLK)

The latency timer defines the minimum amount of time, in PCI clock cycles, that the bus master can retain the ownership of the bus.

Options: 0-255.

INT Pin1 to Pin4 Assignment

These settings allow the user to specify what IRQ will be assigned to PCI devices in the chosen slot. The defaults are Auto.

Options: Auto,3,4,5,7,9,10,11,12,14 & 15.

Interrupt requests are shared as shown below:

	INT A	INT B	INT C	INT D
PCI 1	V			
PCI 2		V		
PCI 3			V	
PCI 4				V
PCI 5			V	
PCI 6				V
AGP Slot	V			
AC97/MC97			V	
Onboard USB1	V			
Onboard USB2		V		
Onboard USB3			V	
USB2.0				V
Onboard LAN (Optional)	V			
Serial ATA (Optional)			V	
RAID (Optional)		V		

IMPORTANT!

If using PCI cards on shared slots, make sure that the drivers support “Shared IRQ” or that the cards don’t need IRQ assignments. Conflicts will arise between the two PCI groups that will make the system unstable or cards inoperable.

4-7 PC Health Status

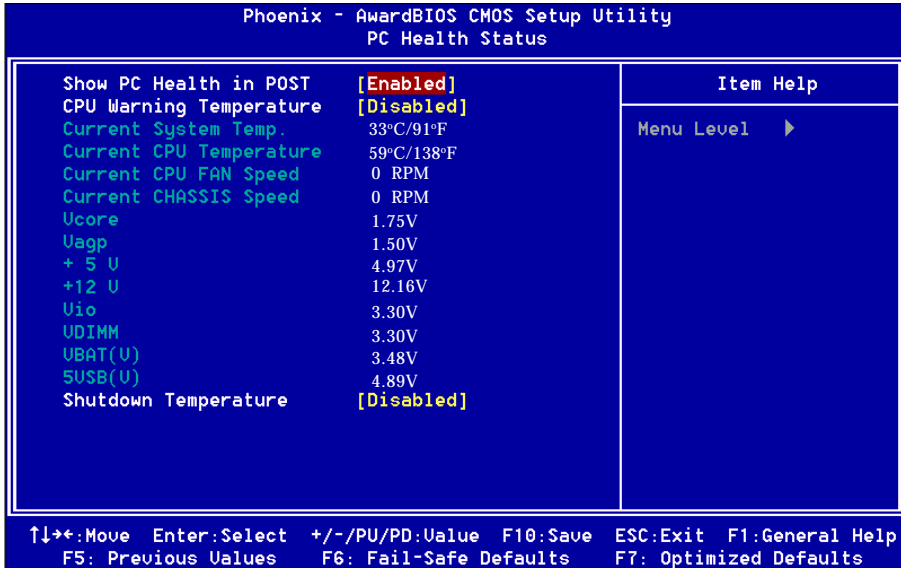

Figure 8: PC Health Status

Show PC Health in POST

When this function is enabled the PC Health information is displayed during the POST (Power On Self Test).

Options: Disabled, Enabled.

CPU Warning Temperature

Sets the temperature at which the computer will respond to an overheating CPU. The default is Disabled.

Options: Disabled, 50°C/122°F ~ 70°C/158°F.

Current System Temperature

Displays the current system temperature.

Current CPU Temperature

Displays the current CPU temperature.

Current CPU/Chassis/Power FAN Speed

Displays the current speed of the CPU, chassis, and power fan speed in RPMs.

BIOS

Vcore

The voltage level of the CPU(Vcore).

Vagp

The voltage level of Power supplied to AGP card.

VDIMM

The voltage level of the DRAM.

+ 5V, +12V, VBAT(V), 5VSB(V)

The voltage level of the switching power supply.

Shutdown Temperature

This is the temperature that the computer will turn off the power to combat the effects of an overheating system. (requires ACPI to be enabled in Power Management BIOS and ACPI compliant operating system.) The default is Disabled.

Options available are 60°C/140°F to 75°C/167°F in increments of 5°C.

4-8 Frequency/Voltage Control

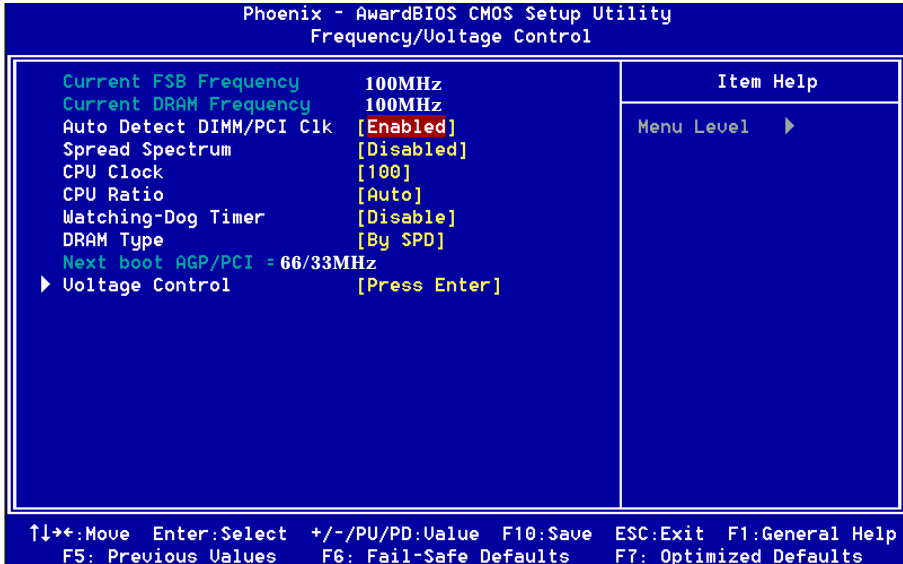

Figure 9: Frequency/Voltage Control

Current CPU Frequency

Display the current CPU clock frequency information.

Current DRAM Frequency

Display the DRAM frequency information.

Auto Detect DIMM/PCI Clk

When enabled the mainboard automatically disables the clock source for a DIMM/PCI slot which does not have a module in it, reducing EMI (ElectroMagnetic Interference). The default is Enabled.

Options: Enabled, Disabled.

Spread Spectrum

If you enable spread spectrum, it can significantly reduce the EMI (ElectroMagnetic Interference) generated by the system.

Options: Disabled, Enabled.

BIOS

CPU Clock

Enables you to set the CPU front side bus speed. The default is 100 MHz. Enables you to adjust CPU clock 1MHz by step. Pressing Enter displays the following screen:

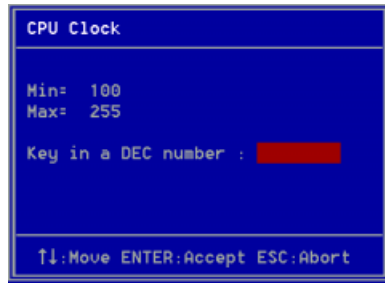

Key in the DEC (decimalism) number for the CPU clock.

Note: Overclocking failure will cause system No display problem.

At this moment, please press “*Insert*” key to back to the initial or default setting to boot up your system.

CPU Ratio

Use this item to select a multiplier for the system frontside bus (FSB) frequency. Options: Auto, x6 ~ x15.

The value of the multiplier must be set so that:

$$\text{Multiplier} \times \text{Frontside Bus Frequency} = \text{CPU Clock Speed}$$

For example, if you have a processor that is rated to run at 450 MHz and the system is running a frontside bus frequency of 100 MHz, you should select a multiplier of 4.5 so that:

$$4.5 (\text{Multiplier}) \times 100 \text{ MHz (frontside bus)} = 450 \text{ MHz (CPU clock)}$$

Watching-Dog Timer

If you select enabled and overclock fail before POST code 26h, the system will reset automatically by default configuration.

Options: Enabled, Disabled.

DRAM Type

This item allows you to select the DRAM type. The default is By SPD.

Options: By SPD, DDR200, DDR266, DDR333, DDR400.

► **Voltage Control**

Scroll to Voltage Control and press <Enter>. The following screen appears:

Phoenix - AwardBIOS CMOS Setup Utility			Item Help
Voltage Control			Menu Level ►►
Ucore	Default Voltage	1.75V	
	Current Voltage	[Default]	
	Adjust Voltage	1.75V	
DIMM	Default Voltage	2.50 U	
	Add Voltage	[+0.00 U]	
	New Voltage	2.50V	

In the following items, “Default Voltage” indicates the original factory value, and “New Voltage” indicates the value that you assign.

CPU Vcore Voltage

This item allows you to set the CPU Vcore voltage. The default is Default. Options: Default, 1.400V to +1.850V in 0.025V increments and 1.850V to +2.000V in 0.050V increments. We recommend that you leave this at the default value.

DIMM Voltage

This item allows you to set the DIMM slot voltage. The default is +0.00V. Options: +0.00V to +0.70V in 0.10V increments. We recommend that you leave this at the default value.

BIOS

4-9 Defaults Menu

Selecting “Defaults” from the main menu shows you two options which are described below

Load Fail-Safe Defaults

When you press <Enter> on this item you get a confirmation dialog box:

Load Fail-Safe Defaults (Y/N) ? N

Pressing ‘Y’ loads the BIOS default values for the most stable, minimal-performance system operations.

Load Optimized Defaults

When you press <Enter> on this item you get a confirmation dialog box:

Load Optimized Defaults (Y/N) ? N

Pressing ‘Y’ loads the default values that are factory settings for optimal performance system operations.

4-10 Supervisor/User Password Setting

You can set either supervisor or user password, or both of them. The differences between are:

supervisor password : can enter and change the options of the setup menus.

user password : just can only enter but do not have the right to change the options of the setup menus. When you select this function, the following message will appear at the center of the screen to assist you in creating a password.

ENTER PASSWORD:

Type the password, up to eight characters in length, and press <Enter>. The password typed now will clear any previously entered password from CMOS memory. You will be asked to confirm the password. Type the password again and press <Enter>. You may also press <Esc> to abort the selection and not enter a password. To disable a password, just press <Enter> when you are prompted to enter the password. A message will confirm the password will be disabled. Once the password is disabled, the system will boot and you can enter Setup freely.

PASSWORD DISABLED.

When a password has been enabled, you will be prompted to enter it every time you try to enter Setup. This prevents an unauthorized person from changing any part of your system configuration.

Additionally, when a password is enabled, you can also require the BIOS to request a password every time your system is rebooted. This would prevent unauthorized use of your computer.

You determine when the password is required within the BIOS Features Setup Menu and its Security option. If the Security option is set to “System”, the password will be required both at boot and at entry to Setup. If set to “Setup”, prompting only occurs when trying to enter Setup.

BIOS

4-11 Exiting BIOS

Save & Exit Setup

Pressing <Enter> on this item asks for confirmation:

Save to CMOS and EXIT (Y/N)? Y

Pressing “Y” stores the selections made in the menus in CMOS – a special section of memory that stays on after you turn your system off. The next time you boot your computer, the BIOS configures your system according to the Setup selections stored in CMOS. After saving the values the system is restarted again.

Exit Without Saving

Pressing <Enter> on this item asks for confirmation:

Quit without saving (Y/N)? Y

This allows you to exit Setup without storing in CMOS any change. The previous selections remain in effect. This exits the Setup utility and restarts your computer.

Easy Driver Installation

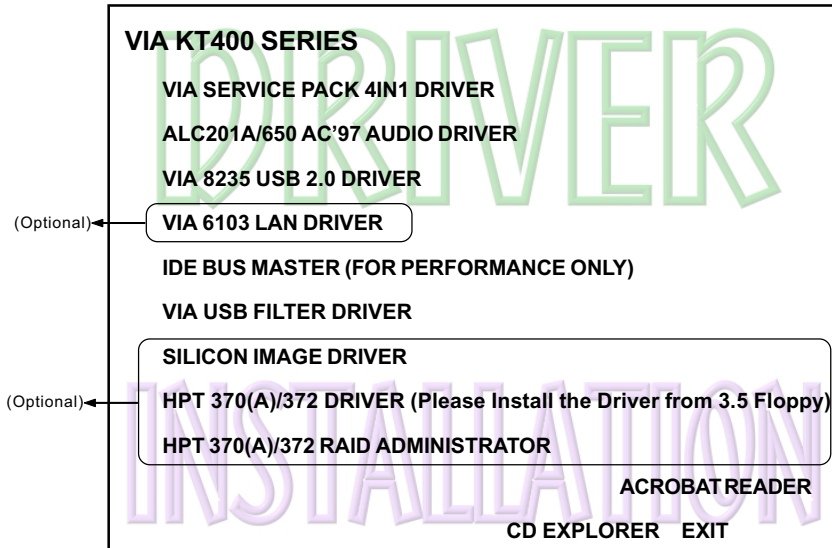

Insert the bundled CD-disk.

- Step 1 :** Click “**VIA SERVICE PACK 4IN1 DRIVER**”. Install all components recommended.
 - Step 2 :** Click “**ALC201A/650 AC'97 AUDIO DRIVER**” to install Audio driver.
 - Step 3 :** Click “**VIA 8235 USB 2.0 DRIVER**” to install USB Driver.
 - Step 4 :** Click “**VIA 6103 LAN DRIVER**” to install LAN driver. (Optional)
 - Step 5 :** Click “**VIA IDE BUS MASTER**” to install BusMaster PCI IDE driver. (For performance only).
 - Step 6 :** Click “**VIA USB FILTER DRIVER**” to install USB filter driver for Windows 98/2000. (Please refer to README.TXT file).
 - Step 7 :** Click “**SILICON IMAGE DRIVER**” to install serial ATA driver. (Optional)
- Note:** If your board equipped with a HPT370(A)/372 device, please install the driver from 3.5 floppy. (Optional)
- The “**HPT 370(A)/372 RAID ADMINISTRATOR**” item is for install Raid Administrator. (Optional)

Drivers Installation

ALC650 Configuration Setup (6 Channel)

- ◆ To enable ALC650 Function

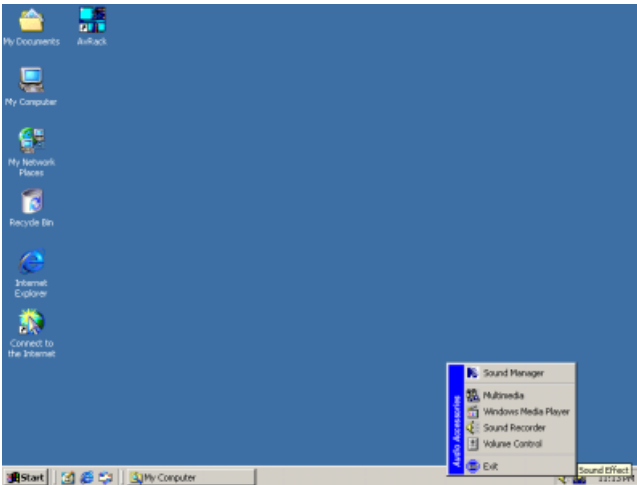

<Figure 1>

1. Right-click **Sound Effect** button in the tool bar display currently selected Titles. Select **Sound Manager**.

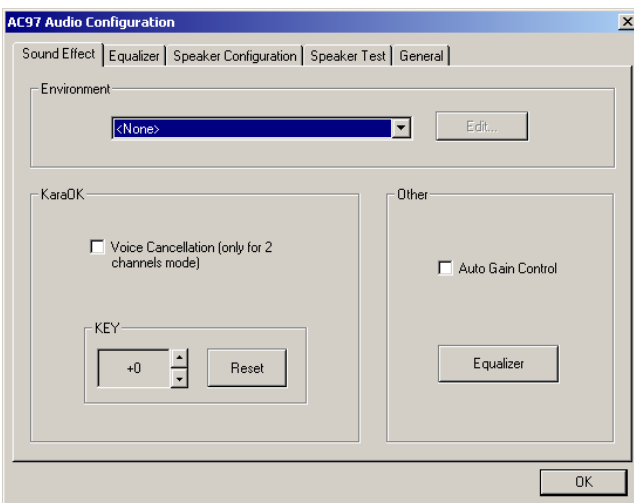

Sound Effect:

<Figure 2>

2. Click **Sound Effect** button and select **Environment** from the drop-down menu.

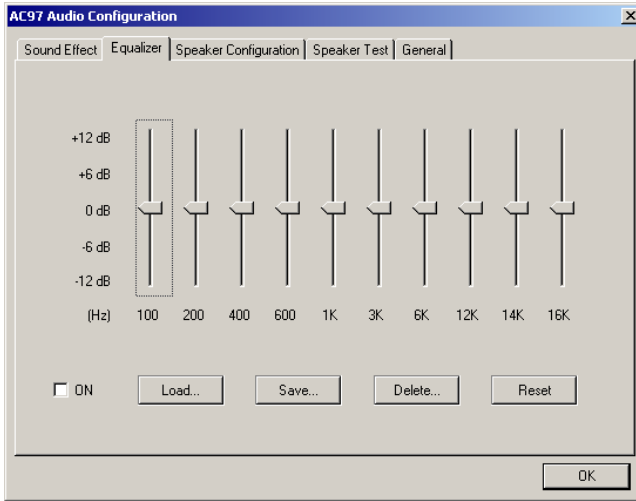

Equalizer:

<Figure 3>

3. Click **Equalizer** and setup the value of dB.

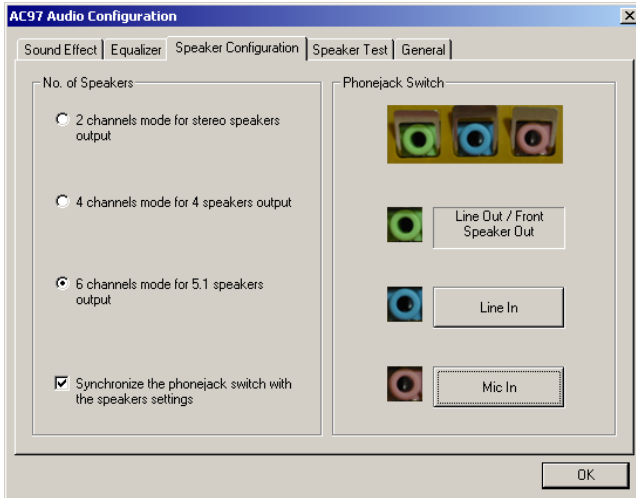

Speak Configuration:

<Figure 4>

4. Click **Line in** and **Mic in** buttons to enable 6 channel function as this is required for the ALC650.

Drivers Installation

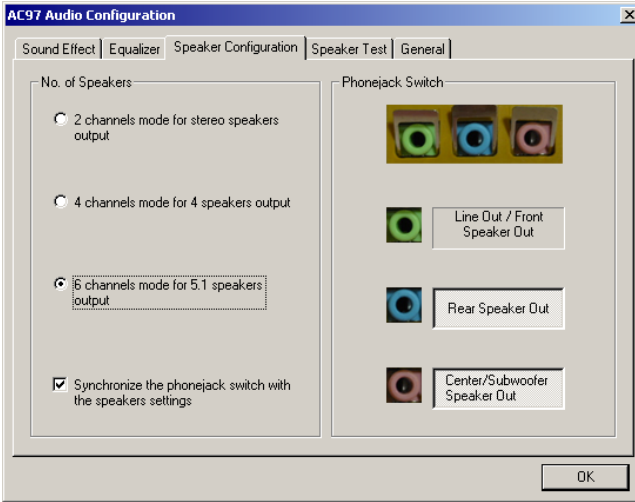

**Speak
Configutation:**

<Figure 5>

5. The selected screen appears.

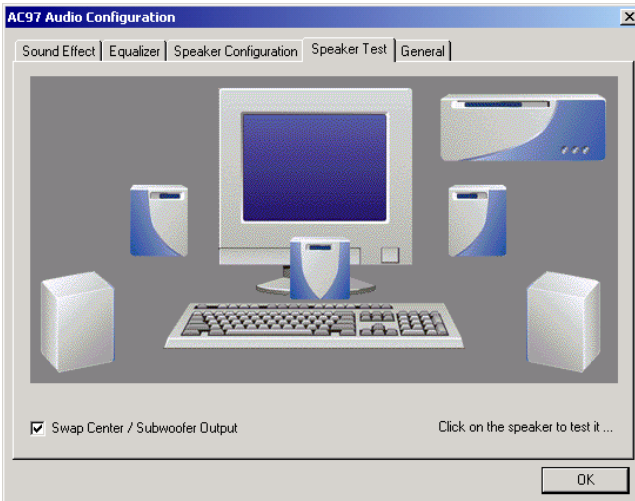

Speaker Test:

<Figure 6>

6. Click **Speaker Test** button and click on the speakers directly which show on the screen to test it.

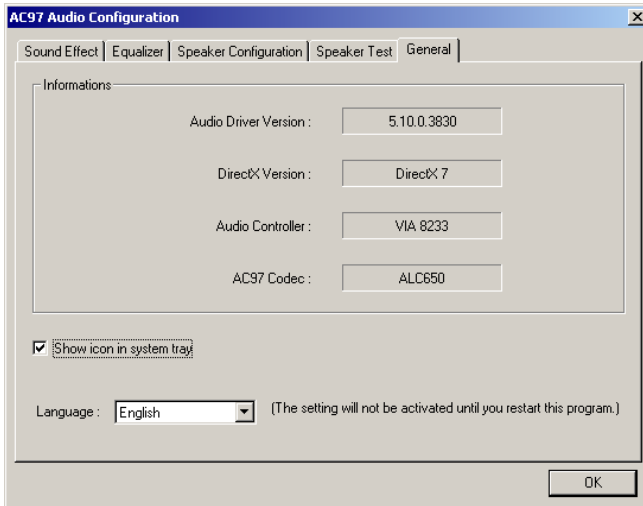

General:

<Figure 7>

7. General Information for user reference.

A-1 Avance® Media Player User's Guide

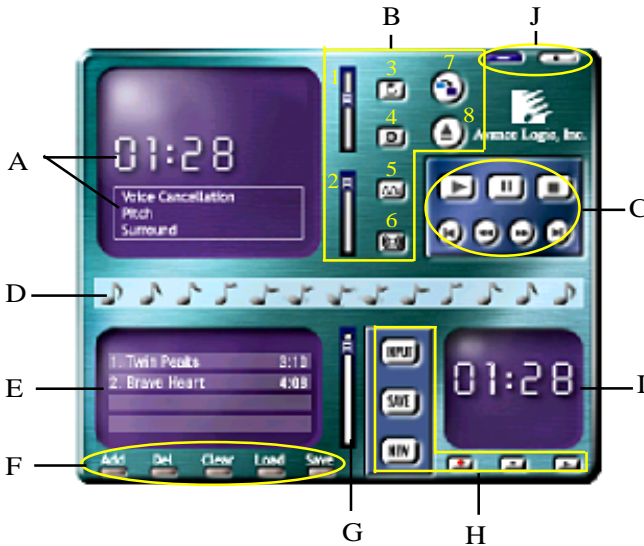
Avance® Media Player Platform**Functional Descriptions****A. Playback Windows Display**

Playback windows displays the following mode information:

1. Playback Time Display
2. Voice Cancellation Mode Display
3. Pitch Mode Display
4. Surround Sound Mode Display

B. Playback Function Controls

There are 8 selectable functions for the playback:

1. Volume control High/Low Adjustment Bar.
2. Pitch control 4-step High/Low Adjustment Bar.

Appendix

- 3. Repeat mode Choice of Repeat, All Repeat, Random or No Repeat Mode.
- 4. Mute Mute On/Off Mode select.
- 5. Voice cancellation Voice Cancellation On/Off Mode select for Karaoke.
- 6. Surround mode A total of 26 Surround Sound mode select as shown in the table below.

Surround mode	Surround mode
Generic	Stone corridor
Padded	Alley
Room	Forrest
Bathroom	City
Living room	Mountain
Stone	Quarry
Auditorium	Plain
Concert	Parking lot
Cave	Sewer pipe
Arena	Under water
Hangar	Drug
Carpet	Dizzy
Hallway	Psychological

- 7. Skin change Media Player Skin Type select.
- 8. Open Open file formats including MP3, CDA, MDI, WAV & WMA support.

C. Playback Controls

The playback controls include “Play”, “Pause”, “Stop”, “Previous”, “Backward”, “Forward”, & “Next”.

D. Seeking bar

Display Animated Playback Status

E. Title/Play List Windows

Display Currently Selected Title(s)

B-1 Update Your System BIOS

Download the xxxxx.EXE file corresponding to your model from our website to an empty directory on your hard disk or floppy. Run the downloaded xxxxx.EXE file and it will self extract. Copy these extracted files to a bootable DOS floppy disk.

Note: The DOS floppy disk should contain NO device drivers or other programs.

1. Type "A:\AWDFLASH and press <Enter> Key.
2. You will see the following setup on screen.
3. Please key in the xxxxx.bin BIOS file name.

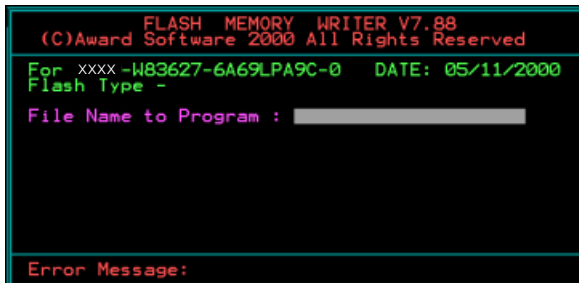

```
FLASH MEMORY WRITER V7.88
(C)Award Software 2000 All Rights Reserved

For xxxxx-W83627-6A69LPA9C-0  DATE: 05/11/2000
Flash Type -
File Name to Program : _____

Error Message:
```

4. If you want to save the previous BIOS data to the diskette, please key in [Y], otherwise please key in [N].

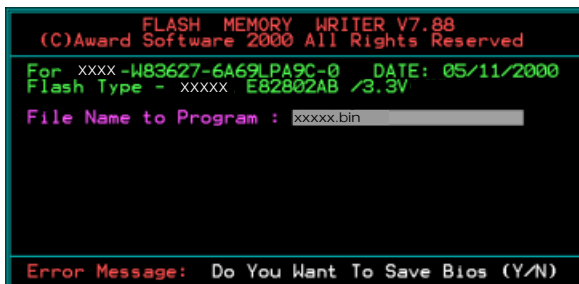

```
FLASH MEMORY WRITER V7.88
(C)Award Software 2000 All Rights Reserved

For xxxxx-W83627-6A69LPA9C-0  DATE: 05/11/2000
Flash Type - xxxxxx E82802AB /3.3V
File Name to Program : xxxxx.bin

Error Message: Do You Want To Save Bios (Y/N)
```

Appendix

5. Key in File Name to save previous BIOS to file.

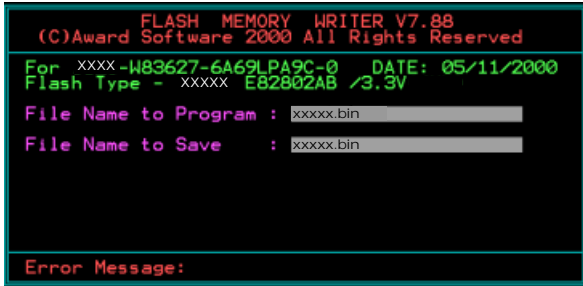

6. Are you sure to program (y/n), please key in [Y] to start the programming.

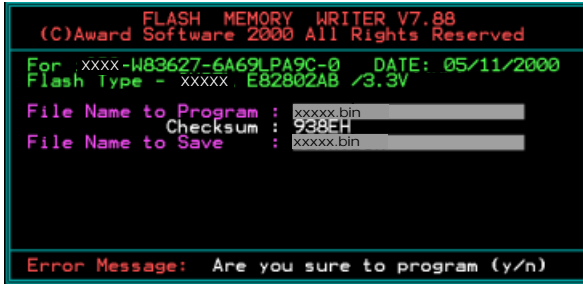

7. The programming is finished.

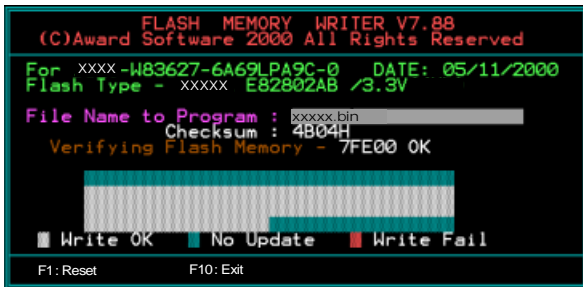

C-1 EEPROM BIOS Remover

Do not remove the BIOS chip, unless instructed by a technician and only with a PLCC IC extractor tool.

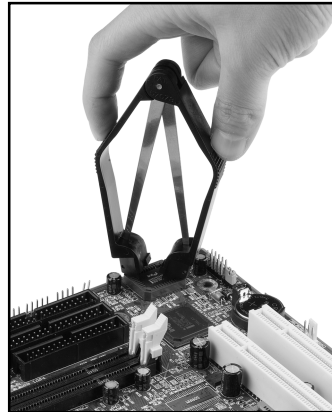
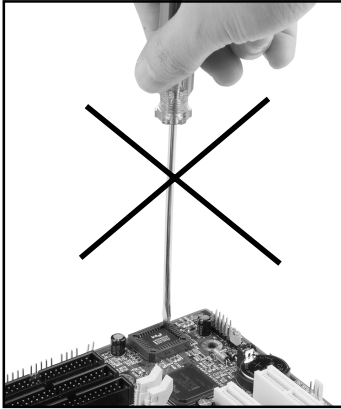

The BIOS socket may be damaged if using an improper method to replace the BIOS chip.

D-1 GHOST 7 Quick User's Guide (Optional)

Installation is very easy. You only need to copy the **Ghost7** folder or **Ghost.exe** to your hard disk.

Main Menu

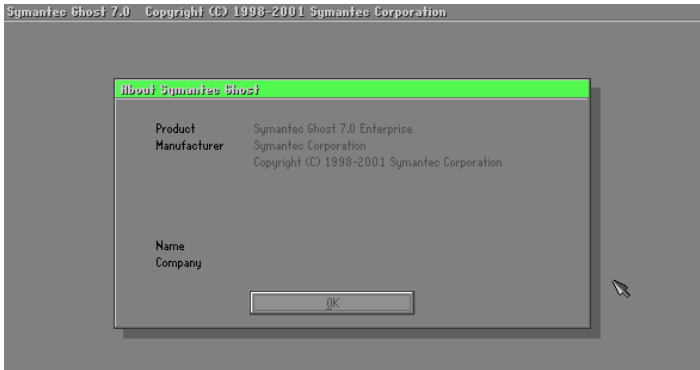

Description of Menu

Ghost clones and backs up **Disk** and **Partition**.

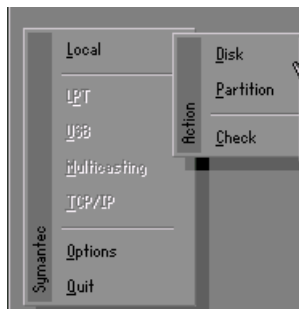

In which **Disk** indicates hard disk options
Partition indicates partition options
Check indicates check options

Appendix

Disk

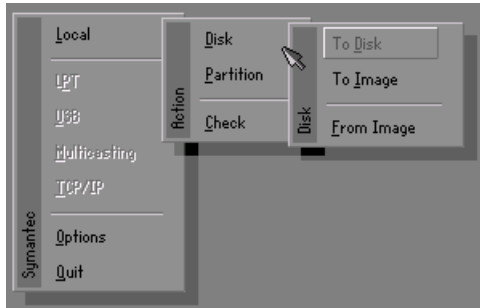

There are 3 hard disk functions:

1. Disk To Disk (disk cloning)
2. Disk To Image (disk backup)
3. Disk From Image (restore backup)

Important!

1. To use this function, the system must have at least 2 disks. Press the **Tab** key to move the cursor.
2. When restoring to a destination disk, all data in that disk will be completely destroyed.

Disk To Disk (Disk Cloning)

1. Select the location of the **Source drive**.
2. Select the location of the **Destination drive**.

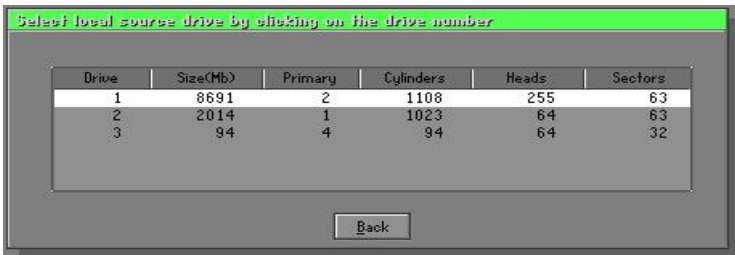

- When cloning a disk or restoring the backup, set the required partition size as shown in the following figure.



- Click OK to display the following confirmation screen. Select **Yes** to start.

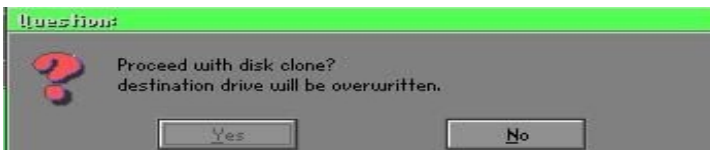

Disk To Image (Disk Backup)

- Select the location of the Source drive.

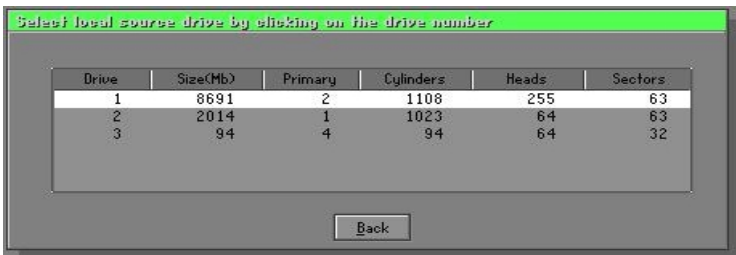

Appendix

2. Select the location for storing the backup file.

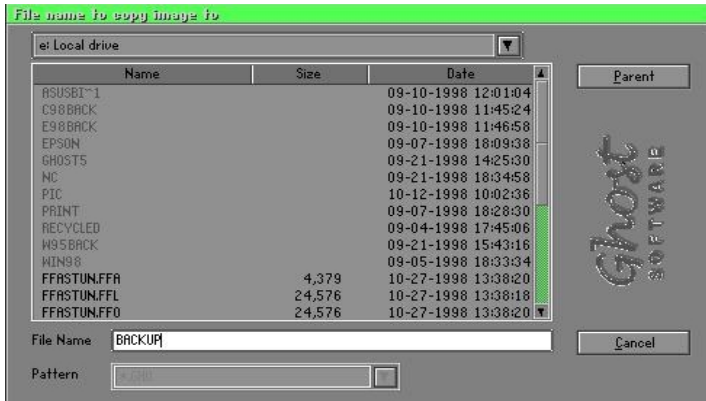

3. Click **OK** to display the following confirmation screen. Select **Yes** to start.

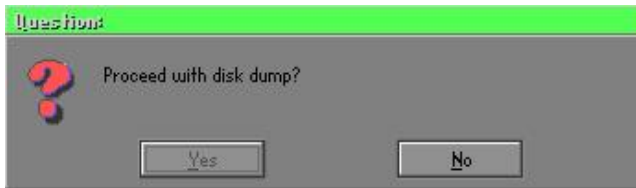

Disk From Image (Restore Backup)

1. Select the Restoring file.

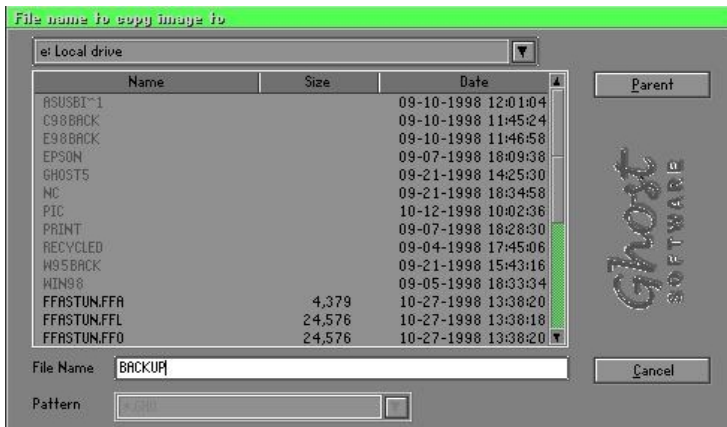

2. Select the **Destination drive** of the disk to be restored.

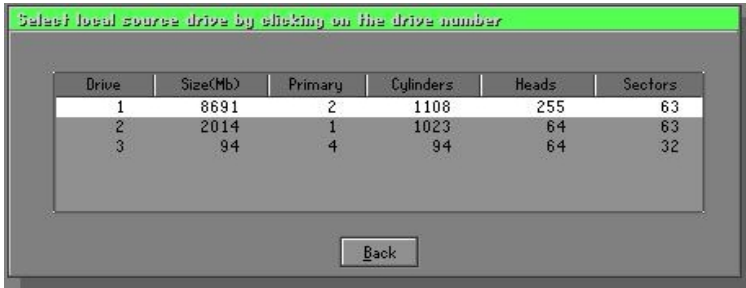

3. When restoring disk backup, set the required partition size as shown in the following figure.

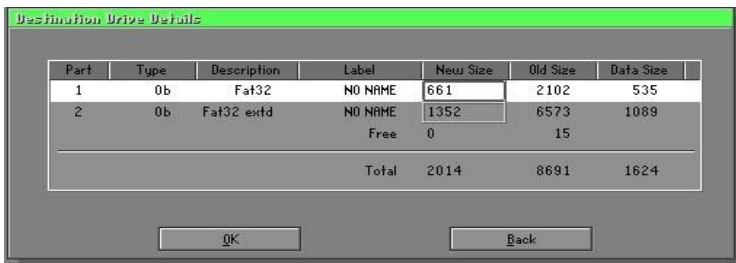

4. Click **OK** to display the following confirmation screen. Select **Yes** to start.

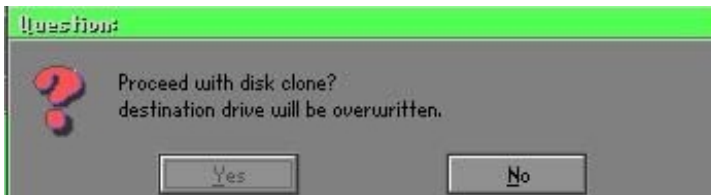

Partition

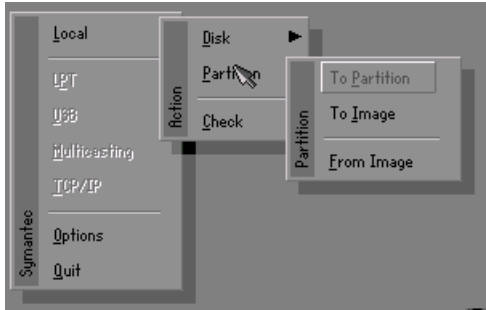

There are 3 partition functions:

1. **Partition To Partition** (partition cloning)
2. **Partition To Image** (partition backup)
3. **Partition From Image** (restore partition)

Partition To Partition (Partition Cloning)

The basic unit for partition cloning is a “partition”. Refer to “disk cloning” for the operating method.

Partition To Image (Partition Backup)

1. Select the disk to be backed up.

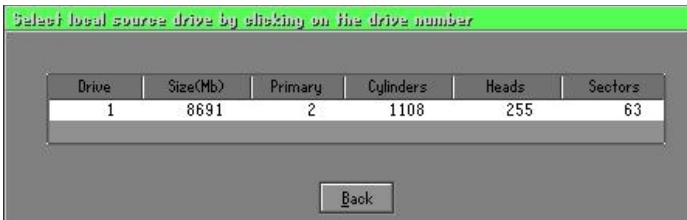

2. Select the first partition to be backed up. This is usually where the operating system and programs are stored.



3. Select the path and file name to store the backup file.

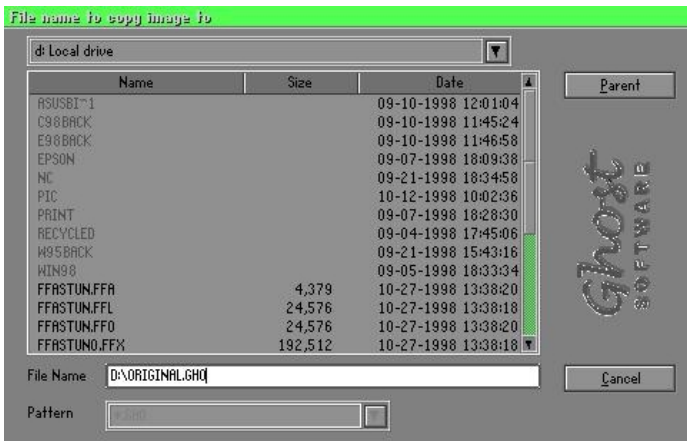

4. Is the file compressed? There are 3 options:
 - (1) No: do not compress data during backup
 - (2) Fast: Small volume compression
 - (3) High: high ratio compression. File can be compressed to its minimum, but requiring longer execution time.

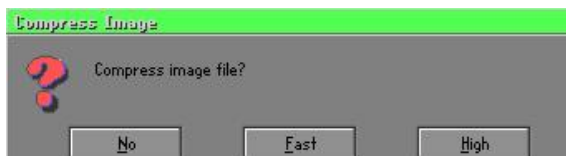

Appendix

5. Select Yes to start performing backup.



Partition From Image (Restore Partition)

1. Select the backup file to be restored.

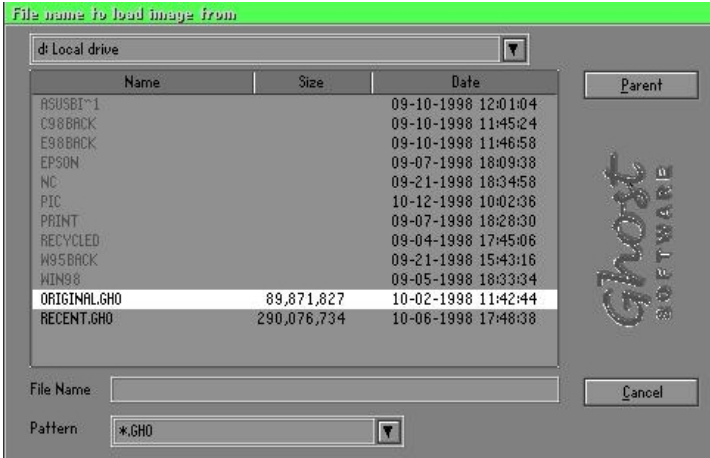

2. Select the source partition.



3. Select the disk to be restored.



4. Select the partition to be restored.



5. Select Yes to start restoring.

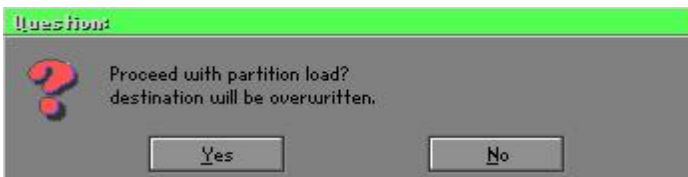

Check

This function is to check possible error caused by defective FAT or track during backup or restoring.

How to Reinstall Windows in 2 Minutes

This chapter guides you how to setup your computer properly and, if necessary, reinstall Windows in 2 minutes. Ghost provides different methods to complete this task. The following two sections explain how to create an emergency Recover Floppy and Recover CD:

Emergency Recover Floppy

Divide a hard disk into two partitions. The first partition is to store the operating system and application programs. The second partition is to back up the operating system and data. The size of the partition can be determined according to the backup requirements. For example, the **Windows** operating system needs 200MB of hard disk space, Plus complete **Office** programs require 360MB. The remaining space can be used to store data.

After installing **Windows**, use **Ghost** to create a backup area for the system and to store the file (Image file) in drive D. The file is named **Original.gho**. Then, create a recover floppy disk containing:

- ◆ Bootable files (Command.com, Io.sys, and MSDOS.SYS)
- ◆ Config.sys (configuration setup file)
- ◆ Autoexec.bat (auto-execution batch file)
- ◆ Ghost.exe (Ghost execution file)

There are two ways to create the content of the recover floppy for restoring:

- (1) To load **Windows** automatically after booting, store the **Autoexec.bat** file with a command line:

```
Ghost.exe clone, mode=pload, src=d:\original.gho:2,dst=1:1 -fx -sure -rb
```

Command Description: Runs the restore function automatically with the Image File. Stored in drive D. After execution, it will exit Ghost and boots the system.

Refer to the [Introducing Ghosts Functions] for details.

- (2) After booting, the screen displays the Menu. Select Backup or Restore: Since the user may install other applications in the future, he/she may alter **Autoexec.bat** file to back up or restore the user-defined Image file as follows:

Backup

Back up Windows and application programs as a file (Recent.gho). Command is:

```
Ghost -clone,mode=pdump,src=1:1,dst=d:\Recent.gho -fx -sure -rb
```

Restore

Restore types include [**General Windows**] and [**Windows and Application Programs**]. If you select [**General Windows**], the system is restored to the general **Windows** operation condition. The command is:

```
Ghost.exe -clone,mode=pload,src=d:\Original.gho,dst=1:1 -fx -sure -rb
```

If you select [**Windows and Application Programs**], the latest backup file (Recent.gho) is restored, skipping the installation and setup of application programs.

For description of related parameters, refer to [**Introducing Ghosts Functions**].

For more information about menu design, refer to Config.sys and Autoexec.bat under /Menu in the CD. You can also create a backup CD containing Ghost.exe and these two files.

Recover CD

The following is a simple guide to create a recover CD:

1. First, create a recover floppy disk contains the following with any copy program such as “Easy CD Create” (Note 2) :

Bootable files (Command.com and Io.sys and MSDOS.SYS)

Config.sys (Configuration setup file)

Autoexec.bat (Auto-execution batch file)

Mscdex.exe (CD-Rom execution file)

Ghost.exe (Ghost execution file)

Oakcdrom.sys (ATAPI CD-ROM compatible driver)

The content of Config.sys is:

```
DEVICE=Oakcdrom.sys /d:idecd001
```

The content of Autoexec.bat includes:

```
MSCDEX.EXE /D:IDECD001 /L:Z
```

```
Ghost.exe clone,mode=load,src=z:\original.gho,dst=1 -sure -rb
```

2. Write the backup image file (original.gho) of the entire hard disk or partition into the recover CD. Use the Recover CD to boot up the system and restore the backup files automatically.

For description of related parameters, refer to **[Introducing Ghosts Functions]**.

Note: For more details about copy the creation program and method to create a recover CD, please refer to the related software and its associated operating manual.

Note: Ghost may be executed in interactive or in batch mode. Most of the Ghost switches are used to assist in batch mode operation. To list switches, type ghost.exe -h.

E-1 POST CODES (Optional)

<u>POST (hex)</u>	<u>DESCRIPTION</u>
CfH	Test CMOS R/W functionality.
C0h	Early chipset initialization: <ul style="list-style-type: none">- Disable shadow RAM- Disable L2 cache (socket 7 or below)- Program basic chipset registers
C1h	Detect memory <ul style="list-style-type: none">- Auto-detection of DRAM size, type and ECC.- Auto-detection of L2 cache (socket 7 or below)
C3h	Expand compressed BIOS code to DRAM
C5h	Call chipset hook to copy BIOS back to E000 & F000 shadow RAM.
0h1	Expand the Xgroup codes locating in physical address 1000:0
02h	Reserved
03h	Initial Superio_Early_Init switch.
04h	Reserved
05h	<ol style="list-style-type: none">1. Blank out screen2. Clear CMOS error flag
06h	Reserved
07h	<ol style="list-style-type: none">1. Clear 8042 interface2. Initialize 8042 self-test
08h	<ol style="list-style-type: none">1. Test special keyboard controller for Winbond 977 series Super I/O chips.2. Enable keyboard interface.
09h	Reserved
0Ah	<ol style="list-style-type: none">1. Disable PS/2 mouse interface (optional).2. Auto detect ports for keyboard & mouse followed by a port & interface swap (optional).3. Reset keyboard for Winbond 977 series Super I/O chips.
0B-0Dh	Reserved

Appendix

0Eh	Test F000h segment shadow to see whether it is R/W-able or not. If test fails, keep beeping the speaker.
0Fh	Reserved
10h	Auto detect flash type to load appropriate flash R/W codes into the run time area in F000 for ESCD & DMI support.
11h	Reserved
12h	Use walking 1's algorithm to check out interface in CMOS circuitry. Also set real-time clock power status, and then check for override.
13h	Reserved
14h	Program chipset default values into chipset. Chipset default values are MODBINable by OEM customers.
15h	Reserved
16h	Initial Early_Init_Onboard_Generator switch.
17h	Reserved
18h	Detect CPU information including brand, SMI type (Cyrix or Intel) and CPU level (586 or 686).
19-1Ah	Reserved
1Bh	Initial interrupts vector table. If no special specified, all H/W interrupts are directed to SPURIOUS_INT_HDLR & S/W interrupts to SPURIOUS_soft_HDLR.
1Ch	Reserved
1Dh	Initial EARLY_PM_INIT switch.
1Eh	Reserved
1Fh	Load keyboard matrix (notebook platform)
20h	Reserved
21h	HPM initialization (notebook platform)
22h	Reserved
23h	<ol style="list-style-type: none">1. Check validity of RTC value: e.g. a value of 5Ah is an invalid value for RTC minute.2. Load CMOS settings into BIOS stack. If CMOS checksum fails, use default value instead.3. Prepare BIOS resource map for PCI & PnP use. If ESCD is valid, take into consideration of the ESCD's legacy information.

	<ol style="list-style-type: none">Onboard clock generator initialization. Disable respective clock resource to empty PCI & DIMM slots.Early PCI initialization:<ul style="list-style-type: none">-Enumerate PCI bus number-Assign memory & I/O resource-Search for a valid VGA device & VGA BIOS, and put it into C000:0.
24-26h	Reserved
27h	Initialize INT 09 buffer
28h	Reserved
29h	<ol style="list-style-type: none">Program CPU internal MTRR (P6 & PII) for 0-640K memory address.Initialize the APIC for Pentium class CPU.Program early chipset according to CMOS setup. Example: onboard IDE controller.Measure CPU speed.Invoke video BIOS.
2A-2Ch	Reserved
2Dh	<ol style="list-style-type: none">Initialize multi-languagePut information on screen display, including Award title, CPU type, CPU speed
2E-32h	Reserved
33h	Reset keyboard except Winbond 977 series Super I/O chips.
34-3Bh	Reserved
3Ch	Test 8254
3Dh	Reserved
3Eh	Test 8259 interrupt mask bits for channel 1.
3Fh	Reserved
40h	Test 8259 interrupt mask bits for channel 2.
41h	Reserved
42h	Reserved
43h	Test 8259 functionality.
44h	Reserved
45-46h	Reserved
47h	Initialize EISA slot

Appendix

48h	Reserved
49h	<ol style="list-style-type: none">1. Calculate total memory by testing the last double word of each 64K page.2. Program writes allocation for AMD K5 CPU.
4A-4Dh	Reserved
4Eh	<ol style="list-style-type: none">1. Program MTRR of M1 CPU2. Initialize L2 cache for P6 class CPU & program CPU with proper cacheable range.3. Initialize the APIC for P6 class CPU.4. On MP platform, adjust the cacheable range to smaller one in case the cacheable ranges between each CPU are not identical.
4Fh	Reserved
50h	Initialize USB
51h	Reserved
52h	Test all memory (clear all extended memory to 0)
53-54h	Reserved
55h	Display number of processors (multi-processor platform)
56h	Reserved
57h	<ol style="list-style-type: none">1. Display PnP logo2. Early ISA PnP initialization -Assign CSN to every ISA PnP device.
58h	Reserved
59h	Initialize the combined Trend Anti-Virus code.
5Ah	Reserved
5Bh	(Optional Feature) Show message for entering AWDFLASH. EXE from FDD (optional)
5Ch	Reserved
5Dh	<ol style="list-style-type: none">1. Initialize Init_Onboard_Super_IO switch.2. Initialize Init_Onboard_AUDIO switch.
5E-5Fh	Reserved
60h	Okay to enter Setup utility; i.e. not until this POST stage can users enter the CMOS setup utility.
61-64h	Reserved
65h	Initialize PS/2 Mouse

66h	Reserved
67h	Prepare memory size information for function call: INT 15h ax=E820h
68h	Reserved
69h	Turn on L2 cache
6Ah	Reserved
6Bh	Program chipset registers according to items described in Setup & Auto-configuration table.
6Ch	Reserved
6Dh	<ol style="list-style-type: none">1. Assign resources to all ISA PnP devices.2. Auto assign ports to onboard COM ports if the corresponding item in Setup is set to "AUTO".
6Eh	Reserved
6Fh	<ol style="list-style-type: none">1. Initialize floppy controller2. Set up floppy related fields in 40:hardware.
70-72h	Reserved
73h	(Optional Feature) Enter AWDFLASH.EXE if : -AWDFLASH is found in floppy drive. -ALT+F2 is pressed
74h	Reserved
75h	Detect & install all IDE devices: HDD, LS120, ZIP, CDROM.....
76h	Reserved
77h	Detect serial ports & parallel ports.
78h	Reserved
79h	Reserved
7Ah	Detect & install co-processor
7B-7Eh	Reserved
7Fh	<ol style="list-style-type: none">1. Switch back to text mode if full screen logo is supported. -If errors occur, report errors & wait for keys -If no errors occur or F1 key is pressed to continue:<ul style="list-style-type: none">◆ Clear EPA or customization logo.
80h	Reserved
81h	Reserved
82h	<ol style="list-style-type: none">1. Call chipset power management hook.2. Recover the text fond used by EPA logo (not for full

Appendix

	screen logo)
	3. If password is set, ask for password.
83h	Save all data in stack back to CMOS
84h	Initialize ISA PnP boot devices
85h	<ol style="list-style-type: none">1. USB final Initialization2. NET PC: Build SYSID structure3. Switch screen back to text mode4. Set up ACPI table at top of memory.5. Invoke ISA adapter ROMs6. Assign IRQs to PCI devices7. Initialize APM8. Clear noise of IRQs.
86-92h	Reserved
93h	Read HDD boot sector information for Trend Anti-Virus code
94h	<ol style="list-style-type: none">1. Enable L2 cache2. Program boot up speed3. Chipset final initialization.4. Power management final initialization5. Clear screen & display summary table6. Program K6 write allocation7. Program P6 class write combining
95h	<ol style="list-style-type: none">1. Program daylight saving2. Update keyboard LED & typematic rate
96h	<ol style="list-style-type: none">1. Build MP table2. Build & update ESCD3. Set CMOS century to 20h or 19h4. Load CMOS time into DOS timer tick5. Build MSIRQ routing table.
FFh	Boot attempt (INT 19h)