



User's Manual

An AMD Socket A Processor based
mainboard (100/133MHz)

Supports PC1600/PC2100/PC2700 Memory
Modules (DDR Memory)

TRADEMARK

All products and company names are trademarks or registered
trademarks of their respective holders.

These specifications are subject to change without notice.

*Manual Revision 1.0
July 05, 2002*

POST Port Frequently Asked Questions

Below is a list of some basic POST Codes, possible problems, and solutions. For more detailed information about POST Codes, refer to Appendix E in this manual.

POST CODE	Problem	Solution
FFh or CFh	<ol style="list-style-type: none">1. BIOS chip inserted incorrectly2. Incorrect BIOS update version3. Mainboard problem4. Add-on card inserted incorrectly.	<ol style="list-style-type: none">1. Reinsert the BIOS chip2. Download the correct BIOS version update from the manufacturer's Web site.3. Replace mainboard4. Remove and replace the add-on card
C1h - C5h	<ol style="list-style-type: none">1. Memory module inserted incorrectly2. Memory compatibility problem3. Memory module damaged	<ol style="list-style-type: none">1. Reinsert memory module2. Replace memory with correct type3. Replace memory module
2Dh	<ol style="list-style-type: none">1. Error occurred in VGA BIOS2. VGA card inserted incorrectly	<ol style="list-style-type: none">1. Replace VGA card2. Reinsert the VGA card
26h	Overclock error	Clear CMOS or press the insert key to power on the system
07h - 12h	<ol style="list-style-type: none">1. Init keyboard controller error2. RTC error	<ol style="list-style-type: none">1. Ensure that the keyboard and mouse are connected correctly.2. Replace the RTC battery.

Table of Contents

		<i>Page</i>
<i>Section 1</i>	<i>Introduction</i>	
	Components Checklist	1-1
	<i>Overview</i>	
	AMD Duron™ & Athlon™ Processors	1-2
	Accelerated Graphics Port	1-3
	Ultra ATA66/100/133	1-3
	Hardware Monitoring	1-3
	Mainboard Form-Factor	1-4
	I/O Shield Connector	1-5
	Power-On/Off (Remote)	1-5
	System Block Diagram	1-6
<i>Section 2</i>	<i>Features</i>	
	Mainboard Features	2-1
<i>Section 3</i>	<i>Installation</i>	
	Mainboard Detailed Layout	3-2
	<i>Easy Installation Procedure</i>	
	CPU Insertion	3-3
	Jumper Settings	3-5
	System Memory Configuration	3-6
	Device Connectors	3-8
	STR (Suspend To RAM) Function	3-13
	CPU Overheating Protection	3-15
<i>Section 4</i>	<i>Award BIOS Setup</i>	
	BIOS Instructions	4-1
	Standard CMOS Setup	4-2
	Advanced BIOS Features	4-3

Advanced Chipset Features	4-8
Integrated Peripherals	4-13
Power Management Setup	4-18
PNP/PCI Configuration Setup	4-22
PC Health Status	4-24
Frequency/Voltage Control	4-26
Defaults Menu	4-28
Supervisor/User Password Setting	4-29
Exit Selecting	4-30

Section 5

Driver Installation

Easy Driver Installation	5-1
ALC650 Configuration Setup	5-2

Appendix

Appendix A

Avance Media Player User's Guide	A-1
--	-----

Appendix B

Update Your System BIOS	B-1
-------------------------------	-----

Appendix C

EEPROM BIOS Remover	C-1
---------------------------	-----

Appendix D

GHOST 7 Quick User's Guide (Optional)	D-1
---	-----

Appendix E

POST Codes	E-1
------------------	-----

Section 1
INTRODUCTION

Components Checklist

Package Contents

- A. (1) Mainboard
- B. (1) User's manual
- C. (1) Floppy ribbon cable
- D. (1) ATA-66/100 Hard drive ribbon cable
- E. (1) Driver and utility

Optional Item

- F. (1) USB2.0 Cable
- G. (1) Game port cable
- H. (1) I/O Shield

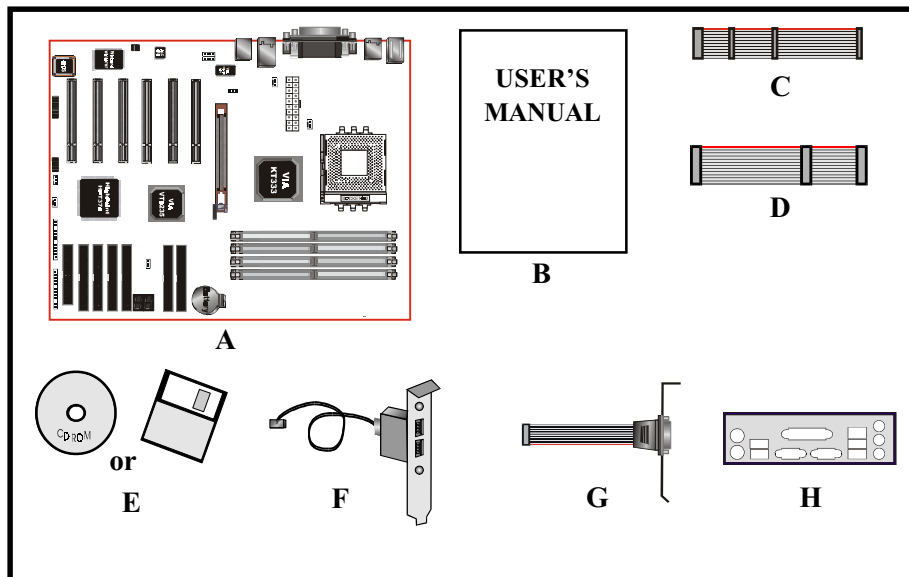

AMD Duron™ & Athlon™ Processors

The AMD Athlon™ is a seventh-generation micro architecture with an integrated L2 cache, which is powerful enough to support the bandwidth requirements of a large range of applications, hardware, graphics, and memory technologies. These processors implement advanced design techniques such as:

- ◆ Socket A (PGA 462)
- ◆ 200/266MHz system interface based on the Alpha™ EV6 bus protocol.
- ◆ Three out-of-order, superscalar, pipelined Multimedia Units.
- ◆ Three out-of-order, superscalar, pipelined Integer Units.
- ◆ Fixed-sized internal instruction formats (MacroOPs).
- ◆ 72-entry Instruction Control Units.
- ◆ AMD enhanced 3DNow!™ technology
- ◆ L1 and L2 caches.
- ◆ Dynamic branch prediction.

Socket A is the name for AMD's new socketed interface designed to support both AMD Duron™ and AMD Athlon™ processors. This innovation is made possible by integrating the L2 cache memory on chip with the processor. Socket A will help enable smaller enclosures, and ultimately result in a wider variety of solutions in the market.

The AMD Duron™ & Athlon™ processors in the Socket A format continue to deliver the ultimate performance for cutting-edge applications. Both bring to desktop systems running industry-standard x86 software superscalar RISC performance. Being provided in the Socket A format they are the world's most powerful x86 processors. They easily deliver the highest integer, floating-point, and 3D multimedia performance for applications running on x86 platforms around.

The AMD Duron™ processor is derived from the AMD Athlon™ processor core. It features full-speed, on-chip cache memory, a 200/266MHz front side system bus, and enhanced 3DNow!™ technology. Although both processors are related, there are key differences. The AMD Athlon™ processor is targeted at the performance segment, and as such will have more cache memory and higher clock speeds.

Accelerated Graphics Port (AGP or A.G.P.)

Typically, 3D graphics rendering requires a tremendous amount of memory, and demands ever increasing throughput speed as well. As 3D products for the personal computer become more and more popular, these demands will only increase. This will cause a rise in costs for both end users and manufacturers. Lowering these costs as well as improving performance is the primary motivation behind AGP. By providing a massive increase in the bandwidth available between the video card and the processor, it will assist in relieving some of these pressures for quite sometime.

Ultra ATA/66/100/133

The board provides Ultra ATA/66/100/133 Bus Master IDE controller, that support Ultra ATA/66/100/133 protocols, perfect for such demanding applications as real-time video, multimedia, and high performance operating system. A new IDE cable is required for Ultra ATA/66/100/133. This cable is an 80 conductor cable; however the connectors are, of course, backwards compatible with ATA/33.

Hardware Monitoring

Hardware monitoring allows you to monitor various aspects of your systems operations and status. The features include CPU temperature, voltage and RPM of fan.

Introduction

Mainboard Form-Factor

The board is designed with ATX form factor - the new industry standard of chassis. ATX form factor is essentially a Baby-AT baseboard rotated 90 degrees within the chassis enclosure and a new mounting configuration for the power supply. With these changes the processor is relocated away from the expansion slots, allowing them all to hold full length add-in cards. ATX defines a double height aperture to the rear of the chassis which can be used to host a wide range of onboard I/O. Only the size and position of this aperture is defined, allowing PC manufacturers to add new I/O features (e.g.; TV input, TV output, joystick, modem, LAN, etc.) to systems. This will help systems integrators differentiate their products in the marketplace, and better meet your needs.

- Smaller size promotes a smaller system size.
- I/O shield does not need to be retooled in an ATX 2.01 or later. The mainboard should be used in an ATX 2.01 (or later) compliant case.
- A smaller power supply can be used. High integration on mainboard reduces the system cost.

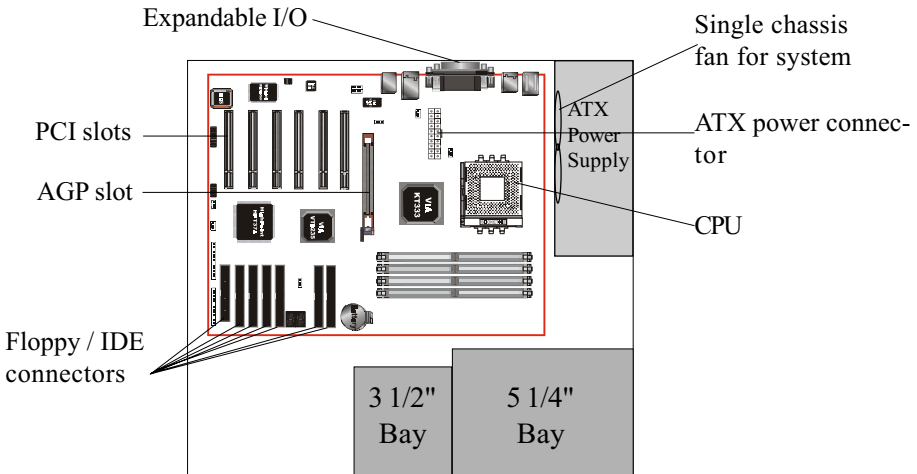

Figure 2: Summary of ATX chassis features

I/O Shield Connector

The board is equipped with an I/O back panel. Please use the appropriate I/O shield (figure 3).

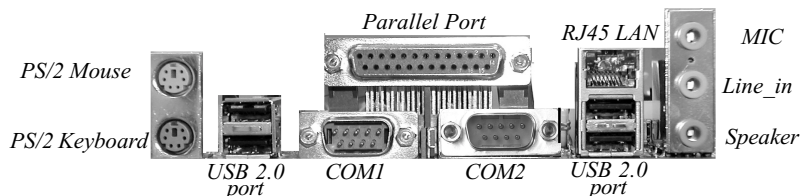

Figure 3: I/O back panel layout

Power-On/Off (Remote)

The board has a single 20-pin connector for ATX power supplies. For ATX power supplies that support the **Remote On/Off** feature, this should be connected to the systems front panel for system Power On/Off button. The systems power On/Off button should be a momentary button that is normally open.

The board has been designed with "Soft Off" functions. You can turn Off the system from one of two sources: The first is the front panel Power On/Off button, and the other is the "Soft Off" function (coming from the M/B's onboard circuit controller) that can be controlled by the operating system such as Windows® 95/98/SE/ME or Windows® 2000.

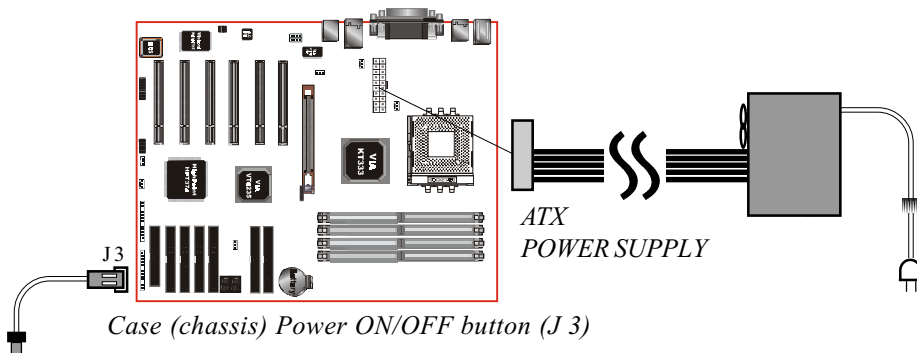

Figure 4: Simple ATX Power ON/OFF Controller

Introduction

System Block Diagram

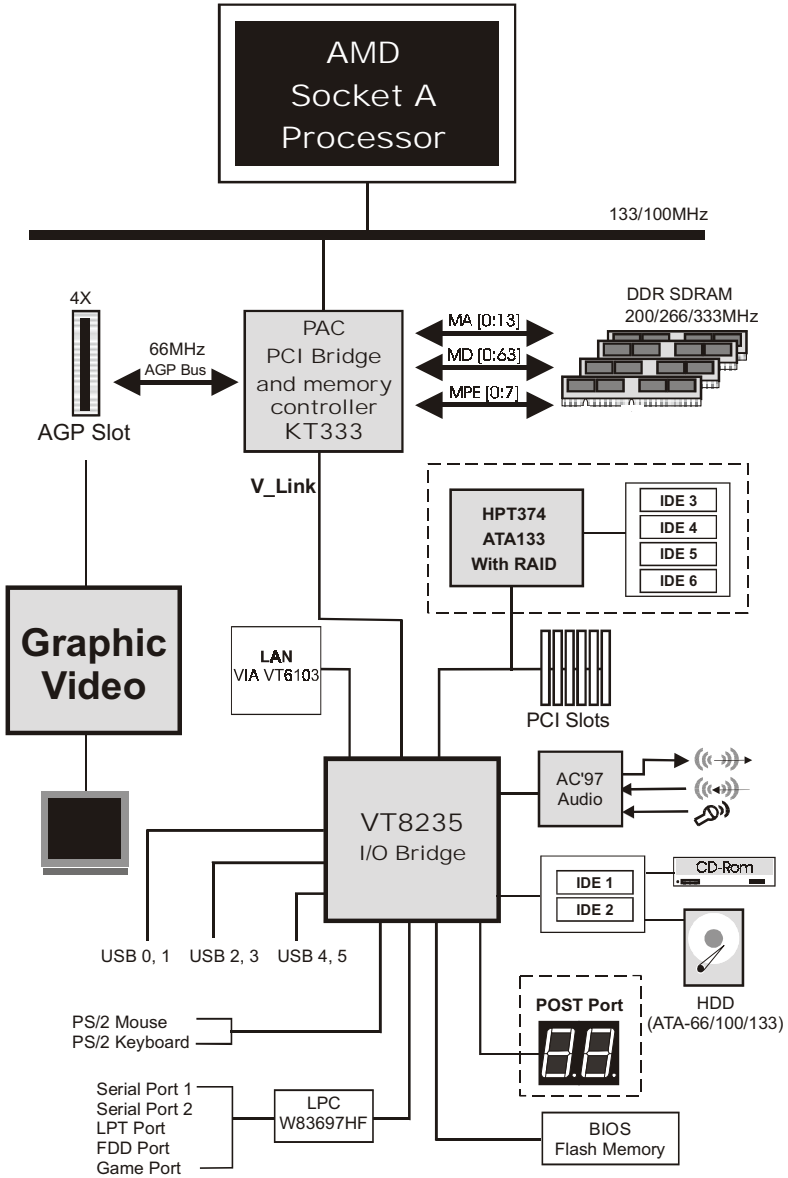

Figure 5: System Block Diagram

Mainboard Features:

◆ **PROCESSOR**

- The Socket A compatible AMD Athlon™ XP processor 1500+ to 2000+, 600MHz to 1.4GHz AMD Athlon™ and AMD Duron™ Processor up to 1.3GHz

◆ **CHIPSET**

- VIA KT333 AGPset (KT333 + VT8235)

◆ **DRAM MODULE**

- 184pin DDR DIMM x 4 for PC1600/2100/2700 Memory
- DRAM Size: 64MB to 4GB

◆ **EXPANSION SLOT**

- PCI x 6, 4X AGP x 1

◆ **ONBOARD I/O**

- Winbond 83697HF LPC I/O integrated with FDD, Parallel, Serial, Game and Fast IR Port

◆ **ONBOARD PCI / IDE**

- PCI Bus IDE Port with PIO/Ultra DMA-66/100/133 x 2 (up to 4 devices)
- Extra dual channel IDE Port by HPT374 with Ultra DMA-66/100/133 and IDE RAID x 4 (up to 8 devices)
 - * Supports JBOD function (Just a Bunch of Disks). JBOD are a group of hard disks in a computer that are not configured in a RAID.

◆ **I/O CONNECTOR**

- PS/2 Mouse and PS/2 style Keyboard
- COM1, COM2, Printer, Audio-in/out, MIC & Game Port connectors by extra cable

Features

◆ Onboard LAN

- Integrated 10/100MB fast Ethernet controller in chipset with external VIA VT6103 physical Layer by RJ-45 connector

◆ USB

- Supports USB2.0 specification
- USB connector x 6 (2 for Opt.)

◆ BIOS

- Award Plug & Play BIOS

◆ Built-in AC97 Digital Audio (By Realtek ALC650)

- Compliant with AC97 2.2 Specification
- 6 channel slot selectable DAC output for multi-channel applications
- Supports digital SPDIF
- Supports 2 general purpose I/O pins

◆ EXTENDED FUNCTION

- Supports Hardware Monitoring Function by W83697HF
- Supports exclusive KBPO (KeyBoard Power On) Function
- Supports Wake-On-LAN Function
- Supports STR (Suspend To RAM) power saving Function
- Supports CPU Clock and Ratio settings via BIOS
- Supports CPU Vcore and Memory Voltage setting via BIOS
- Supports “Magic Health” and “Easy Boot” Function
- Supports CPU Overheating Protection
- POST Port onboard design with 7-segment LED display

◆ FORM FACTOR

- 305mm x 245mm ATX Size

Section 3
INSTALLATION

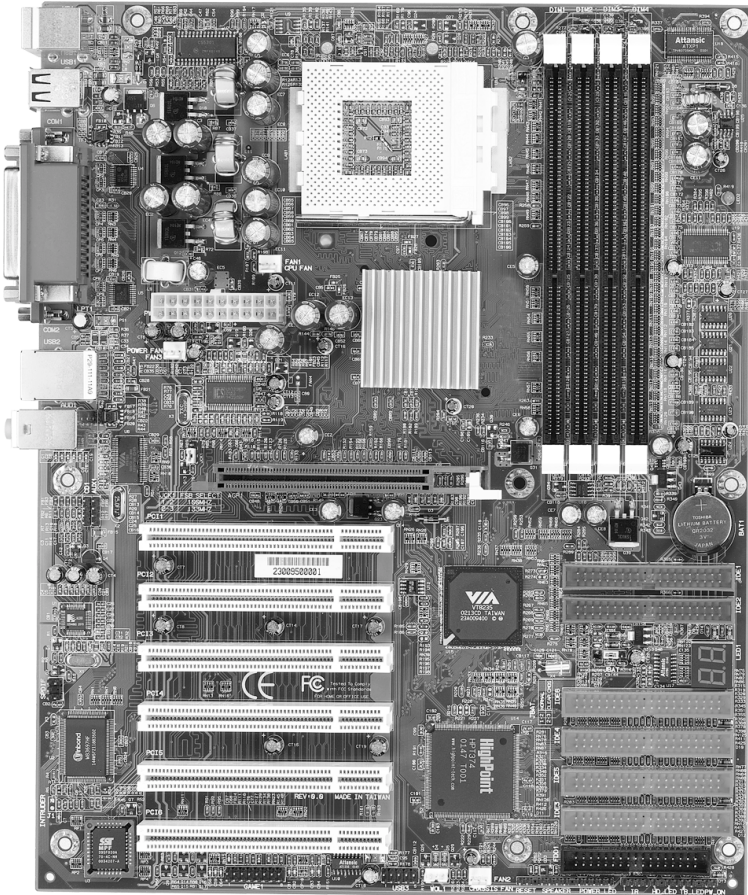

Easy Installation Procedure

The following must be completed before powering on your new system:

- 3-1. CPU Installation**
- 3-2. Jumper Settings**
- 3-3. System Memory Configuration**
- 3-4. Device Connectors**
- 3-5. STR Function**
- 3-6. CPU Overheating Protection**

Section 3-1 CPU Installation

CPU Insertion: (use AMD Athlon™ as reference)

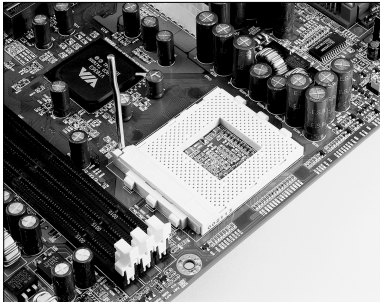

Figure 2

Step 1

Open the socket by raising the actuation lever.

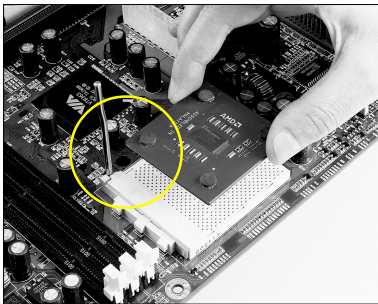

Figure 3

Step 2

Insert the processor.

Ensure proper pin 1 orientation by aligning the FC-PGA corner marking with the socket corner closest to the actuation arm tip. The pin field is keyed to prevent mis-oriented insertion.

Don't force processor into socket. If it does not go in easily, check for mis-orientation and debris.

Make sure the processor is fully inserted into the socket on all sides.

Installation

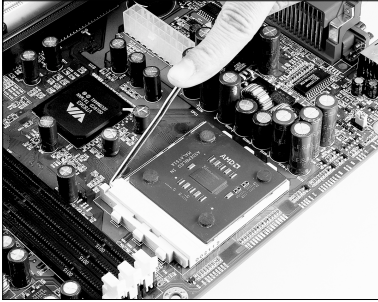

Figure 4

Step 3

Close the socket by lowering and locking the actuation lever.

Step 4

Thermal compound and qualified heatsink recommended by AMD are a must to avoid CPU overheat damage. For more information about installing your CPU, please refer to the AMD website article “Socket A AMD processor and Heatsink Installation Guide” <http://www.amd.com/products/cpg/athlon/pdf/23986.pdf>.

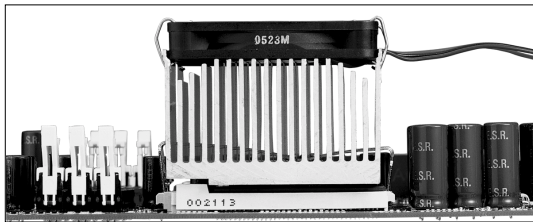
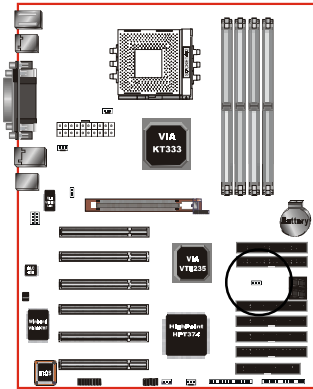

Figure 5

Section 3-2 Jumper Settings



JBAT



- CMOS Clear
- 1-2: Normal (Default)
 - 2-3: Clear CMOS

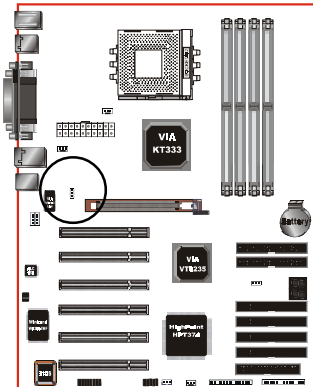

JCK1



- CPU Host Clock Select
- 1-2: 100MHz (Default)
 - 2-3: 133MHz

Installation

Section 3-3 System Memory Configuration

Memory Layout

The board supports (4) PC1600/2100/2700 184-pin DIMMs (Dual In-line Memory Module). The DIMMs is for DDR SDRAM (Double-Data-Rate Synchronous DRAM) only.

Figure 6 and Table 1 show several possible memory configurations.

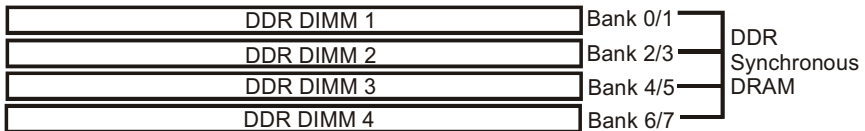

Figure 6

Total Memory	DDR DIMM 1 (Bank 0/1)	DDR DIMM 2 (Bank 2/3)	DDR DIMM 3 (Bank 4/5)	DDR DIMM 4 (Bank 6/7)
= 1GB Maximum	DDR SDRAM* 64MB, 128MB, 256MB, 512MB, 1GB* X 1	None	None	None
= 2GB Maximum	DDR SDRAM* 64MB, 128MB, 256MB, 512MB, 1GB* X 1	DDR SDRAM* 64MB, 128MB, 256MB, 512MB, 1GB* X 1	None	None
= 3GB Maximum	DDR SDRAM* 64MB, 128MB, 256MB, 512MB, 1GB* X 1	DDR SDRAM* 64MB, 128MB, 256MB, 512MB, 1GB* X 1	DDR SDRAM* 64MB, 128MB, 256MB, 512MB, 1GB* X 1	None
= 4GB Maximum	DDR SDRAM* 64MB, 128MB, 256MB, 512MB, 1GB* X 1	DDR SDRAM* 64MB, 128MB, 256MB, 512MB, 1GB* X 1	DDR SDRAM* 64MB, 128MB, 256MB, 512MB, 1GB* X 1	DDR SDRAM* 64MB, 128MB, 256MB, 512MB, 1GB* X 1

Table 1

- * DDR SDRAM supports 64, 128, 256, 512MB and 1GB DIMM modules.
- * 1GB module using 512Mb technology.
- * DO NOT MIX the unbuffered and registered DDR SDRAM on DIMM1, DIMM2, DIMM 3 and DIMM4 socket.
- * This mainboard doesn't support ECC memory module.

DIMM Module Installation

Figure 7 displays the notch marks and what they should look like on your DDR DIMM memory module.

DIMMs have 184-pins and one notch that will match with the onboard DDR DIMM socket. DIMM modules are installed by placing the chip firmly into the socket at a 90 degree angle and pressing straight down (figure 8) until it fits tightly into the DIMM socket (figure 9).

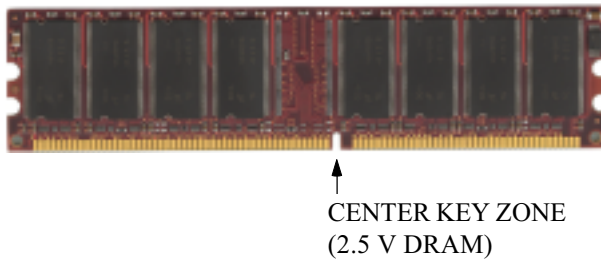

Figure 7

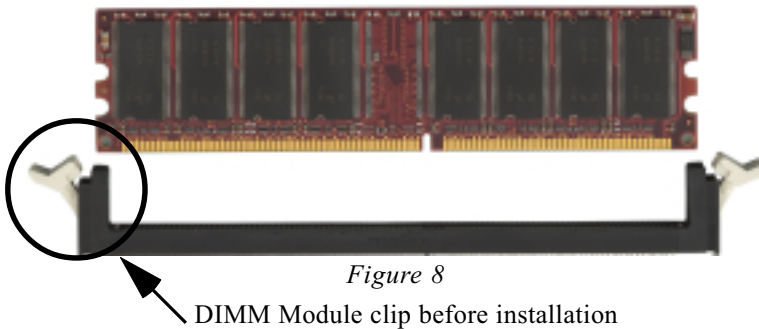

Figure 8

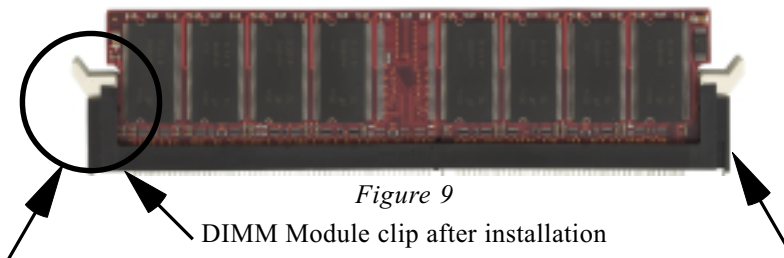

Figure 9

To remove the DIMM module simply press down both of the white clips on either side and the module will be released from the socket.

Installation

Section 3-4 Device Connectors

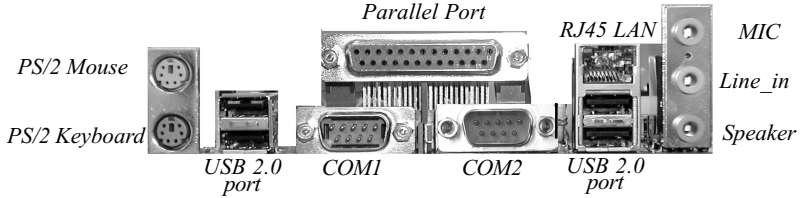
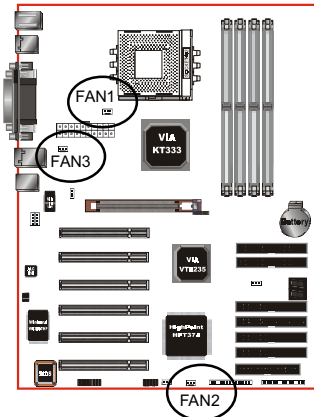

Figure 10



FAN1 / FAN2 / FAN3:

- The plug-in for CPU/Chassis/Power Fan power

FAN1:
CPU Fan

FAN2:
CHASSIS Fan

FAN3:
POWER Fan

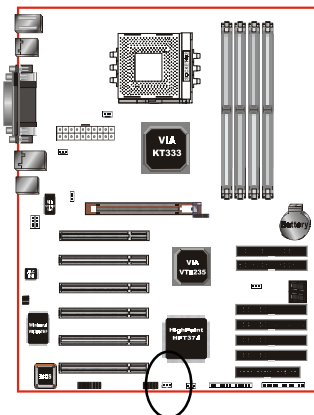
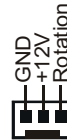

WOL1: WOL (Wake On LAN) Connector
Reserved for NIC (Network Interface Card) to wake the system.



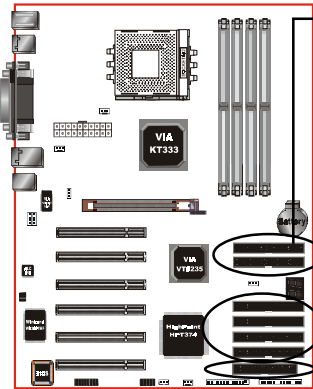

IDE1/2: Ultra DMA-66/100/133 Primary/Secondary IDE Connector (Blue)

IDE3/4/5/6: Ultra DMA-66/100/133 & dual RAID Primary/Secondary IDE Connector (Red)
Supported by HTP374 chipset
(Optional)

FDD1: Floppy Controller Connector (Black color)

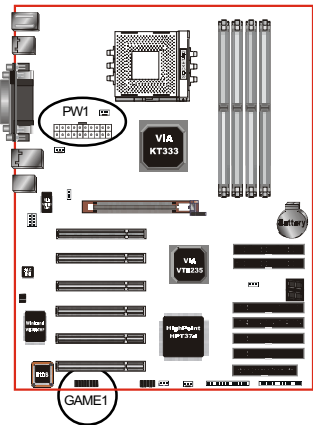

PW1: ATX Power Connector
(20-pin power connector)

GAME1: Game port connector

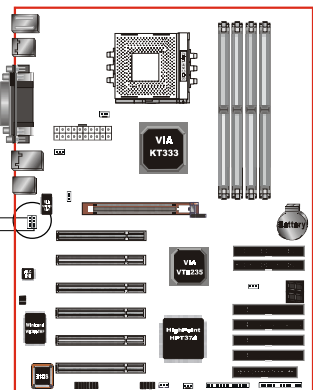

CD1: CD Audio_IN Connector

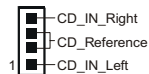

AUX1: Auxiliary Line_IN Connector

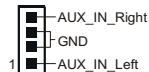

Installation

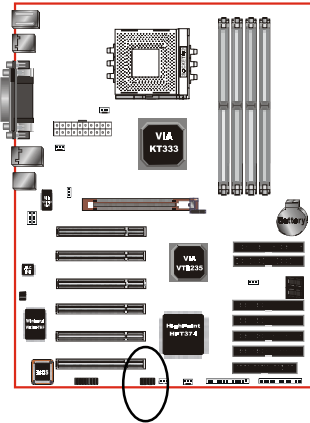

USB3: USB port header pins for two USB2.0 ports.

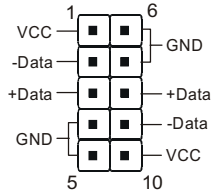

USB port header pin descriptions.

PIN#	Wire color	Signal Name	Comment
1	Red	Vcc	Cable Power
2	White	-Data	Data
3	Green	+Data	Data
4	Black	Ground	Cable Ground
5	Black	Ground	Case Ground
6	Black	Ground	Case Ground
7	Black	Ground	Cable Ground
8	Green	+Data	Data
9	White	-Data	Data
10	Red	Vcc	Cable Power

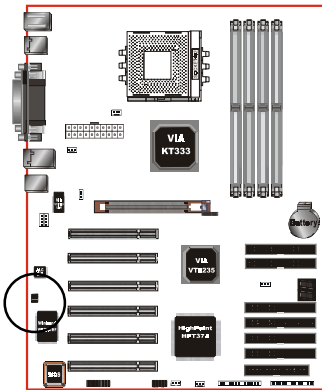

SPDIF: Sony/Philips Digital Interface

This connector is the digital link between the motherboard and your devices, such as CD player, sampler or DAT recorder. It allows the digital transmission of audio data in SPDIF format.

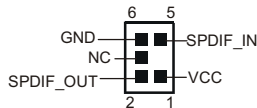

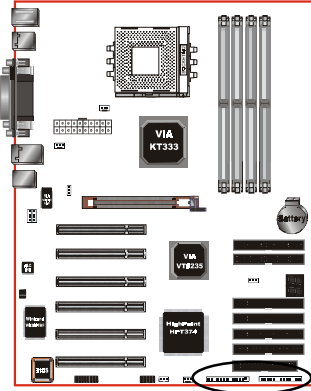

◆ Power On/Off

(This is connected to the power button on the case. Using the Soft-Off by Pwr-BTTN feature, you can choose either Instant Off (turns system off immediately), or 4 sec delay (you need to push the button down for 4 seconds before the system turns off). When the system is in 4 sec delay mode, suspend mode is enabled by pushing the button momentarily.)

◆ Turbo LED indicator

LED ON when higher speed is selected

◆ IDE LED indicator

LED ON when Onboard PCI IDE Hard disks is activate

◆ IR Connector

- | | |
|---------|---------|
| 1. VCC | 4. GND |
| 2. NC | 5. IRTX |
| 3. IRRX | |

◆ Power LED

Power LED connector

- | | |
|-----------------|--------|
| 1. Power LED(+) | 4. NC |
| 2. N/C | 5. GND |
| 3. GND | |

◆ Speaker

Connect to the system's speaker for beeping

- | | |
|------------|--------|
| 1. Speaker | 3. GND |
| 2. N/C | 4. GND |

◆ Reset

Closed to restart system.

J3

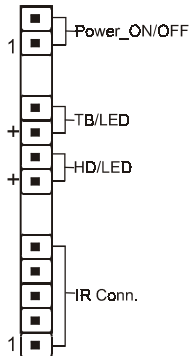

J2

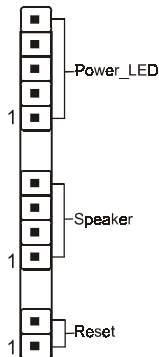

Installation

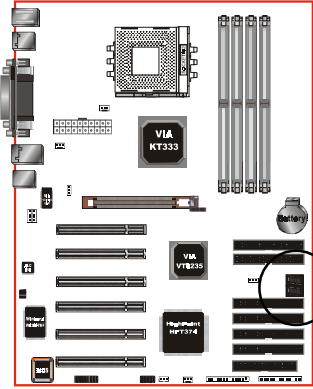

LED1

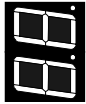

POST Debug 7-segment LED display (Please refer to Appendix E for POST codes)

3-5 STR (Suspend To RAM) Function

The board supports the STR power management state by maintaining the appropriate states on the DDR SDRAM interface signals. The power source must be kept alive to the DDR SDRAM during STR (ACPI S3). Advanced Configuration Power Interface (ACPI) provides more Energy Saving Features for operating systems that supporting Instant ON and QuickStart™ function.

1. To enable the ACPI function and use the STR functionally to save your system energy, you are recommended to confirm the following requirements:
 - a. Please do install all ACPI qualified add-on cards such as AGP, LAN, Modem cards.
 - b. In BIOS, please select “ACPI function: Enable” and “ACPI Suspend Type: S3(STR)” in the Power Management Setup menu.
 - c. Then, please install the Windows® 98SE/ME or Windows® 2000.
 - d. Restart your system.
 - e. Getting in to the “Advanced” of the Power Management icon of Control Panel, and selecting the “Stand By” in the Power Buttons.
2. Getting start with STR function, please click the START button and choose Shut Down. Then, select the Stand By option in the Shut Down Windows box to get into STR mode.

Here are the differences between STR power saving mode and Green (or Suspend) mode:

- a. It is the most advanced Power Management mode
- b. It cuts all the power supplied to peripherals except to Memory - max. power saving
- c. It saves and keeps all on-screen data including any executed applications to DDR SDRAM.

Installation

- d. You must push the Power button connected with onboard J3 pin to wake up your system (not to click to PS/2 mouse or press PS/2 keyboard to wake up the system).

Just pushing Power button, your system will quickly back to the last screen for you.

The “LED Indicator for ACPI Status” table shown below will guide you and give you a reference for ACPI status on this mainboard.

ACPI Onboard's LED Status Indicator Table					
Onboard's LED Location	Status				
	Plug in the ATX Power Core	Power ON J3(PW-ON)	Green Mode (S1)	STR (S3)	Shutdown (Soft-OFF) (S5)
LED2 (Red LED)	OFF	ON	ON	ON	OFF
J2 PW_LED	OFF	ON	Blinking	Slow Blinking	OFF

3-6 CPU Overheating Protection

This board has CPU Overheating Protection when the temperature of CPU is overheating. This board supports automatically shutdown (to remove power) circuit when the CPU has reached the temperature of approximately 100°C. Meanwhile the speaker will sustained beep and the system will not be to power on.

To power on your system normally, we recommend you to confirm the following steps:

- Step1:** Unplug in the ATX power core (or turn off ATX power supply switch).
- Step2:** Please wait the beep to stop then plug in the ATX power core again (or turn on ATX power switch) to turn on your system.

Note: The CPU Overheating Protection will function only when CPU has thermal diode design.

Section 4

AWARD BIOS SETUP

Main Menu

Award's ROM BIOS provides a built-in Setup program which allows user to modify the basic system configuration and hardware parameters. The modified data will be stored in a battery-backed CMOS, so that data will be retained even when the power is turned off. In general, the information saved in the CMOS RAM will stay unchanged unless there is a configuration change in the system, such as hard drive replacement or a device is added.

It is possible for the CMOS battery to fail, this will cause data loss in the CMOS only. If this does happen you will need to reconfigure your BIOS settings.

To enter the Setup Program :

Power on the computer and press the key immediately, this will bring you into the BIOS CMOS SETUP UTILITY.

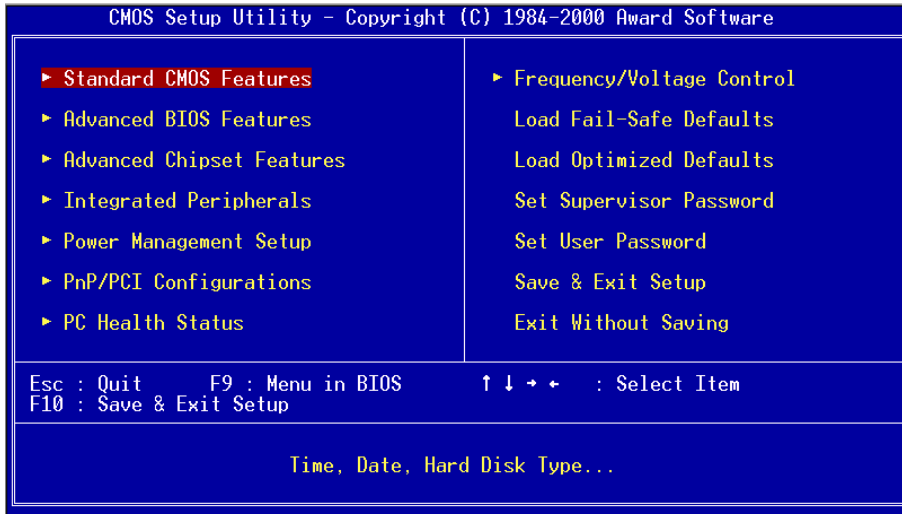

Figure 1: CMOS Setup Utility

BIOS

The menu displays all the major selection items. Select the item you need to reconfigure. The selection is made by moving the cursor (press any direction key) to the item and pressing the ‘Enter’ key. An on-line help message is displayed at the bottom of the screen as the cursor is moved to various items which provides a better understanding of each function. When a selection is made, the menu of the selected item will appear so that the user can modify associated configuration parameters.

4-1 Standard CMOS Setup

Choose “Standard CMOS Setup” in the CMOS SETUP UTILITY Menu (Figure 2). The Standard CMOS Setup allows the user to configure system settings such as the current date and time, type of hard disk drive installed, floppy drive type, and display type. Memory size is auto-detected by the BIOS and displayed for your reference. When a field is highlighted (use direction keys to move the cursor and the <Enter> key to select), the entries in the field can be changed by pressing the <PgDn> or the <PgUp> key.

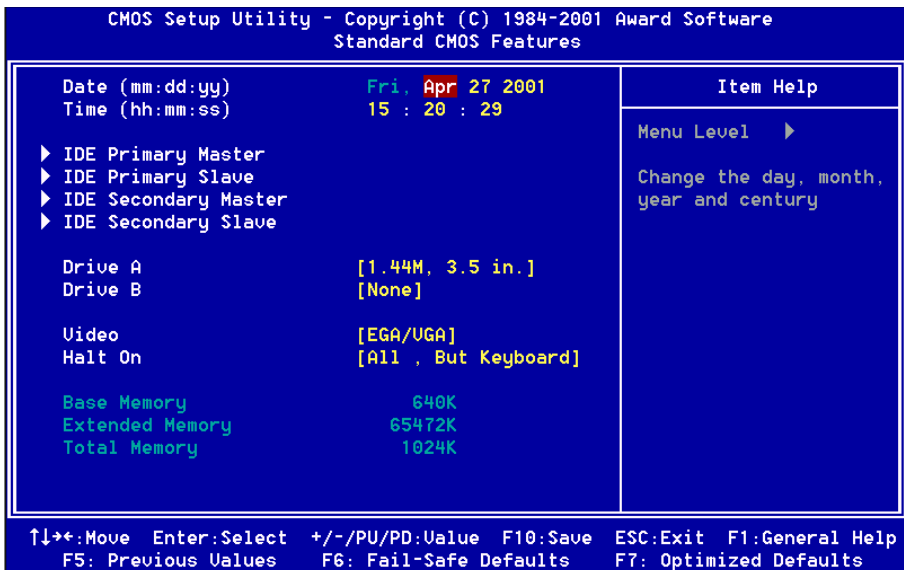

Figure 2: Standard CMOS Setup

NOTE: If the hard disk Primary Master/Slave and Secondary Master/Slave are set to Auto, then the hard disk size and model will be auto-detected.

NOTE: The “Halt On:” field is used to determine when to halt the system by the BIOS if an error occurs.

NOTE: Floppy 3 Mode support is a mode used to support a special 3.5” drive used in Japan. This is a 3.5” disk that stores only 1.2 MB, the default setting for this is disabled.

4-2 Advanced BIOS Features

Selecting the “BIOS FEATURES SETUP” option in the CMOS SETUP UTILITY menu allows users to change system related parameters in the displayed menu.

This menu shows all of the manufacturer’s default values for the board.

Pressing the [F1] key will display a help message for the selected item.

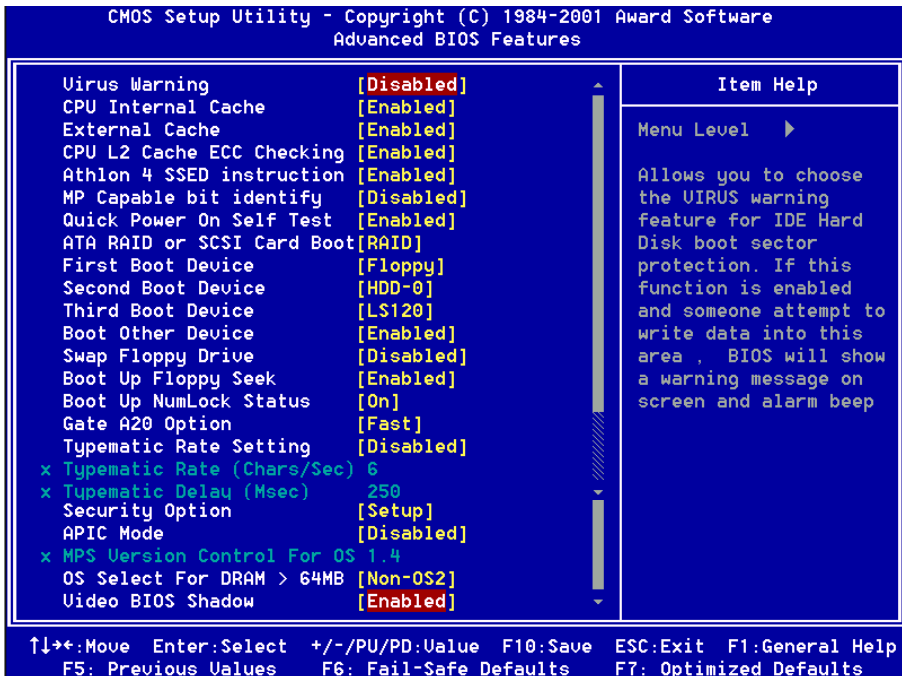

Figure 3: BIOS Features Setup

BIOS

Virus Warning: During and after the system boots up, any attempt to write to the boot sector or partition table of the hard disk drive will halt the system and an error message will appear.

You should then run an anti-virus program to locate the virus. Keep in mind that this feature protects only the boot sector, not the entire hard drive.

The default value is Disabled.

Enabled: Activates automatically when the system boots up causing a warning message to appear when anything attempts to access the boot sector.

Disabled: No warning message will appear when anything attempts to access the boot sector.

Note: Many disk diagnostic programs that access the boot sector table can trigger the virus warning message. If you plan to run such a program, we recommend that you first disable the virus warning.

CPU Internal Cache: This controls the status of the processor's internal cache area. The default is Enabled.

Enabled: This activates the processor's internal cache thereby increasing performance.

Disabled: This deactivates the processor's internal cache thereby lowering performance.

External (L2) Cache: This controls the status of the external (L2) cache area. The default is Enabled.

Enabled: This activates the CPU's L2 cache thereby increasing performance.

Disabled: This deactivates the CPU's L2 cache thereby lowering performance.

CPU L2 Cache ECC Checking: This control if the CPU's L2 Cache will support Error Checking and Correcting (ECC). The default is Disabled.

Enabled: Enables ECC support for the CPU's L2 cache. Performance will decrease 2%~4%.

Disabled: Disables ECC support for the CPU's L2 cache.

Athlon 4 SSED instruction: This item allows you to disable Athlon 4 new SSED instruction. The default is Enabled.

The choices: Enabled, Disabled.

MP Capable bit identify: This item allows you to identify Athlon MP Processor, if this function is Enabled. The default is Disabled.

The choices: Enabled, Disabled.

Quick Power On Self Test: This category speeds up the Power On Self Test (POST). The default is Enabled.

Enabled: This setting will shorten or skip of the items checked during POST.

Disabled: Normal POST.

ATA RAID or SCSI Card Boot (Optional): Setup the boot up priority either form onboard ATA RAID connector or SCSI Card, if you select SCSI as the first boot at the option below item. The default is RAID.

The choices: RAID, SCSI.

First /Second/Third/Other Boot Device: The BIOS attempts to load the operating system from the devices in the sequence selected in these items.

The choices: Floppy, LS120, HDD-0, SCSI, CDROM, HDD-1, HDD-2, HDD-3, ZIP100, USB-FDD, USB-ZIP, USB-CDROM, USB-HDD, LAN, Disabled.

Swap Floppy Drive: This will swap your physical drive letters A & B if you are using two floppy disks. The default is Disabled.

Enabled: Floppy A & B will be swapped under the O/S.

Disabled: Floppy A & B will be not swapped.

Boot Up Floppy Seek: During Power-On-Self-Test (POST), BIOS will determine if the floppy disk drive installed is 40 or 80 tracks. Only 360K type is 40 tracks while 760K, 1.2MB and 1.44MB are all 80 tracks. The default is Enabled.

Enabled: The BIOS will search the floppy disk drive to determine if it is 40 or 80 tracks.

Disabled: The BIOS will not search for the type of floppy disk drive by track number.

Note: BIOS can not tell the difference between 720K, 1.2MB and 1.44MB drive types as they are all 80 tracks.

Boot Up NumLock Status: This controls the state of the NumLock key when the system boots. The default is On.

BIOS

On: The keypad acts as a 10-key pad.

Off: The keypad acts like the cursor keys.

Gate A20 Option: This refers to the way the system addresses memory above 1MB (extended memory). The default is Normal.

Normal: The A20 signal is controlled by the keyboard controller or chipset hardware.

Fast: The A20 signal is controlled by Port 92 or chipset specific method.

Typematic Rate Setting: This determines the keystrokes repeat rate. The default is Disabled.

Enabled: Allows typematic rate and typematic delay programming.

Disabled: The typematic rate and typematic delay will be controlled by the keyboard controller in your system.

Typematic Rate (Chars/Sec): This is the number of characters that will be repeated by a keyboard press. The default is 6.

The Choices: 6, 8, 10, 12, 15, 20, 24, 30 characters per second.

Typematic Delay (msec): This setting controls the time between the first and the second character displayed by typematic auto-repeat. The default is 250.

The Choices: 250, 500, 750, 1000 msec.

Security Option: This category allows you to limit access to the System and Setup, or just to Setup. The default is Setup.

System: The system will not boot and the access to Setup will be denied if the correct password is not entered at the prompt.

Setup: The system will boot; but the access to Setup will be denied if the incorrect password is not entered at the prompt.

APIC Mode: This item allows you to enable APIC (Advanced Programmable Interrupt Controller) functionality. APIC is an Intel chip that provides symmetric multiprocessing (SMP) for its Pentium systems. The default is Disabled.

Options: Enabled, Disabled.

MPS Version Control For OS 1.4: Specifies the Multiprocessor Specification (MPS). Version 1.4 supports multiple PCI bus configurations by incorporating extended bus definitions. Enable this for Windows NT or Linux. For older operating systems, select Version 1.1. The default is 1.4.

Options: 1.1, 1.4.

OS Select For DRAM > 64MB: Some operating systems require special handling. Use this option only if your system has greater than 64MB of memory. The default is Non-OS2.

OS2: Select this if you are running the OS/2 operating system with greater than 64MB of RAM.

Non-OS2: Select this for all other operating systems and configurations.

Video BIOS Shadow: This option allows video BIOS to be copied into RAM. Video Shadowing will increase the video performance of your system. The default is Enabled.

Enabled: Video shadow is enabled.

Disabled: Video shadow is disabled.

4-3 Advanced Chipset Features

Choose the “CHIPSET FEATURES SETUP” in the CMOS SETUP UTILITY menu to display following menu.

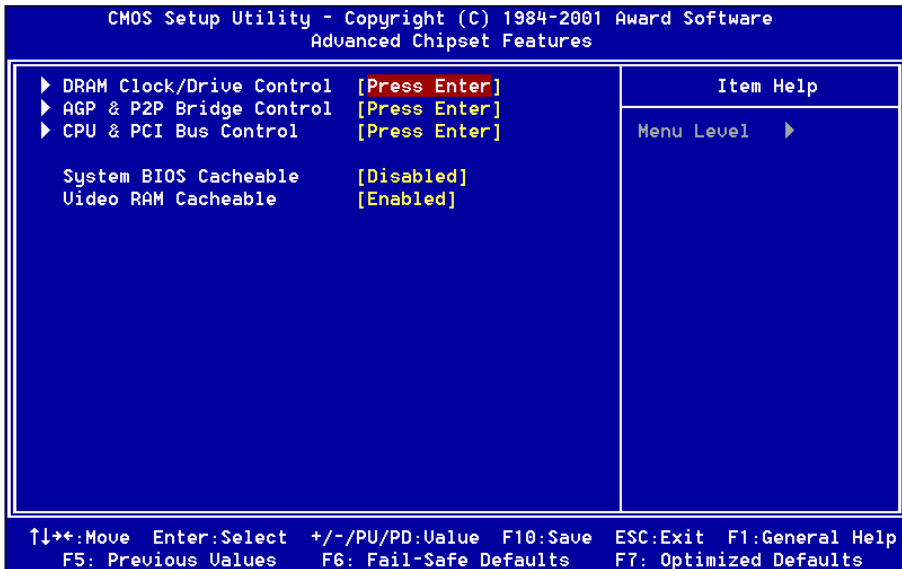

Figure 4: Chipset Features Setup

System BIOS Cacheable: This item allows the system to be cached in memory for faster execution. The default is Enabled.

Options: Disabled, Enabled.

Video RAM Cacheable: This option allows the CPU to cache read/writes of the video RAM. The default is Enabled.

Enabled: This option allows for faster video access.

Disabled: Reduced video performance.

CMOS Setup Utility - Copyright (C) 1984-2001 Award Software
 DRAM Clock/Drive Control

System Performance	[Normal]	Item Help
Current FSB Frequency	100MHz	Menu Level ▶▶
Current DRAM Frequency	133MHz	
DRAM Clock	[By SPD]	
DRAM Timing	[By SPD]	
x SDRAM Cycle Length	3	
x Bank Interleave	Disabled	
x Precharge to Active(Trp)	3T	
x Active to Precharge(Tras)	6T	
x Active to CMD(Trcd)	3T	
DRAM Burst Length	[4]	
DRAM Queue Depth	[4 level]	
DRAM Command Rate	[AUTO]	
DCLKI Timing	[Auto]	
DCLKO Timing	[Auto]	
Fast R-W Turn Around	[Disabled]	
Continuous DRAM Request	[Disabled]	
Write Recovery Time	[3T]	

↑↓←→:Move Enter:Select +/-/PU/PD:Ualue F10:Save ESC:Exit F1:General Help
 F5: Previous Values F6: Fail-Safe Defaults F7: Optimized Defaults

▶ **DRAM Clock/Drive Control**

System Performance : This item will help you to configure your system performance quickly and easily. There are four selections. When a selection is made, the other related items will automatically vary values.

The Choices: Normal, Fast, Fastest, Turbo.

Note: If you select the higher performance, compatibility problem could be occurred.

Current FSB Frequency: CPU clock frequency information. (No option/Display only).

Current DRAM Frequency: DRAM frequency information. (No option/Display only).

DRAM Clock : The item will synchronize/asynchronize DRAM clock operation.

100MHz: DRAM is running at 100MHz frequency.

133MHz: DRAM is running at 133MHz frequency.

166MHz: DRAM is running at 166MHz frequency.

By SPD: SDRAM clock by SPD data.

BIOS

DRAM Timing : Select SPD for setting SDRAM timing by SPD.

The Choices: Manual, SPD.

SDRAM Cycle length: This setting defines the CAS timing parameter of the SDRAM in terms of clocks. Default is by SPD.

The Choices: 2, 2.5, 3.

Bank Interleave: The item allows you to set how many banks of SDRAM support in your mainboard. Default is by SPD.

The Choices: 2 Bank, 4 Bank, Disabled.

Precharge to Active (Trp): Setup the minimum row precharge time.

The Choices: 2T, 3T.

Active to Precharge (Tras): Setup the minimum RAS pulse width.

The Choices: 5T, 6T.

Active to CMD (Trcd): Setup the minimum CAS to RAS delay.

The Choices: 2T, 3T.

DRAM Burst Length:

The Choices: 4, 8.

DRAM Queue Depth:

The Choices: 4 level, 2 level, 3 level.

DRAM Command Rate: Setup the timing at each cycle.

The Choices: 1T Command, 2T Command.

DCLKI/DCLKO Timing:

The Choices: 0ns, 0.5ns, 1ns, Auto.

Fast R-W Turn Around: This item controls the DRAM timing. It allows you to enable/disable the fast/write turn around.

The Choices: Enabled, Disabled.

Continuous DRAM Request:

The Choices: Enabled, Disabled.

CMOS Setup Utility - Copyright (C) 1984-2001 Award Software		AGP & P2P Bridge Control	
AGP Aperture Size	[128M]	Item Help	
AGP Mode	[4X]		
AGP Driving Control	[Auto]	Menu Level >>	
x AGP Driving Value	DA		
AGP Fast Write	[Disabled]		
AGP Master 1 WS Write	[Disabled]		
AGP Master 1 WS Read	[Disabled]		

▶ **AGP & P2P Bridge Control**

AGP Aperture Size: The amount of system memory that the AGP card is allowed to share with. The default is 128MB.

The Choices: 4, 8, 16, 32, 64, 128, 256MB.

AGP Mode: Chipset AGP Mode support.

The choices: 1X, 2X, 4X.

AGP Driving Control: This item allows you to adjust the AGP driving force. Choose Manual to key in a AGP Driving Value in the next selection. This field is recommended to set in **Auto** for avoiding any error in your system.

AGP Fast Write: Selecting Enabled allows to use Fast Write Protocol for 4X AGP card.

AGP Master 1 WS Write: When Enabled, Writes to the AGP (Accelerated Graphics Port) are executed with one wait states.

The Choices: Enabled, Disabled.

AGP Master 1 WS Read: When Enabled, Reads to the AGP (Accelerated Graphics Port) are executed with one wait states.

The Choices: Enabled, Disabled.

BIOS

CMOS Setup Utility - Copyright (C) 1984-2001 Award Software	
CPU & PCI Bus Control	
PCI1 Master 0 WS Write	[Enabled]
PCI1 Post Write	[Enabled]
PCI2 Post Write	[Enabled]
PCI Delay Transaction	[Enabled]
	Item Help
	Menu Level >>

▶ *CPU & PCI Bus Control*

PCI1 Master 0 WS Write: When Enabled, Writes to the PCI bus are commanded with zero wait states.

The Choices: Enabled, Disabled.

PCI Delay Transaction: The chipset has an embedded 32-bit posted write buffer to support delay transactions cycles. Select Enabled to support compliance with PCI specification version 2.1.

The Choices: Enabled, Disabled.

4-4 Integrated Peripherals

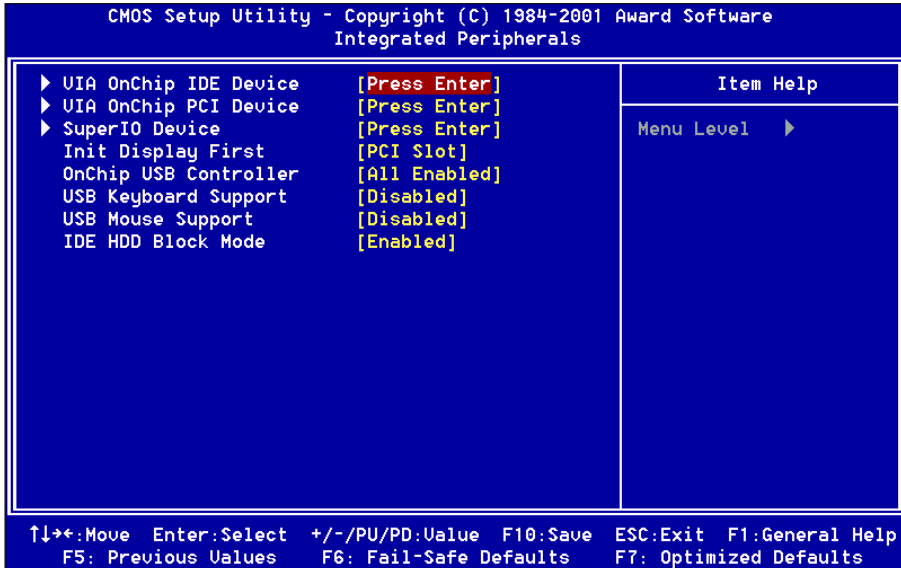

Figure 5: Integrated Peripherals

Note: If you do not use the Onboard IDE connector, then you will need to set Onboard Primary PCI IDE: Disabled and Onboard Secondary PCI IDE: Disabled

Note: The Onboard PCI IDE cable should be equal to or less than 18 inches (45 cm.).

Init Display First: If two video cards are used (1 AGP and 1 PCI) this specifies which one will be the primary display adapter. The default is PCI Slot.

PCI Slots: PCI video card will be primary adapter.

AGP: AGP video card will be primary adapter.

OnChip USB Controller: USB Controller (Port1)(Port2)(Port3).

The Choices: All Disabled, All Enabled.

USB Keyboard/Mouse Support: Select Enabled if your system contains a Universal Serial Bus (USB) controller and you have a USB Mouse/keyboard device.

The Choices: Enabled, Disabled.

BIOS

IDE HDD Block Mode: IDE Block Mode allows the controller to access blocks of sectors rather than a single sector at a time. The default is Enabled.

Enabled: Enabled IDE HDD Block Mode. Provides higher HDD transfer rates.

Disabled: Disable IDE HDD Block Mode.

CMOS Setup Utility - Copyright (C) 1984-2001 Award Software		
VIA OnChip IDE Device		
OnChip IDE Channel0	[Enabled]	Item Help
OnChip IDE Channel1	[Enabled]	
IDE Prefetch Mode	[Enabled]	Menu Level >>
Primary Master PIO	[Auto]	
Primary Slave PIO	[Auto]	
Secondary Master PIO	[Auto]	
Secondary Slave PIO	[Auto]	
Primary Master UDMA	[Auto]	
Primary Slave UDMA	[Auto]	
Secondary Master UDMA	[Auto]	
Secondary Slave UDMA	[Auto]	
CDROM UDMA Support	[Disabled]	

▶ *VIA OnChip IDE Device*

OnChip IDE Channel0/1: The default value is Enabled.

The integrated peripheral controller contains an IDE interface with support for two IDE channels. Select *Enabled* to activate each channel separately.

The choices: Enabled, Disabled.

IDE Prefetch Mode: Enable prefetching for IDE drive interfaces that support its faster drive accesses. If you are getting disk drive errors, change the setting to omit the drive interface where the errors occur. Depending on the configuration

of your IDE subsystem, this field may not appear, and it does not appear when the Internal PCI/IDE field, above, is Disabled.

The Choices: Enabled, Disabled.

Primary/Secondary Master/Slave PIO: The default is Auto.

The four IDE PIO (Programmed Input/Output) fields let you set a PIO mode (0-4) for each of the four IDE devices that the onboard IDE interface supports.

Modes 0 through 4 provide successively increased performance. In Auto mode, the system automatically determines the best mode for each device.

The choices: Auto, Mode 0, Mode 1, Mode 2, Mode 3, Mode 4.

Primary/Secondary Master/Slave UDMA: This allows you to select the mode of operation for the Ultra DMA-33/66/100/133 implementation is possible only if your IDE hard drive supports it and the operating environment includes a DMA driver (Windows 95 OSR2 or a third-party IDE bus master driver). If your hard drive and your system software both support Ultra DMA-33/66/100/133, select Auto to enable UDMA mode by BIOS or you can select mode by manual.

The Choices: Auto, Disabled, UDMA33, UDMA66, UDMA100, UDMA133.

CDROM UDMA Support: This allows you to select the mode of operation for the CDROM implementation is possible only if your CDROM drive supports it and the operating environment includes a DMA driver (Windows 95 OSR2 or a third-party IDE bus master driver).

The Choices: Enabled, Disabled.

CMOS Setup Utility - Copyright (C) 1984-2001 Award Software		Onboard PCI Device	
VIA AC97 Audio	[Auto]	Item Help	
AC97 Speaker At POST	[Disabled]		
High Point IDE RAID	[Auto]	Menu Level >>	
VIA OnChip LAN	[Enabled]		
Onboard Lan Boot ROM	[Disabled]		

► **Onboard PCI Device**

VIA AC97 Audio: This item allows you to decide to Auto or disable the chipset family to support AC97 Audio. The function setting AC97 Audio Codec states. The system default is Auto.

AC97 Speaker At POST: This item allows you to decide to enable or disable AC97 Speaker At POST function. The default is Disabled. The choices: Enabled, Disabled.

High Point IDE RAID (Optional): This item can control onboard PCI device High Point IDE RAID to use. The choices: Auto, Enabled, Disabled.

Onboard PCI LAN: Enables the onboard LAN feature. The default is Enabled.

Onboard Lan Boot ROM: Enables and disables the onboard LAN Boot ROM. The default is Disabled.

Options: Enabled, Disabled.

CMOS Setup Utility - Copyright (C) 1984-2001 Award Software SuperIO Device		
Onboard FDC Controller	[Enabled]	Item Help
Onboard Serial Port 1	[3F8/IRQ4]	
Onboard Serial Port 2	[2F8/IRQ3]	Menu Level ▶▶
UART Mode Select	[Normal]	
RxD , TxD Active	[Hi,Lo]	
IR Transmission Delay	[Enabled]	
UR2 Duplex Mode	[Half]	
Use IR Pins	[IR-Rx2Tx2]	
Onboard Parallel Port	[378/IRQ7]	
Parallel Port Mode	[SPP]	
EPP Mode Select	[EPP1.7]	
ECP Mode Use DMA	[3]	
Game Port Address	[201]	
Midi Port Address	[Disabled]	
x Midi Port IRQ	10	

► *Super IO Device*

Onboard FDC Controller: Select Enabled if your system has a floppy disk controller (FDC) installed on the system board and you wish to use it. If you install and-in FDC or the system has no floppy drive, select Disabled in this field.

The choices: Enabled, Disabled.

Onboard Serial Port 1/2: Select an address and corresponding interrupt for the first and second serial ports.

The choices: 3F8/IRQ4, 2E8/IRQ3, 3E8/IRQ4, 2F8/IRQ3, Disabled, Auto.

UART Mode Select: This field allows the users to configure what IR mode the 2nd serial port should use. The default is Normal.

The choices: Normal, IrDA and ASKIR.

RxD, TxD Active :This field configures the receive and transmit signals generated from the IR port. The default is Hi Lo (when UART Mode Select is not set to Normal).

The choices: Hi Hi, Hi Lo, Lo Hi, and Lo Lo.

IR Transmission delay: This item allows you to enabled/disable IR transmission delay.

The choices: Enabled, Disabled.

UR2 Duplex Mode: This item allows you to select IR half/full duplex function.

The choices: Half, Full.

Use IR Pins: This item allows you to select IR transmission routes, one is Rx2D2, Tx2D2 (COM Port) and the other is IR-Rx2Tx2.

The choices: IR-Rx2Tx2, Rx2D2, Tx2D2.

Onboard Parallel port: This field allows the user to configure the LPT port.

The choices: 378/IRQ7, 278/IRQ5, 3BC/IRQ7, Disabled.

Parallel Port Mode: This field allows the user to select the parallel port mode.

The choices: SPP, EPP, ECP, ECP+EPP.

EPP Mode Select: This item allows you to determine the IR transfer mode of onboard I/O chip.

The Choices: EPP1.9, EPP1.7.

ECP Mode USE DMA: This field allows the user to select DMA1 or DMA3 for the ECP mode.

The Choices: DMA1, DMA3.

Game Port Address: Select an address for the Game port.

The choices: 201, 209, Disabled.

Midi Port Address: Select an address for the Midi port.

The choices: 290, 300, 330, Disabled.

Midi Port IRQ

Select an interrupt for the Midi port.

The choices: 5, 10.

4-5 Power Management Setup

Choose the “POWER MANAGEMENT SETUP” in the CMOS SETUP UTILITY to display the following screen. This menu allows the user to modify the power management parameters and IRQ signals. In general, these parameters should not be changed unless it’s absolutely necessary.

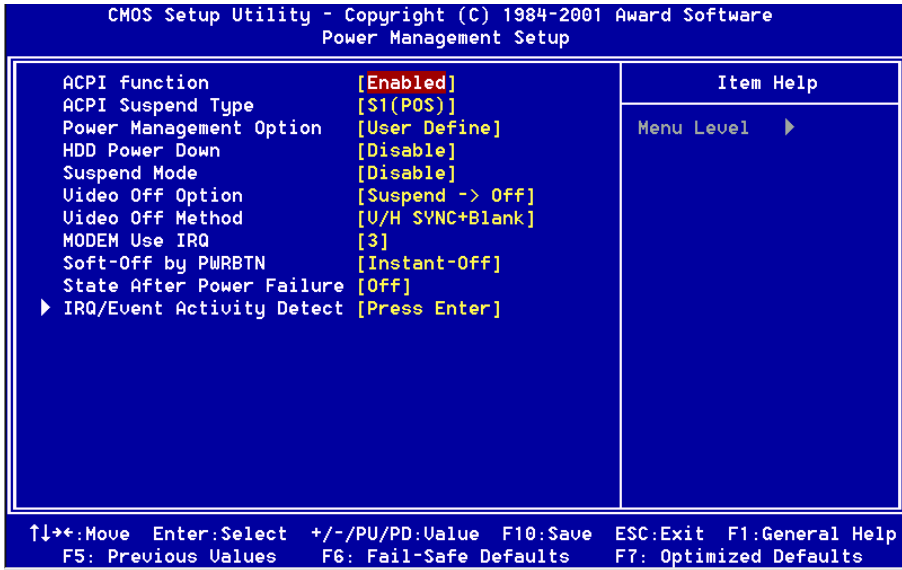

Figure 6: Power Management Setup

ACPI Function: This option allows you to select ACPI Function.

The default is Enabled.

The Choices: Enabled, Disabled.

ACPI Suspend Type: This item allows you to select S1(POS) or S3(STR) function.

The choices: S1(POS), S3(STR).

Power Management Option: Use this to select your Power Management selection.

The default is User define.

Max. saving: Maximum power savings. Inactivity period is 1 minute in each mode.

Min. saving: Minimum power savings. Inactivity period is 1 hour in each mode.

User define: Allows user to define PM Timers parameters to control power saving mode.

HDD Power Down: When enabled and after the set time of system inactivity, the hard disk drive will be powered down while all other devices remain active.
The choices: Enabled, Disabled.

Suspend Mode: When enabled and after the set time of system inactivity, all devices except the CPU will be shut off.
The choices: Enabled, Disabled.

Video Off Option: Tells you what time frame that the video will be disabled under current power management settings. The default is Suspend->Off.

Always On: Video power off not controlled by power management.

Suspend->Off: Video powers off after time shown in suspend mode setting.

Video Off Method: This option allows you to select how the video will be disabled by the power management. The default is V/H Sync + Blank

V/H Sync + Blank: System turns off vertical and horizontal synchronization ports and writes blanks to the video buffer.

DPMS Support: Select this option if your monitor supports the Display Power Management Signaling (DPMS) standard of the Video Electronics Standards Association (VESA). Use the software supplied for your video subsystem to select video power management values.

Blank Screen: System only writes blanks to the video buffer.

MODEM Use IRQ: Name the interrupt request (IRQ) line assigned to the modem (if any) on your system. Activity of the selected IRQ always awakens the system. Default is IRQ 3.

The Choices: N/A, 3, 4, 5, 7, 9, 10, 11

Soft-Off by PWRBTN: Use this to select your soft-off function.

The default is Instant Off.

Instant Off: Turns off the system instantly.

Delay 4 Second : Turns off the system after a 4 second delay. If momentary press of button, the system will go into Suspend Mode. Press the power button again to make system back to work.

BIOS

State After Power Failure: This field lets you determine the state that your PC returns to after a power failure. If set to OFF, the PC will not boot after a power failure, if set to ON, the PC will restart after a power failure.

► *IRQ/Event Activity Dectect*

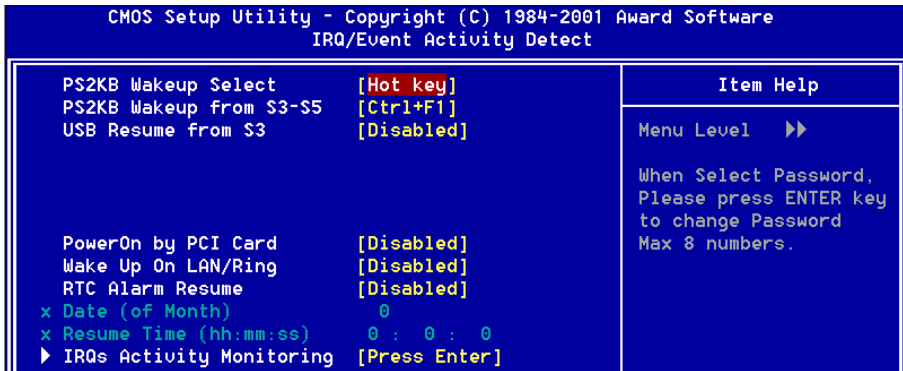

PS2KB Wakeup Select : This item allows you to select Hot Key or Password to wake-up the system by PS2 Keyboard. When select Password, please press ENTER key to change password max 8 numbers.

PS2KB Wakeup form S3-S5: This item allows you to set a Hot Key to wake-up the system by PS2 Keyboard.

The choices: Disabled, Ctrl+F1, Ctrl+F2, Ctrl+F3, Ctrl+F4, Ctrl+F5, Ctrl+F6, Ctrl+F7, Ctrl+F8, Ctrl+F9, Ctrl+F10, Ctrl+F11, Ctrl+F12, Power, Wake, Any key.
Note: Power and Wake are Windows98 Keyboard button.

USB Resume from S3: This item allows you to wake-up the system by USB device when you save the computer power at S3.

The choices: Enabled, Disabled.

PowerOn by PCI Card: An input signal form PME on the PCI card awakens the system from a soft off state.

Wake Up On LAN/Ring: When set to *Enabled*, any event occurring to the Modem Ring / LAN will awaken a system which has been powered down.

RTC Alarm Resume: When set to *Enable rtc alarm resume*, you could set the date (of month) and timer (hh:mm:ss), any event occurring at will awaken a system which has been powered down.

► **IRQs Activity Monitoring**

CMOS Setup Utility - Copyright (C) 1984-2001 Award Software IRQs Activity Monitoring		
		Item Help
Primary INTR	[ON]	
IRQ3 (COM 2)	[Enabled]	
IRQ4 (COM 1)	[Enabled]	
IRQ5 (LPT 2)	[Enabled]	Menu Level >>>
IRQ6 (Floppy Disk)	[Enabled]	
IRQ7 (LPT 1)	[Enabled]	
IRQ8 (RTC Alarm)	[Disabled]	
IRQ9 (IRQ2 Redir)	[Disabled]	
IRQ10 (Reserved)	[Disabled]	
IRQ11 (Reserved)	[Disabled]	
IRQ12 (PS/2 Mouse)	[Enabled]	
IRQ13 (Coprocessor)	[Enabled]	
IRQ14 (Hard Disk)	[Enabled]	
IRQ15 (Reserved)	[Disabled]	

Primary INTR: When set to *On* (default), any event occurring at will awaken a system which has been powered down.

IRQs 3-15: Allows you to set system to monitor IRQs 3-15 for activity to awaken system form a power management mode.

4-6 PNP/PCI Configuration

The PNP/PCI configuration program is for the user to modify the PCI/ISA IRQ signals when various PCI/ISA cards are inserted in the PCI or ISA slots.

WARNING: *Conflicting IRQ's may cause the system to not find certain devices.*

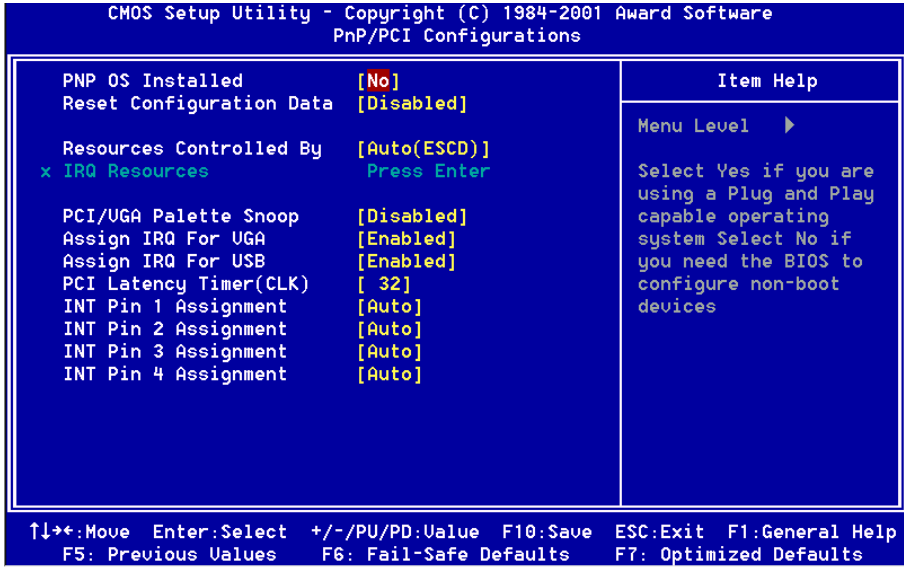

Figure 7: PCI Configuration Setup

PNP OS Installed: Do you have a PNP OS installed on your system. The default is No.

Reset Configuration Data: This setting allows you to clear ESCD data. The default is Disabled

Disabled: Normal Setting.

Enabled: If you have plugged in some Legacy cards to the system and they were recorded into ESCD (Extended System Configuration Data), you can set this field to Enabled in order to clear ESCD.

Resources Controlled By: Who controlled the system PNP/PCI resources. The default is Auto.

Manual: PNP Card’s resources will be controlled manually. You can set which IRQ-X and DMA-X are assigned to PCI/ISA PNP or Legacy ISA Cards.

Auto: If your ISA card and PCI card are all PNP cards, BIOS will assign the interrupt resource automatically.

PCI/VGA Palette Snoop: Leave this field at Disabled.

The choices: Enabled, Disabled.

Assign IRQ For VGA/USB: This item allows BIOS to assign whether IRQ is with VGA/USB or not. If you have not connect the VGA/USB device. Can release the IRQ for other device. The default is Enabled.

Enabled: Provides IRQ for VGA/USB device.

Disabled: Release IRQ for other device.

PCI Latency Timer (CLK): The latency timer defines the minimum amount of time, in PCI clock cycles, that the bus master can retain the ownership of the bus. The Choices: 0-255.

INT Pin1 to Pin4 Assignment: These settings allow the user to specify what IRQ will be assigned to PCI devices in the chosen slot. Options available: Auto,3, 4,5,7,9,10,11,12,14 & 15. The defaults are Auto.

Interrupt request are shared as shown the table below:

	INT A	INT B	INT C	INT D
PCI 1	V			
PCI 2		V		
PCI 3			V	
PCI 4				V
PCI 5			V	
PCI 6				V
AGP Slot	V			
AC97/MC97			V	
Onboard USB1	V			
Onboard USB2		V		
Onboard USB3			V	
USB2.0				V
LAN	V			
RAID (Optional)		V		

IMPORTANT! If using PCI cards on shared slots, make sure that the drivers support “Shared IRQ” or that the cards don’t need IRQ assignments. Conflicts will arise between the two PCI groups that will make the system unstable or cards inoperable.

BIOS

4-7 PC Health Status

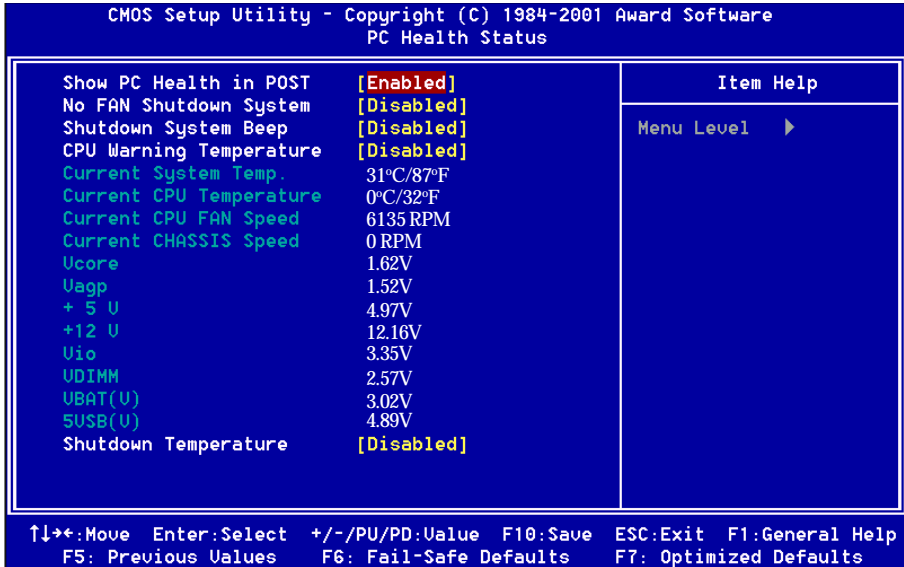

Show PC Health in POST: When enable this function, you can see PC Health in Post screen.

No FAN Shutdown System: When enable this function, the CPU FAN will be checked in POST. If the CPU FAN can't be found, the system will shutdown automatically.

The choices: Enabled, Disabled.

Shutdown System Beep: When enable this function, there will be an warning beep before “No FAN Shutdown System” or “Shutdown System In POST” function active.

The choices: Enabled, Disabled.

CPU Warning Temperature: This is the temperature that the computer will respond to an overheating CPU. The default is Disabled.

The Choices: Disabled, 50°C/122°F, 53°C/127°F, 56°C/133°F, 60°C/140°F, 63°C/145°F, 66°C/151°F, 70°C/158°F.

Current System Temperature: This is the Current temperature of the system.

Current CPU Temperature: This is the Current temperature of the CPU.

Current CPU/Chassis FAN Speed: The current CPU/Chassis fan speed in RPMs.

Vcore: The voltage level of the CPU(Vcore).

Vagp: The voltage level of Power supplied to AGP card.

1.52V: for 4X AGP card.

3.3V : for 2X AGP card.

5V, 12V, VBAT(V), 5VSB(V): The voltage level of the switch power supply.

Vio: The voltage level of the CPU Vio.

VDIMM: The voltage level of the DRAM.

Shutdown Temperature: This is the temperature that the computer will turn off the power to combat the effects of an overheating system. (requires ACPI to be enabled in Power Management BIOS and ACPI compliant operating system.) The default is Disabled.

Options available are 60°C/140°F to 75°C/167°F in increments of 5°C.

4-8 Frequency/Voltage Control

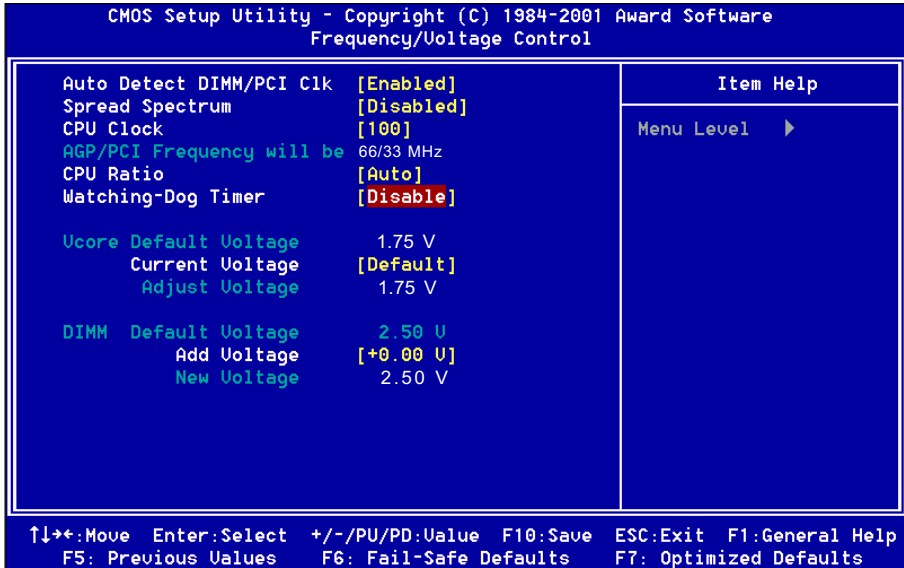

Auto Detect DIMM/PCI Clk: When enabled the motherboard will automatically disable the clock source for a DIMM socket which does not have a module in it. Same applies for PCI slots. This setting will reduce the EMI. The default is Enabled.

Spread Spectrum: This item allows you to enable/disable the spread spectrum modulate.

CPU Clock: The mainboard is designed to set the CPU clock via BIOS. This item allows you to adjust CPU clock 1MHz by step.

Note: Overclocking failure will cause system No display problem. At this moment, please press “Insert” key to back to the initial or default setting to boot up your system.

CPU Ratio: This item allows you to select the CPU ratio. If the CPU ratio is fixed. This item was no function.
The choices: Auto, [x6]...[x15].

Watching-Dog Timer: If you select enabled and overclock fail before POST code 26h, the system will reset automatically by default configuration.

Options: Enabled, Disabled.

Vcore Voltage: This item allows you to set the CPU Vcore Voltage.

Options: Default, 1.400V to 1.850V in 0.025V increments, 1.900V to 2.200V in 0.50V increments. We recommend that you leave this at the default value.

DIMM Voltage: This item allows you to set the DIMM slot Voltage.

Options: +0.00V to +0.70V in 0.1V increments. We recommend that you leave this at the default value.

BIOS

4-9 Defaults Menu

Selecting “Defaults” from the main menu shows you two options which are described below

Load Fail-Safe Defaults

When you press <Enter> on this item you get a confirmation dialog box with a message similar to:

Load Fail-Safe Defaults (Y/N) ? N

Pressing ‘Y’ loads the BIOS default values for the most stable, minimal-performance system operations.

Load Optimized Defaults

When you press <Enter> on this item you get a confirmation dialog box with a message similar to:

Load Optimized Defaults (Y/N) ? N

Pressing ‘Y’ loads the default values that are factory settings for optimal performance system operations.

4-10 Supervisor/User Password Setting

You can set either supervisor or user password, or both of them. The differences between are:

supervisor password : can enter and change the options of the setup menus.

user password : just can only enter but do not have the right to change the options of the setup menus. When you select this function, the following message will appear at the center of the screen to assist you in creating a password.

ENTER PASSWORD:

Type the password, up to eight characters in length, and press <Enter>. The password typed now will clear any previously entered password from CMOS memory. You will be asked to confirm the password. Type the password again and press <Enter>. You may also press <Esc> to abort the selection and not enter a password. To disable a password, just press <Enter> when you are prompted to enter the password. A message will confirm the password will be disabled. Once the password is disabled, the system will boot and you can enter Setup freely.

PASSWORD DISABLED.

When a password has been enabled, you will be prompted to enter it every time you try to enter Setup. This prevents an unauthorized person from changing any part of your system configuration.

Additionally, when a password is enabled, you can also require the BIOS to request a password every time your system is rebooted. This would prevent unauthorized use of your computer.

You determine when the password is required within the BIOS Features Setup Menu and its Security option. If the Security option is set to "System", the password will be required both at boot and at entry to Setup. If set to "Setup", prompting only occurs when trying to enter Setup.

BIOS

4-11 Exit Selecting

Save & Exit Setup

Pressing <Enter> on this item asks for confirmation:

Save to CMOS and EXIT (Y/N)? Y

Pressing “Y” stores the selections made in the menus in CMOS – a special section of memory that stays on after you turn your system off. The next time you boot your computer, the BIOS configures your system according to the Setup selections stored in CMOS. After saving the values the system is restarted again.

Exit Without Saving

Pressing <Enter> on this item asks for confirmation:

Quit without saving (Y/N)? Y

This allows you to exit Setup without storing in CMOS any change. The previous selections remain in effect. This exits the Setup utility and restarts your computer.

Easy Driver Installation



Insert the bundled CD-disk.

- Step 1 :** Click “**SERVICE PACK 4IN1 DRIVER**”. Install all components recommended.
- Step 2 :** Click “**AC'97 ALC201A/650 AUDIO DRIVER**” to install Audio Driver.
- Step 3 :** Click “**VIA 6105/6103 LAN DRIVER**” to install LAN driver.
- Step 4 :** Click “**IDE BUS MASTER**” to install BusMaster PCI IDE.
(For performance only).
- Step 5 :** Click “**USB DRIVER**” or “**USB 2.0 DRIVER**” to install USB Driver.
- Note :** If you install the “**HIGH POINT 374**” Driver, please install the driver from 3.5 floppy. (Optional)
The “**RAID ADMINISTRATOR**” item is for install Raid Administrator. (Optional)

Drivers Installation

ALC650 Configuration Setup (6 Channel)

- ◆ To enable ALC650 Function

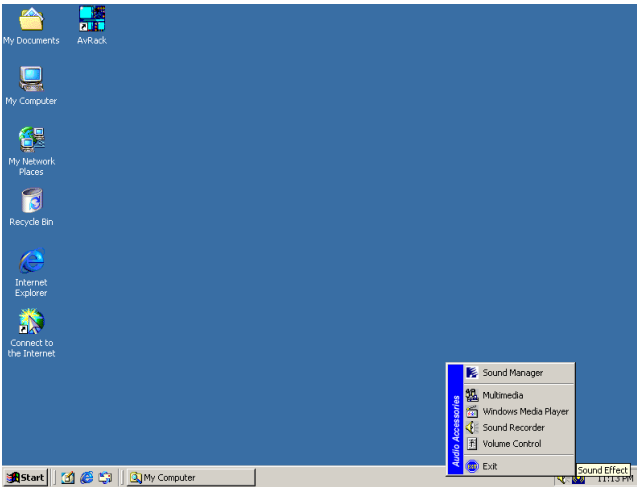

<Figure 1>

1. Right-click **Sound Effect** button in the tool bar display currently selected Titles. Select **Sound Manager**.

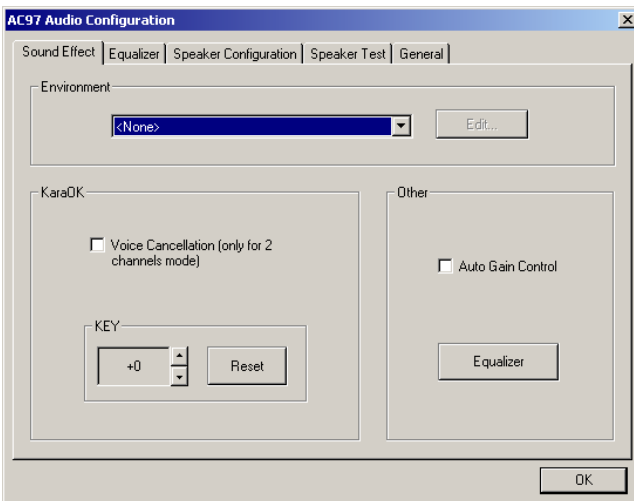

Sound Effect:

<Figure 2>

2. Click **Sound Effect** button and select **Environment** from the drop-down menu.

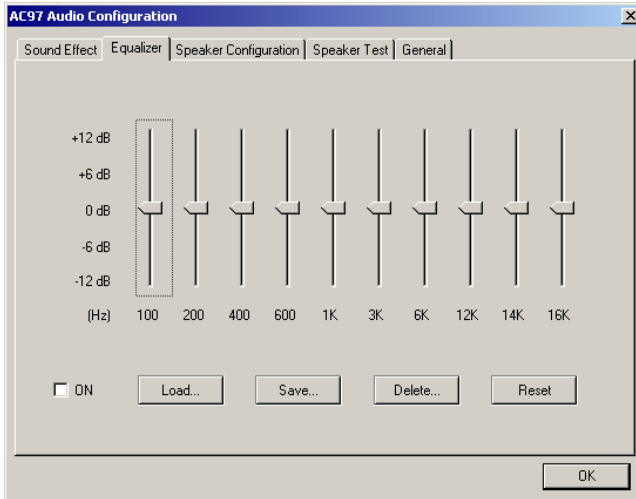

Equalizer:

<Figure 3>

3. Click **Equalizer** and setup the value of dB.

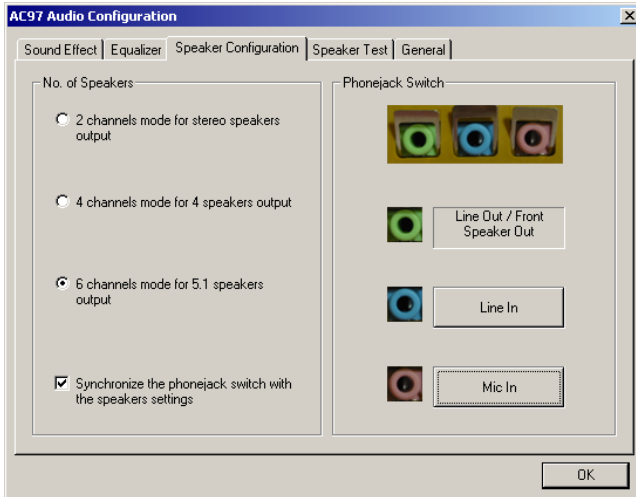

Speak Configuration:

<Figure 4>

4. Click **Line in** and **Mic in** buttons to enable 6 channel function as this is required for the ALC650.

Drivers Installation

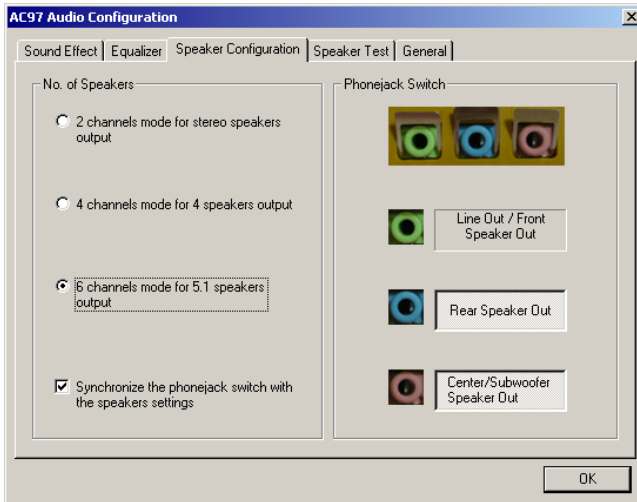

Speak Configuration:

<Figure 5>

5. The selected screen appears.

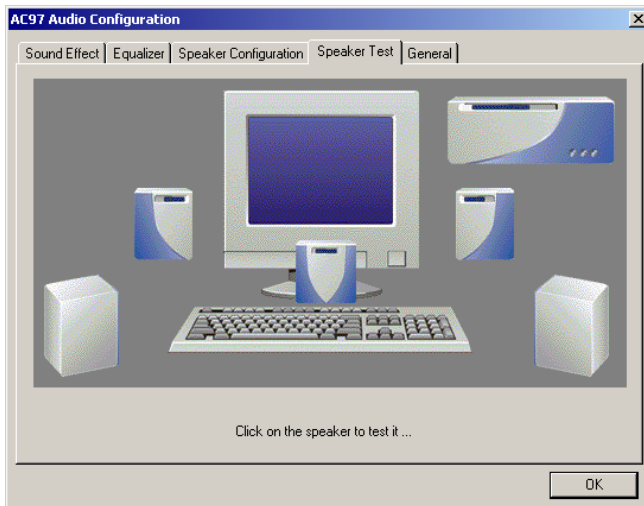

Speaker Test:

<Figure 6>

6. Click **Speaker Test** button and click on the speakers directly which show on the screen to test it.

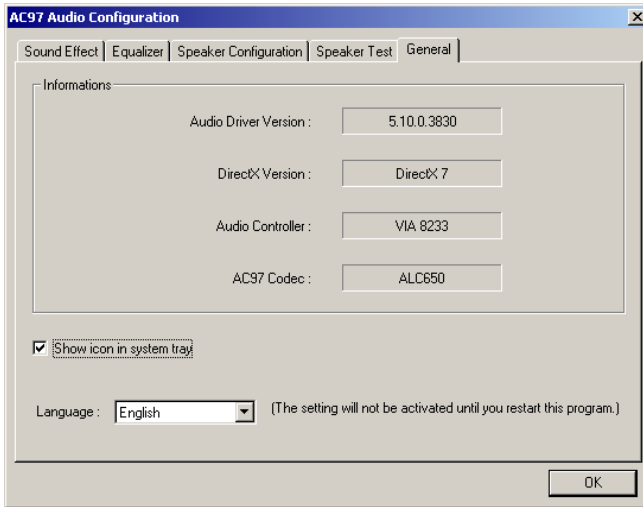

General:

<Figure 7>

7. General Information for user reference.

A-1 Avance® Media Player User's Guide

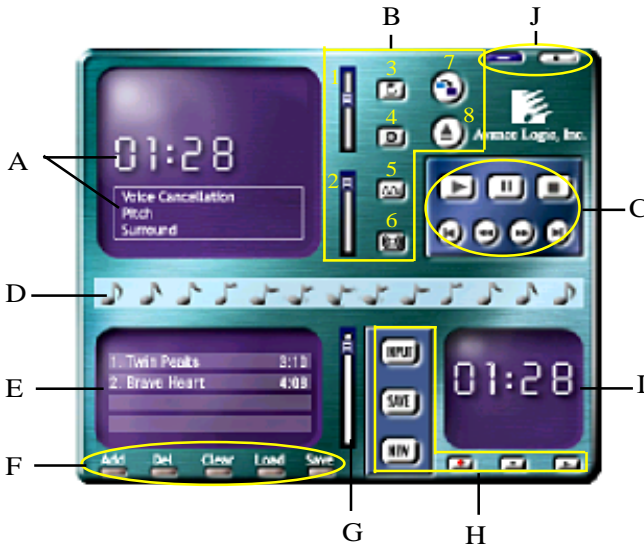
Avance® Media Player Platform**Functional Descriptions****A. Playback Windows Display**

Playback windows displays the following mode information:

1. Playback Time Display
2. Voice Cancellation Mode Display
3. Pitch Mode Display
4. Surround Sound Mode Display

B. Playback Function Controls

There are 8 selectable functions for the playback:

1. Volume control High/Low Adjustment Bar.
2. Pitch control 4-step High/Low Adjustment Bar.

Appendix

- 3. Repeat mode Choice of Repeat, All Repeat, Random or No Repeat Mode.
- 4. Mute Mute On/Off Mode select.
- 5. Voice cancellation Voice Cancellation On/Off Mode select for Karaoke.
- 6. Surround mode A total of 26 Surround Sound mode select as shown in the table below.

Surround mode	Surround mode
Generic	Stone corridor
Padded	Alley
Room	Forrest
Bathroom	City
Living room	Mountain
Stone	Quarry
Auditorium	Plain
Concert	Parking lot
Cave	Sewer pipe
Arena	Under water
Hangar	Drug
Carpet	Dizzy
Hallway	Psychological

- 7. Skin change Media Player Skin Type select.
- 8. Open Open file formats including MP3, CDA, MDI, WAV & WMA support.

C. Playback Controls

The playback controls include “Play”, “Pause”, “Stop”, “Previous”, “Backward”, “Forward”, & “Next”.

D. Seeking bar

Display Animated Playback Status

E. Title/Play List Windows

Display Currently Selected Title(s)

F. Title/Play List Edit Controls

There title/play list controls include “Add”, “Del”, “Clear”, “Load”, & “Store”.

1. Add Add to the Title/Play List.
2. Del Remove form the Title/Play List.
3. Clear Clear the Title/Play Lost.
4. Load Load Title/Play List.
5. Store Save Title/Play List.

G. Title/Play List Scroll bar

Scroll Up/Down the Title/Play List.

H. Recording Function Controls

The recording function controls include “Input”, “Save:”, “New”, “Rec”, “Stop”, & “Play”.

1. Input Input soruce select.
2. Save Save to file.
3. New Open new file & select format includes Sampling Rate, Sampling bit, Mono or Stereo.
4. Rec Start Rec.
5. Stop Stop Rec.
6. Play Playback Rec file.

I. REC/Playback Time Display

Displays REC/Playback Time.

J. Platform Display Panel Controls

The platform display panel control include “Minimize” & “Close”.

1. Minimize Minimize Platform Display Panel.
2. Close Close/Exit Platform Display Panel.

B-1 Update Your System BIOS

Download the xxxxx.EXE file corresponding to your model form the our website to an empty directory on your hard disk or floppy. Run the downloaded xxxxx.EXE file and it will self extract. Copy these extracted files to a bootable DOS floppy disk.

Note: The DOS floppy disk should contain NO device drivers or other programs.

1. Type "A:\AWDFLASH and press <Enter> Key.
2. You will see the following setup on screen.
3. Please key in the xxxxx.bin BIOS file name.

```
FLASH MEMORY WRITER V7.88
(C)Award Software 2000 All Rights Reserved

For xxxx-W83627-6A69LPA9C-0  DATE: 05/11/2000
Flash Type -
File Name to Program : _____

Error Message:
```

4. If you want to save the previous BIOS data to the diskette, please key in [Y], otherwise please key in [N].

```
FLASH MEMORY WRITER V7.88
(C)Award Software 2000 All Rights Reserved

For xxxx-W83627-6A69LPA9C-0  DATE: 05/11/2000
Flash Type - xxxxx E82802AB /3.3V
File Name to Program : xxxxx.bin

Error Message: Do You Want To Save Bios (Y/N)
```

Appendix

5. Key in File Name to save previous BIOS to file.

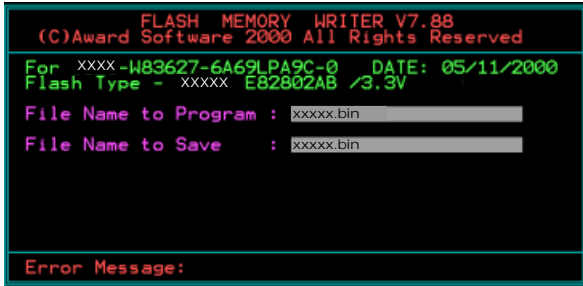

6. Are you sure to program (y/n), please key in [Y] to start the programming.



7. The programming is finished.

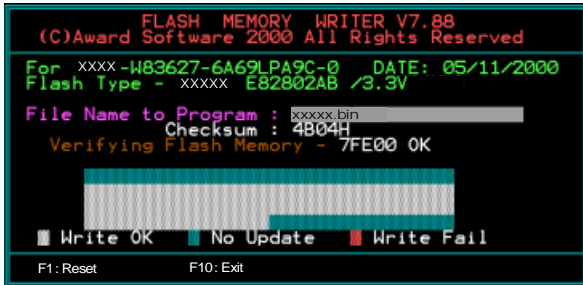

C-1 EEPROM BIOS Remover

Do not remove the BIOS chip, unless instructed by a technician and only with a PLCC IC extractor tool.

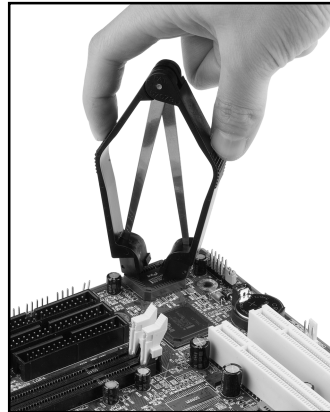
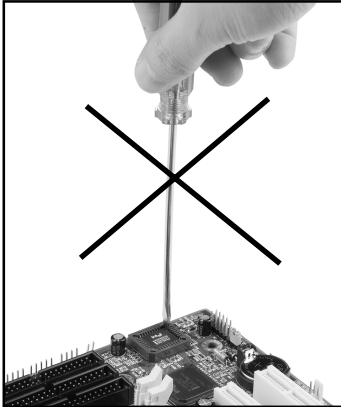

The BIOS socket may be damaged if using an improper method to replace the BIOS chip.

D-1 GHOST 7 Quick User's Guide (Optional)

Installation is very easy. You only need to copy the **Ghost7** folder or **Ghost.exe** to your hard disk.

Main Menu



Description of Menu

Ghost clones and backs up **Disk** and **Partition**.

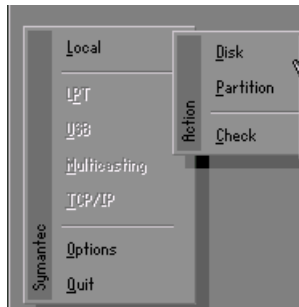

In which **Disk** indicates hard disk options
Partition indicates partition options
Check indicates check options

Appendix

Disk

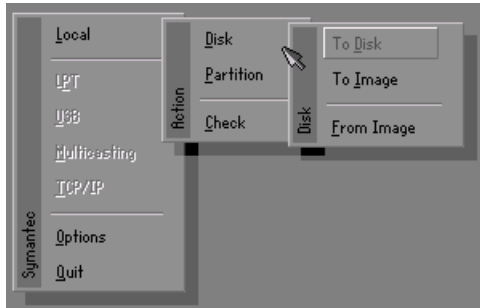

There are 3 hard disk functions:

1. Disk To Disk (disk cloning)
2. Disk To Image (disk backup)
3. Disk From Image (restore backup)

Important!

1. To use this function, the system must have at least 2 disks. Press the **Tab** key to move the cursor.
2. When restoring to a destination disk, all data in that disk will be completely destroyed.

Disk To Disk (Disk Cloning)

1. Select the location of the **Source drive**.
2. Select the location of the **Destination drive**.

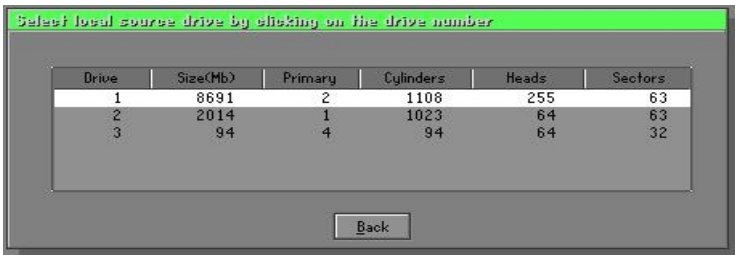

- When cloning a disk or restoring the backup, set the required partition size as shown in the following figure.

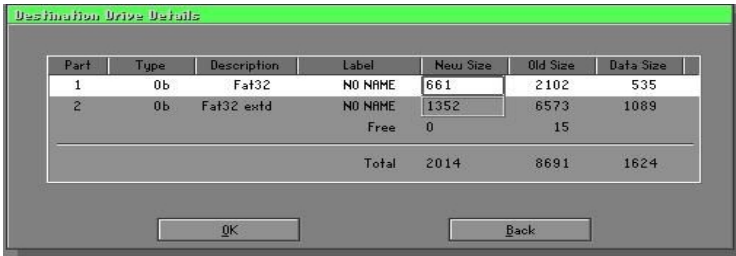

- Click OK to display the following confirmation screen. Select **Yes** to start.

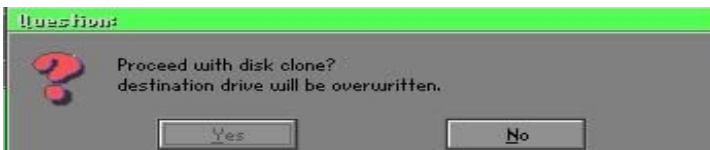

Disk To Image (Disk Backup)

- Select the location of the Source drive.

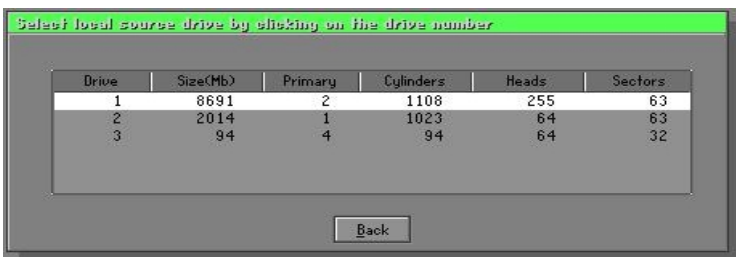

Appendix

2. Select the location for storing the backup file.

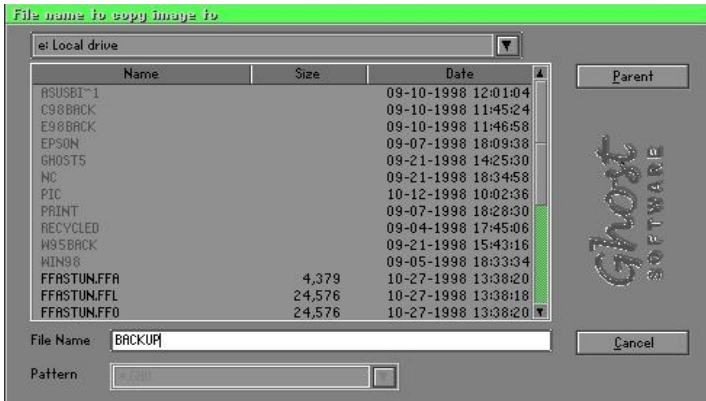

3. Click **OK** to display the following confirmation screen. Select **Yes** to start.



Disk From Image (Restore Backup)

1. Select the Restoring file.

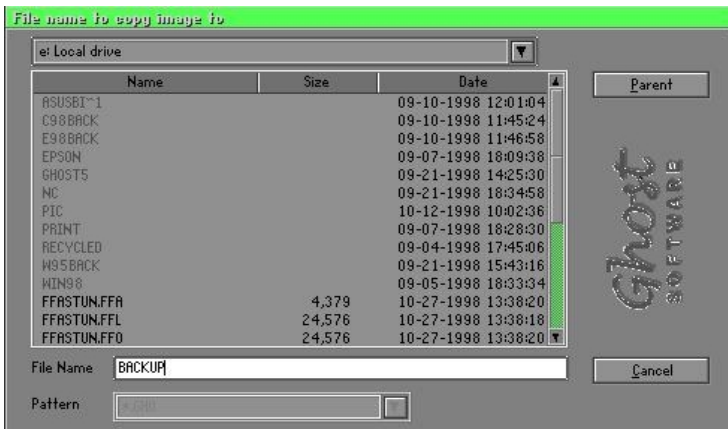

2. Select the **Destination drive** of the disk to be restored.

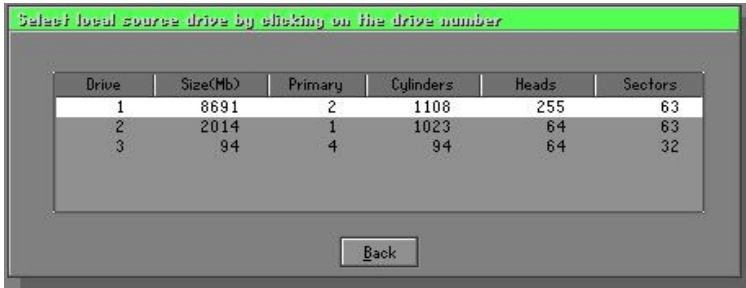

3. When restoring disk backup, set the required partition size as shown in the following figure.



4. Click **OK** to display the following confirmation screen. Select **Yes** to start.

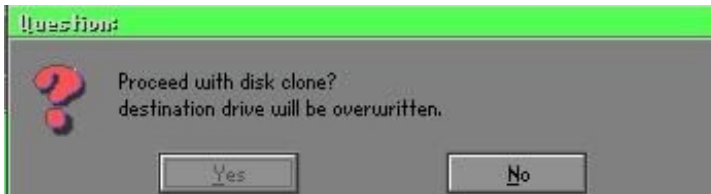

Partition

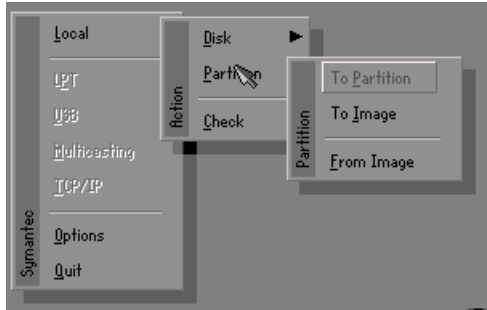

There are 3 partition functions:

1. **Partition To Partition** (partition cloning)
2. **Partition To Image** (partition backup)
3. **Partition From Image** (restore partition)

Partition To Partition (Partition Cloning)

The basic unit for partition cloning is a “partition”. Refer to “disk cloning” for the operating method.

Partition To Image (Partition Backup)

1. Select the disk to be backed up.

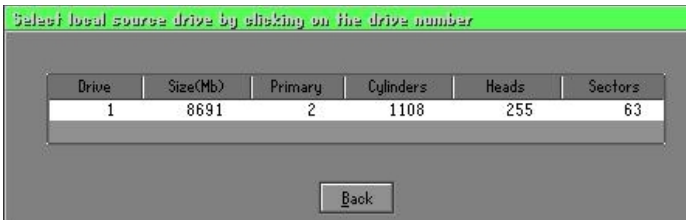

2. Select the first partition to be backed up. This is usually where the operating system and programs are stored.



3. Select the path and file name to store the backup file.

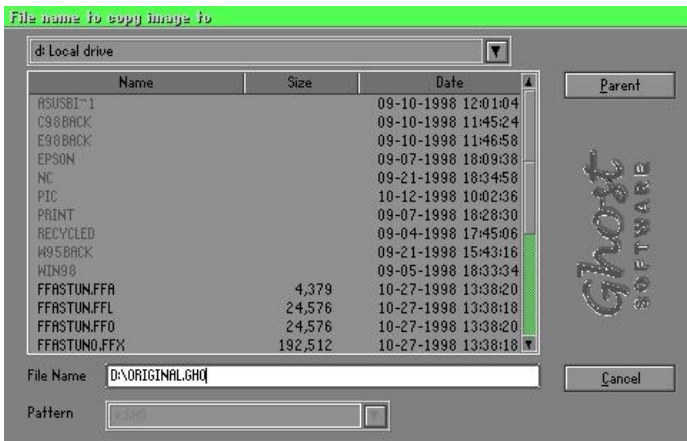

4. Is the file compressed? There are 3 options:
 - (1) No: do not compress data during backup
 - (2) Fast: Small volume compression
 - (3) High: high ratio compression. File can be compressed to its minimum, but requiring longer execution time.

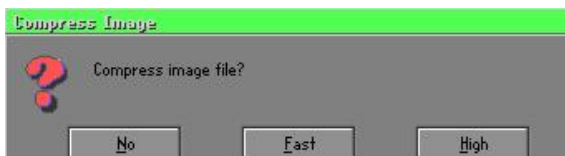

Appendix

5. Select Yes to start performing backup.

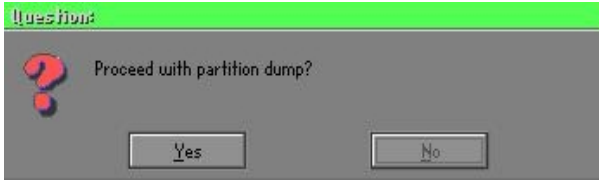

Partition From Image (Restore Partition)

1. Select the backup file to be restored.

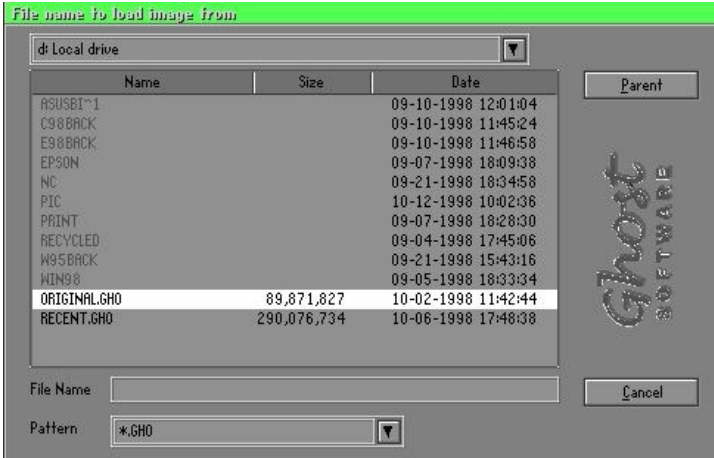

2. Select the source partition.

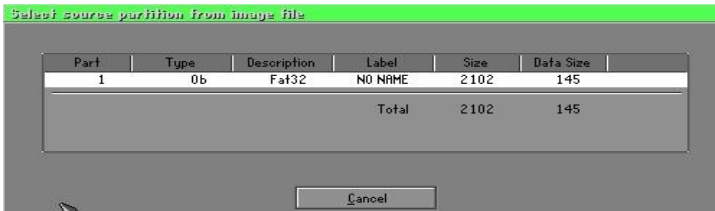

3. Select the disk to be restored.



4. Select the partition to be restored.



5. Select Yes to start restoring.

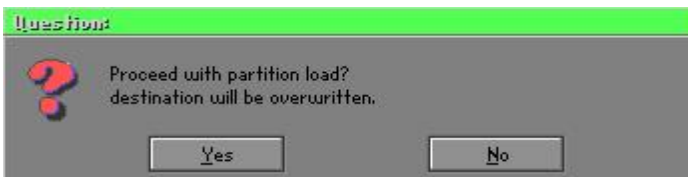

Check

This function is to check possible error caused by defective FAT or track during backup or restoring.

How to Reinstall Windows in 2 Minutes

This chapter guides you how to setup your computer properly and, if necessary, reinstall Windows in 2 minutes. Ghost provides different methods to complete this task. The following two sections explain how to create an emergency Recover Floppy and Recover CD:

Emergency Recover Floppy

Divide a hard disk into two partitions. The first partition is to store the operating system and application programs. The second partition is to back up the operating system and data. The size of the partition can be determined according to the backup requirements. For example, the **Windows** operating system needs 200MB of hard disk space, Plus complete **Office** programs require 360MB. The remaining space can be used to store data.

After installing **Windows**, use **Ghost** to create a backup area for the system and to store the file (Image file) in drive D. The file is named **Original.gho**. Then, create a recover floppy disk containing:

- ◆ Bootable files (Command.com, Io.sys, and MSDOS.SYS)
- ◆ Config.sys (configuration setup file)
- ◆ Autoexec.bat (auto-execution batch file)
- ◆ Ghost.exe (Ghost execution file)

There are two ways to create the content of the recover floppy for restoring:

- (1) To load **Windows** automatically after booting, store the **Autoexec.bat** file with a command line:

```
Ghost.exe clone, mode=pload, src=d:\original.gho:2,dst=1:1 -fx -sure -rb
```

Command Description: Runs the restore function automatically with the Image File. Stored in drive D. After execution, it will exit Ghost and boots the system.

Refer to the [Introducing Ghosts Functions] for details.

- (2) After booting, the screen displays the Menu. Select Backup or Restore: Since the user may install other applications in the future, he/she may alter **Autoexec.bat** file to back up or restore the user-defined Image file as follows:

Backup

Back up Windows and application programs as a file (Recent.gho). Command is:

```
Ghost -clone,mode=pdump,src=1:1,dst=d:\Recent.gho -fx -sure -rb
```

Restore

Restore types include [**General Windows**] and [**Windows and Application Programs**]. If you select [**General Windows**], the system is restored to the general **Windows** operation condition. The command is:

```
Ghost.exe -clone,mode=pload,src=d:\Original.gho,dst=1:1 -fx -sure -rb
```

If you select [**Windows and Application Programs**], the latest backup file (Recent.gho) is restored, skipping the installation and setup of application programs.

For description of related parameters, refer to [**Introducing Ghosts Functions**].

For more information about menu design, refer to Config.sys and Autoexec.bat under /Menu in the CD. You can also create a backup CD containing Ghost.exe and these two files.

Recover CD

The following is a simple guide to create a recover CD:

1. First, create a recover floppy disk contains the following with any copy program such as “Easy CD Create” (Note 2) :

Bootable files (Command.com and Io.sys and MSDOS.SYS)

Config.sys (Configuration setup file)

Autoexec.bat (Auto-execution batch file)

Mscdex.exe (CD-Rom execution file)

Ghost.exe (Ghost execution file)

Oakcdrom.sys (ATAPI CD-ROM compatible driver)

The content of Config.sys is:

```
DEVICE=Oakcdrom.sys /d:idecd001
```

The content of Autoexec.bat includes:

```
MSCDEX.EXE /D:IDECD001 /L:Z
```

```
Ghost.exe clone,mode=load,src=z:\original.gho,dst=1 -sure -rb
```

2. Write the backup image file (original.gho) of the entire hard disk or partition into the recover CD. Use the Recover CD to boot up the system and restore the backup files automatically.

For description of related parameters, refer to **[Introducing Ghosts Functions]**.

Note: For more details about copy the creation program and method to create a recover CD, please refer to the related software and its associated operating manual.

Ghost Command Line Switches Reference

Ghost may be executed in interactive or in batch mode. Most of the Ghost switches are used to assist in batch mode operation. To list switches, type ghost.exe -h.

-clone

The full syntax for this switch is:

```
clone,MODE={copy|load|dump|pcopy|pload|pdump},SRC=
{drive|file|drive:partition|,DST={drive|file|drive:partition},SZE{F|L|n=
{nnnnM|nnP|F|V}}
```

Clone using arguments. This is the most useful of the batch switches and has a series of arguments that define:

- a) **MODE** Defines the type of clone command, can be:
- COPY** disk to disk copy
 - LOAD** file to disk load
 - DUMP** disk to file dump
 - PCOPY** partition to partition copy
 - PLOAD** file to partition load
 - PDUMP** partition to file dump
- b) **SRC** Defines the source location of the command:
- | Mode | Meaning: |
|---------------|---|
| COPY/ | |
| DUMP | Source drive (e.g, 1 for drive one) |
| LOAD | Disk image filename or device (e.g, g:\Images\system2.img) |
| PCOPY/ | |
| PDUMP | Source partition e.g, 1:2 indicates the second partition on drive one. |
| PLOAD | Partition image filename or device and partition number. Example: g:\images\disk1.img:2 indicates the second partition in the Image file. |

Appendix

c) DST	This defines the destination location for the operation:
Mode	Meaning
COPY/	
LOAD	Destination drive (e.g, 2 for drive two)
DUMP	Disk image filename or device,(e.g, g:\images\system2.img)
PCOPY/	
PLOAD	Destination partition,(e.g, 2:2 indicates the second partition on drive two).
PDUMP	Partition image filename (e.g, g:\images\part1.img).
d) SZEy	Partition size to be transferred.

Available Options:

- F** Resizes the first partition to maximum size allowed based on file system type.
- L** Resizes the last partition to maximum size allowed based on file system type.
- n=xxxxM** - indicates that the nth destination partition is set to have a size of xxxx Mb. (e.g, SZE2=800M indicates partition two is to have 800 mb.) **n=mmP** indicates the destination partition is set to have a size of mm percent of the target disk.
- n=F** - indicates the destination partition is remaining fixed size.
- n=V** - Indicates that the partition will be resized according to the following rules:

Rule 1 - If the destination disk is larger than the original source disk, then the partition(s) will be expanded to have the maximum amount of space subject to the free space available and the partition type (e.g, FAT16 partitions will have a maximum size of 2048Mb.)

Rule 2 - If the destination disk is smaller than the original source disk, (but still large enough to accommodate the data from the source disk), the free space left over after the data space has been satisfied will be distributed between the

destination partitions in proportion to the data usage in the source partitions. Some examples follow that will help illustrate:

- fx flag Exit. Normally when Ghost has finished copying a new system to a disk, it prompts the user to reboot with a press Ctrl-Alt-Del to reboot window. However, if Ghost is being run as part of a batch file it is sometimes useful to have it just exist back to the DOS prompt after completion so that further batch commands may be processed. -fx enables this. See -rb for another option on completing a clone.
- ia Image All. The Image All switch forces Ghost to do a sector by sector copy of all partitions. When copying a partition from a disk to an image file or to another disk, Ghost examines the source partition and decides whether to copy just the files and directory structure, or to do an image (sector by sector) copy. If it understands the internal format of the partition it defaults to copying the files and directory structure. Generally this is the best option, but occasionally if a disk has been set up with special hidden security files that are in specific positions on the partition, the only way to reproduce them accurately on the target partition is via an image or sector-by-sector copy.
- span enables spanning across volumes.
- split=x splits image file into 'x' Mb? Mb spans. Use this to create a 'forced' size volume set. For example, if you would like to force smaller image files from a 1024 Megabyte drive, you could specify 200 megabyte segments. For example, ghost.exe -split=200 will divide the image into 200 Megabyte segments.
- sure use the -sure switch in conjunction with -clone to avoid being prompted with the final 'Proceed with disk clone destination drive will be overwritten?'. This command is useful in batch mode.

Appendix

Example 1:

To copy drive one to drive two on a PC, without final prompt if OK to proceed.

```
ghost.exe -clone,mode=copy,src=1,dst=2 -sure
```

Example 2:

To connect via NetBIOS to another PC running Ghost in slave mode, and dump a disk image of local drive two to the remote file c:\drive2.gho

```
ghost.exe -clone,mode=dump,src=2,dst=C:\drive2.gho -nbm
```

Note: The slave Ghost can start with ghost -nbs command

Example 3:

To copy drive one of second partition from a PC to drive two of first of the same PC,

```
ghost.exe -clone,mode=pcopy,src=1:2,dst=2:1 -sure
```

Example 4:

To dump the second partition of drive one to an image file on a mapped drive g:

```
ghost.exe -clone,mode=pdump,src=1:2,dst=g:\part2.gho
```

Example 5:

To load partition 2 from a two-partition image file on a mapped drive g: onto the second partition of the local disk

```
ghost -clone,mode=pload,src=g:\part2.gho:2,dst=1:2
```

Example 6:

To load drive 2 from an image file and resize the destination partitions into a 20:40 allocation

```
ghost.exe -clone,mode=load,src=g:\2prtdisk.gho,dst=2,size1=60P,  
size2=40P
```

E-1 POST CODES (Optional)

<u>POST (hex)</u>	<u>DESCRIPTION</u>
CFh	Test CMOS R/W functionality.
C0h	Early chipset initialization: <ul style="list-style-type: none">- Disable shadow RAM- Disable L2 cache (socket 7 or below)- Program basic chipset registers
C1h	Detect memory <ul style="list-style-type: none">- Auto-detection of DRAM size, type and ECC.- Auto-detection of L2 cache (socket 7 or below)
C3h	Expand compressed BIOS code to DRAM
C5h	Call chipset hook to copy BIOS back to E000 & F000 shadow RAM.
0h1	Expand the Xgroup codes locating in physical address 1000:0
02h	Reserved
03h	Initial Superio_Early_Init switch.
04h	Reserved
05h	<ol style="list-style-type: none">1. Blank out screen2. Clear CMOS error flag
06h	Reserved
07h	<ol style="list-style-type: none">1. Clear 8042 interface2. Initialize 8042 self-test
08h	<ol style="list-style-type: none">1. Test special keyboard controller for Winbond 977 series Super I/O chips.2. Enable keyboard interface.
09h	Reserved
0Ah	<ol style="list-style-type: none">1. Disable PS/2 mouse interface (optional).2. Auto detect ports for keyboard & mouse followed by a port & interface swap (optional).3. Reset keyboard for Winbond 977 series Super I/O chips.
0B-0Dh	Reserved

Appendix

0Eh	Test F000h segment shadow to see whether it is R/W-able or not. If test fails, keep beeping the speaker.
0Fh	Reserved
10h	Auto detect flash type to load appropriate flash R/W codes into the run time area in F000 for ESCD & DMI support.
11h	Reserved
12h	Use walking 1's algorithm to check out interface in CMOS circuitry. Also set real-time clock power status, and then check for override.
13h	Reserved
14h	Program chipset default values into chipset. Chipset default values are MODBINable by OEM customers.
15h	Reserved
16h	Initial Early_Init_Onboard_Generator switch.
17h	Reserved
18h	Detect CPU information including brand, SMI type (Cyrix or Intel) and CPU level (586 or 686).
19-1Ah	Reserved
1Bh	Initial interrupts vector table. If no special specified, all H/W interrupts are directed to SPURIOUS_INT_HDLR & S/W interrupts to SPURIOUS_soft_HDLR.
1Ch	Reserved
1Dh	Initial EARLY_PM_INIT switch.
1Eh	Reserved
1Fh	Load keyboard matrix (notebook platform)
20h	Reserved
21h	HPM initialization (notebook platform)
22h	Reserved
23h	<ol style="list-style-type: none">1. Check validity of RTC value: e.g. a value of 5Ah is an invalid value for RTC minute.2. Load CMOS settings into BIOS stack. If CMOS checksum fails, use default value instead.3. Prepare BIOS resource map for PCI & PnP use. If ESCD is valid, take into consideration of the ESCD's legacy information.

	<ol style="list-style-type: none">Onboard clock generator initialization. Disable respective clock resource to empty PCI & DIMM slots.Early PCI initialization:<ul style="list-style-type: none">-Enumerate PCI bus number-Assign memory & I/O resource-Search for a valid VGA device & VGA BIOS, and put it into C000:0.
24-26h	Reserved
27h	Initialize INT 09 buffer
28h	Reserved
29h	<ol style="list-style-type: none">Program CPU internal MTRR (P6 & PII) for 0-640K memory address.Initialize the APIC for Pentium class CPU.Program early chipset according to CMOS setup. Example: onboard IDE controller.Measure CPU speed.Invoke video BIOS.
2A-2Ch	Reserved
2Dh	<ol style="list-style-type: none">Initialize multi-languagePut information on screen display, including Award title, CPU type, CPU speed
2E-32h	Reserved
33h	Reset keyboard except Winbond 977 series Super I/O chips.
34-3Bh	Reserved
3Ch	Test 8254
3Dh	Reserved
3Eh	Test 8259 interrupt mask bits for channel 1.
3Fh	Reserved
40h	Test 8259 interrupt mask bits for channel 2.
41h	Reserved
42h	Reserved
43h	Test 8259 functionality.
44h	Reserved
45-46h	Reserved
47h	Initialize EISA slot

Appendix

48h	Reserved
49h	<ol style="list-style-type: none">1. Calculate total memory by testing the last double word of each 64K page.2. Program writes allocation for AMD K5 CPU.
4A-4Dh	Reserved
4Eh	<ol style="list-style-type: none">1. Program MTRR of M1 CPU2. Initialize L2 cache for P6 class CPU & program CPU with proper cacheable range.3. Initialize the APIC for P6 class CPU.4. On MP platform, adjust the cacheable range to smaller one in case the cacheable ranges between each CPU are not identical.
4Fh	Reserved
50h	Initialize USB
51h	Reserved
52h	Test all memory (clear all extended memory to 0)
53-54h	Reserved
55h	Display number of processors (multi-processor platform)
56h	Reserved
57h	<ol style="list-style-type: none">1. Display PnP logo2. Early ISA PnP initialization -Assign CSN to every ISA PnP device.
58h	Reserved
59h	Initialize the combined Trend Anti-Virus code.
5Ah	Reserved
5Bh	(Optional Feature) Show message for entering AWDFLASH. EXE from FDD (optional)
5Ch	Reserved
5Dh	<ol style="list-style-type: none">1. Initialize Init_Onboard_Super_IO switch.2. Initialize Init_Onboard_AUDIO switch.
5E-5Fh	Reserved
60h	Okay to enter Setup utility; i.e. not until this POST stage can users enter the CMOS setup utility.
61-64h	Reserved
65h	Initialize PS/2 Mouse

66h	Reserved
67h	Prepare memory size information for function call: INT 15h ax=E820h
68h	Reserved
69h	Turn on L2 cache
6Ah	Reserved
6Bh	Program chipset registers according to items described in Setup & Auto-configuration table.
6Ch	Reserved
6Dh	<ol style="list-style-type: none">1. Assign resources to all ISA PnP devices.2. Auto assign ports to onboard COM ports if the corresponding item in Setup is set to "AUTO".
6Eh	Reserved
6Fh	<ol style="list-style-type: none">1. Initialize floppy controller2. Set up floppy related fields in 40:hardware.
70-72h	Reserved
73h	(Optional Feature) Enter AWDFLASH.EXE if : -AWDFLASH is found in floppy drive. -ALT+F2 is pressed
74h	Reserved
75h	Detect & install all IDE devices: HDD, LS120, ZIP, CDROM.....
76h	Reserved
77h	Detect serial ports & parallel ports.
78h	Reserved
79h	Reserved
7Ah	Detect & install co-processor
7B-7Eh	Reserved
7Fh	<ol style="list-style-type: none">1. Switch back to text mode if full screen logo is supported. -If errors occur, report errors & wait for keys -If no errors occur or F1 key is pressed to continue:<ul style="list-style-type: none">◆ Clear EPA or customization logo.
80h	Reserved
81h	Reserved
82h	<ol style="list-style-type: none">1. Call chipset power management hook.2. Recover the text fond used by EPA logo (not for full

Appendix

	screen logo)
	3. If password is set, ask for password.
83h	Save all data in stack back to CMOS
84h	Initialize ISA PnP boot devices
85h	<ol style="list-style-type: none">1. USB final Initialization2. NET PC: Build SYSID structure3. Switch screen back to text mode4. Set up ACPI table at top of memory.5. Invoke ISA adapter ROMs6. Assign IRQs to PCI devices7. Initialize APM8. Clear noise of IRQs.
86-92h	Reserved
93h	Read HDD boot sector information for Trend Anti-Virus code
94h	<ol style="list-style-type: none">1. Enable L2 cache2. Program boot up speed3. Chipset final initialization.4. Power management final initialization5. Clear screen & display summary table6. Program K6 write allocation7. Program P6 class write combining
95h	<ol style="list-style-type: none">1. Program daylight saving2. Update keyboard LED & typematic rate
96h	<ol style="list-style-type: none">1. Build MP table2. Build & update ESCD3. Set CMOS century to 20h or 19h4. Load CMOS time into DOS timer tick5. Build MSIRQ routing table.
FFh	Boot attempt (INT 19h)