



# EP-3WDF/ 3WEF

A Socket 370 Processor based Intel  
810 Series Chipset mainboard

## **TRADEMARK**

All products and company names are trademarks or registered trademarks of their respective holders.

*These specifications are subject to change without notice.*

*Manual Revision 1.0  
March 31, 2000*

## **User Notice**

No part of this product, including the product and software may be reproduced, transmitted, transcribed, stored in a retrieval system, or translated into any language in any form without the express written permission of EPoX Computer Company (hereinafter referred to as EPoX) except for documentation kept by the purchaser for backup purposes.

We provide this manual “as is” without warranty of any kind, either expressed or implied, including but not limited to the implied warranties or conditions of merchantability or fitness for a particular purpose. In no event shall EPoX be liable for any loss of profits, loss of business, loss of use or data, interruption of business or for indirect, special incidental, or consequential damages of any kind, even if EPoX has been advised of the possibility of such damages arising from any defect or error in the manual or product. EPoX may revise this manual from time to time without notice. For updated BIOS, drivers, or product release information you may visit our websites at <http://www.epox.com> or <http://www.epox.com.tw>.

Products mentioned in this manual are mentioned for identification purposes only. Product names appearing in this manual may or may not be registered trademarks or copyrights of their respective companies. **The product name and revision number are both printed on the mainboard itself.**

## **Handling Procedures**

Static electricity can severely damage your equipment. Handle the EP-3WDF/3WEF and any other device in your system with extreme care and avoid unnecessary contact with system components on the mainboard. Always work on an antistatic surface to avoid possible damage to the mainboard from static discharge. Always have the power supply unplugged and powered off when inserting and removing devices within the computer chassis. EPoX assumes no responsibility for any damage to the EP-3WDF/3WEF mainboard that results from failure to follow instruction or failure to observe safety precautions.



### **CAUTION**



**The EP-3WDF/3WEF mainboard is subject to damage by static electricity. Always observe the handling procedures.**

---

## **EP-3WDF/3WEF**

---

### **Technical Support Services**

If you need additional information, help during installation or normal use of this product, please contact your retailer. Your retailer will have the most current information about your configuration. If your retailer cannot help, you may visit our online technical support website and/or contact our support technicians at the locations listed below.

Record your serial number before installing your EP-3WDF/3WEF mainboard. (The serial number is located near the PCI slots at the edge of the board.)

**EP-3WDF/3WEF serial number:** \_\_\_\_\_

### **Contacting Technical Support**

EPoX technical support is working hard to answer all of your questions online. From our website you can find answers to many common questions, drivers, BIOS updates, tech notes, and important technical bulletins. If you are still unable to locate the solution you are seeking, you always have the option to contact our support technicians directly.

#### **North American website (English language)**

<http://www.epox.com>

[sales@epox.com](mailto:sales@epox.com)

[support@epox.com](mailto:support@epox.com)

#### **European website (Multi-language)**

<http://www.epox.nl>

[sales@epox.nl](mailto:sales@epox.nl)

[support@epox.nl](mailto:support@epox.nl)

#### **Taiwan website (Chinese language)**

<http://www.epox.com.tw>

[sales@epox.com.tw](mailto:sales@epox.com.tw)

[support@epox.com.tw](mailto:support@epox.com.tw)

*Thank you for using EPoX mainboards!*

*Copyright 2000 EPoX Computer Company. All rights reserved.*

---

---

**Table of Contents**

---

	<i>Page</i>
<b><i>Section 1</i></b>	<b><i>Introduction</i></b>
	Components Checklist ..... 1-1
	<b><i>Overview</i></b>
	Intel Celeron processors, the plastic pin grid array (P.P.G.A.) 370 ..... 1-2
	The plastic pin grid array (P.P.G.A.) 370 processor .
	Installation and Removal ..... 1-3
	Intel® 810 Series Chipset Feature ..... 1-4
	EP-3WDF/3WEF Form-Factor ..... 1-6
	I/O Shield Connector ..... 1-7
	Power-On/Off (Remote) ..... 1-7
	System Block Diagram ..... 1-8
<b><i>Section 2</i></b>	<b><i>Features</i></b>
	EP-3WDF/3WEF Features ..... 2-1
<b><i>Section 3</i></b>	<b><i>Installation</i></b>
	EP-3WDF/3WEF Detailed Layout ..... 3-2
	<b><i>Easy Installation Procedure</i></b>
	CPU Insertion ..... 3-3
	Jumper Settings ..... 3-5
	System Memory Configuration ..... 3-6
	Device Connectors ..... 3-8
	Keyboard Power ON Function (KBPO) ..... 3-11
<b><i>Section 4</i></b>	<b><i>Award BIOS Setup</i></b>
	Main Menu ..... 4-1
	Standard CMOS Setup ..... 4-3
	Advanced BIOS Features ..... 4-7
	Advanced Chipset Features ..... 4-10
	Integrated Peripherals ..... 4-13
	Power Management Setup ..... 4-18

---

PNP/PCI Configuration Setup ..... 4-21  
PC Health Status ..... 4-22  
Frequency/Voltage Control ..... 4-24  
Defaults Menu ..... 4-25  
Supervisor/User Password Setting ..... 4-26  
Exit Selecting ..... 4-27

**Section 5      810 Series VGA , Sound and LAN Driver Installation**

Easy Driver Installation ..... 5-1

**Section 6      PCI LAN On Board**

PCI LAN On Board ..... 6-1

**Section 7      PCI LAN Diagnostics Test**

PCI LAN Diagnostics Test ..... 7-1

**Appendix**

**Appendix A**

Memory Map ..... A-1  
I/O Map ..... A-1  
Timer & DMA Channels Map ..... A-2  
Interrupt Map ..... A-2  
RTC & CMOS RAM Map ..... A-3

**Appendix B**

POST Codes ..... A-5

**Appendix C**

Load Optimized Defaults ..... A-13

**Appendix D**

GHOST 5.1 Quick User's Guide ..... A-15

---



**Section 1  
INTRODUCTION**

Components Checklist

- ✓ A. (1) EP-3WDF/3WEF mainboard
- ✓ B. (1) EP-3WDF/3WEF user's manual
- ✓ C. (1) Floppy ribbon cable
- ✓ D. (1) Ultra ATA66 Ribbon cable
- ✓ E. (1) Onboard Graphic, Sound and LAN Driver

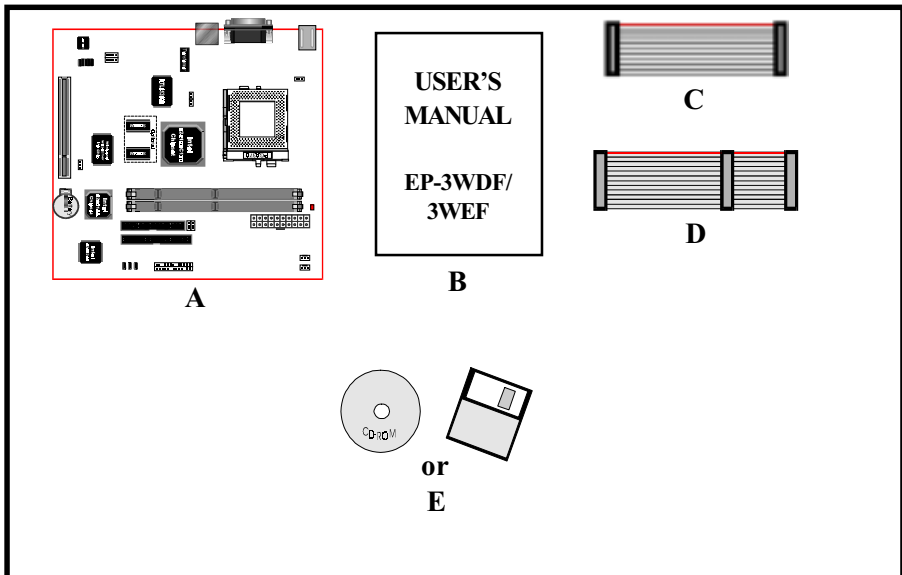

## Intel Celeron processors, the plastic pin grid array (P.P.G.A.) 370

The Intel Celeron processors provide power to handle the internet, educational programs, interactive 3D games, and productivity applications. The Intel Celeron processors at 533, 500, 466, 433, 400, 366, 333 and 300A MHz include integrated L2 cache 128Kbyte. The core for the 533, 500, 466, 433, 400, 366, 333 and 300A MHz processors have 19M transistors due to the addition of the integrated L2 cache 128Kbyte. All the Intel Celeron processors are available in the plastic pin grid array (P.P.G.A.) form factor. The P.P.G.A. form factor is compatible with the 370 pin socket. All the Intel Celeron processors are available in the plastic pin grid array (PPGA) package. The PPGA package is compatible with the 370 pin socket and provides more flexibility to design low cost systems by enabling lower profile and smaller systems and providing the potential for reducing costs of processor retention and cooling solutions. Like the Intel Celeron processors that utilize S.E.P.P., the Intel Celeron processors that use P.P.G.A., feature a P6-microarchitecture-based core processor on a single-sided substrate without BSRAM componentry.

The Intel Celeron processor at 533, 500, 466, 433, 400, 366, 333, and 300A MHz. Includes Intel MMX[tm] media enhancement technology. Offers Dynamic Execution technology.

Includes a 32Kbyte (16Kbyte/16Kbyte) non-blocking, level-one cache that provides fast access to heavily used data. Intel Celeron processors at 533, 500, 466, 433, 400, 366, 333 and 300A MHz include integrated L2 cache 128Kbyte. All the Intel Celeron processor utilize the Intel P6 microarchitecture's multi-transaction system bus at 66MHz. The 533, 500, 466, 433, 400, 366, 333 and 300A MHz processors utilize the Intel P6 microarchitecture's multi-transaction system bus with the addition of the L2 cache interface. The combination of the L2 cache bus and the processor-to-main-memory system bus increases bandwidth and performance over single-bus processors.



Intel MMX technology includes new instructions and data types that allow applications to achieve a new level of performance. Intel's MMX technology is designed as a set of basic, general-purpose integer instructions that are easily applied to the needs of a wide diversity of multimedia and communications applications. The highlights of the technology are:

- \* Single Instruction, Multiple Data (SIMD) technique
- \* 57 new instructions
- \* Eight 64-bit wide MMX technology registers
- \* Four new data types

## The plastic pin grid array (P.P.G.A.) 370 processor Installation and Removal

---

### ***Installation:***

Install the processor and the fan heatsink using the Installation Notes provided with the boxed processor. First, raise the handle of the 370-pin socket. Carefully install the processor into the 370-pin socket making sure that none of the pins are bent. Then close the handle of the socket. Next install the fan heatsink. Make sure to install the heatsink onto the processor after the processor has been inserted into the 370-pin socket. Place the fan heatsink onto the processor such that the integrated clip lines up with the socket's attach tabs. This will align the fan cable with the PGA370 mark on the 370-pin socket. Remember not to damage the thermal interface pad. Attach the clip onto the socket's attach tabs. (A small tool, such as a pen, may make this process easier.) Take care to consider potential scraping of the motherboard underneath the 370-pin socket attach tabs. Connect the attached fan power cable to the motherboard connector and quickly power on the system to verify that the processor fan is running.

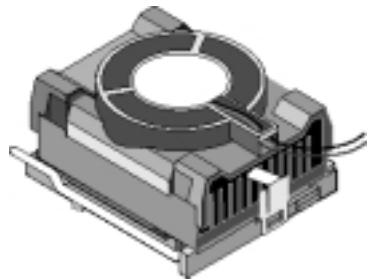

***Removal:***

To simplify the following process, consider removing the motherboard from the chassis before removing the processor. First, unplug the fan power cable from the motherboard's connector. Then pull the integrated clip away from the socket's tab nearest the fan cable. (A small tool, such as a pen or screwdriver, may make this process easier.) Once the clip is free, slowly lift the fan heatsink straight up away from the socket and the processor. (If the processor has been in operation for a long period of time, then this step may require some extra force; this is because the heat dissipated from the processor will have affected the thermal interface pad) Next, lift up the handle of the 370-pin socket. Finally, carefully remove the processor from the socket making sure not to bend any of the processor pins.

## Intel(R) 810 Series chipset features

The Intel(R) 810 series chipset that Built on the strong foundation of Intel(R) 440BX AGPset technology, the Intel(R) 810 series chipset has re-engineered the Value PC, providing next generation features and great graphics performance.

The 82810 series Graphics Memory Controller Hub (GMCH) features : Intel(R) graphics technology and software drivers, using Direct AGP (integrated AGP) to create vivid 2D and 3D effects and images. The 82810 series chip feature integrated Hardware Motion Compensation to improve soft DVD video quality.

The Inte(R) 82810 series chipset use Intel(R) Dynamic Video Memory Technology (D.V.M.T.) is an architecture that offers breakthrough performance for the (motherboard) PC through efficient memory utilization and Direct AGP. The system OS uses the Intel software drivers and intelligent memory arbiter to support richer graphics applications.

The 82801 I/O Controller Hub (ICH) employs the Intel(R) Accelerated Hub Architecture to make a direct connection from the graphics and memory to the integrated AC97 controller, the IDE controllers (ATA/66 or ATA/33), dual USB ports, and PCI add-in cards.

The Accelerated Hub Architecture provides twice the bandwidth of the PCI bus at 266 MB per second. This allows a wider flow of rich information from the I/O controller to the memory controller, with optimized arbitration rules allowing more functions to run concurrently, enabling more life-like audio and video.

The Integrated Audio-Codec 97 controller enables software audio and modem (AMR Riser Optional) by using the processor to run sound and modem software. By reusing existing system resources, this feature adds flexibility, improves sound and modem quality.

The 82802 Firmware Hub (FWH, 4MB) stores system BIOS and video BIOS, eliminating a redundant nonvolatile memory component. In addition, the 82802 contains a hardware Random Number Generator (RNG). The Intel(R) RNG provides truly random numbers to enable fundamental security building blocks supporting stronger encryption, digital signing, and security protocols for the future application program .

## EP-3WDF/3WEF Form-Factor

The EP-3WDF/3WEF is designed with FlexATX form factor - the new industry standard of chassis. The FlexATX form factor of Maximum board size is 8.5 inches (216mm)\*7.4 inches (190mm) for FlexATX addendum version 1.0. This FlexATX addendum allows enhanced flexibility where conforming motherboards may be enclosed; that is a all-in-one termination machine, or low cost desktop systems. In fact, it does focus on delivering one method to implement some of the features of an Ease of Use personal computer. To mount a FlexATX motherboard in an ATX 2.03 - compliant chassis, two new mounting holes are required in the chassis. The FlexATX form factor is essentially a Baby-AT baseboard rotated 90 degrees within the chassis enclosure and a new mounting configuration for the power supply. With these changes the processor is relocated away from the expansion slots, allowing them all to hold full length add-in cards. FlexATX defines a double height aperture to the rear of the chassis which can be used to host a wide range of onboard I/O. Only the size and position of this aperture is defined, allowing PC manufacturers to add new I/O features (e.g.; TV input, TV output, modem, LAN, etc.) to systems. This will help systems integrators differentiate their products in the marketplace, and better meet your needs.

- Smaller size promotes a smaller system size.
- I/O shield does not need to be retooled in an ATX 2.03 or later. The Mainboard should be used in an ATX 2.03 (or later) compliant case.
- A smaller power supply can be used. High integration on mainboard reduces the system costs.

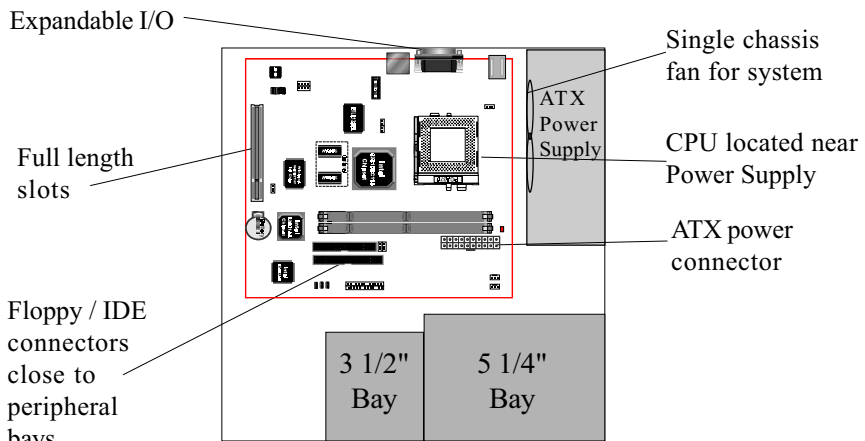

Figure 2: Summary of ATX chassis features

### I/O Shield Connector

The EP-3WDF/3WEF is equipped with an I/O back panel.

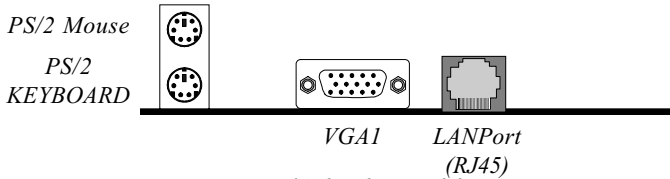

Figure 3: I/O back panel layout

### Power-On/Off (Remote)

The EP-3WDF/3WEF has a single 20-pin connector for ATX power supplies. For ATX power supplies that support the **Remote On/Off** feature, this should be connected to the systems front panel for system Power On/Off button. The systems power On/Off button should be a momentary button that is normally open. The EP-3WDF/3WEF has been designed with "Soft Off" functions. You can turn Off the system from one of two sources: The first is the front panel Power On/Off the button, and the other is the "Soft Off" function controlled by the operating system such as Windows 95/98. When a user clicks to Shutdown the system; the power will be turn off automatically.

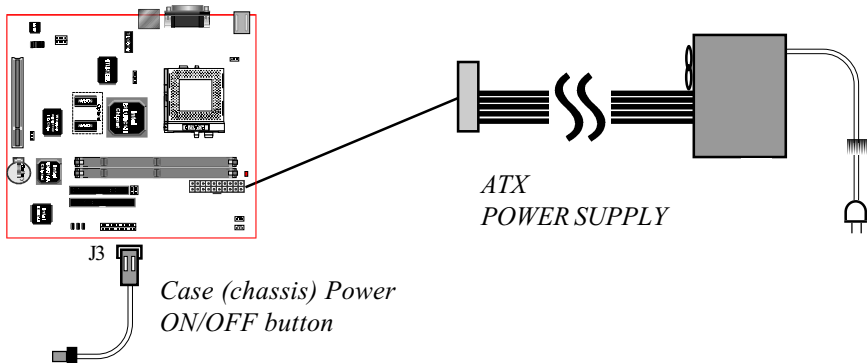

Figure 4: Simple ATX Power ON/OFF Controller

System Block Diagram

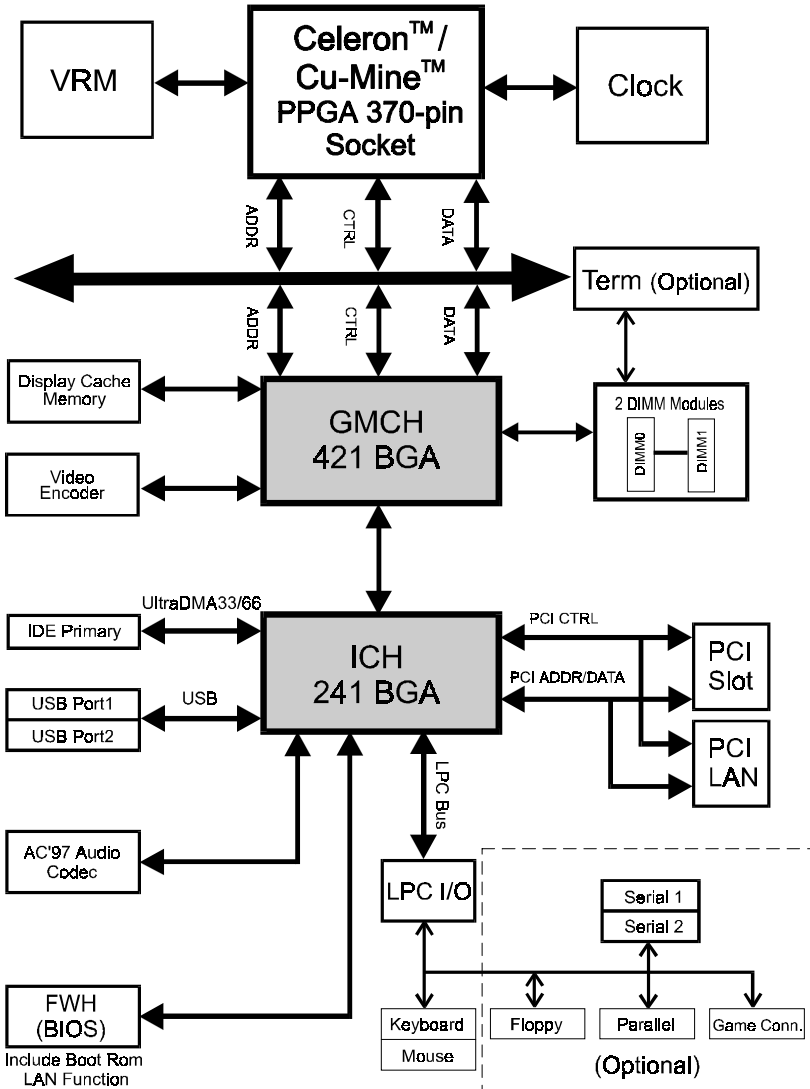

Figure 5: System Block Diagram

---

**Section 2**  
**FEATURES**

---

---

**EP-3WDF/3WEF Features:**

---

- EP-3WDF/3WEF is based on the Socket 370 Processors including PCGA & FC-PGA operating at 300 ~700MHz. The board is configured by a BIOS setting to match your CPU clock speed.
- The 3WDF designed with Intel's 810 series chipset.
- Supports up to 512 MB of 168 Pin SDRAM (minimum of 16 MB) on board . It will run Synchronous DRAM memory (SDRAM) at 100MHz.
- 64-bit system memory interface with optimized support for SDRAM at 100MHz.
- Integrated 2D & 3D Graphics Engine, H/W Motion Compensation Engine, 230MHz DAC and 4MB Display Cache(Optional).
- AC'97 2.1 Audio CODEC onboard for enables the software Audio.
- PCI REALTEK RTL8139B LAN Controller onboard.
- Supports (1) 32 bit PCI slots, provides (1) independent high performance PCI IDE interfaces capable of supporting PIO Mode 3/4 and Ultra DMA 66 devices.
- Designed with Winbond W83627F (or W83627HF) LPC (Low Pin Count) I/O: (1) floppy port, (1) parallel port (EPP, ECP), (2) serial ports (16550 Fast UART).
- Includes a PS/2 mouse connector.
- Allows use of a PS/2 keyboard.
- Features Award Plug & Play BIOS. With 4MB(FWH) Flash Memory you can always upgrade to the current BIOS, Include Boot from LAN function for PXE/RPL Mode (Optional).

- EP-3WDF/3WEF utilizes a Lithium battery which provides environmental protection and longer battery life.
- Support the Universal Serial Bus (USB) connector. The onboard ICH (82801AA) chip provides the means for connecting PC Interface and peripherals such as; keyboards, joysticks, speaker and mouse.
- Built-in ATX 20-pin power supply connector.
- Software power-down when using Windows® 95/98.
- Supports ring-in feature (remote power-on through external modem, allow system to be turned on remotely).
- Resume by Alarm - Allow your system to turn on at a preselected time.
- Supports CPU Hardware sleep and SMM (System Management Mode).
- Supports Hot key, Any key or password Keyboard power ON function (KBPO).
- Supports the System Power LED (PANEL) blinks in the sleep mode.
- Y2K Compliant.
- Advanced Configuration Power Interface (ACPI) ready.
- Supports USDM software to offer motherboard various status on Windows® 95/98.
- Supports OPL3, Sound Blaster Pro, MPU401 UART mode and Joystick function.
- Wake-On \_LAN provides great utility for power management of PC.
- Supports PCI LAN on board 100Mbps Fast Ethernet or 10Mbps Ethernet data transfer, selected via auto-negotiation.
- Supports PCI LAN on board, Full-duplex or half-duplex operation, selected by auto-negotiation.
- Supports PCI LAN on board, Built-in FIFO buffers reduce overhead of memory transfers.
- Drivers for all leading Network operating System.



Section 3  
INSTALLATION

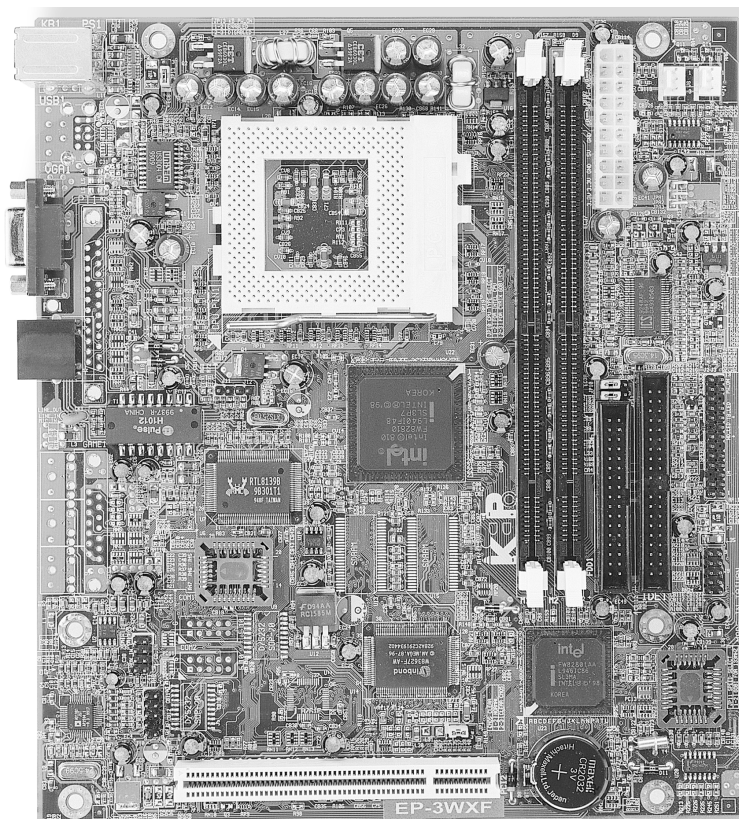

EP-3WDF/3WEF Detailed Layout

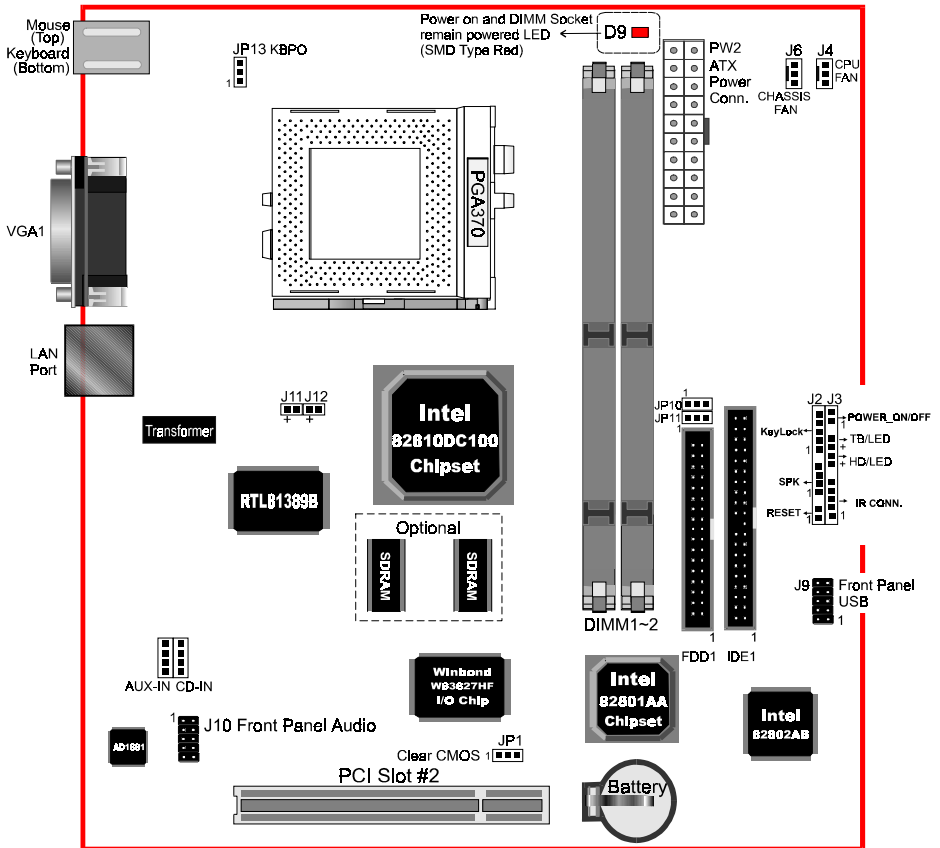

Figure 1

## Easy Installation Procedure

The following must be completed before powering on your new system:

- 3-1. CPU Insertion
- 3-2. Jumper Settings
- 3-3. System memory Configuration
- 3-4. Device Connectors
- 3-5. Keyboard Power ON Functions (KBPO)

### Section 3-1 CPU Insertion

---

CPU Insertion: (use CuMine™ for reference)

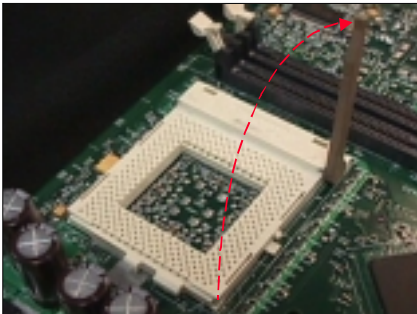

Figure 2

#### Step 1

Open the socket by raising the actuation lever.

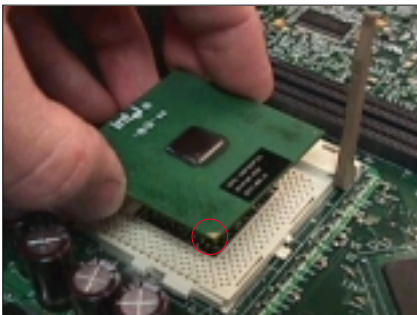

Figure 3

#### Step 2

Insert the processor.

Ensure proper pin 1 orientation by aligning the FC-PGA corner marking with the socket corner closest to the actuation arm tip. The pin field is keyed to prevent mis-oriented insertion.

Don't force processor into socket. If it does not go in easily, check for mis-orientation and debris.

Make sure the processor is fully inserted into the socket on all sides.



Figure 4

**Step 3**

Close the socket by lowering and locking the actuation lever.

Note: Intel's reference design thermal solution is an active heatsink; an extruded aluminum heatsink based and a fan attached to the top on the fin array. (See Figure 5)

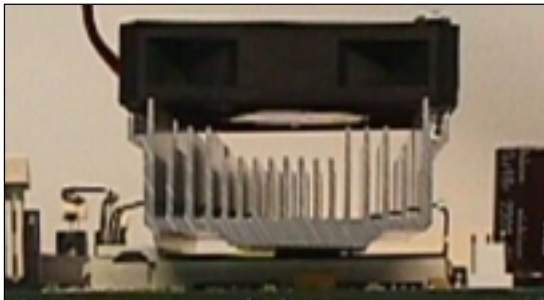





Figure 5

Section 3-2  
Jumper Settings

---

JP1  CMOS Clear  
JP1 = 1-2 Normal (Default)  
      = 2-3 Clear CMOS

JP10  CPU Type Selection  
JP10= 1-2 For Intel's CPU  
      = 2-3 For Others CPU

JP11  CPU Speed Selection  
JP11 = Open for CPU Speed 66MHz  
      = 1-2 for CPU Speed 133MHz  
      = 2-3 for CPU Speed 100MHz

JP13  Keyboard Power-ON Function  
JP13= 1-2 Enabled  
      = 2-3 Disabled (Default)

Section 3-3
System Memory Configuration

Memory Layout

The EP-3WDF/3WEF supports (2) 168-pin DIMMs (Dual In-line Memory Module). Socktts are available for 3.3v SDRAM

- This board supports SPD DIMMs Modules only.
• This board supports 64Mbit and 128Mbit SDRAM technologies. The registered DIMM Supports 32Mx4 128Mbit Memory Modules only.
• We recommend using at least 125MHz (-8ns) SDRAM DIMM at the 100MHz (or higher) FSB as timing becomes more critical at these higher speeds.
• DIMM SDRAM may be 83MHz (-12ns), 100MHz (-10ns) or 125MHz (-8ns) bus speed.

Figure 6 and Table 1 show several possible memory configurations using

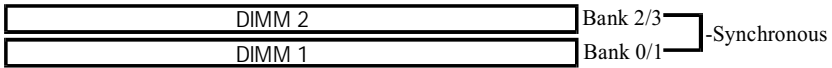

Figure 6

Table with 3 columns: Total Memory, DIMM 1 (Bank 0/1), and DIMM 2 (Bank 2/3). It lists memory configurations for 256MB and 512MB maximums.

\* SDRAM only supports 16, 32, 64, 128, 256MB DIMM modules.

Table 1

### DIMM Module Installation

Figure 7 displays the notch marks and what they should look like on your DIMM memory module.

DIMMs have 168-pins and two notches that will match with the onboard DIMM socket. DIMM modules are installed by placing the chip firmly into the socket at a 90 degree angle and pressing straight down (figure 8) until it fits tightly into the DIMM socket (figure 9).

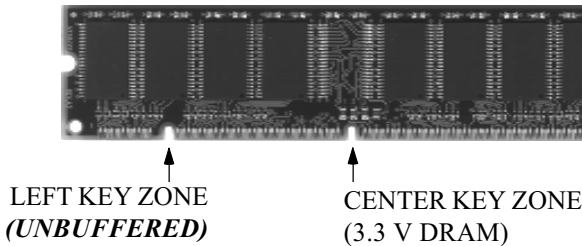

Figure 7

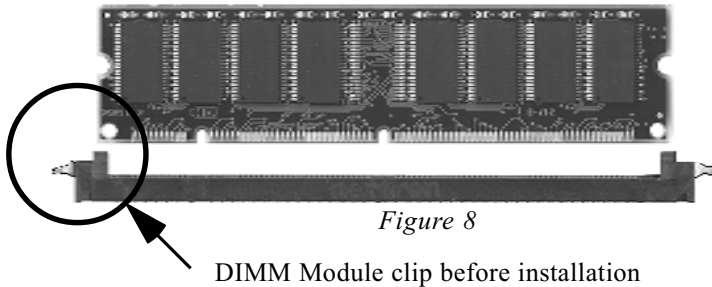

Figure 8

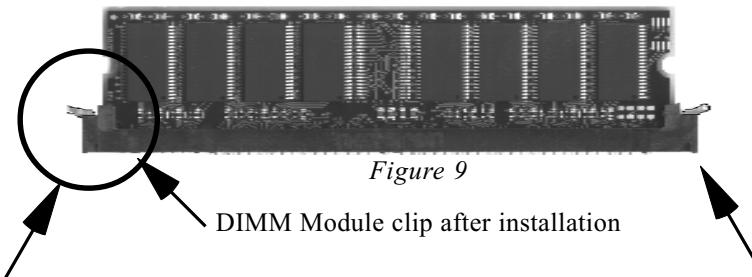

Figure 9

To remove the DIMM module simply press down both of the white clips on either side and the module will be released from the socket.

## Section 3-4

### Device Connectors

---

**Please install the motherboard into the chassis.**

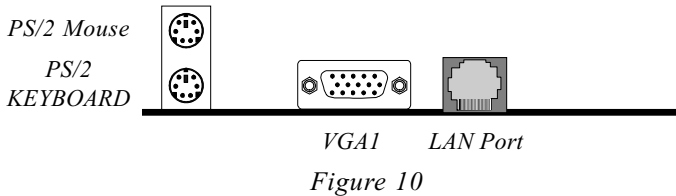

**J2,J3:** Chassis Panel Connector

- Keylock, Speaker, Reset, Sleep, Turbo LED and HDD LED

**J4:** CPU Fan Power

- A plug-in for the CPU Fan Power

**J6:** Chassis Fan Power

- A plug-in for the chassis Fan Power

**J9:** Front Panel USB Connector

**J10:** Front Panel Audio Connector

**J11, J12:** LAN LED Display Connector (Optional)

**PW2:** ATX Power Connector -- 20-pin power connector

**IDE1:** Primary IDE Connector

**FDD1:** Floppy Controller Connector

**CD-IN:** CD Audio\_IN Connector

- Pin1(CD\_IN\_Left), Pin2/Pin3(CD\_Reference), Pin4(CD\_IN\_Right)

**AUX\_IN:** Auxiliary Line\_IN Connector

- Pin1(Left Line\_IN), Pin2/Pin3(GND), Pin4(Right Line-IN)



Device Connectors (continued)

**Power On/Off**

(This is connected to the power button on the case. Using the Soft-Off by Pwr-BTTN feature, you can choose either Instant Off (turns system off immediately), or 4 sec delay (you need to hold the button down for 4 seconds before the system turns off). When the system is in 4 sec delay mode, there is a special feature to make the system to go into suspend mode when the button is pressed momentarily.)

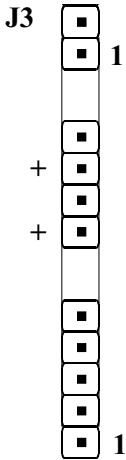

**Turbo LED indicator** - LED ON when higher speed is selected

**IDE LED indicator** - LED ON when Onboard PCI IDE Hard disks is activate

**IR Connector**

- 1. VCC
- 2. NC
- 3. IRRX
- 4. GND
- 5. IRTX

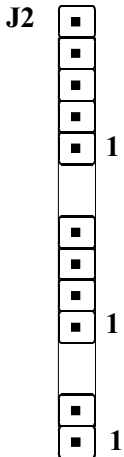

**KeyLock** - Keyboard lock switch & Power LED connector

- 1. Power LED(+)
- 2. N/C
- 3. GND
- 4. KeyLock
- 5. GND

\* The power LED lights when the system is powered on and blinks in SLEEP MODE (Suspend mode).

**Speaker** - Connect to the system's speaker for beeping

- 1. Speaker
- 2. N/C
- 3. GND
- 4. GND

**Reset** - Closed to restart system.

**J9**

1	■	■	2
	■	■	
	■	■	
	■	■	
9	■	■	10

**Front Panel USB Connector**

1. VCC
2. GND
3. USB negative signal for port 1
4. GND
5. USB positive signal for port 1
6. USB positive signal for port 2
7. GND
8. USB negative signal for port 2
9. GND
10. VCC

**J10**

1	■	■	2
	■	■	
	■	■	
	■	■	
9	■	■	10

**Front Panel Audio Connector**

1. Line\_Out\_L
2. Line\_Out\_R
3. GND
4. GND
5. Line\_In\_L
6. Line\_In\_R
7. GND
8. NC
9. MIC\_In
10. GND

**J11**

■	■
---	---

+

**ACTIVITY Indicator**

A flashing green LED indicates that the adapter is sending or receiving data.

**J12**

■	■
---	---

+

**LINK Indicator**

A steady green LED indicates good linkage between the 32-bit PCI bus 10/100Mbps Fast Ethernet Adapter and its supporting hub.

## Section 3-5

Keyboard Power ON Functions (KBPO)**Exclusive Keyboard Power ON Function**

To innovate a unique feature to benefit users, we devoted the easiest and most convenient way to turn on your system based on the the ATX power supply.

How to work with it

**Step 1:** Please check JP13 at the position 1-2 after you finished the system installation.

**JP13**



**Keyboard Power-ON Function Selection**

1-2 : Enabled

2-3 : Disabled (Default)

**Step 2:** Push the momentary switch (J3 PW-ON) to turn on your system and then push again to hold for more than 4 seconds to turn it off after counting memory as soon as you turn it on.

**Step 3:** You can enjoy the Keyboard Power ON function (KBPO) by *pressing any 1 key, Hot key (Ctrl-F1, F2.....F12), Password (A maximum of 5 characters can be entered.) and BUTTON only to turn on your system. Please refer to the BIOS Integrated peripherals setup for detail. The BIOS Default is keyboard Hot key <Ctrl> - <F1> to turn on the system.* Your system will be turned on automatically, after releasing the keys. To power off your system, you can use the Soft-OFF function under Windows 95.

**Notes:**

1. Intel ATX version 2.0 specification has recommended you use the power supply with  $\geq 1.0A$  in 5.0VSB. With our EP-3WDF/3WEF mainboard, *the 5.0VSB standby power only has to be  $\geq 0.1A$  (100mA)* then you can enjoy this unique benefit. However, the ATX power supply which is  $< 0.1$  (100mA) is still applicable to your system by placed JP13 at the position 2-3 to disable this feature.
2. We recommended you use the power supply with 1.0A in 5.0VSB. Because this supported PCI 2.1 specification for remote power-on and wake-up function.

Page Left Blank

---

Section 4  
BIOS SETUP

Main Menu

Once you enter the AwardBIOS™ CMOS Setup Utility, the Main Menu will appear on the screen. The Main Menu allows you to select from several setup functions and two exit choices. Use the arrow keys to select among the items and press <Enter> to accept and enter the sub-menu.

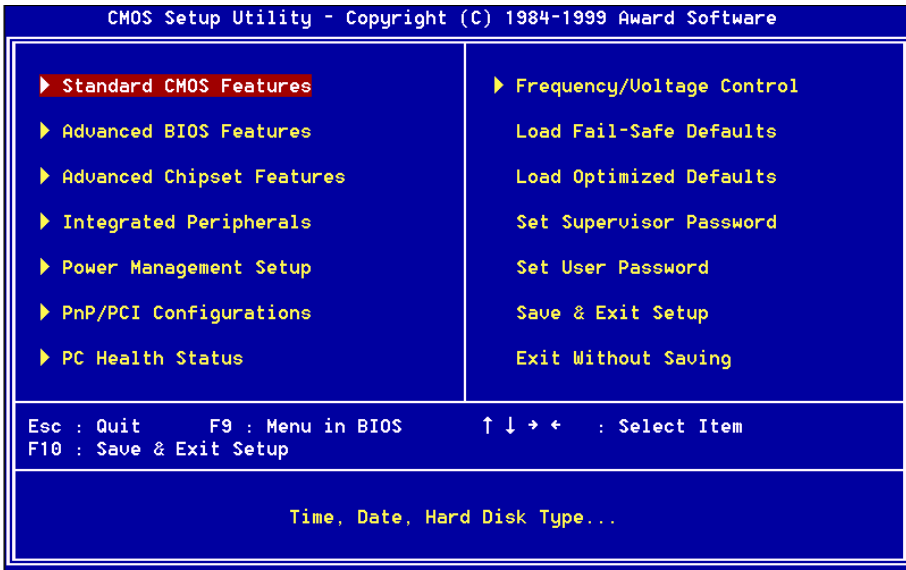

Note that a brief description of each highlighted selection appears at the bottom of the screen.

**Setup Items**

The main menu includes the following main setup categories. Recall that some systems may not include all entries.

**Standard CMOS Features**

Use this menu for basic system configuration.

**Advanced BIOS Features**

Use this menu to set the Advanced Features available on your system.

**Advanced Chipset Features**

Use this menu to change the values in the chipset registers and optimize your system's performance.

**Integrated Peripherals**

Use this menu to specify your settings for integrated peripherals.

**Power Management Setup**

Use this menu to specify your settings for power management.

**PnP / PCI Configuration**

This entry appears if your system supports PnP / PCI.

**PC Health Status**

This item is only show the system health status (include Voltage, Fan speed, CPU temperature...)

**Frequency/Voltage Control**

Use this menu to specify your settings for frequency/Voltage control.

**Load Fail-Safe Defaults**

Use this menu to load the BIOS default values for the minimal/stable performance for your system to operate.

**Load Optimized Defaults**

Use this menu to load the BIOS default values that are factory settings for optimal performance system operations. While Award has designed the custom BIOS to maximize performance, the factory has the right to change these defaults to meet their needs.

**Supervisor / User Password**

Use this menu to set User and Supervisor Passwords.

**Save & Exit Setup**

Save CMOS value changes to CMOS and exit setup.

**Exit Without Save**

Abandon all CMOS value changes and exit setup.

## 4-1 Standard CMOS Setup

The items in Standard CMOS Setup Menu are divided into 10 categories. Each category includes no, one or more than one setup items. Use the arrow keys to highlight the item and then use the <PgUp> or <PgDn> keys to select the value you want in each item.

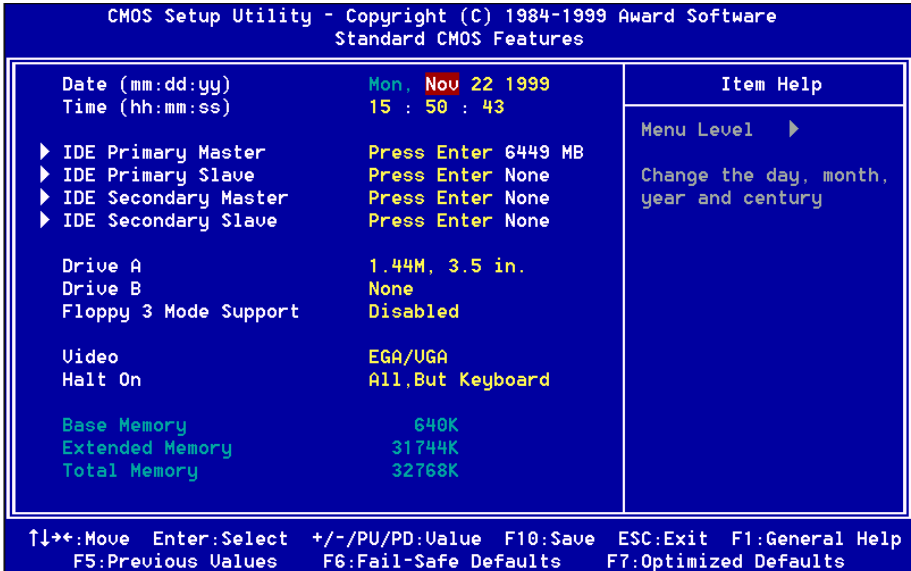

Figure 1: The Main Menu

**Main Menu Selections**

This table shows the selections that you can make on the Main Menu

<b>Item</b>	<b>Options</b>	<b>Description</b>
Date	Month DD YYYY	Set the system date. Note that the 'Day' automatically changes when you set the date
Time	HH : MM : SS	Set the system time
IDE Primary Master	Options are in its sub menu (described in Table 3)	Press <Enter> to enter the sub menu of detailed options
IDE Primary Slave	Options are in its sub menu (described in Table 3)	Press <Enter> to enter the sub menu of detailed options
IDE Secondary Master	None	None
IDE Secondary Slave	None	None
Drive A Drive B	None 360K, 5.25 in 1.2M, 5.25 in 720K, 3.5 in 1.44M, 3.5 in 2.88M, 3.5 in	Select the type of floppy disk drive installed in your system
Floppy 3 Mode Support	Disabled Drive A Drive B Both	
Video	EGA/VGA CGA 40 CGA 80 MONO	Select the default video device
Halt On	All Errors No Errors All, but Keyboard All, but Diskette All, but Disk/Key	Select the situation in which you want the BIOS to stop the POST process and notify you
Base Memory	N/A	Displays the amount of conventional memory detected during boot up
Extended Memory	N/A	Displays the amount of extended memory detected during boot up
Total Memory	N/A	Displays the total memory available in the system

*Table 2 Main Menu Selections*



### IDE Adapters

The IDE adapters control the hard disk drive. Use a separate sub menu to configure each hard disk drive.

Figure 2 shows the IDE primary master sub menu.

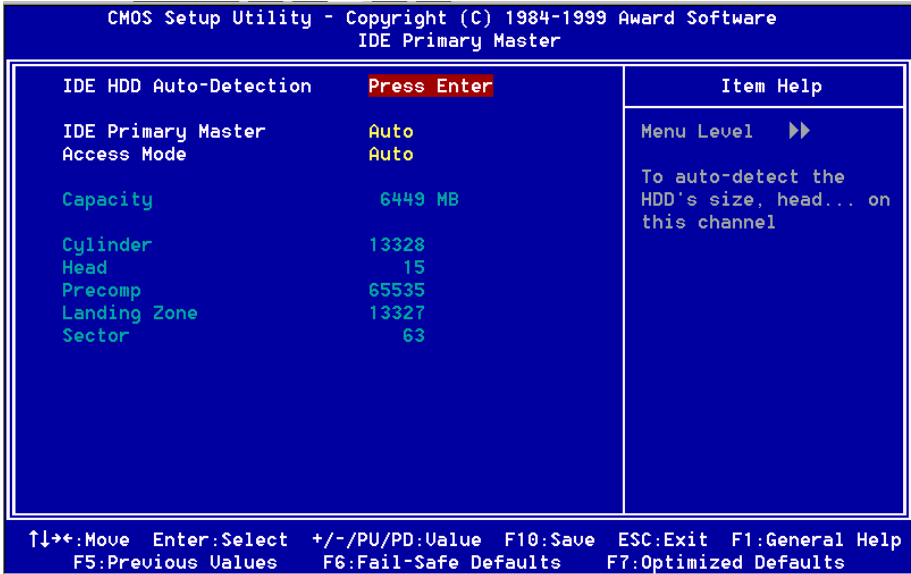

Figure 2 IDE Primary Master sub menu

Use the legend keys to navigate through this menu and exit to the main menu. Use Table 3 to configure the hard disk.

<i>Item</i>	<i>Options</i>	<i>Description</i>
IIDE HDD Auto-detection	Press Enter	Press Enter to auto-detect the HDD on this channel. If detection is successful, it fills the remaining fields on this menu.
IDE Primary Master	None Auto Manual	Selecting 'manual' lets you set the remaining fields on this screen. Selects the type of fixed disk. "User Type" will let you select the number of cylinders, heads, etc. Note: PRECOMP=65535 means NONE !
Capacity	Auto Display your disk drive size	Disk drive capacity (Approximated). Note that this size is usually slightly greater than the size of a formatted disk given by a disk checking program.
Access Mode	Normal LBA Large Auto	Choose the access mode for this hard disk
The following options are selectable only if the 'IDE Primary Master' item is set to 'Manual'		
Cylinder	Min = 0 Max = 65535	Set the number of cylinders for this hard disk.
Head	Min = 0 Max = 255	Set the number of read/write heads
Precomp	Min = 0 Max = 65535	**** <b>Warning:</b> Setting a value of 65535 means no hard disk
Landing zone	Min = 0 Max = 65535	****
Sector	Min = 0 Max = 255	Number of sectors per track

*Table 1 Hard disk selections*

## 4-2 Advanced BIOS Features

This section allows you to configure your system for basic operation. You have the opportunity to select the system’s default speed, boot-up sequence, keyboard operation, shadowing and security.

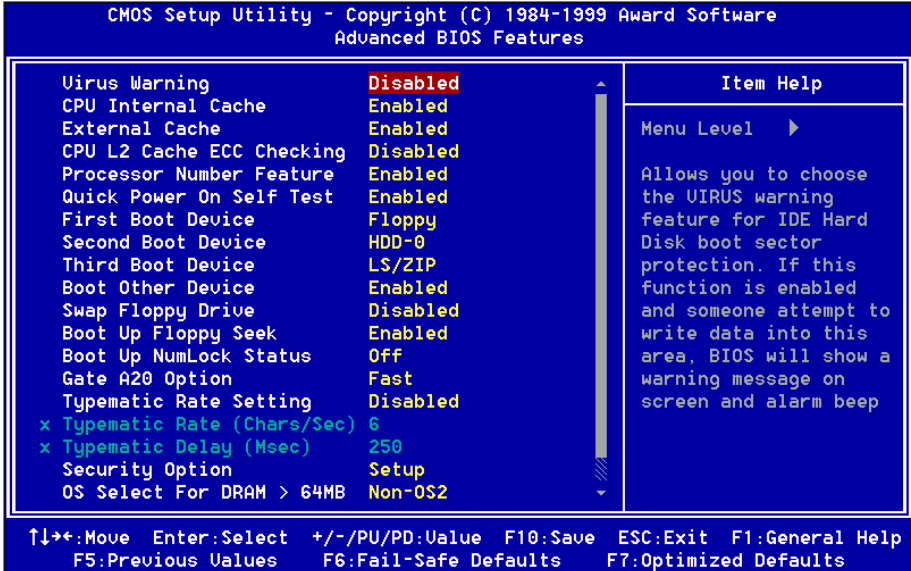

### Virus Warning

Allows you to choose the VIRUS Warning feature for IDE Hard Disk boot sector protection. If this function is enabled and someone attempt to write data into this area, BIOS will show a warning message on screen and alarm beep.

Enabled: Activates automatically when the system boots up causing a warning message to appear when anything attempts to access the boot sector or hard disk partition table.

Disabled: No warning message will appear when anything attempts to access the boot sector or hard disk partition table.

### CPU Internal Cache/External Cache

These two categories speed up memory access. However, it depends on CPU/chipset design.

Enabled: Enable cache

Disabled: Disable cache

**CPU L2 Cache ECC Checking**

This item allows you to enable/disable CPU L2 Cache ECC checking.

The choice: Enabled, Disabled.

**Processor Number Feature**

Pentium III or later CPU new feature. The default is Enabled.

Enabled: Processor serial number readable.

Disabled: Processor serial number disabled.

**Quick Power On Self Test**

This category speeds up Power On Self Test (POST) after you power up the computer. If it is set to Enable, BIOS will shorten or skip some check items during POST.

Enabled: Enable quick POST

Disabled: Normal POST

**First/Second/Third/Other Boot Device**

The BIOS attempts to load the operating system from the devices in the sequence selected in these items.

The Choice: Floppy, LS/ZIP, HDD, SCSI, CDROM, Disabled.

**Swap Floppy Drive**

If the system has two floppy drives, you can swap the logical drive name assignments.

The choice: Enabled/Disabled.

**Boot Up Floppy Seek**

Seeks disk drives during boot up. Disabling speeds boot up.

The choice: Enabled/Disabled.

**Boot Up NumLock Status**

Select power on state for NumLock.

The choice: Enabled/Disabled.

**Gate A20 Option**

Select if chipset or keyboard controller should control GateA20.

Normal: A pin in the keyboard controller controls GateA20

Fast: Lets chipset control GateA20

**Typematic Rate Setting**

Key strokes repeat at a rate determined by the keyboard controller. When enabled, the typematic rate and typematic delay can be selected.

The choice: Enabled/Disabled.

**Typematic Rate (Chars/Sec)**

Sets the number of times a second to repeat a key stroke when you hold the key down.

The choice: 6, 8, 10, 12, 15, 20, 24, 30.

**Typematic Delay (Msec)**

Sets the delay time after the key is held down before it begins to repeat the keystroke.

The choice: 250, 500, 750, 1000.

**Security Option**

Select whether the password is required every time the system boots or only when you enter setup.

**System** The system will not boot and access to Setup will be denied if the correct password is not entered at the prompt.

**Setup** The system will boot, but access to Setup will be denied if the correct password is not entered at the prompt.

*Note: To disable security, select PASSWORD SETTING at Main Menu and then you will be asked to enter password. Do not type anything and just press <Enter>, it will disable security. Once the security is disabled, the system will boot and you can enter Setup freely.*

**OS Select For DRAM > 64MB**

Select the operating system that is running with greater than 64MB of RAM on the system. The choice: Non-OS2, OS2.

**HDD S.M.A.R.T Capability**

The choice: Enabled/Disabled.

**Report No FDD For Win 95**

Whether report no FDD for Win 95 or not.

The choice: Yes, No.

### 4-3 Advanced Chipset Features

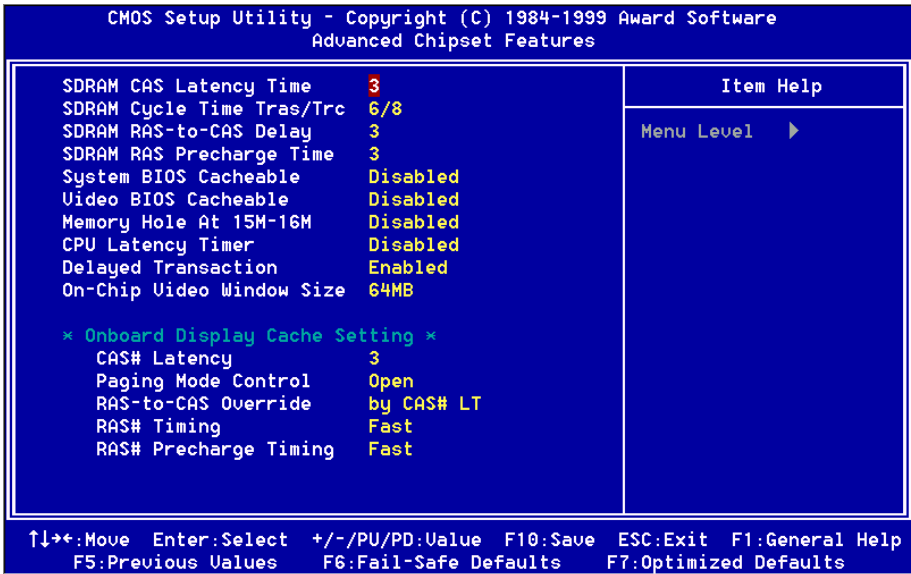

This section allows you to configure the system based on the specific features of the installed chipset. This chipset manages bus speeds and access to system memory resources, such as DRAM and the external cache. It also coordinates communications between the conventional ISA bus and the PCI bus. It must be stated that these items should never need to be altered. The default settings have been chosen because they provide the best operating conditions for your system. The only time you might consider making any changes would be if you discovered that data was being lost while using your system.

#### DRAM Settings

The first chipset settings deal with CPU access to dynamic random access memory (DRAM). The default timings have been carefully chosen and should only be altered if data is being lost. Such a scenario might well occur if your system had mixed speed DRAM chips installed so that greater delays may be required to preserve the integrity of the data held in the slower memory chips.

**SDRAM CAS Latency Time**

When synchronous DRAM is installed, the number of clock cycles of CAS latency depends on the DRAM timing.

The Choice: 2, 3

**SDRAM Cycle Time Tras/Trc**

Select the number of SCLKs for an access cycle.

The Choice: 5/7, 6/8.

**SDRAM RAS-to-CAS Delay**

This field lets you insert a timing delay between the CAS and RAS strobe signals, used when DRAM is written to, read from, or refreshed. *Fast* gives faster performance; and *Slow* gives more stable performance. This field applies only when synchronous DRAM is installed in the system.

The Choice: 2, 3.

**SDRAM RAS Precharge Time**

If an insufficient number of cycles is allowed for the RAS to accumulate its charge before DRAM refresh, the refresh may be incomplete and the DRAM may fail to retain data. *Fast* gives faster performance; and *Slow* gives more stable performance. This field applies only when synchronous DRAM is installed in the system.

The Choice: 2, 3.

**System BIOS Cacheable**

Selecting *Enabled* allows caching of the system BIOS ROM at F0000h-FFFFFh, resulting in better system performance. However, if any program writes to this memory area, a system error may result.

The choice: Enabled, Disabled.

**Video BIOS Cacheable**

Select *Enabled* allows caching of the video BIOS, resulting in better system performance. However, if any program writes to this memory area, a system error may result.

The Choice: Enabled, Disabled.

**Memory Hole At 15M-16M**

You can reserve this area of system memory for ISA adapter ROM. When this area is reserved, it cannot be cached. The user information of peripherals that need to use this area of system memory usually discusses their memory requirements.

The Choice: Enabled, Disabled.

**Delay Transaction**

The chipset has an embedded 32-bit posted write buffer to support delay transactions cycles. Select *Enabled* to support compliance with PCI specification version 2.1.

The Choice: Enabled, Disabled.

**On-Chip Video Window Size**

The amount of system memory that the 810 series AGP is allowed to share. The default is 64.

32: 32MB of systems memory accessible by the 810 series AGP.

64: 64MB of systems memory accessible by the 810 series AGP.

***Onboard Display Cache Setting (Optional for 82810-DC100 only)***

Setting the onboard display cache timing.

**CAS # Latency**

Select the local memory clock periods.

The Choice: 2, 3

**Paging Mode Control**

Select the paging mode control.

The Choice: Close, Open.

**RAS-to-CAS Override**

Select the display cache clock periods control.

The Choice: by CAS# LT, Override(2).

**RAS# Timing**

This item controls RAS# active to Protegra, and refresh to RAS# active delay ( in local memory clocks).

The Choice: Fast, Slow.

**RAS# Precharge Timing**

This item controls RAS# precharge (in local memory clocks).

The choice: Fast, Slow.



# 4-4 Integrated Peripherals

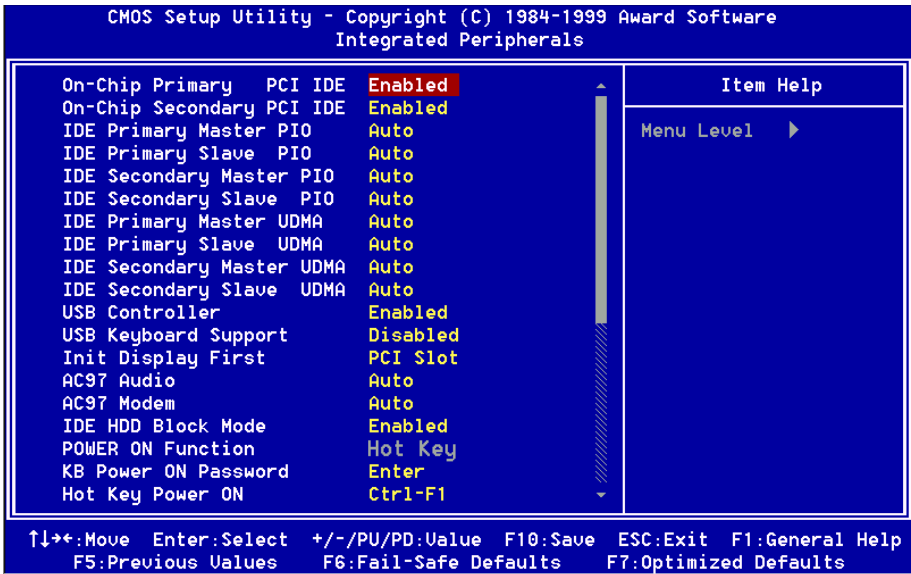

## OnChip Primary PCI IDE

The integrated peripheral controller contains an IDE interface with support for one IDE channels. Select *Enabled* to activate each channel separately.

The choice: Enabled, Disabled. (Can't support Secondary/IDE).

## IDE Primary Master/Slave PIO

The four IDE PIO (Programmed Input/Output) fields let you set a PIO mode (0-4) for each of the four IDE devices that the onboard IDE interface supports. Modes 0 through 4 provide successively increased performance. In Auto mode, the system automatically determines the best mode for each device.

The choice: Auto, Mode 0, Mode 1, Mode 2, Mode 3, Mode 4.

## IDE Primary Master/Slave UDMA

Ultra DMA/33 implementation is possible only if your IDE hard drive supports it and the operating environment includes a DMA driver (Windows 95 OSR2 or a third-party IDE bus master driver). If your hard drive and your system software both support Ultra DMA/33, select Auto to enable BIOS support.

The Choice: Auto, Disabled.

**USB Controller**

Select *Enabled* if your system contains a Universal Serial Bus (USB) controller and you have USB peripherals.

The choice: Enabled, Disabled.

**USB Keyboard Support**

Select *Enabled* if your system contains a Universal Serial Bus (USB) controller and you have a USB keyboard.

The choice: Enabled, Disabled.

**Init Display First**

This item allows you to decide to active whether PCI Slot or on-chip VGA first

The choice: PCI Slot, Onboard .

**AC97 Audio/Modem**

This item allows you to decide to enable/disable the 810 series chipset family to support AC97 Modem.

Select Enable of AC97 Modem item.

The choice: Enabled, Disabled.

**IDE HDD Block Mode**

Block mode is also called block transfer, multiple commands, or multiple sector read/write. If your IDE hard drive supports block mode (most new drives do), select Enabled for automatic detection of the optimal number of block read/writes per sector the drive can support.

The choice: Enabled, Disabled

**Power On Function**

There are “**Button Only**”, “**Hot Key**” and “**Any key**” can be chosen by this field that allows users to select one of these various functions as Power On Method for their requirement. The default value in this selection is “ Hot Key”. (Ctrl-F1)

Hot Key: User can press “Control Key” (Ctrl) and “Function Key” (from F1 to F12) individually to power on the system. The interval between “Ctrl” key and function Key (F1-F12) must be short.

Anykey: Press anykey to power on the system.

Button Only: This power on function controlled by J3 (pw-on.) Use Power On Button to power on the system.

**Password:** User can Power On the System by password, the password can be entered from 1 to 5 characters. The maximum of password is 5 characters. If user forget / lost the password, please turn off the system and open case to clear CMOS by JP1 to re-setting the power on function. When set the password to turn on the system, than can't power on by J3(PW-ON).

### **KB Power On Password**

When the option of "Power On Function" is password selected, user uses the item to key in password.

### **Hot Key Power On**

Use this option with the above "Power On Function" to set a combination of keys that can be used to power the system on. The default is Ctrl-F1.

Options: Ctrl-F1, Ctrl-F2, Ctrl-F3, Ctrl-F4, Ctrl-F5, Ctrl-F6, Ctrl-F7, Ctrl-F8, Ctrl-F9, Ctrl-F10, Ctrl-F11, and Ctrl-F12.

### **Onboard FDC Controller**

Select Enabled if your system has a floppy disk controller (FDC) installed on the system board and you wish to use it. If you install and-in FDC or the system has no floppy drive, select Disabled in this field.

The choice: Enabled, Disabled.

### **Onboard Serial Port 1/Port 2 (Optional)**

Select an address and corresponding interrupt for the first and second serial ports.

The choice: 3F8/IRQ4, 2E8/IRQ3, 3E8/IRQ4, 2F8/IRQ3, Disabled, Auto.

### **UART Mode Select**

This field allows the users to configure what IR mode the 2nd serial port should use. The default is Normal.

Optional: Normal, IrDA and ASKIR.

### **RxD, TxD Active (Optional)**

This field configures the receive and transmit signals generated from the IR port. The default is Hi Lo (when UART Mode Select is not set to Normal).

Options: Hi Hi, Hi Lo, Lo Hi, and Lo Lo.

### **IR Transmission delay**

The default is Enabled (when UART Mode Select is not set to Normal).

Options: Enabled and Disabled.

**Onboard Parallel port (Optional)**

This field allows the user to configure the LPT port.

The default is 378H / IRQ7.

**378H:** Enable Onboard LPT port and address is 378H and IRQ7.

**278H:** Enable Onboard LPT port and address is 278H and IRQ5.

**3BCH:** Enable Onboard LPT port and address is 3BCH and IRQ7.

**Disabled:** Disable Onboard LPT port.

**Parallel Port Mode (Optional)**

This field allows the user to select the parallel port mode.

The default is ECP+EPP.

**Normal:** Standard mode. IBM PC/AT Compatible bidirectional parallel port.

**EPP:** Enhanced Parallel Port mode.

**ECP:** Extended Capabilities Port mode.

**EPP+ECP:** ECP Mode & EPP Mode.

**EPP Mode Select (Optional)**

This item allows you to determine the IR transfer mode of onboard I/O chip.  
options: EPP1.9, EPP1.7.

**ECP Mode USE DMA (Optional)**

This field allows the user to select DMA1 or DMA3 for the ECP mode.

The default is DMA3.

**DMA1:** This field selects the routing of DMA1 for the ECP mode.

**DMA3:** This field selects the routing of DMA3 for the ECP mode.

**PWRON After PWR-Fail**

The system will stay off or power on after a power interrupte.

The default is Fomer-Status.

**Fomer-Status:** Stay off or power on depend on system safe shut-down or power fail.

**ON:** System always power on after a power interrupte.

**OFF:** System always stay off after a power interrupte.

**Game Port Address (Optional)**

Select an address for the Game port.

The choice: 201, 209, Disabled.

**Midi Port Address (Optional)**

Select an address for the Midi port.

The choice: 290, 300, 330, Disabled.

**Midi Port IRQ (Optional)**

Select an interrupt for the Midi port.

The choice: 5, 10.

## 4-5 Power Management Setup

The Power Management Setup allows you to configure you system to most effectively save energy while operating in a manner consistent with your own style of computer use.

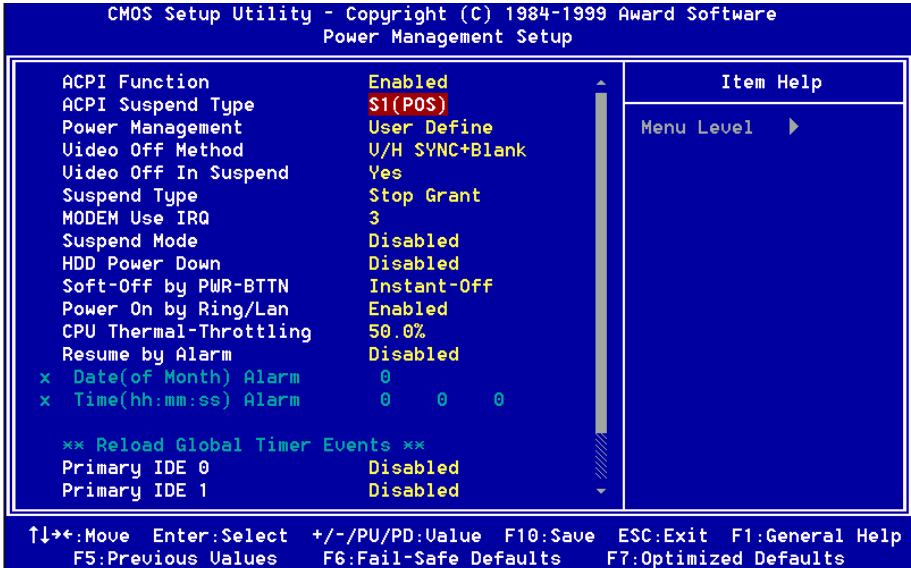

### ACPI Function

This item allows you to enable/disable the Advanced Configuration and Power Management (ACPI).

The choice: Enabled, Disabled.

### ACPI Suspend Type

This item allows you to select S1(POS) function.

The choice: S1(POS).

### Power Management

This category allows you to select the type (or degree) of power saving and is directly related to the following modes:

1. HDD Power Down
2. Doze Mode
3. Suspend Mode

There are four selections for Power Management, three of which have fixed mode settings.

Disable (default)	No power management. Disables all four modes
Min. Power Saving	Minimum power management. Doze Mode = 1 hr. Standby Mode = 1 hr., Suspend Mode = 1 hr., and HDD Power Down = 15 min.
Max. Power Saving	Maximum power management -- <b>ONLY AVAILABLE FOR SL CPU's.</b> Doze Mode = 1 min., Standby Mode = 1 min., Suspend Mode = 1 min., and HDD Power Down = 1 min.
User Defined	Allows you to set each mode individually. When not disabled, each of the ranges are from 1 min. to 1 hr. except for HDD Power Down which ranges from 1 min. to 15 min. and disable.

**Video Off Method**

This determines the manner in which the monitor is blanked.

V/H SYNC+Blank	This selection will cause the system to turn off the vertical and horizontal synchronization ports and write blanks to the video buffer.
Blank Screen	This option only writes blanks to the video buffer.
DPMS	Initial display power management signaling.

**Video Off In Suspend**

This determines the manner in which the monitor is blanked.

The choice: Yes, No.

**Suspend Type**

Select the Suspend Type.

The choice: PWRON Suspend, Stop Grant.

**MODEM Use IRQ**

This determines the IRQ in which the MODEM can use.

The choice: 3, 4, 5, 7, 9, 10, 11, NA.

**Suspend Mode**

When enabled and after the set time of system inactivity, all devices except the CPU will be shut off.

The choice: Enabled, Disabled.

**HDD Power Down**

When enabled and after the set time of system inactivity, the hard disk drive will be powered down while all other devices remain active.

The choice: Enabled, Disabled.

**Soft-Off by PWR-BTTN**

Pressing the power button for more than 4 seconds forces the system to enter the Soft-Off state when the system has “hung.” The default is Instant-off.

The choice: Delay 4 Sec, Instant-Off.

**PowerOn By Ring/Lan**

This option is used to set the remote ring in and Wake on LAN (WOL) features.

The choice: Enabled, Disabled.

**CPU Thermal-Throttling**

Select the CPU Thermal-Throttling rate.

The choice: 25.0%, 37.5%, 50.0%, 62.5%, 75.0%, 87.5%.

**Resume by Alarm**

This option allows you to have the system turn on at a present time each day or on a certain day.

The choice: Disabled, Enabled.

**\*\* PM Events \*\***

PM events are I/O events whose occurrence can prevent the system from entering a power saving mode or can awaken the system from such a mode. In effect, the system remains alert for anything which occurs to a device which is configured as *Enabled*, even when the system is in a power down mode.

**Primary IDE 0**

**Primary IDE 1**

**PCI PIRQ[A-D] #**



## 4-6 PnP/PCI Configuration Setup

This section describes configuring the PCI bus system. PCI, or Personal Computer Interconnect, is a system which allows I/O devices to operate at speeds nearing the speed the CPU itself uses when communicating with its own special components. This section covers some very technical items and it is strongly recommended that only experienced users should make any changes to the default settings.

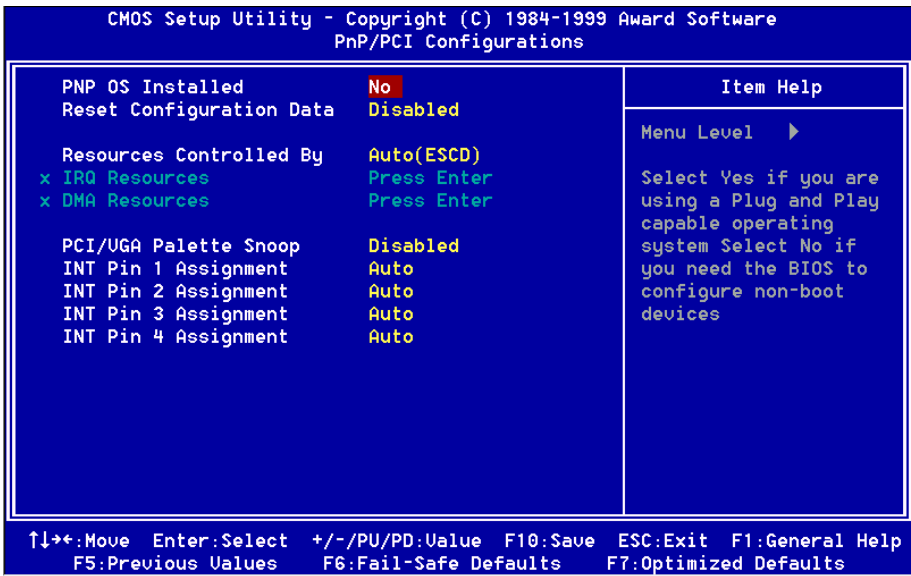

### Reset Configuration Data

Normally, you leave this field Disabled. Select Enabled to reset Extended System Configuration Data (ESCD) when you exit Setup if you have installed a new add-on and the system reconfiguration has caused such a serious conflict that the operating system can not boot.

The choice: Enabled, Disabled .

### Resource controlled by

The Award Plug and Play BIOS has the capacity to automatically configure all of the boot and Plug and Play compatible devices. However, this capability means absolutely nothing unless you are using a Plug and Play operating system such as

Windows95. If you set this field to “manual” choose specific resources by going into each of the sub menu that follows this field (a sub menu is preceded by a “Ø”). The choice: Auto(ESCD), Manual.

**PCI/VGA Palette Snoop**

Leave this field at *Disabled*.

Choices are Enabled, Disabled.

**INT Pin1 to Pin4 Assignment**

These settings allow the user to specify what IRQ will be assigned to PCI devices in the chosen slot. Options available: Auto,3,4,5,7,9,10,11,12,14 & 15. The defaults are Auto.

**4-7 PC Health Status**

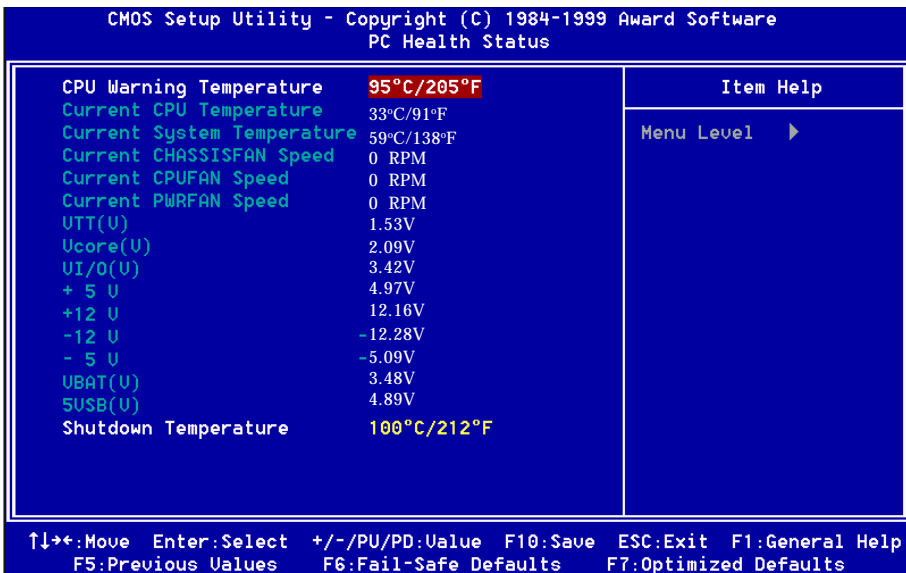

**CPU Warning Temperature**

This is the temperature that the computer will respond to an overheating CPU. The default is Enabled.

Enabled: Temperature is monitored on the CPU, default is 95°C/205°F.

Disabled: This feature is turned off.

**Current CPU Temperature**

This is the current temperature of the CPU.

**Current System Temperature**

This is the Current temperature of the system.

**Current CHASSISFAN / CPUFAN / PWRFAN Speed**

The current CPU fan speed in RPMs.

**CPU(V)**

The voltage level of the Vtt, Vcore, Vcc.

**+5V, +12V, -12V, -5V, VBAT, 5VSB:** The voltage level of the switch power supply.

**Shutdown Temperature**

This is the temperature that the computer will turn off the power to combat the effects of an overheating system. (requires ACPI to be enabled in Power Management BIOS and ACPI compliant operating system.) The default is 100°C/212°F.

Options available are 60°C/140°F to 100°C/212°F in increments of 5°C.

## 4-8 Frequency/Voltage Control

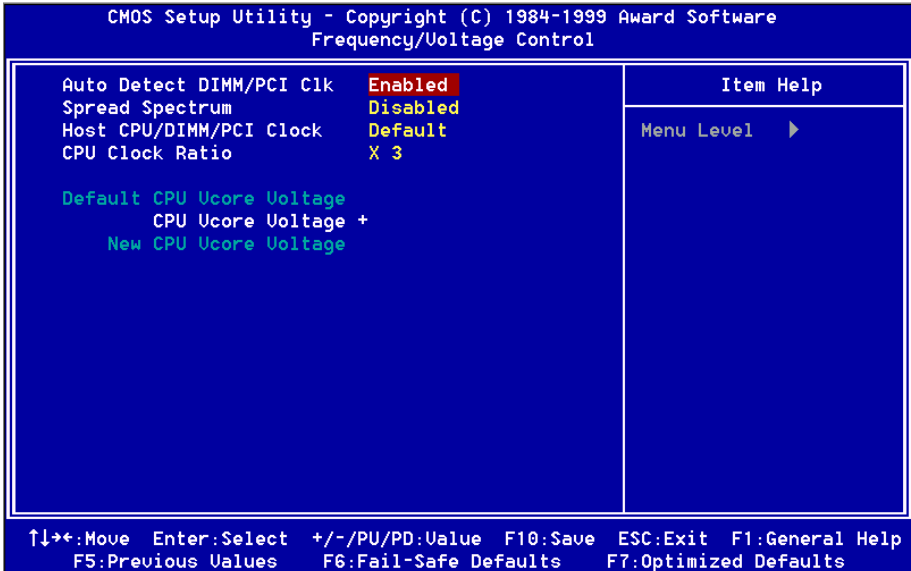

### Auto Detect DIMM/PCI Clk

This item allows you to enable/disable auto detect DIMM/PCI Clock.  
The choice: Enabled, Disabled.

### Spread Spectrum

This item allows you to enable/disable the spread spectrum modulate.  
The choice: Enabled, Disabled.

### Host CPU/DIMM/PCI Clock

The mainboard is designed to set the Host CPU/DIMM/PCI clock at jumperfree. This item allows you to select the CPU Host speed and PCI clock speed by “Enter” key. If “default” is means the CPU Host speed that depend on the CPU is 66MHz, 100MHz or 133MHz.

### CPU Clock Ratio

This item allows you to select the CPU ratio. If the CPU ratio is fixed. This item was no function. Configuration options: [3.x]...[7x], [7.5x], [8.x].

### CPU Vcore Voltage (Optional)

This item allows you to increase the CPU Vcore Voltage.

## 4-9 Defaults Menu

Selecting “Defaults” from the main menu shows you two options which are described below

### **Load Fail-Safe Defaults**

When you press <Enter> on this item you get a confirmation dialog box with a message similar to:

Load Fail-Safe Defaults (Y/N) ? N

Pressing ‘Y’ loads the BIOS default values for the most stable, minimal-performance system operations.

### **Load Optimized Defaults**

When you press <Enter> on this item you get a confirmation dialog box with a message similar to:

Load Optimized Defaults (Y/N) ? N

Pressing ‘Y’ loads the default values that are factory settings for optimal performance system operations.

## 4-10 Supervisor/User Password Setting

---

You can set either supervisor or user password, or both of them. The differences between are:

**supervisor password** : can enter and change the options of the setup menus.

**user password** : just can only enter but do not have the right to change the options of the setup menus. When you select this function, the following message will appear at the center of the screen to assist you in creating a password.

### ENTER PASSWORD:

Type the password, up to eight characters in length, and press <Enter>. The password typed now will clear any previously entered password from CMOS memory. You will be asked to confirm the password. Type the password again and press <Enter>. You may also press <Esc> to abort the selection and not enter a password. To disable a password, just press <Enter> when you are prompted to enter the password. A message will confirm the password will be disabled. Once the password is disabled, the system will boot and you can enter Setup freely.

### PASSWORD DISABLED.

When a password has been enabled, you will be prompted to enter it every time you try to enter Setup. This prevents an unauthorized person from changing any part of your system configuration.

Additionally, when a password is enabled, you can also require the BIOS to request a password every time your system is rebooted. This would prevent unauthorized use of your computer.

You determine when the password is required within the BIOS Features Setup Menu and its Security option (see Section 3). If the Security option is set to "System", the password will be required both at boot and at entry to Setup. If set to "Setup", prompting only occurs when trying to enter Setup.

## 4-11 Exit Selecting

### **Save & Exit Setup**

Pressing <Enter> on this item asks for confirmation:

**Save to CMOS and EXIT (Y/N)? Y**

Pressing “Y” stores the selections made in the menus in CMOS – a special section of memory that stays on after you turn your system off. The next time you boot your computer, the BIOS configures your system according to the Setup selections stored in CMOS. After saving the values the system is restarted again.

### **Exit Without Saving**

Pressing <Enter> on this item asks for confirmation:

**Quit without saving (Y/N)? Y**

This allows you to exit Setup without storing in CMOS any change. The previous selections remain in effect. This exits the Setup utility and restarts your computer.

Page Left Blank

---



---

Section 5  
810 Series VGA, Sound and LAN Driver  
Installation

---

### Easy Driver Installation



- Step 1 :** To Click the Intel 810/820 series Chipset INF Files that enable the Intel (R) 810 Chipsets to be recognized by listed operating systems. This installer will unpack updated .INF files into a specified folder. Supported operating systems: Microsoft Windows\* 95 OSR 2.1+ and Windows\* 98 operating systems.
- Step 2 :** To Click the Intel 810/820 series INF Installation Utility. This installer will install updated .INF files onto the target machine. Supported operating systems: Microsoft Windows\* 95 OSR 2.1+ and Windows\* 98 operating systems. This procedure will Re-start the system.
- Step 3 :** To Click the Intel 810 VGA Driver to installation the Graphics resolution.
- Step 4 :** To Click the Audio Driver/Utilities to installation the Audio Sound Driver in operating system.

**Step 5 :** The Lan Driver Path\810-820\lan  
Please follow this path to setup LAN driver.  
Files on configuration Disk

- ◆ Installing Novell network drivers
  - Workstation for DOS ODI Client
  - Workstation for OS/2 ODI Client
  - Sever Driver for NetWare 3.11
  - Sever Driver for NetWare 3.12
  - Sever Driver for NetWare 4.0
  - Sever Driver for NetWare 4.1X
  - Sever Driver for NetWare 5.0
  - Client 32 for Windows 95
  
- ◆ Installing IBM network drivers
  - LAN Server for OS/2 2.3
  - LAN Server got OS/2 4.0
  
- ◆ Installing Microsoft network drivers
  - Microsoft Network Client for DOS
  - LAN Manager Workstation/Server
  - Windows for Workgroups V3.11
  - Windows NT 3.5, 3.51 & 4.0

## Section 7

# PCI LAN Diagnostics Test

### **Introduction**

This document describes the parameter of Diagnostics program for REALTEK RTL8139 Fast Ethernet.

Location of Program: \810-820\LAN\RSET8139.EXE

The available parameters are:

/? : Show this message.

/T : Test the LAN and output to a log file.

### **TROUBLESHOOTING**

\* Please follow below to run the Diagnostic program.

1. Remove any add-on adapters from slot, except for VGA adapter.
2. Disable PnP OS support in BIOS.
3. Boot from DOS-only environment.
4. When the Diagnostic program is started, there are no any TSR programs running.
5. If the tests fail, it is onboard LAN function error.

### **EEPROM Test**

This test reads and verifies the content of the Serial ROM. The test fails if the onboard LAN configuration data kept in the Serial ROM returns with a bad checksum, meaning the onboard LAN may not be programmed properly, or the Serial ROM may be damaged.

### **Diagnostics On Board Test**

In this test, traffic is generated at the rate of 100Mbps or 10Mbps, packets are being interrupted and reflected at the MAC level without reaching the network cable. A fail test result represents a faulty Ethernet controller.

Page Left Blank

---

Appendix A

A-1 MEMORY MAP

Address Range	Size	Description
[0000-7FFFF]	512K	Conventional memory
[8000-9FBFF]	127K	Extended Conventional memory
[9FC00-9FFFF]	1K	Extended BIOS data area if PS/2 mouse is installed
[A0000-C7FFF]	160K	Available for Hi DOS memory
[C8000-DFFFF]	96K	Available for Hi DOS memory and adapter ROMs
[E0000-EEFFF]	60K	Available for UMB
[EF000-EFFFF]	4K	Video service routine for Monochrome & CGA adaptor
[F0000-F7FFF]	32K	BIOS CMOS setup utility
[F8000-FCFFF]	20K	BIOS runtime service routine (2)
[FD000-FDFFF]	4K	Plug and Play ESCD data area
[FE000-FFFFF]	8K	BIOS runtime service routine (1)

A-2 I/O MAP

[000-01F]	DMA controller.(Master)
[020-021]	INTERRUPT CONTROLLER.(Master)
[022-023]	CHIPSET control registers. I/O ports.
[040-05F]	TIMER control registers.
[060-06F]	KEYBOARD interface controller.(8042)
[070-07F]	RTC ports & CMOS I/O ports.
[080-09F]	DMA register.
[0A0-0BF]	INTERRUPT controller.(Slave)
[0C0-0DF]	DMA controller.(Slave)
[0F0-0FF]	MATH COPROCESSOR.
[1F0-1F8 ]	HARD DISK controller.
[278-27F]	PARALLEL port 2.
[2B0-2DF]	GRAPHICS adapter controller.

[2F8-2FF]	SERIAL port 2.
[360-36F]	NETWORK ports.
[378-37F]	PARALLEL port 1.
[3B0-3BF]	MONOCHROME & PARALLEL port adapter.
[3C0-3CF]	EGA adapter.
[3D0-3DF]	CGA adapter.
[3F0-3F7]	FLOPPY DISK controller.
[3F8-3FF]	SERIAL port 1.

### A-3 TIMER & DMA CHANNELS MAP

#### TIMER MAP:

TIMER Channel 0	System timer interrupt.
TIMER Channel 1	DRAM REFRESH request.
TIMER Channel 2	SPEAKER tone generator.

#### DMA CHANNELS:

DMA Channel 0	Available.
DMA Channel 1	Onboard ECP (Option).
DMA Channel 2	FLOPPY DISK (SMC CHIP).
DMA Channel 3	Onboard ECP (default).
DMA Channel 4	Cascade for DMA controller 1.
DMA Channel 5	Available.
DMA Channel 6	Available.
DMA Channel 7	Available

### A-4 INTERRUPT MAP

#### NMI :

Parity check error.

#### IRQ (H/W):

0	System TIMER interrupt from TIMER 0.
1	KEYBOARD output buffer full.
2	Cascade for IRQ 8-15.
3	SERIAL port 2.
4	SERIAL port 1.
5	PARALLEL port 2.

- 6 FLOPPY DISK (SMC CHIP).
- 7 PARALLEL port 1.
- 8 RTC clock.
- 9 Available.
- 10 Available.
- 11 Available.
- 12 PS/2 Mouse.
- 13 MATH coprocessor.
- 14 Onboard HARD DISK (IDE1) channel.
- 15 Onboard HARD DISK (IDE1) channel.

### A-5 RTC & CMOS RAM MAP

RTC & CMOS:

- 00 Seconds.
- 01 Second alarm.
- 02 Minutes.
- 03 Minutes alarm.
- 04 Hours.
- 05 Hours alarm.
- 06 Day of week.
- 07 Day of month.
- 08 Month.
- 09 Year.
- 0A Status register A.
- 0B Status register B.
- 0C Status register C.
- 0D Status register D.
- 0E Diagnostic status byte.
- 0F Shutdown byte.
- 10 FLOPPY DISK drive type byte.
- 11 Reserve.
- 12 HARD DISK type byte.
- 13 Reserve.
- 14 Equipment type.
- 15 Base memory low byte.

- 16 Base memory high byte.
- 17 Extension memory low byte.
- 18 Extension memory high byte.
- 19-2d
- 2E-2F
- 30 Reserved for extension memory low byte.
- 31 Reserved for extension memory high byte.
- 32 DATE CENTURY byte.
- 33 INFORMATION FLAG.
- 34-3F Reserve.
- 40-7F Reserved for CHIPSET SETTING DATA.



---

Appendix B

---

B-1 POST CODES

**For BIOS 6.0 Code**

<b>POST (hex)</b>	<b>DESCRIPTION</b>
CFh	Test CMOS R/W functionality.
C0h	Early chipset initialization: <ul style="list-style-type: none"> <li>- Disable shadow RAM</li> <li>- Disable L2 cache (socket 7 or below)</li> <li>- Program basic chipset registers</li> </ul>
C1h	Detect memory <ul style="list-style-type: none"> <li>- Auto-detection of DRAM size, type and ECC.</li> <li>- Auto-detection of L2 cache (socket 7 or below)</li> </ul>
C3h	Expand compressed BIOS code to DRAM
C5h	Call chipset hook to copy BIOS back to E000 & F000 shadow RAM.
0h1	Expand the Xgroup codes locating in physical address 1000:0
02h	Reserved
03h	Initial Superio_Early_Init switch.
04h	Reserved
05h	1. Blank out screen 2. Clear CMOS error flag
06h	Reserved
07h	1. Clear 8042 interface 2. Initialize 8042 self-test
08h	1. Test special keyboard controller for Winbond 977 series Super I/O chips. 2. Enable keyboard interface.
09h	Reserved
0Ah	1. Disable PS/2 mouse interface (optional). 2. Auto detect ports for keyboard & mouse followed by a port & interface swap (optional).

	3. Reset keyboard for Winbond 977 series Super I/O chips.
0Ch	Reserved
0Dh	Reserved
0Eh	Test F000h segment shadow to see whether it is R/W-able or not. If test fails, keep beeping the speaker.
0Fh	Reserved
10h	Auto detect flash type to load appropriate flash R/W codes into the run time area in F000 for ESCD & DMI support.
11h	Reserved
12h	Use walking 1's algorithm to check out interface in CMOS circuitry. Also set real-time clock power status, and then check for override.
13h	Reserved
14h	Program chipset default values into chipset. Chipset default values are MODBINable by OEM customers.
15h	Reserved
16h	Initial Early_Init_Onboard_Generator switch.
17h	Reserved
18h	Detect CPU information including brand, SMI type (Cyrix or Intel) and CPU level (586 or 686).
19h	Reserved
1Ah	Reserved
1Bh	Initial interrupts vector table. If no special specified, all H/W interrupts are directed to PURIOUS_INT_HDLR & S/W interrupts to SPURIOUS_soft_HDLR.
1Ch	Reserved
1Dh	Initial EARLY_PM_INIT switch.
1Eh	Reserved
1Fh	Load keyboard matrix (notebook platform)
20h	Reserved
21h	HPM initialization (notebook platform)
22h	Reserved
23h	<ol style="list-style-type: none"><li>1. Check validity of RTC value: e.g. a value of 5Ah is an invalid value for RTC minute.</li><li>2. Load CMOS settings into BIOS stack. If CMOS</li></ol>

- checksum fails, use default value instead.
  - 3. Prepare BIOS resource map for PCI & PnP use. If ESCD is valid, take into consideration of the ESCD's legacy information.
  - 4. Onboard clock generator initialization. Disable respective clock resource to empty PCI & DIMM slots.
  - 5. Early PCI initialization:
    - Enumerate PCI bus number
    - Assign memory & I/O resource
    - Search for a valid VGA device & VGA BIOS, and put it into C000:0.
- |     |   |
|-----|---|
| 24h | Reserved  |
| 25h | Reserved  |
| 26h | Reserved  |
| 27h | Initialize INT 09 buffer  |
| 28h | Reserved  |
| 29h | <ol style="list-style-type: none"> <li>1. Program CPU internal MTRR (P6 &amp; PII) for 0-640K memory address.</li> <li>2. Initialize the APIC for Pentium class CPU.</li> <li>3. Program early chipset according to CMOS setup.<br/>Example: onboard IDE controller.</li> <li>4. Measure CPU speed.</li> <li>5. Invoke video BIOS.</li> </ol> |
| 2Ah | Reserved  |
| 2Bh | Reserved  |
| 2Ch | Reserved  |
| 2Dh | <ol style="list-style-type: none"> <li>1. Initialize multi-language</li> <li>2. Put information on screen display, including Award title, CPU type, CPU speed ....</li> </ol>   |
| 2Eh | Reserved  |
| 2Fh | Reserved  |
| 30h | Reserved  |
| 31h | Reserved  |
| 32h | Reserved  |
| 33h | Reset keyboard except Winbond 977 series Super I/O chips.   |

---

34h	Reserved
35h	Reserved
36h	Reserved
37h	Reserved
38h	Reserved
39h	Reserved
3Ah	Reserved
3Bh	Reserved
3Ch	Test 8254
3Dh	Reserved
3Eh	Test 8259 interrupt mask bits for channel 1.
3Fh	Reserved
40h	Test 8259 interrupt mask bits for channel 2.
41h	Reserved
42h	Reserved
43h	Test 8259 functionality.
44h	Reserved
45h	Reserved
46h	Reserved
47h	Initialize EISA slot
48h	Reserved
49h	<ol style="list-style-type: none"><li>1. Calculate total memory by testing the last double word of each 64K page.</li><li>2. Program write allocation for AMD K5 CPU.</li></ol>
4Ah	Reserved
4Bh	Reserved
4Ch	Reserved
4Dh	Reserved
4Eh	<ol style="list-style-type: none"><li>1. Program MTRR of M1 CPU</li><li>2. Initialize L2 cache for P6 class CPU &amp; program CPU with proper cacheable range.</li><li>3. Initialize the APIC for P6 class CPU.</li><li>4. On MP platform, adjust the cacheable range to smaller one in case the cacheable ranges between each CPU are not identical.</li></ol>
4Fh	Reserved
50h	Initialize USB

---

---

51h	Reserved
52h	Test all memory (clear all extended memory to 0)
53h	Reserved
54h	Reserved
55h	Display number of processors (multi-processor platform)
56h	Reserved
57h	1. Display PnP logo 2. Early ISA PnP initialization - Assign CSN to every ISA PnP device.
58h	Reserved
59h	Initialize the combined Trend Anti-Virus code.
5Ah	Reserved
5Bh	(Optional Feature) Show message for entering AWDFLASH.EXE from FDD (optional)
5Ch	Reserved
5Dh	1. Initialize Init_Onboard_Super_IO switch. 2. Initialize Init_Onboard_AUDIO switch.
5Eh	Reserved
5Fh	Reserved
60h	Okay to enter Setup utility; i.e. not until this POST stage can users enter the CMOS setup utility.
61h	Reserved
62h	Reserved
63h	Reserved
64h	Reserved
65h	Initialize PS/2 Mouse
66h	Reserved
67h	Prepare memory size information for function call: INT 15h ax=E820h
68h	Reserved
69h	Turn on L2 cache
6Ah	Reserved
6Bh	Program chipset registers according to items described in Setup & Auto-configuration table.
6Ch	Reserved

---

---

6Dh	<ol style="list-style-type: none"><li>1. Assign resources to all ISA PnP devices.</li><li>2. Auto assign ports to onboard COM ports if the corresponding item in Setup is set to "AUTO".</li></ol>
6Eh	Reserved
6Fh	<ol style="list-style-type: none"><li>1. Initialize floppy controller</li><li>2. Set up floppy related fields in 40:hardware.</li></ol>
70h	Reserved
71h	Reserved
72h	Reserved
73h	(Optional Feature) Enter AWDFLASH.EXE if : - AWDFLASH is found in floppy drive. - ALT+F2 is pressed
74h	Reserved
75h	Detect & install all IDE devices: HDD, LS120, ZIP, CDROM.....
76h	Reserved
77h	Detect serial ports & parallel ports.
78h	Reserved
79h	Reserved
7Ah	Detect & install co-processor
7Bh	Reserved
7Ch	Reserved
7Dh	Reserved
7Eh	Reserved
7Fh	<ol style="list-style-type: none"><li>1. Switch back to text mode if full screen logo is supported. - If errors occur, report errors &amp; wait for keys - If no errors occur or F1 key is pressed to continue:     ◆Clear EPA or customization logo.</li></ol>
80h	Reserved
81h	Reserved
82h	<ol style="list-style-type: none"><li>1. Call chipset power management hook.</li><li>2. Recover the text fond used by EPA logo (not for full screen logo)</li><li>3. If password is set, ask for password.</li></ol>
83h	Save all data in stack back to CMOS

---

---

84h	Initialize ISA PnP boot devices
85h	<ol style="list-style-type: none"><li>1. USB final Initialization</li><li>2. NET PC: Build SYSID structure</li><li>3. Switch screen back to text mode</li><li>4. Set up ACPI table at top of memory.</li><li>5. Invoke ISA adapter ROMs</li><li>6. Assign IRQs to PCI devices</li><li>7. Initialize APM</li><li>8. Clear noise of IRQs.</li></ol>
86h	Reserved
87h	Reserved
88h	Reserved
89h	Reserved
90h	Reserved
91h	Reserved
92h	Reserved
93h	Read HDD boot sector information for Trend Anti-Virus code
94h	<ol style="list-style-type: none"><li>1. Enable L2 cache</li><li>2. Program boot up speed</li><li>3. Chipset final initialization.</li><li>4. Power management final initialization</li><li>5. Clear screen &amp; display summary table</li><li>6. Program K6 write allocation</li><li>7. Program P6 class write combining</li></ol>
95h	<ol style="list-style-type: none"><li>1. Program daylight saving</li><li>2. Update keyboard LED &amp; typematic rate</li></ol>
96h	<ol style="list-style-type: none"><li>1. Build MP table</li><li>2. Build &amp; update ESCD</li><li>3. Set CMOS century to 20h or 19h</li><li>4. Load CMOS time into DOS timer tick</li><li>5. Build MSIRQ routing table.</li></ol>
FFh	Boot attempt (INT 19h)

Page Left Blank

---



Appendix C

**NOTE:**

The "**LOAD Optimized DEFAULTS**" function loads the system default data directly from ROM and initializes the associated hardware properly. This function will be necessary when you accept this mainboard, or the system CMOS data is corrupted.

CMOS Setup Utility - Copyright ( C ) 1984-1998

Standard CMOS Feature	Frequency/Voltage Control
Advanced BIOS Feature	Load Fail-Safe Defaults
Advanced Chipset Feature	Load Optimized Defaults
Integrated Peripherals	Set Supervisor Password
Power Management S	Load Optimized Defaults (Y/N)? Y
PnP/PCI Configuratio	
PC Health Status	Exit Without Saving
Esc : Quit	↑ ↓ ← → : Select Item
F10 : Save & Exit Setup	
Time, Date, Hard Disk Type....	

**LOAD Optimized DEFAULTS**

Page Left Blank

---