

Mainboard User's Manual

This publication, including all photographs, illustrations and software, is protected under international copyright laws, with all rights reserved. Neither this manual, nor any of the material contained herein, may be reproduced without the express written consent of the manufacturer.

The information in this document is subject to change without notice. The manufacturer makes no representations or warranties with respect to the contents hereof and specifically disclaims any implied warranties of merchantability or fitness for any particular purpose. Further, the manufacturer reserves the right to revise this publication and to make changes from time to time in the content hereof without obligation of the manufacturer to notify any person of such revision or changes.

Trademarks

IBM, VGA, and PS/2 are registered trademarks of International Business Machines.

Intel, Pentium/II/III/IV, Celeron and MMX are registered trademarks of Intel Corporation.

Microsoft, MS-DOS and Windows NT/95/98/ME/2000 are registered trademarks of Microsoft Corporation.

PC-cillin is a registered trademark of Trend Micro Inc.

AMI is a registered trademark of American Megatrends Inc.

A3D is a registered trademark of Aureal Inc.

MediaRing Talk is a registered trademark of MediaRing Inc.

3Deep is a registered trademark of E-Color Inc.

SiS is a trademark of Silicon Integrated System Corporation.

Other names used in this publication may be trademarks and are acknowledged.

**Copyright © 2001
All Rights Reserved
MS9307C Series, V3.0
S645/December 2001**

Mainboard User's Manual

Mainboard User's Manual

Table of Contents

Trademarks	I
Chapter 1	1
Introduction	1
Key Features	2
Package Contents	5
Static Electricity Precautions	6
Pre-Installation Inspection	6
Chapter 2.....	7
Mainboard Installation	7
Mainboard Components.....	8
I/O Ports	9
Install A CPU.....	10
Installing Memory Modules.....	11
Setting Jumper Switches.....	13
Install the Mainboard.....	13
Optional Extension Brackets.....	15
Install Other Devices	17
Expansion Slots.....	19
Chapter 3.....	21
BIOS Setup Utility	21
Introduction.....	21
Running the Setup Utility	22
Standard CMOS Setup Page	23
Advanced Setup Page	24
Power Management Setup Page.....	26
PCI / Plug and Play Setup Page	27
Load Optimal Settings	28
Load Best Performance Settings.....	28
Features Setup Page	29
CPU PnP Setup Page	31
Hardware Monitor Page.....	32
Change Password.....	33
Exit.....	33
Chapter 4: Using the Mainboard Software	35
About the Software CD-ROM.....	35
Utility Software Reference.....	36

Mainboard User's Manual

Chapter 1

Introduction

This mainboard has a **Socket-478** processor socket for **Intel Pentium 4** type of processors supporting front side bus (FSB) speeds up to **400 MHz**.

This mainboard uses the **SiS645** chipset which supports built-in **AC97 Codec**, **2 DDR + 2 SDR** modules up to 2GB system memory, and provides **Ultra DMA 33/66/100** function. This mainboard has one **4X AGP** slot for highly graphics display. In addition, this mainboard has a full set of I/O ports including two PS/2 ports for mouse and keyboard, two serial ports, one parallel port, one MIDI/game port and six USB ports (two backpanel ports, onboard USB headers providing four extra ports). By means of the Extended USB Module connected to the mainboard, you can make two extra USB ports.

This mainboard is an ATX mainboard that uses a 4-layer printed circuit board and measures 305 x 244mm.

Mainboard User's Manual

Key Features

The key features of this mainboard include:

Socket-478 Processor

- ◆ The PGA Socket 478
- ◆ Supports **Intel Pentium 4 series** CPUs
- ◆ Supports up to 400 MHz Front-Side Bus

Memory Support

- ◆ Two 168-pin DIMM slots for SDRAM memory modules
- ◆ Two 184-pin DIMM slots for DDR memory modules
- ◆ Support SDRAM up to 133 MHz /DDR up to 333 MHz memory bus
- ◆ Maximum installed memory is 2GB

Notice: You can NOT use SDRAM and DDR simultaneously.

Expansion Slots

- ◆ One 4xAGP slot for AGP 2.0-compliant interface
- ◆ One ACR slot (Audio Communication Riser)
- ◆ Four 32-bit PCI slots for PCI 2.2-compliant bus interface

Onboard IDE channels

- ◆ Primary and Secondary PCI IDE channels
- ◆ Support for PIO (programmable input/output) modes
- ◆ Support for Multiword DMA modes
- ◆ Support for Bus Mastering and Ultra DMA 33/66/100 modes

Power Supply and Power Management

- ◆ ATX power supply connector
- ◆ Meets ACPI 1.0b and APM 1.2 requirements, keyboard power on/off
- ◆ Supports RTC Alarm, Wake On Modem, AC97 Wake-Up and USB Wake-Up

1: Introduction

AC97 Audio Codec

- ◆ Compliant AC97 2.2 specification
- ◆ Supports 18-bit ADC (Analog Digital Converter) and DAC (Digital Analog Converter) as well as 18-bit stereo full-duplex codec

Onboard I/O Ports

The mainboard has a full set of I/O ports and connectors:

- ◆ Two PS/2 ports for mouse and keyboard
- ◆ Two serial ports
- ◆ One parallel port
- ◆ One MIDI/game port
- ◆ Six USB ports (two backpanel ports, onboard USB headers providing four extra ports)
- ◆ Audio jacks for microphone, line-in and line-out

Hardware Monitoring

- ◆ Built-in hardware monitoring for CPU & System temperatures, fan speeds and mainboard voltages.

Onboard Flash ROM

- ◆ Supports Plug and Play configuration of peripheral devices and expansion cards

Mainboard User's Manual

Bundled Software

- ◆ **PC-Cillin2000** provides automatic virus protection under Windows 95/98/NT/2000
- ◆ **MediaRing Talk** provides PC to PC or PC to Phone internet phone communication
- ◆ **SuperVoice** is data, fax and voice communication software
- ◆ **WinDVD2000** is a DVD playback application (optional)
- ◆ **Recovery Genius 21st V5.0** provides the function to recover, reserve and transfer hard disk data.
- ◆ **CD Ghost** is the software stimulating a real CD-ROM to perform equivalent function.
- ◆ **Language Genius 21st** is the software to provides learning tools of language and singing.

Dimensions

- ◆ ATX form factor 305 x 244mm

1: Introduction

Package Contents

Your mainboard package contains the following items:

- The mainboard
- The User's Manual
- One diskette drive ribbon cable
- One IDE drive ribbon cable
- Software support CD
- Module Retention damp

Optional Accessories

You can purchase the following optional accessories for this mainboard.

- Extended USB module
- AMR v.90 56K Fax/Modem card

Mainboard User's Manual

Static Electricity Precautions

Components on this mainboard can be damaged by static electricity. Take the following precautions when unpacking the mainboard and installing it in a system.

1. Keep the mainboard and other components in their original static-proof packaging until you are ready to install them.
2. During installation, wear a grounded wrist strap if possible. If you don't have a wrist strap, discharge static electricity by touching the bare metal of the system chassis.
3. Handle the mainboard carefully by the edges. Avoid touching the components unless it is absolutely necessary. During installation put the mainboard on top of the static-protection packaging it came in with the component side facing up.

Pre-Installation Inspection

1. Inspect the mainboard for damage to the components and connectors on the board.
2. If you suspect that the mainboard has been damaged, do not connect power to the system. Contact your mainboard vendor and report the damage.

Chapter 2

Mainboard Installation

To install this mainboard in a system, please follow the instructions in this chapter:

- ❑ Identify the mainboard components
- ❑ Install a CPU
- ❑ Install one or more system memory modules
- ❑ Verify that all jumpers or switches are set correctly
- ❑ Install the mainboard in a system chassis (case)
- ❑ Connect any extension brackets or cables to connecting headers on the mainboard
- ❑ Install other devices and make the appropriate connections to the mainboard connecting headers.

Note:

1. Before installing this mainboard, make sure jumper JP4 is under Normal setting. See this chapter for information about locating JP4 and the setting options.
2. Never connect power to the system during installation; otherwise, it may damage the mainboard.

Mainboard User's Manual

Mainboard Components

Use the diagram below to identify the major components on the mainboard.

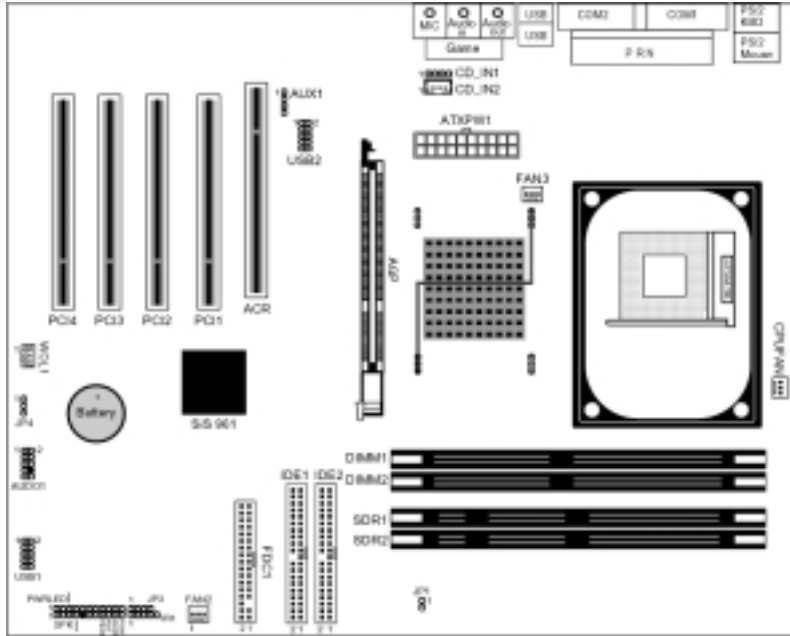

Note: Any jumpers on your mainboard that do not appear in the illustration above are for testing only.

2: Mainboard Installation

I/O Ports

The illustration below shows a side view of the built-in I/O ports on the mainboard.

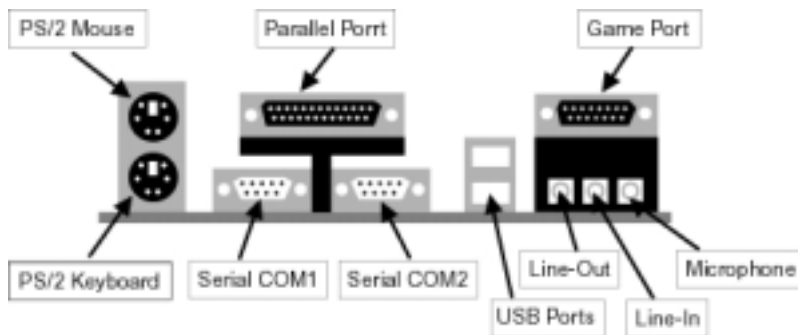

1. Use the upper PS/2 port to connect a PS/2 pointing device.
2. Use the lower PS/2 port to connect a PS/2 keyboard.
3. Use the USB ports to connect USB devices.
4. Use LPT1 to connect printers or other parallel communications devices.
5. Use the COM ports to connect serial devices such as mice or fax/modems. COM1 is identified by the system as COM1/3. COM2 is identified by the system as COM2/4.
6. Use the game port to connect a joystick or a MIDI device.
7. Use the three audio ports to connect audio devices. The left side jack is for a stereo line-out signal. The middle jack is for a stereo line-in signal. The right side jack is for a microphone.

Mainboard User's Manual

Install A CPU

This mainboard has a Socket-478 which supports Intel Pentium 4 series processors.

To ensure reliability, ensure that your processor has a heatsink/cooling fan assembly.

Do neither try to install a Socket 370 processor nor a Socket423 in the Socket-478. A Socket 370 processor such as the Pentium III, or Celeron , does not fit in the Socket 478.

The following processor is currently supported by this mainboard.

Intel P4 478: 1.4GHz ~ 2.2GHz, FSB: 400MHz

Installing a Socket-478 Processor

A processor installs into the ZIF (Zero Insertion Force) Socket-478 on the mainboard.

1. Locate the Socket-478 and CPUFAN. Pull the locking lever out slightly from the socket and raise it to the upright position.

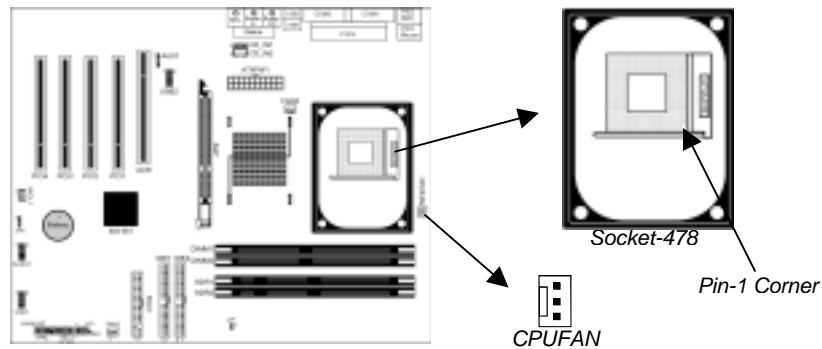

2. On the processor, identify the Pin-1 corner by its beveled edge.
3. On the Socket-478, identify the Pin-1 corner. The Pin-1 corner is at the top of the locking lever when it is locked.
4. Match the Pin-1 corners and insert the processor into the socket. No force is required and the processor should drop into place freely.

2: Mainboard Installation

5. Swing the locking lever down and hook it under the catch on the side of the socket. This secures the CPU in the socket.
6. All processors should be installed with a combination heatsink/cooling fan, connect the cable from the fan to the CPU fan power connector CPUFAN.

Installing Memory Modules

This mainboard accommodates 168-pin 3.3V/184-pin 2.5V unbuffered SDRAM memory modules. The memory chips must be standard or registered SDRAM (Synchronous Dynamic Random Access Memory).

The CPU supports 100MHz system bus. The SDRAM DIMMs and DDRs can synchronously work with 100 MHz or operates over a 333 MHz system bus.

You must install at least one memory module in order to use the mainboard, **either SDRAM or DDR SDRAM, but you can not use them simultaneously.**

DDR SDRAM provides 800 MBps or 1 GBps data transfer depending on whether the bus is 100 MHz or 333 MHz. It doubles the rate to 1.0 GBps and 2.1 GBps by transferring data on both the rising and falling edges of the clock. DDR SDRAM uses additional power and ground lines and requires 184-pin 2.5V unbuffered DIMM module rather than the 168-pin 3.3V unbuffered DIMMs used by SDRAM.

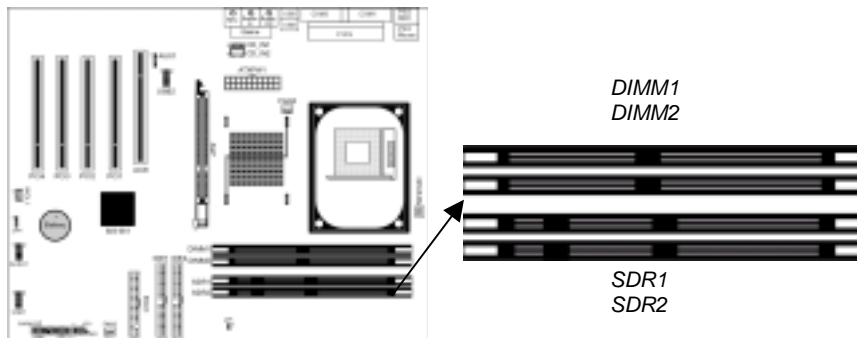

Mainboard User's Manual

Installation Procedure

The mainboard accommodates two memory modules. You must install at least one module in any of the three slots. Each module can be installed with up to 2GB system memory.

Refer to the following to install the memory modules.

1. Push the latches on each side of the DIMM slot down.
2. Align the memory module with the slot. The DIMM slots are keyed with notches and the DIMMs are keyed with cutouts so that they can only be installed correctly.
3. Check that the cutouts on the DIMM module edge connector match the notches in the DIMM slot.
4. Install the DIMM module into the slot and press it firmly down until it seats correctly. The slot latches are levered upwards and latch on to the edges of the DIMM.
5. Install any remaining DIMM modules.

2: Mainboard Installation

Setting Jumper Switches

Jumpers are sets of pins connected together with jumper caps. The jumper caps change the way the mainboard operates by changing the electronic circuits on the mainboard. If a jumper cap connects two pins, we say the pins are **SHORT**. If a jumper cap is removed from two pins, the pins are **OPEN**.

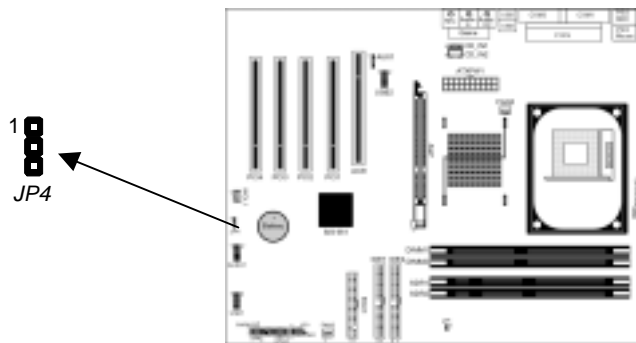

Jumper JP4: Clear CMOS Memory

Use this jumper to clear the contents of the CMOS memory. You may need to clear the CMOS memory if the settings in the Setup Utility are incorrect and prevent your mainboard from operating. To clear the CMOS memory, disconnect all the power cables from the mainboard and then move the jumper cap into the **CLEAR** setting for a few seconds.

Function	Jumper Setting
Clear CMOS	Short Pins 1-2
Normal Mode	Short Pins 2-3

Install the Mainboard

Install the mainboard in a system chassis (case). The board is an ATX size mainboard with a twin-tier of I/O ports. You can install this mainboard in an ATX case. Ensure that your case has an I/O cover plate that matches the ports on this mainboard.

Mainboard User's Manual

Install the mainboard in a case. Follow the instructions provided by the case manufacturer using the hardware and internal mounting points on the chassis.

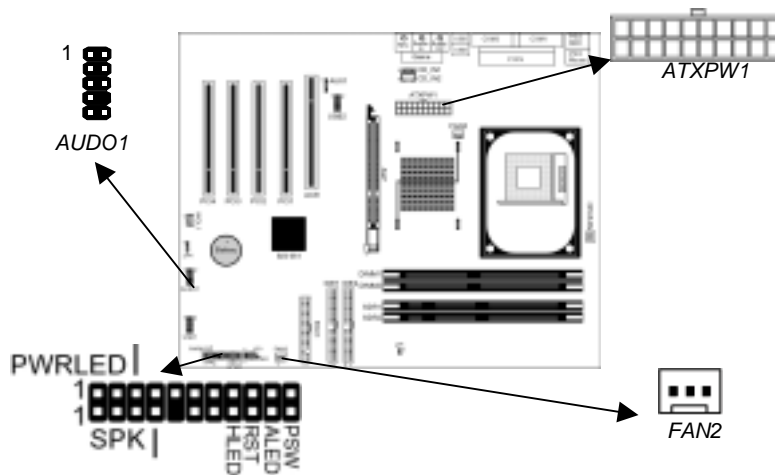

Connect the power connector from the power supply to the **ATXPW1** connector on the mainboard.

If there is a cooling fan installed in the system chassis, connect the cable from the cooling fan to the **FAN2** fan power connector on the mainboard.

Connect the cable from the PC speaker to the **SPK** header on the mainboard.

Connect the case switches and indicator LEDs to the **PWRLED** header. If there are a headphone jack or/and a microphone jack on the front panel, connect the cables to the **AUDIO1** header on the mainboard. See the illustrations below for the guide to the **PWRLED**, **SPK** and **AUDIO1** headers pin assignments.



2: Mainboard Installation

Optional Extension Brackets

For this mainboard, you can also obtain a USB module extension bracket for more USB ports. Install them by following the steps below.

Note: All the ribbon cables used on the extension brackets have a red stripe on the Pin-1 side of the cable.

Extended USB Module

This module bracket has four USB ports for more USB devices (USB port 3-6).

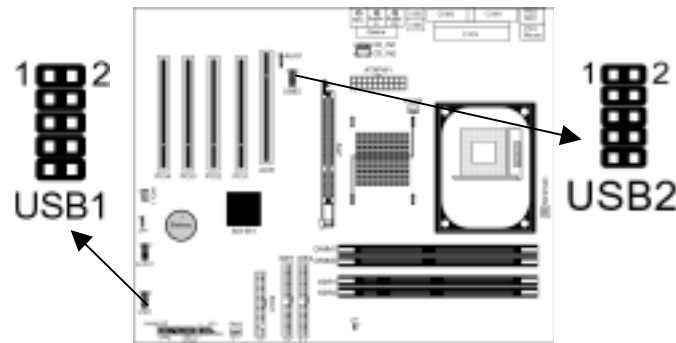

1. Locate the USB1/USB2 header on the mainboard.
2. Plug the bracket cable onto the USB1/USB2 header.
3. In the system chassis, remove a slot cover from one of the expansion slots and install the extension bracket in the opening. Use the screw that held the slot cover in place to secure the extension bracket to the chassis.

Mainboard User's Manual

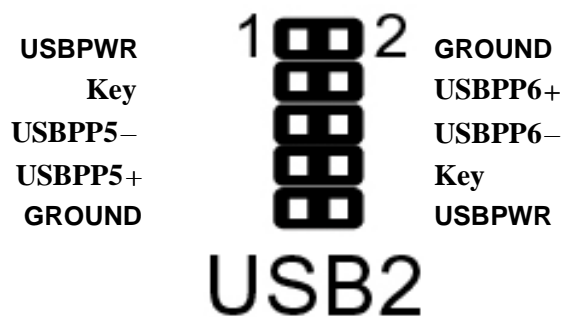
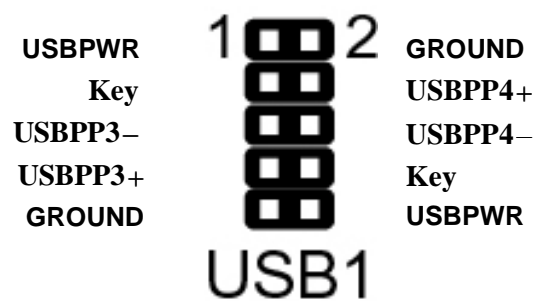

2: Mainboard Installation

Install Other Devices

Install and connect other devices in the system as steps below.

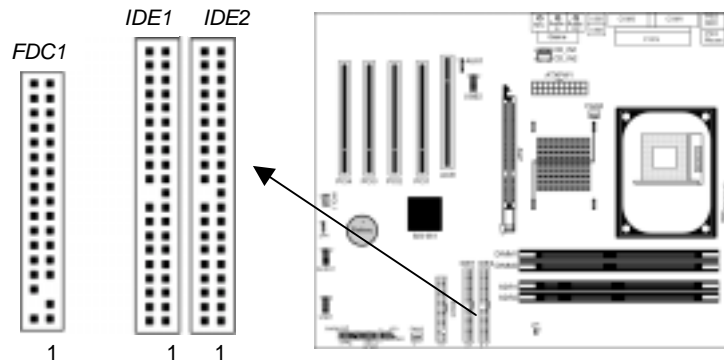

Floppy Disk Drive

The mainboard ships with a floppy disk drive cable that can support one or two drives. Drives can be 3.5" or 5.25" wide, with capacities of 360K, 720K, 1.2MB, 1.44MB, or 2.88MB.

Install your drives and connect power from the system power supply. Use the cable provided to connect the drives to the floppy disk drive connector **FDC1**.

IDE Devices

IDE devices include hard disk drives, high-density diskette drives, and CD-ROM or DVD-ROM drives, among others.

The mainboard ships with an IDE cable that can support one or two IDE devices. If you connect two devices to a single cable, you must configure one of the drives as Master and one of the drives as Slave. The documentation of the IDE device will tell you how to configure the device as a Master or Slave device. The Master device connects to the end of the cable.

Install the device(s) and connect power from the system power supply. Use the cable provided to connect the device(s) to the Primary IDE channel connector **IDE1** on the mainboard.

If you want to install more IDE devices, you can purchase a second IDE cable and connect one or two devices to the Secondary IDE channel connector **IDE2** on the mainboard. If you have two devices on the cable, one must be Master and one must be Slave.

Mainboard User's Manual

Internal Sound Connections

If you have installed a CD-ROM drive or DVD-ROM drive, you can connect the drive audio cable to the onboard sound system.

On the mainboard, locate the two 4-pin connectors **CD_IN1** and **CD_IN2**. There are two kinds of connector because different brands of CD-ROM drive have different kinds of audio cable connectors. Connect the cable to the appropriate connector.

If you have installed a secondary CD-ROM drive or DVD-ROM drive, you can connect the drive audio cable to the onboard sound system. On the mainboard, locate the 4-pin Aux-In header **AUX1**, connect the cable to the connector.

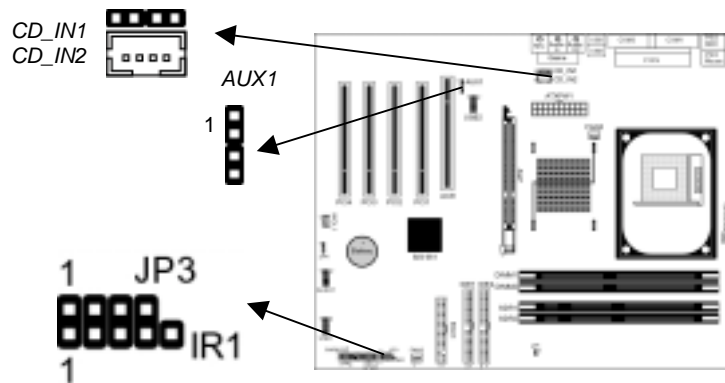

Infrared Port

You can connect an infrared port to the mainboard. You can purchase this option from third-party vendors.

1. Locate the infrared port **IR1** header on the mainboard.
2. If you are adding an infrared port, connect the ribbon cable from the port to the IR header and then secure the port to an appropriate place in your system chassis.

2: Mainboard Installation

Expansion Slots

This mainboard has four 32-bit PCI slots, one ACR slot and one AGP slot.

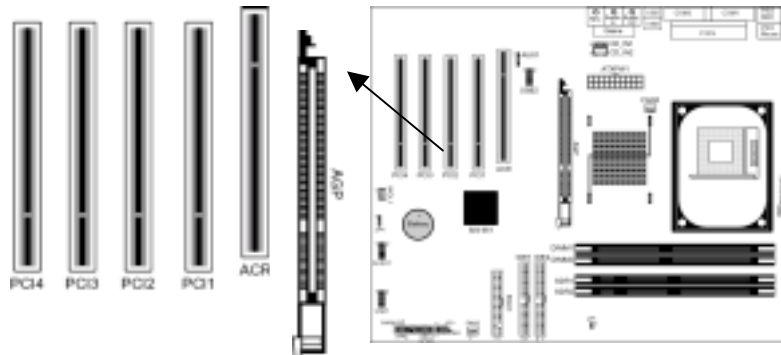

Follow the steps below to install a PCI/ACR/AGP expansion card.

1. Locate the AGP or PCI slots on the mainboard.
2. Remove this slot cover from the system chassis.
3. Insert the expansion card edge connector into the slot and press it firmly down into until fully inserted.
4. Secure the expansion card bracket to the system chassis with the screw that held the slot cover.

Mainboard User's Manual

Chapter 3

BIOS Setup Utility

Introduction

The BIOS Setup Utility records settings and information about your computer such as the date and time, the type of installed hardware, and various configuration settings. Your computer applies that information to initialize all the components while booting up, and the basic functions of coordination between system components.

If the Setup Utility configuration is incorrect, it may cause the system to malfunction. It can even stop your computer booting properly. If it happens, you can use the clear CMOS jumper to clear the CMOS memory that has stored the configuration information; or you can hold down the **Page Up** key while rebooting your computer. Holding down the **Page Up** key also clears the setup information.

You can run the setup utility and manually change the configuration. You might need to do this to configure some hardware installed in or connected to the mainboard, such as the CPU, system memory, disk drives, etc.

Mainboard User's Manual

Running the Setup Utility

Every time you start your computer, a message appears on the screen before the operating system loading that prompts you to “Hit if you want to run SETUP”. Whenever you see this message, press the **Delete** key and the Main menu page of the Setup Utility appears on your monitor.

AMIBIOS SIMPLE SETUP UTILITY – VERSION 1.21.06
(C) 2000 American Megatrends, Inc. All Rights Reserved

Standard CMOS Setup	Features Setup
Advanced Setup	CPU PnP Setup
Power Management Setup	Hardware Monitor
PCI / Plug and Play Setup	Change Password
Load Optimal Settings	Exit
Load Best Performance Settings	
Esc : Quit ↑ ↓ ← →: Select Item (Shift)F2 : Change Color F5 : Old Values F6 : Optimal values F7 : Best performance values F10 : Save&Exit	
Standards CMOS setup for changing time, date, hard disk type, etc.	

You can use cursor arrow keys to highlight anyone of options on the main menu page. Press **Enter** to select the highlighted option. Press the **Escape** key to leave the setup utility. Hold down the **Shift** key and press **F2** to cycle through the Setup Utility's optional color schemes.

Some options on the main menu page lead to tables of items with installed values that you can use cursor arrow keys to highlight one item, and press **PgUp** and **PgDn** keys to cycle through alternative values of that item. The other options on the main menu page lead to dialog boxes that require your answer Yes or No by hitting the **Y** or **N** keys.

If you have already changed the setup utility, press **F10** to save those changes and exit the utility. Press **F5** to reset the changes to the original values. Press **F6** to install the setup utility with a set of default values. Press **F7** to install the setup utility with a set of high-performance values.

3: BIOS Setup Utility

Standard CMOS Setup Page

This page helps you set up basic information such as the date and time, the IDE devices, and the diskette drives.

AMIBIOS SETUP – STANDARD CMOS SETUP										
(C) 2000 American Megatrends, Inc. All Rights Reserved										
Date (mm/dd/yy) : Wed Dec.5, 2001										
Time (hh/mm/ss) : 14:39:06										
	Type	Size	Cyln	Head	WPcom	Sec	Mode	LBA Blk Mode	PIO Mode	32Bit Mode
Pri Master	: Auto									On
Pri Slave	: Auto									On
Sec Master	: Auto									On
Sec Slave	: Auto									On
Floppy Drive A : 1.44 MB 3 1/2										
Floppy Drive B : Not Installed										
Month : Jan – Dec					ESC : Exit					
Day : 01 – 31					↑↓ : Select Item					
Year : 1901 – 2099					PU/PD/+/- : Modify					
					(Shif)F2 : Color					
					F3 : Detect All HDD					

Date & Time	Use these items to set the system date and time
Pri Master	Use these items to configure devices connected to the Primary and Secondary IDE channels. To configure an IDE hard disk drive, choose <i>Auto</i> . If the <i>Auto</i> setting fails to find a hard disk drive, set it to <i>User</i> , and then fill in the hard disk characteristics (Size, Cyls, etc.) manually. If you have a CD-ROM drive, select the setting <i>CDROM</i> . If you have an ATAPI device with removable media (e.g. a ZIP drive or an LS-120) select <i>Floptical</i> .
Pri Slave	
Sec Master	
Sec Slave	
Floppy Drive A	Use these items to set the size and capacity of the floppy diskette drive(s) installed in the system.
Floppy Drive B	

Mainboard User's Manual

Advanced Setup Page

This page sets up more advanced information about your system. Take care of this page with caution. Any changes can affect the operation of your computer.

AMIBIOS SETUP – ADVANCED SETUP		
(C) 2000 American Megatrends, Inc. All Rights Reserved		
Quick Boot	Enabled	
1 st Boot Device	IDE-0	
2 nd Boot Device	Floppy	
3 rd Boot Device	CDROM	
Try Other Boot Devices	Yes	
S.M.A.R.T. for Hard Disks	Disabled	
BootUp Num-Lock	On	
Floppy Drive Swap	Disabled	
Floppy Drive Seek	Disabled	
Password Check	Setup	
Boot To OS/2 > 64MB	No	ESC : Quit ↑↓←→ : Select Item
L2 Cache	Enabled	F1 : Help PU/PD/+/- : Modify
System BIOS Cacheable	Disabled	F5 : Old Values (Shift)F2 : Color
Graphic Win Size	4M	F6 : Load BIOS Defaults
DRAM CAS# Latency	3T	F7 : Load Setup Defaults
Timing Setting Mode	Normal	
MA 1T/2T Select	Auto	
Advanced Read Prefetch	Enabled	
Auto Detect DIMM/PCI Clk	Enabled	
Spread Spectrum	Disabled	

Quick Boot	If you enable this item, the system starts up more quickly by eliminating some of the power on test routines.
1st Boot Device 2nd Boot Device 3rd Boot Device	Use these items to determine the device order the computer uses to look for an operating system to load at start-up time.
Try Other Boot Device	If you enable this item, the system will also search for other boot devices if it fails to find an operating system from the first two locations.
S.M.A.R.T. for Hard Disks	Enable this item if any IDE hard disks support the S.M.A.R.T. (Self-Monitoring, Analysis and Reporting Technology) feature.
BootUp Num-Lock	This item determines if the Num Lock key is active or inactive at system start-up time.

3: BIOS Setup Utility

Floppy Drive Swap	If you have two diskette drives installed and you enable this item, drive A becomes drive B and drive B becomes drive A.
Floppy Drive Seek	If you enable this item, your system will check all floppy disk drives at start up. Disable this item unless you are using an old 360KB drive.
Password Check	If you have entered a password for the system, use this item to determine, if the password is required to enter the Setup Utility (<i>Setup</i>) or required both at start-up and to enter the Setup Utility (<i>Always</i>).
Boot to OS/2 > 64MB	Enable this item if you are booting the OS/2 operating system and you have more than 64MB of system memory installed.
L2 Cache	Leave these items enabled since all the processors that can be installed on this board have internal L2 cache memory.
System BIOS Cacheable	If you enable this item, a segment of the system BIOS will be copied to main memory for faster execution.
Graphic Win Size	This item defines the size of aperture if you use a graphic adapter.
DRAM CAS# Latency	This item determines the operation of DRAM memory CAS (column address strobe). It is recommended that you leave this item at the default value. The 3T setting requires faster memory that specifically supports this mode.
Timing Setting Mode	This item determines the timing setting mode of the memory. We recommend that you leave this item at the default value.
MA 1T/2T Select	This item adjusts timing 1T/2T latency. We recommend you leave this item at the default value.
Advanced Read Prefetch	This item enables prefetching for reading data. We recommend you leave this item at the default value.
Auto detect DIMM/PCI Clk	When this item is enabled, BIOS will disable the clock signal of free DIMM/PCI slots.
Spread Spectrum	If you enable spread spectrum, it can significantly reduce the EMI(Electro-Magnetic Interference) generated by the system.

Mainboard User's Manual

Power Management Setup Page

This page sets some of the parameters for system power management operation.

AMIBIOS SETUP – POWER MANAGEMENT SETUP (C) 2000 American Megatrends, Inc. All Rights Reserved		
ACPI Aware O/S	Yes	
Power Management	Enabled	
Suspend Time out	Disabled	
Hard Disk Time out	Disabled	
Resume On RTC Alarm	Disabled	ESC : Quit ↑↓←→ : Select Item F1 : Help PU/PD+/- : Modify F5 : Old Values (Shift)F2 : Color F6 : Load BIOS Defaults F7 : Load Setup Defaults
RTC Alarm Date	15	
RTC Alarm Hour	12	
RTC Alarm Minute	30	
RTC Alarm Second	30	
LAN/Ring Power On	Disabled	
Keyboard Power On	Disabled	

ACPI Aware O/S	Enable this item if you are using an O/S that supports ACPI function such as Windows 98/ME /2000.
Power Management	Use this item to select a power management scheme. Both APM and ACPI are supported.
Suspend Time Out	This sets the timeout for Suspend mode in minutes. If the time selected passes without any system activity, the computer will enter power-saving Suspend mode.
Hard Disk Time Out	This sets the timeout to power down the hard disk drive, if the time selected passes without any hard disk activity.
Resume On RTC Alarm Date / Hour / Minute / Second	The system can be turned off with a software command. If you enable this item, the system can automatically resume at a fixed time based on the system's RTC (realtime clock). Use the items below this one to set the date and time of the wake-up alarm. You must use an ATX power supply in order to use this feature.
LAN/Ring Power On	The system can be turned off with a software command. If you enable this item, the system can automatically resume if there is an incoming call on the Modem. You must use an ATX power supply in order to use this feature.

3: BIOS Setup Utility

KeyBoard Power On	If you enable this item, you can turn the system on and off by pressing hot keys on the keyboard. You must enable the Keyboard Power On jumper and use an ATX power supply in order to use this feature.
--------------------------	----------------------------------------------------------------------------------------------------------------------------------------------------------------------------------------------------------

PCI / Plug and Play Setup Page

This page sets some of the parameters for devices installed on the PCI bus and devices that use the system plug and play capability.

AMIBIOS SETUP – PCI / PLUG AND PLAY SETUP (C) 2000 American Megatrends, Inc. All Rights Reserved	
Plug and Play Aware O/S	Yes
Primary Graphics Adapter	PCI
Allocate IRQ for PCI VGA	Yes
ESC : Quit ↑↓←→ : Select Item F1 : Help PU/PD/+/- : Modify F5 : Old Values (Shift)F2 : Color F6 : Load BIOS Defaults F7 : Load Setup Defaults	

Plug and Play Aware O/S	Enable this item if you are using an O/S that supports Plug and Play such as Windows 95/98/ME.
Primary Graphics Adapter	This item indicates if the primary graphics adapter uses the PCI or the AGP bus. The default PCI setting still lets the onboard display work and allows the use of a second display card installed in a PCI slot.
Allocate IRQ to PCI VGA	If this item is enabled, an IRQ will be assigned to the PCI VGA graphics system. You set this value to No to free up an IRQ.

Mainboard User's Manual

Load Optimal Settings

If you select this item and press **Enter** a dialog box appears. If you press **Y**, and then **Enter**, the Setup Utility loads a set of fail-safe default values. These default values are not very demanding and they should allow your system to function with most kinds of hardware and memory chips.

Note: It is highly recommended that users enter this option to load optimal values for accessing the best performance.

Load Best Performance Settings

If you select this item and press **Enter** a dialog box appears. If you press **Y**, and then **Enter**, the Setup Utility loads a set of best-performance default values. These default values are quite demanding and your system might not function properly if you are using slower memory chips or other low-performance components.

3: BIOS Setup Utility

Features Setup Page

This page sets some of the parameters for peripheral devices connected to the system.

AMBIOS SETUP – FEATURES SETUP		
(C) 2000 American Megatrends, Inc. All Rights Reserved		
OnBoard FDC	Enabled	
OnBoard Serial PortA	3F8h/COM1	
OnBoard Serial PortB	2F8h/COM2	
Serial Port2 Mode	Normal	
OnBoard Parallel Port	378h	
Parallel Port Mode	ECP	
Parallel Port IRQ	7	
Parallel Port DMA	3	ESC : Quit ↑↓←→ : Select Item
OnBoard Game Port	201h	F1 : Help PU/PD/+/- : Modify
OnBoard MIDI Port	300h	F5 : Old Values (Shift)F2 : Color
MIDI Port IRQ	10	F6 : Load BIOS Defaults
OnBoard PCI IDE	Both	F7 : Load Setup Defaults
Audio Device	Enabled	
Modem Device	Enabled	
Ethernet Device	Enabled	
Onboard USB Function	Enabled	
USB Function for DOS	Disabled	

OnBoard FDC	Use this item to enable or disable the onboard floppy disk drive interface.
OnBoard Serial PortA/B	Use these items to enable or disable the onboard COM1/2 serial port, and to assign a port address.
Serial Port2 Mode	Use this item to allocate the resources of the second serial port. Under Normal, the resources are allocated to the onboard serial port. Under ASKIR or IrDA, the resources are allocated to the onboard IR port.
Onboard Parallel Port	Use this item to enable or disable the onboard LPT1 parallel port, and to assign a port address. The Auto setting will detect and available address.
Parallel Port Mode	Use this item to set the parallel port mode. You can select SPP (Standard Parallel Port), ECP (Extended Capabilities Port), EPP (Enhanced Parallel Port), or ECP + EPP.
Parallel Port IRQ	Use this item to assign either IRQ 5 or 7 to the parallel port.

Mainboard User's Manual

Parallel Port DMA	Use this item to assign a DMA channel to the parallel port. The options are 0, 1 and 3.
OnBoard Game Port	Use this item to enable or disable the onboard Game port.
OnBoard MIDI Port	Use this item to enable or disable the onboard MIDI port, and to assign a port address.
MIDI Port IRQ	Use this item to assign an IRQ to the MIDI port.
Onboard PCI IDE	Use this item to enable or disable either or both of the onboard Primary and Secondary IDE channels.
Audio Device	This item enables or disables the onboard AC'97 audio chip.
Modem Device	This item enables or disables the onboard AC'97 modem chip.
Ethernet Device	This item enables or disables the onboard Ethernet LAN.
Onboard USB Function	Enable this item if you plan to use the USB ports on this mainboard.
USB Function for DOS	Enable this item if you plan to use the USB ports on this mainboard in a DOS environment.

3: BIOS Setup Utility

CPU PnP Setup Page

This page lets you manually configure the mainboard for the CPU. The system will automatically detect the kind of CPU that you have installed and make the appropriate adjustments to the items on this page.

AMIBIOS SETUP - CPU PnP SETUP	
©2000 American Megatrends, Inc. All Rights Reserved	
CPU Type	Intel P4
CPU/DRAM Speed	100/100MHz
CPU Core Voltage	1.616V
CPU Ratio	H/W Trap
CPU Frequency	100 MHz
DRAM Frequency	100 MHz
ESC : Quit ↑↓←→ : Select Item F1 : Help PU/PD/+/- : Modify F5 : Old Values (Shift)F2 : Color F6 : Load Optimal values F7 : Load Best performance values	

CPU Type/Core Voltage/Ratio/Frequency	These items show the type, core voltage, ratio and frequency of CPU installed in your system.
CPU/DRAM Speed/Frequency	These items decide CPU/DRAM speed/frequency installed in your system.

Mainboard User's Manual

Hardware Monitor Page

This page sets some of the parameters for the hardware monitoring function of this mainboard.

AMIBIOS SETUP – HARDWARE MONITOR		
(C) 2000 American Megatrends, Inc. All Rights Reserved		
*** System Hardware ***		
Vcore	1.632V	
Vcc 2.5V/Vcc3.3V	2.496V	
Vcc 3.3V	3.392V	
Vcc	4.972V	
+12V	11.968V	
SB3V	3.488V	
-12V	-11.721V	
SB5V	5.053V	
VBAT	3.488V	ESC : Quit ↑↓←→ : Select Item
SYSTEM Fan Speed	0 RPM	F1 : Help PU/PD/+/- : Modify
CPU Fan Speed	1350 RPM	F5 : Old Values (Shift)F2 : Color
Power Temperature	53°C/127°F	F6 : Load BIOS Defaults
SYSTEM Temperature	39°C/102°F	F7 : Load Setup Defaults
CPU Temperature	31°C/87°F	

CPU / System Temperature	These items display CPU and system temperature measurement.
FANs & Voltage Measurements	These items indicate cooling fan speeds in RPM and the various system voltage measurements.

3: BIOS Setup Utility

Change Password

If you highlight this item and press **Enter**, a dialog box appears which lets you enter a Supervisor password. You can enter no more than six letters or numbers. Press **Enter** after you have typed in the password. A second dialog box asks you to retype the password for confirmation. Press **Enter** after you have retyped it correctly. The password is then required to access the Setup Utility or for that and at start-up, depending on the setting of the Password Check item in Advanced Setup.

Change or Remove the Password

Highlight this item, press **Enter** and type in the current password. At the next dialog box, type in the new password, or just press **Enter** to disable password protection.

Exit

Highlight this item and press **Enter** to save the changes that you have made in the Setup Utility configuration and exit the program. When the Save and Exit dialog box appears, press **Y** to save and exit, or press **N** to exit without saving.

Mainboard User's Manual

Using the Mainboard Software

About the Software CD-ROM

The support software CD-ROM that is included in the mainboard package contains all the drivers and utility programs needed to properly run the bundled products. Below you can find a brief description of each software program, and the location for your mainboard version. More information on some programs is available in a README file, located in the same directory as the software.

Note: Never try to install software from a folder that is not specified for use with your mainboard.

Before installing any software, always inspect the folder for files named README.TXT, INSTALL.TXT, or something similar. These files may contain important information that is not included in this manual.

Utility Software Reference

All the utility software available on the CD-ROM is Windows compliant. It is provided only for the convenience of customers. The following software is furnished under license and may only be used or copied in accordance with the terms of the license.

Note: The software in these folders is subject to change at anytime without prior notice. Please refer to the support CD for available software.

Award Flash Memory Utility

This utility enables you to erase the system BIOS stored on a Flash Memory chip on the mainboard, and lets you copy an updated version of the BIOS to the chip. Proceed with caution when using this program. If you erase the current BIOS and fail to write a new BIOS, or write a new BIOS that is incorrect, your system will malfunction. Refer to Chapter 3, Using BIOS for more information.

PC-CILLIN

The PC-CILLIN software program provides anti-virus protection for your system. This program is available for Windows 2000/ME/98SE and Windows NT. Be sure to check the readme.txt and install the appropriate anti-virus software for your operating system.

We strongly recommend users to install this free anti-virus software to help protect your system against viruses.

Note: Update your virus software regularly to protect against new viruses.

MediaRing Talk – Telephony Software

To install the MediaRing Talk voice modem software for the built-in modem, run MRTALK-SETUP72.EXE from the following directory:

\UTILITY\MEDIARING TALK

4: Software & Applications

Super Voice – Fax/Modem Software

To install the Super Voice voice, fax, data communication application for use with the built-in fax/modem, run PICSHELL.EXE from the following directory:
\\UTILITY\\SUPER VOICE

CD Ghost

The CD Ghost software enables you to create a virtual cabinet of CD-ROM drives on your system to help you categorize and organize your CD collection. A user-friendly interface assists you in quickly creating images of both CDs and DVDs onto your system. To install the software, run SETUP.EXE from the following directory:
\\UTILITY\\CDGHOST\\ENG\\CDGHOST

Recovery Genius

The Recovery Genius software program is an innovative windows application system that protects your Hard Disk Drive from virus intrusion, accidental deletions, and system corruption. To install the Recovery Genius software program run SETUP.EXE from the following directory
\\UTILITY\\RECOVERY GENIUS\\ENG\\RECOVERYGENIUS

Language Genius

The Language Genius is a software-based product that helps you to learn new languages. To install the Language Genius software program run SETUP.EXE from the following directory
\\UTILITY\\LANGUAGE GENIUS\\ENG\\LANGUAGEGENIUS

Mainboard User's Manual

PageABC

The PageABC application software enables you to create your own home page. To install the PageABC, run SETUP.EXE from the following directory:

\UTILITY\PageABC

This concludes Chapter 4.