

MS-C78

Micro ATX Motherboard

User's Manual

Edition 1.3
2021/08/23

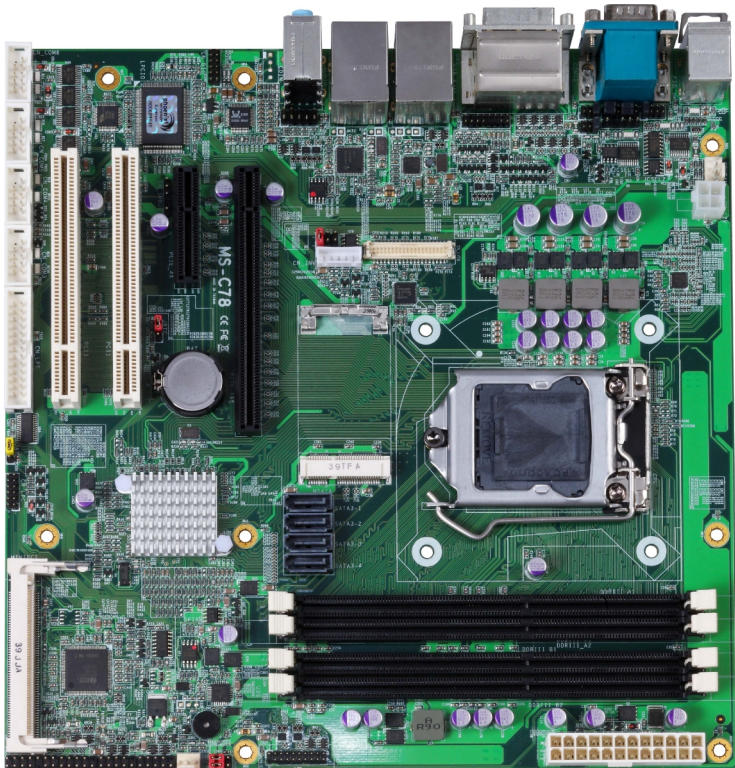

Copyright

Copyright 2021, all rights reserved. This document is copyrighted and all rights are reserved. The information in this document is subject to change without prior notice to make improvements to the products.

This document contains proprietary information and protected by copyright. No part of this document may be reproduced, copied, or translated in any form or any means without prior written permission of the manufacturer.

All trademarks and/or registered trademarks contains in this document are property of their respective owners.

Disclaimer

The company shall not be liable for any incidental or consequential damages resulting from the performance or use of this product.

The company does not issue a warranty of any kind, express or implied, including without limitation implied warranties of merchantability or fitness for a particular purpose.

The company has the right to revise the manual or include changes in the specifications of the product described within it at any time without notice and without obligation to notify any person of such revision or changes.

Trademark

All trademarks are the property of their respective holders.

Any questions please visit our website at <http://www.commell.com.tw>

Packing List:

Please check the package content before you starting using the board.

Hardware:

MS-C78 Micro ATX motherboard x 1

Cable Kit:



SATA Cable x 2
(OALSATA3-L)
(1040529)



DB25 & DB9 cable x 1
(OAL1S1P)
(1040041)

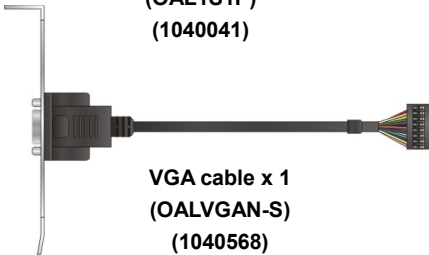
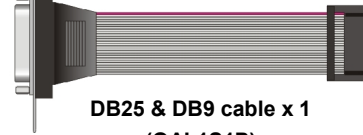

VGA cable x 1
(OALVGAN-S)
(1040568)

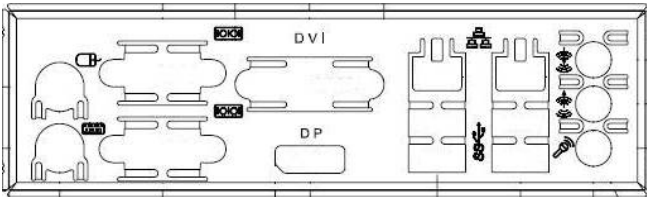

I/O Shield x 1
(OPLATE-MCDLA)
(1270055)

Printed Matters:

Driver CD (Including User's Manual) x 1

Index

Chapter 1 <Introduction>	5
1.1 <Product Overview>.....	5
1.2 <Product Specification>	6
1.3 <Mechanical Drawing>.....	7
1.4 <Block Diagram>.....	8
Chapter 2 <Hardware Setup>	9
2.1 <Connector Location>	9
2.2 <Jumper Location & Reference>.....	9
2.3 <Connector Reference>	11
2.3.1 <Internal Connectors>	11
2.3.2 <External Connectors>	11
2.4 <CPU and Memory Setup>	12
2.4.1 <CPU installation>	12
2.4.2 <Memory Setup>	13
2.5 <CMOS & ATX Setup>	14
2.6 <Serial ATA Interface>	15
2.7 <Ethernet Interface>	16
2.8 <Onboard Display Interface>	17
2.8.1 <Analog Display>	17
2.8.2 <Digital Display>.....	18
2.8.3 <VGA Interface>	22
2.9 <Integrated Audio Interface>	23
2.10 <USB Interface>.....	24
2.11 <Serial Port>	26
2.12 <mSATA Interface>	29
2.13 <GPIO and SMBus Interface>.....	30
2.14 <Power Supply and Fan Interface >.....	31
2.14.1 <Power Input>	31
2.14.2 <Fan connector>.....	32

2.15 <Switch and Indicator> 33

Chapter 3 <System Setup> 34

3.1 <Audio Configuration> 34

3.2 <Display Properties Setting> 35

3.3 <SATA configuration> 37

3.4 <SATA RAID Configuration> 38

Chapter 4 <BIOS Setup> 40

Appendix A <I/O Port Pin Assignment> 41

A.1 <Serial ATA Port> 41

A.2 <IrDA Port> 41

A.3 <LAN Port> 41

A.4 <Parallel Port> 42

Appendix B <Flash BIOS> 43

<Flash BIOS Procedure> 43

Appendix C <Programming GPIO's> 44

Appendix D <Programming Watchdog Timer > 44

Contact Information 46

Chapter 1 <Introduction>

1.1 <Product Overview>

MS-C78 the 4th Generation Intel of the Micro ATX motherboard, supports 4th Generation Intel® Core™ i7, Core™ i5, Core™ i3, Celeron, Pentium Desktop Processor and features Intel Q87 chipset, integrated HD Graphics, DDR3 memory, REALTEK High Definition Audio, Serial ATAIII with RAID function for a system and Intel Gigabit LAN.

Intel Haswell Processor

The 4th Generation Intel® Core™ processor family desktop is the next generation of 64-bit, the processors are based on Intel® microarchitecture formerly known as Haswell, manufactured on 22nm process technology with 3-D tri-gate transistors.

Features for Intel Q87 chipset

The board integrates Intel Q87 chipset, supports integrated HD Graphics, built-in high speed mass storage interface of Serial ATAIII interface with RAID function, High Definition Audio with 2 channels surrounding sound.

Flexible Extension Interface

The board provides, mSATA socket, Mini-PCI socket, one PCIEx16 slot and one PCIEx4 slot, and two PCI slot.

1.2 <Product Specification>

General Specification

Form Factor	Micro ATX motherboard
CPU	Supports 4th Generation Intel® Core™ i7/ i5/ i3/ Celeron/ Pentium Desktop Processor. Package type: FCLGA1150
Memory	Four DDR3/DDR3L (support 1.5V) 1333/1600 DIMM up to 32GB Support Non-ECC, unbuffered memory only
Chipset	Intel Q87 Express chipset
Real Time Clock	Chipset integrated RTC with onboard lithium battery
Watchdog Timer	Generates a system reset with internal timer for 1min/s ~255min/s
Power Management	Supports ACPI 4.0 compliant
Serial ATA Interface	Intel® Q87 PCH built-in 4 x Serial ATAIII interface up to 600MB/s Support RAID 0, 1, 5, 10 and Intel Rapid Storage Technology. (not support SATA II device)
VGA Interface	Intel® Clear Video integrated HD Graphics Technology
DVI Interface	Onboard DVI connector
LVDS Interface	Onboard 24-bit dual channel LVDS connector with +3.3V/+5V/+12V supply
Display port Interface	Onboard DisplayPort connector
Audio Interface	Intel® integrated Q87 with Realtek ALC888 HD Audio.
LAN Interface	1 x Intel® I210 Gigabit LAN 1 x Intel® I217-LM Gigabit LAN
GPIO interface	Onboard programmable 8-bit Digital I/O interface
Extended Interface	One PCIE X 16 slot & one PCIE X 4 slot, One mSATA, One Mini PCI, Two PCI slot. (mSATA only Support SATAIII)
Internal I/O Port	4 x RS232, 1 x GPIO, 1 x Audio, 1 x IrDA, 1 x SMBUS, 1 x CRT, 1 x LVDS, 1 x LCD inverter, 1 x LPC, 1 x LPT, 6 x USB2.0, 2 x USB3.0, 4 x SATAIII
External I/O Port	1 x PS/2 Keyboard/Mouse Port, 1 x RS232, 1 x RS232/422/485, 1 x DVI port, 1 x DisplayPort, 2 x RJ45 LAN ports, 4 x USB3.0 ports and 1 x 2 Channel Audio.
Power Requirement	Standard ATX 24-pin (20-pin is compatible) power supply and P4 4-pin 12V
Dimension	244mm x 244mm
Temperature	Operating within 0~60 centigrade Storage within -20~85 centigrade

Ordering Code

MS-C78	Onboard DVI, DisplayPort, CRT, LVDS, 2 x Gigabit LAN, USB3.0 & 2.0, Serial Port, SATAIII, IrDA, Realtek HD Audio, Mini PCI, PCIE x16 & x4, PCI, SMBus, GPIO, LPC, LPT, mSATA.
---------------	---

The specifications may be different as the actual production.

For further product information please visit the website at <http://www.comnell.com.tw>

1.3 <Mechanical Drawing>

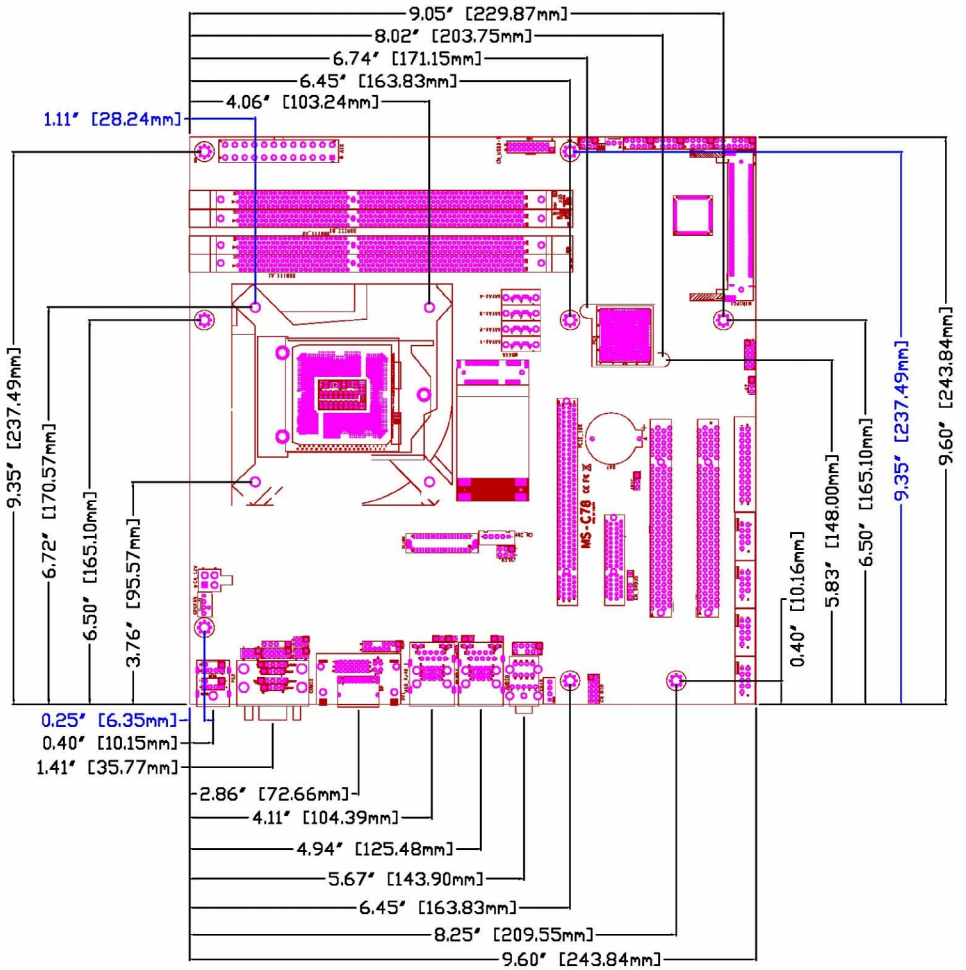

1.4 <Block Diagram>

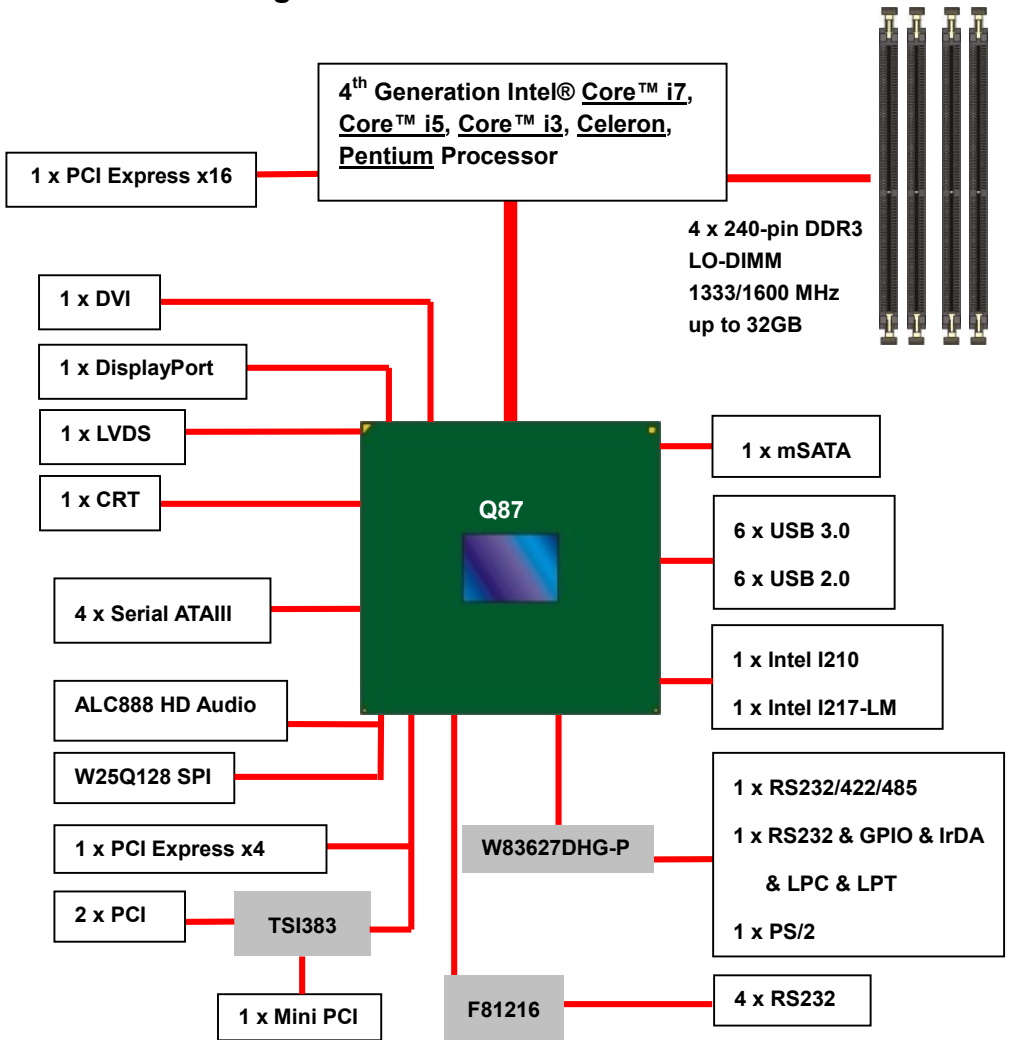

Chapter 2 <Hardware Setup>

2.1 <Connector Location>

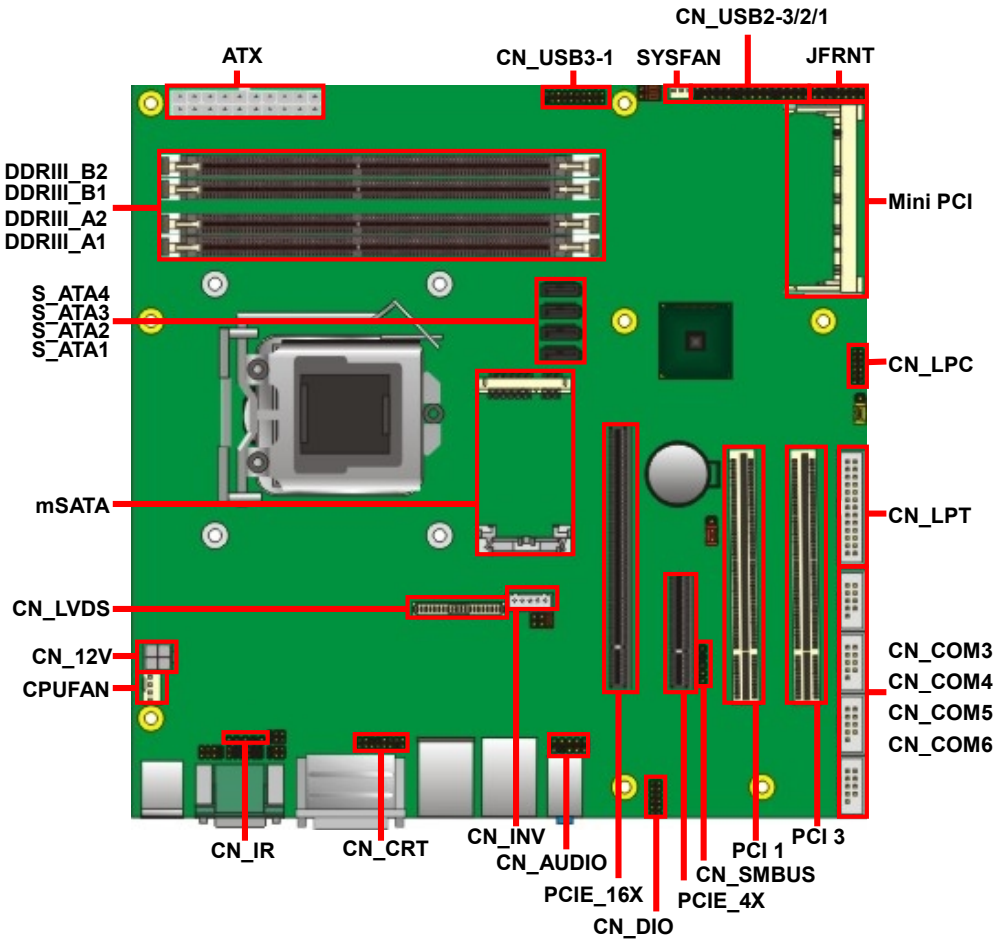

PS2

COM1+COM2

DVI

USB_RJ45_1/2

Audio

DisplayPort

2.2 <Jumper Location & Reference>

Jumper	Function
JRTC	CMOS Operating/Clear Setting
JVLCD	Panel Voltage Setting
JAT	Power mode select
JP1	Com1 Voltage Setting (For Pin 9)
JP2	Com2 Voltage Setting (For Pin 9)
JCSEL1	COM2 RS-232 RS422 RS485 Setting
JCSEL2	CN_IR IrDA Setting
JVUSB	USB Voltage Setting

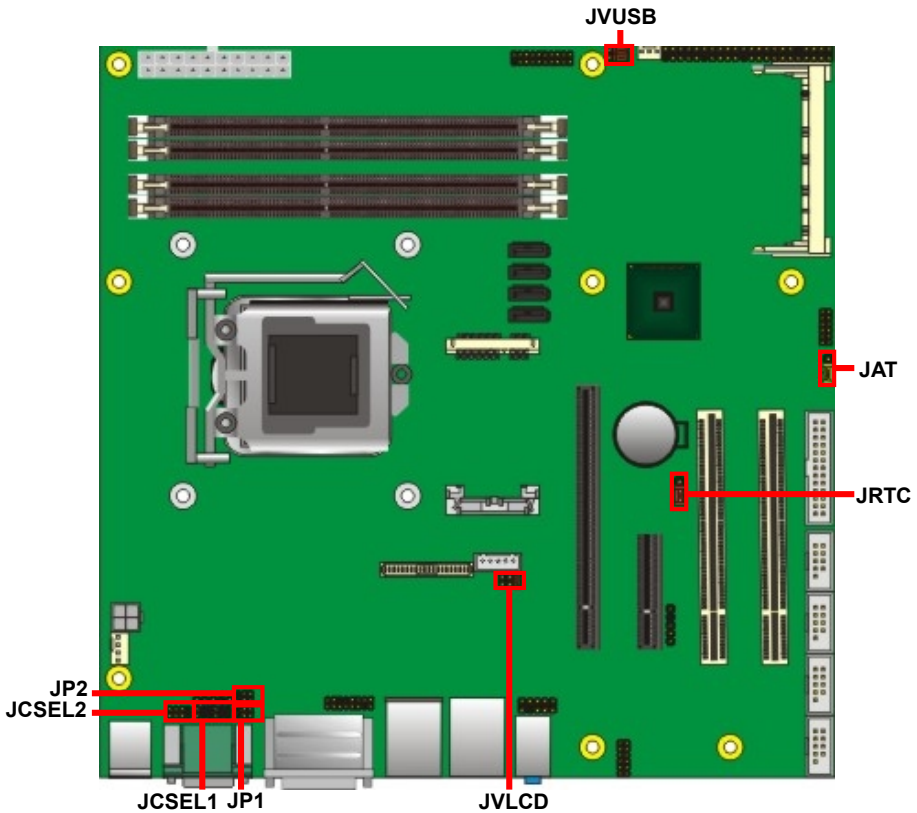

2.3 <Connector Reference>

2.3.1 <Internal Connectors>

Connector	Function	Remark
CPU	LGA1150 CPU Socket	
DDRIII A-1/2 & B-1/2	240 -pin DDR3 LO-DIMM socket	
SATAIII 1/2/3/4	7-pin Serial ATAIII connector	
DC_12V	4-pin +12V additional power supply connector	
ATX	24-pin power supply connector	
CN_AUDIO	5 x 2-pin audio connector	
CN_DIO	6 x 2-pin digital I/O connector	
CN_USB2-1/2/3	10-pin USB connector	
CN_USB3	20-pin USB3.0 connector	
CPUFAN	4-pin CPU cooler fan connector	
SYSFAN	3-pin system cooler fan connector	
CN_CRT	16-pin VGA connector	
CN_LVDS	20 x 2-pin LVDS connector	
CN_INV	5-pin LCD inverter connector	
CN_IR	5-pin IrDA connector	
CN_COM 3/4/5/6	9-pin RS232	
CN_LPC	5 x 2-pin LPC connector	
CN_LPT	13 x 2-pin printer connector	
JFRNT	14-pin front panel switch/indicator connector	
PCIE_16X	164-pin x16 PCIE slot	
PCIE_4X	64-pin x4 PCIE slot	
PCI	120-pin PCI slot	
mSATA	2 x 52-pin Mini-PCle socket	
Mini PCI	124-pin Mini PCI slot	
JAT	Power mode select	

2.3.2 <External Connectors>

Connector	Function	Remark
USB_RJ45 1/2	2 x USB3.0 and 1 x RJ45 LAN connector	
DVI + DisplayPort	DVI connect and DisplayPort connector	
COM 1/2	Serial port connector	
PS/2	PS/2 keyboard and mouse connector	
AUDIO	Audio connector	

2.4 <CPU and Memory Setup>

2.4.1 <CPU installation>

MS-C78 has a LGA1150 CPU socket onboard; please check following steps to install the processor properly.

Attention If MS-C78 needs RMA please Keep CPU socket cover on the CPU Socket.

Warning If CPU Socket internal Pin damage We could not provide warranty.



Intel® I3/I5/I7/Celeron/Pentium processor Package
type: 1150 pin FCLGA
FSB:1333/1600MHz

1. Lift this bar

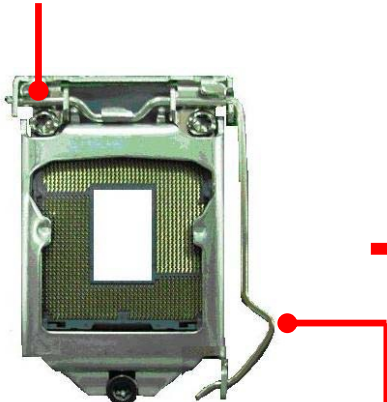

2. Uncover this plate



Checked point

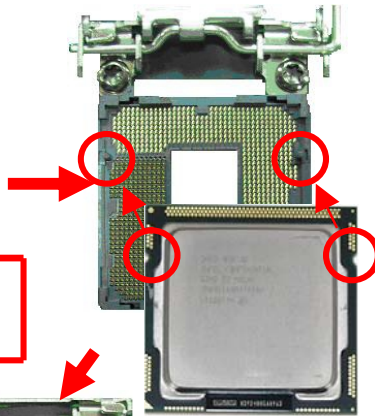

3. Place the CPU on the top of the pins

4. Lock this bar



5. Cover this plate

Notice: Please place the CPU on the pins tenderly to avoid bending the pins

2.4.2 <Memory Setup>

MS-C78 has four 240-pin DDR3/DDR3L DIMM support up to 32GB of memory capacity and 1.5 Voltage. The memory frequency supports 1333/1600 MHz. Only Non-ECC memory is supported.

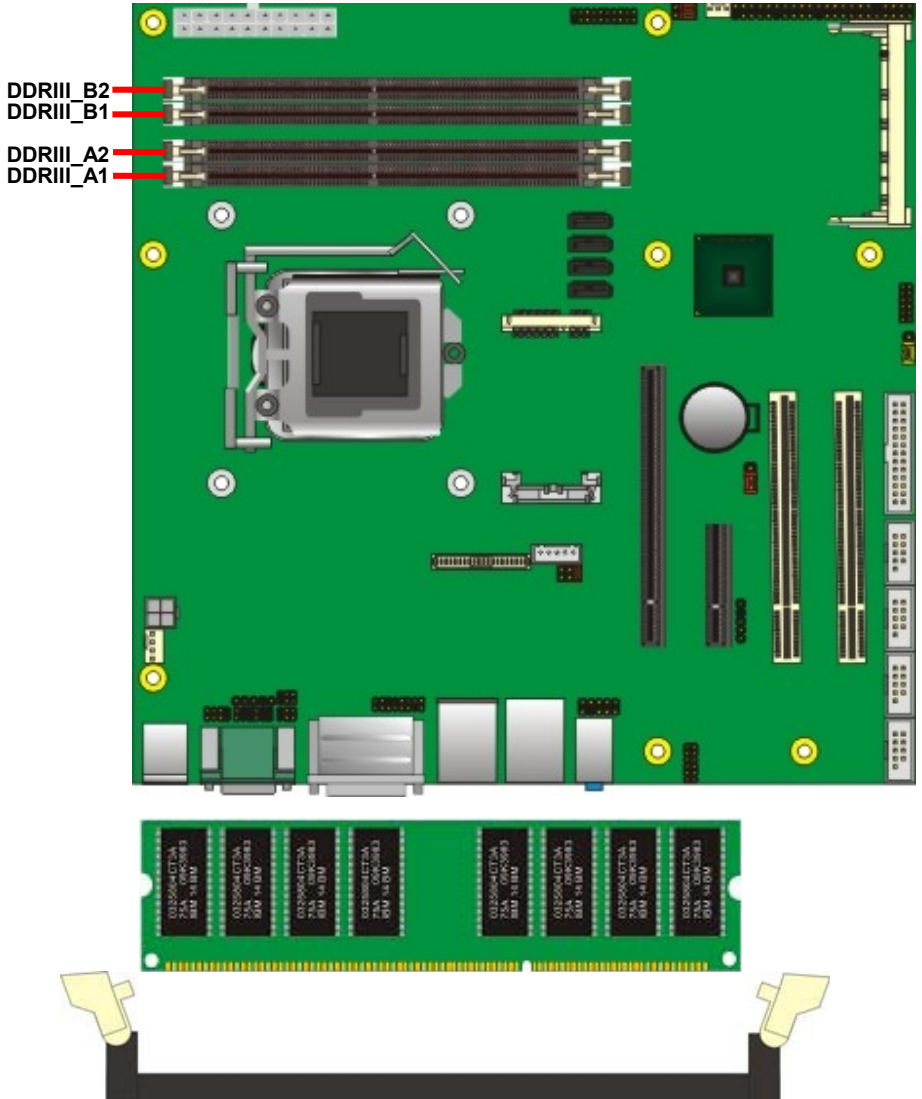

Please check the pin number to match the socket side well before installing memory module.

2.5 <CMOS & ATX Setup>

The board's data of CMOS can be setting in BIOS. If the board refuses to boot due to inappropriate CMOS settings, here is how to proceed to clear (reset) the CMOS to its default values.

Jumper: JRTC

Type: Onboard 3-pin jumper

JRTC	Mode
1-2	Clear CMOS
2-3	Normal Operation

Default setting: 2-3

Jumper: JAT

Type: onboard 3-pin jumper

JAT	Mode
1-2	AT Mode
2-3	ATX Mode

Default setting:2-3

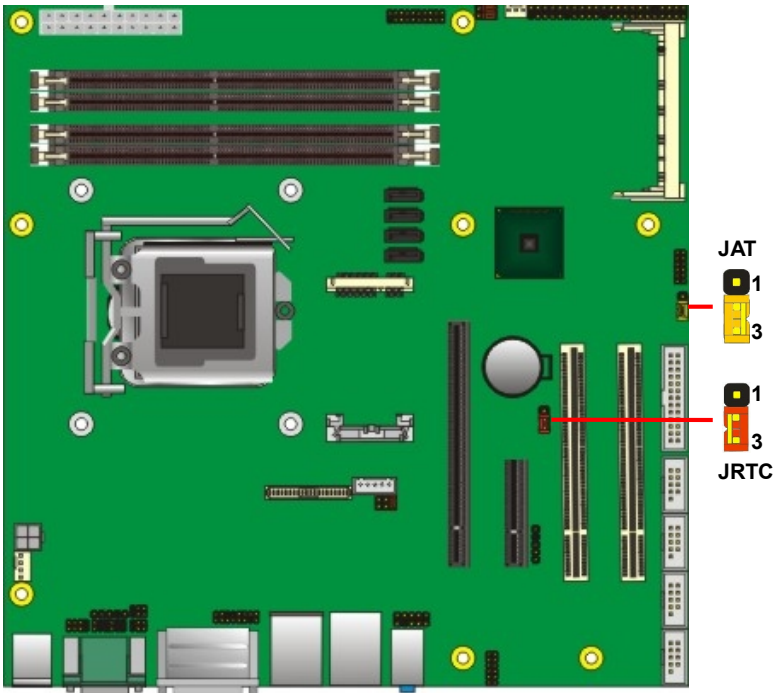

2.6 <Serial ATA Interface>

MS-C78 has Four Serial ATA III interfaces with RAID function, the transfer rate of the Serial ATA III can be up to 600MB/s, but **not supports SATAII device**. Based on Intel® PCH, it supports **Intel® Rapid Storage Technology** with combination of RAID 0,1,5 and 10. The main features of RAID on Intel® Q87 PCH are listed below:

1. Supports for up to RAID volumes on a single, two-hard drive RAID array.
2. Supports for two, two-hard drive RAID arrays on any of six Serial ATA ports.
3. Supports for Serial ATA ATAPI devices.
4. Supports for RAID spares and automatic rebuild.
5. Supports on RAID arrays, including NCQ and native hot plug.

For more information please visit Intel's official website.

For more about the system setup for Serial ATA, please check the chapter of SATA configuration.

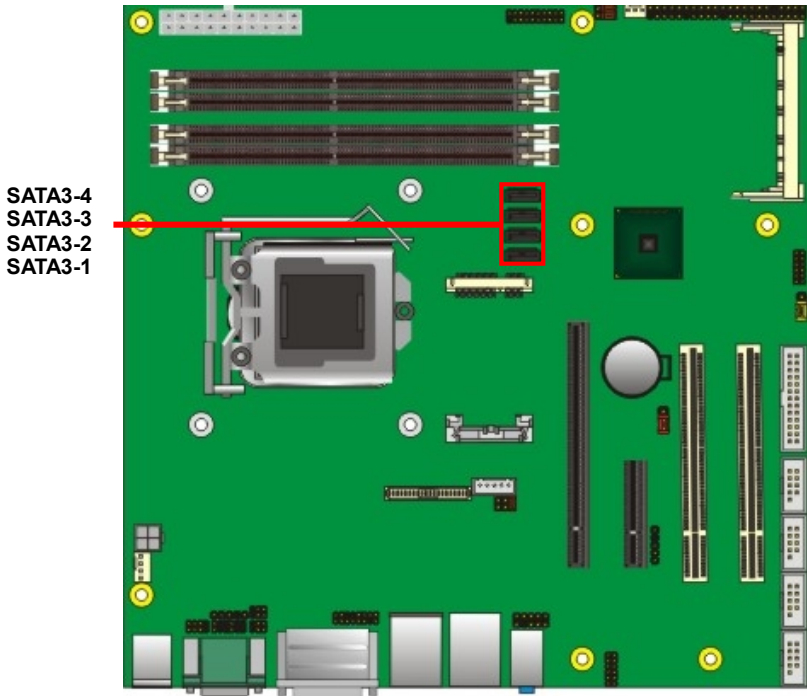

2.7 <Ethernet Interface>

The board integrates with one Intel I210 Gigabit Ethernet & one Intel I217-LM controllers, as the PCI Express bus. The Intel I210 & I217-LM supports triple speed of 10/100/1000Base-T, with IEEE802.3 compliance and Wake-On-LAN supported.

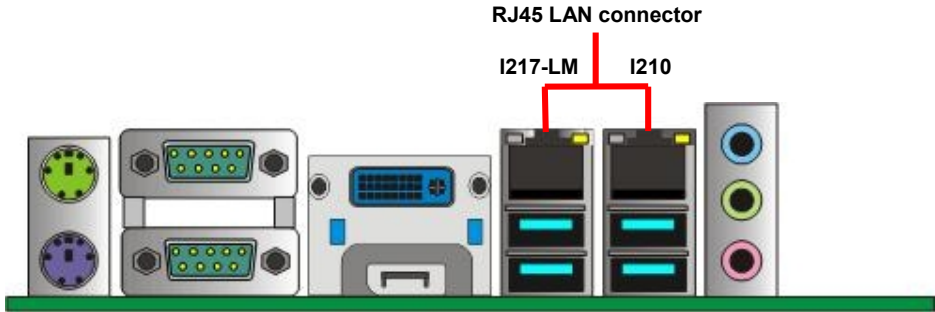

Onboard Intel® I217-LM GbE controller support Intel® AMT 9.0 feature on primary LAN port. The BIOS is ready to support Intel® AMT 9.0 feature. The necessary prerequisite is your CPU must support Intel® vPro technology, ex : Intel® Core™ i7

For further instruction about the Intel® AMT features and set up, please refer to the [iAMT Setting.pdf](#).

2.8 <Onboard Display Interface>

Based on Intel Q87 chipset with built-in HD Graphic, the board provides one DVI connector & one DisplayPort on rear external I/O port, one 40-pin LVDS interface with 5-pin LCD backlight inverter connector and provides 16-pin VGA interface.

The board provides dual display function with clone mode and extended desktop mode for DVI, DisplayPort, VGA and LVDS.

2.8.1 <Analog Display>

Please connect your DVI & DisplayPort or LCD monitor with male connector to the onboard female connector on rear I/O port .

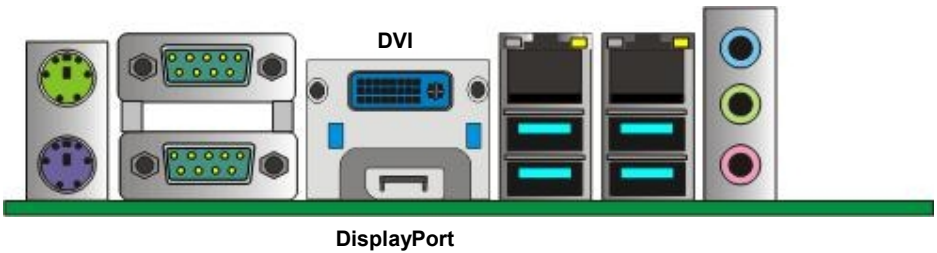

2.8.2 <Digital Display>

The board provides one 40-pin LVDS connector for 24-bit single/dual channel panels, supports up to 1920 x 1200 (UXGA) resolution, with one LCD backlight inverter connector and one jumper for panel voltage setting.

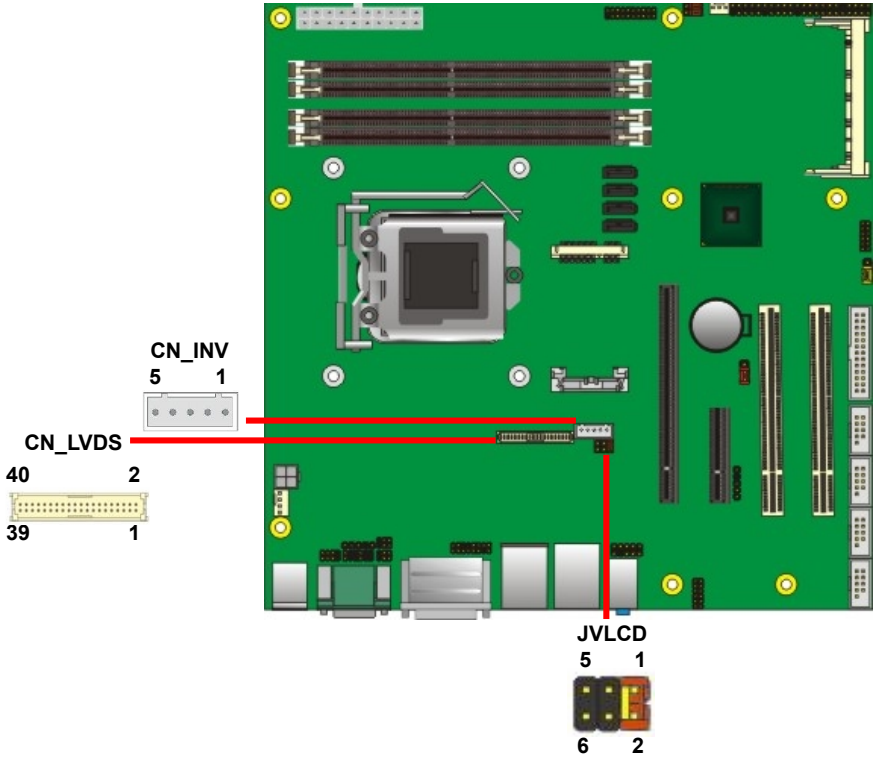

Effective patterns of connection: 1-2 / 3-4 / 5-6



Warning: others cause damages

Connector: **CN_INV**

Type: 5-pin LVDS Power Header

Pin	Description
1	+12V
2	Reserved (Note)
3	GND
4	GND
5	ENABKL

Note: Reserved for MB internal test
Please treat it as NC.

Connector: **JVLCD**

Type: 6-pin Power select Header

Pin	Description
1-2	LCDVCC (3.3V)
3-4	LCDVCC (5V)
5-6	LCDVCC (12V)

Default: 1-2

Connector: **CN_LVDS**

Type: onboard 40-pin connector for LVDS connector

Connector model: **HIROSE DF13-40DP-1.25V**

Pin	Signal	Pin	Signal
2	LCDVCC	1	LCDVCC
4	GND	3	GND
6	ATX0-	5	BTX0-
8	ATX0+	7	BTX0+
10	GND	9	GND
12	ATX1-	11	BTX1-
14	ATX1+	13	BTX1+
16	GND	15	GND
18	ATX2-	17	BTX2-
20	ATX2+	19	BTX2+
22	GND	21	GND
24	ACLK-	23	BTX3-
26	ACLK+	25	BTX3+
28	GND	27	GND
30	ATX3-	29	BCLK-
32	ATX3+	31	BCLK+
34	GND	33	GND
36	LVDS_SCL	35	N/C
38	LVDS_DAT	37	N/C
40	N/C	39	N/C

MS-C78 User's Manual

To setup the LCD, you need the component below:

1. A panel with LVDS interfaces.
2. An inverter for panel's backlight power.
3. A LCD cable and an inverter cable.

For the cables, please follow the pin assignment of the connector to make a cable, because every panel has its own pin assignment, so we do not provide a standard cable; please find a local cable manufacture to make cables.

LCD Installation Guide:

1. Preparing the **MS-C78**, **LCD panel** and the **backlight inverter**.

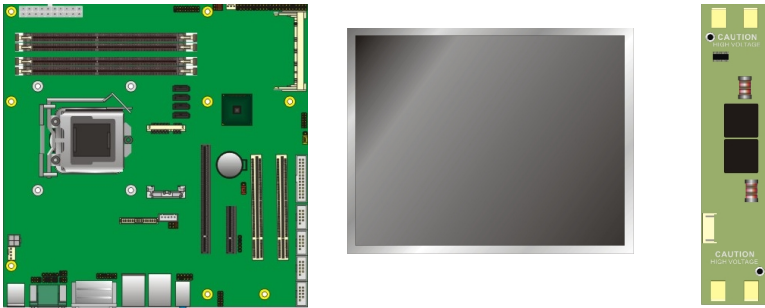

2. Please check the datasheet of the panel to see the voltage of the panel, and set the jumper **JVLC**D to +12V or +5V or +3.3V.
3. You would need a LVDS type cable.

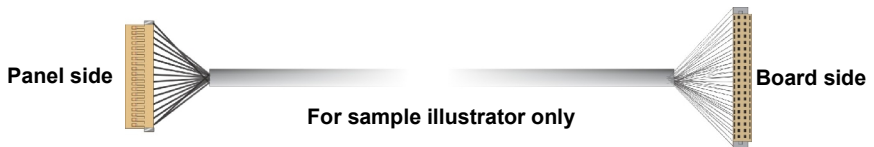

4. To connect all of the devices well.

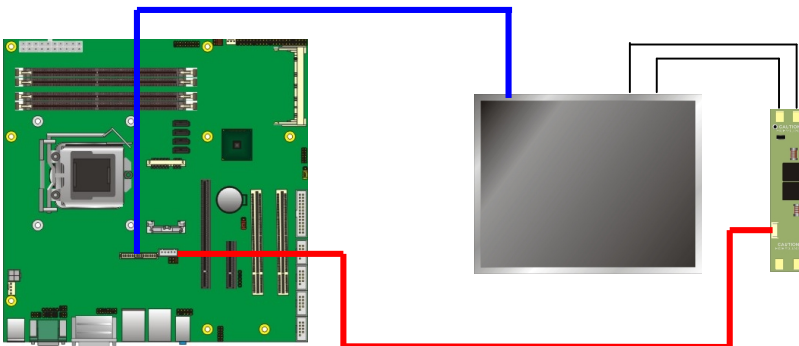

MS-C78 User's Manual

After setup the devices well, you need to select the LCD panel type in the BIOS.

The panel type mapping is list below:

BIOS panel type selection form (BIOS Version:1.0)			
Single / Dual channel		Single / Dual channel	
NO.	Output format	NO.	Output format
1	640 x 480	9	1680 x 1050
2	800 x 600	10	1920 x 1200
3	1024 x 768	11	1440 x 900
4	1280 x 1024	12	1600 x 900
5	1400 x 1050 Reduced Blanking	13	1024 x 768
6	1400 x 1050 non-Reduced Blanking	14	1280 x 800
7	1600 x 1200	15	1920 x 1080
8	1366 x 768		

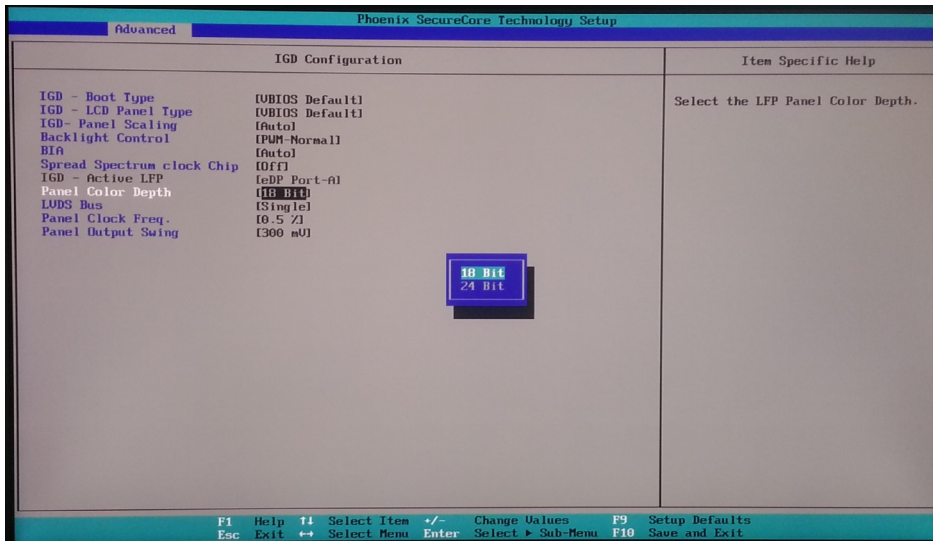

2.8.3 <VGA Interface>

Connector: **CN_CRT**

Type: onboard 16-pin connector for CN_VGA connector

Pin	Signal	Pin	Signal
1	BR	2	BG
3	BB	4	NC
5	-CRTATCH	6	VGAGND
7	VGAGND	8	VGAGND
9	NC	10	-CRTATCH
11	NC	12	5VCDA
13	5HSYNC	14	5VSYNC
15	5VCLK	16	NC

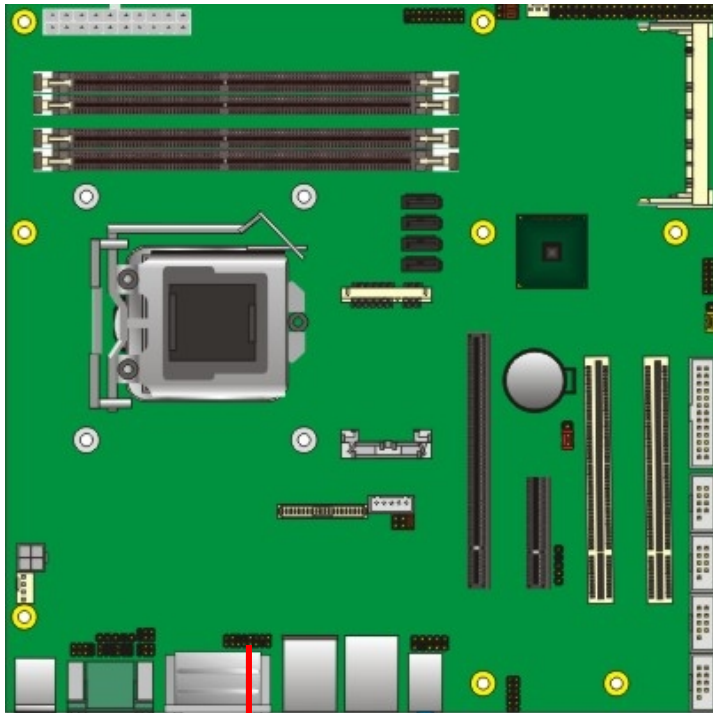

CN_CRT



2.9 <Integrated Audio Interface>

The board integrates onboard audio interface with REALTEK ALC888 code, with Intel next generation of audio standard as High Definition Audio, it offers more vivid sound and other advantages than former HD audio compliance.

The main specifications of ALC888 are:

- **High-performance DACs with 100dB S/N ratio**
- **2 DAC channels support 16/20/24-bit PCM format for 2 audio solution**
- **Compatible with HD**
- **Meets Microsoft WHQL/WLP 2.0 audio requirements**

The board provides 2 channels audio phone jacks on rear I/O port, Line-in/MIC-in ports for front I/O panel through optional cable.

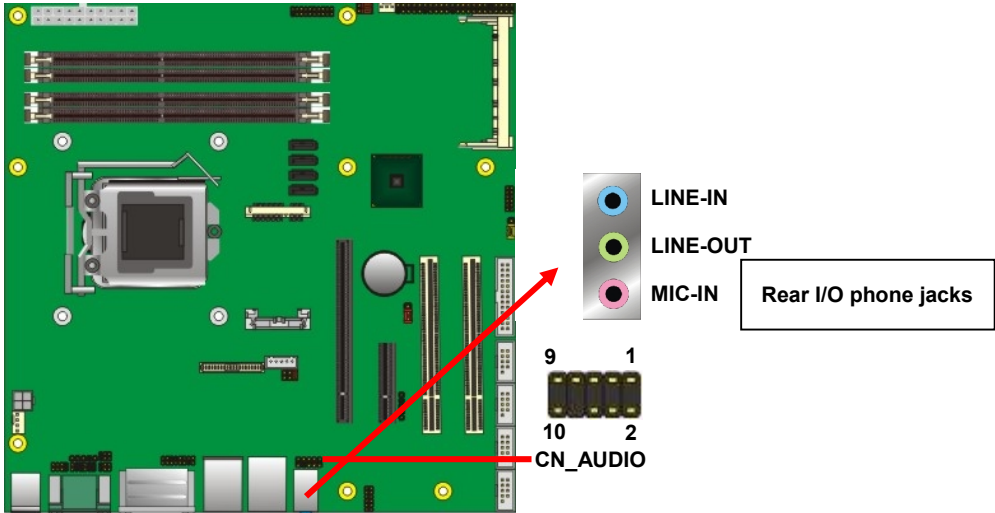

Connector: CN_AUDIO
Type: 10-pin (2 x 5) header

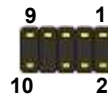

Pin	Description	Pin	Description
1	MIC_L	2	Ground
3	MIC_R	4	ACZ_DET
5	Speaker_R	6	MIC Detect
7	SENSE	8	N/C
9	Speaker_L	10	Speaker Detect

2.10 <USB Interface>

MS-C78 integrates six USB3.0 ports and four USB2.0 ports.

The specifications of USB3.0 are listed below:

Interface	USB3.0
Controller	Intel® Q87
Transfer Rate	Up to 5Gb/s
Voltage	5V_SB/5V



USB1/2/3/4

Type: USB3.0

The specifications of USB2.0 are list:

Interface	USB2.0
Controller	Intel® Q87
Transfer Rate	Up to 480Mb/s
Voltage	5V

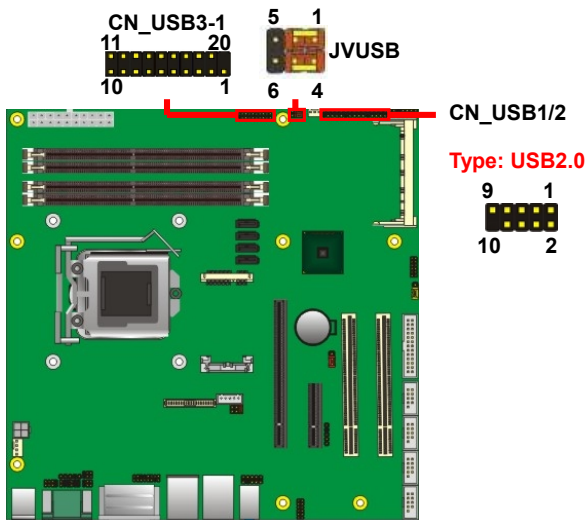

Connector: **CN_USB3-1**

Type: 20-pin (2 x 10) header

Pin	Description	Pin	Description
1	VCC (5V_SB/ 5V)	20	NC
2	USB3.0_RX0-	19	VCC (5V_SB/ 5V)
3	USB3.0_RX0+	18	USB3.0_RX1-
4	Ground	17	USB3.0_RX1+
5	USB3.0_TX0-	16	Ground
6	USB3.0_TX0+	15	USB3.0_TX1-
7	Ground	14	USB3.0_TX1+
8	Data0-	13	Ground
9	Data0+	12	Data1-
10	NC	11	Data1+

Connector: **CN_USB2-1/2/3**

Type: 10-pin (2 x 5) header

Pin	Description	Pin	Description
1	VCC	2	VCC
3	Data0-	4	Data1-
5	Data0+	6	Data1+
7	Ground	8	Ground
9	Ground	10	N/C

Connector: **JVUSB**

Type: 6-pin Power select jumper

Pin	Description
1-3 & 2-4	5V_SB
3-5 & 4-6	5V

Default: 1-3 & 2-4

***Only Support USB3.0 (USB1/2 & CN_USB3-1)**

Effective patterns of connection: 1-3 & 2-4 or 3-5 & 4-6



Warning: others cause damages

2.11 <Serial Port>

The board supports Three RS232 serial port and one jumper selectable RS232/422/485 serial ports. The jumper JCSEL1 & JCSEL2 can let you configure the communicating modes for COM2.



Connector: **COM1/3/4/5/6**

Type: 9-pin D-sub male connector on bracket for COM1

Pin	Description	Pin	Description
1	DCD	2	RXD
3	TXD	4	DTR
5	GND	6	DSR
7	RTS	8	CTS
9	RI	10	N/C

Connector: **COM2**

Type: 9-pin D-sub male connector on bracket for COM2

Pin	Description	Pin	Description
1	DCD/422TX-/485-	2	RXD/422TX+/485+
3	TXD/422RX+	4	DTR/422RX-
5	GND	6	DSR
7	RTS	8	CTS
9	RI	10	N/C

Setting RS-232 & RS-422 & RS-485 for COM2

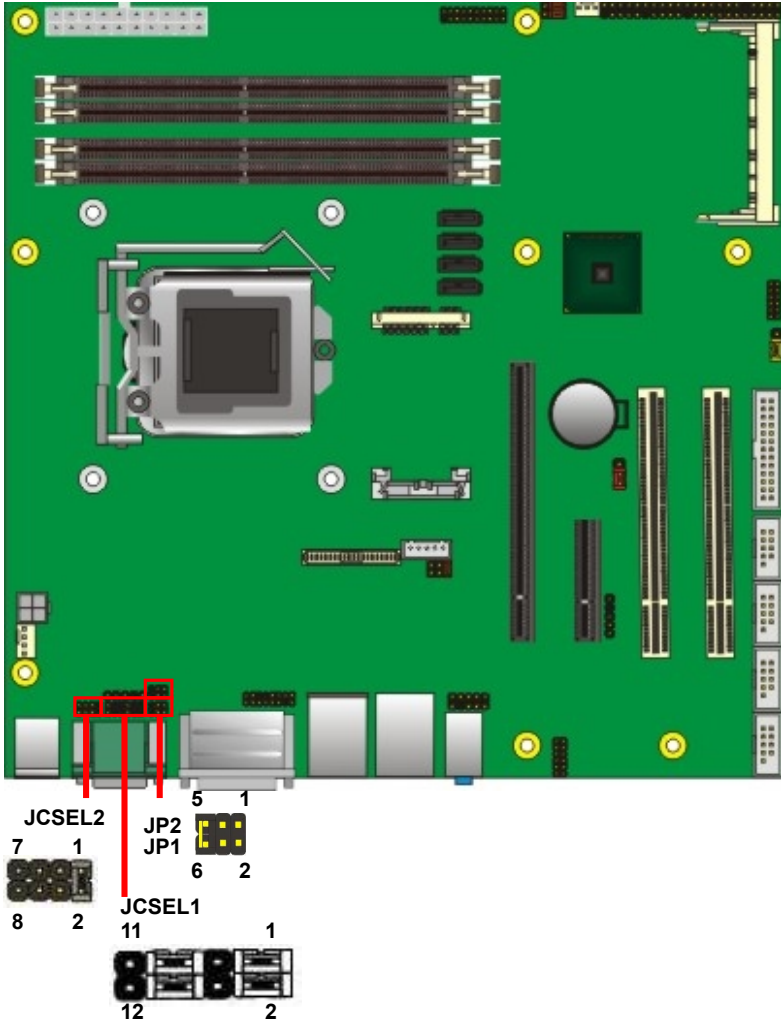

Function	JCSEL2	JCSEL1
IrDA		
RS-422		
RS-485		
RS-232		

Default setting:

JCSEL1: (1-3, 2-4, 7-9, 8-10) JCSEL2: (1-2)

Jumper: **JP1/JP2 (COM1/2)**

Type: onboard 6-pin header

Power Mode	JP1/2
Pin 9 with 5V Power	1-2
Pin 9 with 12V Power	3-4
Standard COM port	5-6
	Default setting

2.12 <mSATA Interface>

The board provides mSATA sockets.

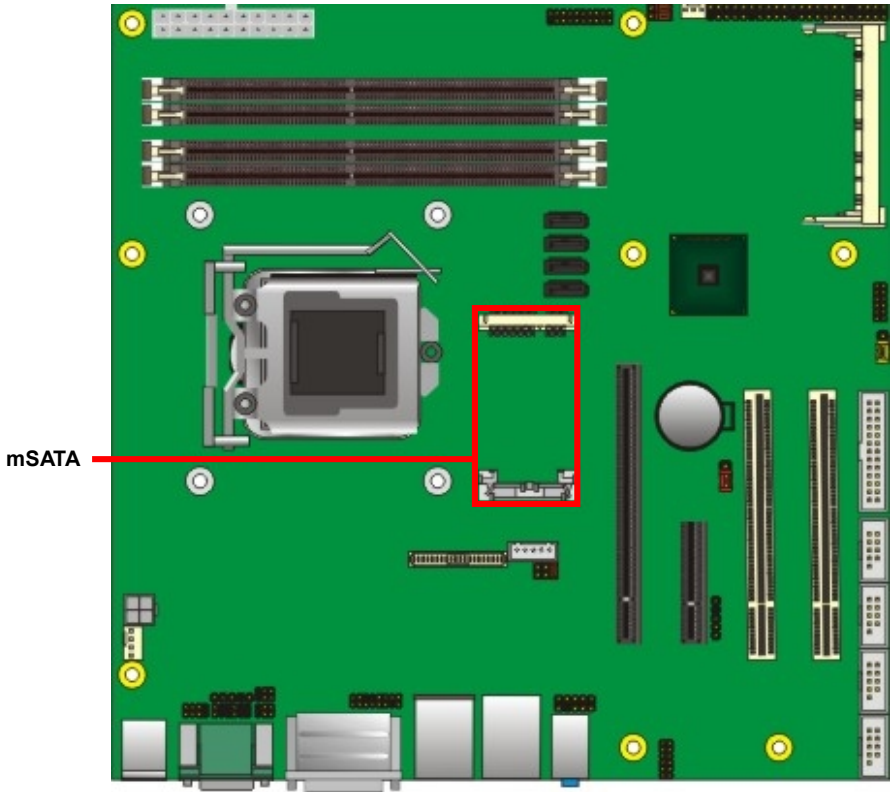

2.13 <GPIO and SMBus Interface>

The board provides a programmable 8-bit digital I/O interface; you can use this general purpose I/O port for system control like POS or KIOSK, and a SMBus (System Management Bus) interface.

Connector: **CN_DIO**

Type: 12-pin (6 x 2) header (pitch = 2.0mm)

Pin	Description	Pin	Description
1	Ground	2	Ground
3	GP10	4	GP14
5	GP11	6	GP15
7	GP12	8	GP16
9	GP13	10	GP17
11	5V	12	12V

Connector: **CN_SMBUS**

Type: 5-pin header for SMBus Ports

Pin	Description
1	VCC
2	N/C
3	SMBDATA
4	SMBCLK
5	Ground

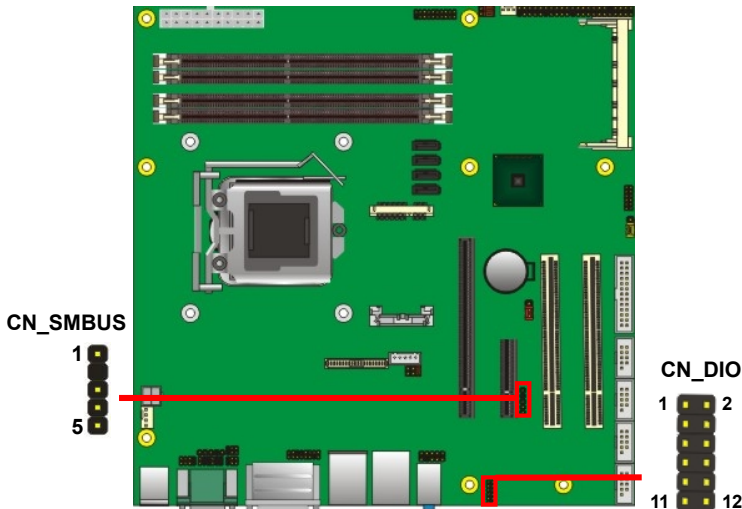

2.14 <Power Supply and Fan Interface >

2.14.1 <Power Input>

The **MS-C78** provides a standard ATX power supply with **24-pin** ATX connector and additional 12V connector, and the board provides one **4-pin** fan connectors supporting smart fan for CPU cooler and one 3-pin cooler fan connectors for system and Northbridge chip. The 4-pin CN_12V additional power connector is necessary for CPU powering; please connect this well before you finishing the system setup.

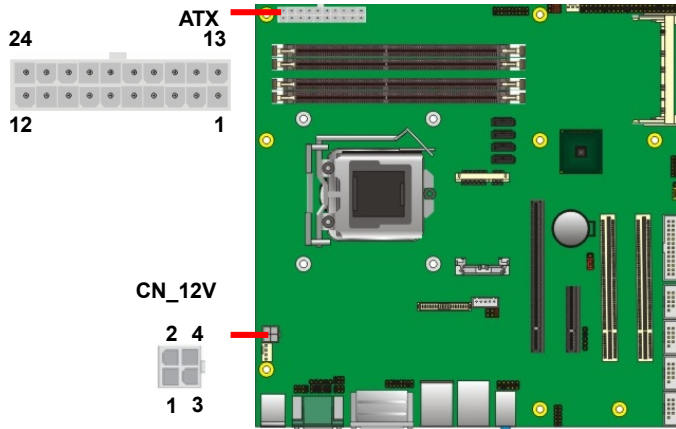

Connector: **CN_12V**

Type: 4-pin standard Pentium 4 additional +12V power connector

Pin	Description	Pin	Description
1	Ground	2	Ground
3	+12V	4	+12V

Connector: **ATX**

Type: 24-pin ATX power connector

PIN assignment			
1	3.3V	13	3.3V
2	3.3V	14	-12V
3	GND	15	GND
4	5V	16	-PSON
5	GND	17	GND
6	5V	18	GND
7	GND	19	GND
8	PW_OK	20	N/C
9	5V_SB	21	5V
10	12V	22	5V
11	12V	23	5V
12	3.3V	24	GND

2.14.2 <Fan connector>

The board provides one **4-pin** fan connectors supporting smart fan for CPU cooler and one **3-pin** cooler fan connectors for system.

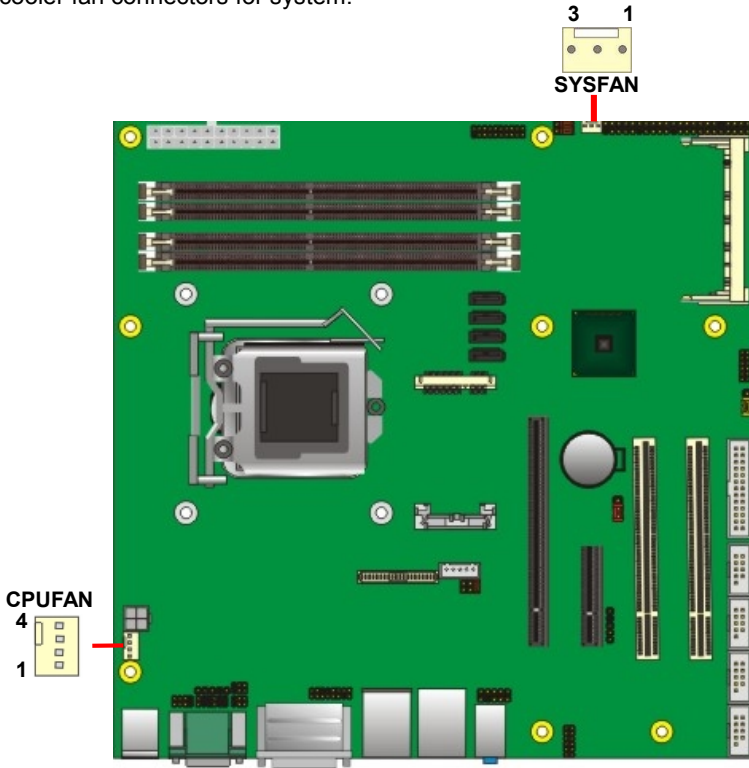

Connector: **CPUFAN**

Type: 4-pin fan wafer connector

Pin	Description	Pin	Description
1	Ground	2	+12V
3	Fan Speed Detection	4	Fan Control

Connector: **SYSFAN**

Type: 3-pin fan wafer connector

Pin	Description	Pin	Description	Pin	Description
1	Ground	2	+12V	3	Sense

2.15 <Switch and Indicator>

The **JFRNT** provides front control panel of the board, such as power button, reset and beeper, etc. Please check well before you connecting the cables on the chassis.

Connector: **JFRNT**

Type: onboard 14-pin (2 x 7) 2.54-pitch header

Function	Signal	PIN		Signal	Function
IDE LED	HDLED+	1	2	PWRLED+	Power LED
	HDLED-	3	4	N/C	
Reset	Reset+	5	6	PWRLED-	Speaker
	Reset-	7	8	SPK+	
N/C		9	10	N/C	
Power Button	PWRBT+	11	12	N/C	
	PWRBT-	13	14	SPK-	

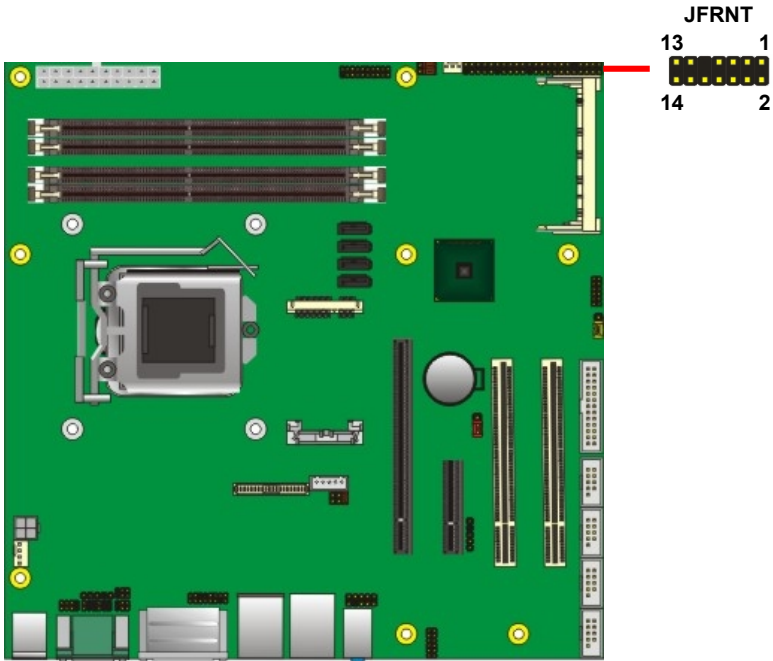

Chapter 3 <System Setup>

3.1 <Audio Configuration>

The board integrates Intel® Q87 with REALTEK® ALC888 code. It can support 2-channel sound under system configuration. Please follow the steps below to setup your sound system.

1. Install REALTEK HD Audio driver.
2. Lunch the control panel and Sound Effect Manager.

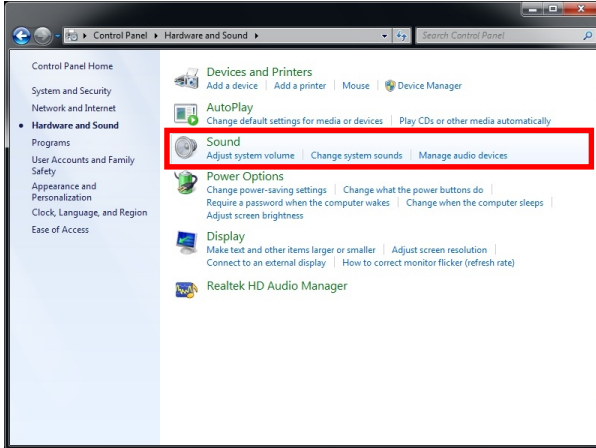

3. Select Speaker Configuration

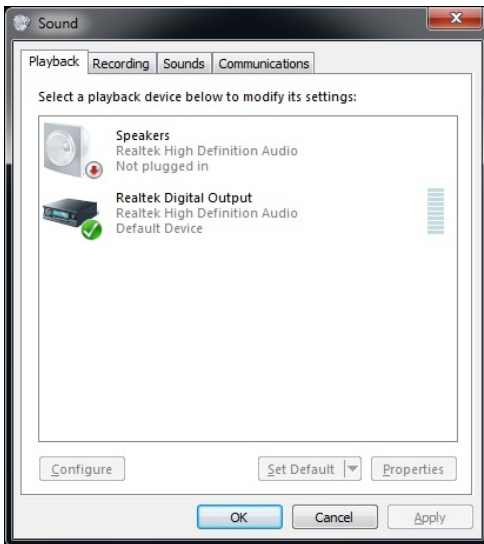

3.2 <Display Properties Setting>

Based on Intel Q87 with HD Graphic, the board supports two DACs for display device as different resolution and color bit.

Please install the Intel Graphic Driver before you starting setup display devices.

1. Click right button on the desktop to lunch **Screen resolution > Advanced settings**

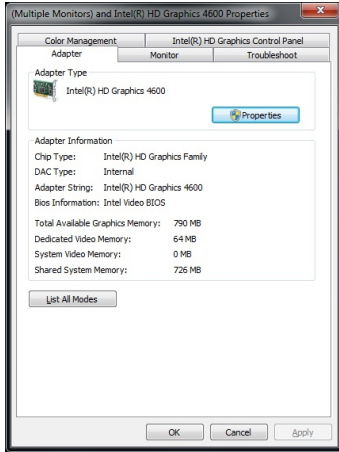

2. Click **Graphics Properties...** button for more specificity setup.

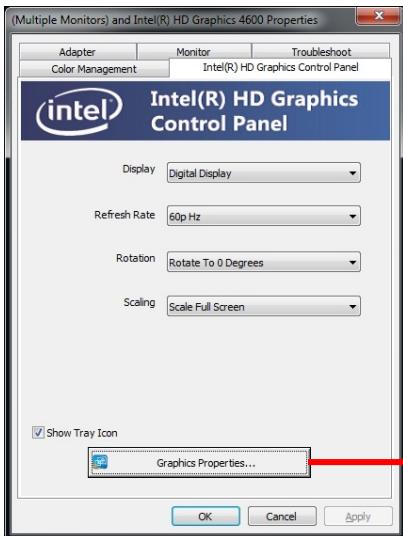

Click Graphics Properties... for advanced setup

3. This setup options can let you define each device settings.

Click [Display Settings](#) to setup the CRT monitor for Resolution and Refresh Rate

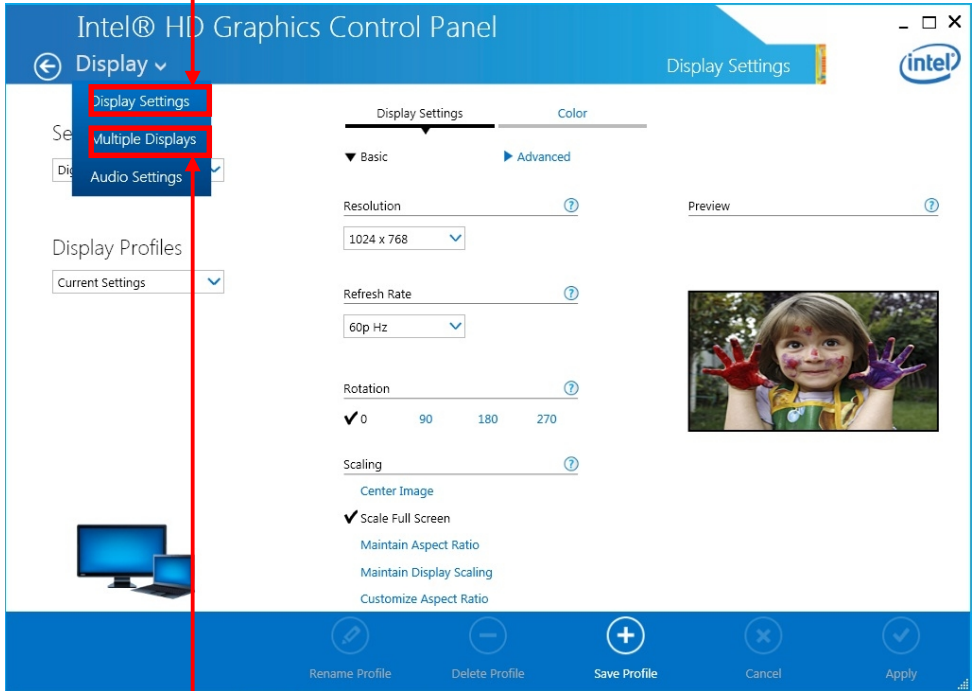

Click [Multiple Displays](#) to setup the dual display mode as same screen

3.3 <SATA configuration>

SATA Mode:

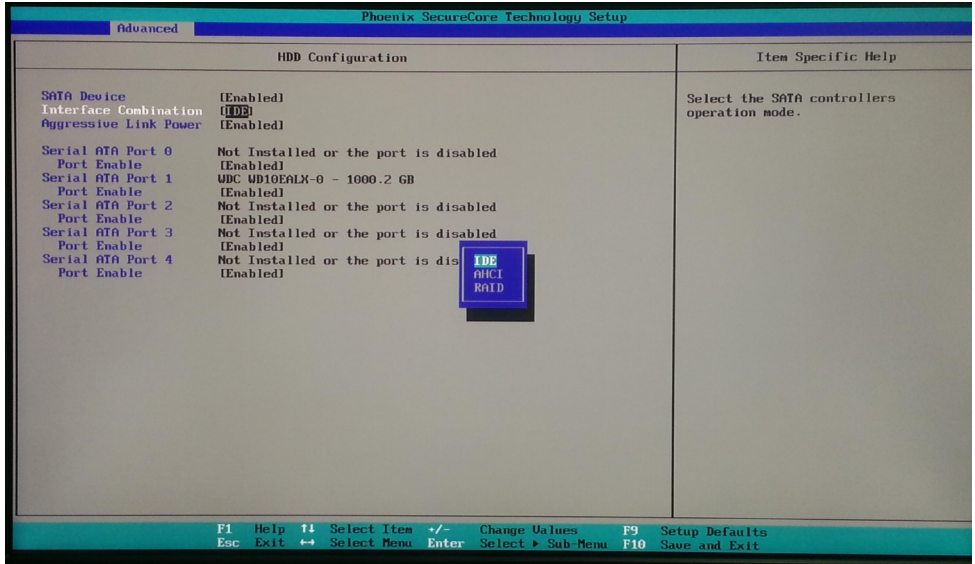

This option can let you select whether the Serial ATA hard drives would work under normal IDE or AHCI or RAID mode. The RAID mode need more than one HDD is applied.

3.4 <SATA RAID Configuration>

The board integrates Intel® Q87 PCH with RAID function for Serial ATA drives, and supports the configurations below:

RAID 0 (Striping): Two hard drives operating as one drive for optimized data R/W performance. It needs two unused drives to build this operation.

RAID 1 (Mirroring): Copies the data from first drive to second drive for data security, and if one drive fails, the system would access the applications to the workable drive. It needs two unused drives or one used and one unused drive to build this operation. The second drive must be the same or larger size than first one.

RAID 5 (striping with parity)

A RAID 5 array contains three or more hard drives where the data is divided into manageable blocks called strips. Parity is a mathematical method for recreating data that was lost from a single drive, which increases fault-tolerance. The data and parity are striped across all the hard drives in the array. The parity is striped in a rotating sequence to reduce bottlenecks associated with the parity calculations.

RAID 10 (RAID 0+1)

A RAID 10 array uses four hard drives to create a combination of RAID levels 0 and 1. The data is striped across a two-drive array forming the RAID 0 component. Each of the drives in the RAID 0 array is then mirrored by a RAID 1 component.

Intel Rapid Storage Technology: This technology would allow you to use **RAID 0+1** mode on only two drives (4 drives needed on traditional RAID 0+1). It will create two partitions on each hard drive to simulate **RAID 0** and **RAID 1**. It also can let you modify the partition size without re-formatted.

For more information of Intel Rapid Storage Technology, please visit Intel's website.

If you need to install an operation system on the RAID set, please use the driver disk attached in the package when it informs you to obtain the RAID drivers.

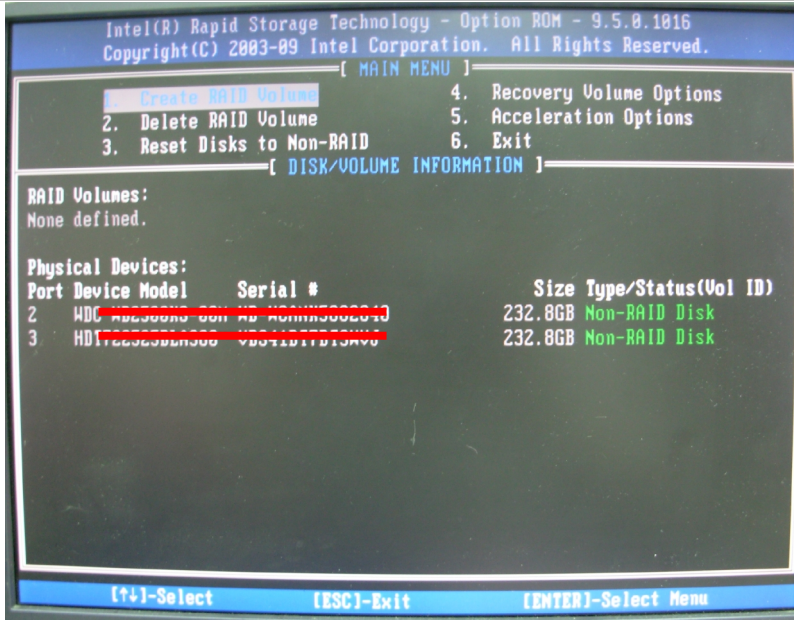

Please press <CTRL>+ to enter the RAID configuration menu.

You can setup the RAID under operation system for Microsoft® Windows 7 , please install the Intel® Application Accelerator Ver.4.5 later to support RAID configuration with Intel® Rapid Storage Technology.

Chapter 4 <BIOS Setup>

The motherboard uses the Phoenix BIOS for the system configuration. The Phoenix BIOS in the single board computer is a customized version of the industrial standard BIOS for IBM PC AT-compatible computers. It supports Intel x86 and compatible CPU architecture based processors and computers. The BIOS provides critical low-level support for the system central processing, memory and I/O sub-systems.

The BIOS setup program of the single board computer let the customers modify the basic configuration setting. The settings are stored in a dedicated battery-backed memory, NVRAM, retains the information when the power is turned off. If the battery runs out of the power, then the settings of BIOS will come back to the default setting.

The BIOS section of the manual is subject to change without notice and is provided here for reference purpose only. The settings and configurations of the BIOS are current at the time of print, and therefore they may not be exactly the same as that displayed on your screen.

To activate CMOS Setup program, press key immediately after you turn on the system. The following message "Press DEL to enter SETUP" should appear in the lower left hand corner of your screen. When you enter the CMOS Setup Utility, the Main Menu will be displayed as **Figure 4-1**. You can use arrow keys to select your function, press <Enter> key to accept the selection and enter the sub-menu.

Figure 4-1 CMOS Setup Utility Main Screen

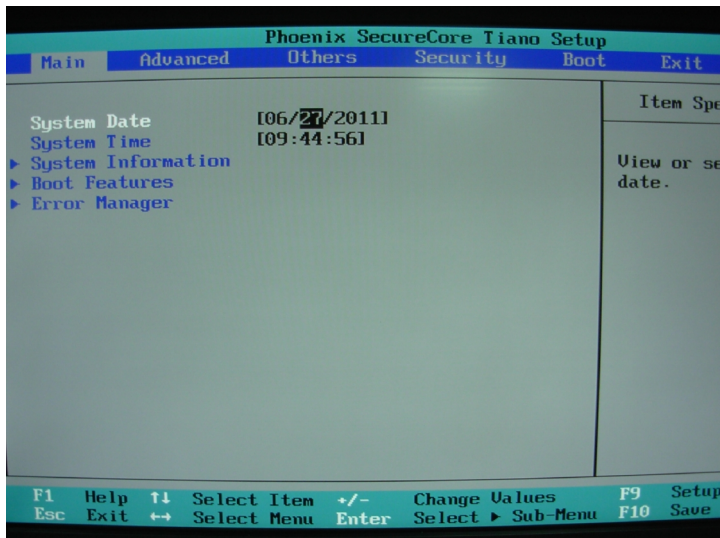

Appendix A <I/O Port Pin Assignment>

A.1 <Serial ATA Port>

Connector: **SATA1/2/3/4**

Type: 7-pin wafer connector

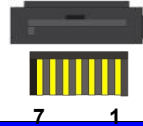

1	2	3	4	5	6	7
GND	RSATA_TXP1	RSATA_TXN1	GND	RSATA_RXN1	RSATA_RXP1	GND

A.2 <IrDA Port>

Connector: **CN_IR**

Type: 5-pin header for SIR Ports

JCSEL1 must jump to "SIR"

Pin	Description
1	VCC
2	N/C
3	IRRX
4	Ground
5	IRTX



A.3 <LAN Port>

Connector: **RJ45**

Type: RJ45 connector with LED on bracket

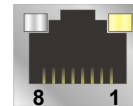

Pin	1	2	3	4	5	6	7	8
Description	MIO+	MIO-	MI1+	MI2+	MI2-	MI1-	MI3+	MI3-

A.4 <Parallel Port>

Connector: **CN_LPT**

Type: 26-Pin box header

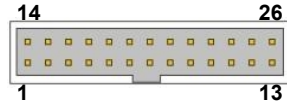

Pin	Description	Pin	Description
1	-PSTB	14	AFD-
2	PRO0	15	ERR-
3	PRO1	16	INT-
4	PRO2	17	SLIN-
5	PRO3	18	Ground
6	PRO4	19	Ground
7	PRO5	20	Ground
8	PRO6	21	Ground
9	PRO7	22	Ground
10	ACK-	23	Ground
11	BUSY	24	Ground
12	PE	25	Ground
13	SLCT	26	N/C

Appendix B <Flash BIOS>

<Flash BIOS Procedure>

1. Please make a bootable floppy disk.
2. Get the last .bin files you want to update and copy it into the disk.
3. Copy Fpt.exe to the disk.
4. Power on the system and flash the BIOS.
(Example: C:/Fpt -savemac -f XXX.bin)
5. Restart the system.

Any question about the BIOS re-flash please contact your distributors or visit the web-site at below:

<http://www.commell.com.tw/support/support.htm>

Appendix C <Programming GPIO's>

The GPIO can be programmed with the MSDOS debug program using simple IN/OUT commands. The following lines show an example how to do this.

```
GPIO0.....GPIO7  bit0.....bit7
-o 2 E 87          ;enter configuration
-o 2E 87
-o 2E 07
-o 2F 09          ;enable GPIO function
-o 2E 30
-o 2F 02          ;enable GPIO configuration
-o 2E F0
-o 2F xx          ;set GPIO as input/output; set '1' for input,'0'for output
-o 2E F1
-o 2F xx          ;if set GPIO's as output,in this register its value can be
                  set
```

Optional :

```
-o 2E F2
-o 2F xx          ; Data inversion register ; '1' inverts the current valus of
                  the bits ,'0' leaves them as they are
-o 2E 30
-o 2F 01          ; active GPIO's
```

For further information, please refer to Winbond W83627DHG-P datasheet.

Appendix D <Programming Watchdog Timer >

The watchdog timer makes the system auto-reset while it stops to work for a period.

The integrated watchdog timer can be setup as system reset mode by program.

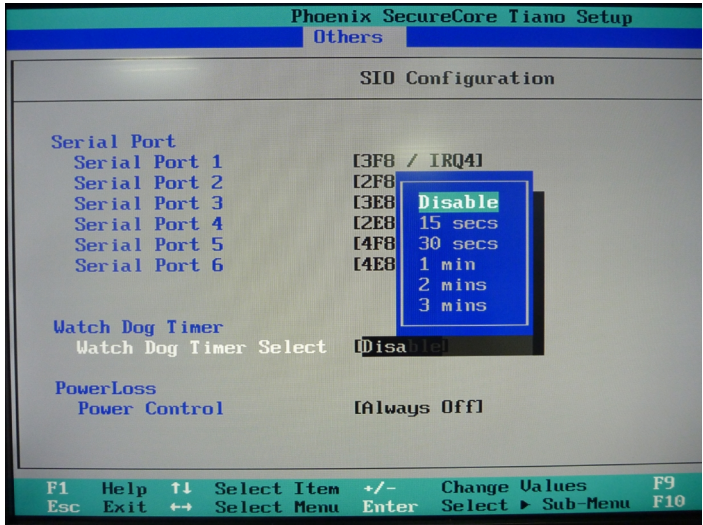

Timeout Value Range

- 1 to 255
- Second or Minute

Program Sample

Watchdog timer setup as system reset with 5 second of timeout

2E, 87	
2E, 87	
2E, 07	
2F, 08	Logical Device 8
2E, 30	Activate
2F, 01	
2E, F5	Set as Second*
2F, 00	
2E, F6	Set as 5
2F, 05	

* Minute: bit 3 = 1; Second: bit 3 = 0

You can select Timer setting in the BIOS, after setting the time options, the system will reset according to the period of your selection.

Contact Information

Any advice or comment about our products and service, or anything we can help you please don't hesitate to contact with us. We will do our best to support you for your products, projects and business.

Taiwan Commate Computer Inc.

Address	19F., No.94, Sec. 1, Xintai 5th Rd., Xizhi Dist., New Taipei City 22102, Taiwan
TEL	+886-2-26963909
FAX	+886-2-26963911
Website	http://www.commell.com.tw
E-Mail	info@commell.com.tw (General Information) tech@commell.com.tw (Technical Support)

Commell is a brand name of Taiwan commate computer Inc.