

Chapter 1

INTRODUCTION

The ATX IR1 mainboard is a high-performance personal computer mainboard based on the AMD® Athlon™ processor with 3DNOW™. The AMD® Athlon™ processor is the newest microprocessor in the AMD K86™ family of microprocessors.

The mainboard uses the highly integrated AMD® 751 system controller and AMD® 756 peripheral controller. The AMD® 751 system controller features: the S2k system interface supports a 100Mhz clock and double-data rate (DDR) transfers, the 33MHz 32-bit PCI bus interface supports up to five masters, the 66MHz AGP 1.0 compliant interface supports 2x data transfer mode, and High Speed memory designed to support a 100MHz SDRAM (PC-100-compatible-DIMM) with serial presence detect(PSD). The AMD® 756 peripheral bus controllers feature an integrated ISA bus controller, an enhanced IDE controller with Ultra DMA-66 support, and a keyboard/mouse controller.

The ATX IR1 mainboard is our first system board to implement the AMD® 750 chipset (AMD® 751 and AMD® 756), which supports a single Slot A for AMD® Athlon™ processor.

1.1 Mainboard Features

CPU

- Slot A for AMD® Athlon™ processor.
- Support 500MHz, 550MHz, 600MHz, or higher processor

Chipset

- AMD® Irongate™ chipset. (Northbridge)
 - 200MHz EV6 System Interface speed
 - 100MHz SDRAM
 - 1x/2x AGp
 - Status - Silicon currently in bring-up
- AMD® 756™ (Viper) chipset. (Southbridge)
 - OHCI USB
 - APIC
 - ACPI Power Management

Front Side Bus (FSB)

- 100MHz clock is supported.

Main Memory

- Supports three memory banks using three 168-pin unbuffered DIMM sockets.
- Supports a maximum memory size of 768MB for SDRAM.
- Supports 3.3v PC100 SDRAM DIMM.

Slots

- One AGP (Accelerated Graphics Port) slot.
 - AGP specification compliant
 - AGP 66/133MHz 3.3v device support
- Five 32-bit Master PCI Bus slots and two 16-bit ISA bus slots (wherein one PCI/ISA is shared)
- Supports 3.3v/5v PCI bus Interface.

On-Board IDE

- An IDE controller on the AMD® 756™ Viper chipset provides IDE HDD/CD-ROM with PIO and Ultra DMA/66 operation modes.
- Can connect up to four IDE devices.

On-Board Peripherals

- On-Board Peripherals include:
 - 1 floppy port supports 2 FDD with 360K, 720K, 1.2M, 1.44M and 2.88Mbytes.
 - 2 serial ports (COMA + COMB)
 - 1 parallel port supports SPP/EPP/ECP mode
 - 4 USB ports
 - 1 IrDA connector for SIR.

BIOS

- The mainboard BIOS provides “Plug & Play” BIOS which detects the peripheral devices and expansion cards of the board automatically.
- The mainboard provides a Desktop Management Interface (DMI) function which records your mainboard specifications.

Dimension

- ATX Form Factor: 20.9cm x 30.5cm

Mounting

- 8 mounting holes.

1.2 Mainboard Layout

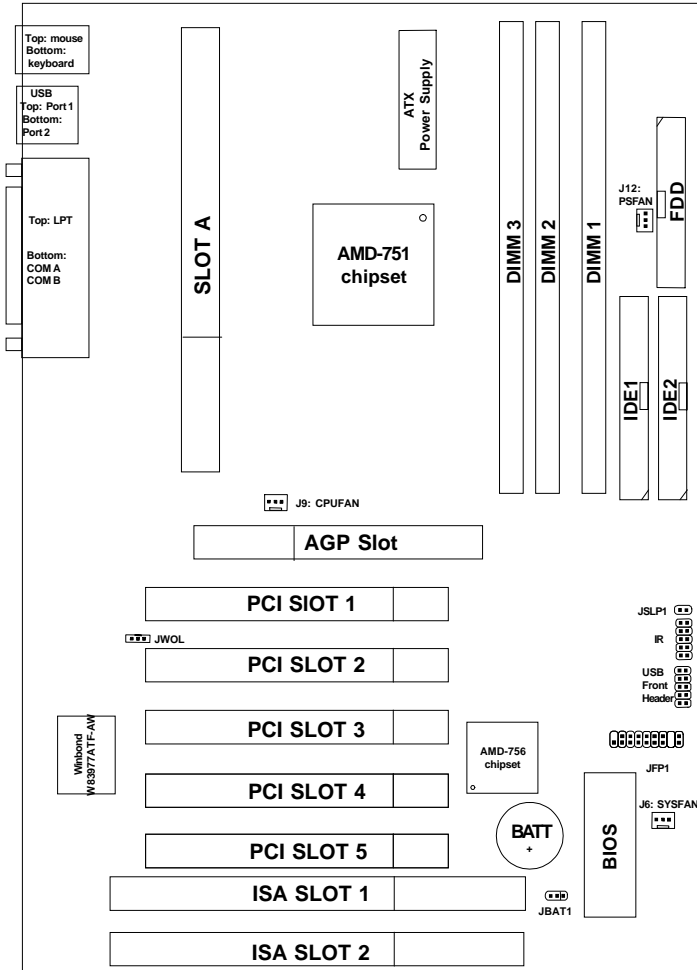

MS-6167 ATX IR1 Mainboard

Chapter 2

HARDWARE INSTALLATION

2.1 Central Processing Unit: CPU

2.1-1 Processor Installation Procedure

Step 1: Install the Retention Mechanism.

Attach the Retention Mechanism to the Mainboard. Push the Plastic lock to secure the Retention Mechanism into the mainboard.

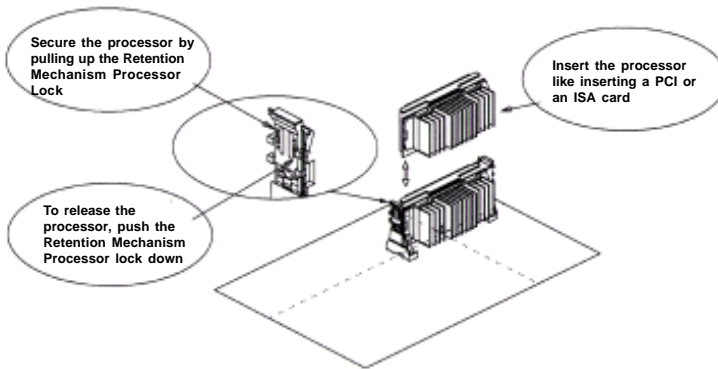

Step 2: Install the Processor.

Insert the Processor like inserting a PCI or an ISA card.

Step 3: Lock the Processor.

Lock the processor by pulling up the Retention Mechanism processor lock shown above.

2.1-2 CPU Core Speed Derivation Procedure

The Mainboard can auto-detect the processor speed. Just insert the AMD Athlon processor into Slot A.

If	<u>CPU Clock</u>	=	100MHz
	<u>Core/Bus ratio</u>	=	5
then	<u>CPU core speed</u>	=	<u>Host Clock</u> x <u>Core/Bus ratio</u>
		=	100MHz x 5
		=	500MHz

2.1-4 Fan Power Connectors: J9, J12, & J6

These connectors support system cooling fan with + 12V. It supports three pin head connector. When connecting the wire to the connector, always take note that the red wire is the positive and should be connected to the +12V, the black wire is Ground and should be connected to GND. If your mainboard has System Hardware Monitor chipset on-board, you must use a specially designed fan with speed sensor to take advantage of this function.

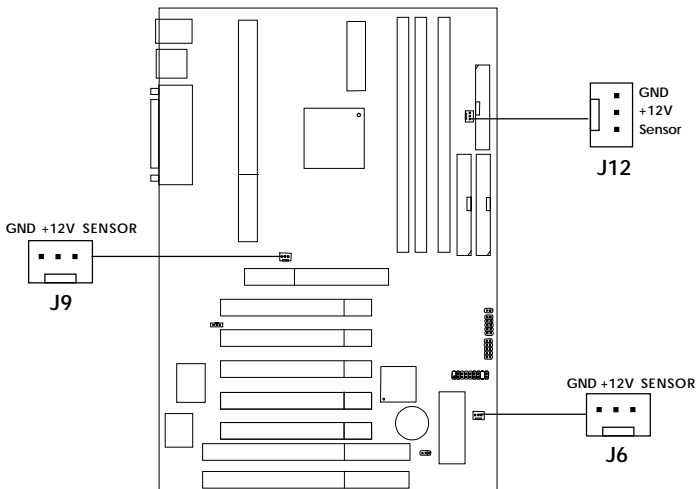

J9: Processor Fan
J12: Power Supply Fan
J6: System Fan

For fans with fan speed sensor, every rotation of the fan will send out 2 pulses. System Hardware Monitor will count and report the fan rotation speed.

Note:

1. Always consult vendor for proper CPU cooling fan.
2. CPU FAN supports the FAN control. You can install PC Alert utility. This will automatically control the CPU FAN Speed according to the actual CPU temperature.

2.2 Clear CMOS Jumper: JBAT1

A battery must be used to retain the mainboard configuration in CMOS RAM. Short 1-2 pins of JBAT1 to store the CMOS data.

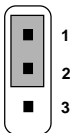
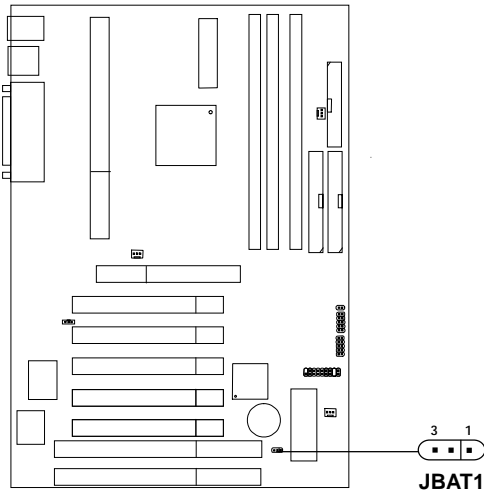

Keep Data

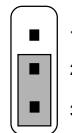

Clear Data

Note: You can clear CMOS by shorting 2-3 pin, while the system is off. Then, return to 1-2 pin position. Avoid clearing the CMOS while the system is on, it will damage the mainboard. Always unplug the power cord from the wall socket.

2.3 Memory Installation

2.3-1 Memory Bank Configuration

The mainboard supports a maximum memory size of 768MB for SDRAM: It provides three 168-pin **unbuffered** DIMMs (Double In-Line Memory Module) sockets. It supports 8 MB to 256 Mbytes DIMM memory module.

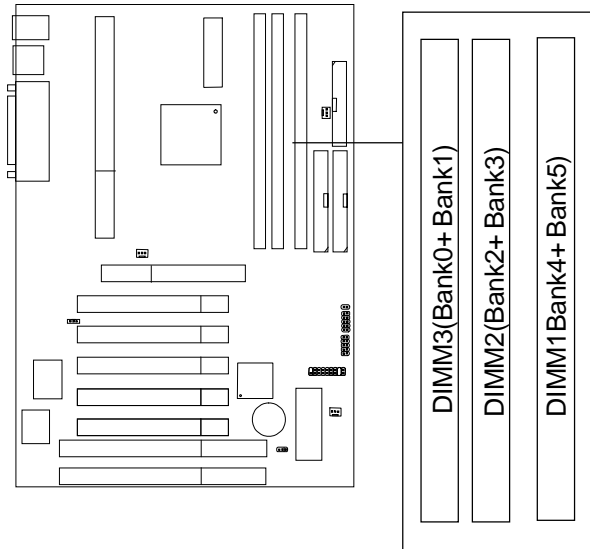

2.3-2 Memory Installation Procedures

A. How to install a DIMM Module

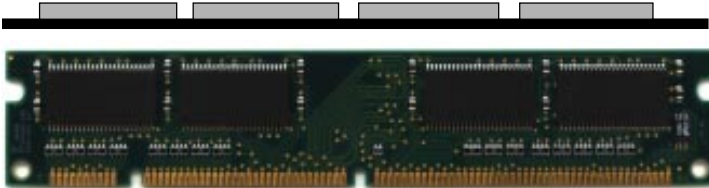

Single Sided DIMM

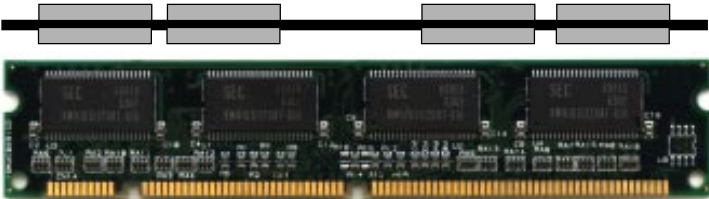

Double Sided DIMM

1. The DIMM slot has 2 Notch Keys “VOLT and DRAM”, so the DIMM memory module can only fit in one direction.
2. Insert the DIMM memory module vertically into the DIMM slot. Then push it in.

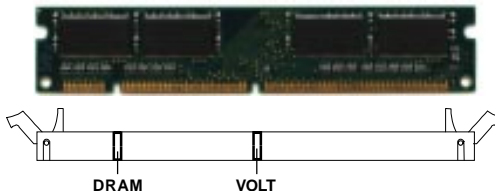

3. The plastic clip at the side of the DIMM slot will automatically close.

2.3-3 Memory Population Rules

1. Supports only PC100 SDRAM DIMM.
2. To operate properly, at least one 168-pin DIMM module must be installed.
3. This mainboard supports Table Free memory, so memory can be installed on DIMM1, DIMM 2, or DIMM 3 in any order.
4. Supports 3.3 volt DIMM.
5. The DRAM addressing and the size supported by the mainboard is shown below:

Table 2.3-1 SDRAM Memory Addressing

DRAM Tech.	DRAM Density & Width	DRAM Addressing	Address Size		MB/DIMM	
			Row	Column	Single no. Side(S) pcs.	Double no. Side(D) pcs.
16M	1Mx16	ASYM	11	8	8MBx4	16MBx8
	2Mx8	ASYM	11	9	16MBx8	32MBx16
64M	2Mx32	ASYM	11	9	32MBx2	64MBx4
	2Mx32	ASYM	12	8	16MBx2	32MBx4
	4Mx16	ASYM	11	10	32MB	64MB
	4Mx16	ASYM	13	8	32MB	64MB
64M	8Mx8	ASYM	13	9	64MB	128MB
	2Mx32	ASYM	11	8	16MB	32MB
64M	4Mx16	ASYM	12	8	---	---
	8Mx8	ASYM	12	9	---	---

2.4 Case Connector: JFP1

The Keylock, Power Switch, Reset Switch, Power LED, Speaker, and HDD LED are all connected to the JFP1 connector block.

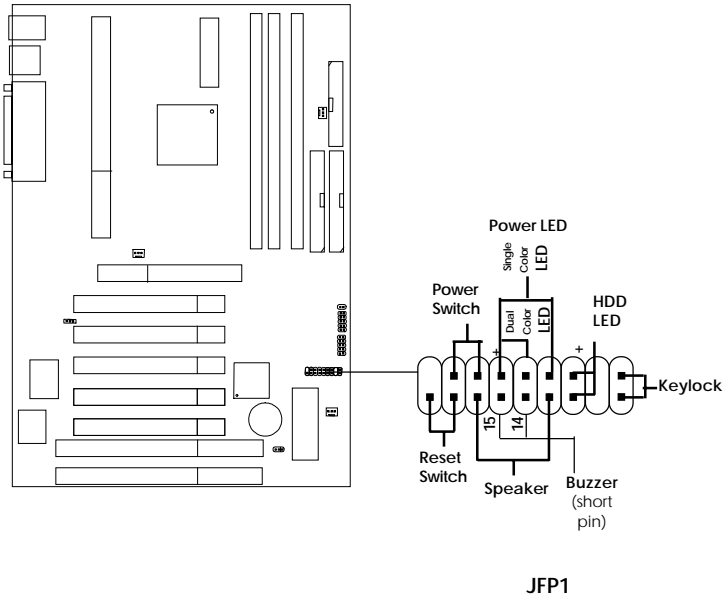

2.4-1 Power Switch

Connect to a 2-pin push button switch. This switch has the same feature with JRMS1.

2.4-2 Reset Switch

Reset switch is used to reboot the system rather than turning the power ON/OFF. Avoid rebooting while the HDD LED is lit. You can connect the Reset switch from the system case to this pin.

2.4-3 Power LED

The Power LED is lit while the system power is on. Connect the Power LED from the system case to this pin. There are two types of LED that you can use: 3-pin single color LED or 2-pin dual color LED(ACPI request).

- a. 3 pin single color LED connect to pin 4, 5, & 6. This LED will lit when the system is on.
- b. 2 pin dual color LED connect to pin 5 & 6.
GREENColor: Indicate the system is in full on mode.
ORANGEColor: Indicate the system is in suspend mode.

2.4-4 Speaker

Speaker from the system case is connected to this pin.

If on-board Buzzer is available:

Short pin 14-15: On-board Buzzer Enabled.

Open pin 14-15: On-board Buzzer Disabled.

2.4-5 HDD LED

HDD LED shows the activity of a hard disk drive. Avoid turning the power off while the HDD led is lit. You can connect the HDD LED from the system case to this pin.

2.4-6 Keylock

Keylock allows you to disable the keyboard for security purposes. You can connect the keylock to this pin.

2.5 Floppy Disk Connector: FDD

The mainboard also provides a standard floppy disk connector FDD that supports 360K, 720K, 1.2M, 1.44M and 2.88M floppy disk types. This connector supports the provided floppy drive ribbon cables.

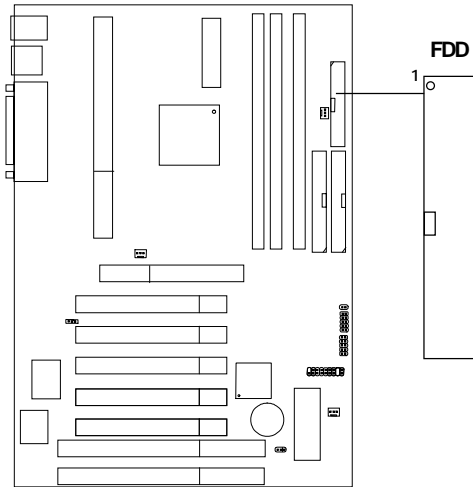

2.6 Hard Disk Connectors: IDE1 & IDE2

The mainboard has a 32-bit Enhanced PCI IDE and Ultra DMA/66 (ICH)/ Ultra DMA/33(ICH0) Controller that provides PIO mode 0~4, Bus Master, and Ultra DMA/33 function. It has two HDD connectors IDE1 (primary) and IDE2 (secondary). You can connect up to four hard disk drives, CD-ROM, 120MB Floppy (reserved for future BIOS) and other devices to IDE1 and IDE2. These connectors support the provided IDE hard disk cable.

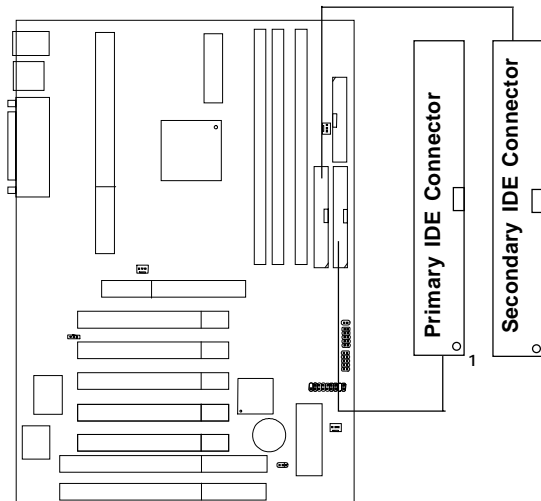

IDE1(Primary IDE Connector)

The first hard drive should always be connected to IDE1. IDE1 can connect a Master and a Slave drive. You must configure second hard drive to Slave mode by setting the jumper accordingly.

IDE2(Secondary IDE Connector)

IDE2 can also connect a Master and a Slave drive.

2.7 Power Supply

2.7-1 ATX 20-pin Power Connector: JPWR1

This connector supports the power button on-board. Using the ATX power supply, functions such as Modem Ring Wake-Up and Soft Power Off are supported by this mainboard. This power connector supports instant power on function which means that system will boot up instantly when the power connector is inserted on the board.

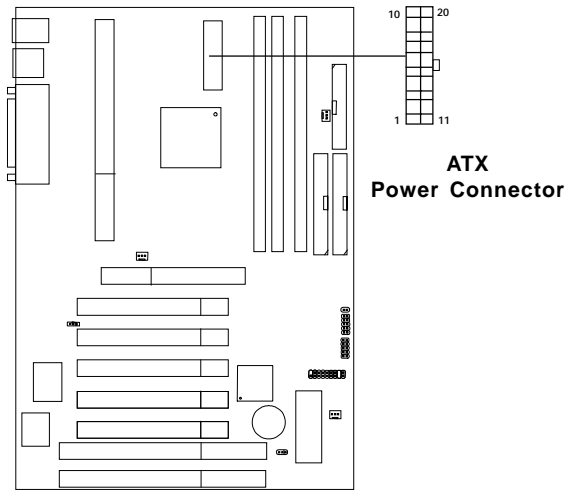

PIN DEFINITION

PIN	SIGNAL	PIN	SIGNAL
1	3.3V	11	3.3V
2	3.3V	12	-12V
3	GND	13	GND
4	5V	14	PS_ON
5	GND	15	GND
6	5V	16	GND
7	GND	17	GND
8	PW_OK	18	-5V
9	5V_SB	19	5V
10	12V	20	5V

Warning: Since the mainboard has the instant power on function, make sure that all components are installed properly before inserting the power connector to ensure that no damage will be done.

2.8 IrDA Infrared Module Connector: IR

The mainboard provides one infrared (IR) connector for IR modules. This connector is for optional wireless transmitting and receiving infrared module. You must configure the setting through the BIOS setup to use the IR function.

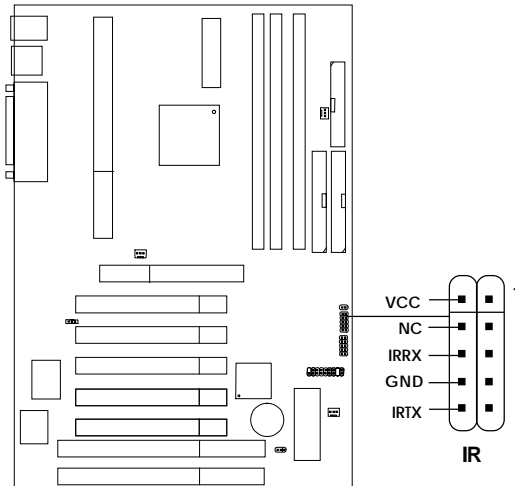

2.9 Serial Port Connectors: COM A and COM B

The mainboard provides two 9-pin male DIN connector for serial port COM A and COM B. These port are 16550A high speed communication port that send/receive 16 bytes FIFOs. You can attach a mouse or a modem cable directly into this connector.

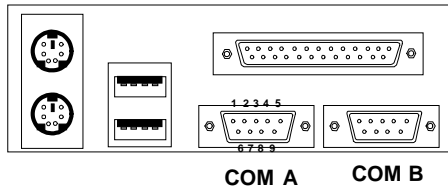

Serial Port (9-pin Male)

PIN DEFINITION

PIN	SIGNAL
1	DCD (Data Carry Detect)
2	SIN (Serial In or Receive Data)
3	SOUT (Serial Out or Transmit Data)
4	DTR (Data Terminal Ready)
5	GND
6	DSR (Data Set Ready)
7	RTS (Request To Send)
8	CTS (Clear To Send)
9	RI (Ring Indicate)

2.10 Parallel Port Connector: LPT1

The mainboard provides a 25 pin female centronic connector for LPT. A parallel port is a standard printer port that also supports Enhanced Parallel Port(EPP) and Extended capabilities Parallel Port(ECP). See connector and pin definition below:

Parallel Port (25-pin Female)

LPT 1

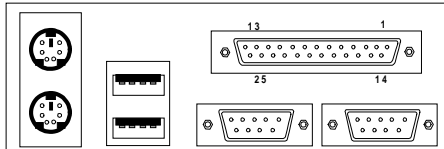

PIN DEFINITION

PIN	SIGNAL	PIN	SIGNAL
1	STROBE	14	AUTO FEED#
2	DATA0	15	ERR#
3	DATA1	16	INIT#
4	DATA2	17	SLIN#
5	DATA3	18	GND
6	DATA4	19	GND
7	DATA5	20	GND
8	DATA6	21	GND
9	DATA7	22	GND
10	ACK#	23	GND
11	BUSY	24	GND
12	PE	25	GND
13	SELECT		

2.11 Mouse Connector: JKBMS1

The mainboard provides a standard PS/2[®] mouse mini DIN connector for attaching a PS/2[®] mouse. You can plug a PS/2[®] mouse directly into this connector. The connector location and pin definition are shown below:

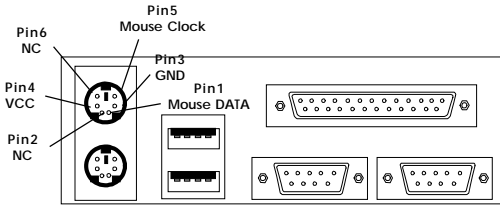

PS/2 Mouse (6-pin Female)

2.12 Keyboard Connector: JKBMS1

The mainboard provides a standard PS/2[®] keyboard mini DIN connector for attaching a keyboard. You can plug a keyboard cable directly to this connector.

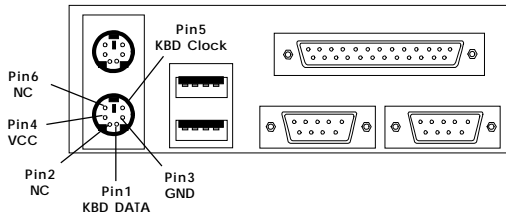

PS/2 Keyboard (6-pin Female)

2.13 USB Connectors

The mainboard provides a **UHCI(Universal Host Controller Interface) Universal Serial Bus root** for attaching USB devices like: keyboard, mouse and other USB devices. You can plug the USB device directly to this connector.

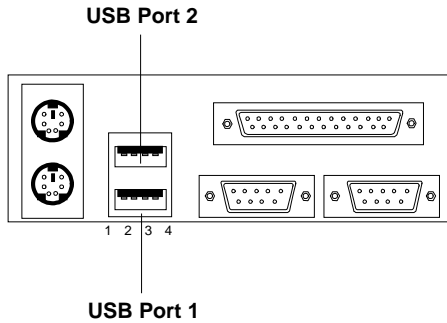

PIN	SIGNAL
1	VCC
2	-Data0
3	GND
4	+Data0

2.14 USB Front Connector

The mainboard provides a **front Universal Serial Bus connector**. This is an optional USB connector for Front Panel.

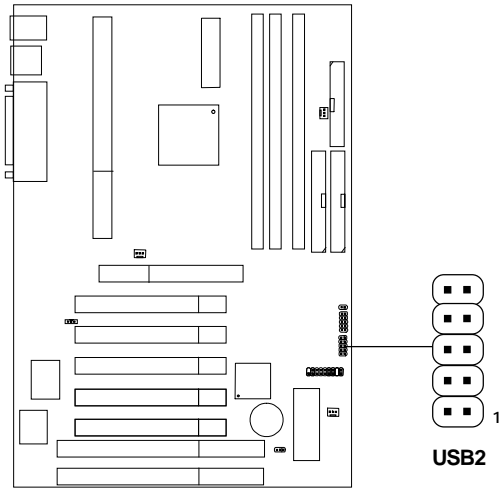

2.15 Wake-Up on LAN Connector: JWOL

The JWOL connector is for use with LAN add-on cards that supports Wake Up on LAN function. To use this function, you need to set the “Wake-Up on LAN” to enable at the BIOS Power Management Setup.

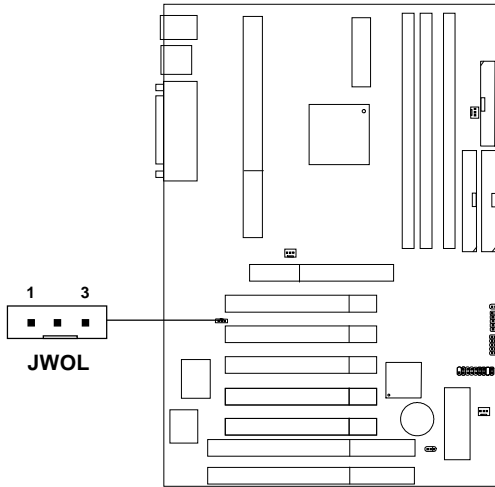

PIN	SIGNAL
1	5VSB
2	GND
3	MP_WAKEUP

Note: LAN wake-up signal is active “high”.

Note: To be able to use this function, you need a power supply that provide enough power for this feature. (Power supply with 750ma 5V Stand-by)

2.16 Power Saving Switch Connector: JSLP1

Attach a power saving switch to **JSLP1**. When the switch is pressed, the system immediately goes into suspend mode. Press any key and the system wakes up.

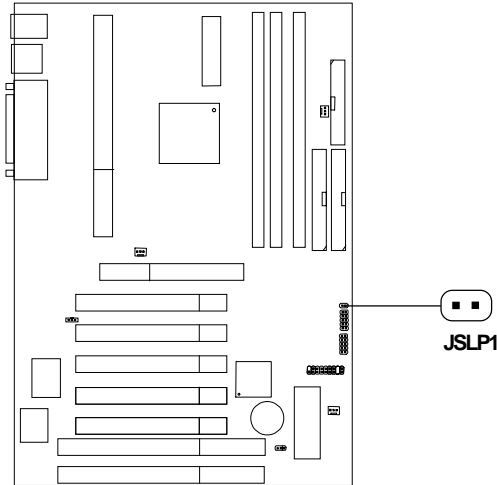

Chapter 3

AWARD® BIOS SETUP

Award® BIOS ROM has a built-in Setup program that allows users to modify the basic system configuration. This type of information is stored in battery-backed RAM (CMOS RAM), so that it retains the Setup information when the power is turned off.

3.1 Entering Setup

Power on the computer and press immediately to allow you to enter Setup. The other way to enter Setup is to power on the computer. When the below message appears briefly at the bottom of the screen during the POST (Power On Self Test), press key or simultaneously press <Ctrl>, <Alt>, and <Esc> keys.

TO ENTER SETUP BEFORE BOOT, PRESS <CTRL-ALT-ESC>
OR KEY

If the message disappears before you respond and you still wish to enter Setup, restart the system to try again by turning it OFF then ON or pressing the “RESET” button on the system case. You may also restart by simultaneously pressing <Ctrl>, <Alt>, and <Delete> keys. If you do not press the keys at the correct time and the system does not boot, an error message will be displayed and you will again be asked to,

PRESS <F1> TO CONTINUE, <CTRL-ALT-ESC>
OR TO ENTER SETUP

3.2 Getting Help

Main Menu

The on-line description of the highlighted setup function is displayed at the bottom of the screen.

Status Page Setup Menu/Option Page Setup Menu

Press F1 to pop up a small help window that describes the appropriate keys to use and the possible selections for the highlighted item. To exit the Help Window, press <Esc>.

Advanced Chipset Features

Use this menu to change the values in the chipset registers and optimize your system's performance.

Integrated Peripherals

Use this menu to specify your settings for integrated peripherals.

Power Management Setup

Use this menu to specify your settings for power management.

PnP/PCI Configurations

This entry appears if your system supports PnP/PCI.

Frequency/Voltage Control

Use this menu to specify your settings for frequency/voltage control.

Load Fail-Safe Defaults

Use this menu to load the BIOS default values for the minimal/stable performance for your system to operate.

Load Optimized Defaults

Use this menu to load the BIOS default values that are factory settings for optimal performance system operations.

Supervisor/User Password

Use this menu to set User and Supervisor Passwords.

Save & Exit Setup

Save CMOS value changes to CMOS and exit setup.

Exit Without Saving

Abandon all CMOS value changes and exit setup.

3.4 Standard CMOS Features

The items in Standard CMOS Setup Menu are divided into 10 categories. Each category includes no, one or more than one setup items. Use the arrow keys to highlight the item and then use the <PgUp> or <PgDn> keys to select the value you want in each item.

CMOS Setup Utility - Copyright(C) 1984-1999 Award Software
Standard CMOS Setup

Date(mm:dd:yy):	Fri, July 23,1999	Item Help
Time(hh:mm:ss):	00:00:00	
IDE Primary Master	Press Enter 2557MB	Menu Level >
IDE Primary Slave	Press Enter None	
IDE Secondary Master	Press Enter None	
IDE Secondary Slave	Press Enter None	
Drive A	1.44M, 3.5in.	
Drive B	None	
Video	EGA/VGA	
Halt On	All Errors	
Based Memory	640K	
Extended Memory	64512K	
Total Memory	65536K	
↑↓ →← Move Enter:Select +/-/PU/PD:Value F10:Save ESC:Exit F1:General Help F5:Previous Values F6:Fail-safe defaults F7:Optimized Defaults		

Date

The date format is <day><month> <date> <year>.

Day	Day of the week, from Sun to Sat, determined by BIOS. Read-only.
month	The month from Jan. through Dec.
date	The date from 1 to 31 can be keyed by numeric function keys.
year	The year, depends on the year of the BIOS

Time

The time format is <hour> <minute> <second>.

PrimaryMaster/PrimarySlave**SecondaryMaster/Secondary Slave**

Press PgUp/<+> or PgDn/<-> to select Manual, None, Auto type.

Note that the specifications of your drive must match with the drive table. The hard disk will not work properly if you enter improper information for this category. If your hard disk drive type is not matched or listed, you can use Manual to define your own drive type manually.

If you select Manual, related information is asked to be entered to the following items. Enter the information directly from the keyboard. This information should be provided in the documentation from your hard disk vendor or the system manufacturer.

If the controller of HDD interface is SCSI, the selection shall be
“None”.

If the controller of HDD interface is CD-ROM, the selection shall be
“None”.

Access Mode	The settings are Auto, Normal, Large,LBA.
Cylinder	number of cylinders
Head	number of heads
Precomp	write precom
Landing Zone	landing zone
Sector	number of sectors

3.5 Advanced BIOS Features

CMOS Setup Utility - Copyright(C) 1984-1999 Award Software
Advanced BIOS Features

Virus Warning	Disabled	Item Help
CPU Internal Cache	Enabled	
External Cache	Enabled	Menu Level >
Quick Power On Self Test	Disabled	
First Boot device	Floppy	
Second Boot device	HDD-0	
Third Boot device	LS/Zip	
Boot other device	Enabled	
Swap Floppy Drive	Disabled	
Boot Up Floppy Seek	Disabled	
Boot Up Numlock Status	Off	
Gate A20 Option	Fast	
Typematic Rate Setting	Disabled	
Typematic Rate (Chars/Sec)	6	
Typematic Delay (Msec)	250	
Security Option	Setup	
OS Select for DRAM > 64MB	Non-OS2	
Video BIOS Shadow	Enabled	
↑ ↓ → ← Move Enter:Select +/-/PU/PD:Value F10:Save ESC:Exit F1:General Help F5:Previous Values F6:Fail-safe defaults F7:Optimized Defaults		

Virus Warning

Allows you to choose the VIRUS Warning feature for IDE Hard Disk boot sector protection. If this function is enabled and someone attempt to write data into this area, BIOS will show a warning message on screen and alarm beep.

Disable(default) No warning message to appear when anything attempts to access the boot sector or hard disk partition table.

Enable Activates automatically when the system boots up causing a warning message to appear when anything attempts to access the boot sector of hard disk partition table.

CPU Internal Cache

The default value is Enabled.

Enabled (default) Enable cache

Disabled Disable cache

Note: The internal cache is built in the processor.

External Cache

Choose Enabled or Disabled. This option enables the level 2 cache memory.

Quick Power On Self Test

This category speeds up Power On Self Test (POST) after you power on the computer. If this is set to Enabled, BIOS will shorten or skip some check items during POST.

Enabled Enable quick POST

Disabled (default) Normal POST

First/Second/Third/Other Boot Device

The BIOS attempts to load the operating system from the devices in the sequence selected in these items. The settings are Floppy, LS/ZIP, HDD-0/HDD-1/HDD-2/HDD-3, SCSI, CDROM, LAN, and Disabled.

Swap Floppy Drive

Switches the floppy disk drives between being designated as A and B. Default is Disabled.

Boot Up Floppy Seek

During POST, BIOS will determine if the floppy disk drive installed is 40 or 80 tracks. 360K type is 40 tracks while 760K, 1.2M and 1.44M are all 80 tracks.

Boot Up NumLock Status

The default value is On.

On Keypad is numeric keys.

Off(default) Keypad is arrow keys.

Gate A20 Option

Normal The A20 signal is controlled by keyboard controller or chipset hardware.

Fast(default) The A20 signal is controlled by port 92 or chipset specific method.

Typematic Rate Setting

Key strokes repeat at a rate determined by the keyboard controller. When enabled, the typematic rate and typematic delay can be selected. The settings are: Enabled/Disabled.

Typematic Rate (Chars/Sec)

Sets the number of times a second to repeat a key stroke when you hold the key down. The settings are: 6, 8, 10, 12, 15, 20, 24, 30.

Typematic Delay (Msec)

Sets the delay time after the key is held down before it begins to repeat the keystroke. The settings are: 250, 500, 750, 1000.

Security Option

This category allows you to limit access to the system and Setup, or just to Setup.

System The system will not boot and access to Setup will be denied if the correct password is not entered at the prompt.

Setup(default)The system will boot, but access to Setup will be denied if the correct password is not entered at the prompt.

OS Selection for DRAM > 64MB

Allows OS2® to be used with > 64 MB of DRAM. Settings are Non-OS/2 (default) and OS2. Set to OS/2 if using more than 64MB and running OS/2®.

Video BIOS Shadow

Determines whether video BIOS will be copied to RAM for faster execution. Video shadow will increase the video performance.

Enabled (default)	Video BIOS will be enabled
Disabled	Video BIOS will be disabled

3.6 Advanced Chipset Features

The Advanced Chipset Features Setup option is used to change the values of the chipset registers. These registers control most of the system options in the computer.

Choose the “ADVANCED CHIPSET FEATURES” from the Main Menu and the following screen will appear.

CMOS Setup Utility - Copyright(C) 1984-1999 Award Software
 Advanced Chipset Features

SDRAM Precharge Control	Disabled	Item Help
System BIOS Cacheable	Disabled	
Video RAM Cacheable	Disabled	Menu Level >
Memory Hole At 15M-16M	Disabled	
AGP Aperture Size (MB)	64	
AGP ISA Aliasing	Enabled	
K7 CLK CTL Select	Optimal	
SDRAM PH Limit	64 Cycle	
SDRAM Idle Limit	8 Cycle	
SDRAM Trc Timing Value	7 Cycle	
SDRAM Trp Timing Value	2 Cycle	
SDRAM Tras Timing Value	5 Cycle	
SDRAM CAS Latency	3 Cycle	
SDRAM Trcd Timing Value	2 Cycle	

↑ ↓ → ← Move Enter:Select +/-/PU/PD:Value F10:Save ESC:Exit F1:General Help
 F5:Previous Values F6:Fail-safe defaults F7:Optimized Defaults

Note: Change these settings only if you are familiar with the chipset.

SDRAM Precharge Control

This item allows you to Enabled or Disabled SDRAM Precharge Control.

System BIOS Cacheable

Selecting *Enabled* allows caching of the system BIOS ROM at F0000h-FFFFFh, resulting in better system performance. However, if any program writes to this memory area, a system error may result. The settings are: Enabled and Disabled.

Video RAM Cacheable

Select Enabled allows caching of the video RAM, resulting in better system performance. However, if any program writes to this memory area, a system error may result.

Memory Hole At 15M-16M

You can reserve this area of system memory for ISA adapter ROM. When this area is reserved, it cannot be cached. The user information of peripherals that need to use this area of system memory usually discusses their memory requirements. The settings are: Enabled and Disabled.

AGP Aperture Size (MB)

Select the size of the Accelerated Graphics Port (AGP) aperture. The aperture is a portion of the PCI memory address range dedicated for graphics memory address space. Host cycles that hit the aperture range are forwarded to the AGP without any translation.

AGP ISA Aliasing

This item allows you to enabled or disabled the AGP ISA aliasing.

K7 CLK_CTL Select

During Optimal, this item will auto-detect the processor clock generator. During None, the processor clock will always be set to 100MHz.

SDRAM PH Limit

This item specify the number of consecutive Page-Hit requests to allow before choosing a non Page-Hit request. The settings are: 1/4/32/64 cycles.

SDRAM Idle Limit

This item specify the number of idel cycles to wait before precharging an idle bank. The settings are: 1/8/32/64 cycles.

SDRAM Trc Timing Value

This item specify the minimum time to activate the same bank. The settings are: 3/4/5/6/7/8 cycles or reserved.

SDRAM Trp Timing Value

This item specify the delay from precharge command to activate command. The settings are 3/2/1 cycles

SDRAM Tras Timing Value

This item specify the minimum bank active time. The settings are: 2/3/4/5/6/7 cycles or reserved.

SDRAM CAS latency

When synchronous DRAM is installed, the number of clock cycles of CAS latency depends on the DRAM timing. The settings are: 2/3 cycles.

SDRAM Trcd Timing Value

This item specify the delay from activation of a bank to the time that a read or write command is accepted. The settings are: 1/2/3/4 cycles.

3.7 Integrated Peripherals

CMOS Setup Utility - Copyright(C) 1984-1999 Award Software
Integrated Peripherals

IDE Read/Write Prefetch	Disabled	Item Help
IDE Primary Master PIO	Auto	
IDE Primary Slave PIO	Auto	Menu Level >
IDE Secondary Master PIO	Auto	
IDE Secondary Slave PIO	Auto	↑ ↓ → ← Move Enter:Select +/-/PU/PD:Value F10:Save ESC:Exit F1:General Help F5:Previous Values F6:Fail-safe defaults F7:Optimized Defaults
IDE Primary Master UDMA	Auto	
IDE Primary Slave UDMA	Auto	
IDE Secondary Master UDMA	Auto	
IDE Secondary Slave UDMA	Auto	
On-Chip Primary PCI IDE	Enabled	
On-Chip Secondary PCI IDE	Enabled	
USB Host Controller	Enabled	
USB Keyboard Support	Enabled	
Init Display First	PCI Slot	
IDE HDD Block Mode	Enabled	
Onboard FDC Controller	Enabled	
Onboard Serial Port 1	3F8/IRQ4	
Onboard Serial Port 2	2F8/IRQ3	
Onboard IR Controller	Disabled	
IR Address Select	2E8H	
IR Mode	IrDA	
IR Transmission delay	Enabled	
IR IRQ Select	IRQ10	
IR Mode Use DMA	Disable	
Onboard Parallel Port	378/IRQ7	
Parallel Port Mode	SPP	
ECP Mode Use DMA	3	
EPP Mode Select	EPP1.9	

IDE Read/Write Prefetch

During Enabled, the IDE Read/Write prefetch buffer will be used to store data for faster performance.

IDE Primary/Secondary Master/Slave PIO

The four IDE PIO (Programmed Input/Output) fields let you set a PIO mode (0-4) for each of the four IDE devices that the onboard IDE interface supports. Modes 0 through 4 provide successively increased performance. In Auto mode, the system automatically determines the best mode for each device. The settings are: Auto, Mode 0, Mode 1, Mode 2, Mode 3, Mode 4.

IDE Primary/Secondary Master/Slave UDMA

Ultra DMA/33 implementation is possible only if your IDE hard drive supports it and the operating environment includes a DMA driver (Windows 95 OSR2 or a third-party IDE bus master driver). If your hard drive and your system software both support Ultra DMA/33 and Ultra DMA/66, select Auto to enable BIOS support. The settings are: Auto, Disabled.

OnChip Primary/Secondary PCI IDE

The integrated peripheral controller contains an IDE interface with support for two IDE channels. Select *Enabled* to activate each channel separately. The settings are: Enabled and Disabled.

USB Host Controller

Select *Enabled* if your system contains a Universal Serial Bus (USB) controller and you have USB peripherals. The settings are: Enabled, Disabled.

USB Keyboard Support

Select *Enabled* if your system contains a Universal Serial Bus (USB) controller and you have a USB keyboard. The settings are: Enabled, Disabled.

Init Display First

This item allows you to decide to activate whether PCI Slot or on-chip VGA first. The settings are: PCI Slot, Onboard.

IDE HDD Block Mode

Block mode is also called block transfer, multiple commands, or multiple sector read/write. If your IDE hard drive supports block mode (most new drives do), select Enabled for automatic detection of the optimal number of block read/writes per sector the drive can support. The settings are: Enabled, Disabled.

Onboard FDC Controller

Select Enabled if your system has a floppy disk controller (FDD) installed on the system board and you wish to use it. If you install add-on FDC or the system has no floppy drive, select Disabled in this field. The settings are: Enabled and Disabled.

Onboard Serial Port 1/Port 2

Select an address and corresponding interrupt for the first and second serial ports. The settings are: 3F8/IRQ4, 2E8/IRQ3, 3E8/IRQ4, 2F8/IRQ3, Disabled, Auto.

Onboard IR Controller

This item allows you to Enabled or Disabled the onboard IR(Infrared) controller.

IR Address Select

This item allows you to select which address the IR will occupy.

IR Mode

This item allows you to select the IR mode.

IR Transmission Delay

This item allows you to Enabled or Disabled the IR transmitting delay.

IR IRQ Select

This item allows you to select which IRQ the IR will occupy.

IR Mode Use DMA

This item allows you to Enabled or Disabled the IR using DMA mode.

Onboard Parallel Port

Disabled
(3BCH/IRQ7)/
(278H/IRQ5)/
(378H/IRQ7)

There is a built-in parallel port on the on-board Super I/O chipset that provides Standard, ECP, and EPP features. It has the following options:

Disable
3BCH/IRQ7 Line Printer port 0
278H/IRQ5 Line Printer port 2
378H/IRQ7 Line Printer port 1

Onboard Parallel Mode

SPP : Standard Parallel Port
EPP : Enhanced Parallel Port
ECP : Extended Capability Port

**SPP/EPP/ECP/
ECP+EPP**

To operate the onboard parallel port as Standard Parallel Port only, choose "SPP." To operate the onboard parallel port in the EPP modes simultaneously, choose "EPP." By choosing "ECP", the onboard parallel port will operate in ECP mode only. Choosing "ECP + EPP" will allow the onboard parallel port to support both the ECP and EPP modes simultaneously. The ECP mode has to use the DMA channel, so choose the onboard parallel port with the ECP feature. After selecting it, the following message will appear: "ECP Mode Use DMA" At this time, the user can choose between DMA

channels 3 or 1. The onboard parallel port is EPP Spec. compliant, so after the user chooses the onboard parallel port with the EPP function, the following message will be displayed on the screen: “EPP Mode Select.” At this time either EPP 1.7 spec. or EPP 1.9 spec. can be chosen.

3.8 Power Management Setup

The Power Management Setup allows you to configure you system to most effectively save energy while operating in a manner consistent with your own style of computer use.

CMOS Setup Utility - Copyright(C) 1984-1999 Award Software
Power Management Setup

ACPI Function	Enabled	Item Help
Power Management	User Define	
Video Off Method	DPMS Support	Menu Level >
Suspend Type	PwrOn Suspend	
Standby Mode	Disabled	
HDD Power Down	Disabled	
HDD Down In Suspend	Disabled	
Soft-Off by BTN	Instant-Off	
RI Resume/WOL	3	
Modem Use IRQ	3	
RTC Resume	Disabled	
Date (of Month) Alarm	0	
Date (hh:mm:ss) Alarm	0	
Primary IDE 0	Enabled	
Primary IDE 1	Enabled	
Secondary IDE 0	Enabled	
Secondary IDE 1	Enabled	
Parallel Port	Disabled	
Serial Port	Disabled	
IRQ3 (COM 2)	Disabled	
IRQ4 (COM 1)	Disabled	
IRQ5 (LPT 2)	Disabled	
IRQ6 (Floppy Disk)	Disabled	
↑ ↓ → ← Move Enter:Select +/-/PU/PD=Value F10:Save ESC:Exit F1:General Help F5:Previous Values F6:Fail-safe defaults F7:Optimized Defaults		
IRQ7 (LPT 1)	Disabled	
IRQ8 (RTC Alarm)	Disabled	
IRQ9 (IRQ2 Redir)	Disabled	
IRQ10 (Reserved)	Disabled	
IRQ11 (Reserved)	Disabled	
IRQ12 (PS/2 Mouse)	Disabled	
IRQ13 (Coprocessor)	Disabled	
IRQ14 (Hard Disk)	Disabled	
IRQ15 (Reserved)	Disabled	

ACPI Function

This item allows you to enable/disable the Advanced Configuration and Power Management (ACPI). The settings are: Enabled and Disabled.

Power Management

This category allows you to select the type (or degree) of power saving and is directly related to the following modes:

1. Suspend Mode
2. HDD Power Down

There are three selections for Power Management, two of which have fixed mode settings.

Min. Power Saving	Minimum power management. Suspend Mode = 1 hr., and HDD Power Down = 15 min.
Max. Power Saving	Maximum power management — Suspend Mode = 1 min., and HDD Power Down = 1 min.
User Defined (default)	Allows you to set each mode individually. When not disabled, each of the ranges are from 1 min. to 1 hr. except for HDD Power Down which ranges from 1 min. to 15 min. and disable.

Video Off Method

This determines the manner in which the monitor is blanked.

V/HSYNC+Blank	This selection will cause the system to turn off the vertical and horizontal synchronization ports and write blanks to the video buffer.
Blank Screen	This option only writes blanks to the video buffer.
DPMS (default)	Initial display power management signaling.

Suspend Type

Select the Suspend Type. The settings are: PWRON Suspend, Stop Grant.

Standby Mode

When enabled and after the set time of system inactivity, all devices except will be shut off. The settings are: 1/2/4/8/12/20/30/40 Min, 1 Hour, and Disabled.

HDD Power Down

When enabled and after the set time of system inactivity, the hard disk drive will be powered down while all other devices remain active. The settings are: 1/2/3/4/5/6/7/8/9/10/11/12/13/14/15Min and Disabled.

HDD Down In Suspend

When enabled, the hard disk drive will be powered down with the other device during suspend mode. The settings are: Enabled and Disabled.

Soft-Off by PWRBTN

Pressing the power button for more than 4 seconds forces the system to enter the Soft-Off state. The settings are: Delay 4 Sec, Instant-Off.

RI Resume/WOL

To use this function, you need a LAN add-on card which support power on functions. It should also support the wake-up on LAN jumper (JWOL).

Enabled	Wake up on LAN supported.
Disabled	Wake up on LAN not supported.

Modem Use IRQ

This determines the IRQ in which the MODEM can use. The settings are: 3, 4, 5, 7, 9, 10, 11, NA.

RTC Resume

This function is for setting date and time for your computer to boot up. During Disabled, you cannot use this function. During Enabled, choose the Date and Time Alarm:

Date(of month) Alarm	You can choose which month the system will boot up. Set to 0, to boot every day.
Time(hh:mm:ss) Alarm	You can choose what hour, minute and second the system will boot up.

Note: If you have change the setting, you must let the system boot up until it goes to the operating system, before this function will work.

Reload Global Timer Events

Reload Global Timer events are I/O events whose occurrence can prevent the system from entering a power saving mode or can awaken the system from such a mode. In effect, the system remains alert for anything which occurs to a device which is configured as *Enabled*, even when the system is in a power down mode.

Primary IDE 0

Primary IDE 1

Secondary IDE 0

Secondary IDE 1

Parallel Port

Serial Port

IRQ3 (COM 2)

IRQ4 (COM 1)

IRQ5 (LPT 2)

IRQ6 (Floppy Disk)

IRQ7 (LPT 1)

IRQ8 (RTC Alarm)

IRQ9 (IRQ2 Redir)

IRQ10 (Reserved)

IRQ11 (Reserved)

IRQ12 (PS/2 Mouse)

IRQ13 (Coprocessor)

IRQ14 (Hard Disk)

IRQ15 (Reserved)

3.9 PnP/PCI Configuration Setup

This section describes configuring the PCI bus system. PCI, or **P**ersonal **C**omputer **I**nterconnect, is a system which allows I/O devices to operate at speeds nearing the speed the CPU itself uses when communicating with its own special components. This section covers some very technical items and it is strongly recommended that only experienced users should make any changes to the default settings.

CMOS Setup Utility - Copyright(C) 1984-1999 Award Software
PnP/PCI Configuration Setup

PnP OS Installed	No	Item Help
Reset Configuration Data	Disabled	
Resources Controlled By	Auto	Menu Level >
IRQ Resources	Press Enter	
Memory Resources	Press Enter	
PCI/VGA Palette Snoop	Disabled	
↑ ↓ → ← Move Enter:Select +/-/PU/PD:Value F10:Save ESC:Exit F1:General Help F5:Previous Values F6:Fail-safe defaults F7:Optimized Defaults		

PNP OS Installed

This item allows you to determine, whether to install PnP OS or not. The settings are: Yes or No.

Reset Configuration Data

Normally, you leave this field Disabled. Select Enabled to reset Extended System Configuration Data (ESCD) when you exit Setup if you have installed a new add-on and the system reconfiguration has caused such a serious conflict that the operating system can not boot. The settings are: Enabled and Disabled.

Resource Controlled By

The Award Plug and Play BIOS has the capacity to automatically configure all of the boot and Plug and Play compatible devices. However, this capability means absolutely nothing unless you are using a Plug and Play operating system such as Windows®95/98. If you set this field to “manual” choose specific resources by going into each of the sub menu that follows this field (a sub menu is preceded by a “➤”). The settings are: Auto(ESCD), Manual.

IRQ Resources

When resources are controlled manually, assign each system interrupt a type, depending on the type of device using the interrupt.

Memory Resources

This sub menu can let you control the memory resource.

PCI/VGA Palette Snoop

Leave this field at *Disabled*. The settings are Enabled, Disabled.

3.10 Frequency/Voltage Control

This section is for setting CPU Frequency/Voltage Control.

CMOS Setup Utility - Copyright(C) 1984-1999 Award Software
Frequency/Voltage Control

Auto Detect DIMM/PCI Clk	Enabled	Item Help
CPU Clock/Spread Spectrum	Default	Menu Level >
↑↓ →← Move Enter:Select +/-/PU/PD:Value F10:Save ESC:Exit F1:General Help F5:Previous Values F6:Fail-safe defaults F7:Optimized Defaults		

Auto Detect DIMM/PCI CLK

This item allows you to enable/disable auto detect DIMM/PCI Clock.
The settings are: Enabled, Disabled.

CPU Clock/Spread Spectrum

This item allows you to set the CPU Clock/Spread Spectrum.

3.11 Load Fail-Safe/Optimized Defaults

Load Fail-Safe Defaults

When you press <Enter> on this item, you get a confirmation dialog box with a message similar to:

Load Fail-Safe Defaults (Y/N) ? N

Pressing 'Y' loads the BIOS default values for the most stable, minimal-performance system operations.

Load Optimized Defaults

When you press <Enter> on this item, you get a confirmation dialog box with a message similar to:

Load Optimized Defaults (Y/N) ? N

Pressing 'Y' loads the default values that are factory settings for optimal performance system operations.

3.12 Set Supervisor/User Password

You can set either supervisor or user password, or both of them. The differences are:

Supervisor password : can enter and change the options of the setup menus.

User password : Can only enter but do not have the right to change the options of the setup menus. When you select this function, the following message will appear at the center of the screen to assist you in creating a password.

ENTER PASSWORD:

Type the password, up to eight characters in length, and press <Enter>. The password typed now will clear any previously entered password from CMOS memory. You will be asked to confirm the password. Type the password again and press <Enter>. You may also press <Esc> to abort the selection and not enter a password.

To disable a password, just press <Enter> when you are prompted to enter the password. A message will confirm the password will be disabled. Once the password is disabled, the system will boot and you can enter Setup freely.

PASSWORD DISABLED.

When a password has been enabled, you will be prompted to enter it every time you try to enter Setup. This prevents an unauthorized person from changing any part of your system configuration.

Additionally, when a password is enabled, you can also require the BIOS to request a password every time your system is rebooted. This would prevent unauthorized use of your computer.

You determine when the password is required within the BIOS Features Setup Menu and its Security option. If the Security option is set to “System”, the password will be required both at boot and at entry to Setup. If set to “Setup”, prompting only occurs when trying to enter Setup.