

Chapter 1

INTRODUCTION

The MICRO ATX BX7 mainboard is a high-performance personal computer mainboard based on the Intel® Pentium® II processor. This mainboard combines leading edge AGP ATI® 3D RAGE PRO/RAGE PRO Turbo technology in graphics and Creative® ES1371/ES1373(reserved) PCI technology in audio. The Intel® Pentium® II processor supports MMX™ (Multimedia Extension) technology.

The mainboard uses the highly integrated Intel® 82443BX AGP chipset to support the PCI/ISA and Green standards, and to provide the Host/AGP bridge. The Intel® 82371EB chipset integrates all system control functions such as ACPI (Advanced Configuration and Power Interface). The ACPI provides more Energy Saving Features for the OSPM(OS Direct Power Management) function. The Intel® 82371EB chipset also improves the IDE transfer rate by supporting Ultra DMA/33 IDE that transfers data at the rate of 33MB/s.

The mainboard also supports the System Hardware Monitor Controller as an optional function. Its functions include: CPU /power supply/chassis fan revolution detect, CPU/system voltage monitor, system temperature monitor, and chassis intrusion detect(optional).

1.1 Mainboard Features

CPU

- Slot 1 for Intel® Pentium® II/Celeron™ processor.
- Supports 233MHz, 266MHz, 300MHz, 333MHz, 350MHz, 400MHz, 450MHz, and faster.

Chipset

- Intel® 82443BX/PIIX4E chipset.

Clock Generator

- 66/68/75/83/100/112/133MHz clocks are supported.

Main Memory

- Supports four memory banks using two 168-pin unbuffered DIMM.
- Supports a maximum memory size of 256MB (8M x 8) or 512MB (16M x 4) registered DIMM only.
- Supports ECC(1-bit Error Code Correct) function.
- Supports 3.3v SDRAM DIMM.

Slots

- Three 32-bit Master PCI Bus slots and one 16-bit ISA bus slots.
- Supports 3.3v/5v PCI bus Interface.

On-Board IDE

- An IDE controller on the Intel® PIIX4E PCI Chipset provides IDE HDD/CD-ROM with PIO, Bus Master and Ultra DMA/33 operation modes.
- Can connect up to four IDE devices.

On-Board Peripherals

- On-Board Peripherals include:
 - 1 floppy port supports 2 FDD with 360K, 720K, 1.2M, 1.44M and 2.88Mbytes.
 - 1 serial port (COM A) + 1 serial connector (COM B)
 - 1 parallel port supports SPP/EPP/ECP mode
 - 2 USB ports
 - 1 IrDA connector for SIR.
-

VGA

- ATI® 3D RAGE PRO/RAGE PRO TURBO 2x
 - Running on AGP BUS.
 - Onboard 8MB SDRAM.
 - 3D Acceleration.
 - AGP 2x mode (133MHz) support pipelined and sideband protocols.

Sound

- Creative® ES1371/ES1373 (reserved)
 - Running on PCI BUS.
 - 64 Voice and AC3 Capable (ES1373 only)
 - Support Direct Sound and Direct Sound 3D
 - AC97' Compliant

I/O Chip

- Winbond® multi super I/O W83977F
 - 2M bps fast tape drive, IRQ sharing
 - Device Power Management
 - Real time clock (256 bytes RAM)
 - 8042-based keyboard controller (support PS/2 mouse)

BIOS

- The mainboard BIOS provides “Plug & Play” BIOS which detects the peripheral devices and expansion cards of the board automatically.
- The mainboard provides a Desktop Management Interface(DMI) function which records your mainboard specifications.
- ACPI(Advanced Configuration and Power Interface) feature.

Dimension

- MICRO ATX Form Factor : 24.4cm(L) x 19.2cm(W) x 4 layers PCB

Mounting

- 6 mounting holes.

System Hardware Monitor (optional)

- CPU/Power Supply/Chassis Fan Revolution Detect
- CPU Fan Control (the fan will automatically stop when the system enters suspend mode)
- System Voltage Detect
- CPU Overheat Warning.
- Display Actual Current Voltage

Other Features

- Keyboard Password Wake-Up (reserved)
- LAN Wake-Up
- Internal/External Modem Wake-Up

1.2 Mainboard Layout

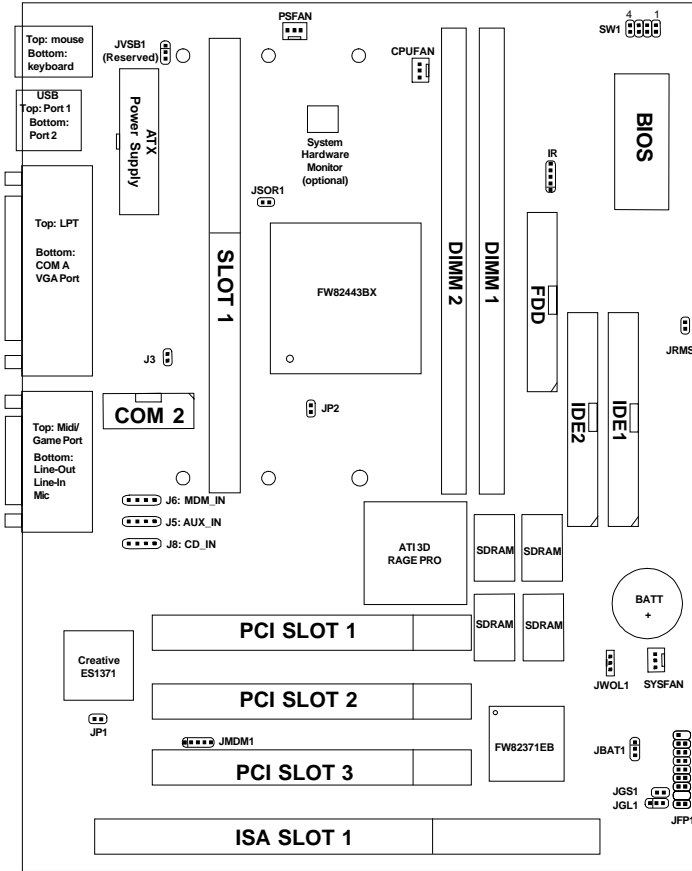

MS-6147 MICRO ATX BX7 Mainboard

Chapter 2

HARDWARE INSTALLATION

2.1 Central Processing Unit: CPU

The mainboard operates with **Intel® Pentium® II/Celeron™ processor**. The mainboard uses a CPU Slot called Slot 1 for easy CPU installation and a jumper switch (SW1) to set the proper speed for the CPU. The CPU should always have a Heat Sink and a cooling fan attached to prevent overheating.

2.1-1 CPU Installation Procedures

Different kinds of Pentium® II processor that is currently used: the OEM version, the Boxed version, and Celeron™. OEM Pentium® II Processor has no Heat Sink, Fan and Heat Sink Support, the Boxed Pentium® II Processor is provided with Heat Sink w/ fan and Heat Sink Support, while the Celeron™ processor is a plain processor card without cover or heatsink..

A. OEM Pentium® II Processor Installation Procedures

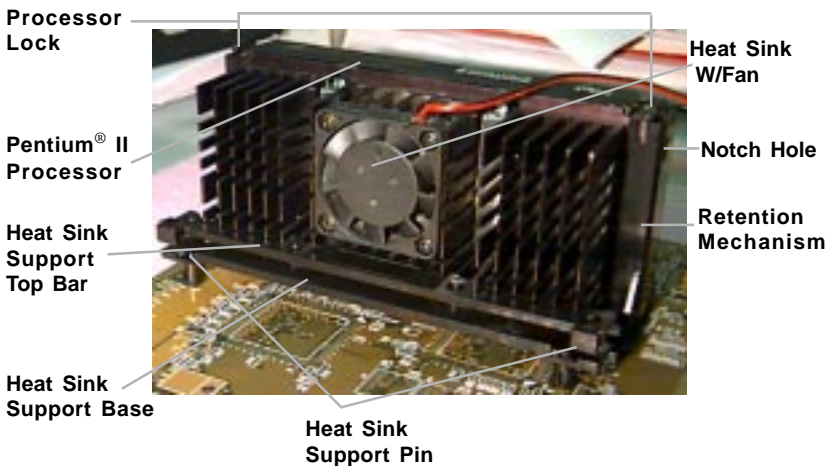

Required Things:

Pentium® II processor - Processor.

***Retention Mechanism(RM)** - Plastic Guide that holds the S.E.C. Cartridge in the Slot 1 connector.

***Retention Mechanism Attach Mount(RMAM)** - Bolt/Bridge assemblies inserted up through the bottom of the motherboard. RM secures to RMAM (2 RMAM required per RM).

***Heat Sink Support Base (HSSBASE)** - Plastic support bar mounted to the mainboard under the ATX heatsink. (One leg is always bigger than the other one)

***Heat Sink Support Pin (HSSPIN)** - Plastic pins inserted through the HSSBASE to secure it to the mainboard (2 required per Assembly).

***Heat Sink Support Top Bar (HSSTOP)** - Plastic bar that clips onto the HSSBASE through the fins on the ATX heatsink.

****Heat Sink w/ fan** - Heat Sink that can be attached to the **Pentium® II processor** with metal clip.

Note: * Provided by MSI mainboard.

** Provided by Special request.

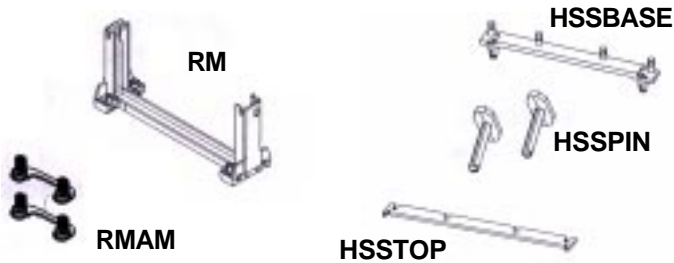

Step 1: Insert the Retention Mechanism Attach Mount at the bottom of the mainboard.

Step 2: Install the Retention Mechanism.

Look for the key on Slot 1, and match it with the Notch Key on the Retention Mechanism for proper direction. Then, attach the Retention Mechanism to the Retention Mechanism Attach Mount. Use a Screwdriver to secure the Retention Mechanism.

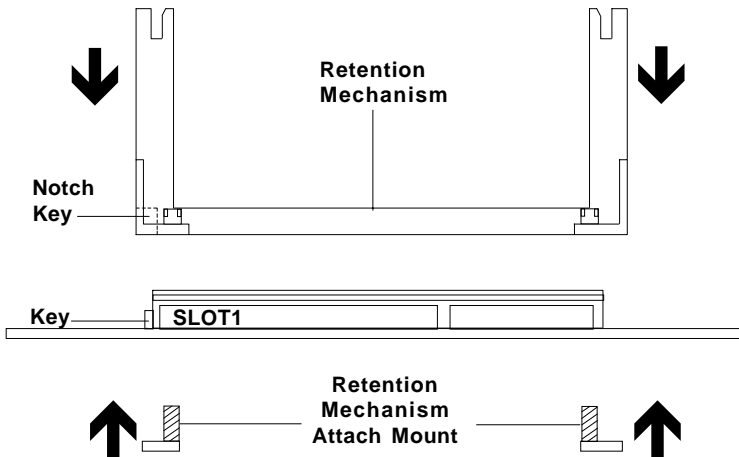

Step 3: Install the Heat Sink Support Base.

Look for the Two holes across Slot 1, and match it with the Two legs of the Heat Sink Support Base for the proper direction. Take note that one hole/leg is bigger than the other. The Four top pins of the Heat Sink Support Base should also be oriented towards Slot 1.

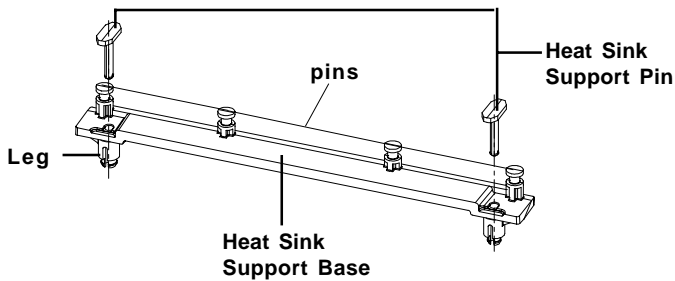

Push the Heat Sink Support Base onto the mainboard, until you hear a click sound. Check for a perfect fit.

Step 4: Install the Heat Sink Support Pin.

Push the Heat Sink Support Pins onto the two holes of the Heat Sink Support Base. Check for a perfect fit. These pins are used to secure the Heat Sink Support Base.

Step 5: Install the Heat Sink with Fan to the Processor.

Push down the metal clips, so that they are in line with the back of the Heat Sink. Be careful, so as not to detach the metal clips from the Heat Sink.

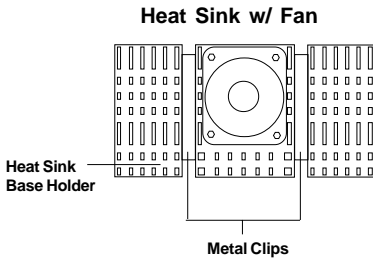

↓ The arrow should be pointing down.

In case the metal clips are detached from the Heat Sink, re-attach them. Look for the arrow on the metal clip. This arrow should be pointing down and aligned with the Heat Sink Support Base Holder.

Attach the Heat Sink to the processor.

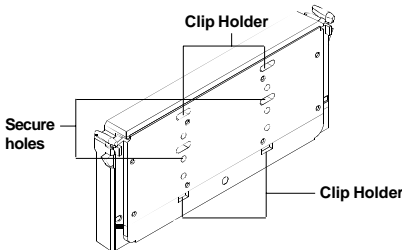

Pentium® II Processor (Back)

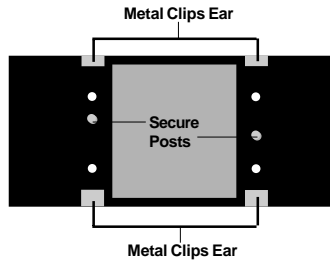

Heat Sink w/ Fan(Back)

- Look at the back of the Heat Sink and take note of the 2 secure posts. Insert these 2 Secure posts to the 2 secure holes on the back of the processor.
- Align the ears of the metal clips with the clip holders on the back of the processor. Use a screw driver to push the metal clips onto the clip holders. Check for a perfect fit.

Step 6: Install the Processor.

Unlock the Processor by pushing in the Processor Locks.



Insert the Processor like inserting a PCI or an ISA card.

Step 7: Lock the Processor Locks.

Secure the CPU by pulling the Processor Locks out.



Step 8: Install the Heat Sink Support Top Bar.

Push the Heat Sink Support Top Bar to the Heat Sink Support Base, Until you hear a “click” sound. Check for a perfect fit.



**Heatsink
Support Top
Bar**

The installation is now complete.

B. Boxed Pentium® II Processor Installation Procedures

The Boxed Pentium® II Processor has a built-in Fan and Heat Sink. It also has a Heat Sink Support. So if you're going to use a Boxed Pentium™ II Processor, all you need is the Retention Mechanism.

Step 1: Insert the Retention Mechanism Attach Mount at the bottom of the mainboard.

Step 2: Install the Retention Mechanism.

Look for the key on Slot 1, and match it with the Notch Key on the Retention Mechanism for proper direction. Then, attach the Retention Mechanism to the Retention Mechanism Attach Mount. Use a Screwdriver to secure the Retention Mechanism.

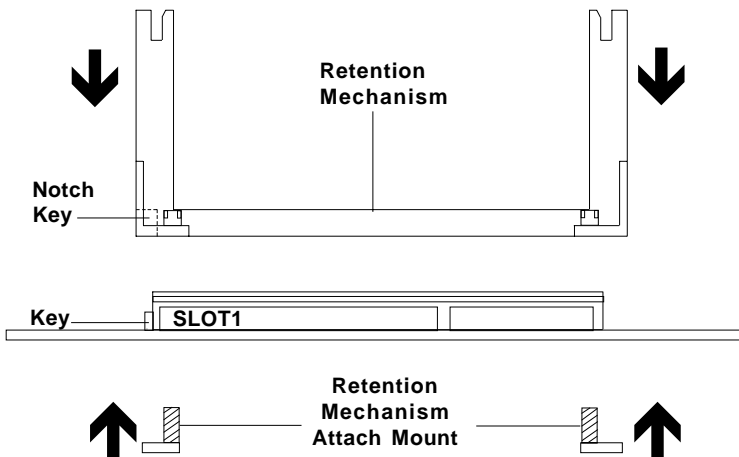

Step 3: Install the Heat Sink Support Base.

Look for the 2 holes across Slot 1, and match it with the 2 Heat Sink Support Base. Take note that one hole/base is bigger than the other.

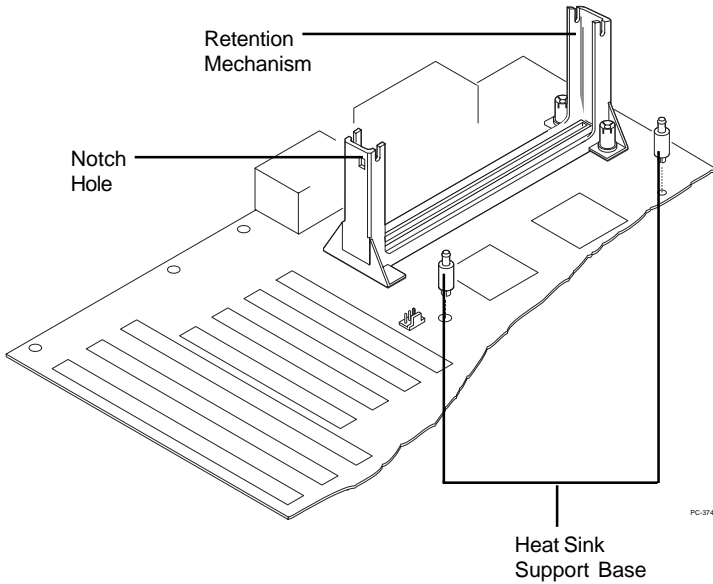

Push the Heat Sink Support Base onto the mainboard, until you hear a click sound. Check for a perfect fit.

Step 4: Install the Heat Sink Support.

Attach the 2 Heat Sink Supports to the sides of the Processor. These Heat Sink Supports will fit in any direction, so be sure that the Heat Sink Support Locks are oriented outwards for the proper direction.

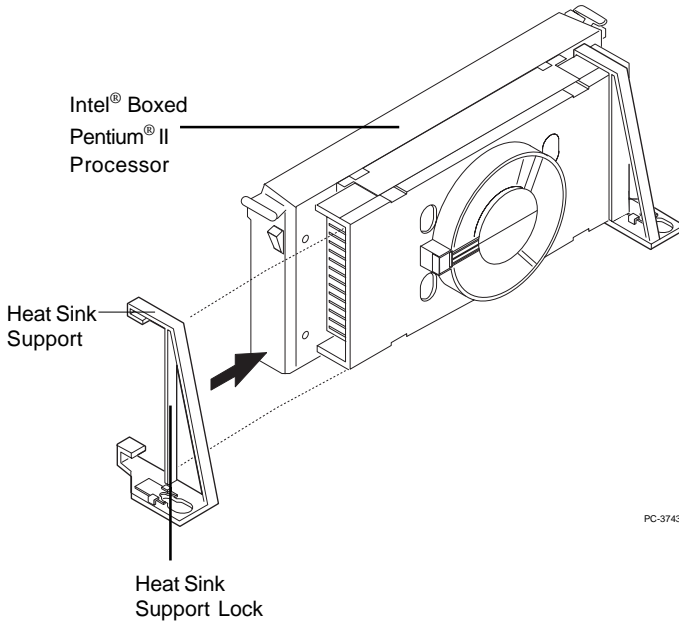

Step 5: Unlock the Processor Locks and Heat Sink Support Locks.

Push in the Processor Locks. Open the Heat Sink Support Locks.

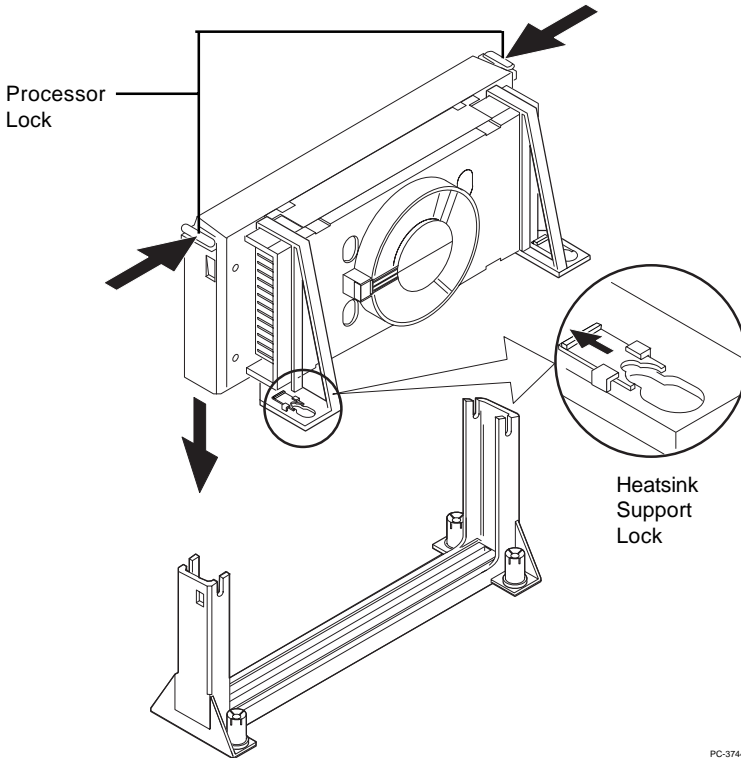

Step 6: Insert the Processor like inserting a PCI or an ISA card.

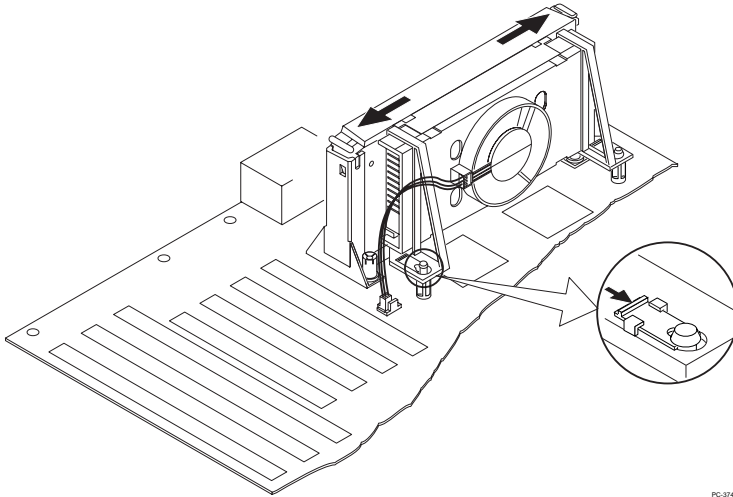

PC-3746

Step 7: Lock the Processor Locks and Heat Sink Support Locks

Secure the CPU by pushing out the Processor Locks. Close the Heat Sink Support Locks.

The installation is now complete.

C. OEM Celeron™ Processor Installation Procedures

Step 1: Insert the Retention Mechanism Attach Mount at the bottom of the mainboard.

Step 2: Install the Retention Mechanism.

Look for the key on Slot 1, and match it with the Notch Key on the Retention Mechanism for proper direction. Then, attach the Retention Mechanism to the Retention Mechanism Attach Mount. Use a Screwdriver to secure the Retention Mechanism.

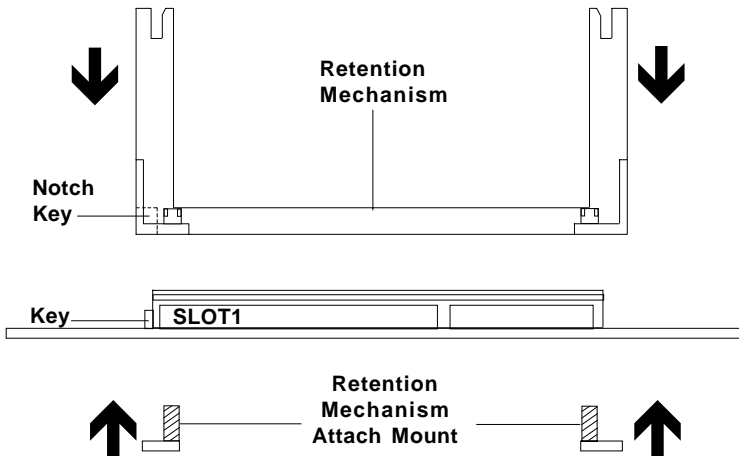

Step 3: Install the MSI Heat Sink (optional) to the Processor.

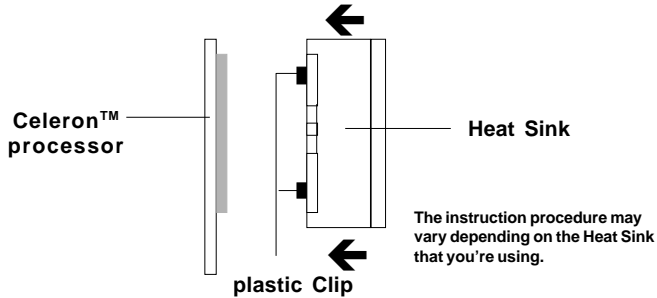

Push down the plastic clips, so that they are in line with the hole on the processor. Check for perfect fit.

Step 4: Install the Processor.

Insert the Processor like inserting a PCI or an ISA card.

Step 5: Lock the Processor

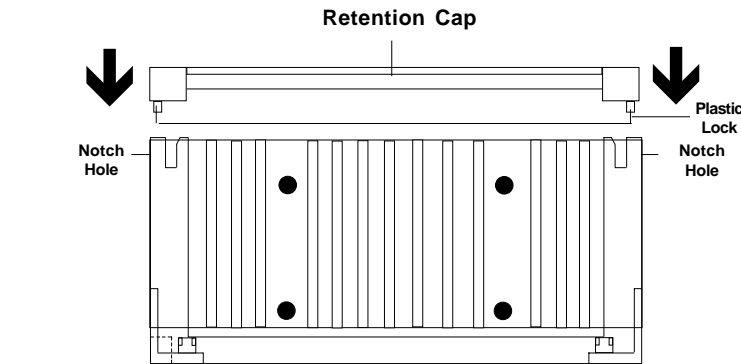

Lock the processor by putting the Retention Cap provided. Take note of the two plastic lock at the side of the Retention Cap. This two plastic lock should be aligned properly into the Retention Mechanism notch hole.

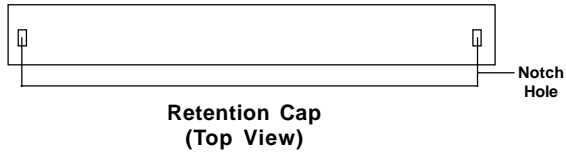
Procedure for detaching the Retention Cap:

To remove the Retention Cap, you need a Screw Driver (0.3 cm) tip.

- Insert the screw driver into the retention cap notch hole.
- Push the retention cap plastic lock inward.
- Pull the retention cap upward.

2.1-2 CPU Core Speed Derivation Procedure

1. The DIP Switch SW1 (1, 2, 3, and 4) is used to set the Core/Bus (Fraction) ratio of the CPU. The actual core speed of the CPU is the Host Clock Frequency multiplied by the Core/Bus ratio. For example:

$$\begin{aligned}
 \text{If } & \text{CPU Clock} & = & 66\text{MHz}/100\text{MHz} \\
 & \text{Core/Bus ratio} & = & 4 \\
 \text{then } & \text{CPU core speed} & = & \text{Host Clock} \times \text{Core/Bus ratio} \\
 & & = & 66\text{MHz} \times 4/100\text{MHz} \times 4 \\
 & & = & 266\text{MHz}/400\text{MHz}
 \end{aligned}$$

SW1				CPU
1	2	3	4	Core/Bus Ratio
ON	OFF	ON	ON	2.5
ON	ON	OFF	ON	3
ON	OFF	OFF	ON	3.5
ON	ON	ON	OFF	4
ON	OFF	ON	OFF	4.5
ON	ON	OFF	OFF	5
ON	OFF	OFF	OFF	5.5
OFF	ON	ON	ON	6
OFF	OFF	ON	ON	6.5
OFF	ON	OFF	ON	7
OFF	OFF	OFF	ON	7.5
OFF	ON	ON	OFF	8

ON - Short OFF - Open

Note: The CPU Bus Frequency is set at 66MHz or 100MHz by CPU default.

2.1-3 CPU Speed Setting: SW1

To adjust the speed of the CPU, you must know the specification of your CPU (*always ask the vendor for CPU specification*). The mainboard can auto-detect between 66 or 100MHz CPU Bus Frequency.

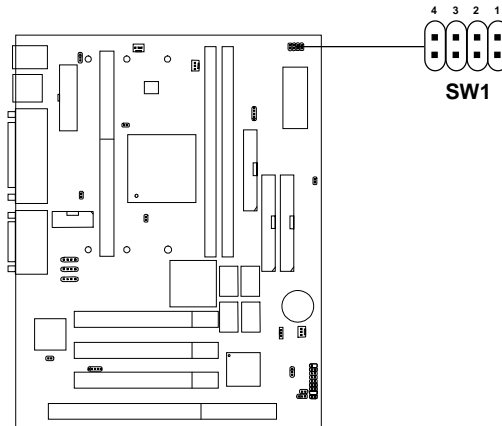

a. 66MHz CPU Bus Frequency





CPU Type	SW1
233MHz	
266MHz	
300MHz	
333MHz	

Table 2.1 233 ~ 333MHz Intel® Pentium® II/Celeron™ processor

b. 100MHz CPU Bus Frequency



CPU Type	SW1
350MHz	
400MHz	
450MHz	

Table 2.2 350 ~ 450MHz Intel® Pentium® II processor

2.1-4 Fan Power Connectors: CPUFAN/PSEFAN/SYSFAN

These connectors support system cooling fan with +12V. It supports three pin head connector. When connecting the wire to the connector, always take note that the red wire is the positive and should be connected to the +12V, the black wire is Ground and should be connected to GND. If your mainboard has System Hardware Monitor chipset on-board, you must use a specially designed fan with speed sensor to take advantage of this function.

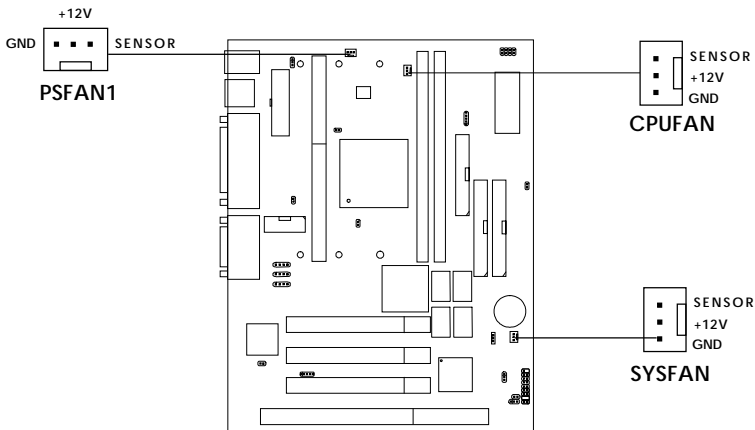

PSFAN : Power Supply Fan
CPUFAN : Processor Fan
SYSFAN : System(Chassis) Fan

For fans with fan speed sensor, every rotation of the fan will send out 2 pulses. System Hardware Monitor will count and report the fan rotation speed.

Note: 1. Always consult vendor for proper CPU cooling fan.

2.2 Clear CMOS Jumper: JBAT1

A battery must be used to retain the mainboard configuration in CMOS RAM. Short 1-2 pins of JBAT1 to store the CMOS data.

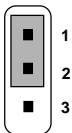
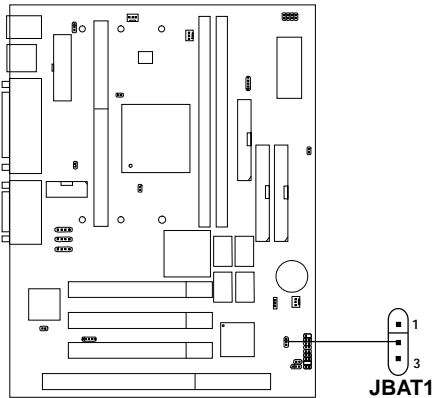

Keep Data

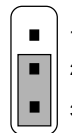

Clear Data

Note: You can clear CMOS by shorting 2-3 pin, while the system is off. Then, return to 1-2 pin position. Avoid clearing the CMOS while the system is on, it will damage the mainboard. Always unplug the power cord from the wall socket.

2.3 Memory Installation

2.3-1 Memory Bank Configuration

The mainboard supports a maximum memory size of 256MB (8M x 8) or 512MB (16M x 4) registered DIMM for SDRAM: It provides two 168-pin **unbuffered** DIMMs (Double In-Line Memory Module) sockets. It supports 8 MB to 256 Mbytes DIMM memory module.

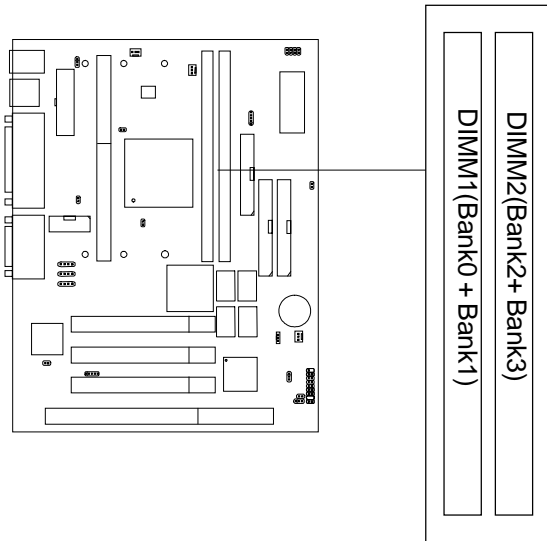

There are two kinds of DIMM specification supported by this mainboard: PC100 and PC66. If you use 66MHz CPU Bus Frequency, these two DIMM Specs. is supported. If you use 100 MHz CPU Bus Frequency, only PC100 DIMM Specs. is supported.

2.3-2 Memory Installation Procedures

A. How to install a DIMM Module

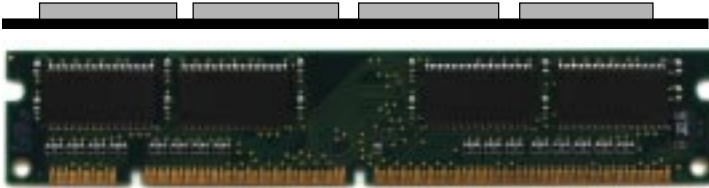

Single Sided DIMM

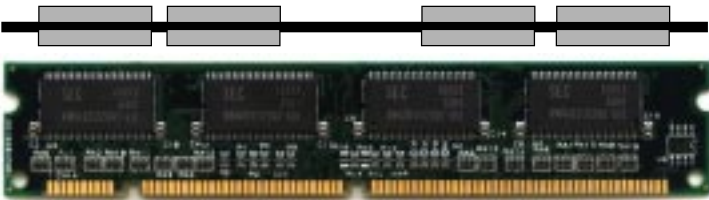

Double Sided DIMM

1. The DIMM slot has a two Notch Key “VOLT and DRAM”, so the DIMM memory module can only fit in one direction.
2. Insert the DIMM memory module vertically into the DIMM slot. Then push it in.

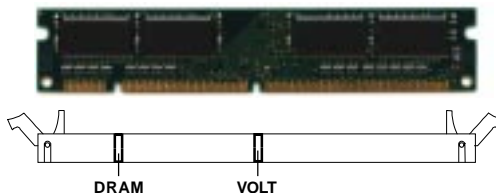

3. The plastic clip at the side of the DIMM slot will automatically close..

2.3-3 Memory Population Rules

1. Supports only SDRAM DIMM.
2. To operate properly, at least one 168-pin DIMM module must be installed.
3. This mainboard supports Table Free memory, so memory can be installed on DIMM1 or DIMM 2 in any order.
4. Supports 3.3 volt DIMM.
5. The DRAM addressing and the size supported by the mainboard is shown below:

Table 2.3-1 SDRAM Memory Addressing

DRAM Tech.	DRAM Density & Width	DRAM Addressing	Address Size		MB/DIMM	
			Row	Column	Single no. Side(S) pcs.	Double no. Side(D) pcs.
16M	1Mx16	ASYM	11	8	8MBx4	16MBx8
	2Mx8	ASYM	11	9	16MBx8	32MBx16
	4Mx4	ASYM	11	10	32MB	64MB
64M	2Mx32	ASYM	11	9	32MBx2	64MBx4
	2Mx32	ASYM	12	8	16MBx2	32MBx4
	4Mx16	ASYM	11	10	32MB	64MB
	4Mx16	ASYM	13	8	32MB	64MB
	8Mx8	ASYM	13	9	64MB	128MB
	16Mx4	ASYM	13	10	128MB	256MB
	2Mx32	ASYM	12	8	16MB	32MB
64M	4Mx16	ASYM	13	8	32MB	64MB
	8Mx8	ASYM	13	9	64MB	128MB
	16Mx4	ASYM	13	10	128MB	256MB

2.4 Case Connector: JFP1

The Power Switch, Reset Switch, Power LED, Speaker, Keylock and HDD LED are all connected to the JFP1 connector block.

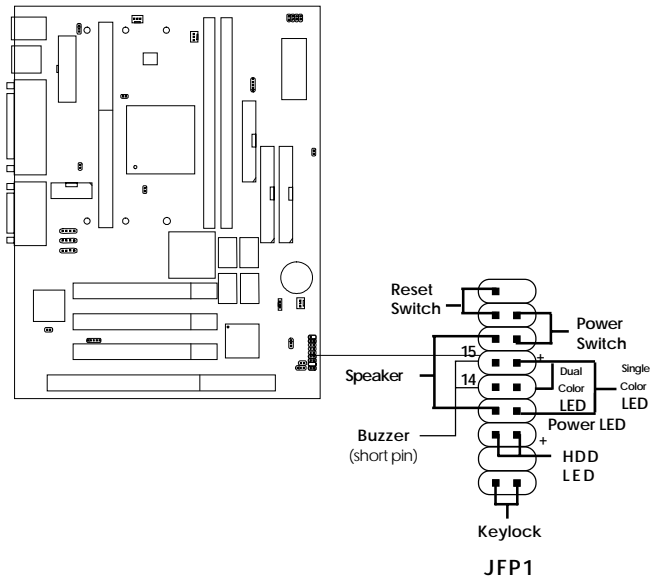

2.4-1 Power Switch

Connect to a 2-pin push button switch. This switch had the same feature with JRMS1.

2.4-2 Reset Switch

Reset switch is used to reboot the system rather than turning the power ON/OFF. Avoid rebooting while the HDD LED is lit. You can connect the Reset switch from the system case to this pin.

2.4-3 Power LED

The Power LED is lit while the system power is on. Connect the Power LED from the system case to this pin. There are two types of LED that you can use: 3-pin single color LED or 2-pin dual color LED(ACPI request).

- a. 3 pin single color LED connect to pin 4, 5, & 6. This LED will lit when the system is on.
- b. 2 pin dual color LED connect to pin 5 & 6.

GREEN Color: Indicate the system is full on mode.

ORANGE Color: Indicate the system is in suspend mode.

2.4-4 Speaker

Speaker from the system case is connected to this pin.

If on-board Buzzer is available:

Short pin 14-15: On-board Buzzer Enabled.

Open pin 14-15: On-board Buzzer Disabled.

2.4-5 HDD LED

HDD LED shows the activity of a hard disk drive. Avoid turning the power off while the HDD led is lit. You can connect the HDD LED from the system case to this pin.

2.4-6 Keylock

Keylock allows you to disable the keyboard for security purposes. You can connect the keylock to this pin.

2.5 Floppy Disk Connector: FDD

The mainboard also provides a standard floppy disk connector FDC that supports 360K, 720K, 1.2M, 1.44M and 2.88M floppy disk types. This connector supports the provided floppy drive ribbon cables.

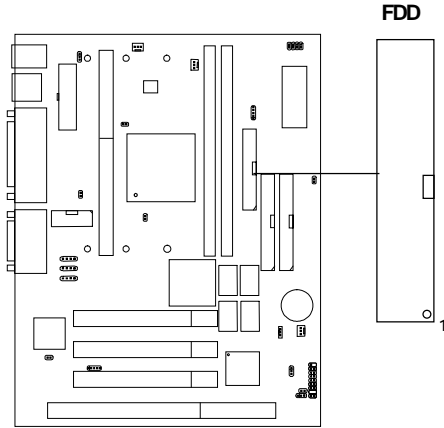

2.6 Hard Disk Connectors: IDE1 & IDE2

The mainboard has a 32-bit Enhanced PCI IDE Controller that provides PIO mode 0~4, Bus Master, and Ultra DMA/33 function. It has two HDD connectors IDE1 (primary) and IDE2 (secondary). You can connect up to four hard disk drives, CD-ROM, 120MB Floppy (reserved for future BIOS) and other devices to IDE1 and IDE2. These connectors support the provided IDE hard disk cable.

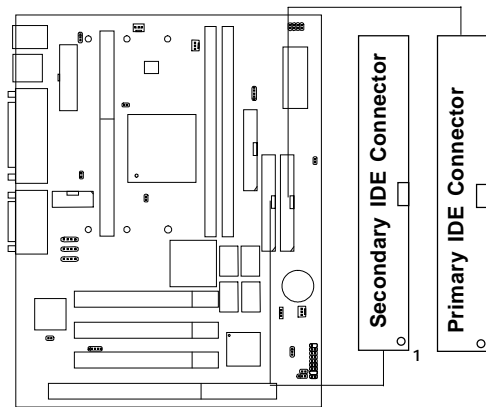

IDE1(Primary IDE Connector)

The first hard drive should always be connected to IDE1. IDE1 can connect a Master and a Slave drive. You must configure second hard drive to Slave mode by setting the jumper accordingly.

IDE2(Secondary IDE Connector)

IDE2 can also connect a Master and a Slave drive.

2.7 Power Supply

2.7-1 ATX 20-pin Power Connector: JPWR1

This connector supports the power button on-board. Using the ATX power supply, functions such as Modem Ring Wake-Up and Soft Power Off are supported by this mainboard. This power connector supports instant power on function which means that system will boot up instantly when the power connector is inserted on the board.

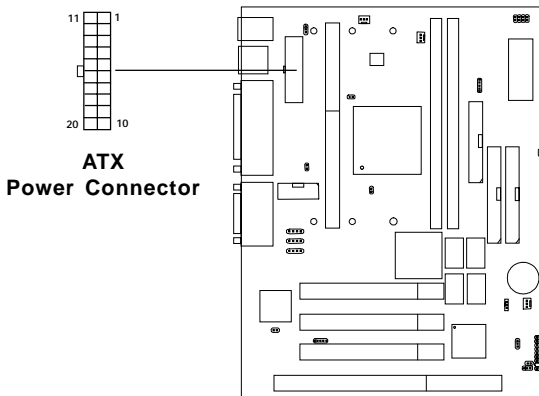

PIN DEFINITION

PIN	SIGNAL	PIN	SIGNAL
1	3.3V	11	3.3V
2	3.3V	12	-12V
3	GND	13	GND
4	5V	14	PS_ON
5	GND	15	GND
6	5V	16	GND
7	GND	17	GND
8	PW_OK	18	-5V
9	5V_SB	19	5V
10	12V	20	5V

Warning: Since the mainboard has the instant power on function, make sure that all components are installed properly before inserting the power connector to ensure that no damage will be done.

2.7-2 Remote Power On/Off Switch: JRMS1

Connect to a 2-pin push button switch. During OFF state, press once and the system turns on. **During ON stage, push once and the system goes to sleep mode: pushing it more than 4 seconds will change its status from ON to OFF.** If you want to change the setup, you could go to the BIOS Power Management Setup. This is only used for ATX type power supply.

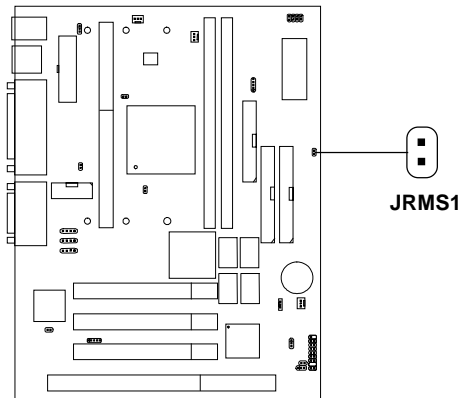

2.8 IrDA Infrared Module Connector: IR

The mainboard provides one 5-pin infrared (IR) connector for IR modules. This connector is for optional wireless transmitting and receiving infrared module. You must configure the setting through the BIOS setup to use the IR function. FIR and Consumer IR are reserved functions.

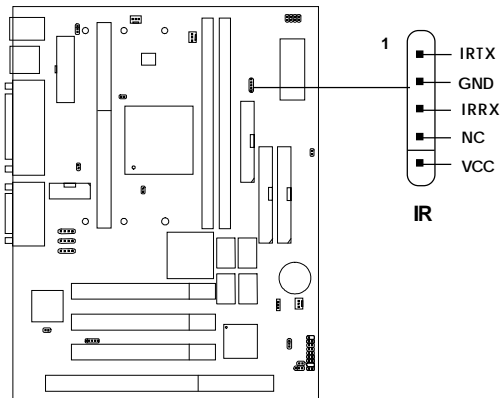

2.9 Serial Port Connectors: COM 1 and COM 2

The mainboard has a 9-pin male DIN connector for serial port COM 1. This port is a 16550A high speed communication port that send/receive 16 bytes FIFOs. You can attach a mouse or a modem cable directly into this connector.

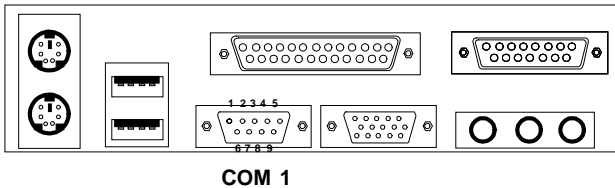

Serial Port (9-pin Male)

PIN DEFINITION

PIN	SIGNAL
1	DCD (Data Carry Detect)
2	SIN (Serial In or Receive Data)
3	SOUT (Serial Out or Transmit Data)
4	DTR (Data Terminal Ready)
5	GND
6	DSR (Data Set Ready)
7	RTS (Request To Send)
8	CTS (Clear To Send)
9	RI (Ring Indicate)

Note: There’s another serial port connector (COM 2), which is located on the mainboard. Connect a serial port 9-pin male port into this connector.

2.10 Parallel Port Connector: LPT

The mainboard provides a 25 pin female centronic connector for LPT. A parallel port is a standard printer port that also supports Enhanced Parallel Port(EPP) and Extended capabilities Parallel Port(ECP). See connector and pin definition below:

Parallel Port (25-pin Female)

LPT

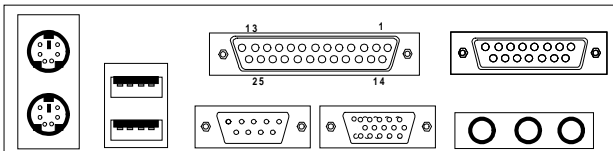

PIN DEFINITION

PIN	SIGNAL	PIN	SIGNAL
1	STROBE	14	AUTO FEED#
2	DATA0	15	ERR#
3	DATA1	16	INIT#
4	DATA2	17	SLIN#
5	DATA3	18	GND
6	DATA4	19	GND
7	DATA5	20	GND
8	DATA6	21	GND
9	DATA7	22	GND
10	ACK#	23	GND
11	BUSY	24	GND
12	PE	25	GND
13	SELECT		

2.11 Mouse Connector: JKBS1

The mainboard provides a standard PS/2[®] mouse mini DIN connector for attaching a PS/2[®] mouse. You can plug a PS/2[®] mouse directly into this connector. The connector location and pin definition are shown below:

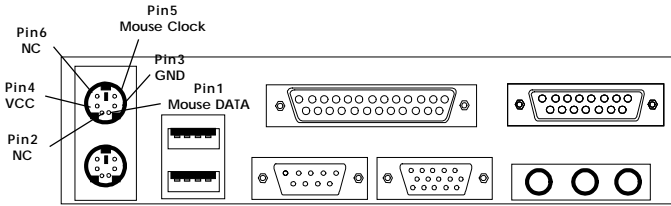

PS/2 Mouse (6-pin Female)

2.12 Keyboard Connector: JKBS1

The mainboard provides a standard PS/2[®] keyboard mini DIN connector for attaching a keyboard. You can plug a keyboard cable directly to this connector.

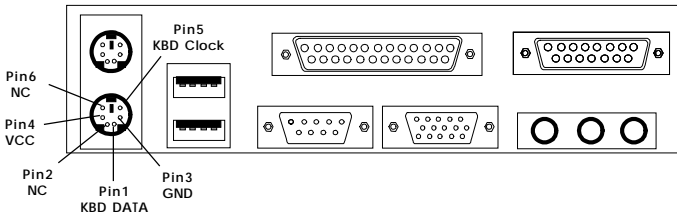

PS/2 Keyboard (6-pin Female)

2.13 Joystick/Midi Connectors

You can connect joystick or game pads to this connector.

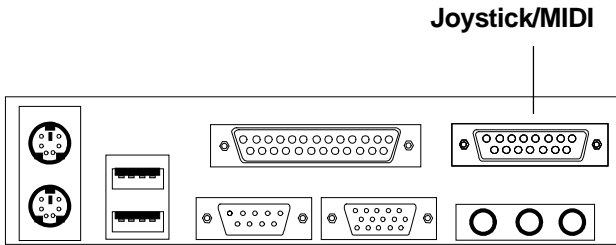

2.14 Audio Port Connectors

Line Out is a connector for Speakers or Headphones. **Line In** is used for external CD player, Tape layer, or other audio devices. **Mic** is a connector for the microphones.

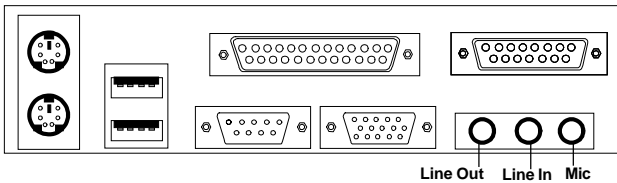

1/8" Stereo Audio Connectors

2.15 USB Connectors

The mainboard provides a **UHCI(Universal Host Controller Interface) Universal Serial Bus root** for attaching USB devices like: keyboard, mouse and other USB devices. You can plug the USB device directly to this connector.

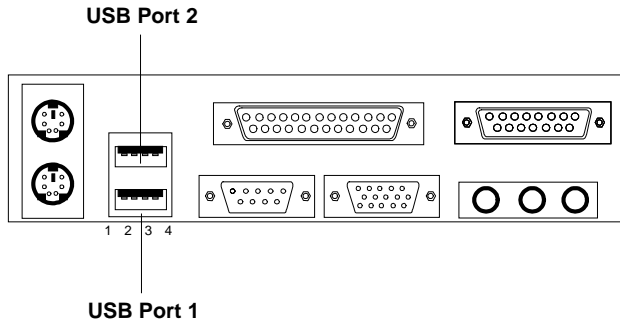

PIN	SIGNAL
1	VCC
2	-Data0
3	GND
4	+Data0

2.16 VGA DB 15 Pin Connector

The mainboard provides a DB 15-pin connector to connect to a VGA monitor.

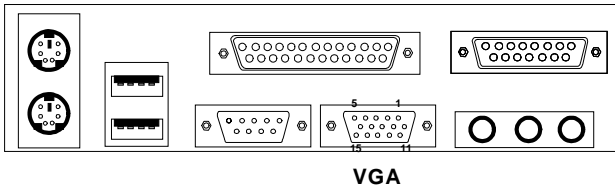



Analog Video Display Connector(DB15-S)	
Pin	Signal Description
1	Red
2	Green
3	Blue
4	Not used
5	Ground
6	Ground
7	Ground
8	Ground
9	Not used
10	Ground
11	Not used
12	SDA
13	Horizontal Sync
14	Vertical Sync
15	SCL

2.17 Onboard VGA Disable/Enable Jumper: JP2

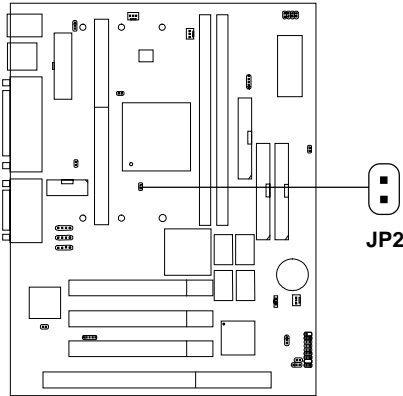
This jumper is used to Enable/Disable the onboard VGA feature.



JVGA1	Function
	Enable Onboard VGA
	Disable Onboard VGA

2.18 Power Saving Switch Connector: JGS1

Attach a power saving switch to **JGS1**. When the switch is pressed, the system immediately goes into suspend mode. Press any key and the system wakes up.

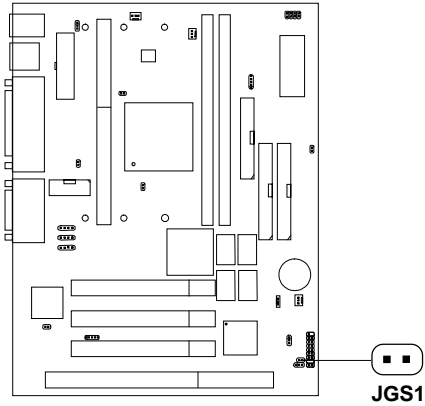

2.19 Power Saving LED Connector: JGL1

JGL1 can be connected with two-color LED. There are two type of LED that you can use: 3-pin LED or 2-pin LED(ACPI request). LED will lit while the system is in suspend mode.

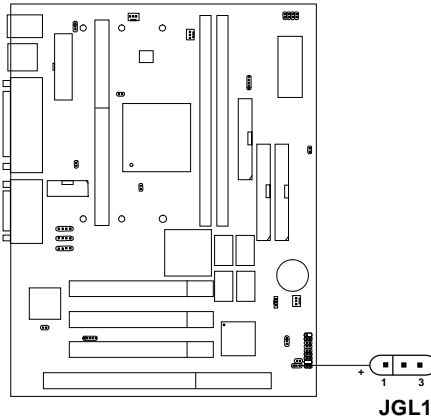

3-pin LED	2-pin LED
<p>1-2 Single Color 1-3 Blink</p>	<p>1-2 Dual Color</p>

2.20 Power On Mode Jumper: JP1

The mainboard supports three kinds of system boot up: the Boot-Up by switch, Immediate Boot-Up, and Last State. With the **Boot-Up by Switch**, the system will boot up only when the power on switch is pressed. For **Immediate Boot-Up**, the system will boot up instantly when the power connector is connected into the system; this function must be set in the BIOS Power Management. For **Last State**, this will record the last status the system was in: either System on or Shut down. The next time you boot up, the system will remember the last status. This function must be set at the BIOS Power Management Setup.

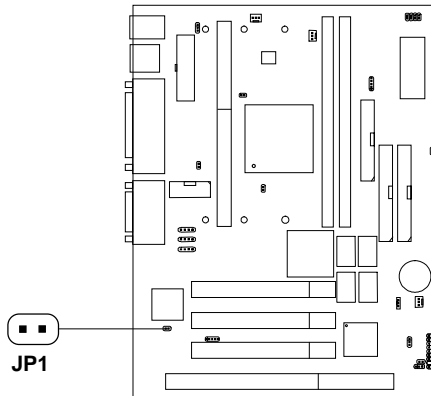



Table 2.20: Power On Mode Feature

JP1	Feature
	Select Boot-Up by Switch
	Select Immediate Boot-Up/ Select Last State

Note: Short **JP1**, when using Boot-Up by Switch feature. Open **JP1**, to enable Immediate Boot-Up or Last State.

2.21 Wake-Up on LAN Connector: JWOL

The JWOL connector is for use with LAN add-on cards that supports Wake Up on LAN function. To use this function you need to set the “Resume By Ring” to enable at the BIOS Power Management Setup.

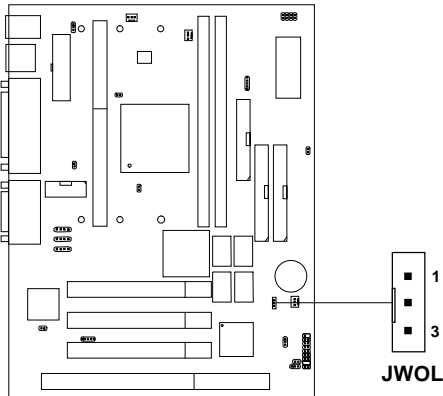

PIN	SIGNAL
1	5VSB
2	GND
3	MP_WAKEUP

Note: LAN wake-up signal is active “high”.

Note: To be able to use this function, you need a power supply that provide enough power for this feature.
(750 ma power supply with 5V Stand-by)

2.22 Modem Wake Up Connector: JMDM1

The JMDM1 connector is for used with Modem add-on card that supports the Modem Wake Up function. To use this function, you need to set the “Resume By Ring” to enable at the BIOS Power Management Setup.

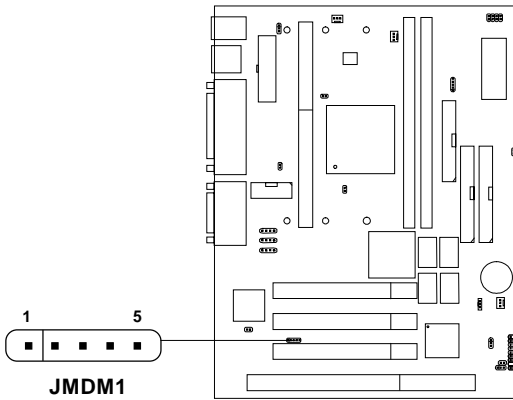

PIN	SIGNAL
1	NC
2	GND
3	MDM_WAKEUP
4	NC
5	5VSB

Note: Modem wake-up signal is active “low”.

Note: To be able to use this function, you need a power supply that provide enough power for this feature.
(750 ma power supply with 5V Stand-by)

2.23 Modem-In: J6

The connector is for Modem with internal voice connector.

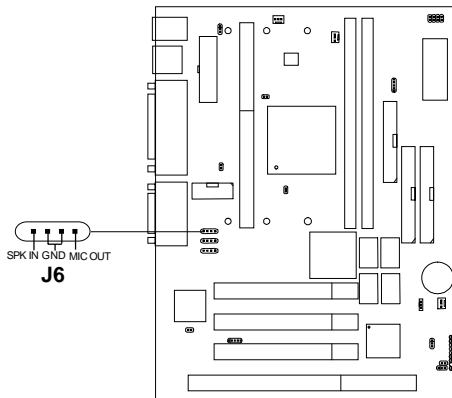

SPK_IN is connected to the Modem Speaker Out connector.

MIC_OUT is connected to the Modem Microphone In connector.

2.24 AUX Line In Connector: J5

This connector is used for DVD Add on Card with Line In connector.

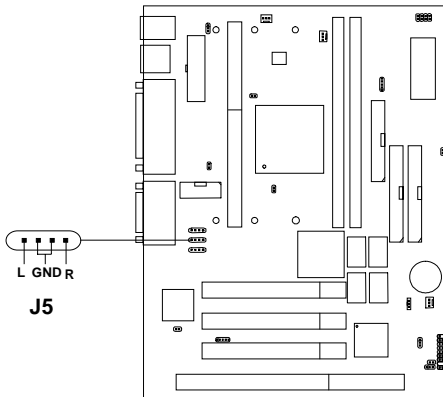

2.25 CD-In Modem Connector: J8

This connector is for Modem with internal voice connector.

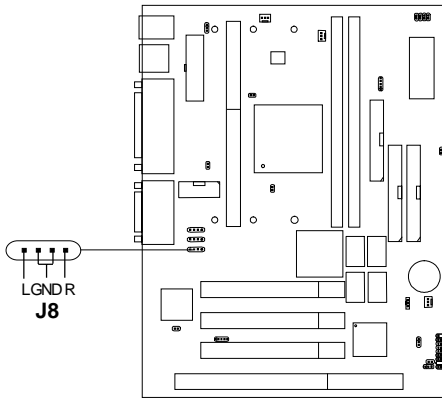

2.23 CPU Temperature Sensor: JSOR1 (optional)

This is used to check the CPU temperature. The J1 is a sensor that is placed near the processor heatsink. This will monitor the CPU temperature.

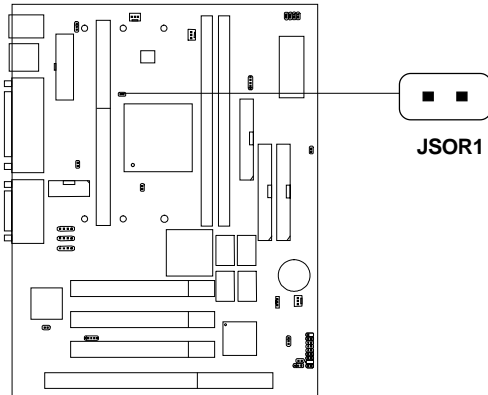

2.24 Chassis Intrusion Switch Connector: J3

This connector is connected to 2-pin connector chassis switch. If the Chassis is open, the switch will be short. The system will record this status. To clear the warning, you must enter the BIOS setting and clear the status.

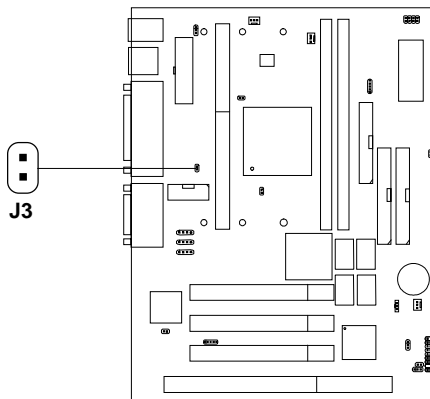

2.25 Keyboard Power: JVSBI (reserved)

The JVSBI jumper is for setting keyboard power. This function is provided by keyboard and PS/2 mouse Wake-up function.

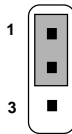
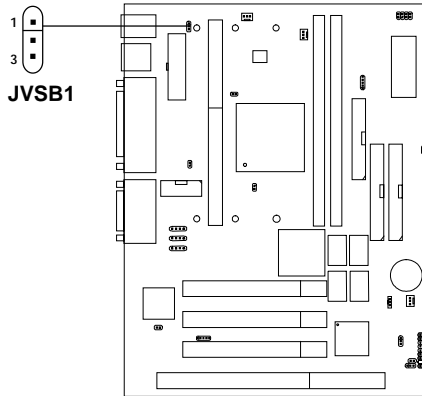

5V Standby
Enable keyboard
power on function

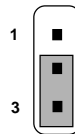

5V (default)
Disable keyboard
power on function

Note: To be able to use this function, you need a power supply that provide enough power for this feature.
(750 ma power supply with 5V Stand-by)

Chapter 3

AWARD® BIOS SETUP

Award® BIOS ROM has a built-in Setup program that allows users to modify the basic system configuration. This type of information is stored in battery-backed RAM (CMOS RAM), so that it retains the Setup information when the power is turned off.

3.1 Entering Setup

Power on the computer and press immediately to allow you to enter Setup. The other way to enter Setup is to power on the computer. When the below message appears briefly at the bottom of the screen during the POST (Power On Self Test), press key or simultaneously press <Ctrl>, <Alt>, and <Esc> keys.

TO ENTER SETUP BEFORE BOOT PRESS <CTRL-ALT-ESC>
OR KEY

If the message disappears before you respond and you still wish to enter Setup, restart the system to try again by turning it OFF then ON or pressing the “RESET” button on the system case. You may also restart by simultaneously pressing <Ctrl>, <Alt>, and <Delete> keys. If you do not press the keys at the correct time and the system does not boot, an error message will be displayed and you will again be asked to,

PRESS <F1> TO CONTINUE, <CTRL-ALT-ESC>
OR TO ENTER SETUP

3.2 Getting Help

Main Menu

The on-line description of the highlighted setup function is displayed at the bottom of the screen.

Status Page Setup Menu/Option Page Setup Menu

Press F1 to pop up a small help window that describes the appropriate keys to use and the possible selections for the highlighted item. To exit the Help Window press <F1> or <Esc>.

Chipset Features Setup

This setup page includes all the items of chipset special features.

Power Management Setup

This category determines the power consumption for system after setting the specified items. Default value is Disable.

PNP/PCI Configuration Setup

This category specifies the IRQ level for PCI and ISA devices.

Supervisor Password/User Password

Change, set or disable password. This function allows the user access to the system and setup or just setup.

Load Setup Defaults

Chipset defaults indicates the values required by the system for the maximum performance.

Special Features Setup

This function is reserved for Special Hardware Monitor.

IDE HDD Auto Detection

Automatically configure hard disk parameters.

Save & Exit Setup

Save CMOS value changes to CMOS and exit setup.

Exit Without Saving

Abandon all CMOS value changes and exit setup.

3.4 Standard CMOS Setup

The items in Standard CMOS Setup Menu are divided into 10 categories. Each category includes no, one or more than one setup items. Use the arrow keys to highlight the item and then use the <PgUp> or <PgDn> keys to select the value you want in each item.

ROM PCI/ISA BIOS (2A59IM4A)
STANDARD CMOS SETUP
AWARD SOFTWARE, INC.

Date(mm:dd:yy): Fri, Feb 28,1997							
Time(hh:mm:ss): 00:00:00							
HARD DISKS	TYPE	SIZE	CYLS	HEADS	PRECOMP	LANDZONE	SECTOR MODE
Primary Master:	Auto	0	0	0	0	0	AUTO
Primary Slave :	Auto	0	0	0	0	0	AUTO
Secondary Master :	Auto	0	0	0	0	0	AUTO
Secondary Slave :	Auto	0	0	0	0	0	AUTO
Drive A :	1.44M,3.5in.			Base Memory: 640K			
Drive B :	None			Extended Base Memory:15360K			
Video :	EGA/VGA			Other Memory: 384K			
Halt On :	All, but Keyboard			Total Memory: 16384K			
ESC : Quit ↑↓→← : Select Item PU/PD/+/- : Modify F1 : Help (Shift)F2 : Change Color							

Date

The date format is <day><month> <date> <year>.

Day	Day of the week, from Sun to Sat, determined by BIOS. Read-only.
month	The month from Jan. through Dec.
date	The date from 1 to 31 can be keyed by numeric function keys.
year	The year, depends on the year of the BIOS

Time

The time format is <hour> <minute> <second>.

**PrimaryMaster/PrimarySlave
SecondaryMaster/Secondary Slave**

These categories identify the types of 2 channels that have been installed in the computer. There are 45 pre-defined types and 4 user definable types for Enhanced IDE BIOS. Type 1 to Type 45 are pre-defined. Type User is user-definable.

Press PgUp/<+> or PgDn/<-> to select a numbered hard disk type or type the number and press <Enter>. Note that the specifications of your drive must match with the drive table. The hard disk will not work properly if you enter improper information for this category. If your hard disk drive type is not matched or listed, you can use Type User to define your own drive type manually.

If you select Type User, related information is asked to be entered to the following items. Enter the information directly from the keyboard and press <Enter>. This information should be provided in the documentation from your hard disk vendor or the system manufacturer.

If the controller of HDD interface is ESDI, the selection shall be
“Type 1”.

If the controller of HDD interface is SCSI, the selection shall be
“None”.

If the controller of HDD interface is CD-ROM, the selection shall be
“None”.

CYLS.	number of cylinders
HEADS	number of heads
PRECOMP	write precom
LANDZONE	landing zone
SECTORS	number of sectors
MODE HDD	access mode

CPU Internal Cache

The default value is Enabled.

Enabled (default) Enable cache

Disabled Disable cache

Note: The internal cache is built in the processor.

External Cache

Choose Enabled or Disabled. This option enables the level 2 cache memory.

CPU L2 Cache ECC Checking

Choose Enabled or Disabled. This option enables the level 2 cache memory ECC(error check correction). Using 66MHz CPU BUS Deschutes processor, set to Enabled or Disabled. Using 100MHz CPU BUS Deschutes processor, always set to Enabled. For Klamath processor, always set to Disabled.

Quick Power On Self Test

This category speeds up Power On Self Test (POST) after you power on the computer. If this is set to Enabled, BIOS will shorten or skip some check items during POST.

Enabled Enable quick POST

Disabled (default) Normal POST

Boot From LAN First

During Enabled, if there's a LAN card onboard, the priority from booting will be from the LAN.

Boot Sequence

This category determines which drive the computer searches first for the disk operating system (i.e., DOS). The settings are A,C,SCSI/C,A,SCSI/C,CD-ROM,A/CD-ROM,C,A/D,A,SCSI/E,A,SCSI/F,A,SCSI/SCSI,A,C/SCSI,C,A/C,LS/ZIP,C only. Default value is A,C,SCSI.

Swap Floppy Drive

Switches the floppy disk drives between being designated as A and B. Default is Disabled.

Boot Up Floppy Seek

During POST, BIOS will determine if the floppy disk drive installed is 40 or 80 tracks. 360K type is 40 tracks while 760K, 1.2M and 1.44M are all 80 tracks.

Floppy FIFO Control

During Enabled, the FDD disk will perform better.

Boot Up NumLock Status

The default value is On.

On (default) Keypad is numeric keys.

Off Keypad is arrow keys.

Gate A20 Option

Normal The A20 signal is controlled by keyboard controller or chipset hardware.

Fast(default) The A20 signal is controlled by port 92 or chipset specific method.

Security Option

This category allows you to limit access to the system and Setup, or just to Setup.

System	The system will not boot and access to Setup will be denied if the correct password is not entered at the prompt.
Setup (default)	The system will boot, but access to Setup will be denied if the correct password is not entered at the prompt.

PCI VGA Palette Snooping

Choose Disabled or Enabled. Some graphic controllers which are not VGA compatible, take the output from a VGA controller and map it to their display as a way to provide the boot information and the VGA compatibility.

However, the color information coming from the VGA controller is drawn from the palette table inside the VGA controller to generate the proper colors, and the graphic controller needs to know what is in the palette of the VGA controller. To do this, the non-VGA graphic controller watches for the Write access to the VGA palette and registers the snoop data. In PCI based systems, where the VGA controller is on the PCI bus and a non-VGA graphic controller is on an ISA bus, the Write Access to the palette will not show up on the ISA bus if the PCI VGA controller responds to the Writes.

In this case, the PCI VGA controller should not respond to the Write. It should only snoop the data and permit the access to be forwarded to the ISA bus. The non-VGA ISA graphic controller can then snoop the data on the ISA bus. Unless you have the above situation, you should disable this option.

Disabled (default)	Disables the function
Enabled	Enables the function

OS Selection for DRAM > 64MB

Allows OS2® to be used with > 64 MB of DRAM. Settings are Non-OS/2 (default) and OS2. Set to OS/2 if using more than 64MB and running OS/2®.

Report No FDD For WIN 95

This function is only used when you are testing SCT for Windows® 95 Logo.

Video BIOS Shadow

Determines whether video BIOS will be copied to RAM for faster execution. Video shadow will increase the video performance.

Enabled (default)	Video shadow is enabled
Disabled	Video shadow is disabled

C8000 - CFFFF Shadow/E8000 - EFFFF Shadow

Determines whether the optional ROM will be copied to RAM for faster execution.

Enabled	Optional shadow is enabled
Disabled (default)	Optional shadow is disabled

Note: For C8000-DFFFF optional-ROM on PCI BIOS, BIOS will automatically enable the shadow RAM. User does not have to select the item.

3.6 Chipset Features Setup

The Chipset Features Setup option is used to change the values of the chipset registers. These registers control most of the system options in the computer.

Choose the “CHIPSET FEATURES SETUP” from the Main Menu and the following screen will appear.

ROM PCI/ISA BIOS(2A59IM4A)
CMOS SETUP UTILITY
CHIPSET FEATURES SETUP

SDRAM Configuration by :SPD	CPU Host/PCI clock :Default
SDRAM RAS to CAS Delay :3	
SDRAM RAS Precharge Time :3	
SDRAM CAS Latency Time :3	
DRAM Data Integrity Mode :Non-ECC	
System BIOS Cacheable :Disabled	
Video BIOS Cacheable :Disabled	
Video RAM Cacheable :Disabled	
8 Bit I/O Recovery Time :1	
16 Bit I/O Recovery Time :1	
Memory Hole at 15M-16M :Disabled	
Passive Release :Enabled	
Delayed Transaction :Disabled	
AGP Aperture Size (MB) :64	
Spread Spectrum Modulated:Enabled	
	Esc : Quit ↑↓→← : Select item
	F1 : Help PU/PD/+/- : modify
	F5 : Old Value(Shift) F2 : Color
	F6 : Load BIOS Defaults
	F7 : Load Setup Defaults

Note: Change these settings only if you are familiar with the chipset.

SDRAM RAS to CAS Delay

You can select the SDRAM RAS to CAS delay time in HCLKs of 2 or 3 (default). The system board designer should set the values in this field, depending on the SDRAM installed.

SDRAM RAS Precharge Time

You can select the SDRAM RAS Precharge time in HCLKs of 2 or 3 (default). The system board designer should set the values in this field, depending on the SDRAM installed.

SDRAM CAS Latency Time

You can select CAS latency time in HCLKs of 2 or 3 (default). The system board designer should set the values in this field, depending on the SDRAM installed.

DRAM Data Integrity Mode

Select Non-ECC or ECC(error-correcting code), according to the type of installed DRAM. The settings are Non-ECC (default) or ECC.

System BIOS Cacheable

Select Enabled allows caching of the system BIOS ROM at F000h-FFFFh, resulting in better system performance. However, if any program writes to this memory area, a system error may result.

Enabled	BIOS access cached
Disabled	BIOS access not cached

Video BIOS Cacheable

Select Enabled allows caching of the system BIOS ROM at C0000h-F7FFFh, resulting in better video performance. However, if any program writes to this memory area, a system error may result.

Enabled	Video BIOS access cached
Disabled	Video BIOS access not cached

Video RAM Cacheable

Select Enabled allows caching of the video RAM, resulting in better system performance. However, if any program writes to this memory area, a system error may result.

8 Bit I/O Recovery Time

The recovery time is the length of time, measured in CPU clocks, which the system will delay after the completion of an input/output request. This delay takes place because the CPU is operating so much faster than the input/output bus that the CPU must be delayed to allow for the completion of the I/O.

This items allows you to determine the recovery time allowed for 8 bit I/O. Choices are from NA, 1 to 8 CPU clocks.

16 Bit I/O Recovery Time

This items allows you to determine the recovery time allowed for 16 bit I/O. Choices are from NA, 1 to 4 CPU clocks.

Memory Hole At 15M-16M

In order to improve performance, certain space in memory can be reserved for ISA cards. This memory must be mapped into the memory space below 16 MB.

Enabled	Memory hole supported.
Disabled	Memory hole not supported.

Passive Release

When Enabled, CPU to PCI bus accesses are allowed during passive release. Otherwise, the arbiter only accepts another PCI master access to local DRAM. The settings are Enabled or Disabled.

Delayed Transaction

The chipset has an embedded 32-bit posted write buffer to support delay transaction cycles. Select Enabled to support compliance with PCI specification version 2.1. The settings are Enabled or Disabled.

AGP Aperture Size (MB)

Select the size the of the Accelerated Graphics Port (AGP) aperture. The aperture is a portion of the PCI memory address range dedicated for graphics memory address space. Host cycles that hit the aperture range are forwarded to the AGP without any translation.

Spread Spectrum Modulated

This item allows you to select the clock generator Spread Spectrum function. The default is enabled. This item should always be set to Disabled, if you over-clock the processor.

CPU Host/PCI Clock

This items allows you to select the CPU host frequency and PCI clock frequency. The settings are 66/33Mhz or 100/33MHz (default), 100/33MHz, 133/44MHz, 112/33MHz, and 103/34MHz.

3.7 Power Management Setup

The Power Management Setup will appear on your screen like this:

ROM PCI/ISA BIOS (2A59IM4A)
 POWER MANAGEMENT SETUP
 AWARD SOFTWARE, INC.

Power Management	:User Define	Wake Up on LAN	: Disable
PM Control by APM	:Yes	Restore AC/Power Loss	:Power On
Video Off Method	:DPMS	IRQ 8 Break Suspend	:Disabled
Video Off After	:Standby		
Modem Use IRQ	:3	** Reload Global Timer Events **	
Reserve IRQ9	:Yes	IRQ [3-7,9-15],NMI	: Disabled
Doze Mode	:Disable	Primary IDE 0	: Enabled
Standby Mode	:Disable	Primary IDE 1	: Enabled
Suspend Mode	:Disable	Secondary IDE 0	: Disabled
HDD Power Down	:Disable	Secondary IDE 1	: Disabled
Throttle Duty Cycle	:62.5%	Floppy Disk	: Disabled
VGA Active Monitor	:Disabled	Serial Port	: Enabled
Soft-Off by PWR-BTTN	:Instant-Off	Parallel Port	: Disabled
CPUFAN off in Suspend	:Enabled		
Resume by Ring	:Disabled		
Resume by Alarm	:Disabled		
Date(of Month) Alarm	:2		
Time(hh:mm:ss) Alarm	: 0:0:0		
		Esc : Quit	↑↓→← : Select item
		F1 : Help	PU/PD/+/- : modify
		F5 : Old Value(Shift)	F2 : Color
		F6 : Load BIOS Defaults	
		F7 : Load Setup Defaults	
Power status LED	:Dual Color		

Power Management

This category determines the power consumption for system after selecting below items. Default value is user define. The following pages tell you the options of each item & describe the meanings of each options.

Power Management

Disable	Global Power Management will be disabled.
User Define	Users can configure their own power management.
Min Saving	Pre-defined timer values are used such that all timers are in their MAX value.
Max Saving	Pre-defined timer values are used such that all timers are in their MIN value.

PM Control by APM

No	System BIOS will ignore APM when power managing the system.
Yes	System BIOS will wait for APM's prompt before it enter any PM mode

Note :Enable this for O.S. with APM like Windows® 95, Windows® NT, etc.

Video Off Method

Blank Screen	The system BIOS will only blank off the screen when disabling video.
V/H SYNC+Blank	In addition to (1), BIOS will also turn off the V-SYNC & H-SYNC signals from VGA card to monitor.
DPMS	This function is enabled only for VGA card supporting DPMS.

Note: Green monitors detect the V/H SYNC signals to turn off its electron gun.

Video Off After

The settings are N/A, Standby, Doze, or Suspend. This option is for choosing the setting in which the monitor will turn off.

N/A Always turn on.

Doze During Doze mode, the monitor will be turned off.

Standby During Standby mode, the monitor will be turned off.

Suspend During Suspend mode, the monitor will be turned off.

The default setting is Standby.

MODEM Use IRQ

Name the interrupt request (IRQ) line assigned to the modem (if any) on your system. Activity of the selected IRQ always awakens the system. The settings are NA, 3, 4, 5, 7, 9, 10, or 11.

Reserve IRQ 9

This item is reserved for Windows® 98 ACPI mode. Choose yes, if you use Windows® 98 ACPI mode. Otherwise, set to no.

Doze Mode

Disable System will never enter DOZE mode.

1 Min/2 Min/4 Min/6 Min/ Defines the continuous idle time before the system enters DOZE mode.

8 Min/10 Min/20 Min/30 Min/40 Min/1 Hr If any item defined in the options of “Power Down and Resume events” is enabled & active, DOZE timer will be reloaded. When the system have entered Doze mode, any of the items enabled in “Wake Up Events in Doze and Standby” will trigger the system to wake up.

Standby Mode

- Disable** System will never enter STANDBY mode.
- 1 Min/2 Min/** Defines the continuous idle time before the
4 Min/6 Min/ system enters STANDBY mode.
8 Min/10 Min/ If any item defined in the options of “Power
20 Min/30 Min/ Down and Resume events” is enabled & active,
40 Min/1 Hr STANDBY timer will be reloaded. When the
system has entered Standby mode , any of the
items that are enabled in “Wake Up Events of
Doze and Standby” will trigger the system to
wake up.

Suspend Mode

- Disable** System will never enter SUSPEND mode.
- 1 Min/2 Min/** Defines the continuous idle time before the
4 Min/6 Min/ system enters SUSPEND mode.
8 Min/10 Min/ If any item defined in the options of “Power
20 Min/30 Min/ Down & Resume Events” is enabled & active,
40 Min/1 Hr SUSPEND timer will be reloaded. When the
system has entered SUSPEND mode, any of the
items enabled in the “Power Down & Resume
Events” will trigger the system to wake up.

HDD Power Down

- Disable** HDD’s motor will not shut off.
- 1 Min/2 Min/** Defines the continuous HDD idle time before
3 Min/4 Min/ the HDD enters the power saving mode (motor
5 Min/6 Min/ off). BIOS will turn off the HDD’s motor when
7 Min/8 Min/ time is out.
9 Min/10 Min/
11 Min/12 Min/
13 Min/14 Min/
15 Min

Throttle Duty Cycle

This option will determine how much power will be used by the CPU , if the system goes into suspend mode.

VGA Active Monitor

During Enabled, if there's no activity in the monitor screen, the system will go into Power Saving Mode. During Disabled, the system will go into Power Saving Mode, whether there is activity in the monitor screen or not. The settings are Disabled and Enabled.

Soft-Off by PWR-BTTN

The settings are Delay 4 sec or Instant-off. During Delay 4 sec, if you push the switch once, the system goes into suspend mode. If you push it more than 4 seconds, the system will be turned off. During instant-off, the system will turn off once you push the switch.

CPUFAN Off in Suspend

During Enabled, if the system goes into suspend mode, the CPU fan will stop. During Disabled, if the system goes into suspend mode the CPU fan will resume.

Resume by Ring

During Disabled, the system will ignore any incoming call from the modem. During Enabled, the system will boot up if there's an incoming call from the modem.

Note: If you have change the setting, you must let the system boot up until it goes to the operating system, before this function will work.

Resume by Alarm

This function is for setting date and time for your computer to boot up. During Disabled, you cannot use this function. During Enabled, choose the Date and Time Alarm:

Date(of month) Alarm You can choose which month the system will boot up. Set to 0, to boot every month.

Time(hh:mm:ss) Alarm You can choose what hour, minute and second the system will boot up.

Note: If you have change the setting, you must let the system boot up until it goes to the operating system, before this function will work.

Power LED

This item determines which state the Power LED will use. The settings are Blink, Dual color, and Single color. During blink, the power LED will blink when the system enters the suspend mode. When the mode is in Dual Color, the power LED will change its color. Choose the single color and the power LED will always remain lit.

Wake Up On LAN

To use this function, you need a LAN add-on card which support power on functions. It should also support the wake-up on LAN jumper (JWOL1).

Enabled	Wake up on LAN supported.
Disabled	Wake up on LAN not supported.

Restore on AC/Power Loss

The settings are power on or last status. During power on, after every AC power loss, the system will be turned on. During last status, after every AC power loss, whatever the system status, it will be the same when the AC power returns.

Note: a. If you set this option to last status, jumper JP1 must be open or this function will not work.

IRQ 8 Clock Event

You can Enable or Disable monitoring of IRQ 8 so it does not awaken the system form suspend mode.

IRQ 8 Clock Event

IRQ[3-7,9-15], NMI	: Enabled
Primary IDE 0	: Enabled
Primary IDE 1	: Disabled
Secondary IDE 0	: Disabled
Secondary IDE 1	: Disabled
Floppy Disk	: Enabled
Serial Port	: Enabled
Parallel Port	: Enabled

During Enabled, if any interrupt event occurs, the system will wake-up from suspend mode. During Disabled, the system will not monitor any interrupt event.

3.8 PNP/PCI Configuration Setup

You can manually configure the PCI Device's IRQ. The following pages tell you the options of each item & describe the meanings of each options.

ROM PCI/ISA BIOS (2A69HM4D)
PNP/PCI CONFIGURATION SETUP
AWARD SOFTWARE, INC.

PnP OS Installed	:No	Assign IRQ for VGA	: Enabled
Resources Controlled By	:Manual	Assign IRQ for USB	: Enabled
Reset Configuration Data	:Disabled	Used MEM base addr	: N/A
IRQ-3 assigned to	:Legacy ISA		
IRQ-4 assigned to	:Legacy ISA		
IRQ-5 assigned to	:PCI/ISA PnP		
IRQ-7 assigned to	:PCI/ISA PnP		
IRQ-9 assigned to	:PCI/ISA PnP		
IRQ-10 assigned to	:PCI/ISA PnP		
IRQ-11 assigned to	:PCI/ISA PnP		
IRQ-12 assigned to	:PCI/ISA PnP		
IRQ-14 assigned to	:PCI/ISA PnP		
IRQ-15 assigned to	:PCI/ISA PnP		
DMA-0 assigned to	:PCI/ISA PnP		
DMA-1 assigned to	:PCI/ISA PnP		
DMA-3 assigned to	:PCI/ISA PnP		
DMA-5 assigned to	:PCI/ISA PnP		
DMA-6 assigned to	:PCI/ISA PnP		
DMA-7 assigned to	:PCI/ISA PnP		
		Esc : Quit	↑↓→← : Select item
		F1 : Help	FU/PD/+/- : modify
		F5 : Old Value(Shift)	F2 : Color
		F6 : Load BIOS Defaults	
		F7 : Load Setup Defaults	

PnP OS Installed

When set to YES, BIOS will only initialize the PnP cards used for booting (VGA, IDE, SCSI). The rest of the cards will be initialized by the PnP operating system like Windows® 95 or 98. When set to NO, BIOS will initialize all the PnP cards. So, for non-PnP operating system (DOS, Netware®), this option must set to NO.

Resources Controlled By

By Choosing “Auto”, the system BIOS will detect the system resource and automatically assign the relative IRQ and DMA Channel for each peripheral.

By Choosing “Manual”(default), the user will need to assign IRQ & DMA for add-on cards. Be sure that there is no conflict for IRQ/DMA and I/O ports.

Note: When choosing “Auto”, you must be sure that all of the system add-on cards are PnP type.

Reset Configuration Data

The system BIOS supports the PnP feature so the system needs to record which resource is assigned and protect resources from conflict. Every peripheral device has a node which is called ESCD. This node records which resources are assigned to it. The system needs to record and update ESCD to the memory locations. These locations (4K) are reserved at the system BIOS.

If Disabled (default) is chosen, the system’s ESCD will update only when the new configuration varies from the last one.

If Enabled is chosen, the system will be forced to update the system’s ESCD. Then, this option will be auto-set to Disable.

IRQ-3 assigned to : Legacy ISA
IRQ-4 assigned to : Legacy ISA
IRQ-5 assigned to : PCI/ISA PnP
IRQ-7 assigned to : Legacy ISA
IRQ-9 assigned to : PCI/ISA PnP
IRQ-10 assigned to : PCI/ISA PnP
IRQ-11 assigned to : PCI/ISA PnP
IRQ-12 assigned to : PCI/ISA PnP
IRQ-14 assigned to : PCI/ISA PnP

IRQ-15 assigned to : PCI/ISA PnP
DMA-0 assigned to : PCI/ISA PnP
DMA-1 assigned to : PCI/ISA PnP
DMA-3 assigned to : PCI/ISA PnP
DMA-5 assigned to : PCI/ISA PnP
DMA-6 assigned to : PCI/ISA PnP
DMA-7 assigned to : PCI/ISA PnP

The above settings will be shown on the screen only if “Manual” is chosen for the *Resources Controlled By* function.

Legacy is the term which signifies that a resource is assigned to the ISA Bus and provides for non PnP ISA add-on card. PCI/ISA PnP signifies that a resource is assigned to the PCI Bus or provides for ISA PnP add-on cards and peripherals.

Assign IRQ for VGA

Lets the user choose which IRQ to assign for VGA card.

Assign IRQ for USB

Set to Enabled when USB port will be used. Set to Disable if the USB port will not be used.

Used MEM base addr

Lets the user choose the Legacy ISA addr. The settings are NA#, C800, CC00, D000, D400, D800 or DC00.

Used MEM base addr

Lets the user choose the Legacy ISA addr. memory length. The settings are 8K, 16K, 32K, or 64K.

3.9 Load BIOS/Setup Defaults

This Main Menu item loads the default system values. If the CMOS is corrupted, the defaults are loaded automatically. Choose this item and the following message appears:

“ Load Setup Defaults (Y / N) ? N “

To use the Setup defaults, change the prompt to “Y” and press < Enter >

Note: The Setup defaults can be customized to increase performance. However the BIOS defaults can always be used as a back up if there is some problem with the mainboard operation.

3.10 Special Features Setup (optional)

This Special Features Setup is used by System Hardware Monitor chipset. You can manually change the value of each option.

ROM PCI/ISA BIOS (2A69HM4C)
 INTEGRATED PERIPHERALS
 AWARD SOFTWARE, INC.

***** POST SHOWING *****		***** SYSTEM MONITOR *****	
Chassis Fan Detected	: Disabled	Chassis FAN RPM	: 0
Power Fan Detected	: Disabled	Power FAN RPM	: 0
CPU Fan Detected	: Enabled	CPU Fan RPM	: 6367
Chassis Intrusion Detect	: Disabled	System Temperature	: 26°C/78°F
Voltage Detected	: Enabled	CPU Temperature	: 28°C/82°F
Vcore Voltage Detected	: Enabled	CPU Critical Temp	: Disabled
+2.5V Voltage Detected	: Enabled	Shutdown Temp	: Disabled
+3.3V Voltage Detected	: Enabled		
+5.0V Voltage Detected	: Enabled		
+12V Voltage Detected	: Enabled		
-12V Voltage Detected	: Enabled		
-5.0V Voltage Detected	: Enabled		
*****CPU PLUG & PLAY *****			
CPU Speed	: 350MHz (100x3.5)	Esc : Quit ↑↓→← : Select item	
CPU Ratio	: x3	F1 : Help PU/PD/+/- : modify	
CPU Frequency	: 68MHz	F5 : Old Value(Shift) F2 : Color	
		F6 : Load BIOS Defaults	
		F7 : Load Setup Defaults	

Chassis Fan Detected/Power Fan Detected/CPU Fan Detected/Voltage Detected/Vcore Voltage Detected/+2.5V Voltage Detected/+3.3V Voltage Detected/+5.0 Voltage Detected/+12V Voltage Detected/-12V Voltage Detected/-5.0 Voltage Detected

During Enabled, this will show the CPU/FAN voltage chart during system boot up. During Disabled, this will not show.

Chassis Intrusion Detect

Set this option to Enabled, Reset, or Disabled the chassis intrusion detector. During Enabled, any intrusion on the system chassis will be recorded. The next time you turn on the system, it will show a warning message. To be able to clear those warning, choose Reset. After clearing the message, it will go back to Enabled.

CPU Speed

Check you processor and set this function accordingly. If you set this to Manual, you can set the CPU Ratio and CPU Frequency accordingly. CPU Frequencies are: 66, 68, 75, 83 and 100, 103, 112. **Though 68, 75, 83, 103, and 112 frequencies are available, it is advised that you use these only for testing since this might cause instability as the CPU is not designed for these frequencies.** CPU ratio are: 3, 3.5, 4, 4.5, 5, 5.5, 6, 6.5, 7, 7.5, or 8.

Note: If you set the CPU Ratio and CPU Frequency to be too high, and the system will not turn on, restart the system. Press “F10” until bootup. This will set the default setting.

Chassis/Power/CPU Fan RPM

During Enabled, this will monitor the RPM of your CPU/Chassis/Power fan.

System Temperature/CPU Temperature

This will show the System and CPU temperature.

CPU Critical Temp

This option is for setting the critical temperature level for the processor. When the processor reach the temperature you set, this will reduce the load on the processor.

Shutdown Temp

This option is for setting the Shutdown temperature level for the processor. When the processor reach the temperature you set, this will shutdown the system. This function only works with Windows® 95 operating system.

3.11 Integrated Peripherals

ROM PCI/ISA BIOS (2A69HM4D)
 INTEGRATED PERIPHERALS
 AWARD SOFTWARE, INC.

IDE HDD Block Mode : Enabled	Parallel Port Mode : SPP
IDE Primary Master PIO : Auto	
IDE Primary Slave PIO : Auto	
IDE Secondary Master PIO : Auto	
IDE Secondary Slave PIO : Auto	
IDE Primary Master UDMA : Auto	
IDE Primary Slave UDMA : Auto	
IDE Secondary Master UDMA: Auto	
IDE Secondary Slave UDMA : Auto	
On-Chip Primary PCI IDE : Enabled	
On-Chip Primary PCI IDE : Enabled	
Init Dislay First : PCI slot	
USB Keyboard support : Disabled	
Onboard Sound : Enable	
Onboard FDC controller : Enabled	Esc : Quit ↑↓→←: Select item
Onboard Serial Port 1 : 3F8/IRQ4	F1 : Help PU/PD/+/- : modify
Onboard Serial Port 2 : 2F8/IRQ3	F5 : Old Value(Shift) F2 : Color
UART Mode Select : Normal	F6 : Load BIOS Defaults
Onboard Parallel Mode : 378/IRQ7	F7 : Load Setup Defaults

IDE HDD Block Mode

Enabled/Disabled Enabled allows the Block mode access for the IDEHDD.

IDE Primary Master PIO

Auto/Mode0/Mode1-4

IDE Primary Slave PIO

Auto/Mode0/Mode1-4

IDE Secondary Master PIO

Auto/Mode0/Mode1-4

IDE Secondary Slave PIO**Auto/Mode0/Mode1-4**

For these 4 IDE options, choose “Auto” to have the system BIOS auto detect the IDE HDD operation mode for PIO access.

Note: Some IDE HDD can not operate at the responding HDD’s mode. When the user has selected “Auto” and the system BIOS has accepted the HDD response mode, the user may degrade the HDD’s operation mode. Ex: IF the HDD reported it can operate in mode 4 but it is not operating properly, the user will have to manually change the operation mode to mode 3.

Choosing Mode 1-4 will have the system ignore the HDD’s reported operation mode and use the selected mode instead.

Note: According to ATA specs. Mode 4 transfer rate is > Mode 3 > Mode 2 > Mode 1 > Mode 0. If the user’s HDD can operate at Mode 3 the user can also select a slower Mode (i.e. Mode 0-2) but not a faster Mode (ie Mode 4).

On-Chip Primary PCI IDE**Enabled/Disabled****On-Chip Secondary PCI IDE****Enabled/Disabled**

The system provides for a On-Board On-Chipset PCI IDE controller that supports Dual Channel IDE (Primary and Secondary). A maximum of 4 IDE devices can be supported. If the user install the Off-Board PCI IDE controller (i.e. add-on cards), the user must choose which channels will be disabled. This will depend on which channel will be used for the Off-Board PCI IDE add-on card.

USB Keyboard Support**Enabled/Disabled**

Choosing Enabled will allow the system to use USB keyboard without a device driver.

Onboard FDC Controller**Enabled/Disabled**

The system has an on-board Super I/O chip with a FDD controller that supports 2 FDDs for 360K/720K/1.2M/1.44M/2.8M. Choose “Enabled” to use the on-board FDD controller for accessing the FDD. Otherwise choose “Disabled” to use the off-board FDD controller.

Onboard Serial Port 1**Disabled/(3F8/IRQ4)/(2F8/IRQ3)/(3E8/IRQ4)/(2E8/IRQ3)****Onboard Serial Port 2****Disabled/(3F8/IRQ4)/(2F8/IRQ3)/(3E8/IRQ4)/(2E8/IRQ3)**

The system has an On-board Super I/O chipset with 2 serial ports. The On-board serial ports can be selected as:

Disabled

3F8/IRQ4	COM 1 uses IRQ4
2F8/IRQ3	COM 2 uses IRQ3
3E8/IRQ4	COM 3 uses IRQ4
2E8/IRQ3	COM 4 uses IRQ3

Note: Because the ISA Bus Interrupt accepts low to high edge trigger, the interrupt request line cannot be shared by multiple sources. If an off-board ISA add-on card with a serial port is installed the user may have to disable the on-board serial port because it will conflict with IRQ request line for the off-board serial port.

UART Mode Select

This item allow you to determine which Infra Red (IR) function of onboard I/O chip.

Onboard Parallel Port

Disabled

(3BCH/IRQ7)/

(278H/IRQ5)/

(378H/IRQ5)

There is a built-in parallel port on the on-board Super I/O chipset that provides Standard, ECP, and EPP features. It has the following options:

Disable

3BCH/IRQ7 Line Printer port 0

278H/IRQ5 Line Printer port 2

378H/IRQ5 Line Printer port 1

Onboard Parallel Mode

SPP : Standard Parallel Port

EPP : Enhanced Parallel Port

ECP : Extended Capability Port

SPP/(EPP/SPP)/

ECP(ECP/EPP)

To operate the onboard parallel port as Standard Parallel Port only, choose "SPP." To operate the onboard parallel port in the ECP and SPP modes simultaneously, choose "ECP/SPP." By choosing "ECP", the onboard parallel port will operate in ECP mode only. Choosing "ECP/EPP" will allow the onboard parallel port to support both the ECP and EPP modes simultaneously. The ECP mode has to use the DMA channel, so choose the onboard parallel port with the ECP feature. After selecting it, the following message will appear: "ECP Mode Use DMA" At this time, the user can choose between DMA

channels 3 or 1. The onboard parallel port is EPP Spec. compliant, so after the user chooses the onboard parallel port with the EPP function, the following message will be displayed on the screen: “EPP Mode Select.” At this time either EPP 1.7 spec. or EPP 1.9 spec. can be chosen.

3.12 Supervisor/User Password Setting

This Main Menu item lets you configure the system so that a password is required each time the system boots or an attempt is made to enter the Setup program. Supervisor Password allows you to change all CMOS settings but the User Password setting doesn't have this function. The way to set up the passwords for both Supervisor and User are as follow:

1. Choose "Change Password" in the Main Menu and press <Enter>. The following message appears:

"Enter Password:"

2. The first time you run this option, enter your password up to only 8 characters and press <Enter>. The screen does not display the entered characters. For no password just press <Enter>.
3. After you enter the password, the following message appears prompting you to confirm the password:

"Confirm Password:"

4. Enter exactly the same password you just typed in to confirm the password and press <Enter>.
 5. Move the cursor to Save & Exit Setup to save the password.
 6. If you need to delete the password you entered before, choose the Supervisor Password and press <Enter>. It will delete the password that you had before.
 7. Move the cursor to Save & Exit Setup to save the option you did. Otherwise, the old password will still be there when you turn on your machine next time.
-

3.13 IDE HDD Auto Detection

You can use this utility to automatically detect the characteristics of most hard drives.

When you enter this utility, the screen asks you to select a specific hard disk for Primary Master. If you accept a hard disk detected by the BIOS, you can enter “Y” to confirm and then press <Enter> to check next hard disk. This function allows you to check four hard disks and you may press the <Esc> after the <Enter> to skip this function and go back to the Main Menu.

**ROM ISA BIOS
CMOS SETUP UTILITY
AWARD SOFTWARE, INC.**

HARD DISKS	TYPE	SIZE	CYLS	HEADS	PRECOMP	LANDZONE	SECTOR MODE
Primary Master:	Auto	0	0	0	0	0	AUTO
Primary Slave :	Auto	0	0	0	0	0	AUTO
Secondary Master :	Auto	0	0	0	0	0	AUTO
Secondary Slave :	Auto	0	0	0	0	0	AUTO

Select Primary Master		Option (N=Skip) : N				
OPTIONS	SIZE	CYLS	HEAD	PRECOMP	LANDZ	SECTOR MODE
2	2112	1023	64	0	4094	63 LBA
1	2113	4095	16	65535	4094	63 NORMAL
3	2113	2047	32	65535	4094	63 LARGE

[ESC: Skip]

Chapter 4

ATI® 3D RAGE PRO/ATI® 3D RAGE IIC VGA DRIVER

1. Overview

The ATI® 3D RAGE PRO/ATI® 3D RAGE IIC is a highly integrated graphics controller. Incorporated within this single chip are the 2D, 3D, and video accelerators, palette DAC, and dual-clock synthesizer. This multi-function integrated controller delivers TV-quality scaled video optimized for MPEG playback, industry-leading mach64 2D performance.

1.1 ATI® RAGE PRO Features

- Support 2M or 4M SGRAM for 100MHz.
- Support AGP 2X BUS Up to 133MHz.
- Complete 3D primitive support: points, lines, triangles, strips, and quadrilaterals.
- 4K On-chip Texture Cache.
- 16-bit Z buffer.

1.2 ATI® RAGE II C Features

- Support 2M or 4M SGRAM for 83MHz.
- Support AGP 1X BUS Up to 66MHz.
- Complete 3D primitive support: points, lines, triangles, lists, strips, and quadrilaterals.
- Hidden surface removal using 16-bit Z-buffering.
- Support for single pass bi-and tri-linear texture filtering.

1.3 System Requirements

This section describes system requirements for the VGA Driver installation and Usage.

Computer	Intel® Pentium® II processor or higher
Monitor	VGA Support, minimum 640x480 resolution
Operating system	DOS 5.0 or higher, Windows® 95, Windows® NT 3.51 or 4.0, or OS/2®
CD-ROM	Double Speed or Higher
Chipset	ATI® 3D RAGE II C/ATI® RAGE PRO
VGA BIOS	Version 1.01 or Higher

2. ATI® 3D VGA Driver Setup & Usage Procedures

Insert the CD-title into your CD-ROM drive. This CD will auto-run. This will display installation for VGA driver and sound driver. Also included are Intel® PIIX4 patch for Windows® 95, Norton® Anti-virus, and Bus Master driver. Just click the button for automatic installation for VGA driver.

2.1 Windows® 95

If you start Windows® 95, this will automatically detect this hardware onboard “PCI Multimedia Audio Device” and “Gameport Joystick”. You need to click “Next”, then “Finish”. Do not click on the “Cancel”. The driver need these ID.

2.1-1 Display Driver Installation Procedure:

Step 1: Insert the provided CD_ROM disk into the CD-ROM drive.

Step 2: Look for the CD_ROM drive, double click on the CD_ROM icon. This will show the setup screen.

Step 3: Click on “ATI Installation” icon.

Step 4: This will show an ATI installation menu.

Step 5: Click on “Display Drivers”.

Step 6: Click “OK”.

Step 7: This will copy the VGA drivers into the hard drive.

Step 8: A message will appear stating you must restart the Windows® 95 system, select **yes** to restart.

Step 9: After restarting, Windows® 95 will show a new display setting.

2.1-2 Changing resolution, color depth, and refresh rate:

- Step 1:** Click **Start** menu and select **Control Panel** from **Settings** group.
- Step 2:** Select **Display** icon.
- Step 3:** Select **Settings**.
- Step 4:** Select Color Palette to change between 16 color, 256 color, Hi color, or True color.
- Step 5:** Select desktop resolution from 640x480, 800x600, 1024x768, and 1280x1024.
- Step 6:** Select Refresh rate list box to change the screen refresh rate.
- Step 7:** Click OK or Apply.

2.1-3 ATI Video Player for Windows 95

- Step 1:** Insert the provided CD_ROM disk into the CD-ROM drive.
- Step 2:** Look for the CD_ROM drive, double click on the CD_ROM icon. This will show the setup screen.
- Step 3:** Click on “ATI Installation” icon.
- Step 4:** This will show an ATI installation menu.
- Step 5:** Click on “ATI Video Player”.
- Step 6:** This will show “ATI Video Player Setup” icon.
- Step 7:** Click on “Finish”.
- Step 8:** This will copy the necessary files into the hard drive.
- Step 9:** After restarting, ATI setup is completed.

Note: Xing Software MPEG is incompatible with Windows® 95.

2.2 Windows® NT 4.0

You need to install Windows® NT “Service Pack”, before you install Windows® NT driver.

2.2-1 Display Driver Installation Procedure:

- Step 1:** Click **Start** menu and select **Control Panel** from **Settings** group.
- Step 2:** Select **Display** icon.
- Step 3:** Select **Settings** on the Display Properties.
- Step 4:** Select **Display Type**.
- Step 5:** Select **Change** from the **Adapter Type** Area.
- Step 6:** Select **Have Disk** of Change Display.
- Step 7:** Insert the **CD-Title Disk** into CD-ROM Drive.
- Step 8:** When the Install from Disk dialog box appears, look for your CD-ROM drive: **:\VGAATI\NT40\ati.inf**.
- Step 9:** When the **Change Display** dialog box appears, click **OK**.
- Step 10:** When the Third-party Drivers dialog box appears, click **Yes**
A message will appear stating that the drivers were successfully installed. Click **OK**. You must now restart Windows® NT 4.0.

2.2-2 Changing resolution, color depth, and refresh rate:

- Step 1:** Click **Start** menu and select **Control Panel** from **Settings** group.
- Step 2:** Select **Display** icon.
- Step 3:** Select **Settings**.
- Step 4:** Select Color Palette to change between 16 color, 256 color, 32768 colors, 65536 colors, and 16777216 colors.
- Step 5:** To select desktop resolution size, go to the Desktop area and use the slide bar to change resolution from 640x480, 800x600, 1024x768, to 1280x1024.
- Step 6:** Select Test to test the resolution. If the display test screen was good, then select Yes when the Testing Mode dialog box appears. If the display test screen was bad, then select No. Windows® NT will give you an error message.
- Step 7:** Click OK. If the display test screen was good and you select Yes, Windows® NT 4.0 will change the mode without restarting the system.

2.3 AutoCAD, OS/2 and other application. Please refer to “On-Line Manual” in the CD-ROM. You need to install the “Acrobat Reader 3.01” program first.

Chapter 5

CREATIVE® AUDIO DRIVER

1. Overview

The Creative® ES1371 digital controller provides the next generation of audio performance to the PC market.

1.1 Features

- SoundScape WaveTable Synthesizer.
- Full DOS Game Compatibility.
- PCI Bus Master for fast DMA.
- Fully Compliant with PC97 Power Management Specification.

1.2 System Requirements

This section describes system requirements for the Audio Driver installation and Usage.

Computer	Intel® Pentium® II/Celeron™ processor or higher
Operating system	DOS 5.0 or higher, Windows® 95, Windows® NT 3.51 or 4.0, or OS/2®
CD-ROM	Double Speed or Higher
Chipset	Creative® ES1371

2. Audio Driver Setup

Insert the CD-title into your CD-ROM drive. This CD will auto-run. This will display installation for VGA driver and sound driver. Also included are Intel® PIIX4 patch for Windows® 95, Norton® Anti-virus, and Bus Master driver. Just click the button for automatic installation for audio driver.

2.1 Windows® 95

If you start Windows® 95, this will automatically detect this hardware onboard “PCI Multimedia Audio Device” and “Gameport Joystick”. You need to click “Next”, then “Finish”. Do not click on the “Cancel”. The driver need these ID.

2.1-1 Audio Driver Installation Procedure:

- Step 1:** Insert the provided CD_ROM disk into the CD-ROM drive.
- Step 2:** Look for the CD_ROM drive, double click on the CD_ROM icon. This will show the setup screen.
- Step 3:** Click on “ENSONIQ AudioPCI” icon.
- Step 4:** This will copy the audio drivers into the hard drive.
- Step 5:** A message will appear stating you must restart the Windows® 95 system, select **yes** to restart.

2.2 Windows® NT 4.0

2.2-1 Audio Driver Installation Procedure:

- Step 1:** Click **Start** menu and select **Control Panel** from **Settings** group.
- Step 2:** Select **Multimedia** icon.
- Step 3:** Click on the **Devices** tab.
- Step 4:** Click **Add**.
- Step 5:** Double click on **Unlisted or Updated Driver** in the list.
- Step 6:** Insert the **CD-ROM Disk** into the CD-ROM Drive.
- Step 7:** When the Install from Disk dialog box appears, look for your CD-ROM drive: `:\Sound\Ensoniq\AudioPCI\NT40\`
- Step 8:** Click **OK**.
- Step 9:** Click **OK**.
- Step 10:** A message will appear stating that the drivers were successfully installed. Click **OK**. You must now restart Windows® NT 4.0.

2.3 Detailed User's Manual

The detailed user's manual can be found on following path of the CD-ROM provided:

PATH: `Sound\Ensoniq\AudioPCI\Docs\Manual.doc`