

Chapter 1

INTRODUCTION

The MICRO NLX BX4 mainboard is a high-performance personal computer mainboard based on Intel® Pentium® II processor. It combines ATI® 3D RAGE 128VR/Rage XL/Rage Pro AGP graphics accelerator, YAMAHA® YMF740C PCI enhanced audio, and Intel® 82559 10/100M Ethernet. The Pentium® II processor supports MMX™ (Multimedia Extension) technology.

The mainboard uses the highly integrated Intel® 82443BX chipset to support the PCI/ISA and Green standards, and to provide the Host/AGP bridge. The Intel® 82371EB chipset integrates all system control functions such as ACPI (Advanced Configuration and Power Interface). The ACPI provides more Energy Saving Features for the OSPM(OS Direct Power Management) function. The Intel® 82371EB chipset also improves the IDE transfer rate by supporting Ultra DMA/33 IDE that transfers data at the rate of 33MB/s.

The mainboard also supports the System Hardware Monitor Controller. This function includes: CPU /power supply/chassis fan revolution detect, CPU/system voltage monitor, system temperature monitor, and chassis intrusion detect.

1.1 Mainboard Features

CPU

- Slot 1 for Pentium® II/III or Celeron™ processor.
- Supports 233MHz, 266MHz, 300MHz, 333MHz, 350MHz, 400MHz, 450MHz, and faster processor speeds.
- Core/Bus ratios are x2, x2.5, x3, x3.5, x4, x4.5, x5, x5.5, x6 and higher.

Switching Voltage Regulator

- On-board switching mode DC-DC Step Down Regulator.
- Conforms to Intel® VRM ver 8.2 specifications.
- Over-Voltage and Over-Current protection.

Chipset

- Intel® 82440BX AGP chipset.

Clock Generator

- 66.6MHz and 100MHz clocks are supported.

Main Memory

- Supports four memory banks using two 168-pin unbuffered DIMM.
- Supports a maximum memory size of 256MB (8M x 8) or 512MB (16M x 4) registered DIMM only.
- Supports ECC(1-bit Error Code Correct) function.
- Supports 3.3v SDRAM DIMM.

Video

- ATI® RAGE 128VR/Rage XL/ Rage Pro
 - Running on AGP BUS.
 - Onboard 8MB SGRAM (optional 4MB).
 - 3D Acceleration.
 - AGP 2x mode (133MHz) support pipelined and sideband protocols.

System Hardware Monitor

- This can be used with Intel®LDCM to monitor system voltage, system temperature & fan rotation speed.
- This can also be used to monitor overall system status over the network.
- System temperature sensor: (TOP Tech)
 - detect Pentium®II processor's temperature.
- System voltage monitor:
 - monitor CPU core voltage, CPU interface voltage, 3.3v,±12v, ±5v, VBAT
- Fan speed monitor:
 - monitor control chassis fan, power fan & CPU cooling fan speed.

Power Management Features

- Doze/Standby/Suspend mode.
- System management mode compliant.
- Support APM 1.2.
- Meet ACPI spec.
- PC97/98 compliant.

Audio

- YAMAHA®YMF740C Audio Controller.
- Sound Blaster PRO Compatible.
- Support Plug and Play:
 - stereo 16-bit A/D
 - stereo 16-bit D/A
- Stereo enhancement support.
- Advanced power management.
- Maximum 32 voice xG capital wavetable.
- Synthesizer including GM compatible.

Network

- Intel®82559 10/100M Ethernet.
- WFW baseline & NET PC specs compliant.
- Advanced Power Management (ACPI support)
- Magic packet filtering to wake-up LAN.
- ARP & FLEXIBLE frame filtering.
- Software drivers are backwards compatible.
- IP checksumming in hardware.

Note: Requires an ATX power supply with 720mA 5VSB (5v Stand by).

Rear Mainboard Connectors

- PS/2 type keyboard/mouse connector.
- Two COM port connectors.
- One Printer port with SPP/EPP/ECP function.
- RJ-45 LAN connector.
- Audio connector
- VGA port

Dimension

- MICRO NLX Form Factor: 20.3cm(L) x 25.4cm(W) x 4 layers PCB.

Other Features

- Bulk Erase Flash ROM.
- Supports DMI.
- System Wake-up by modem.
- System Wake-up by alarm.
- Soft-power off. (Windows®95)
- Polyfuse function.
 - this function works when the electric current is larger than 2A. It will become an open circuit to protect your mainboard. Turn the power off for 1-3 secs for polyfuse to recover.
- LAN wake-up.
- Restore AC power loss status.

1.2 Mainboard Layout

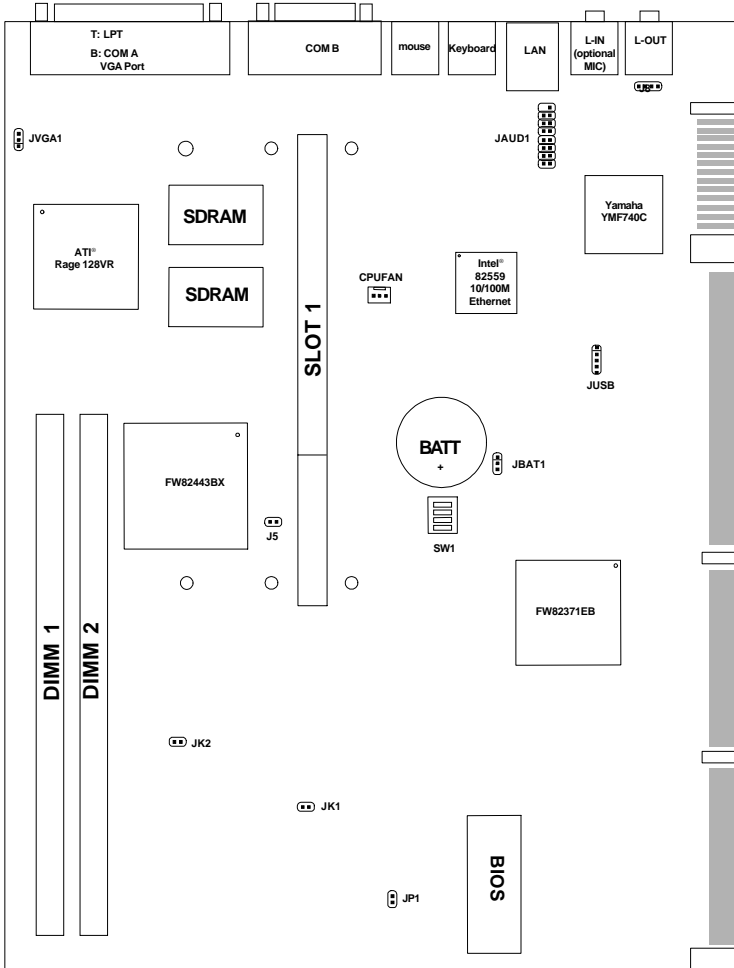

MS-6131 Micro NLX BX6 Mainboard

Chapter 2

HARDWARE INSTALLATION

2.1 Central Processing Unit: CPU

The mainboard operates with **Intel® Pentium® II processor with MMX™ technology**. The mainboard uses a CPU Slot called Slot 1 for easy CPU installation and a DIP switch (SW1) to set the proper speed for the CPU. The CPU should always have a Heat Sink and a cooling fan attached to prevent overheating.

2.1-1 CPU Installation Procedures

Different kinds of Pentium® II/III processor that is currently used: the OEM version, the Boxed version, and Celeron™. OEM Pentium® II/III Processor has no Heat Sink, Fan and Heat Sink Support, the Boxed Pentium® II/III Processor is provided with Heat Sink w/ fan and Heat Sink Support, while the Celeron™ processor is a plain processor card without cover or heatsink..

A. OEM Pentium® II/III processor Installation Procedure

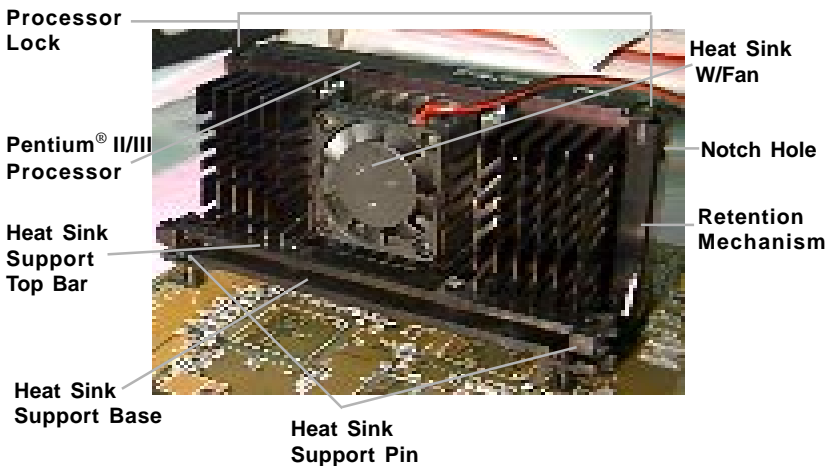

Required Things:

Pentium® II/III processor - Processor.

***Retention Mechanism(RM)** - Plastic Guide that holds the S.E.C. Cartridge/S.E.C.C. 2 in the Slot 1 connector.

***Retention Mechanism Attach Mount(RMAM)** - Bolt/Bridge assemblies inserted up through the bottom of the motherboard. RM secures to RMAM (2 RMAM required per RM).

***Heat Sink Support Base (HSSBASE)** - Plastic support bar mounted to the mainboard under the ATX heatsink.
(One leg is always bigger than the other one)

***Heat Sink Support Pin (HSSPIN)** - Plastic pins inserted through the HSSBASE to secure it to the mainboard (2 required per Assembly).

***Heat Sink Support Top Bar (HSSTOP)** - Plastic bar that clips onto the HSSBASE through the fins on the ATX heatsink.

****Heat Sink w/ fan** - Heat Sink that can be attached to the **Pentium® II/III processor** with metal clip.

Note: * Provided by MSI mainboard.

** Provided by Special request.

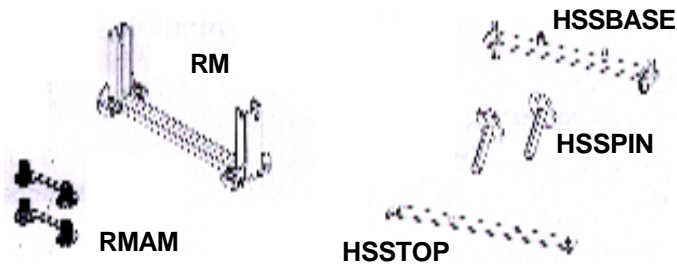

Step 1: Insert the Retention Mechanism Attach Mount at the bottom of the mainboard.

Step 2: Install the Retention Mechanism.

Look for the key on Slot 1, and match it with the Notch Key on the Retention Mechanism for proper direction. Then, attach the Retention Mechanism to the Retention Mechanism Attach Mount. Use a Screwdriver to secure the Retention Mechanism.

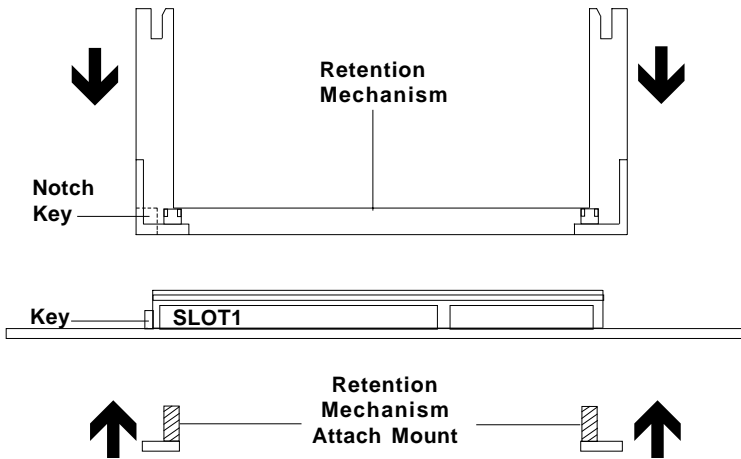

Step 3: Install the Heat Sink Support Base.

Look for the Two holes across Slot 1, and match it with the Two legs of the Heat Sink Support Base for the proper direction. Take note that one hole/leg is bigger than the other. The Four top pins of the Heat Sink Support Base should also be oriented towards Slot 1.

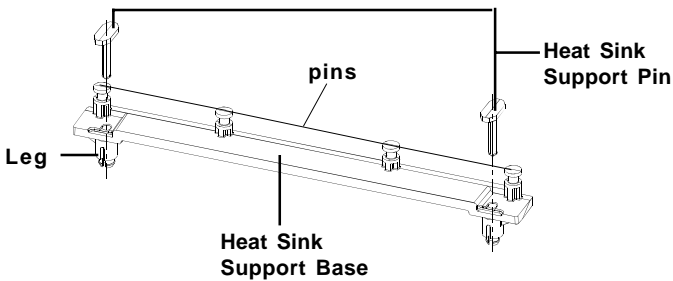

Push the Heat Sink Support Base onto the mainboard, until you hear a click sound. Check for a perfect fit.

Step 4: Install the Heat Sink Support Pin.

Push the Heat Sink Support Pins onto the two holes of the Heat Sink Support Base. Check for a perfect fit. These pins are used to secure the Heat Sink Support Base.

Step 5: Install the Heat Sink with Fan to the Processor.

Push down the metal clips, so that they are in line with the back of the Heat Sink. Be careful, so as not to detach the metal clips from the Heat Sink.

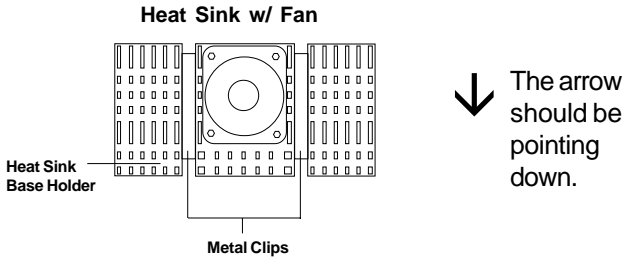

In case the metal clips are detached from the Heat Sink, re-attach them. Look for the arrow on the metal clip. This arrow should be pointing down and aligned with the Heat Sink Support Base Holder.

Attach the Heat Sink to the processor.

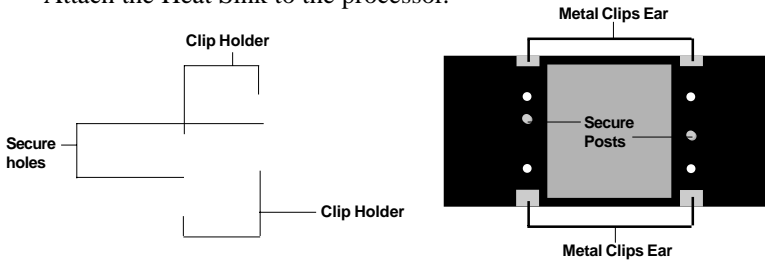

Pentium® II processor (Back)

Heat Sink w/ Fan(Back)

- Look at the back of the Heat Sink and take note of the 2 secure posts. Insert these 2 Secure posts to the 2 secure holes on the back of the processor.
- Align the ears of the metal clips with the clip holders on the back of the processor. Use a screw driver to push the metal clips onto the clip holders. Check for a perfect fit.

Step 6: Install the Processor.

Unlock the Processor by pushing in the Processor Locks.



Insert the Processor like inserting a PCI or an ISA card.

Step 7: Lock the Processor Locks.

Secure the CPU by pulling the Processor Locks out.

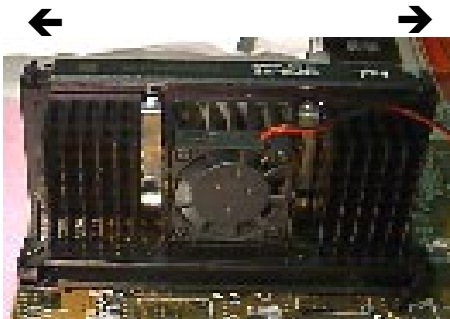

Step 8: Install the Heat Sink Support Top Bar.

Push the Heat Sink Support Top Bar to the Heat Sink Support Base, Until you hear a “click” sound. Check for a perfect fit.

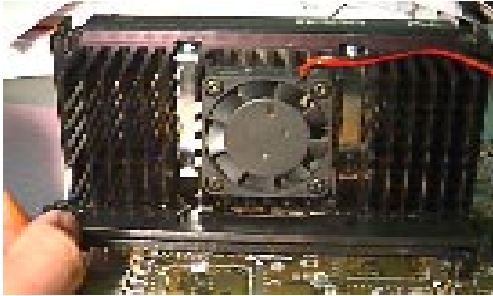

**Heatsink
Support Top
Bar**

The installation is now complete.

B. Boxed Pentium® II/III processor Installation Procedures

The Boxed Pentium® II/III processor has a built-in Fan and Heat Sink. It also has a Heat Sink Support. So if you're going to use the Boxed processor, all you need is the Retention Mechanism.

Step 1: Insert the Retention Mechanism Attach Mount at the bottom of the mainboard.

Step 2: Install the Retention Mechanism.

Look for the key on Slot 1, and match it with the Notch Key on the Retention Mechanism for proper direction. Then, attach the Retention Mechanism to the Retention Mechanism Attach Mount. Use a Screwdriver to secure the Retention Mechanism.

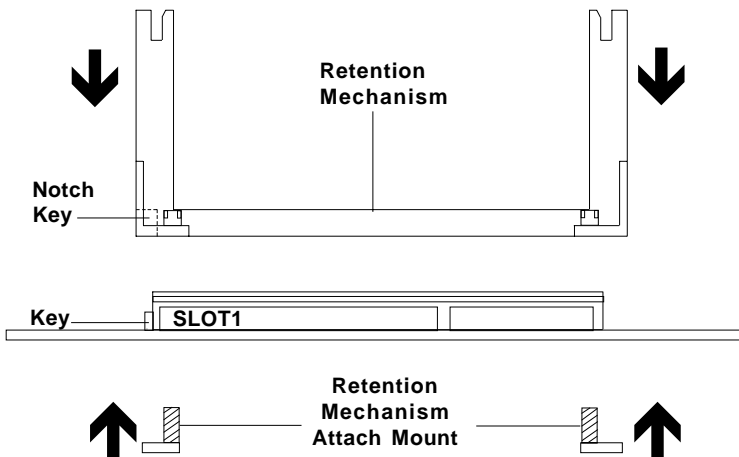

Step 3: Install the Heat Sink Support Base.

Look for the 2 holes across Slot 1, and match it with the 2 Heat Sink Support Base. Take note that one hole/base is bigger than the other.

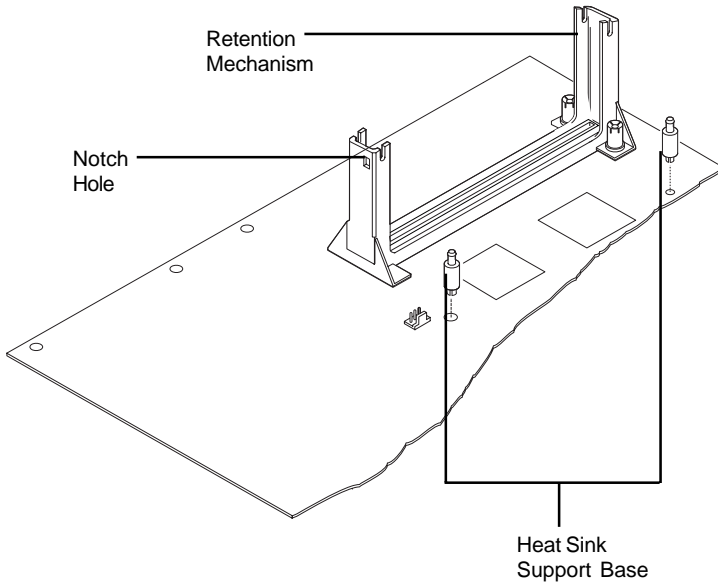

Push the Heat Sink Support Base onto the mainboard, until you hear a click sound. Check for a perfect fit.

Step 4: Install the Heat Sink Support.

Attach the 2 Heat Sink Supports to the sides of the Processor. These Heat Sink Supports will fit in any direction, so be sure that the Heat Sink Support Locks are oriented outwards for the proper direction.

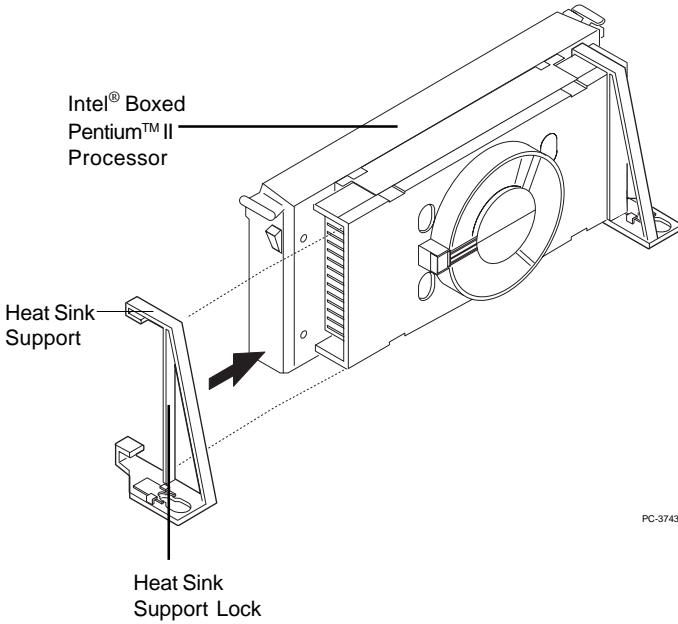

Step 5: Unlock the Processor Locks and Heat Sink Support Locks.

Push in the Processor Locks. Open the Heat Sink Support Locks.

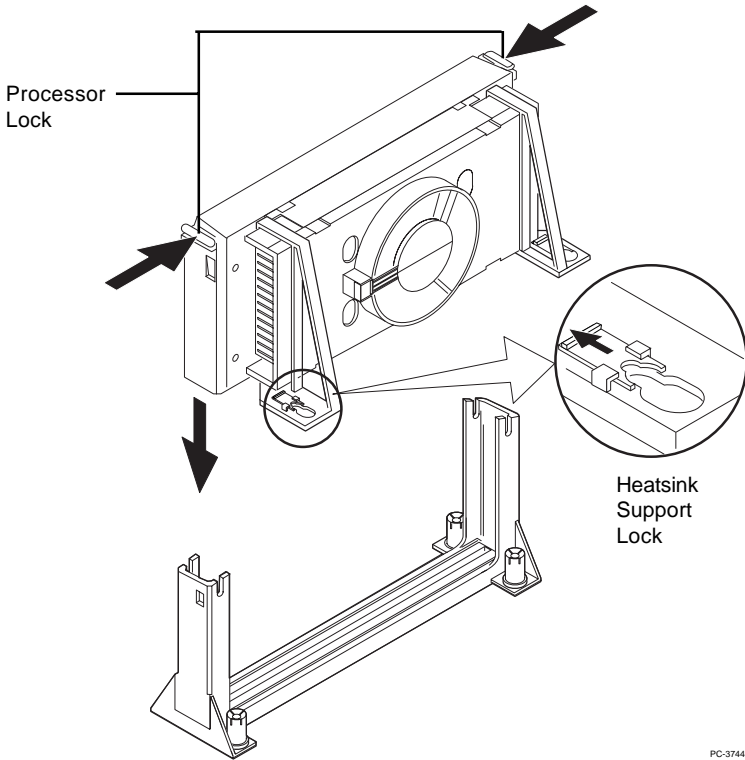

Step 6: Insert the Processor like inserting a PCI or an ISA card.

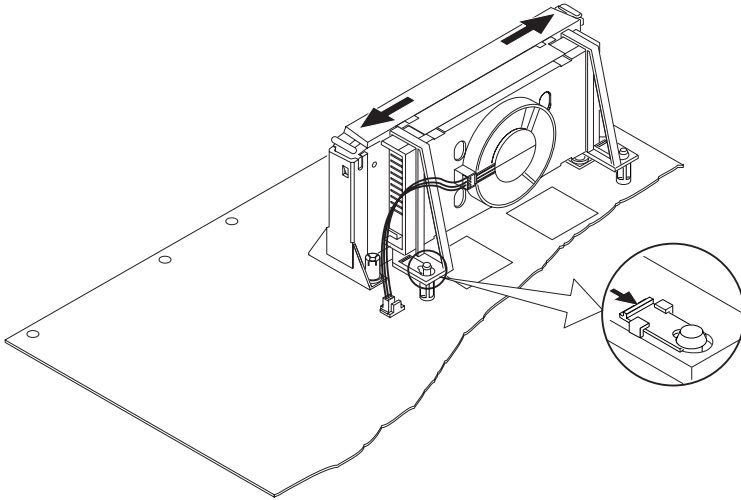

Step 7: Lock the Processor Locks and Heat Sink Support Locks

Secure the CPU by pushing out the Processor Locks. Close the Heat Sink Support Locks.

The installation is now complete.

C. OEM Celeron™ Processor and Pentium II (S.E.C.C. 2) processor Installation Procedures

Step 1: Insert the Retention Mechanism Attach Mount at the bottom of the mainboard.

Step 2: Install the Retention Mechanism.

Look for the key on Slot 1, and match it with the Notch Key on the Retention Mechanism for proper direction. Then, attach the Retention Mechanism to the Retention Mechanism Attach Mount. Use a Screwdriver to secure the Retention Mechanism.

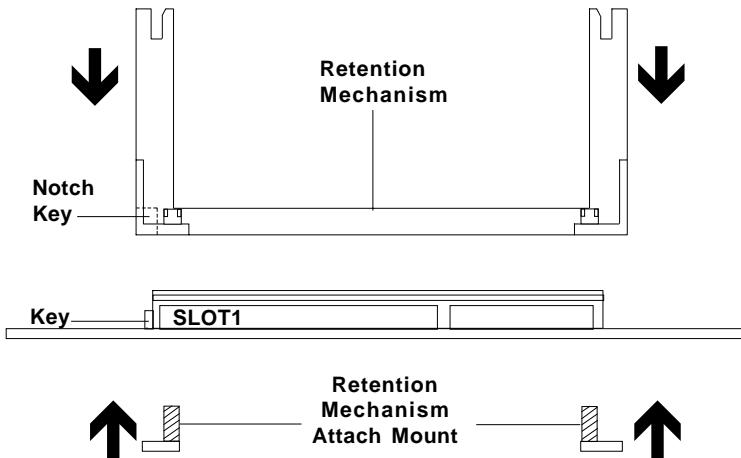

Step 3: Install the MSI Heat Sink (optional) to the Processor.

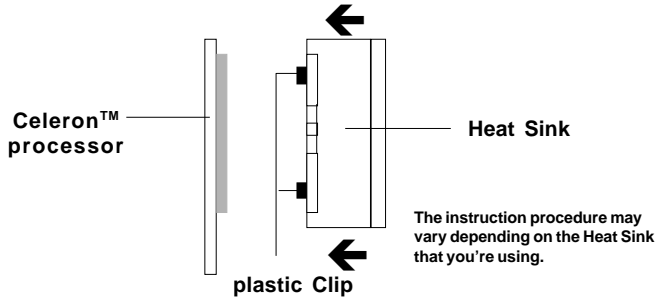

Push down the plastic clips, so that they are in line with the hole on the processor. Check for perfect fit.

Step 4: Install the Processor.

Insert the Processor like inserting a PCI or an ISA card.

Step 5: Lock the Processor.

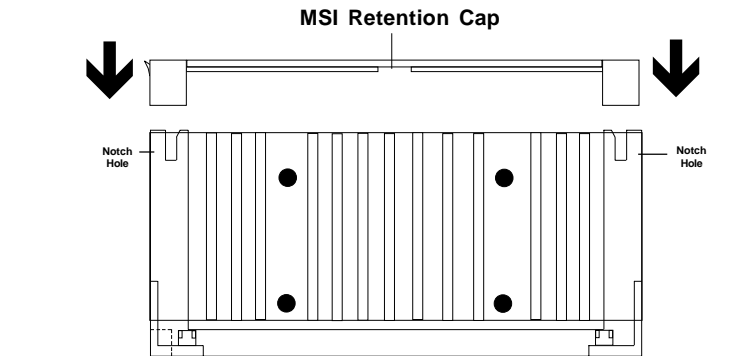

Lock the processor by putting the MSI Retention Cap provided. The MSI Retention Cap will only fit in one direction. The MSI Retention Cap is only used with Intel® Celeron™ processor and Intel® Pentium®II processor (S.E.C.C. 2).

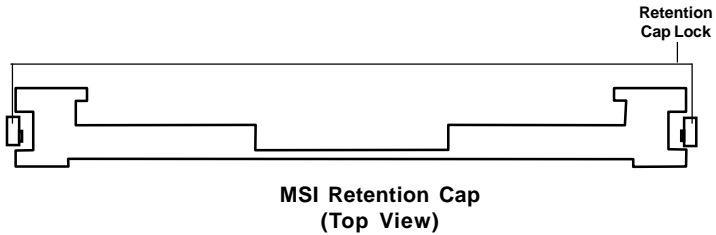
Procedure for detaching the MSI Retention Cap:

To remove the Retention Cap.

- Pull the the Retention Cap Lock outward.
- Pull one side upward at a time.

2.1-2 CPU Core Speed Derivation Procedure

- The DIP Switch SW1 (1, 2, 3, and 4) is used to set the Core/Bus (Fraction) ratio of the CPU. The actual core speed of the CPU is the Host Clock Frequency multiplied by the Core/Bus ratio. For example:

$$\begin{array}{lcl}
 \text{If} & \text{CPU Clock} & = 66\text{MHz}/100\text{MHz} \\
 & \text{Core/Bus ratio} & = 4 \\
 \text{then} & \text{CPU core speed} & = \text{Host Clock} \times \text{Core/Bus ratio} \\
 & & = 66\text{MHz} \times 4/100\text{MHz} \times 4 \\
 & & = 266\text{MHz}/400\text{MHz}
 \end{array}$$

SW1				CPU
1	2	3	4	Core/Bus Ratio
OFF	OFF	ON	OFF	1.5
OFF	OFF	OFF	OFF	2
ON	OFF	ON	ON	2.5
ON	ON	OFF	ON	3
ON	OFF	OFF	ON	3.5
ON	ON	ON	OFF	4
ON	OFF	ON	OFF	4.5
ON	ON	OFF	OFF	5
ON	OFF	OFF	OFF	5.5
OFF	ON	ON	ON	6
OFF	OFF	ON	ON	6.5
OFF	ON	OFF	ON	7
OFF	OFF	OFF	ON	7.5
OFF	ON	ON	OFF	8

2.1-3 CPU Speed Setting: SW1

To adjust the speed of the CPU, you must know the specifications of your CPU (*always ask the vendor for CPU spec.*). The mainboard can auto-detect between 66 or 100MHz CPU Bus Frequency.

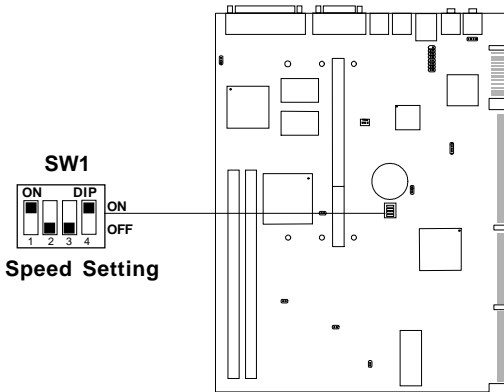



WARNINGS

The ATI RAGE 128VR/RAGE PRO Turbo onboard graphics controller should be disabled, when selecting over 100MHz processor BUS speed. The onboard graphics controller support only 66MHz/100MHz bus speed processor.

2.1-4 CPU Bus Frequency Selector: JK1

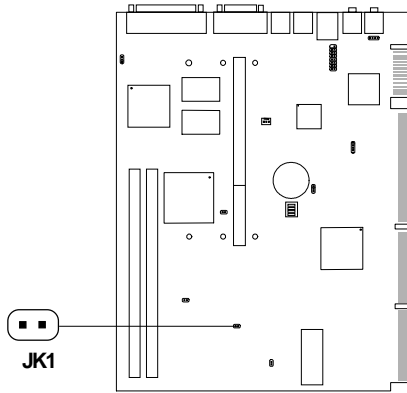
The JK1 jumper is used to set the CPU Bus Frequencies from 66MHz to 100MHz. When JK1 is shorted, this will automatically detect the CPU Bus Frequency. When JK1 is open, if you used 66MHz CPU Bus Frequency, this will set it Virtually into 100MHz.



JK1	Feature
	<p>Automatically detect 66MHz and 100MHz CPU Bus Frequency</p>
	<p>Virtually set 66MHz CPU Bus Frequency into 100MHz</p>





WARNINGS

If you used the JK1 jumper to set the procesor bus frequency, you need to disable the CPU Plug & Play feature on the BIOS.

2.1-5 AGP Bus Frequency Selector: JK2

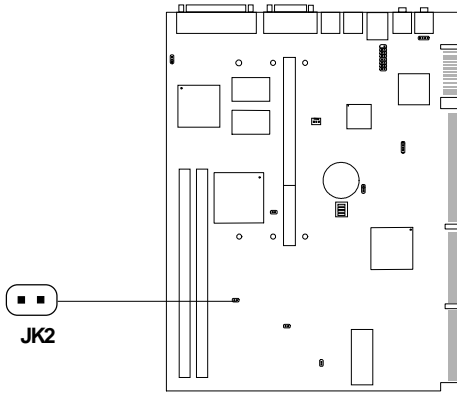
The JK2 jumper is used to set the AGP Bus Frequencies. When JK2 is shorted, the AGP Bus Frequency will be set to 66MHz. When JK2 is open, the AGP Bus Frequency will be the same with the CPU Bus Frequency.



JK2	Feature
	<p>66MHz AGP Bus Frequency</p>
	<p>The AGP will have same Bus Frequency with the processor</p>

a. 66MHz CPU Bus Frequency







CPU Type	SW1
200MHz	
233MHz	
266MHz	
300MHz	
333MHz	
400MHz	
433MHz	

Table 2.1 200 ~ 333MHz Intel® Pentium® II/Celeron™ processor

b. 100MHz CPU Bus Frequency







CPU Type	SW1
350MHz	
400MHz	
450MHz	
500MHz	
550MHz	
600MHz	

Table 2.2 350 ~ 450MHz Intel® Pentium® II processor

2.1-6 Fan Power Connector: CPUFAN

This connector support system cooling fan with +12V. It supports three pin head connector. When connecting the wire to the connector, always take note that the red wire is the positive and should be connected to the +12V, the black wire is Ground and should be connected to GND. If your mainboard had a System Hardware Monitor chipset on-board, you must use a specially designed fan with speed sensor to take advantage of the CPU fan control.

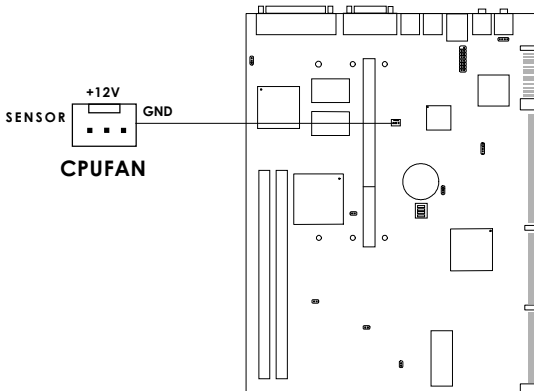

Note: For fans with speed sensor, every rotation of the fan will send out 2 pulses. System Hardware monitor will count and report the fan rotation speed.

2.2 Clear CMOS Jumper: JBAT1

A battery must be used to retain the mainboard configuration in CMOS RAM. If you use the on-board battery, you must short 1-2 pins of JBAT1 to keep the CMOS data.

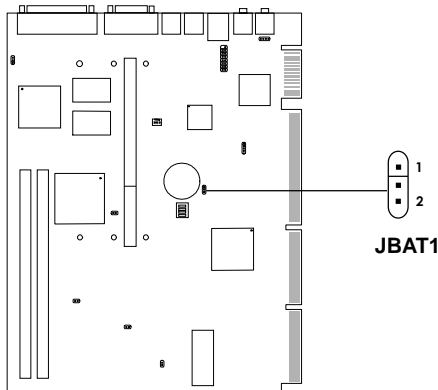

JBAT1	Function
	Keep Data
	Clear Data

Note: You can clear CMOS by shorting 2-3 pin, while the system is off. Then, return to 1-2 pin position. To be able to clear the CMOS, you need to unplug the power plug of the system, because there's a 3V standby power for PIIX4E chipset which is provided by the power supply. Otherwise, the CMOS will not be cleared.

2.3 Power On Mode Jumper: JP1

The mainboard supports two kinds of system power on: the Boot-Up by switch and the Immediate Boot-Up. With the Boot-Up by Switch, the system will boot up only when the power on switch is pressed. For Immediate Boot-Up, the system will boot up instantly when the power connector is connected into the system.

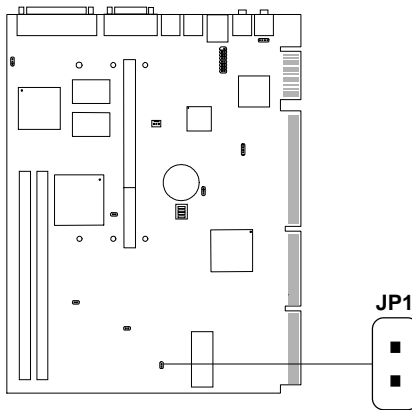



Table 2.3: Power On Mode Feature

JP1	Feature
	Select Boot-Up by Switch
	Select Immediate Boot-Up

Note: Short **JP1**, when using Boot-Up by Switch feature. Open **JP1**, to enable Immediate Boot-Up.

2.4 Memory Installation

2.4-1 Memory Bank Configuration

The mainboard supports a maximum of 512MB of memory : It provides two 168-pin DIMMs (Double In-Line Memory Module) sockets. It supports 8 MB to 256 Mbytes DIMM memory module. The memory module can only support SDRAM(Synchronous DRAM) MODE DRAM.

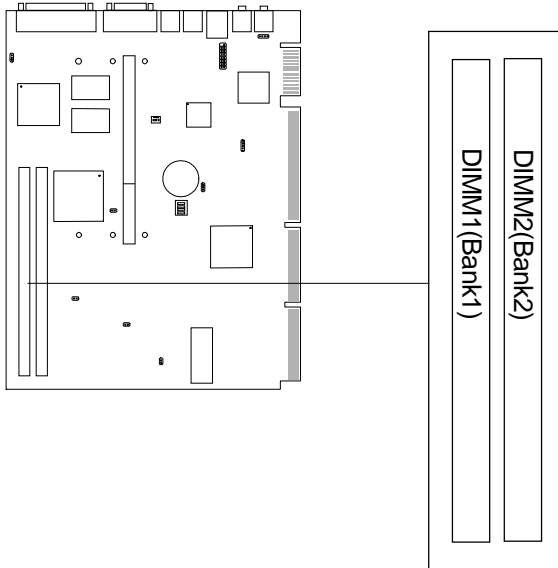

WARNING!

There are two kinds of DIMM specification supported by this mainboard: PC100 and PC66. If you use 66MHz CPU Bus Frequency, these two DIMM Specs. is supported. If you use 100 MHz CPU Bus Frequency, only PC100 DIMM Specs. is supported.

2.4-2 Memory Installation Procedures:

A. How to install a DIMM Module

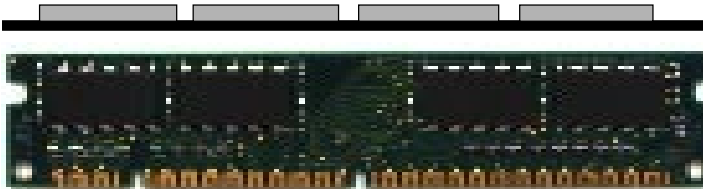

Single Sided DIMM

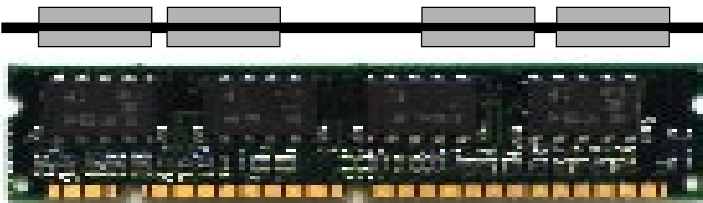

Double Sided DIMM

1. The DIMM slot has a two Notch Key “VOLT and DRAM”, so the DIMM memory module can only fit in one direction.
2. Insert the DIMM memory module vertically into the DIMM slot. Then push it in.

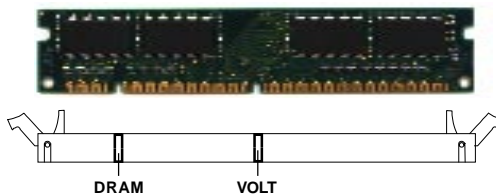

3. The plastic clip at the side of the DIMM slot will automatically close.

2.4-3 Memory Population Rules

1. Supports SDRAM DIMM.
2. To operate properly, at least one 168-pin DIMM module must be installed.
3. This mainboard supports Table Free memory, so memory can be installed on DIMM1 or DIMM 2 in any order.
4. Supports 3.3 volt DIMM.
5. The DRAM addressing and the size supported by the mainboard is shown below:

Table 2.4-1 SDRAM Memory Addressing

DRAM Tech.	DRAM Density & Width	DRAM Addressing	Address Size		MB/DIMM	
			Row	Column	Single Side(S)	Double Side(D)
16M	1Mx16	ASYM	12	8	8MB	16MB
	2Mx8	ASYM	12	9	16MB	32MB
	4Mx4	ASYM	12	10	32MB	64MB
64M	2Mx32	ASYM	12	9	32MB	64MB
	2Mx32	ASYM	13	8	16MB	32MB
	4Mx16	ASYM	12	10	32MB	64MB
	4Mx16	ASYM	14	8	32MB	64MB
	8Mx8	ASYM	14	9	64MB	128MB
	16Mx4	ASYM	14	10	128MB	256MB

Note: * Both 4M x 4 and 16M x 4 SDRAM device are supported in the form of registered DIMM only.

* If you used the mainboard onboard VGA, you need to install at least 32MB of SDRAM.

2.5 Serial Port Connector: COM A & COM B

The mainboard provides two 9-pin male DIN connectors for serial port COM A and COM B. These ports are 16550A high speed communication ports that send/receive 16 bytes FIFOs. You can attach a mouse or a modem cable directly into this connector.

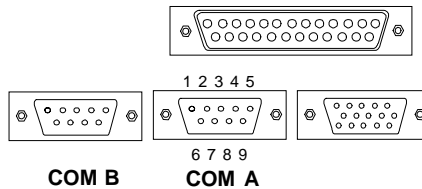

PIN DEFINITION

PIN	SIGNAL
1	DCD (Data Carry Detect)
2	SIN (Serial In or Receive Data)
3	SOUT (Serial Out or Transmit Data)
4	DTR (Data Terminal Ready)
5	GND
6	DSR (Data Set Ready)
7	RTS (Request To Send)
8	CTS (Clear To Send)
9	RI (Ring Indicate)

2.6 VGA DB 15 Pin Connector

The mainboard provides a DB 15-pin connector to connect to a VGA monitor.

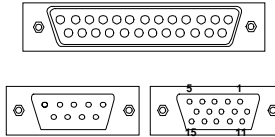

VGA

Analog Video Display Connector(DB15-S)	
Pin	Signal Description
1	Red
2	Green
3	Blue
4	Not used
5	Ground
6	Ground
7	Ground
8	Ground
9	Not used
10	Ground
11	Not used
12	SDA
13	Horizontal Sync
14	Vertical Sync
15	SCL

2.7 Parallel Port Connector: LPT

The mainboard provides a 25 pin female centronic connector for LPT. A parallel port is a standard printer port that also supports Enhanced Parallel Port(EPP) and Extended capabilities Parallel Port(ECP). See connector and pin definition below:

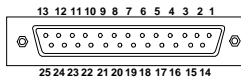

LPT

PIN DEFINITION

PIN	SIGNAL	PIN	SIGNAL
1	STROBE	14	AUTO FEED#
2	DATA0	15	ERR#
3	DATA1	16	INIT#
4	DATA2	17	SLIN#
5	DATA3	18	GND
6	DATA4	19	GND
7	DATA5	20	GND
8	DATA6	21	GND
9	DATA7	22	GND
10	ACK#	23	GND
11	BUSY	24	GND
12	FE	25	GND
13	SELECT		

2.8 Mouse Connector

The mainboard provides a standard PS/2[®] mouse mini DIN connector for attaching a PS/2[®] mouse. You can plug a PS/2[®] mouse directly into this connector. The connector location and pin definition are shown below:

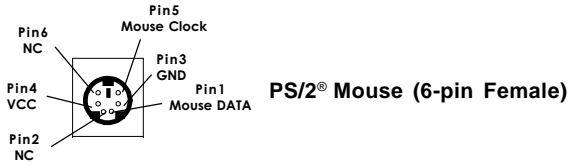

2.9 Keyboard Connector

The mainboard provides a standard PS/2[®] keyboard mini DIN connector for attaching a keyboard. You can plug a keyboard cable directly to this connector.

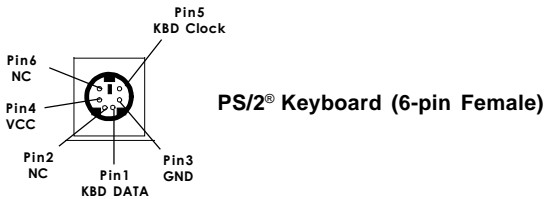

2.10 LAN Connector

The mainboard provides a RJ-45 connector for your network need.

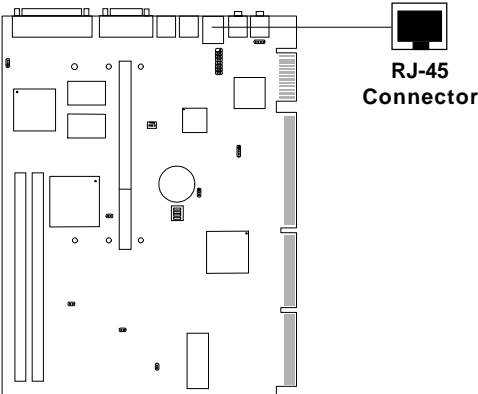

2.11 Audio Port Connectors

Line Out is a connector for Speakers or Headphones. **Line In** is used for external CD player, Tape player, or other audio devices.

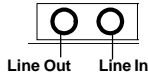

1/8" Stereo Audio Connectors

2.12 CPU Temperature Sensor: J6 (optional)

This is used to check the CPU temperature. The J6 is a sensor that is placed near the processor heatsink. This will monitor the CPU temperature.

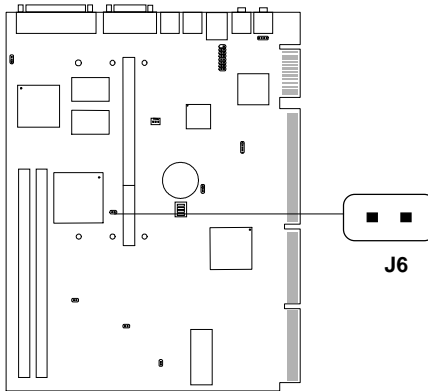

2.13 Onboard VGA Disable/Enable Jumper: JVGA1

If your mainboard supports onboard VGA, this jumper is used to disable the onboard VGA.

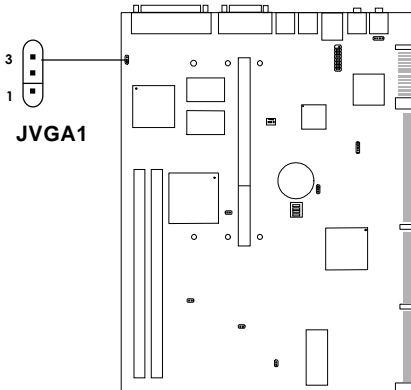

JVGA1	Function
	Enable Onboard VGA
	Disable Onboard VGA

2.14 Joystick/Midi Connector: JAUD1

You can connect MIDI keyboard, joystick or game pads to this connector.

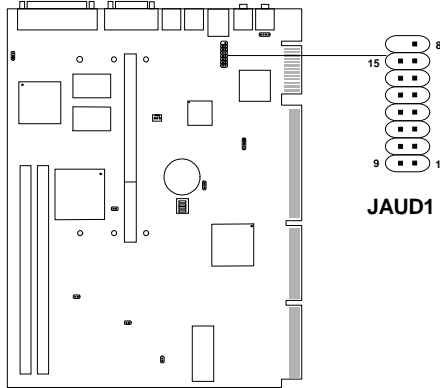

PIN	SIGNAL
1	+5v
2	Joystick But0
3	Joystick X1
4	GND
5	GND
6	Joystick Y1
7	Joystick But1
8	+5v
9	+5v
10	Joystick But2
11	Joystick X2
12	Midi Out
13	Joystick Y2
14	Joystick But3
15	Midi In

2.15 AUX Line In Connector: J AUX1

This connector is used for DVD Add on Card with Line In connector.

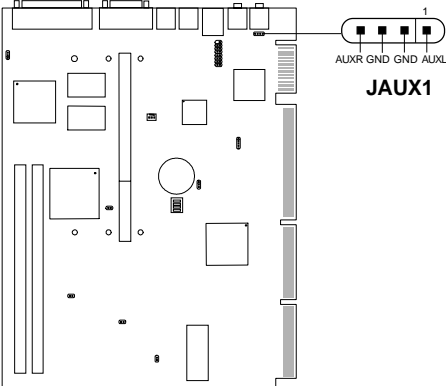

2.16 Optional USB Connector: JUSB1

This connector is designed for user who need an optional USB connector. This can be connected with USB Port.

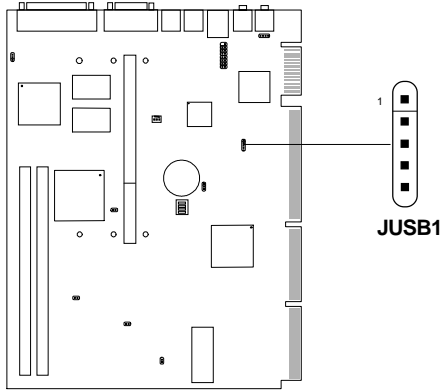

PIN	SIGNAL
1	VCC
2	D-
3	D+
4	Key
5	GND

Chapter 3

AWARD® BIOS SETUP

Award® BIOS ROM has a built-in Setup program that allows users to modify the basic system configuration. This type of information is stored in battery-backed RAM (CMOS RAM), so that it retains the Setup information when the power is turned off.

3.1 Entering Setup

Power on the computer and press immediately to allow you to enter Setup. The other way to enter Setup is to power on the computer. When the below message appears briefly at the bottom of the screen during the POST (Power On Self Test), press key or simultaneously press <Ctrl>, <Alt>, and <Esc> keys.

TO ENTER SETUP BEFORE BOOT PRESS <CTRL-ALT-ESC>
OR KEY

If the message disappears before you respond and you still wish to enter Setup, restart the system to try again by turning it OFF then ON or pressing the “RESET” button on the system case. You may also restart by simultaneously pressing <Ctrl>, <Alt>, and <Delete> keys. If you do not press the keys at the correct time and the system does not boot, an error message will be displayed and you will again be asked to,

PRESS <F1> TO CONTINUE, <CTRL-ALT-ESC>
OR TO ENTER SETUP

3.2 Getting Help

Main Menu

The on-line description of the highlighted setup function is displayed at the bottom of the screen.

Status Page Setup Menu/Option Page Setup Menu

Press F1 to pop up a small help window that describes the appropriate keys to use and the possible selections for the highlighted item. To exit the Help Window press <F1> or <Esc>.

3.3 The Main Menu

Once you enter Award® BIOS CMOS Setup Utility, the Main Menu (Figure 1) will appear on the screen. The Main Menu allows you to select from eleven setup functions and two exit choices. Use arrow keys to select among the items and press <Enter> to accept or enter the sub-menu.

```

ROM PCI/ISA BIOS (2A69KM4A)
  CMOS SETUP UTILITY
  AWARD SOFTWARE, INC.

```

STANDARD CMOS SETUP	SPECIAL FEATURES SETUP
BIOS FEATURES SETUP	INTEGRATED PERIPHERALS
CHIPSET FEATURES SETUP	SUPERVISOR PASSWORD
POWER MANAGEMENT SETUP	USER PASSWORD
PNP/PCI CONFIGURATION	IDE HDD AUTO DETECTION
LOAD SETUP DEFAULTS	SAVE & EXIT SETUP
	EXIT WITHOUT SAVING
Esc : Quit	↑↓←→ : Select Item
F10 : Save & Exit Setup	(Shift)F2 : Change Color
Time, Date, Hard Disk Type...	

Standard CMOS Setup

This setup page includes all the items in a standard compatible BIOS.

BIOS Features Setup

This setup page includes all the items of Award special enhanced features.

Chipset Features Setup

This setup page includes all the items of chipset special features.

Power Management Setup

This category determines the power consumption for system after setting the specified items. Default value is Disable.

PCI Configuration Setup

This category specifies the IRQ level for PCI and ISA devices.

Supervisor Password/User Password

Change, set or disable password. This function allows the user access to the system and setup or just setup.

Load Setup Defaults

Chipset defaults indicates the values required by the system for the maximum performance.

Special Features Setup

This function is reserved for Special Hardware Monitor controller function.

IDE HDD Auto Detection

Automatically configures hard disk parameters.

Save & Exit Setup

Save CMOS value changes to CMOS and exit setup.

Exit Without Saving

Abandon all CMOS value changes and exit setup.

3.4 Standard CMOS Setup

The items in Standard CMOS Setup Menu are divided into 10 categories. Each category includes no, one or more than one setup items. Use the arrow keys to highlight the item and then use the <PgUp> or <PgDn> keys to select the value you want in each item.

ROM PCI/ISA BIOS (2A69KM4A)
STANDARD CMOS SETUP
AWARD SOFTWARE, INC.

Date(mm:dd:yy): Wed, Oct 28,1998							
Time(hh:mm:ss): 00:00:00							
HARD DISKS	TYPE	SIZE	CYLS	HEADS	PRECOMP	LANDZONE	SECTOR MODE
Primary Master:	Auto	0	0	0	0	0	AUTO
Primary Slave :	Auto	0	0	0	0	0	AUTO
Secondary Master :	Auto	0	0	0	0	0	AUTO
Secondary Slave :	Auto	0	0	0	0	0	AUTO
Drive A :	1.44M,3.5in.			Base Memory:		640K	
Drive B :	None			Extended Base Memory:		15360K	
Video :	EGA/VGA			Other Memory:		384K	
Halt On :	All, but Keyboard			Total Memory:		16384K	
ESC : Quit ↑↓→← : Select Item PU/PD/+/- : Modify F1 : Help (Shift)F2 : Change Color							

Date

The date format is <day><month> <date> <year>.

Day	Day of the week, from Sun to Sat, determined by BIOS. Read-only.
month	The month from Jan. through Dec.
date	The date from 1 to 31 can be keyed by numeric function keys.
year	The year, depends on the year of the BIOS

Time

The time format is <hour> <minute> <second>.

**PrimaryMaster/PrimarySlave
SecondaryMaster/Secondary Slave**

These categories identify the types of 2 channels that have been installed in the computer. There are 45 pre-defined types and 4 user definable types for Enhanced IDE BIOS. Type 1 to Type 45 are pre-defined. Type User is user-definable.

Press PgUp/<+> or PgDn/<-> to select a numbered hard disk type or type the number and press <Enter>. Note that the specifications of your drive must match with the drive table. The hard disk will not work properly if you enter improper information for this category. If your hard disk drive type is not matched or listed, you can use Type User to define your own drive type manually.

If you select Type User, related information is asked to be entered to the following items. Enter the information directly from the keyboard and press <Enter>. This information should be provided in the documentation from your hard disk vendor or the system manufacturer.

If the controller of HDD interface is ESDI, the selection shall be
“Type 1”.

If the controller of HDD interface is SCSI, the selection shall be
“None”.

If the controller of HDD interface is CD-ROM, the selection shall be
“None”.

CYLS.	number of cylinders
HEADS	number of heads
PRECOMP	write precom
LANDZONE	landing zone
SECTORS	number of sectors
MODEHDD	access mode

3.5 BIOS Features Setup

ROM PCI/ISA BIOS (2A69KM4A)
 BIOS FEATURES SETUP
 AWARD SOFTWARE, INC.

Anti-Virus Protection	: Disabled	Video BIOS Shadow	: Enabled
CPU Internal Cache	: Enabled		
External Cache	: Enabled		
CPU L2 Cache ECC Checking:	Enabled		
Quick Power on Self Test	: Disabled		
Boot From LAN First	: Disabled		
Boot Sequence	: A,C,SCSI		
Swap Floppy Drive	: Disabled		
Boot Up Floppy Seek	: Enabled		
Floppy FIFO Control	: Disabled		
Boot up NumLock status	: On		
Gate A20 Option	: Fast		
Security Option	: Setup		
PCI/VGA palette snoop	: Disabled		
OS select for DRAM>64MB	: Non-OS2		
Report No FDD For WIN 95	: Yes		
		Esc : Quit	↑↓←→ : Select item
		F1 : Help	PU/PD/+/- : modify
		F5 : Old Value(Shift)	F2 : Color
		F7 : Load Setup Defaults	

Anti-Virus Protection

During and after the system boots up, any attempt to write to the boot sector or partition table of the hard disk drive will halt the system and the following error message will appear. For the meantime, you can run an anti-virus program to locate the problem. The settings are either Enabled or Disabled.

!WARNING!

Disk Boot Sector is to be modified
 Type "Y" to accept write or "N" to abort write
 Award Software, Inc.

Disabled (default)	No warning message to appear when anything attempts to access the boot sector or hard disk partition table.
Enabled	Activates automatically when the system boots up causing a warning message to appear when anything attempts to access the boot sector of hard disk partition table.

Note: *This function is available only for DOS and other OS that do not trap INT13.*

CPU Internal Cache

The default value is Enabled.

Enabled (default)	Enable cache
Disabled	Disable cache

Note: The internal cache is built in the processor.

External Cache

Choose Enabled or Disabled. This option enables the level 2 cache memory.

CPU L2 Cache ECC Checking

Choose Enabled or Disabled. This option enables the level 2 cache memory ECC(error check correction). Using 66MHz CPU BUS Deschutes processor, set to Enabled or Disabled. Using 100MHz CPU BUS Deschutes processor, always set to Enabled. For Klamath processor, always set to Disabled.

Quick Power On Self Test

This category speeds up Power On Self Test (POST) after you power on the computer. If this is set to Enabled, BIOS will shorten or skip some check items during POST.

Enabled	Enable quick POST
Disabled (default)	Normal POST

Boot From LAN First

During Enabled, if there's a LAN card onboard, the priority of booting will be from the LAN.

Boot Sequence

This category determines which drive the computer searches first for the disk operating system (i.e., DOS). The settings are A,C,SCSI/C,A,SCSI/C,CD-ROM,A/CD-ROM,C,A/D,A,SCSI/E,A,SCSI/F,A,SCSI/SCSI,A,C/SCSI,C,A/C only. Default value is A,C,SCSI.

Swap Floppy Drive

Switches the floppy disk drives between being designated as A and B. Default is Disabled.

Boot Up Floppy Seek

During POST, BIOS will determine if the floppy disk drive installed is 40 or 80 tracks. 360K type is 40 tracks while 760K, 1.2M and 1.44M are all 80 tracks.

Floppy FIFO Control

During Enabled, the FDD disk will perform better.

Boot Up NumLock Status

The default value is On.

On (default) Keypad is numeric keys.

Off Keypad is arrow keys.

Gate A20 Option

Normal The A20 signal is controlled by keyboard controller or chipset hardware.

Fast(default) The A20 signal is controlled by port 92 or chipset specific method.

Security Option

This category allows you to limit access to the system and Setup, or just to Setup.

System	The system will not boot and access to Setup will be denied if the correct password is not entered at the prompt.
Setup(default)	The system will boot, but access to Setup will be denied if the correct password is not entered at the prompt.

PCI VGA Palette Snooping

Choose Disabled or Enabled. Some graphic controllers which are not VGA compatible, take the output from a VGA controller and map it to their display as a way to provide the boot information and the VGA compatibility.

However, the color information coming from the VGA controller is drawn from the palette table inside the VGA controller to generate the proper colors, and the graphic controller needs to know what is in the palette of the VGA controller. To do this, the non-VGA graphic controller watches for the Write access to the VGA palette and registers the snoop data. In PCI based systems, where the VGA controller is on the PCI bus and a non-VGA graphic controller is on an ISA bus, the Write Access to the palette will not show up on the ISA bus if the PCI VGA controller responds to the Writes.

In this case, the PCI VGA controller should not respond to the Write. It should only snoop the data and permit the access to be forwarded to the ISA bus. The non-VGA ISA graphic controller can then snoop the data on the ISA bus. Unless you have the above situation, you should disable this option.

Disabled (default)	Disables the function
Enabled	Enables the function

OS Selection for DRAM > 64MB

Allows OS2® to be used with > 64 MB of DRAM. Settings are Non-OS/2 (default) and OS2. Set to OS/2 if using more than 64MB and running OS/2®.

Report No FDD For WIN 95

This function is only used when you are testing SCT for Windows® 95 Logo.

Video BIOS Shadow

Determines whether video BIOS will be copied to RAM for faster execution. Video shadow will increase the video performance.

Enabled (default)

Video shadow is enabled

Disabled

Video shadow is disabled

3.6 Chipset Features Setup

The Chipset Features Setup option is used to change the values of the chipset registers. These registers control most of the system options in the computer.

Choose the “CHIPSET FEATURES SETUP” from the Main Menu and the following screen will appear.

ROM PCI/ISA BIOS(2A69KM4A)
CMOS SETUP UTILITY
CHIPSET FEATURES SETUP

SDRAM RAS-to-CAS Delay :3	Spread Spectrum Modulated :Enabled
SDRAM RAS Precharge TIME :3	
SDRAM CAS Latency Time :3	
DRAM Data Integrity Mode :Non-ECC	
System BIOS Cacheable :Disabled	
Video BIOS Cacheable :Disabled	
Video RAM Cacheable :Disabled	
8 Bit I/O Recovery Time :1	
16 Bit I/O Recovery Time :1	
Memory Hole at 15M-16M :Disabled	
Passive Release :Enabled	
Delayed Transaction :Enabled	
AGP Aperture Size (MB) :64	
	Esc : Quit ↑↓←→ : Select item
	F1 : Help PU/PD/+/- : modify
	F5 : Old Value(Shift) F2 : Color
	F7 : Load Setup Defaults

Note: Change these settings only if you are familiar with the chipset.

SDRAM RAS-To-CAS Delay

You can select the RAS-to-CAS delay time for SDRAM in HCLKs of 2 or 3 (default). Setting the value in the field should depend on the SDRAM installed.

SDRAM RAS-To-CAS Delay

You can select the RAS-to-CAS delay time for SDRAM in HCLKs of 2 or 3 (default). Setting the value in the field should depend on the SDRAM installed.

SDRAM CAS Latency Time

You can select CAS latency time in HCLKs of 2 or 3. The system board designer should set the values in this field, depending on the DRAM installed.

DRAM Data Integrity Mode

Select Non-ECC or ECC(error-correcting code), according to the type of installed DRAM. The settings are Non-ECC or ECC.

System BIOS Cacheable

Select Enabled to allow caching of the system BIOS ROM at F000h-FFFFh, resulting in better system performance. However, if any program writes to this memory area, a system error may result.

Enabled	BIOS access cached
Disabled	BIOS access not cached

Video BIOS Cacheable

Select Enabled to allow caching of the system BIOS ROM at C0000h-F7FFFh, resulting in better video performance. However, if any program writes to this memory area, a system error may result.

Enabled	Video BIOS access cached
Disabled	Video BIOS access not cached

Video RAM Cacheable

Select Enabled allows caching of the video RAM, resulting in better system performance. However, if any program writes to this memory area, a system error may result.

8 Bit I/O Recovery Time

The recovery time is the length of time, measured in CPU clocks, which the system will delay after the completion of an input/output request. This delay takes place because the CPU is operating so much faster than the input/output bus that the CPU must be delayed to allow for the completion of the I/O.

This items allows you to determine the recovery time allowed for 8 bit I/O. Choices are from NA, 1 to 8 CPU clocks.

16 Bit I/O Recovery Time

This items allows you to determine the recovery time allowed for 16 bit I/O. Choices are from NA, 1 to 4 CPU clocks.

Memory Hole At 15M-16M

In order to improve performance, certain space in memory can be reserved for ISA cards. This memory must be mapped into the memory space below 16 MB.

Enabled	Memory hole supported.
Disabled	Memory hole not supported.

Passive Release

When Enabled, CPU to PCI bus accesses are allowed during passive release. Otherwise, the arbiter only accepts another PCI master access to local DRAM. The settings are Enabled or Disabled.

Delayed Transaction

The chipset has an embedded 32-bit posted write buffer to support delay transactions cycles. Select Enabled to support compliance with PCI specification version 2.1. The settings are Enabled or Disabled.

AGP Aperture Size (MB)

Select the size the of the Accelerated Graphics Port (AGP) aperture. The aperture is a portion of the PCI memory address range dedicated for graphics memory address space. Host cycles that hit the aperture range are forwarded to the AGP without any translation.

3.7 Power Management Setup

The Power Management Setup will appear on your screen like this:

```
ROM PCI/ISA BIOS (2A69KM4A)
POWER MANAGEMENT SETUP
AWARD SOFTWARE, INC.
```

ACPI Function	:Enabled	Restore AC/Power Loss	:Power On
Power Management	:User Define	IRQ 8 Clock Event	:Disabled
PM Control by APM	:Yes	** Reload Global Timer Events **	
Video Off Method	:DPMS	IRQ [3-7,9-15],NMI	: Disabled
Video Off After	:Standby	Primary IDE 0	: Enabled
Modem Use IRQ	:3	Primary IDE 1	: Enabled
Doze Mode	:Disable	Secondary IDE 0	: Disabled
Standby Mode	:Disable	Secondary IDE 1	: Disabled
Suspend Mode	:Disable	Floppy Disk	: Disabled
HDD Power Down	:Disable	Serial Port	: Enabled
Throttle Duty Cycle	:62.5%	Parallel Port	: Disabled
VGA Active Monitor	:Enabled		
Soft-Off by PWR-BTTN	:Instant-Off		
CPUFAN off in Suspend	:Enabled		
Resume by Ring	:Disabled		
Resume by Alarm	:Disabled		
Date(of Month) Alarm	:2		
Time(hh:mm:ss) Alarm	:0:0:0		
Wake Up On LAN	: Enabled		
		Esc : Quit ↑↓→←: Select item	
		F1 : Help PU/PD+/- : modify	
		F5 : Old Value(Shift) F2 : Color	
		F7 : Load Setup Defaults	

Power Management

This category determines the power consumption for system after selecting below items. Default value is Disable. The following pages tell you the options of each item & describe the meanings of each options.

ACPI Function

During Enabled, this will support ACPI function.

Power Management

Disable	Global Power Management will be disabled.
User Define	Users can configure their own power management.
Min Saving	Pre-defined timer values are used such that all timers are in their MAX value.
Max Saving	Pre-defined timer values are used such that all timers are in their MIN value.

PM Control by APM

No	System BIOS will ignore APM when power managing the system.
Yes	System BIOS will wait for APM's prompt before it enter any PM mode

Note :Enable this for O.S. with APM like Windows®95, Windows®NT, etc.

Video Off Method

Blank Screen	The system BIOS will only blank off the screen when disabling video.
V/H SYNC+Blank	In addition to (1), BIOS will also turn off the V-SYNC & H-SYNC signals from VGA card to monitor.
DPMS	This function is enabled only for VGA card supporting DPMS.

Note: Green monitors detect the V/H SYNC signals to turn off its electron gun.

Video Off After

The settings are N/A, Standby, Doze, or Suspend. This option is for choosing the setting in which the monitor will turn off.

- N/A** Always turn on.
 - Doze** During Doze mode, the monitor will be turned off.
 - Standby** During Standby mode, the monitor will be turned off.
 - Suspend** During Suspend mode, the monitor will be turned off.
- The default setting is Standby.

MODEM Use IRQ

Name the interrupt request (IRQ) line assigned to the modem (if any) on your system. Activity of the selected IRQ always awakens the system. The settings are NA, 3, 4, 5, 7, 9, 10, or 11.

Doze Mode

- Disable** System will never enter DOZE mode.
 - 1 Min/2 Min/** Defines the continuous idle time before the
 - 4 Min/8 Min/** system enters DOZE mode.
 - 12 Min/20 Min/** If any item defined in the options of “Power
 - 30 Min/40 Min/** Down and Resume events” is enabled & active,
 - 1 Hr** DOZE timer will be reloaded. When the system
- have entered Doze mode, any of the items enabled in “Wake Up Events in Doze and Standby” will trigger the system to wake up.

Standby Mode**Disable**

System will never enter STANDBY mode.

1 Min/2 Min/

Defines the continuous idle time before the system enters STANDBY mode.

4 Min/8 Min/**12 Min/20 Min/****30 Min/40 Min/****1 Hr**

If any item defined in the options of “Power Down and Resume events” is enabled & active, STANDBY timer will be reloaded. When the system has entered Standby mode , any of the items that are enabled in “Wake Up Events of Doze and Standby” will trigger the system to wake up.

Suspend Mode**Disable**

System will never enter SUSPEND mode.

1 Min/2 Min/

Defines the continuous idle time before the system enters SUSPEND mode.

4 Min/8 Min/**12 Min/20 Min/****30 Min/40 Min/****1 Hr**

If any item defined in the options of “Power Down & Resume Events” is enabled & active, SUSPEND timer will be reloaded. When the system has entered SUSPEND mode, any of the items enabled in the “Power Down & Resume Events” will trigger the system to wake up.

HDD Power Down**Disable**

HDD’s motor will not shut off.

1 Min/2 Min/

Defines the continuous HDD idle time before the HDD enters the power saving mode (motor off). BIOS will turn off the HDD’s motor when time is out.

3 Min/4 Min/**5 Min/6 Min/****7 Min/8 Min/****9 Min/10 Min/****11 Min/12 Min/****13 Min/14 Min/****15 Min**

Throttle Duty Cycle

This option will determine how much power will be used by the CPU , if the system goes into suspend mode.

VGA Active Monitor

During Enabled, if there's no activity in the monitor screen, the system will go into Power Saving Mode. During Disabled, the system will go into Power Saving Mode, whether there is activity in the monitor screen or not. The settings are Disabled and Enabled.

Soft-Off by PWR-BTTN

The settings are Delay 4 sec or Instant-off. During Delay 4 sec, if you push the switch once, the system goes into suspend mode and if you push it more than 4 seconds, the system will be turned off. During instant-off, the system will turn off once you push the switch.

CPUFAN Off in Suspend

During Enabled, if the system goes into suspend mode, the CPU fan will stop. During Disabled, if the system goes into suspend mode, the CPU fan will resume.

Resume by Ring

During Disabled, the system will ignore any incoming call from the modem. During Enabled, the system will boot up if there's an incoming call from the modem.

Note: If you have change the setting, you must let the system boot up until it goes to the operating system, before this function will work.

Resume by Alarm

This function is for setting date and time for your computer to boot up. During Disabled, you cannot use this function. During Enabled, choose the Date and Time Alarm:

Date(of month) Alarm	You can choose which month the system will boot up. Set to 0, to boot every day.
Time(hh:mm:ss) Alarm	You can choose what hour, minute and second the system will boot up.

Note: If you have change the setting, you must let the system boot up until it goes to the operating system, before this function will work.

Wake Up On LAN

This function support the wake-up on LAN jumper (JWOL1).

Enabled	Wake up on LAN supported.
Disabled	Wake up on LAN not supported.

Restore on AC/Power Loss

The settings are power on or last status. During power on, after every AC power loss, the system will be turned on. During last status, after every AC power loss, whatever the system status, it will be the same when the AC power returns.

Note: If you set this option to last status, jumper JP2 must be open or this function will not work.

IRQ 8 Clock Event

You can Enable or Disable monitoring of IRQ 8 so it does not awaken the system from suspend mode.

IRQ 8 Clock Event

IRQ[3-7,9-15], NMI	: Enabled
Primary IDE 0	: Enabled
Primary IDE 1	: Disabled
Secondary IDE 0	: Disabled
Secondary IDE 1	: Disabled
Floppy Disk	: Enabled
Serial Port	: Enabled
Parallel Port	: Enabled

During Enabled, if any interrupt event occurs, the system will wake-up from suspend mode. During Disabled, the system will not monitor any interrupt event.

3.8 PNP/PCI Configuration Setup

You can manually configure the PCI Device's IRQ. The following pages tell you the options of each item & describe the meanings of each options.

ROM PCI/ISA BIOS (2A69KM4A)
PNP/PCI CONFIGURATION SETUP
AWARD SOFTWARE, INC.

PnP OS Installed	:No	Assign IRQ for VGA	: Enabled
Resources Controlled By	:Manual	Assign IRQ for USB	: Enabled
Reset Configuration Data	:Disabled	Used MEM base addr	: N/A
IRQ-3 assigned to	:Legacy ISA		
IRQ-4 assigned to	:Legacy ISA		
IRQ-5 assigned to	:PCI/ISA PnP		
IRQ-7 assigned to	:PCI/ISA PnP		
IRQ-9 assigned to	:PCI/ISA PnP		
IRQ-10 assigned to	:PCI/ISA PnP		
IRQ-11 assigned to	:PCI/ISA PnP		
IRQ-12 assigned to	:PCI/ISA PnP		
IRQ-14 assigned to	:PCI/ISA PnP		
IRQ-15 assigned to	:PCI/ISA PnP		
DMA-0 assigned to	:PCI/ISA PnP		
DMA-1 assigned to	:PCI/ISA PnP		
DMA-3 assigned to	:PCI/ISA PnP		
DMA-5 assigned to	:PCI/ISA PnP		
DMA-6 assigned to	:PCI/ISA PnP		
DMA-7 assigned to	:PCI/ISA PnP		
		Esc : Quit	↑↓←→ : Select item
		F1 : Help	PU/PD/+/- : modify
		F5 : Old Value(Shift)	F2 : Color
		F7 : Load Setup Defaults	

PnP OS Installed

When set to YES, BIOS will only initialize the PnP cards used for booting (VGA, IDE, SCSI). The rest of the cards will be initialized by the PnP operating system like Windows®95 or 98. When set to NO, BIOS will initialize all the PnP cards. So, for non-PnP operating system (DOS, Netware®), this option must set to NO.

Resources Controlled By

By Choosing “Auto”, the system BIOS will detect the system resource and automatically assign the relative IRQ and DMA Channel for each peripheral.

By Choosing “Manual”(default), the user will need to assign IRQ & DMA for add-on cards. Be sure that there is no conflict for IRQ/DMA and I/O ports.

Note: When choosing “Auto” you must be sure that all of the system add-on cards are PnP type.

Reset Configuration Data

The system BIOS supports the PnP feature so the system needs to record which resource is assigned and protect resources from conflict. Every peripheral device has a node which is called ESCD. This node records which resources are assigned to it. The system needs to record and update ESCD to the memory locations. These locations (4K) are reserved at the system BIOS.

If Disabled (default) is chosen the system’s ESCD will update only when the new configuration varies from the last one.

If Enabled is chosen the system will be forced to update the system’s ESCD. Then, this option will be auto-set to Disable.

IRQ-3 assigned to : Legacy ISA
IRQ-4 assigned to : Legacy ISA
IRQ-5 assigned to : PCI/ISA PnP
IRQ-7 assigned to : Legacy ISA
IRQ-9 assigned to : PCI/ISA PnP
IRQ-10 assigned to : PCI/ISA PnP
IRQ-11 assigned to : PCI/ISA PnP
IRQ-12 assigned to : PCI/ISA PnP
IRQ-14 assigned to : PCI/ISA PnP

IRQ-15 assigned to : PCI/ISA PnP
DMA-0 assigned to : PCI/ISA PnP
DMA-1 assigned to : PCI/ISA PnP
DMA-3 assigned to : PCI/ISA PnP
DMA-5 assigned to : PCI/ISA PnP
DMA-6 assigned to : PCI/ISA PnP
DMA-7 assigned to : PCI/ISA PnP

The above settings will be shown on the screen only if “Manual” is chosen for the *Resources Controlled By* function.

Legacy is the term which signifies that a resource is assigned to the ISA Bus and provides for non PnP ISA add-on card. PCI/ISA PnP signifies that a resource is assigned to the PCI Bus or provides for ISA PnP add-on cards and peripherals.

Assign IRQ for VGA

Lets the user choose which IRQ to assign for VGA card.

Assign IRQ for USB

Set to Enabled when USB port will be used. Set to Disable if the USB port will not be used.

Used MEM base addr

Lets the user choose the Legacy ISA addr. The settings are NA#, C800, CC00, D000, D400, D800 OR DC00.

Used MEM base addr

Lets the user choose the Legacy ISA addr. memory length. The settings are 8K, 16K, 32K, or 64K.

3.9 Load BIOS Defaults

This Main Menu item loads the default system values. If the CMOS is corrupted, the defaults are loaded automatically. Choose this item and the following message appears:

“ Load Setup Defaults (Y / N) ? N “

To use the Setup defaults, change the prompt to “Y” and press < Enter >

Note: The Setup defaults can be customized to increase performance. However, the BIOS defaults can always be used as a back up if there is some problem with the mainboard operation.

3.10 Special Features Setup (optional)

This Special Features Setup is used by System Hardware Monitor chipset. You can manually change the value of each option.

ROM PCI/ISA BIOS (2A69KM4A)
INTEGRATED PERIPHERALS
AWARD SOFTWARE, INC.

***** POST SHOWING *****	***** SYSTEM MONITOR *****
Chassis Fan Detected :Disabled	Chassis FAN RPM :0
Power Fan Detected :Disabled	Power FAN RPM :0
CPU Fan Detected :Enabled	CPU Fan RPM :6367
Chassis Intrusion Detect :Disabled	System Temperature :26°C/78°F
Voltage Detected :Enabled	CPU Temperature :28°C/82°F
Vcore Voltage Detected :Enabled	CPU Critical Temp :Disabled
+2.5V Voltage Detected :Enabled	Shutdown Temp :Disabled
+3.3V Voltage Detected :Enabled	
+5.0V Voltage Detected :Enabled	
+12V Voltage Detected :Enabled	
-12V Voltage Detected :Enabled	
-5.0V Voltage Detected :Enabled	
*****CPU PLUG & PLAY *****	
CPU Speed :350MHz (100x3.5)	Esc : Quit ↑↓←→ : Select item
CPU Ratio : x3	F1 : Help PU/PD/+/- : modify
CPU Frequency : 68MHz	F5 : Old Value(Shift) F2 : Color
	F7 : Load Setup Defaults

Chassis Fan Detected/Power Fan Detected/CPU Fan Detected/Voltage Detected/Vcore Voltage Detected/+2.5V Voltage Detected/+3.3V Voltage Detected/+5.0 Voltage Detected/+12V Voltage Detected/-12V Voltage Detected/-5.0 Voltage Detected

During Enabled, this will show the CPU/FAN voltage chart during system boot up. During Disabled, this will not show.

Chassis Intrusion Detect

Set this option to Enabled, Reset, or Disabled the chassis intrusion detector. During Enabled, any intrusion on the system chassis will be recorded. The next time you turn on the system, it will show a warning message. To be able to clear those warning, choose Reset. After clearing the message, it will go back to Enabled.

CPU Speed

Check your processor and set this function accordingly. If you set this to Manual, you can set the CPU Ratio and CPU Frequency accordingly. CPU Frequencies are: 66, 68, 75, 83 and 100, 103, 112. **Though 68, 75, 83, 103, and 112 frequencies are available, it is advised that you use these only for testing since this might cause instability as the CPU is not designed for these frequencies.** CPU ratio are: 3, 3.5, 4, 4.5, 5, 5.5, 6, 6.5, 7, 7.5, or 8.

Note: If you set the CPU Ratio and CPU Frequency too high, and the system will not turn on, restart the system and press “F10” until bootup. This will set the default setting.

Chassis/Power/CPU Fan RPM

During Enabled, this will monitor the RPM of your CPU/Chassis/Power fan.

System Temperature/CPU Temperature

This will show the System and CPU temperature.

CPU Critical Temp

This option is for setting the critical temperature level for the processor. When the processor reach the temperature you set, this will reduce the load on the processor.

Shutdown Temp

This option is for setting the Shutdown temperature level for the processor. When the processor reach the temperature you set, this will shutdown the system. This function only works with Windows®95 operating system.

3.11 Integrated Peripherals

ROM PCI/ISA BIOS (2A69KM4A)
 INTEGRATED PERIPHERALS
 AWARD SOFTWARE, INC.

IDE HDD Block Mode	: Enabled	IR Address Select	: 2E8H
IDE Primary Master PIO	: Auto	IR Mode	: IrDa
IDE Primary Slave PIO	: Auto	IR Transmitting Delay	: Enabled
IDE Secondary Master PIO	: Auto	IR IRQ Select	: IRQ10
IDE Secondary Slave PIO	: Auto		
IDE Primary Master UDMA	: Auto	Onboard Parallel Port	: 378/IRQ7
IDE Primary Slave UDMA	: Auto	Parallel Port Mode	: SPP
IDE Secondary Master UDMA	: Auto		
IDE Secondary Slave UDMA	: Auto		
On-Chip Primary PCI IDE	: Enabled		
On-Chip Secondary PCI IDE	: Enabled		
USB Keyboard Controller	: Disabled		
Init Display First	: PCI Slot		
Onboard Sound	: Enabled		
Onboard LAN	: Enabled		
Onboard FDC controller	: Enabled		
Onboard Serial Port 1	: 3F8/IRQ4	Esc : Quit	↑↓←→ : Select item
Onboard Serial Port 2	: 2F8/IRQ3	F1 : Help	PU/PD/+/- : modify
Onboard IR Controller	: Disabled	F5 : Old Value(Shift)	F2 : Color
		F7 : Load Setup Defaults	

IDE HDD Block Mode

Enabled/Disabled Enabled allows the Block mode access for the IDE HDD.

IDE Primary Master PIO

Auto/Mode0/Mode1-4

IDE Primary Slave PIO

Auto/Mode0/Mode1-4

IDE Secondary Master PIO

Auto/Mode0/Mode1-4

IDE Secondary Slave PIO

Auto/Mode0/Mode1-4

For these 4 IDE options, choose “Auto” to have the system BIOS auto detect the IDE HDD operation mode for PIO access.

Note: Some IDE HDD cannot operate at the responding HDD’s mode. When the user has selected “Auto” and the system BIOS has accepted the HDD response mode, the user may degrade the HDD’s operation mode. Ex: IF the HDD reported it can operate in mode 4 but it is not operating properly, the user will have to manually change the operation mode to mode 3.

Choosing Mode 1-4 will have the system ignore the HDD’s reported operation mode and use the selected mode instead.

Note: According to ATA specs. Mode 4 transfer rate is > Mode 3 > Mode 2 > Mode 1 > Mode 0. If the user’s HDD can operate at Mode 3 the user can also select a slower Mode (i.e. Mode 0-2) but not a faster Mode (ie Mode 4).

On-Chip Primary PCI IDE

Enabled/Disabled

On-Chip Secondary PCI IDE

Enabled/Disabled

The system provides for a On-Board On-Chipset PCI IDE controller that supports Dual Channel IDE (Primary and Secondary). A maximum of 4 IDE devices can be supported. If the user install the Off-Board PCI IDE controller (i.e. add-on cards), the user must choose which channels will be disabled. This will depend on which channel will be used for the Off-Board PCI IDE add-on card.

USB Keyboard Support**Enabled/Disabled**

Choosing Enabled will allow the system to use USB keyboard without a device driver.

Init Display First**PCI Slot/AGP Slot**

Select whether the PCI slot VGA or AGP slot VGA will function first.

Onboard Sound Controller**Enabled/Disabled**

The system has an on-board YAMAHA® YMF740 audio controller . Choose “Enabled” to use the on-board audio controller . Otherwise choose “Disabled” to use the add-on sound card controller.

Onboard LAN**Enabled/Disabled**

The system has an on-board Intel® 82558 10/100M Ethernet LAN Controller. Choose “Enabled” to use the on-board LAN controller for accessing the RJ-45. Otherwise choose “Disabled” to use the add-on LAN Card .

Onboard FDC Controller**Enabled/Disabled**

The system has an on-board Super I/O chip with a FDD controller that supports 2 FDDs for 360K/720K/1.2M/1.44M/2.8M. Choose “Enabled” to use the on-board FDD controller for accessing the FDD. Otherwise choose “Disabled” to use the off-board FDD controller.

Onboard Serial Port 1

Disabled/(3F8/IRQ4)/(2F8/IRQ3)/(3E8/IRQ4)/(2E8/IRQ3)

Onboard Serial Port 2

Disabled/(3F8/IRQ4)/(2F8/IRQ3)/(3E8/IRQ4)/(2E8/IRQ3)

The system has an On-board Super I/O chipset with 2 serial ports. The On-board serial ports can be selected as:

Disabled

3F8/IRQ4	COM 1 uses IRQ4
2F8/IRQ3	COM 2 uses IRQ3
3E8/IRQ4	COM 3 uses IRQ4
2E8/IRQ3	COM 4 uses IRQ3

Note: Because the ISA Bus Interrupt accepts low to high edge trigger, the interrupt request line cannot be shared by multiple sources. If an off-board ISA add-on card with a serial port is installed the user may have to disable the on-board serial port because it will conflict with IRQ request line for the off-board serial port.

Onboard IR Controller

This item allows you to Enabled or Disabled the Onboard IR(Infrared) controller.

IR Address Select

This item allows you to select which address the IR will occupy.

IR Mode

This allows you to select the IR Mode.

IR Transmitting Delay

This item allows you to Enabled or Disabled the IR transmitting delay.

IR IRQ Select

This item allows you to select which IRQ the IR will occupy.

Onboard Parallel Port

Disabled
(3BCH/IRQ7)/
(278H/IRQ5)/
(378H/IRQ5)

There is a built-in parallel port on the on-board Super I/O chipset that provides Standard, ECP, and EPP features. It has the following options:

Disable

3BCH/IRQ7 Line Printer port 0
 278H/IRQ5 Line Printer port 2
 378H/IRQ5 Line Printer port 1

Onboard Parallel Mode

SPP : Standard Parallel Port
 EPP : Enhanced Parallel Port
 ECP : Extended Capability Port

SPP/(EPP/SPP)/
ECP(ECP/EPP)

To operate the onboard parallel port as Standard Parallel Port only, choose “SPP.” To operate the onboard parallel port in the ECP and SPP modes simultaneously, choose “ECP/SPP.” By choosing “ECP”, the onboard parallel port will operate in ECP mode only. Choosing “ECP/EPP” will allow the onboard parallel port to support both the ECP and EPP modes simultaneously. The ECP mode has to use the DMA channel, so choose the onboard parallel port with the ECP feature. After selecting it, the following message will appear: “ECP Mode Use DMA” At this time the user can choose between DMA channels 3 or 1. The onboard parallel port is EPP Spec. compliant, so after the user chooses the onboard parallel port with the EPP function, the following message will be displayed on the screen: “EPP Mode Select.” At this time either EPP 1.7 spec. or EPP 1.9 spec. can be chosen.

3.12 Supervisor/User Password Setting

This Main Menu item lets you configure the system so that a password is required each time the system boots or an attempt is made to enter the Setup program. Supervisor Password allows you to change all CMOS settings but the User Password setting doesn't have this function. The way to set up the passwords for both Supervisor and User are as follow:

1. Choose "Change Password" in the Main Menu and press <Enter>. The following message appears:

"Enter Password:"

2. The first time you run this option, enter your password up to only 8 characters and press <Enter>. The screen does not display the entered characters. For no password just press <Enter>.
3. After you enter the password, the following message appears prompting you to confirm the password:

"Confirm Password:"

4. Enter exactly the same password you just typed in to confirm the password and press <Enter>.
 5. Move the cursor to Save & Exit Setup to save the password.
 6. If you need to delete the password you entered before, choose the Supervisor Password and press <Enter>. It will delete the password that you had before.
 7. Move the cursor to Save & Exit Setup to save the option you did. Otherwise, the old password will still be there when you turn on your machine next time.
-

3.13 IDE HDD Auto Detection

You can use this utility to automatically detect the characteristics of most hard drives.

When you enter this utility, the screen asks you to select a specific hard disk for Primary Master. If you accept a hard disk detected by the BIOS, you can enter “Y” to confirm and then press <Enter> to check next hard disk. This function allows you to check four hard disks and you may press the <Esc> after the <Enter> to skip this function and go back to the Main Menu.

ROM ISA BIOS
CMOS SETUP UTILITY
AWARD SOFTWARE, INC.

HARD DISKS	TYPE	SIZE	CYLS	HEADS	PRECOMP	LANDZONE	SECTOR MODE
Primary Master:	Auto	0	0	0	0	0	AUTO
Primary Slave :	Auto	0	0	0	0	0	AUTO
Secondary Master :	Auto	0	0	0	0	0	AUTO
Secondary Slave :	Auto	0	0	0	0	0	AUTO

Select Primary Master		Option (N=Skip) : N				
OPTIONS	SIZE	CYLS	HEAD	PRECOMP	LANDZ	SECTOR MODE
2	2112	1023	64	0	4094	63 LBA
1	2113	4095	16	65535	4094	63 NORMAL
3	2113	2047	32	65535	4094	63 LARGE

[ESC: Skip]

Chapter 4

ATI® 3D RAGE PRO TURBO VGA DRIVER

1. Overview

The ATI® 3D RAGE PRO Turbo is a highly integrated graphics controller. Incorporated within this single chip are the 2D, 3D, and video accelerators, palette DAC, and dual-clock synthesizer. This multi-function integrated controller delivers TV-quality scaled video optimized for MPEG playback, industry-leading mach64 2D performance.

1.1 ATI® RAGE PRO Turbo Features

- Support 2M or 4M SGRAM for 100MHz.
- Support AGP 2X BUS up to 133MHz.
- Complete 3D primitive support: points, lines, triangles, strips, and quadrilaterals.
- 4K On-chip Texture Cache.
- 16-bit Z buffer.

1.3 System Requirements

This section describes system requirements for the VGA Driver installation and Usage.

Computer	Intel® Pentium®II/Celeron™ processor or higher
Monitor	VGA Support, minimum 640x480 resolution
Operating system	DOS 5.0 or higher, Windows®95/98, Windows®NT 3.51 or 4.0, or OS/2®
CD-ROM	Double Speed or Higher
Chipset	ATI®3D RAGE PRO Turbo
VGA BIOS	Version 1.01 or Higher

2. ATI®3D VGA Driver Setup & Usage Procedures

Insert the CD-title into your CD-ROM drive. This CD will auto-run. This will display installation for VGA driver and sound driver. Also included are Intel®PIIX4E patch for Windows®95, Trend PC-cillin 98 and Bus Master driver. Just click the button for automatic installation for VGA driver.

2.1 Windows® 95/98

If you start Windows®95/98, this will automatically detect this hardware onboard “PCI Multimedia Audio Device” and “Gameport Joystick”. You need to click “Next”, then “Finish”. Do not click on the “Cancel”. The driver need these ID.

2.1-1 Display Driver Installation Procedure:

- Step 1:** Insert the provided CD_ROM disk into the CD-ROM drive.
 - Step 2:** Look for the CD_ROM drive, double click on the CD_ROM icon. This will show the setup screen.
 - Step 3:** Click on “ATI Installation” icon.
 - Step 4:** This will show an ATI installation menu.
 - Step 5:** Click on “Display Drivers”.
 - Step 6:** Click “OK”.
 - Step 7:** This will copy the VGA drivers into the hard drive.
 - Step 8:** A message will appear stating you must restart the Windows®95/98 system, select **yes** to restart.
 - Step 9:** After restarting, Windows®95/98 will show a new display setting.
-

2.1-2 Changing resolution, color depth, and refresh rate:

- Step 1:** Click **Start** menu and select **Control Panel** from **Settings** group.
- Step 2:** Select **Display** icon.
- Step 3:** Select **Settings**.
- Step 4:** Select Color Palette to change between 16 color, 256 color, Hi color, or True color.
- Step 5:** Select desktop resolution from 640x480, 800x600, 1024x768, and 1280x1024.
- Step 6:** Select Refresh rate list box to change the screen refresh rate.
- Step 7:** Click OK or Apply.

2.1-3 ATI Video Player for Windows 95/98

- Step 1:** Insert the provided CD_ROM disk into the CD-ROM drive.
- Step 2:** Look for the CD_ROM drive, double click on the CD_ROM icon. This will show the setup screen.
- Step 3:** Click on “ATI Installation” icon.
- Step 4:** This will show an ATI installation menu.
- Step 5:** Click on “ATI Video Player”.
- Step 6:** This will show “ATI Video Player Setup” icon.
- Step 7:** Click on “Finish”.
- Step 8:** This will copy the necessary files into the hard drive.
- Step 9:** After restarting, ATI setup is completed.

Note: Xing Software MPEG is incompatible with Windows®95.

2.2 Windows® NT 4.0

You need to install Windows®NT “Service Pack”, before you install Windows®NT driver.

2.2-1 Display Driver Installation Procedure:

- Step 1:** Click **Start** menu and select **Control Panel** from **Settings** group.
- Step 2:** Select **Display** icon.
- Step 3:** Select **Settings** on the Display Properties.
- Step 4:** Select **Display Type**.
- Step 5:** Select **Change** from the **Adapter Type** Area.
- Step 6:** Select **Have Disk** of Change Display.
- Step 7:** Insert the **CD-Title Disk** into CD-ROM Drive.
- Step 8:** When the Install from Disk dialog box appears, look for your CD-ROM drive :**\SVGA\ATI\3D_RAGE\WINNT\ati.inf**.
- Step 9:** When the **Change Display** dialog box appears, click **OK**.
- Step 10:** When the Third-party Drivers dialog box appears, click **Yes**.
A message will appear stating that the drivers were successfully installed. Click **OK**. You must now restart Windows®NT 4.0.

2.2-2 Changing resolution, color depth, and refresh rate:

- Step 1:** Click **Start** menu and select **Control Panel** from **Settings** group.
- Step 2:** Select **Display** icon.
- Step 3:** Select **Settings**.
- Step 4:** Select Color Palette to change between 16 color, 256 color, 32768 colors, 65536 colors, and 16777216 colors.
- Step 5:** To select desktop resolution size, go to the Desktop area and use the slide bar to change resolution from 640x480, 800x600, 1024x768, to 1280x1024.
- Step 6:** Select Test to test the resolution. If the display test screen was good, then select Yes when the Testing Mode dialog box appears. If the display test screen was bad, then select No. Windows®NT will give you an error message.
- Step 7:** Click OK. If the display test screen was a good and you select Yes, Windows®NT 4.0 will change the mode without restarting the system.

2.3 AutoCAD, OS/2 and other application. Please refer to “On-Line Manual” in the CD-ROM. You need to install the “Acrobat Reader 3.01” program first.

Chapter 5

YAMAHA® AUDIO DRIVER

1. Overview

The YAMAHA® YMF740C PCI audio integrates OPL3, MPU401 MIDI interface and joystick port. This function is suitable for multi-media applications.

1.1 Features

- Support Sound Blaster game compatibility.
- Support Windows sound system compatibility.
- Full Duplex Operation.
- Support Software Wave Table

1.2 System Requirements

This section describes system requirements for the Audio Driver installation and Usage.

Computer	Intel® Pentium® II/Celeron™ processor or higher
Operating system	DOS 5.0 or higher, Windows® 95/98, Windows® NT 3.51 or 4.0, or OS/2®
CD-ROM	Double Speed or Higher
Chipset	YAMAHA YMF740C

2. Audio Driver Setup

Insert the CD-title into your CD-ROM drive. This CD will auto-run. This will display installation for VGA driver and sound driver. Also included are Intel®PIIX4E patch for Windows®95, Trend PC-cillin 98 and Bus Master driver. Just click the button for automatic installation for sound driver.

2.1 Windows® 95/98

2.1-1 Audio Driver Installation Procedure:

- Step 1:** Insert the provided CD_ROM disk into the CD-ROM drive.
- Step 2:** Look for the CD_ROM drive, double click on the CD_ROM icon. This will show the setup screen.
- Step 3:** Click on “Device Driver” icon.
- Step 4:** This will copy the audio drivers into the hard drive.
- Step 5:** A message will appear stating you must restart the Windows® 95/98 system, select **yes** to restart.

2.1-2 Windows®95/98 Application:

- Step 1:** Insert the provided CD_ROM disk into the CD-ROM drive.
- Step 2:** Look for the CD_ROM drive, double click on the CD_ROM icon. This will show the setup screen.
- Step 3:** Click on “YAMAHA YSTATION” icon.
- Step 4:** Follow the setup procedures.
- Step 5:** A message will appear stating you must restart the Windows® 95/98 system, select **yes** to restart.

2.1-3 YAMAHA XG Wavetable Installation

Step 1: Insert the provided CD_ROM disk into the CD-ROM drive.

Step 2: Look for the CD_ROM drive, double click on the CD_ROM icon. This will show the setup screen.

Step 3: Click on “YAMAHA XG Studio” icon.

Step 4: Follow the setup procedures.

Step 5: A message will appear stating you must restart the Windows® 95/98 system, select **yes** to restart.

2.2 Windows® NT 4.0

2.2-1 Audio Driver Installation Procedure:

- Step 1:** Click **Start** menu and select **Control Panel** from **Settings** group.
- Step 2:** Select **Multimedia** icon.
- Step 3:** Click on the **Devices** tab.
- Step 4:** Click **Add**.
- Step 5:** Double click on **Unlisted or Updated Driver** in the list.
- Step 6:** Insert the **CD-ROM Disk** into the CD-ROM Drive.
- Step 7:** When the Install from Disk dialog box appears, look for your CD-ROM drive :`:\SOUND\YAMAHA\YMF740\NT40\`
- Step 8:** Click **OK**.
- Step 9:** Select the language of the driver.
- Step 10:** Click **OK**.
- Step 11:** Set parameters.
- Step 12:** A message will appear stating that the drivers were successfully installed. Click **OK**. You must now restart Windows®NT 4.0.

2.3 Detailed User's Manual

The detailed user's manual can be found on following path of the CD-ROM provided:

PATH: `SOUND\YAMAHA\YMF740\Guide\`

Chapter 6

INTEL® 82559 FAST ETHERNET LAN DRIVER

1. Overview

The 82559 is a sophisticated 32-bit PCI component, with enhanced scatter-gather bus mastering capabilities. Its true 32-bit architecture enables it to perform high speed data transfers on the PCI bus using four DMA channels.

1.1 Features

- IEEE 802.3/802.3u 10BASE-T and 100BASE-TX compatible
- Glueless 32-bit PCI bus master interface
- Backward software compatible to the 82557
- Internal transmit and receive FIFOs (3 kbytes each)
- Back-to-back transmit at 100 Mbps within minimum IFS
- EEPROM support for configuration and customized feature selection
- Advanced configuration and Power Interface Specification, Revision 1.0, and PCI Power Management Specification, Revision 1.0 compliant
- Remote Wake Up (Magic Packet*) support in APM and ACPI modes
- ACPI “interesting” packet wake support in D0 to D3 low power states
- IEEE 802.3u Auto-Negotiation support for 10BASE-T and 100BASE-TX
- Full or half duplex capable at 10 or 100 Mbps
- IEEE 802.3x flow control support

2. LAN Driver Setup

2.1 Windows®95

To install the driver, just insert the provided CD-ROM into the CD-ROM drive. The CD-ROM will autorun. Press the button for installing the LAN driver.

2.2 Other OS driver

To install the driver for other operating system, just insert the provided CD-ROM into the CD-ROM drive.

Type:

CD-ROM Path:\E100B\Setup/readme

This will show different procedure for the installation of LAN driver for different kind of operating system. Just follow the procedures given.