

## System Board Specifications

<b>CPU</b>	Supports Intel P54C - 75 MHz/90 MHz/100 MHz/120 MHz/133MHz/150MHz/166 MHz
<b>Cache Memory</b>	Supports 256K, 512K, 1M or 256K synchronous pipelined burst cache memory
<b>Main Memory</b>	Supports four memory banks using four 72-pin SIMM modules with 4M, 8M, 16M, 32M DRAM  Up to 256 Mbytes on-board memory
<b>Slots</b>	Four 32-bit PCI Bus slots and four 16-bit ISA bus slots in maximum combinations of four 16-bit ISA and four PCI slots  Supports four Master/Slave PCI bus slots
<b>On-Board Peripherals</b>	AT keyboard, or PS/2 keyboard and mouse  On-board peripherals include two serial port, one parallel port, FDC controller, and PCI IDE controller
<b>Battery</b>	3V on-board Lithium battery
<b>Dimensions</b>	28 x 22 cm x 4 layer PCB
<b>Mounting</b>	7 mounting holes

## System Board Layout

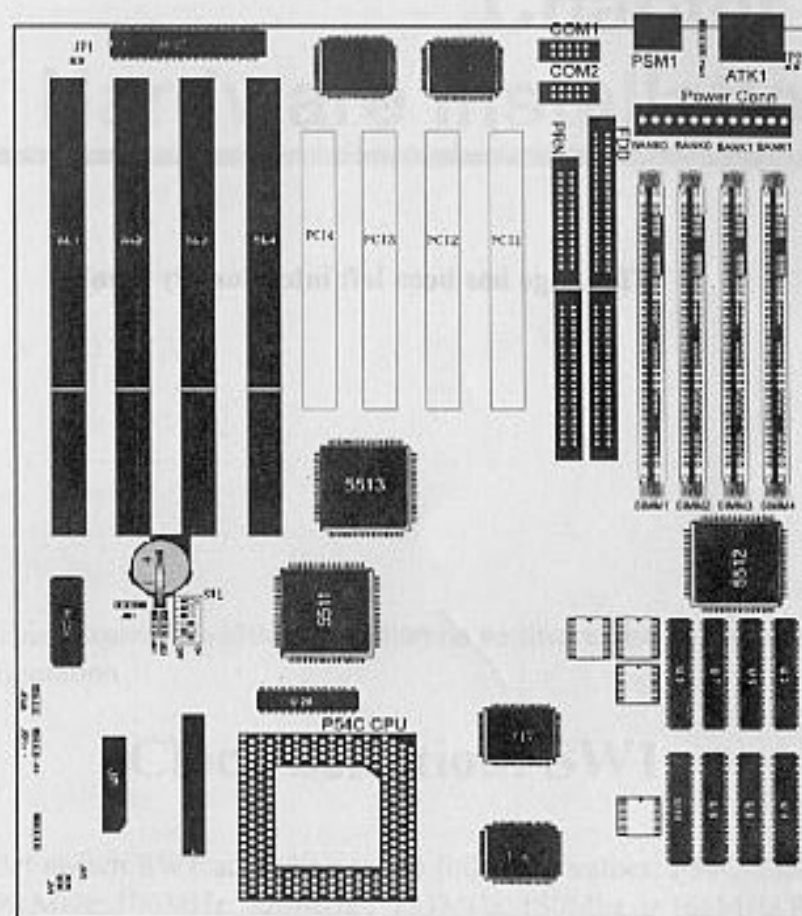

Figure 1-1: System Board Layout.

## SW1 setting

CPU Internal Clock	SW1	SW1
	1 2 3 (Int/Ext Ratio)	4 5 6 (External Clock)
75 MHz	O O O (1.5)	O O S (50MHz)
90 MHz	O O O (1.5)	S O S (60MHz)
100 MHz	O O O (1.5)	S S S (66MHz)
120 MHz	O S O (2)	S O S (60MHz)
133 MHz	O S O (2)	S S S (66MHz)
150MHz	O S S (2.5)	S O S (60MHz)
166MHz	O S S (2.5)	S S S (66MHz)
80MHz (6X86)	S S O (2)	O S S (40MHz)
100MHz (6X86)	S S O (2)	O O S (50MHz)
120Mhz (6X86)	S S O (2)	S O S (60MHz)
133Mhz (6X86)	S S O (2)	S S S (66MHz)

O ⇒ Open = off

S ⇒ Short = on

SW1 (1) ON Pipelined Burst SRAM running Linear mode for M1

OFF Pipelined Burst SRAM running Toggle mode for pentium

SW (2-3) OFF ON for setting Pentium 3X CPU clock

OFF OFF for setting 6X86 3X CPU clock

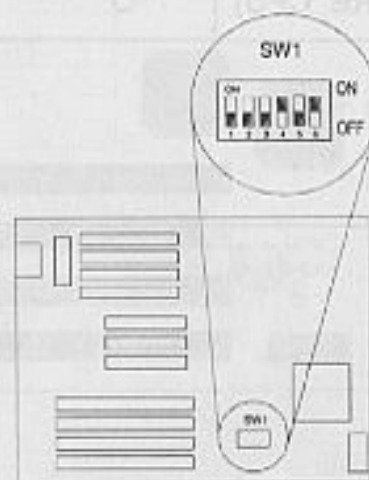

Figure 2-1 : SW1 Settings.

## CPU Voltage Selector: JV1, JV2

For jumpers JV1 and JV2 select either a 3.38 or 3.52 volt power source for the P54C.(3.52V for Intel special CPU)

CPU Voltage	JV1	JV2
3.38V(DEFAULT)	S	S
3.52V(VRE CPU)	O	S

O ⇒ Open

S ⇒ Short

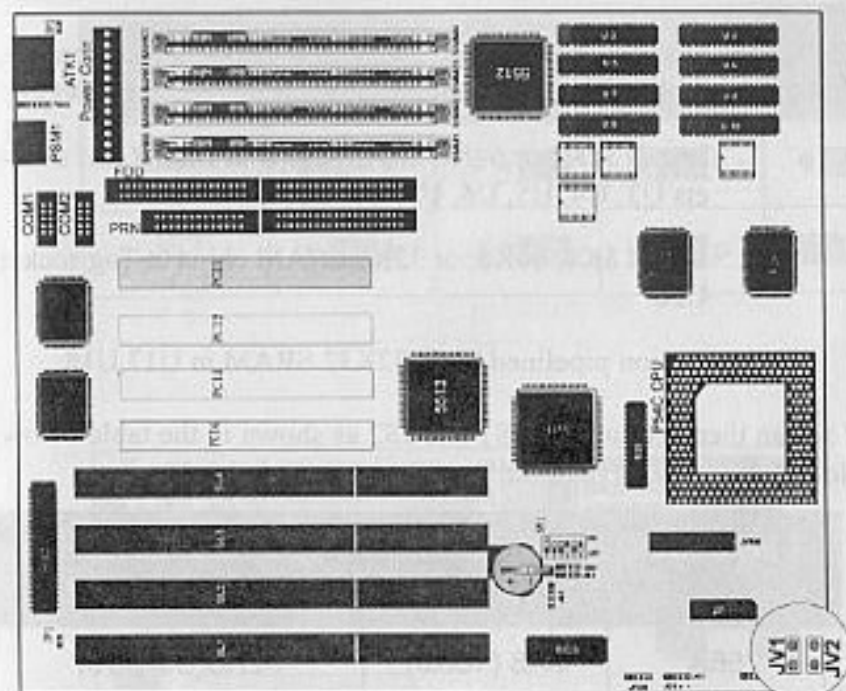

Figure 2-2 : CPU Voltage Selector JV1 and JV2.

## Cache Selection: JS1, JS2

The system board supports 256K, 512K, and 1M of cache memory. You can configure the cache memory in the following three ways:

1. Install 32K8 or 64K8 SRAM chips in Data RAM sockets U3, U4, U5, U6, U7, U8, U9, U10.
2. Install 8K8, 16K8, or 32K8 SRAM chips in Tag socket U28.
3. Option pipelined burst 32K32 SRAM in U17,U18.

You can then set jumpers JS1 and JS2 as shown in the table below. Note that the speed required for SRAM chips is 15ns.

Cache Size	Tag RAM (U28)	Data RAM
256K	8K8 (16K8)	32K8(U3-U10)
512K	16K8	64K8(U3-U10)
512K	16K8	64K8(U3-U10)
1M	32K8	128K8(U3-U10)
256K	8K8(16K8)	32K32(U17,U18)

## JS1, JS2: Cache Size Settings

Cache Size	256K	512K (128AK)	512K (129AK)	1M
JS1				
JS2				

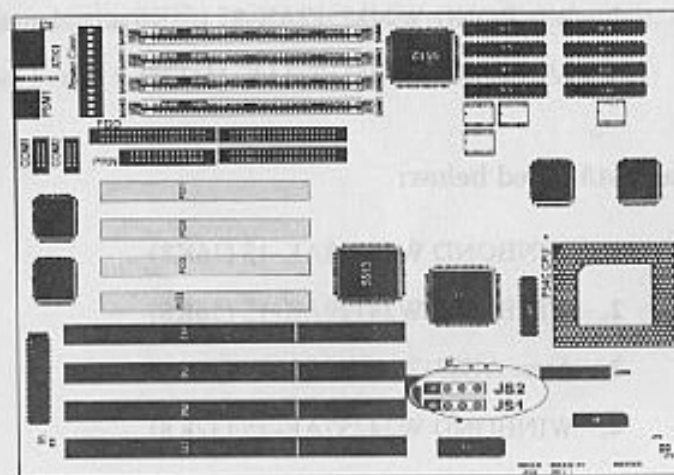

Figure 2-3: JS1 and JS2 Cache Size Settings.

SIMM1	SIMM2	SIMM3	SIMM4
(S/D) type only	—	—	—
(S) type	(S) type	—	—
(D) type	(D) type	—	—
(S) type	(S) type	(S) type	(S) type
(S) type	(S) type	(D) type	(D) type
(D) type	(D) type	(S) type	(S) type
(D) type	(D) type	(D) type	(D) type
—	—	(S) type	(S) type
—	—	(D) type	(D) type

*Note!*

You must install two of the same type of EDO or FP in the SIMM sockets SIMM1/SIMM2 or SIMM3/SIMM4 when you mix the EDO and fast page DRAM. For example:

SIMM1	SIMM2	SIMM3	SIMM4
EDO	EDO	FP	FP
FP	FP	EDO	EDO

## Keyboard Connector ATK1

The system board provides a standard five pin female DIN connector, ATK1, for attaching a keyboard. You can plug a keyboard cable directly into this connector. See *Figure 1-1* for connector locations.

## PS/2 keyboard connector: PSK1

PSK1 is a standard six-pin female mini-DIN Connector. You can plug a PS/2 keyboard cable directly into this connector.

## PS/2 mouse connector: PSM1, PSM2

You can attach a PS/2 mouse with a six-pin mini-DIN connector directly to the system board with this connector - PS2/M2. Alternatively, PS2/M is a five-pin male PIN connector. It connects with an extended Mouse cable for PIN to mini-DIN connections.

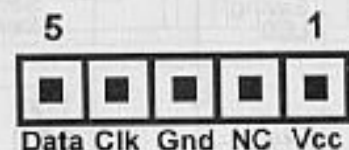

*Note!*

If a PS/2 mouse is used, the Jumper JP1 should be shorted on the system board to assign IRQ12 to the PS/2 mouse. Otherwise, the Interrupt Request IRQ12 will be available for other adapters.

## Case Connector Block: JFP1

The Turbo LED, Turbo Switch, Hardware Reset, Keylock, Power LED, Power Saving LED, Sleep Switch, Speaker and HDD LED all connect to the JFP1 Connector Block as shown below. See figure 1-1 for JFP1's location.

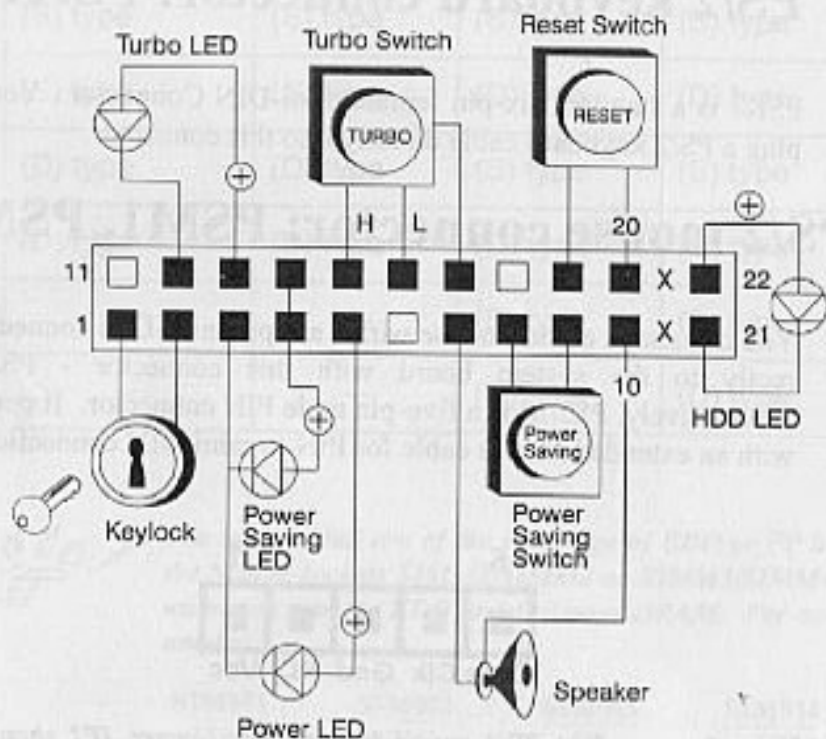

Figure 2-4: Case Connector Block - JFP1.

## Power Supply Connector: J 1

The power supply connector is a twelve-pin male connector. Dual connectors from the power supply can fit in only one direction. Make sure to attach the connectors with the two black wires at the center, as show in the diagram below. See Figure 1-1 for the connector's location.

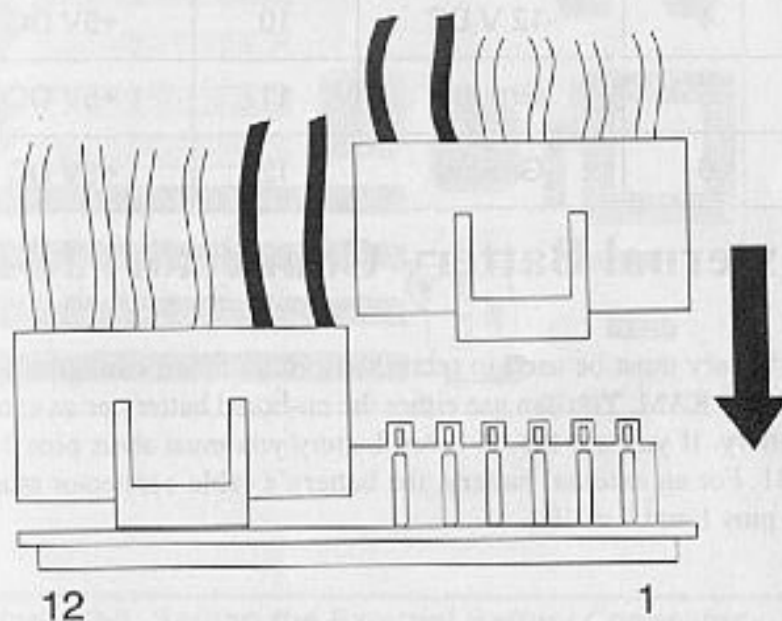

Figure 2-5: Attaching Power Supply Connectors.