



Display Adaptor Selection

If you are using a monochrome or color (CGA) display adaptor you must set the jumper JP1. If you are using an EGA or VGA adaptor, the JP1 setting is irrelevant. See figure 1-1 for jumper location.

JP1: Display Adaptor Jumper

Display type	JP1
Color Graphics Adaptor	
Monochrome Adaptor (default)	

Keyboard Connectors

The system board offers the choice of two connectors for attaching a keyboard. See figure 1-1 for connector locations.

J3: Keyboard Connector - DIN

J3 is a standard five-pin female DIN connector. You can plug a keyboard cable directly into this connector.

J2: Keyboard Connector - PIN

J2 is a five-pin male PIN connector. It connects with an extended keyboard cable for PIN to DIN connection. J2 is suitable for connecting to a DIN connector at the front of the case, which then connects to the keyboard cable jack.

External Battery Connector

A battery must be used to retain the system board configuration in CMOS RAM. You can use either the on-board rechargeable battery or an external battery. If you use the on-board rechargeable battery you must short pins 2-3 of J4. For an external battery, the battery's cable connector attaches to pins 1 and 4 of J4. See Figure 1-1 for the connector's location.

J4: External Battery Connector

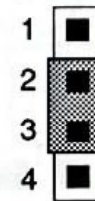

**Jumper Setting
for using
on-board Battery**

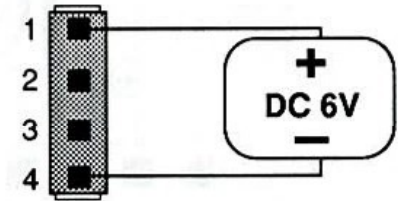

**External Battery
Connection**

Figure 2-1. Setting the External Battery Connector - J4

Case Connector Block

The Turbo LED, Turbo switch, Hardware Reset, Keylock, Power LED, and Speaker are all connected to the J5 Connector Block as shown below. See Figure 1-1 for the connector block's location.

J5: Case Connector Block

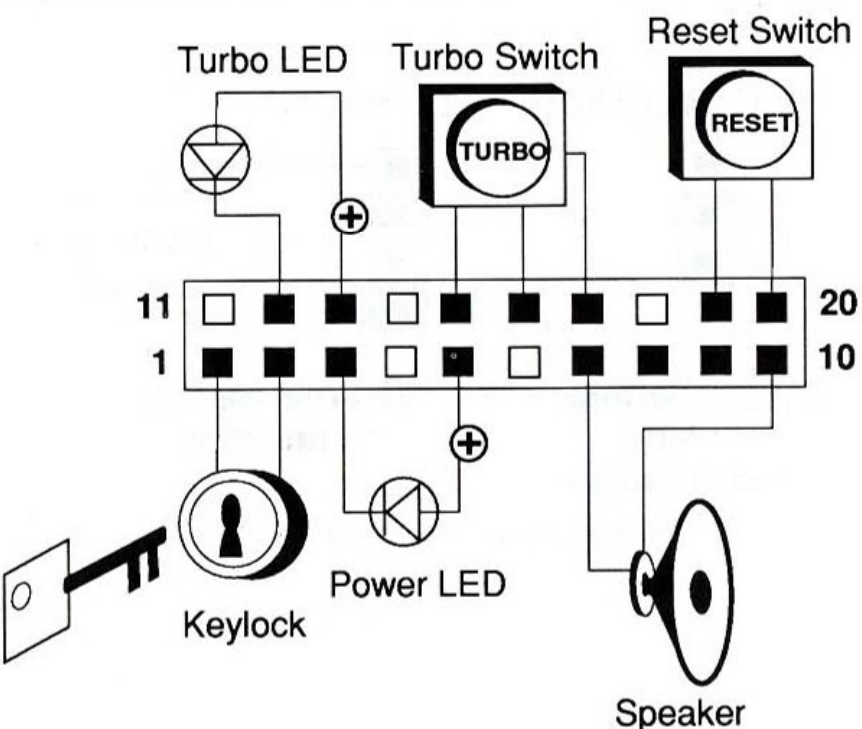

Figure 2-2. Case Connector Block - J5

J1: Power Supply Connector

The power supply connector is a twelve-pin male connector. Dual connectors from the power supply can fit in only one direction. Make sure to attach the connectors with the two black wires at the center, as show in the diagram below. See Figure 1-1 for the connector's location.

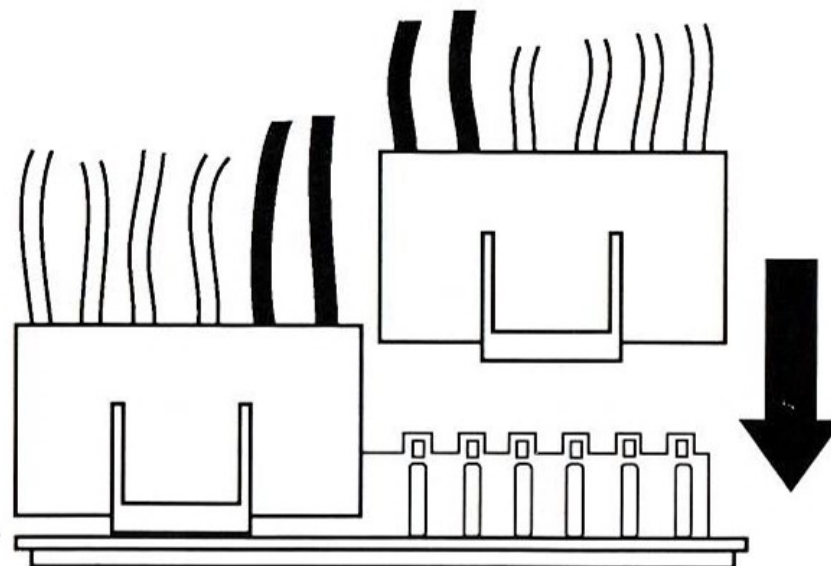

Figure 2-3. Attaching Power Supply Connectors

Connector Pin Description

Pin	Description	Pin	Description
1	Power Good	1	Ground
2	+5V DC	2	Ground
3	+12V DC	3	-5V DC
4	-12V DC	4	+5V DC
5	Ground	5	+5V DC
6	Ground	6	+5V DC

JP6: CPU Type Selection

The CONTAQ-486 system board can support several types of CPU. To configure the system board to recognize which type of CPU is installed, you must set the 12-pin jumper JP6 as below. See Figure 1-1 for the jumper's location.

JP6: CPU Type Selector

486SX / P23	487SX / P23T	486DX / 486DX2 / P24
<p>3 2 1</p> <p>12 11 10</p>	<p>3 2 1</p> <p>12 11 10</p>	<p>3 2 1</p> <p>12 11 10</p>

JP8: Reserve Jumper

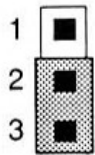

Fixed: 2,3

JP5, JP7: System Clock Selection

* These two jumpers will be available and should be set as following table only when the system board uses clock generator chip (U25) and crystal (Y2) in place of OSC2 and OSC1.

Gclock	40 MHz	50 MHz	66.667 MHz
JP5	<p>5 3 1</p> <p>6 4 2</p>	<p>5 3 1</p> <p>6 4 2</p>	<p>5 3 1</p> <p>6 4 2</p>

System clock	Gclock	Gclock/2
JP7	<p>3 2 1</p>	<p>3 2 1</p>

The following table list variable settings depending on different system.

System	JP5	JP7
40 MHz	1-2, 5-6	1-2
486DX-50	5-6	1-2
ODP-20	1-2, 5-6	2-3
486SX-25 ODP-25 486Dx-25 486DX2-50	5-6	2-3
486DX-33 486DX2-66	1-2, 3-4	2-3



JP3, JP13: Clock Selection

Jumpers JP3 and JP13 should be set correctly depending on the system clock. See Figure 1-1 for the location of the jumpers.

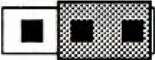
JP3 Settings

System Clock	JP3
20/25 MHz	 3 2 1
33 MHz and up	 3 2 1

JP13 Settings

System Clock	JP13
≤ 33 MHz	
> 33 MHz	

JP2: Cache Memory Configuration

The system board supports 64K/128K/256K of cache memory. You configure cache memory by installing 8K8 or 32K8 SRAM chips in Data RAM sockets U6~U9 and U10~U13, and in Tag RAM socket U14, and then setting the 12-pin cache jumper JP2. Note that the speed required for Data RAM chips is 20ns and 25ns respect to 50MHz and 33MHz system. The speed required for Tag RAM is 20ns.

Cache Size and Memory Locations

Cache Size	Tag RAM (U14)	Bank 0 (U6~U9)	Bank 1 (U10~U13)
64K	8K8	8K8	8K8
128K	8K8	32K8	None
256K	32K8	32K8	32K8

JP2: Cache Size Selector

64K	128K	256K

Memory Bank Configuration

The CONTAQ-486 system board supports two memory banks on-board, numbered bank 0 and bank 1. Each bank consists of four Single In-line Memory Module (SIMM) sockets. Each socket accepts a 256K SIMM, a 1M SIMM or a 4M SIMM.

Although the system board accepts combinations of different capacity memory modules, it does not allow you to combine different module capacities within a memory bank. All of the modules within a bank must be of the same type.

Minimum memory configuration for the system is 1MB (four 256K SIMMs installed in bank 0.) The maximum memory configuration is 32M. See Table 2-1 below for possible configurations.

Bank 0	Bank 1	Memory
256K	—	1M
256K	256K	2M
1M	—	4M
256K	1M	5M
1M	256K	5M
1M	1M	8M
4M	—	16M
256K	4M	17M
4M	256K	17M
1M	4M	20M
4M	1M	20M
4M	4M	32M

Table 2-1. Memory Configurations