

# GA-K8VM800M / GA-K8VM800M-RH

AMD Socket 754 Processor Motherboard

## User's Manual

Rev. 2004

12ME-K8VM800M-2004R



\* The WEEE marking on the product indicates this product must not be disposed of with user's other household waste and must be handed over to a designated collection point for the recycling of waste electrical and electronic equipment!!

■ \* The WEEE marking applies only in European Union's member states.

## Declaration of Conformity

We, Manufacturer/Importer  
(full address)

G.B.T. Technology, Inc.  
17358 Railroad Street  
City of Industry, CA 91748, Germany

(description of the apparatus, system, installation to which it refers)  
(declare that the product

**Motherboard**

is in conformity with  
(reference to the specification under which conformity is declared)

in accordance with 91/263 EEC-EMC Directive

- |  |  |   |   |
|--|--|---|---|
| <input type="checkbox"/> EN 55011              | Units and methods of measurement of radio disturbance characteristics of industrial, scientific and medical (ISM) high frequency equipment | <input checked="" type="checkbox"/> EN 61000-3-2                                  | Disturbances in supply systems caused by household appliances and similar electrical equipment "Voltage fluctuations" |
| <input type="checkbox"/> EN 55013              | Units and methods of measurement of radio disturbance characteristics of electronic receivers and associated equipment                     | <input checked="" type="checkbox"/> EN 55024                                      | Information Technology equipment/immunity equipment   |
| <input type="checkbox"/> EN 55014-1            | Units and methods of measurement of radio disturbance characteristics of portable tools and similar electrical apparatus                   | <input type="checkbox"/> EN 55022   | Generic immunity standard Part 1: Residential, commercial and light industry industrial environment                   |
| <input type="checkbox"/> EN 55015              | Units and methods of measurement of radio disturbance characteristics of television, lamps and luminaires                                  | <input type="checkbox"/> EN 55014-2   | Immunity requirements for household appliances tools and similar apparatus  |
| <input type="checkbox"/> EN 55020              | Immunity from radio interference of broadcast receivers and associated equipment   | <input type="checkbox"/> EN 55019-1-2   | EMC requirements for uninteruptible power systems (UPS)   |
| <input checked="" type="checkbox"/> EN 55022   | Units and methods of measurement of radio disturbance characteristics of information technology equipment                                  |   |   |
| <input type="checkbox"/> DIN VDE 0855          | Cabled distribution systems: Equipment for data processing systems from sound and television signals                                       |   |   |
| <input type="checkbox"/> Part 12               |  |   |   |
| <input checked="" type="checkbox"/> CE marking |  |  | (EC conformity marking)   |
| <input type="checkbox"/> EN 60065              | Safety requirements for mains operated household and similar general use electrical appliances   | <input type="checkbox"/> EN 60950   | Safety for information technology equipment including electrical business equipment                                   |
| <input type="checkbox"/> EN 60335              | Safety of household and similar electrical appliances  | <input type="checkbox"/> EN 60911-1   | General and Safety requirements for uninteruptible power systems (UPS)  |

The manufacturer also declares the conformity of above mentioned product with the safety required safety standards in accordance with LVD 73/23 EEC

Manufacturer/Importer

Signature: Timmy Huang

Date: Aug. 8, 2005

Name: Timmy Huang

(Stamp)

## DECLARATION OF CONFORMITY

Per FCC Part 2, Section 2.1077(a)



Responsible Party Name: G.B.T. INC. (U.S.A.)

Address: 17358 Railroad Street

City of Industry, CA 91748

Phone/Fax No: (818) 854-9338 / (818) 854-9339

hereby declares that the product

Product Name: **Motherboard**

Model Number: GA-K8VM800M

Conforms to the following specifications:

FCC Part 15, Subpart B, Section 15.107(a) and Section 15.109

(a), Class B Digital Device

### Supplementary Information:

This device complies with part 15 of the FCC Rules. Operation is subject to the following two conditions: (1) This device may not cause harmful and (2) this device must accept any interference received, including that may cause undesired operation.

Representative Person's Name: ERIC LU

Signature: Eric Lu

Date: Aug. 8, 2005

## Declaration of Conformity

We, Manufacturer/Importer  
(full address)

G.B.T. Technology, Inc.  
17358 Railroad Street  
City of Industry, CA 91748, Germany

(description of the apparatus, system, installation to which it refers)  
(declare that the product)

**Motherboard**  
GA-K8VM800M-RH

(reference to the specification under which conformity is declared)  
is in conformity with  
in accordance with 90/269 EEC-EMC Directive

- |  |   |  |   |
|--|---|--|---|
| <input type="checkbox"/> EN 55011            | Units and methods of measurement of radio disturbance characteristics of industrial, scientific and medical (ISM) high frequency equipment                | <input checked="" type="checkbox"/> EN 61000-3-2 | Disturbances in supply systems caused by household appliances and similar electrical equipment "Voltage fluctuations" |
| <input type="checkbox"/> EN 55013            | Units and methods of measurement of radio disturbance characteristics of electronic receivers and associated equipment                                    | <input checked="" type="checkbox"/> EN 55024     | Information Technology equipment/immunity equipment   |
| <input type="checkbox"/> EN 55014-1          | Units and methods of measurement of radio disturbance characteristics of household electrical appliances, portable tools and similar electrical apparatus | <input type="checkbox"/> EN 55022-1              | Generic immunity standard Part 1: Residential, commercial and light industry  |
| <input type="checkbox"/> EN 55015            | Units and methods of measurement of radio disturbance characteristics of fluorescent lamps and luminaires   | <input type="checkbox"/> EN 55014-2              | Immunity requirements for household appliances, tools and similar apparatus   |
| <input type="checkbox"/> EN 55020            | Immunity from radio interference of broadcast receivers and associated equipment  | <input type="checkbox"/> EN 55022-2              | Generic immunity standard Part 2: Industrial environment  |
| <input checked="" type="checkbox"/> EN 55022 | Units and methods of measurement of radio disturbance characteristics of information technology equipment   |  |   |
| <input type="checkbox"/> DIN VDE 0855        | Cabled distribution systems: Equipment for data processing systems from Part 12   |  |   |
| <input type="checkbox"/> Part 12             | Sound and television signals  |  |   |

CE marking



(EC conformity marking)

The manufacturer also declares the conformity of above mentioned product with the safety required safety standards in accordance with LVD 73/23 EEC

- |                                   |  |                                     |   |
|-----------------------------------|--|-------------------------------------|---|
| <input type="checkbox"/> EN 60065 | Safety requirements for mains operated household and similar general use electrical appliances | <input type="checkbox"/> EN 60950   | Safety for information technology equipment including electrical business equipment |
| <input type="checkbox"/> EN 60335 | Safety of household and similar electrical appliances  | <input type="checkbox"/> EN 60971-1 | General and Safety requirements for uninteruptible power systems (UPS)              |

Manufacturer/Importer

Signature: Timmy Huang

(Stamp)

Date: Jun. 21, 2006

Name: Timmy Huang

## DECLARATION OF CONFORMITY

Per FCC Part 2, Section 2.1077(a)



Responsible Party Name: G.B.T. INC. (U.S.A.)

Address: 17358 Railroad Street

City of Industry, CA 91748

Phone/Fax No: (818) 854-9338 / (818) 854-9339

hereby declares that the product

Product Name: **Motherboard**

Model Number: GA-K8VM800M-RH

Conforms to the following specifications:

FCC Part 15, Subpart B, Section 15.107(a) and Section 15.109

(a), Class B Digital Device

### Supplementary Information:

This device complies with part 15 of the FCC Rules. Operation is subject to the following two conditions: (1) This device may not cause harmful and (2) this device must accept any interference received, including that may cause undesired operation.

Representative Person's Name: ERIC LU

Signature: Eric Lu

Date: Jun. 21, 2006

## **Copyright**

© 2006 GIGA-BYTE TECHNOLOGY CO., LTD. All rights reserved.

The trademarks mentioned in the manual are legally registered to their respective companies.

## **Notice**

The written content provided with this product is the property of Gigabyte.

No part of this manual may be reproduced, copied, translated, or transmitted in any form or by any means without Gigabyte's prior written permission. Specifications and features are subject to change without prior notice.

## **Product Manual Classification**

In order to assist in the use of this product, Gigabyte has categorized the user manual in the following:

- For detailed product information and specifications, please carefully read the "Product User Manual".
- For detailed information related to Gigabyte's unique features, please go to "Technology Guide" section on Gigabyte's website to read or download the information you need.

For more product details, please click onto Gigabyte's website at [www.gigabyte.com.tw](http://www.gigabyte.com.tw)

# Table of Contents

GA-K8VM800M(-RH) Motherboard Layout .....	7
Block Diagram .....	8
Chapter 1 Hardware Installation .....	9
1-1 Considerations Prior to Installation .....	9
1-2 Feature Summary .....	10
1-3 Installation of the CPU and Heatsink .....	12
1-3-1 Installation of the CPU .....	12
1-3-2 Installation of the Heatsink .....	13
1-4 Installation of Memory .....	14
1-5 Installation of Expansion Cards .....	15
1-6 I/O Back Panel Introduction .....	16
1-7 Connectors Introduction .....	17
Chapter 2 BIOS Setup .....	27
The Main Menu (For example: BIOS Ver. : D1) .....	28
2-1 Standard CMOS Features .....	30
2-2 Advanced BIOS Features .....	32
2-3 Integrated Peripherals .....	33
2-4 Power Management Setup .....	36
2-5 PnP/PCI Configurations .....	38
2-6 PC Health Status .....	39
2-7 Frequency / Voltage Control .....	40
2-8 Load Fail-Safe Defaults .....	41
2-9 Load Optimized Defaults .....	41
2-10 Set Supervisor/User Password .....	42
2-11 Save & Exit Setup .....	43
2-12 Exit Without Saving .....	43

Chapter 3 Drivers Installation .....	45
3-1 Install Chipset Drivers .....	45
3-2 Software Application .....	46
3-3 Software Information .....	46
3-4 Hardware Information .....	47
3-5 Contact Us .....	47
 Chapter 4 Appendix .....	 49
4-1 Unique Software Utilities .....	49
4-1-1 EasyTune 5 Introduction .....	50
4-1-2 Xpress Recovery Introduction .....	51
4-1-3 Flash BIOS Method Introduction .....	54
4-1-4 Serial ATA BIOS Setting Utility Introduction .....	63
4-1-5 2 / 4 / 6 Channel Audio Function Introduction .....	70
4-2 Troubleshooting .....	74

# GA-K8VM800M(-RH) Motherboard Layout

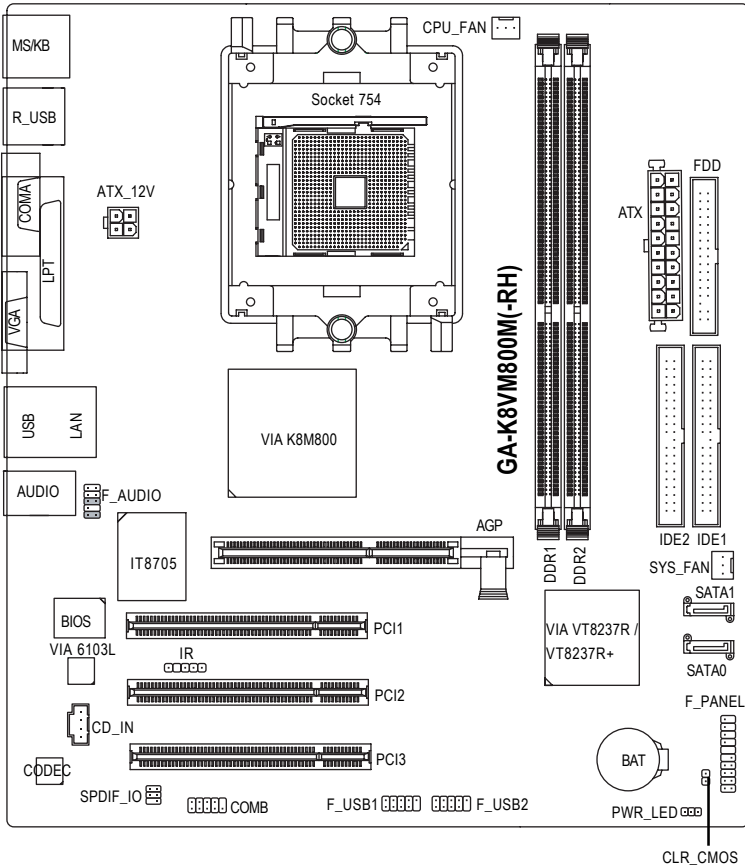

# Block Diagram

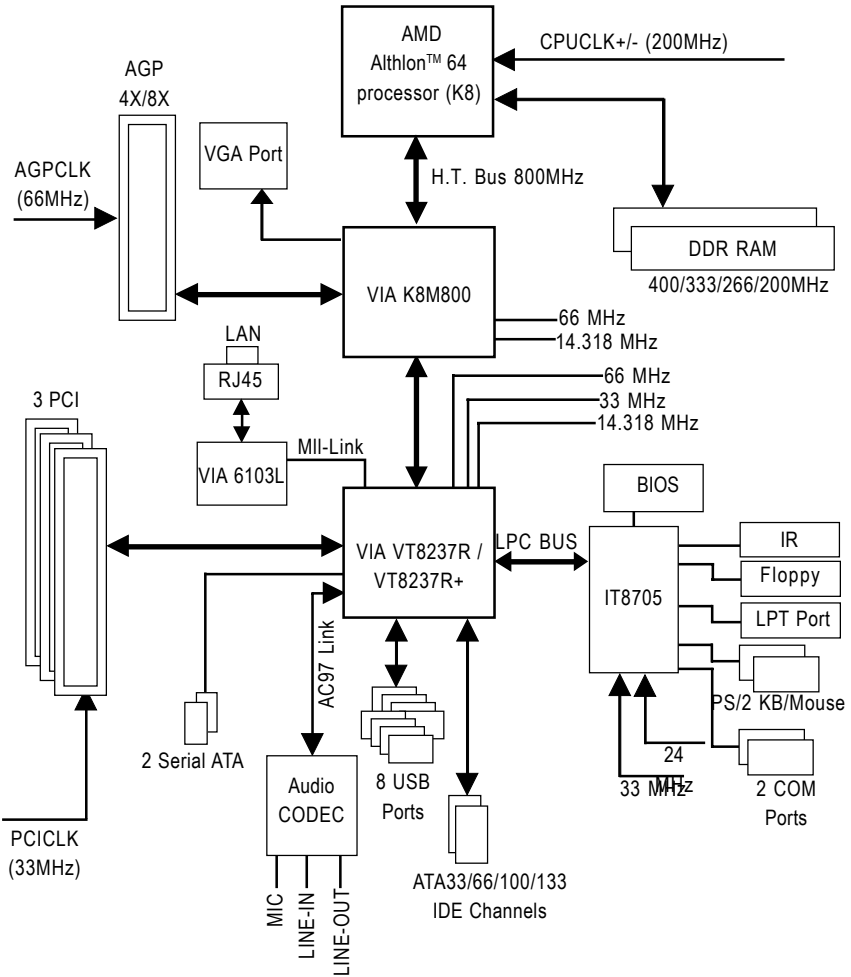



# Chapter 1 Hardware Installation

## 1-1 Considerations Prior to Installation

### Preparing Your Computer

The motherboard contains numerous delicate electronic circuits and components which can become damaged as a result of electrostatic discharge (ESD). Thus, prior to installation, please follow the instructions below:

1. Please turn off the computer and unplug its power cord.
2. When handling the motherboard, avoid touching any metal leads or connectors.
3. It is best to wear an electrostatic discharge (ESD) cuff when handling electronic components (CPU, RAM).
4. Prior to installing the electronic components, please have these items on top of an antistatic pad or within a electrostatic shielding container.
5. Please verify that the power supply is switched off before unplugging the power supply connector from the motherboard.

### Installation Notices

1. Prior to installation, please do not remove the stickers on the motherboard. These stickers are required for warranty validation.
2. Prior to the installation of the motherboard or any hardware, please first carefully read the information in the provided manual.
3. Before using the product, please verify that all cables and power connectors are connected.
4. To prevent damage to the motherboard, please do not allow screws to come in contact with the motherboard circuit or its components.
5. Please make sure there are no leftover screws or metal components placed on the motherboard or within the computer casing.
6. Please do not place the computer system on an uneven surface.
7. Turning on the computer power during the installation process can lead to damage to system components as well as physical harm to the user.
8. If you are uncertain about any installation steps or have a problem related to the use of the product, please consult a certified computer technician.

### Instances of Non-Warranty

1. Damage due to natural disaster, accident or human cause.
2. Damage as a result of violating the conditions recommended in the user manual.
3. Damage due to improper installation.
4. Damage due to use of uncertified components.
5. Damage due to use exceeding the permitted parameters.
6. Product determined to be an unofficial Gigabyte product.

## 1-2 Feature Summary

CPU	<ul style="list-style-type: none"> <li>◆ Socket 754 for AMD Athlon™ 64 processor (K8)</li> <li>◆ 1600MHz system bus</li> <li>◆ Supports core frequencies in excess of 3000+ and faster</li> </ul>
Chipset	<ul style="list-style-type: none"> <li>◆ Northbridge: VIA K8M800</li> <li>◆ Southbridge: VIA VT8237R / VT8237R+</li> </ul>
Memory	<ul style="list-style-type: none"> <li>◆ 2 DDR DIMM memory slots (supports up to 2GB memory)</li> <li>◆ Supports DDR 400<sup>(Note 1)</sup>/333/266/200 DIMM</li> <li>◆ Supports 2.5V DDR DIMM</li> </ul>
Slots	<ul style="list-style-type: none"> <li>◆ 1 AGP slot</li> <li>◆ 3 PCI slots</li> </ul>
IDE Connections	<ul style="list-style-type: none"> <li>◆ 2 IDE connection (UDMA 33/ATA 66/ATA 100/ATA 133), allows connection of 4 IDE devices</li> </ul>
FDD Connections	<ul style="list-style-type: none"> <li>◆ 1 FDD connection, allows connection of 2 FDD devices</li> </ul>
Onboard SATA	<ul style="list-style-type: none"> <li>◆ 2 Serial ATA connections <sup>(Note2)</sup></li> </ul>
Peripherals	<ul style="list-style-type: none"> <li>◆ 1 parallel port supporting Normal/EPP/ECP mode</li> <li>◆ 1 serial port (COMA), 1 VGA port, onboard COMB connection</li> <li>◆ 8 USB 2.0/1.1 ports (rear x 4, front x 4 via cable)</li> <li>◆ 1 front audio connector</li> <li>◆ 1 IR connector</li> <li>◆ 1 PS/2 keyboard port</li> <li>◆ 1 PS/2 mouse port</li> </ul>
On-Board VGA	<ul style="list-style-type: none"> <li>◆ Build in VIA K8M800 Chipset</li> </ul>
Onboard LAN	<ul style="list-style-type: none"> <li>◆ Onboard VIA 6103L chip (10/100 Mbit)</li> <li>◆ 1 RJ 45 port</li> </ul>
Onboard Audio	<ul style="list-style-type: none"> <li>◆ Realtek ALC655 CODEC</li> <li>◆ Supports Line In ; Line Out ; MIC In</li> <li>◆ Supports 2 / 4 / 6 channel audio</li> <li>◆ SPDIF In/Out connection</li> <li>◆ CD In connection</li> </ul>
I/O Control	<ul style="list-style-type: none"> <li>◆ IT8705</li> </ul>

(Note 1) Because of CPU limitations, if you want to install DDR400 memory modules in your system, please install either one double-sided or two single-sided DDR400 memory modules. The DDR400 speed will drop down to DDR333 if you install two double-sided DDR400 memory modules.

(Note 2) It is recommended to use SATA (1.5Gb/s) hard disks.

On-Board SATA RAID	<ul style="list-style-type: none"><li>◆ Built in VIA VT8237R / VT8237R+</li><li>◆ Supports Disk striping (RAID0) or DISK Mirroring (RAID1)</li><li>◆ Supports UDMA up to 150 MB/sec</li><li>◆ Up to 2 SATA Device</li></ul>
Hardware Monitor	<ul style="list-style-type: none"><li>◆ System voltage detection</li><li>◆ CPU temperature detection</li><li>◆ CPU / System fan speed detection</li><li>◆ CPU fan failure warning</li></ul>
BIOS	<ul style="list-style-type: none"><li>◆ Use of licensed AWARD BIOS</li><li>◆ Supports Q-Flash</li></ul>
Additional Features	<ul style="list-style-type: none"><li>◆ Supports @BIOS</li><li>◆ Supports EasyTune <sup>(Note 3)</sup></li></ul>
Overclocking	<ul style="list-style-type: none"><li>◆ Over Clock (CPU) by BIOS</li><li>◆ Over Voltage (CPU/AGP) by BIOS</li></ul>
Form Factor	<ul style="list-style-type: none"><li>◆ Micro ATX form factor; 22.0cm x 24.4cm</li></ul>

(Note 3) EasyTune functions may vary depending on different motherboards.

## 1-3 Installation of the CPU and Heatsink



Before installing the CPU, please comply with the following conditions:

1. Please make sure that the motherboard supports the CPU.
2. Please take note of the one indented corner of the CPU. If you install the CPU in the wrong direction, the CPU will not insert properly. If this occurs, please change the insert direction of the CPU.
3. Please add an even layer of heat sink paste between the CPU and heatsink.
4. Please make sure the heatsink is installed on the CPU prior to system use, otherwise overheating and permanent damage of the CPU may occur.
5. Please set the CPU host frequency in accordance with the processor specifications. It is not recommended that the system bus frequency be set beyond hardware specifications since it does not meet the required standards for the peripherals. If you wish to set the frequency beyond the proper specifications, please do so according to your hardware specifications including the CPU, graphics card, memory, hard drive, etc.

### 1-3-1 Installation of the CPU

Check the processor pins to see that none are bent. Move the socket lever to the unlocked position as shown in Figure 1.(90° to the plane of the motherboard) prior to inserting the processor. The pin 1 location is designated on the processor by a copper triangle that matches up to a triangle on the socket as shown in Figure 2. Align the processor to the socket and gently lower it into place. Do not force the processor into the socket.

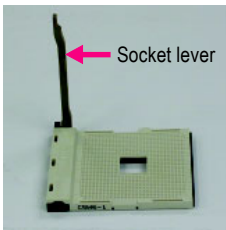

Fig.1  
Position lever at a 90 degree angle.

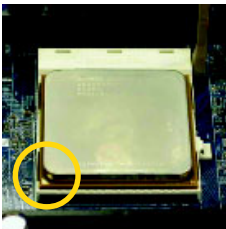

Fig.2  
Pin 1 location on the socket and processor.  
Gently place the CPU into position making sure that the CPU pins fit perfectly into their holes. Once the CPU is positioned into its socket, place one finger down on the middle of the CPU and gently press the metal lever back into its original position.



Please use extra care when installing the CPU. The CPU will not fit if positioned incorrectly. Rather than applying force, please change the positioning of the CPU.

### 1-3-2 Installation of the Heatsink



Fig.1

Before installing the heat sink, please first add an even layer of heat sink paste on the surface of the CPU. Install all the heat sink components (Please refer to the heat sink manual for detailed installation instructions).

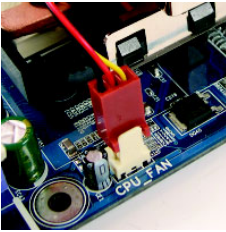

Fig.2

Please connect the heat sink power connector to the CPU\_FAN connector located on the motherboard so that the heat sink can properly function to prevent CPU overheating.



The heat sink may adhere to the CPU as a result of hardening of the heat sink paste. To prevent such an occurrence, it is suggested that either thermal tape rather than heat sink paste be used for heat dissipation or using extreme care when removing the heat sink.

## 1-4 Installation of Memory



Before installing the memory modules, please comply with the following conditions:

1. Please make sure that the memory used is supported by the motherboard. It is recommended that memory of similar capacity, specifications and brand be used.
2. Before installing or removing memory modules, please make sure that the computer power is switched off to prevent hardware damage.
3. Memory modules have a foolproof insertion design. A memory module can be installed in only one direction. If you are unable to insert the module, please switch the direction.

The motherboard supports DDR memory modules, whereby BIOS will automatically detect memory capacity and specifications. Memory modules are designed so that they can be inserted only in one direction. The memory capacity used can differ with each slot.

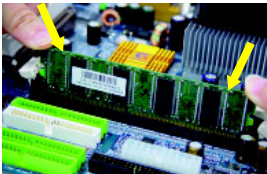
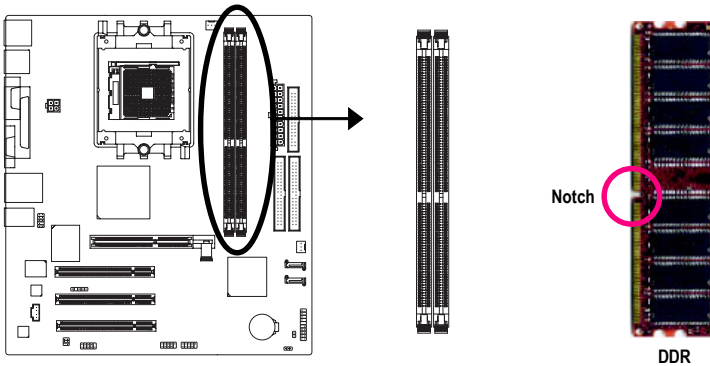

Fig.1

The DIMM socket has a notch, so the DIMM memory module can only fit in one direction. Insert the DIMM memory module vertically into the DIMM socket. Then push it down.



Fig.2

Close the plastic clip at both edges of the DIMM sockets to lock the DIMM module.

Reverse the installation steps when you wish to remove the DIMM module.

## 1-5 Installation of Expansion Cards

You can install your expansion card by following the steps outlined below:

1. Read the related expansion card's instruction document before install the expansion card into the computer.
2. Remove your computer's chassis cover, screws and slot bracket from the computer.
3. Press the expansion card firmly into expansion slot in motherboard.
4. Be sure the metal contacts on the card are indeed seated in the slot.
5. Replace the screw to secure the slot bracket of the expansion card.
6. Replace your computer's chassis cover.
7. Power on the computer, if necessary, setup BIOS utility of expansion card from BIOS.
8. Install related driver from the operating system.

Installing a AGP expansion card:



Please carefully pull out the small white-drawable bar at the end of the AGP slot when you try to install/uninstall the VGA card. Please align the VGA card to the onboard AGP slot and press firmly down on the slot. Make sure your VGA card is locked by the small white-drawable bar.

## 1-6 I/O Back Panel Introduction

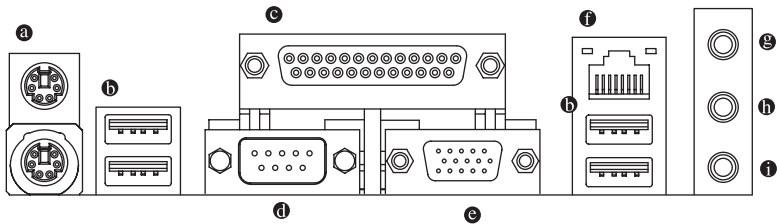

### Ⓐ PS/2 Keyboard and PS/2 Mouse Connector

To install a PS/2 port keyboard and mouse, plug the mouse to the upper port (green) and the keyboard to the lower port (purple).

### Ⓑ USB port

Before you connect your device(s) into USB connector(s), please make sure your device(s) such as USB keyboard, mouse, scanner, zip, speaker...etc. have a standard USB interface. Also make sure your OS supports USB controller. If your OS does not support USB controller, please contact OS vendor for possible patch or driver upgrade. For more information please contact your OS or device(s) vendors.

### Ⓒ Parallel Port

The parallel port allows connection of a printer, scanner and other peripheral devices.

### Ⓓ COM A (Serial Port)

Connects to serial-based mouse or data processing devices.

### Ⓔ VGA Port

Monitor can be connected to VGA port.

### Ⓕ LAN Port

The provided Internet connection is fast Ethernet, providing data transfer speeds of 10/100Mbps.

### Ⓖ Line In

Devices like CD-ROM, walkman etc. can be connected to Line In jack.

### Ⓗ Line Out (Front Speaker Out)

Connect the stereo speakers, earphone or front surround channels to this connector.

### Ⓖ MIC In

Microphone can be connected to MIC In jack.



NOTE You can use audio software to configure 2-/4-/6- channel audio functioning.



## 1-7 Connectors Introduction

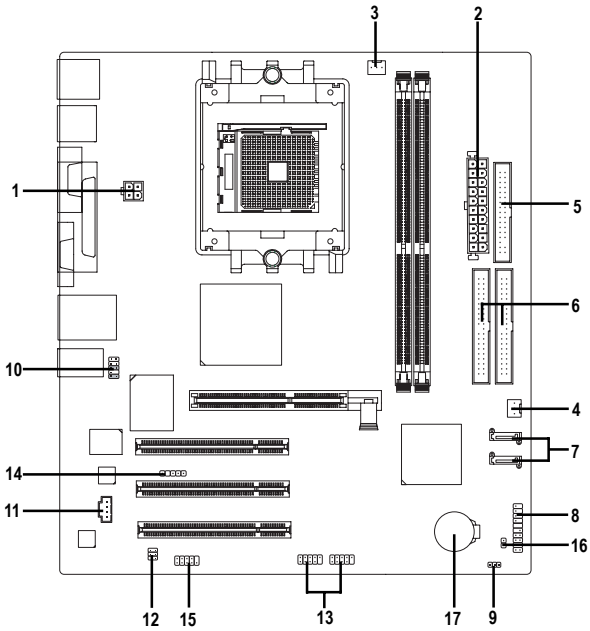

1) ATX_12V	10) F_AUDIO
2) ATX (Power Connector)	11) CD_IN
3) CPU_FAN	12) SPDIF_IO
4) SYS_FAN	13) F_USB1 / F_USB2
5) FDD	14) IR
6) IDE1 / IDE2	15) COMB
7) SATA0 / SATA1	16) CLR_CMOS
8) F_PANEL	17) BAT
9) PWR_LED	

## 1/2) ATX\_12V / ATX (Power Connector)

With the use of the power connector, the power supply can supply enough stable power to all the components on the motherboard. Before connecting the power connector, please make sure that all components and devices are properly installed. Align the power connector with its proper location on the motherboard and connect tightly.

The ATX\_12V power connector mainly supplies power to the CPU. If the ATX\_12V power connector is not connected, the system will not start.

Caution!

Please use a power supply that is able to handle the system voltage requirements. It is recommended that a power supply that can withstand high power consumption be used (300W or greater). If a power supply is used that does not provide the required power, the result can lead to an unstable system or a system that is unable to start.

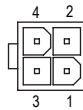
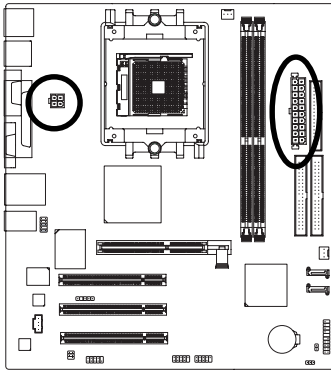

Pin No.	Definition
1	GND
2	GND
3	+12V
4	+12V

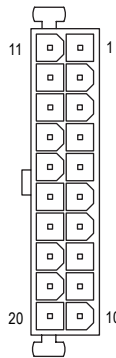

Pin No.	Definition
1	3.3V
2	3.3V
3	GND
4	VCC
5	GND
6	VCC
7	GND
8	Power Good
9	5V SB (stand by +5V)
10	+12V
11	3.3V
12	-12V
13	GND
14	PS_ON(soft on/off)
15	GND
16	GND
17	GND
18	-5V
19	+5V
20	+5V

### 3/4) CPU\_FAN / SYS\_FAN (Cooler Fan Power Connector)

The cooler fan power connector supplies a +12V power voltage via a 3-pin power connector and possesses a foolproof connection design.

Most coolers are designed with color-coded power connector wires. A red power connector wire indicates a positive connection and requires a +12V power voltage. The black connector wire is the ground wire (GND).

Please remember to connect the power to the cooler to prevent system overheating and failure.

Caution!

Please remember to connect the power to the CPU fan to prevent CPU overheating and failure.

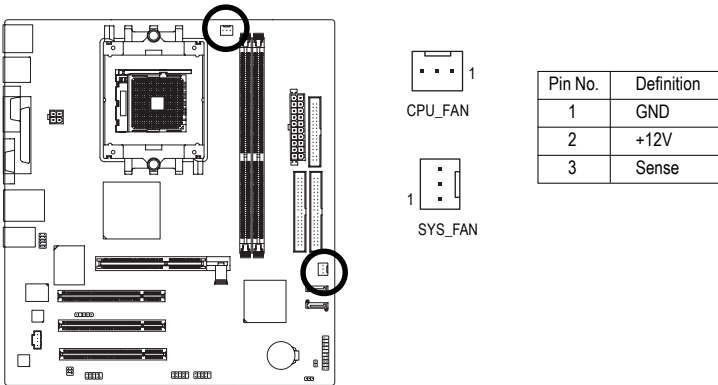

### 5) FDD (FDD Connector)

The FDD connector is used to connect the FDD cable while the other end of the cable connects to the FDD drive. The types of FDD drives supported are: 360KB, 720KB, 1.2MB, 1.44MB and 2.88MB. Before attaching the FDD cable, please take note of the foolproof groove in the FDD connector.

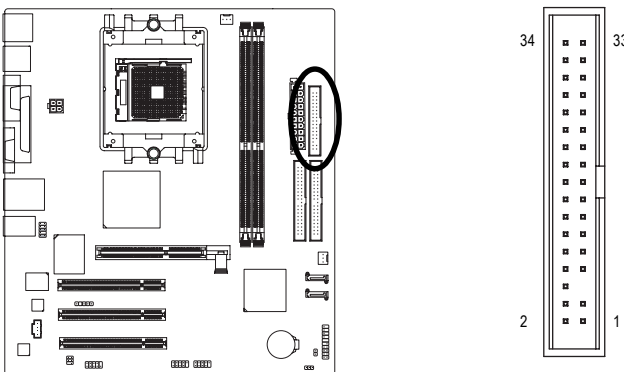

## 6) IDE1 / IDE2 (IDE Connector)

An IDE device connects to the computer via an IDE connector. One IDE connector can connect to one IDE cable, and the single IDE cable can then connect to two IDE devices (hard drive or optical drive). If you wish to connect two IDE devices, please set the jumper on one IDE device as Master and the other as Slave (for information on settings, please refer to the instructions located on the IDE device). Before attaching the IDE cable, please take note of the foolproof groove in the IDE connector.

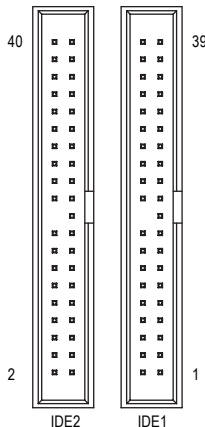
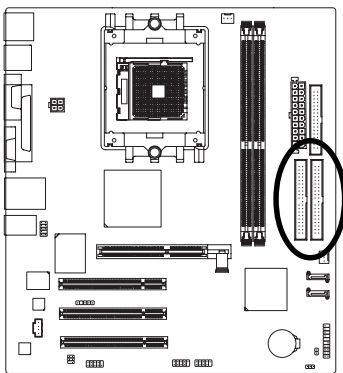

## 7) SATA0 / SATA1 (Serial ATA Connector)

Serial ATA can provide up to 150MB/s transfer rate. Please refer to the BIOS setting for the Serial ATA and install the proper driver in order to work properly.

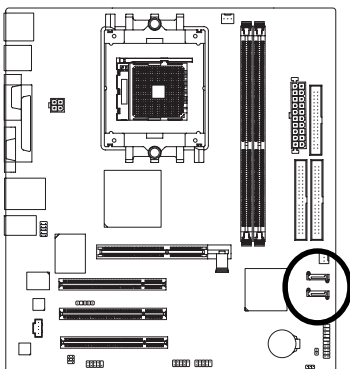

Pin No.	Definition
1	GND
2	TXP
3	TXN
4	GND
5	RXN
6	RXP
7	GND

### 8) F\_PANEL (Front Panel Jumper)

Please connect the power LED, PC speaker, reset switch and power switch etc of your chassis front panel to the F\_PANEL connector according to the pin assignment below.

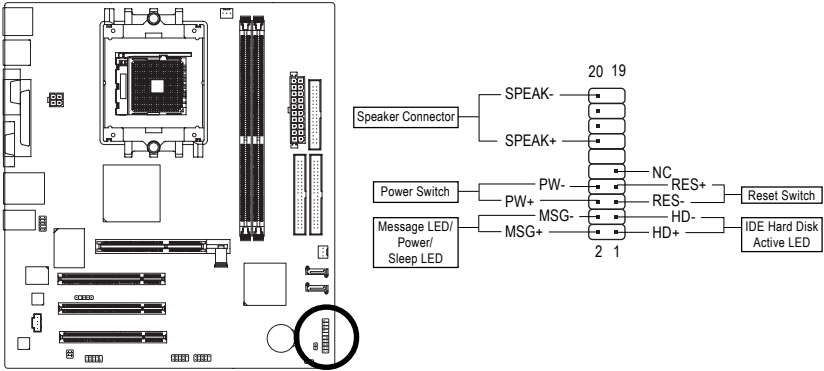

HD (IDE Hard Disk Active LED)	Pin 1: LED anode(+) Pin 2: LED cathode(-)
SPEAK (Speaker Connector)	Pin 1: Power Pin 2- Pin 3: NC Pin 4: Data(-)
RES (Reset Switch)	Open: Normal Close: Reset Hardware System
PW (Power Switch)	Open: Normal Close: Power On/Off
MSG(Message LED/Power/Sleep LED)	Pin 1: LED anode(+) Pin 2: LED cathode(-)
NC	NC

## 9) PWR\_LED

The PWR\_LED connector is connected with the system power indicator to indicate whether the system is on/off. It will blink when the system enters suspend mode.

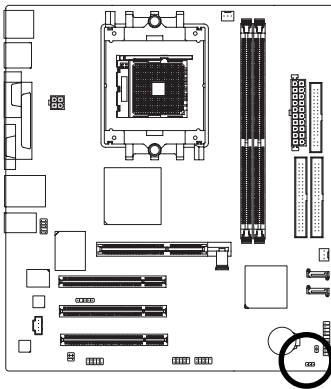

Pin No.	Definition
1	MPD+
2	MPD-
3	MPD-

## 10) F\_AUDIO (Front Audio Panel Connector)

If you want to use Front Audio connector, you must remove 5-6, 9-10 Jumper.

In order to utilize the front audio header, your chassis must have front audio connector. Also please make sure the pin assignments for the cable are the same as the pin assignments for the front audio header. To find out if the chassis you are buying support front audio connector, please contact your dealer. Please note, you can have the alternative of using front audio connector or of using rear audio connector to play sound.

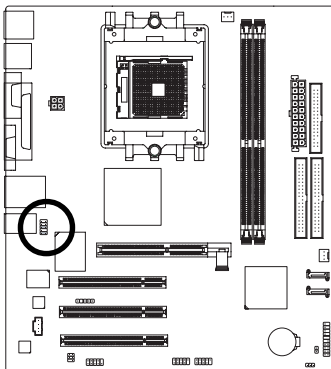

Pin No.	Definition
1	MIC
2	GND
3	MIC_BIAS
4	POWER
5	FrontAudio(R)
6	Rear Audio (R)/ Return R
7	NC
8	No Pin
9	FrontAudio (L)
10	Rear Audio (L)/ Return L

## 11) CD\_IN (CD In Connector)

Connect CD-ROM or DVD-ROM audio out to the connector.

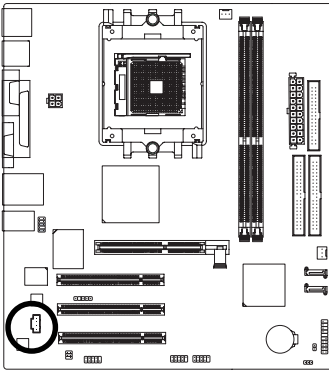

Pin No.	Definition
1	CD-L
2	GND
3	GND
4	CD-R

## 12) SPDIF\_IO (SPDIF In/ Out)

The SPDIF output is capable of providing digital audio to external speakers or compressed AC3 data to an external Dolby Digital Decoder. Use this feature only when your stereo system has digital input function. Use SPDIF IN feature only when your device has digital output function.

Be careful with the polarity of the SPDIF\_IO connector. Check the pin assignment carefully while you connect the SPDIF cable. Incorrect connection between the cable and connector will make the device unable to work or even damage it. For optional SPDIF cable, please contact your local dealer.

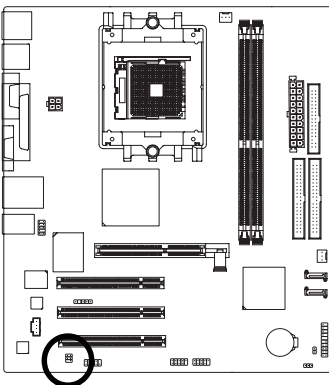

Pin No.	Definition
1	Power
2	No Pin
3	SPDIF
4	SPDIFI
5	GND
6	GND

### 13) F\_USB1 / F\_USB2 (Front USB Connector)

Be careful with the polarity of the front USB connector. Check the pin assignment carefully while you connect the front USB cable, incorrect connection between the cable and connector will make the device unable to work or even damage it. For optional front USB cable, please contact your local dealer.

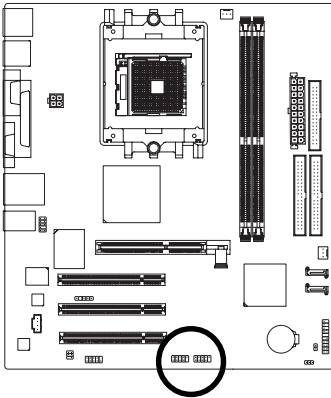

Pin No.	Definition
1	Power
2	Power
3	USB DX-
4	USB Dy-
5	USB DX+
6	USB Dy+
7	GND
8	GND
9	No Pin
10	NC

### 14) IR

Be careful with the polarity of the IR connector while you connect the IR. Please contact your nearest dealer for optional IR device.

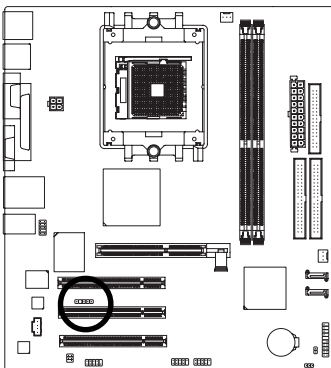

Pin No.	Definition
1	Power
2	No Pin
3	IR RX
4	GND
5	IR TX



## 15) COMB (COMB Connector)

Be careful with the polarity of the COMB connector. Check the pin assignments while you connect the COMB cable. Please contact your nearest dealer for optional COMB cable.

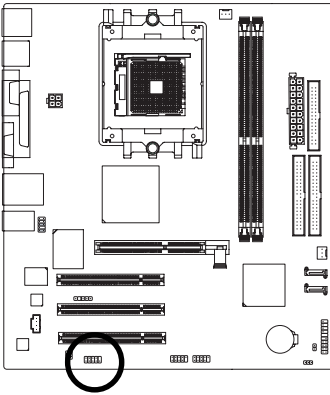



Pin No.	Definition
1	NDCDB-
2	NSINB
3	NSOUTB
4	NDTRB-
5	GND
6	NDSRB-
7	NRTSB-
8	NCTSB-
9	NRIB-
10	No Pin

## 16) CLR\_CMOS (Clear CMOS)

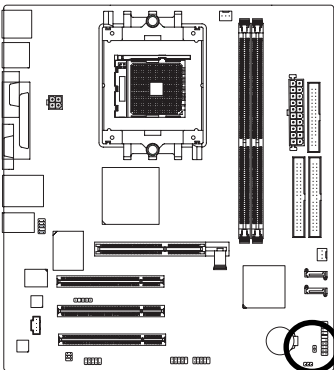
You may clear the CMOS data to its default values by this jumper. To clear CMOS, temporarily short 1-2 pin. Default doesn't include the "Shunter" to prevent from improper use this jumper.



1  Open: Normal

1  Short: Clear CMOS

## 17) BAT (Battery)

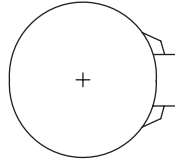
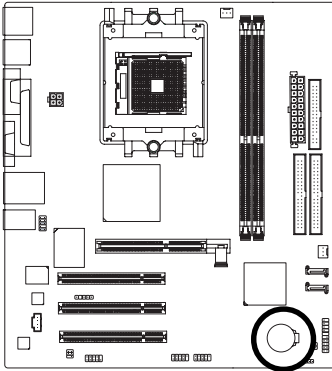

- ❖ Danger of explosion if battery is incorrectly replaced.
- ❖ Replace only with the same or equivalent type recommended by the manufacturer.
- ❖ Dispose of used batteries according to the manufacturer's instructions.

If you want to erase CMOS...

1. Turn off the computer and unplug the power cord.
2. Gently take out the battery and put it aside for about one minute.  
(Or you can use a metal object to connect the positive and negative pins in the battery holder to make them short for five seconds.)
3. Re-install the battery.
4. Plug the power cord in and turn on the computer.

## Chapter 2 BIOS Setup

BIOS (Basic Input and Output System) includes a CMOS SETUP utility which allows user to configure required settings or to activate certain system features.

The CMOS SETUP saves the configuration in the CMOS SRAM of the motherboard.

When the power is turned off, the battery on the motherboard supplies the necessary power to the CMOS SRAM.

When the power is turned on, pushing the <Del> button during the BIOS POST (Power-On Self Test) will take you to the CMOS SETUP screen. You can enter the BIOS setup screen by pressing "Ctrl + F1".

When setting up BIOS for the first time, it is recommended that you save the current BIOS to a disk in the event that BIOS needs to be reset to its original settings. If you wish to upgrade to a new BIOS, either GIGABYTE's Q-Flash or @BIOS utility can be used.

Q-Flash allows the user to quickly and easily update or backup BIOS without entering the operating system. @BIOS is a Windows-based utility that does not require users to boot to DOS before upgrading BIOS but directly download and update BIOS from the Internet.

### CONTROL KEYS

<↑> <↓> <←> <→>	Move to select item
<Enter>	Select Item
<Esc>	Main Menu - Quit and not save changes into CMOS Status Page Setup Menu and Option Page Setup Menu - Exit current page and return to Main Menu
<Page Up>	Increase the numeric value or make changes
<Page Down>	Decrease the numeric value or make changes
<F1>	General help, only for Status Page Setup Menu and Option Page Setup Menu
<F2>	Item Help
<F5>	Restore the previous CMOS value from CMOS, only for Option Page Setup Menu
<F6>	Load the fail-safe default CMOS value from BIOS default table
<F7>	Load the Optimized Defaults
<F8>	Q-Flash utility
<F9>	System Information
<F10>	Save all the CMOS changes, only for Main Menu

### Main Menu

The on-line description of the highlighted setup function is displayed at the bottom of the screen.

### Status Page Setup Menu / Option Page Setup Menu

Press <F1> to pop up a small help window that describes the appropriate keys to use and the possible selections for the highlighted item. To exit the Help Window press <Esc>.



The BIOS Setup menus described in this chapter are for reference only and may differ from the exact settings for your motherboard.

## The Main Menu (For example: BIOS Ver. : D1)

Once you enter Award BIOS CMOS Setup Utility, the Main Menu (as figure below) will appear on the screen. Use arrow keys to select among the items and press <Enter> to accept or enter the sub-menu.

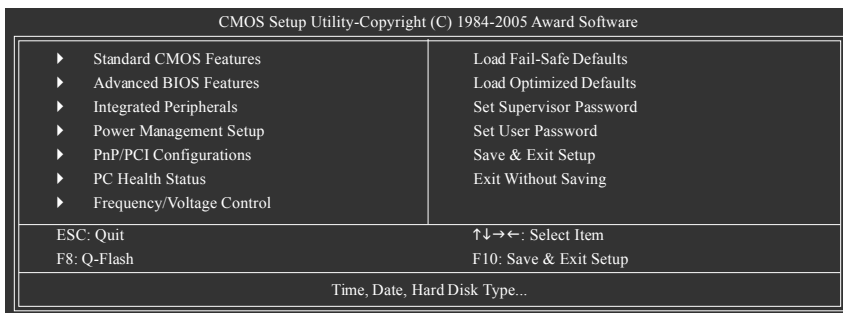

If you can't find the setting you want, please press "Ctrl+F1" to search the advanced option hidden.

### ■ Standard CMOS Features

This setup page includes all the items in standard compatible BIOS.

### ■ Advanced BIOS Features

This setup page includes all the items of Award special enhanced features.

### ■ Integrated Peripherals

This setup page includes all onboard peripherals.

### ■ Power Management Setup

This setup page includes all the items of Green function features.

### ■ PnP/PCI Configuration

This setup page includes all the configurations of PCI & PnP ISA resources.

### ■ PC Health Status

This setup page is the System auto detect Temperature, voltage, fan, speed.

### ■ Frequency/Voltage Control

This setup page is control CPU's clock and frequency ratio.

### ■ Load Fail-Safe Defaults

Fail-Safe Defaults indicates the value of the system parameters which the system would be in safe configuration.

**■ Load Optimized Defaults**

Optimized Defaults indicates the value of the system parameters which the system would be in best performance configuration.

**■ Set Supervisor Password**

Change, set, or disable password. It allows you to limit access to the system and Setup, or just to Setup.

**■ Set User Password**

Change, set, or disable password. It allows you to limit access to the system.

**■ Save & Exit Setup**

Save CMOS value settings to CMOS and exit setup.

**■ Exit Without Saving**

Abandon all CMOS value changes and exit setup.

## 2-1 Standard CMOS Features

CMOS Setup Utility-Copyright (C) 1984-2005 Award Software Standard CMOS Features			Item Help
Date (mm:dd:yy)	Wed, May 11 2005		Menu Level▶
Time (hh:mm:ss)	10:40:9		Change the day, month, year
▶ IDE Channel 0 Master	[None]		<Week>
▶ IDE Channel 0 Slave	[None]		Sun. to Sat.
▶ IDE Channel 1 Master	[None]		<Month>
▶ IDE Channel 1 Slave	[None]		Jan. to Dec.
▶ IDE Channel 2 Master	[None]		<Day>
▶ IDE Channel 2 Slave	[None]		1 to 31 (or maximum allowed in the month)
▶ IDE Channel 3 Master	[None]		<Year>
			1999 to 2098
Drive A	[1.44M, 3.5"]		
Drive B	[None]		
Floppy 3 Mode Support	[Disabled]		
Holt On	[All, But Keyboard]		
Base Memory	640K		
Extended Memory	127M		
Total Memory	128M		
↑↓→←: Move    Enter: Select    +/-/PU/PD: Value    F10: Save    ESC: Exit    F1: General Help F5: Previous Values    F6: Fail-Safe Defaults    F7: Optimized Defaults			

### ☞ Date

The date format is <week>, <month>, <day>, <year>.

- ▶▶ Week      The week, from Sun to Sat, determined by the BIOS and is display only
- ▶▶ Month     The month, Jan. Through Dec.
- ▶▶ Day        The day, from 1 to 31 (or the maximum allowed in the month)
- ▶▶ Year        The year, from 1999 through 2098

### ☞ Time

The times format in <hour> <minute> <second>. The time is calculated base on the 24-hour military-time clock. For example, 1 p.m. is 13:00:00.

### ☞ IDE Channel 0/1 Master, Slave

- ▶▶ IDE HDD Auto-Detection Press "Enter" to select this option for automatic device detection.
- ▶▶ IDE Device Setup. You can use one of three methods:
  - Auto          Allows BIOS to automatically detect IDE devices during POST.(default)
  - None         Select this if no IDE devices are used and the system will skip the automatic detection step and allow for faster system start up.
  - Manual       User can manually input the correct settings
- ▶▶ Access Mode    Use this to set the access mode for the hard drive. The four options are: CHS/LBA/Large/Auto(default:Auto)

### ☞ IDE Channel 2/3 Master

- ▶▶ IDE HDD Auto-Detection Press "Enter" to select this option for automatic device detection.
- ▶▶ Extended IDE Drive SATA devices setup. You can use one of two methods:
  - Auto          Allows BIOS to automatically detect SATA IDE devices during POST. (Default value)
  - None         Select this if no SATA IDE devices are used and the system will skip the automatic detection step and allow for faster system start up.
- ▶▶ Access Mode    Use this to set the access mode for the hard drive. The two options are: Large/Auto(default:Auto)

- » Capacity Capacity of currently installed hard disk.

Hard drive information should be labeled on the outside drive casing. Enter the appropriate option based on this information.

- » Cylinder Number of cylinders
- » Head Number of heads
- » Precomp Write precomp
- » Landing Zone Landing zone
- » Sector Number of sectors

### ☞ Drive A / Drive B

The category identifies the types of floppy disk drive A or drive B that has been installed in the computer.

- » None No floppy drive installed
- » 360K, 5.25" 5.25 inch PC-type standard drive; 360K byte capacity.
- » 1.2M, 5.25" 5.25 inch AT-type high-density drive; 1.2M byte capacity (3.5 inch when 3 Mode is Enabled).
- » 720K, 3.5" 3.5 inch double-sided drive; 720K byte capacity
- » 1.44M, 3.5" 3.5 inch double-sided drive; 1.44M byte capacity. (Default value)
- » 2.88M, 3.5" 3.5 inch double-sided drive; 2.88M byte capacity.

### ☞ Floppy 3 Mode Support (for Japan Area)

- » Disabled Normal Floppy Drive. (Default value)
- » Drive A Drive A is 3 mode Floppy Drive.
- » Drive B Drive B is 3 mode Floppy Drive.
- » Both Drive A & B are 3 mode Floppy Drives.

### ☞ Halt on

The category determines whether the computer will stop if an error is detected during power up.

- » No Errors The system boot will not stop for any error that may be detected and you will be prompted.
- » All Errors Whenever the BIOS detects a non-fatal error the system will be stopped.
- » All, But Keyboard The system boot will not stop for a keyboard error; it will stop for all other errors. (Default value)
- » All, But Diskette The system boot will not stop for a disk error; it will stop for all other errors.
- » All, But Disk/Key The system boot will not stop for a keyboard or disk error; it will stop for all other errors.

### ☞ Memory

The category is display-only which is determined by POST (Power On Self Test) of the BIOS.

#### » Base Memory

The POST of the BIOS will determine the amount of base (or conventional) memory installed in the system.

The value of the base memory is typically 512K for systems with 512K memory installed on the motherboard, or 640K for systems with 640K or more memory installed on the motherboard.

#### » Extended Memory

The BIOS determines how much extended memory is present during the POST.

This is the amount of memory located above 1 MB in the CPU's memory address map.

#### » Total Memory

This item displays the memory size that used.

## 2-2 Advanced BIOS Features

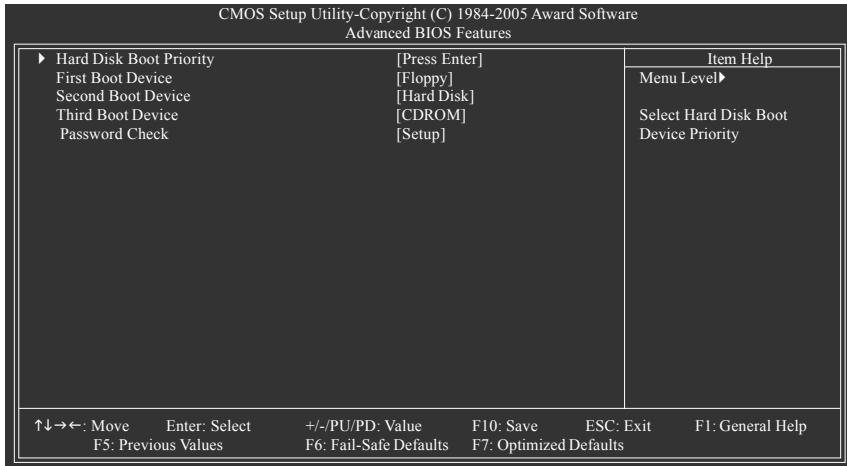

### ☞ Hard Disk Boot Priority

Select boot sequence for onboard(or add-on cards) SCSI, RAID, etc.

Use <↑> or <↓> to select a device, then press<+> to move it up, or <-> to move it down the list. Press <ESC> to exit this menu.

### ☞ First / Second / Third Boot Device

- ▶▶ Floppy      Select your boot device priority by Floppy.
- ▶▶ LS120      Select your boot device priority by LS120.
- ▶▶ Hard Disk    Select your boot device priority by Hard Disk.
- ▶▶ CDROM      Select your boot device priority by CDROM.
- ▶▶ ZIP          Select your boot device priority by ZIP.
- ▶▶ USB-FDD    Select your boot device priority by USB-FDD.
- ▶▶ USB-ZIP     Select your boot device priority by USB-ZIP.
- ▶▶ USB-CDROM   Select your boot device priority by USB-CDROM.
- ▶▶ USB-HDD    Select your boot device priority by USB-HDD.
- ▶▶ Legacy LAN   Select your boot device priority by Legacy LAN.
- ▶▶ Disabled    Disable this function.

### ☞ Password Check

- ▶▶ System      The system can not boot and can not access to Setup page will be denied if the correct password is not entered at the prompt.
- ▶▶ Setup        The system will boot, but access to Setup will be denied if the correct password is not entered at the prompt. (Default value)



## 2-3 Integrated Peripherals

CMOS Setup Utility-Copyright (C) 1984-2005 Award Software  
Integrated Peripherals

IDE DMA transfer access	[Enabled]	Item Help
On-Chip IDE Channel 0	[Enabled]	Menu Level▶
On-Chip IDE Channel 1	[Enabled]	
OnChip Serial ATA	[Enabled]	
SATA Mode	[RAID]	
AC97 Audio	[Auto]	
VIA Onboard LAN	[Enabled]	
USB 1.1 Controller	[Enabled]	
USB 2.0 Controller	[Enabled]	
USB Keyboard Support	[Disabled]	
USB Mouse Support	[Disabled]	
On-Chip LAN Boot ROM	[Disabled]	
Onboard FDC Controller	[Enabled]	
Onboard Serial Port 1	[3F8/IRQ4]	
Onboard Serial Port 2	[2F8/IRQ3]	
UART Mode Select	[Normal]	
x UR2 Duplex Mode	Half	
Onboard Parallel Port	[378/IRQ7]	
Parallel Port Mode	[SPP]	

↑↓→←: Move    Enter: Select    +/-/PU/PD: Value    F10: Save    ESC: Exit    F1: General Help  
F5: Previous Values    F6: Fail-Safe Defaults    F7: Optimized Defaults

CMOS Setup Utility-Copyright (C) 1984-2005 Award Software  
Integrated Peripherals

Midi Port Address	[Disabled]	Item Help
x Midi Port IRQ	10	Menu Level▶

↑↓→←: Move    Enter: Select    +/-/PU/PD: Value    F10: Save    ESC: Exit    F1: General Help  
F5: Previous Values    F6: Fail-Safe Defaults    F7: Optimized Defaults

### ☞ IDE DMA transfer access

- ▶▶ Enabled      Enable IDE DMA transfer access. (Default value)
- ▶▶ Disabled     Disable this function.

### ☞ On-Chip IDE Channel0

- ▶▶ Enabled      Enable onboard 1st channel IDE port. (Default value)
- ▶▶ Disabled     Disable onboard 1st channel IDE port.

### ☞ On-Chip IDE Channel1

- ▶▶ Enabled      Enable onboard 2nd channel IDE port. (Default value)
- ▶▶ Disabled     Disable onboard 2nd channel IDE port.

### ☞ OnChip Serial ATA

- ▶▶ Enabled Enable VT8237R / VT8237R+ Serial ATA supported. (Default value)
- ▶▶ Disabled Disable VT8237R / VT8237R+ Serial ATA supported.

### ☞ SATA Mode

- ▶▶ RAID Set onboard SATA mode to RAID. (Default value)
- ▶▶ IDE Set onboard SATA mode to IDE.

### ☞ AC97 Audio

- ▶▶ Auto Enable onboard AC'97 audio function. (Default value)
- ▶▶ Disabled Disable this function.

### ☞ VIA Onboard LAN

- ▶▶ Enabled Enable VIA onboard LAN function. (Default value)
- ▶▶ Disabled Disable this function.

### ☞ USB 1.1 Controller

- ▶▶ Disabled Disable USB 1.1 controller.
- ▶▶ Enabled Enable USB 1.1 controller. (Default value)

### ☞ USB 2.0 Controller

- ▶▶ Disabled Disable USB 2.0 controller.
- ▶▶ Enabled Enable USB 2.0 controller. (Default value)

### ☞ USB Keyboard Support

- ▶▶ Enabled Enable USB keyboard support.
- ▶▶ Disabled Disable USB keyboard support. (Default value)

### ☞ USB Mouse Support

- ▶▶ Enabled Enable USB mouse support.
- ▶▶ Disabled Disable USB mouse support. (Default value)

### ☞ On-Chip LAN Boot ROM

This function decide whether to invoke the boot ROM of the onboard LAN chip.

- ▶▶ PXE Set On-Chip LAN Boot ROM to PXE.
- ▶▶ RPL Set On-Chip LAN Boot ROM to RPL.
- ▶▶ Disabled Disable this function. (Default value)

### ☞ Onboard FDC Controller

- ▶▶ Enabled Enable onboard FDC Controller. (Default value)
- ▶▶ Disabled Disable onboard FDC Controller.

### ☞ Onboard Serial Port 1

- ▶▶ Auto BIOS will automatically setup the Serial port 1 address.
- ▶▶ 3F8/IRQ4 Enable onboard Serial port 1 and address is 3F8/IRQ4. (Default value)
- ▶▶ 2F8/IRQ3 Enable onboard Serial port 1 and address is 2F8/IRQ3.
- ▶▶ 3E8/IRQ4 Enable onboard Serial port 1 and address is 3E8/IRQ4.
- ▶▶ 2E8/IRQ3 Enable onboard Serial port 1 and address is 2E8/IRQ3.
- ▶▶ Disabled Disable onboard Serial port 1.

### ☞ Onboard Serial Port 2

- ▶▶ Auto BIOS will automatically set up the Serial port 2 address.
- ▶▶ 3F8/IRQ4 Enable onboard Serial port 2 and address is 3F8/IRQ4.
- ▶▶ 2F8/IRQ3 Enable onboard Serial port 2 and address is 2F8/IRQ3. (Default value)
- ▶▶ 3E8/IRQ4 Enable onboard Serial port 2 and address is 3E8/IRQ4.
- ▶▶ 2E8/IRQ3 Enable onboard Serial port 2 and address is 2E8/IRQ3.
- ▶▶ Disabled Disable onboard Serial port 2.

### ☞ UART Mode Select

This item allows you to determine which Infra Red(IR) function of Onboard I/O chip.

- ▶▶ Normal Set onboard I/O chip UART to Normal mode.(Default value)
- ▶▶ IrDA Set onboard I/O chip UART to IrDA mode.
- ▶▶ ASKIR Set onboard I/O chip UART to ASKIR mode.

### ☞ UR2 Duplex Mode

This feature allows you to select IR mode.

This function is available only when UART Mode Select is not set to Normal.

- ▶▶ Half IR Function Duplex Half. (Default value)
- ▶▶ Full IR Function Duplex Full.

### ☞ Onboard Parallel Port

- ▶▶ Disabled Disable onboard LPT port.
- ▶▶ 378/IRQ7 Enable onboard LPT port and address is 378/IRQ7. (Default value)
- ▶▶ 278/IRQ5 Enable onboard LPT port and address is 278/IRQ5.
- ▶▶ 3BC/IRQ7 Enable onboard LPT port and address is 3BC/IRQ7.

### ☞ Parallel Port Mode

- ▶▶ SPP Using Parallel port as Standard Parallel Port. (Default value)
- ▶▶ EPP Using Parallel port as Enhanced Parallel Port.
- ▶▶ ECP Using Parallel port as Extended Capabilities Port.
- ▶▶ ECP+EPP Using Parallel port as ECP and EPP mode.

### ☞ Midi Port Address

- ▶▶ 300 Set Midi Port Address to 300.
- ▶▶ 330 Set Midi Port Address to 330
- ▶▶ Disabled Disable this function. (Default value)

### ☞ Midi Port IRQ

- ▶▶ 5 Set Midi Port IRQ to 5.
- ▶▶ 10 Set Midi Port IRQ to 10. (Default value)

## 2-4 Power Management Setup

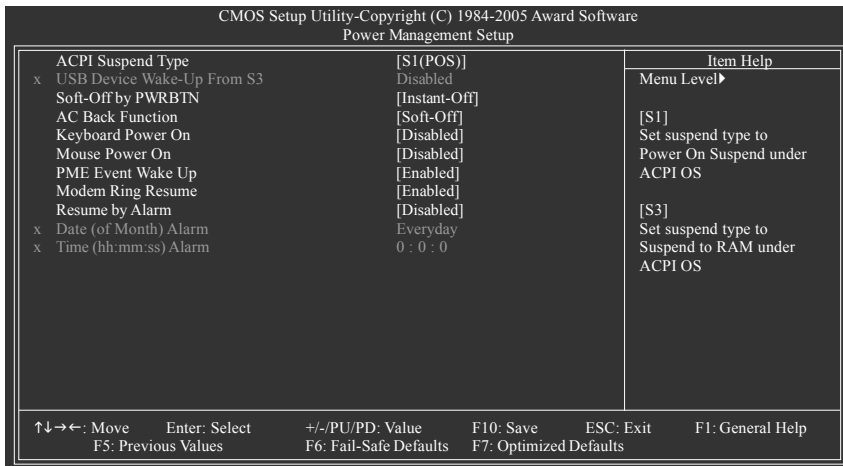

### ☞ ACPI Suspend Type

- ▶▶ S1(POS)    Set ACPI suspend type to S1/POS(Power On Suspend). (Default value)
- ▶▶ S3(STR)    Set ACPI suspend type to S3/STR(Suspend To RAM).

### ☞ USB Device Wake-Up From S3

- ▶▶ Disabled    Disable USB Device Wake-Up from S3. (Default value)
- ▶▶ Enabled    Enable USB Device Wake-Up from S3.

### ☞ Soft-Off by PWRBTN

- ▶▶ Instant-Off    Press power button then Power off instantly. (Default value)
- ▶▶ Delay 4 Sec.    Press power button 4 sec. to Power off. Enter suspend if button is pressed less than 4 sec.

### ☞ AC BACK Function

- ▶▶ Memory    When AC-power back to the system, the system will be back to the last state before AC-power is lost.
- ▶▶ Soft-Off    When AC-power back to the system, the system will be in "Off" state. (Default value)
- ▶▶ Full-On    When AC-power back to the system, the system always in "On" state.

### ☞ Keyboard Power On

- ▶▶ Password    Enter from 1 to 8 characters to set the Keyboard Power On Password.
- ▶▶ Disabled    Disabled this function. (Default value)
- ▶▶ Keyboard 98    If your keyboard have "POWER Key" button, you can press the key to power on the system.

### ☞ **Mouse Power On**

- ▶▶ Disabled      Disabled this function. (Default value)
- ▶▶ Enabled      Double click on PS/2 mouse left button to power on the system.

### ☞ **PME Event Wake Up**

This feature requires an ATX power supply that provides at least 1A on the 5VSB lead.

- ▶▶ Disabled      Disable this function.
- ▶▶ Enabled      Enable PME as wake up event. (Default value)

### ☞ **Modem Ring Resume**

An incoming call via modem can awake the system from any suspend state.

- ▶▶ Disabled      Disable Modem Ring Resume function.
- ▶▶ Enabled      Enable Modem Ring Resume function. (Default value)

### ☞ **Resume by Alarm**

You can set "Resume by Alarm" item to enabled and key in Date/Time to power on system.

- ▶▶ Disabled      Disable this function. (Default value)
- ▶▶ Enabled      Enable alarm function to POWER ON system.

If Resume by Alarm is Enabled.

- ▶▶ Date (of Month) Alarm :      Everyday, 1~31
- ▶▶ Time (hh: mm: ss) Alarm:      (0~23) : (0~59) : (0~59)

## 2-5 PnP/PCI Configurations

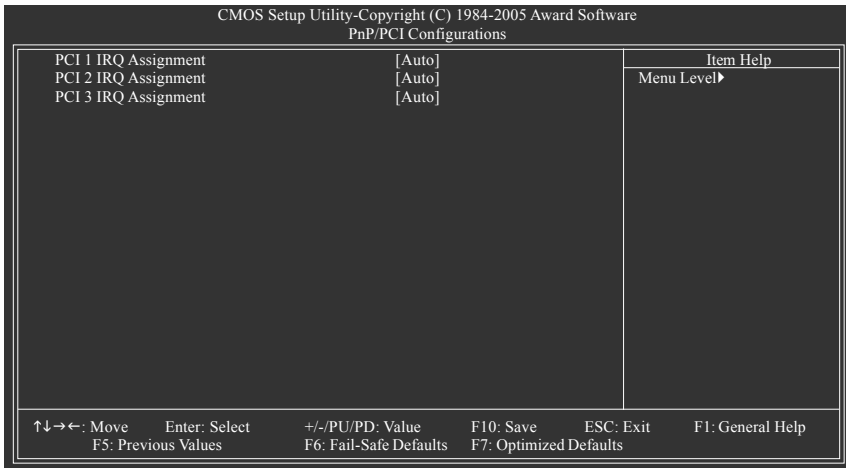

### PCI 1 IRQ Assignment

- ▶▶ Auto                      Auto assign IRQ to PCI 1. (Default value)
- ▶▶ 3,4,5,7,9,10,11,12,14,15    Set IRQ 3,4,5,7,9,10,11,12,14,15 to PCI 1.

### PCI 2 IRQ Assignment

- ▶▶ Auto                      Auto assign IRQ to PCI 2. (Default value)
- ▶▶ 3,4,5,7,9,10,11,12,14,15    Set IRQ 3,4,5,7,9,10,11,12,14,15 to PCI 2.

### PCI 3 IRQ Assignment

- ▶▶ Auto                      Auto assign IRQ to PCI 3. (Default value)
- ▶▶ 3,4,5,7,9,10,11,12,14,15    Set IRQ 3,4,5,7,9,10,11,12,14,15 to PCI 3.

## 2-6 PC Health Status

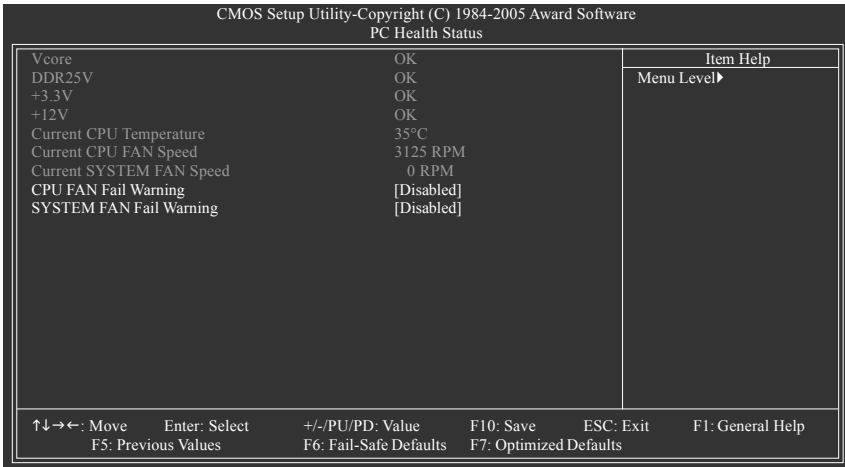

- ☞ **Current Voltage(V) Vcore / DDR25V / +3.3V / +12V**
  - ▶▶ Detect system's voltage status automatically.
- ☞ **Current CPU Temperature**
  - ▶▶ Detect CPU temperature automatically.
- ☞ **Current CPU/SYSTEM FAN Speed (RPM)**
  - ▶▶ Detect CPU/SYSTEM fan speed status automatically.
- ☞ **CPU FAN Fail Warning**
  - ▶▶ Disabled            Disable CPU fan fail warning function. (Default value)
  - ▶▶ Enabled            Enable CPU fan fail warning function.
- ☞ **SYSTEM FAN Fail Warning**
  - ▶▶ Disabled            Disable SYSTEM fan fail warning function. (Default value)
  - ▶▶ Enabled            Enable SYSTEM fan fail warning function.

## 2-7 Frequency / Voltage Control

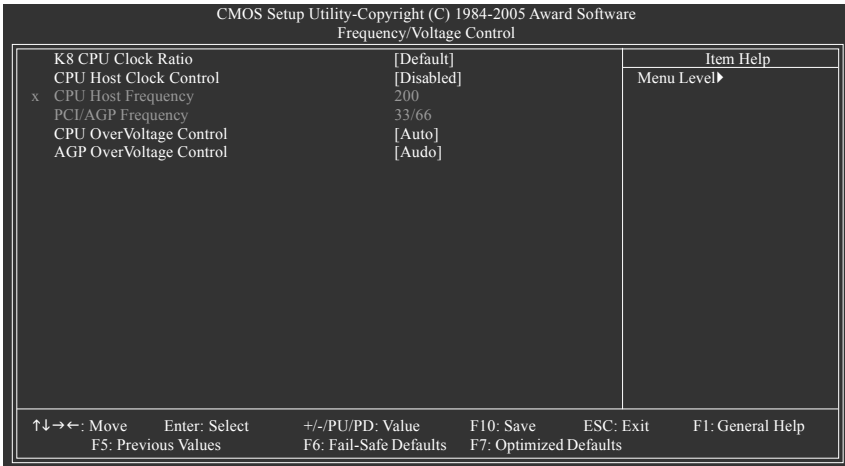

Incorrect using these features may cause your system broken. For power end-user use only.

### ☞ K8 CPU Clock Ratio

- ▶▶ Default                      Set K8 CPU Clock Ratio to CPU factory default. (Default value)
- ▶▶ x4 800Mhz ~ x10 2000Mhz    Set K8 CPU Clock Ratio from x4 800Mhz to x10 2000Mhz.

### ☞ CPU Host Clock Control

Note: Please note that if your system is overclocked and cannot restart, please wait 20secs. for automatic system restart or clear the CMOS setup data and perform a safe restart.

- ▶▶ Disabled                      Disable CPU Host Clock Control.(Default value)
- ▶▶ Enabled                        Enable CPU Host Clock Control.

### ☞ CPU Host Frequency (Mhz)

- ▶▶ 200MHz ~455MHz              Set CPU Host Frequency from 200MHz to 455MHz.

### ☞ PCI /AGP Frequency(Mhz)

- ▶▶ The values depend on CPU Host Frequency(Mhz).

### ☞ CPU OverVoltage Control

- ▶▶ Auto                              BIOS will automatically detect CPU voltage. (Default value)
- ▶▶ +5%                                Set CPU OverVoltage Control to +5%.
- ▶▶ +7.5%                              Set CPU OverVoltage Control to +7.5%.
- ▶▶ +10%                                Set CPU OverVoltage Control to +10%.

Incorrect using it may cause your system broken. For power End-User use only!

### ☞ AGP OverVoltage Control

- ▶▶ Auto                              BIOS will automatically detect AGP voltage. (Default value)
- ▶▶ +0.1V                                Set AGP OverVoltage Control to +0.1V.
- ▶▶ +0.2V                                Set AGP OverVoltage Control to +0.2V.

Increase AGP voltage may get stable for Over\_Clock. But it may damage to AGP Card when enable this feature.



## 2-8 Load Fail-Safe Defaults

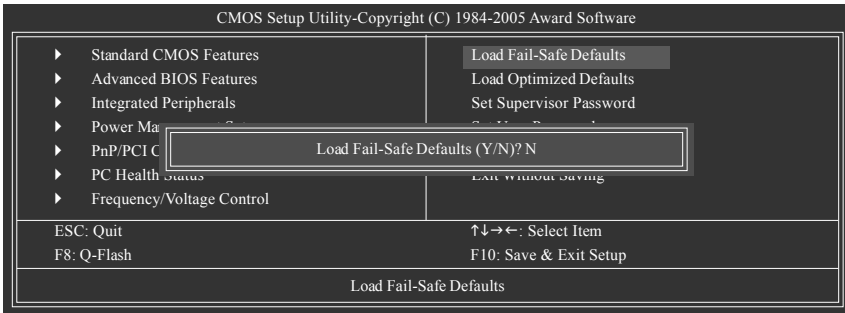

Fail-Safe defaults contain the most appropriate values of the system parameters that allow minimum system performance.

## 2-9 Load Optimized Defaults

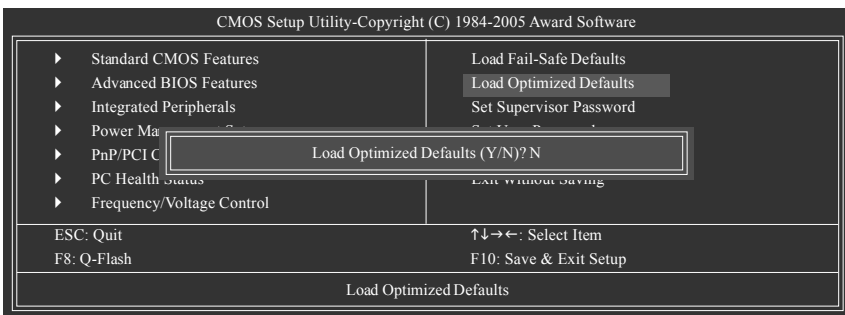

Selecting this field loads the factory defaults for BIOS and Chipset Features which the system automatically detects.

## 2-10 Set Supervisor/User Password

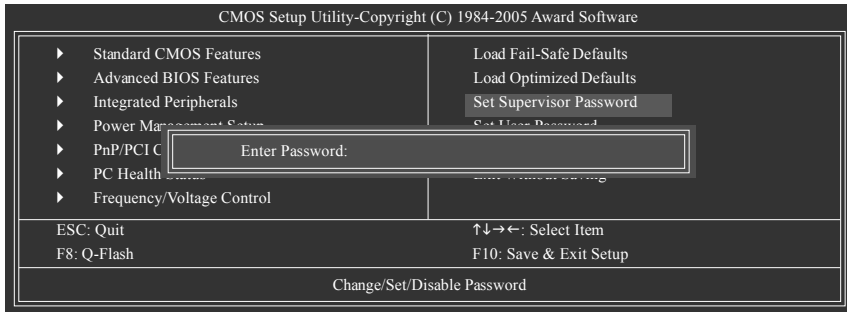

When you select this function, the following message will appear at the center of the screen to assist you in creating a password.

Type the password, up to eight characters, and press <Enter>. You will be asked to confirm the password. Type the password again and press <Enter>. You may also press <Esc> to abort the selection and not enter a password.

To disable password, just press <Enter> when you are prompted to enter password. A message "PASSWORD DISABLED" will appear to confirm the password being disabled. Once the password is disabled, the system will boot and you can enter Setup freely.

The BIOS Setup program allows you to specify two separate passwords: SUPERVISOR PASSWORD and a USER PASSWORD. When disabled, anyone may access all BIOS Setup program function. When enabled, the Supervisor password is required for entering the BIOS Setup program and having full configuration fields, the User password is required to access only basic items.

If you select "System" at "Password Check" in Advance BIOS Features Menu, you will be prompted for the password every time the system is rebooted or any time you try to enter Setup Menu.

If you select "Setup" at "Password Check" in Advance BIOS Features Menu, you will be prompted only when you try to enter Setup.

## 2-11 Save & Exit Setup

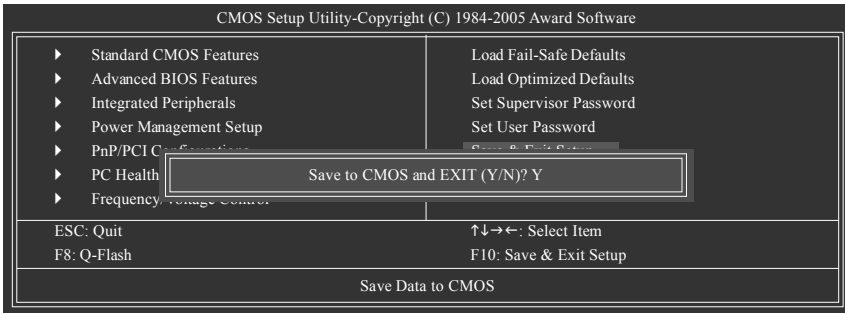

Type "Y" will quit the Setup Utility and save the user setup value to RTC CMOS.

Type "N" will return to Setup Utility.

## 2-12 Exit Without Saving

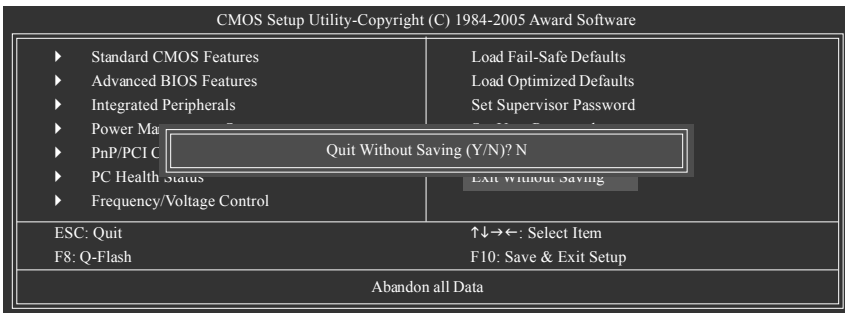

Type "Y" will quit the Setup Utility without saving to RTC CMOS.

Type "N" will return to Setup Utility.



## Chapter 3 Drivers Installation



Pictures below are shown in Windows XP.

Insert the driver CD-title that came with your motherboard into your CD-ROM drive, the driver CD-title will auto start and show the installation guide. If not, please double click the CD-ROM device icon in "My computer", and execute the Setup.exe.

### 3-1 Install Chipset Drivers

After insert the driver CD, "Xpress Install" will scan automatically the system and then list all the drivers that recommended to install. The "Xpress Install" uses the "Click and Go" technology to install the drivers automatically. Just select the drivers you want then click the "GO" button. The "Xpress Install" will execute the installation for you automatically.

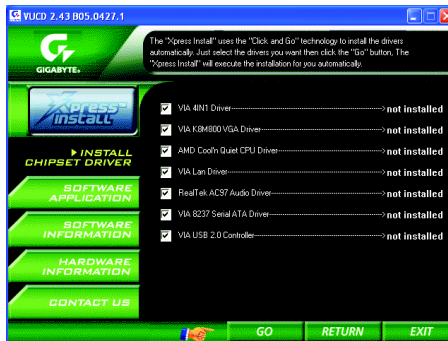

Some device drivers will restart your system automatically. After restarting your system the "Xpress Install" will continue to install other drivers.

System will reboot automatically after install the drivers, afterward you can install others application.



For USB2.0 driver support under Windows XP operating system, please use Windows Service Pack. After install Windows Service Pack, it will show a question mark "?" in "Universal Serial Bus controller" under "Device Manager". Please remove the question mark and restart the system (System will auto-detect the right USB2.0 driver).

## 3-2 Software Application

This page displays all the tools that Gigabyte developed and some free software. You can click an item to install it.



## 3-3 Software Information

This page lists the contents of software and drivers in this CD-title.

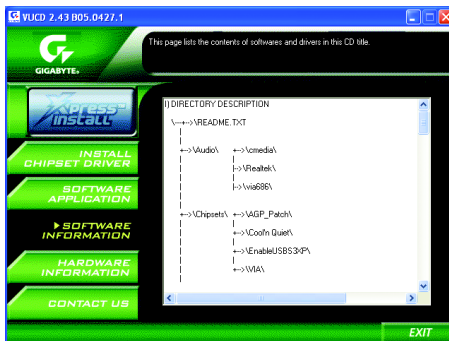

### 3-4 Hardware Information

This page lists all device you have for this motherboard.



### 3-5 Contact Us

Please see the last page for details.







## Chapter 4 Appendix

### 4-1 Unique Software Utilities

(Not all model support these Unique Software Utilities, please check your MB features.)



#### U-PLUS D.P.S. (Universal Plus Dual Power System)

The U-Plus Dual Power System (U-Plus DPS) is a revolutionary eight-phase power circuit built for ultimate system protection. Designed to withstand varying current levels and changes, the U-Plus D.P.S. provides an immensely durable and stable power circuit to the CPU for solid system stability. These characteristics make it the ideal companion with the latest LGA775 Intel® Pentium® 4 Processor as well as future Intel® processors. As well, 4 blue LED's are mounted on the U-Plus D.P.S. for intelligent indication of system loading.



#### M.I.T. (Motherboard Intelligent Tweaker)

Motherboard Intelligent Tweaker (M.I.T.) allows user to access and change BIOS feature settings with relative speed and ease. Through GIGABYTE M.I.T. feature the user is no longer required to switch into different modes within BIOS setup in order to change system settings such as the CPU system bus, memory timings or to enabled Gigabyte's unique C.I.A. 2 and M.I.B. 2 features. M.I.T.'s integration of all platform performance settings into a single mode now gives any user the ability to control and enhance their computer system to the desired level.



#### C.I.A.2 (CPU Intelligent Accelerator 2)

GIGABYTE CPU Intelligent Accelerator 2(C.I.A. 2) is designed to automatically adjust CPU computing power to maximize system performance. When enabled, the program detects the current CPU loading and automatically accelerates the CPU computing performance to allow for a faster and smoother execution of programs. When the function is disabled, the CPU is returned to its initial status.



#### M.I.B.2 (Memory Intelligent Booster 2)

Built on the original M.I.B., the new Memory Intelligent Booster 2 (M.I.B. 2) is designed especially to maximize memory performance and boost memory bandwidth up to 10%. With added branded memory module information, users are able to optimize memory performance by selecting from a recommended memory module list.



#### S.O.S. (System Overclock Saver)

System Overclock Saver (S.O.S.) is a unique feature that eliminates system boot-up errors resulting from system over-enhancement by the user. With GIGABYTE's proprietary S.O.S. feature, users no longer need to open up the PC chassis and short-circuit the "Clear CMOS" pins or the battery on the motherboard to reset the system back to factory default settings. Instead, S.O.S. automatically resets the overclocked system settings back to their factory defaults to provide a more user-friendly and reliable platform for users.



#### Download Center

Download Center allows users to quickly download and update their BIOS as well as the latest drivers for their system. Download Center automatically runs a system check of the user PC and provides the user with the current system information as well as displaying a detailed list of all new drivers with the option for download.



#### C.O.M. (Corporate Online Management)

A web-based system management tool that allows system hardware information such as CPU, memory, graphics card, etc. to be monitored and controlled via the Internet, C.O.M. allows corporate MIS engineers to easily maintain corporate computers such as providing the most up-to-date drivers and BIOS. (Do not use C.O.M. and @BIOS at the same time.)

## 4-1-1 EasyTune 5 Introduction

EasyTune 5 presents the most convenient Windows based system performance enhancement and manageability utility. Featuring several powerful yet easy to use tools such as 1) Overclocking for enhancing system performance, 2) C.I.A. and M.I.B. for special enhancement for CPU and Memory, 3) Smart-Fan control for managing fan speed control of both CPU cooling fan and North-Bridge Chipset cooling fan, 4) PC health for monitoring system status. <sup>(Note)</sup>

### User Interface Overview



	Button / Display	Description
1.	Overclocking	Enters the Overclocking setting page
2.	C.I.A./C.I.A.2 and M.I.B./M.I.B.2	Enters the C.I.A./2 and M.I.B./2 setting page
3.	Smart-Fan	Enters the Smart-Fan setting page
4.	PC Health	Enters the PC Health setting page
5.	GO	Confirmation and Execution button
6.	"Easy Mode" & "Advance Mode"	Toggles between Easy and Advance Mode
7.	Display screen	Display panel of CPU frequency
8.	Function display LEDs	Shows the current functions status
9.	GIGABYTE Logo	Log on to GIGABYTE website
10.	Help button	Display EasyTune™ 5 Help file
11.	Exit or Minimize button	Quit or Minimize EasyTune™ 5 software

(Note) EasyTune 5 functions may vary depending on different motherboards.

## 4-1-2 Xpress Recovery Introduction



### What is Xpress Recovery ?

Xpress Recovery is a utility used to back up and restore an OS partition. If the hard drive is not working properly, the user can restore the drive to its original state.



1. Supports FAT16, FAT32, and NTFS formats
2. Must be connected to the IDE1 Master
3. Allows installation of only one OS
4. Must be used with an IDE hard disk supporting HPA
5. The first partition must be set as the boot partition. When the boot partition is backed up, please do not alter its size.
6. Xpress Recovery is recommended when using Ghost to return boot manager to NTFS format.

### How to use the Xpress Recovery

1. Boot from CD-ROM (BMP Mode)

Enter the BIOS menu, select "Advanced BIOS Feature" and set to boot from CD-ROM. Insert the provided driver CD into your CD drive, then save and exit the BIOS menu. Once the computer has restarted, the phrase "Boot from CD:" will appear at the bottom left-hand corner of the screen. When "Boot from CD:" appears, press any key to enter Xpress Recovery.

Once you have completed this step, subsequent access to Xpress Recovery can also function by pressing the F9 key during computer power on.



Boot from CD:

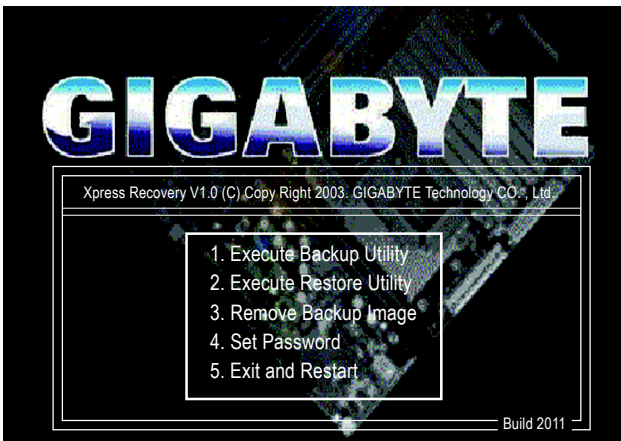

2. Press F9 during powering on the computer. (Text Mode)

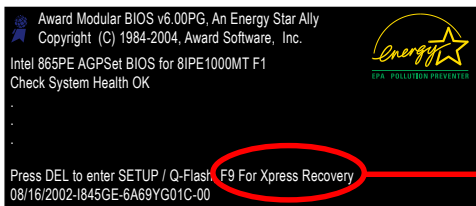

**F9 For Xpress Recovery**

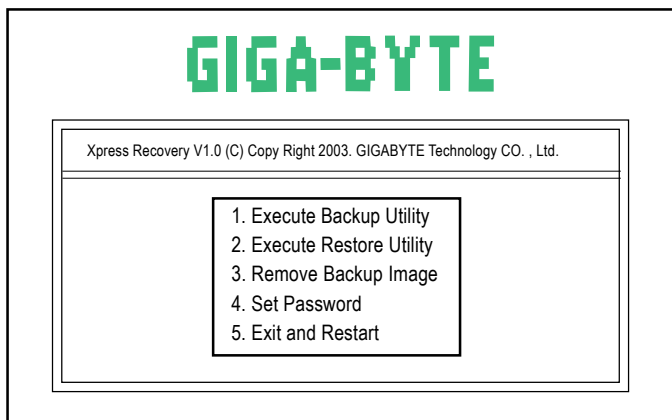

1. If you have already entered Xpress Recovery by booting from the CD-ROM, you can enter Xpress Recovery in the future by pressing the F9 key.
2. System storage capacity as well as drive reading/writing speed will affect backup speed.
3. It is recommended that Xpress Recovery be immediately installed after OS and all required driver and software installations are complete.

### 1. Execute Backup Utility:

#### **Press B to Backup your System or Esc to Exit**

The backup utility will automatically scan your system and back up data as a backup image in your hard drive.



Not all systems support access to Xpress Recovery by pressing the F9 key during computer power on. If this is the case, please use the boot from CD-ROM method to enter Xpress Recovery.

### 2. Execute Restore Utility:

#### **This program will recover your system to factory default.**

**Press R to restore your system back to factory default or press Esc to exit**

Restores backup image to original state.

### 3. Remove Backup Image:

#### **Remove backup image. Are you sure? (Y/N)**

Remove the backup image.

### 4. Set Password:

#### **Please input a 4-16 character long password (a-z or 0-9) or press Esc to exit**

You can set a password to enter Xpress Recovery to protect your hard disk data. Once this is done, password input will be required to enter Xpress Recovery during the next as well as subsequent system restarts. If you wish to remove the need for password entry, please select "Set Password" and under "New Password/Confirm Password", make sure there is no entry and then press "Enter" to remove password requirement.

### 5. Exit and Restart:

Exit and restart your computer.

### 4-1-3 Flash BIOS Method Introduction



#### Method 1 : Q-Flash™ Utility

Q-Flash™ is a BIOS flash utility embedded in Flash ROM. With this utility, users only have to stay in the BIOS menu when they want to update BIOS. Q-Flash allows users to flash BIOS without any utility in DOS or Windows. Using Q-Flash indicating no more fooling around with any complicated instructions and operating system since it is in the BIOS menu.



Please note that because updating BIOS has potential risk, please do it with caution!! We are sorry that Gigabyte Technology Co., Ltd is not responsible for damages of system because of incorrect manipulation of updating BIOS to avoid any claims from end-users.

#### Before You Begin:

Before you start updating BIOS with the Q-Flash™ utility, please follow the steps below first.

1. Download the latest BIOS for your motherboard from Gigabyte's website.
2. Extract the BIOS file downloaded and save the BIOS file (the one with model name.Fxx. For example, 8KNXPU.Fba) to a floppy disk.
3. Reboot your PC and press **Del** to enter BIOS menu.

The BIOS upgrading guides below are separated into two parts.

If your motherboard has dual-BIOS, please refer to **Part One**.

If your motherboard has single-BIOS, please refer to **Part Two**.

#### Part One:

#### Updating BIOS with Q-Flash™ Utility on Dual BIOS Motherboards.

Some of Gigabyte motherboards are equipped with dual BIOS. In the BIOS menu of the motherboards supporting Q-Flash and Dual BIOS, the Q-Flash utility and Dual BIOS utility are combined in the same screen. This section only deals with how to use Q-Flash utility.

**In the following sections, we take GA-8KNXP Ultra as the example to guide you how to flash BIOS from an older version to the latest version. For example, from Fa3 to Fba.**

The BIOS file is Fa3  
before updating

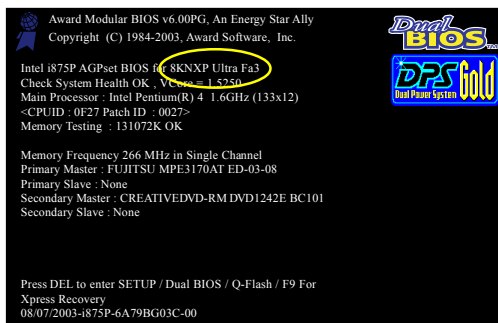

**Entering the Q-Flash™ utility:**

Step1: To use Q-Flash utility, you must press **Del** in the boot screen to enter BIOS menu.

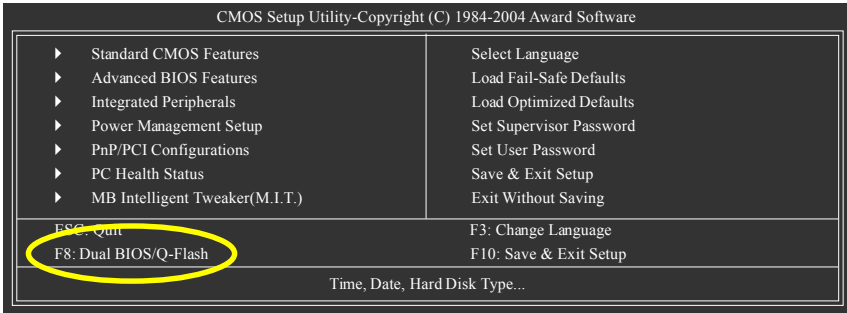

Step 2: Press **F8** button on your keyboard and then **Y** button to enter the Dual BIOS/Q-Flash utility.

**Exploring the Q-Flash™ / Dual BIOS utility screen**

The Q-Flash / Dual BIOS utility screen consists of the following key components.

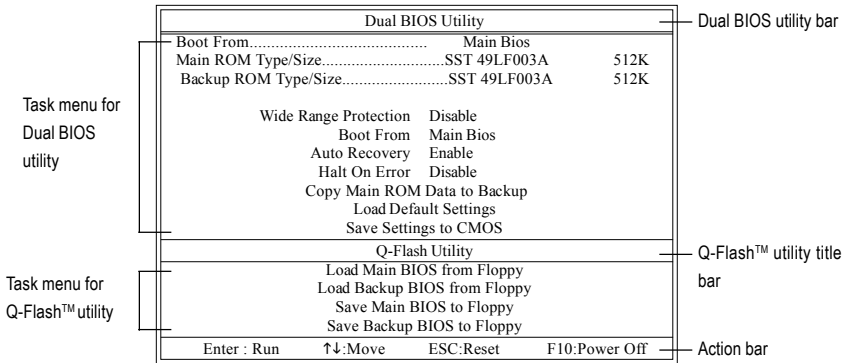

**Task menu for Dual BIOS utility:**

Contains the names of eight tasks and two item showing information about the BIOS ROM type. Blocking a task and pressing Enter key on your keyboard to enable execution of the task.

**Task menu for Q-Flash utility:**

Contains the names of four tasks. Blocking a task and pressing Enter key on your keyboard to enable execution of the task.

**Action bar:**

Contains the names of four actions needed to operate the Q-Flash/Dual BIOS utility. Pressing the buttons mentioned on your keyboards to perform these actions.





- Press Y button on your keyboard after you are sure to update BIOS.  
Then it will begin to update BIOS. The progress of updating BIOS will be displayed.



Please do not take out the floppy disk when it begins flashing BIOS.

- Press any keys to return to the Q-Flash menu when the BIOS updating procedure is completed.

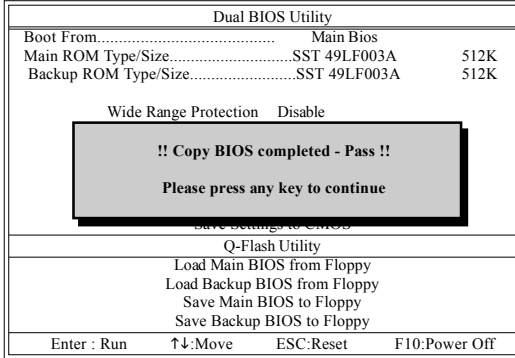

You can repeat Step 1 to 4 to flash the backup BIOS, too.

- Press Esc and then Y button to exit the Q-Flash utility. The computer will restart automatically after you exit Q-Flash.

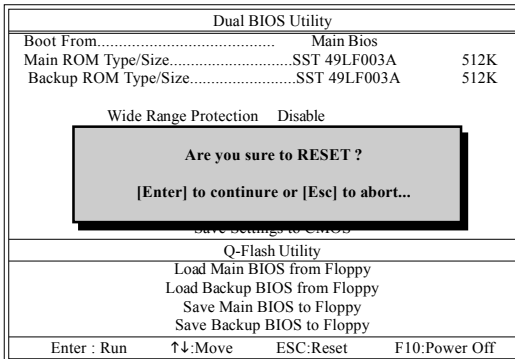

After system reboots, you may find the BIOS version on your boot screen becomes the one you flashed.

The BIOS file becomes Fab after updating.

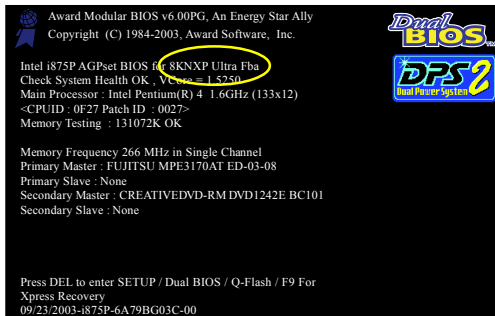

6. Press **Del** to enter BIOS menu after system reboots. When you are in BIOS menu, move to **Load Optimized Defaults** item and press **Enter** to load BIOS Optimized Defaults. Normally the system redetects all devices after BIOS has been upgraded. Therefore, we highly recommend reloading the BIOS defaults after BIOS has been upgraded.

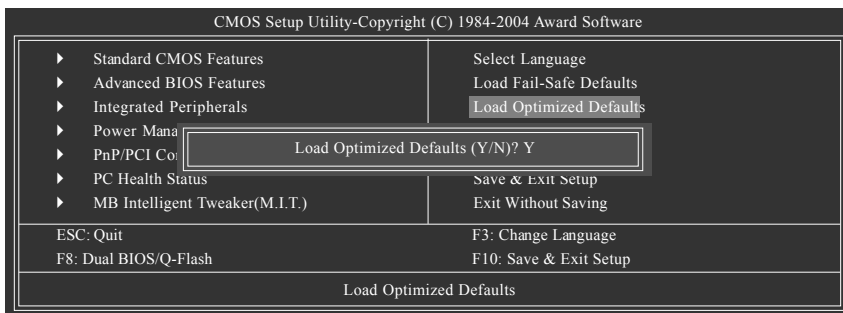

Press **Y** on your keyboard to load defaults.

7. Select **Save & Exit Setup** item to save the settings to CMOS and exit the BIOS menu. System will reboot after you exit the BIOS menu. The procedure is completed.

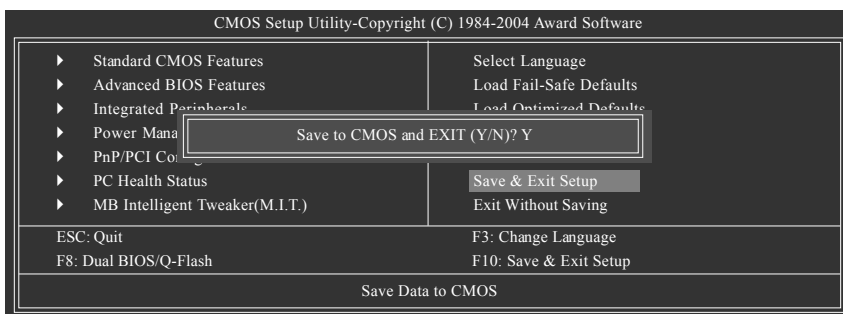

Press **Y** on your keyboard to save and exit.

## Part Two:

### Updating BIOS with Q-Flash™ Utility on Single-BIOS Motherboards.

This part guides users of single-BIOS motherboards how to update BIOS using the Q-Flash™ utility.

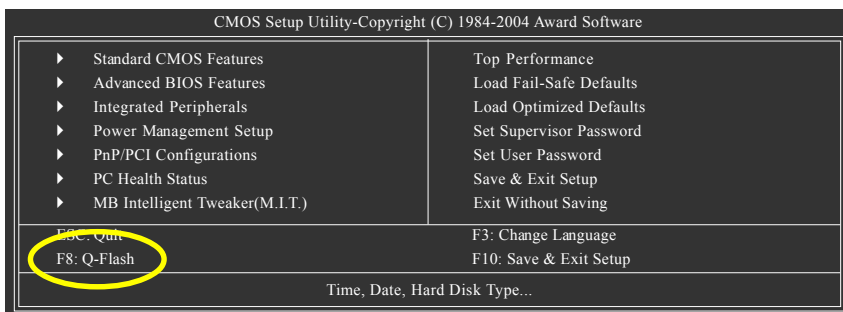

## Exploring the Q-Flash™ utility screen

The Q-FlashBIOS utility screen consists of the following key components.

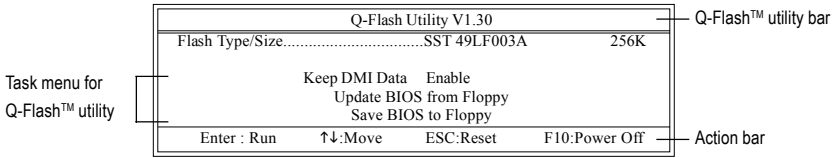

### Task menu for Q-Flash utility:

Contains the names of three tasks. Blocking a task and pressing Enter key on your keyboard to enable execution of the task.

### Action bar:

Contains the names of four actions needed to operate the Q-Flash utility. Pressing the buttons mentioned on your keyboards to perform these actions.

### Using the Q-Flash™ utility:

This section tells you how to update BIOS using the Q-Flash utility. As described in the "Before you begin" section above, you must prepare a floppy disk having the BIOS file for your motherboard and insert it to your computer. If you have already put the floppy disk into your system and have entered the Q-Flash utility, please follow the steps below to flash BIOS.

### Steps:

1. Press arrow buttons on your keyboard to move the light bar to "Update BIOS from Floppy" item in the Q-Flash menu and press Enter button.  
Later, you will see a box pop up showing the BIOS files you previously downloaded to the floppy disk.



If you want to save the current BIOS for backup purpose, you can begin Step 1 with "Save BIOS to Floppy" item.

2. Move to the BIOS file you want to flash and press Enter.

**In this example, we only download one BIOS file to the floppy disk so only one BIOS file, 8GE800.F4, is listed.**



Please confirm again you have the correct BIOS file for your motherboard.

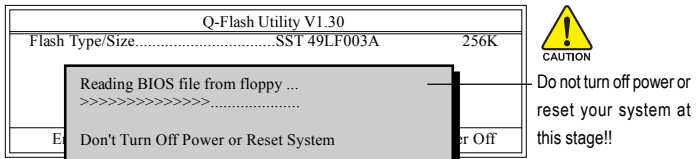
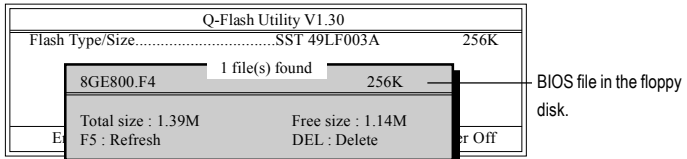

After BIOS file is read, you'll see a confirmation dialog box asking you "Are you sure to update BIOS?"



Please do not take out the floppy disk when it begins flashing BIOS.

- Press Y button on your keyboard after you are sure to update BIOS.  
Then it will begin to update BIOS. The progress of updating BIOS will be shown at the same time.

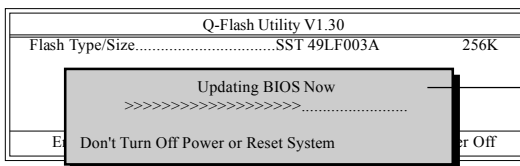

Do not turn off power or reset your system at this stage!!

- Press any keys to return to the Q-Flash menu when the BIOS updating procedure is completed.

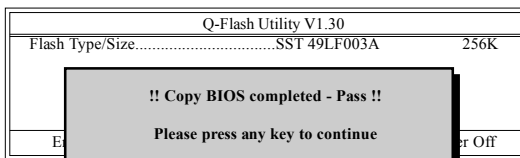

- Press Esc and then Y button to exit the Q-Flash utility. The computer will restart automatically after you exit Q-Flash.

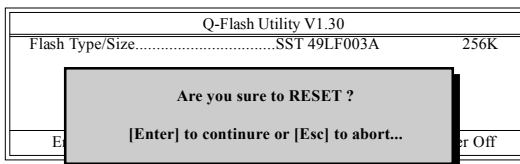

After system reboots, you may find the BIOS version on your boot screen becomes the one you flashed.

The BIOS file becomes F4 after updating

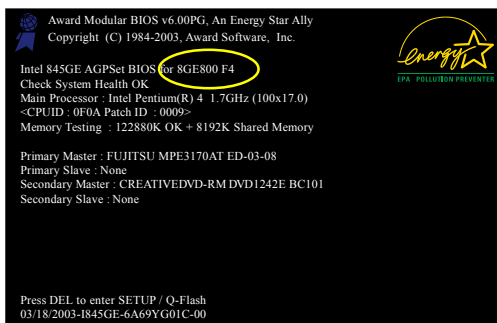

- Press Del to enter BIOS menu after system reboots and "Load BIOS Fail-Safe Defaults". See how to Load BIOS Fail-Safe Defaults, please kindly refer to Step 6 to 7 in **Part One**.

**Congratulation!! You have updated BIOS successfully!!**

## Method 2 : @BIOS™ Utility

If you do not have a DOS startup disk, we recommend that you use the new @BIOS utility. @BIOS allows users to update their BIOS under Windows. Just select the desired @BIOS server to download the latest version of BIOS.

Fig 1. Installing the @BIOS utility

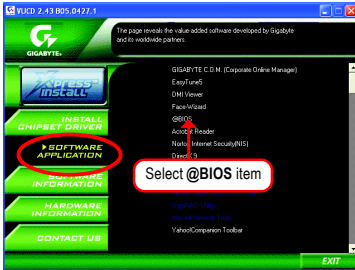

Fig 2. Installation Complete and Run @BIOS

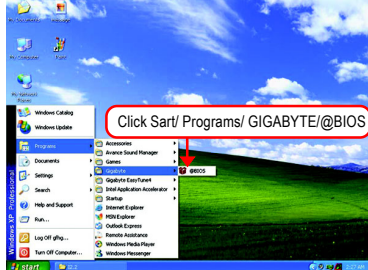

Fig 3. The @BIOS Utility

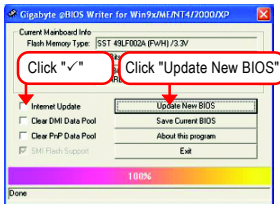

Fig 4. Select the desired @BIOS server



## 1. Methods and steps:

### I. Update BIOS through Internet

- Click "Internet Update" icon
- Click "Update New BIOS" icon
- Select @BIOS™ sever
- Select the exact model name on your motherboard
- System will automatically download and update the BIOS.

### II. Update BIOS NOT through Internet:

- Do not click "Internet Update" icon
- Click "Update New BIOS"
- Please select "All Files" in dialog box while opening the old file.
- Please search for BIOS unzip file, downloading from internet or any other methods (such as: K8VM800M.F1).
- Complete update process following the instruction.

### III. Save BIOS

In the very beginning, there is "Save Current BIOS" icon shown in dialog box. It means to save the current BIOS version.

### IV. Check out supported motherboard and Flash ROM:

In the very beginning, there is "About this program" icon shown in dialog box. It can help you check out which kind of motherboard and which brand of Flash ROM are supported.

## 2. Note:

- I. In method I, if it shows two or more motherboard's model names to be selected, please make sure your motherboard's model name again. Selecting wrong model name will cause the system unbooted.
- II. In method II, be sure that motherboard's model name in BIOS unzip file are the same as your motherboard's. Otherwise, your system won't boot.
- III. In method I, if the BIOS file you need cannot be found in @BIOS™ server, please go onto Gigabyte's web site for downloading and updating it according to method II.
- IV. Please note that any interruption during updating will cause system unbooted.
- V. Do not use @BIOS and C.O.M. (Corporate Online Management) at the same time.

## 4-1-4 Serial ATA BIOS Setting Utility Introduction

### RAID Levels

RAID (Redundant Array of Independent Disks) is a method of combining two hard disk drives into one logical unit. The advantage of an Array is to provide better performance or data fault tolerance. Fault tolerance is achieved through data redundant operation, where if one drives fails, a mirrored copy of the data can be found on another drive. This can prevent data loss if the operating system fails or hangs. The individual disk drives in an array are called members. The configuration information of each member is recorded in the reserved sector that identifies the drive as a member. All disk members in a formed disk array are recognized as a single physical drive to the operating system.

Hard disk drives can be combined together through a few different methods. The different methods are referred to as different RAID levels. Different RAID levels represent different performance levels, security levels and implementation costs. The RAID levels which the VIA VT8237R / VT8237R+ chipset supports are RAID 0, RAID 1, and JBOD.

#### RAID 0 (Striping)

RAID 0 reads and writes sectors of data interleaved between multiple drives. If any disk member fails, it affects the entire array. The disk array data capacity is equal to the number of drive members times the capacity of the smallest member. The striping block size can be set from 4KB to 64KB. RAID 0 does not support fault tolerance.

#### RAID 1 (Mirroring)

RAID 1 writes duplicate data onto a pair of drives and reads both sets of data in parallel. If one of the mirrored drives suffers a mechanical failure or does not respond, the remaining drive will continue to function. Due to redundancy, the drive capacity of the array is the capacity of the smallest drive. Under a RAID 1 setup, an extra drive called the spare drive can be attached. Such a drive will be activated to replace a failed drive that is part of a mirrored array. Due to the fault tolerance, if any RAID 1 drive fails, data access will not be affected as long as there are other working drives in the array.

#### JBOD (Spanning)

A spanning disk array is equal to the sum of the all drives when the drives used are having different capacities. Spanning stores data onto a drive until it is full, then proceeds to store files onto the next drive in the array. When any disk member fails, the failure affects the entire array. JBOD is not really a RAID and does not support fault tolerance.

Please follow the steps below to construct a complete RAID array:

- 1) Have ready your hard drives for RAID construction.  
Note: To achieve best performance, it is recommended that the hard drives used are of similar make and storage capacity.
- 2) Please attach the hard drive connectors to their appropriate location on the motherboard ie. IDE, SCSI, or SATA.
- 3) Enter the motherboard BIOS and locate RAID setup (Please refer to the section on Integrated Peripherals).
- 4) Enter RAID setup in the BIOS and select the RAID type (For instance, enter Tab to select VT8237R / VT8237R+ RAID; Ctrl + S to select Silicon Image).
- 5) Complete driver installation.
- 6) Complete RAID utility installation.

More information on steps 4 and 5 is provided. (For more detailed setup information, please visit our website at <http://www.gigabyte.com.tw> to read or download the information you need.)

### Configuring the VT8237 SATA RAID BIOS

The RAID BIOS setup utility lets you choose the RAID array type and which hard drives you want to make part of the array.

#### Entering the VT8237 SATA RAID BIOS Setup Utility

1. After rebooting your computer, wait until you see the RAID software prompting you to press **Tab**. The RAID prompt appears as part of the system POST and boot process prior to loading the OS. You have a few seconds to press **Tab** before the window disappears.

```
VIA Technologies, Inc. VIA VT8237 Serial ATA RAID BIOS Setting Utility V2.41
Copyright (C) VIA Technologies, Inc. All Right reserved.
```

```
Scan Devices, Please wait...
Press <Tab> key into User Window!
Serial_Ch0 Master : ST3120026AS
Serial_Ch1 Master : ST3120026AS
```

Press **Tab** to enter RAID setup utility, the **VT8237 SATA RAID BIOS** utility screen will appear. You can press up arrow key<↑> or down arrow key<↓> to move the selection bar and select the item that you want to execute.

VIA Tech. VT8237 SATA RAID BIOS Ver 2.41

<ul style="list-style-type: none"> <li>▶ Create Array</li> <li>▶ Delete Array</li> <li>▶ Create/Delete Spare</li> <li>▶ Select Boot Array</li> <li>▶ Serial Number View</li> </ul>	<p>Create a RAID array with the hard disks attached to VIA RAID controller</p> <p>F1 : View Array/disk Status            ↑, ↓ : Move to next item            Enter : Confirm the selection            ESC : Exit</p>																		
<table style="width: 100%; border-collapse: collapse; border-top: 1px solid black;"> <thead> <tr> <th style="text-align: left;">Channel</th> <th style="text-align: left;">Drive Name</th> <th style="text-align: left;">Array Name</th> <th style="text-align: left;">Mode</th> <th style="text-align: left;">Size(GB)</th> <th style="text-align: left;">Status</th> </tr> </thead> <tbody> <tr> <td>Serial_Ch0 Master</td> <td>ST3120026AS</td> <td></td> <td>SATA</td> <td>111.79</td> <td>Hdd</td> </tr> <tr> <td>Serial_Ch1 Master</td> <td>ST3120026AS</td> <td></td> <td>SATA</td> <td>111.79</td> <td>Hdd</td> </tr> </tbody> </table>		Channel	Drive Name	Array Name	Mode	Size(GB)	Status	Serial_Ch0 Master	ST3120026AS		SATA	111.79	Hdd	Serial_Ch1 Master	ST3120026AS		SATA	111.79	Hdd
Channel	Drive Name	Array Name	Mode	Size(GB)	Status														
Serial_Ch0 Master	ST3120026AS		SATA	111.79	Hdd														
Serial_Ch1 Master	ST3120026AS		SATA	111.79	Hdd														



## A. Create Array:

Press Enter on **Create Array** item, you will see the screen as shown below.

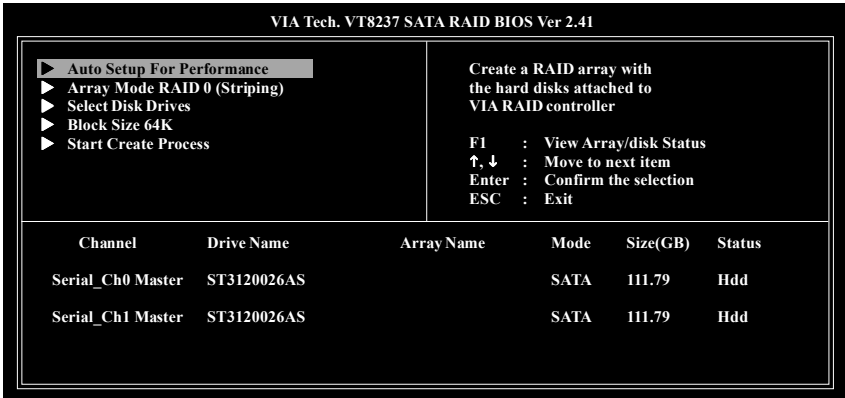

Before create an Array, you have to set the array mode first. Select **Array Mode** and press **Enter**, use the arrow key to select the array mode. The options are: RAID 0 for performance, RAID 1 for data protection, and RAID SPAN for capacity.

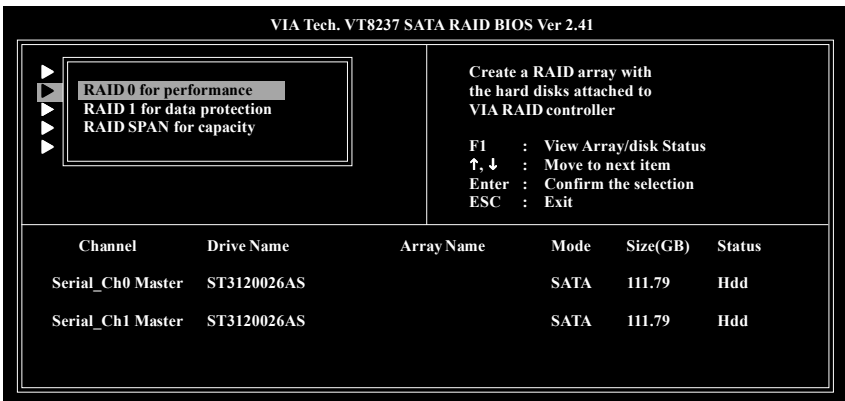

After array mode is selected, there are two methods to create a disk array. One method is **Auto Setup** and the other one is **Select Disk Drives**. **Auto Setup** allows BIOS to select the disk drives and create arrays automatically, but it does not duplicate the mirroring drives even if the user selected Create and duplicate for RAID 1. It is recommended all disk drives are new ones when wanting to create an array. **Select Disk Drives** lets the user select the array drives by their requirements. Select the **Select Disk Drives** item and press **Enter**, use the arrow key to select the hard disk. The selected hard disk will be marked a star(\*) signal.

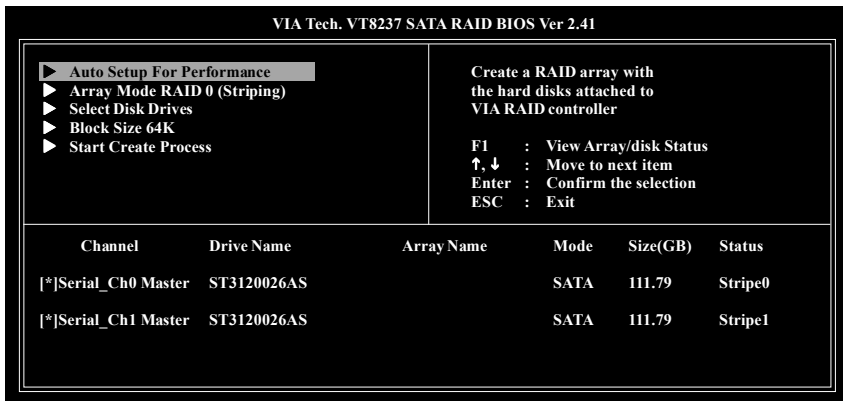

If you select a RAID 0 array, the block size of the array can also be selected. Use the arrow key to select Block Size and press **Enter**, then select a block size from the popup menu. The block size can be 4KB to 64KB.

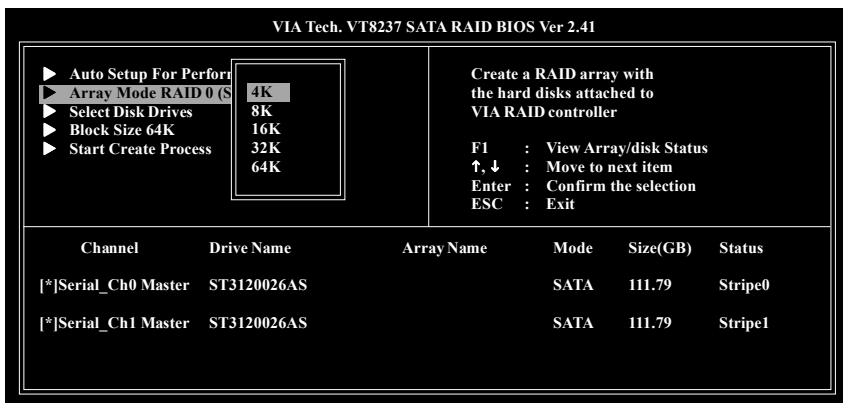

Use the arrow key to select **Start Create Process** and press **Enter**. A warning message will appear [The data on the selected disks will be destroyed. Continue? (Y/N)], press **Y** to finish the creation, or press **N** to cancel the creation.

Important note: All existing contents in the hard drive will be destroyed after array creation.

## B. Delete Array:

If you want to delete the Array, select **Delete Array** in the main menu and press **Enter**. The channel column will be activated. Select the member of an array that is to be deleted and press **Enter**. A warning message will show up, press **Y** to delete or press **N** to cancel.

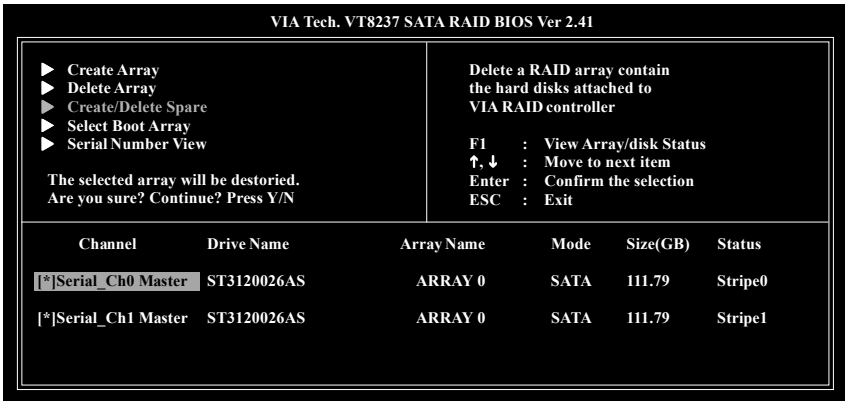

Deleting a disk array will destroy all the data on the disk array except RAID 1 arrays. When a RAID is deleted, the data on these two hard disk drives will be reserved and become two normal disk drives.

## C. Select Boot Array:

You can select a disk array as boot device if you want to boot operating system from an array. Boot disk array cannot be selected if the operating system does not boot from the disk array. Highlight the **Select Boot Array** item; press **Enter** and the channel column will be activated. Then highlight the target disk array and press **Enter**. Press **Esc** to go back to main menu. If you want to cancel the boot array, select the disk array that has a star(\*) mark and press **Enter**, its boot setting will be canceled.

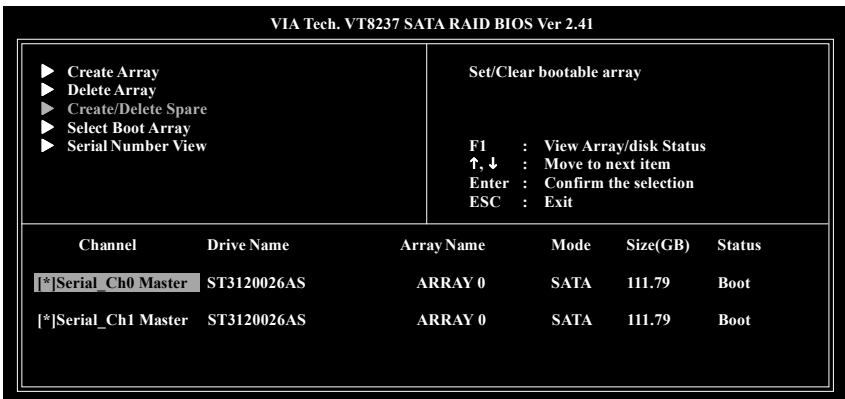

#### D. Serial Number View:

Highlight **Serial Number View** and press **Enter**. Use arrow key to select a drive, the selected drive's serial number can be viewed in the last column.

VIA Tech. VT8237 SATA RAID BIOS Ver 2.41

<ul style="list-style-type: none"> <li>▶ Create Array</li> <li>▶ Delete Array</li> <li>▶ Create/Delete Spare</li> <li>▶ Select Boot Array</li> <li>▶ Serial Number View</li> </ul>	<p>View the serial number of hard disk, it is useful for identify same model disks</p> <p>F1 : View Array/disk Status            ↑, ↓ : Move to next item            Enter : Confirm the selection            ESC : Exit</p>																								
<table border="1" style="width: 100%; border-collapse: collapse;"> <thead> <tr> <th style="width: 15%;">Channel</th> <th style="width: 20%;">Drive Name</th> <th style="width: 20%;">Array Name</th> <th style="width: 10%;">Mode</th> <th style="width: 10%;">Size(GB)</th> <th style="width: 15%;">Status</th> </tr> </thead> <tbody> <tr> <td>Serial_Ch0 Master</td> <td>ST3120026AS</td> <td>ARRAY 0</td> <td>SATA</td> <td>111.79</td> <td>Stripe0</td> </tr> <tr> <td>Serial_Ch1 Master</td> <td>ST3120026AS</td> <td>ARRAY 0</td> <td>SATA</td> <td>111.79</td> <td>Stripe1</td> </tr> <tr> <td>Serial Number:</td> <td colspan="5">3JT354CP</td> </tr> </tbody> </table>		Channel	Drive Name	Array Name	Mode	Size(GB)	Status	Serial_Ch0 Master	ST3120026AS	ARRAY 0	SATA	111.79	Stripe0	Serial_Ch1 Master	ST3120026AS	ARRAY 0	SATA	111.79	Stripe1	Serial Number:	3JT354CP				
Channel	Drive Name	Array Name	Mode	Size(GB)	Status																				
Serial_Ch0 Master	ST3120026AS	ARRAY 0	SATA	111.79	Stripe0																				
Serial_Ch1 Master	ST3120026AS	ARRAY 0	SATA	111.79	Stripe1																				
Serial Number:	3JT354CP																								

#### E. View Array Status:

Press the **F1** key to show the array status on the lower screen. If there are no disk arrays then nothing will be displayed on the screen.

VIA Tech. VT8237 SATA RAID BIOS Ver 2.41

<ul style="list-style-type: none"> <li>▶ Create Array</li> <li>▶ Delete Array</li> <li>▶ Create/Delete Spare</li> <li>▶ Select Boot Array</li> <li>▶ Serial Number View</li> </ul>	<p>Create a RAID array with the hard disks attached to VIA RAID controller</p> <p>F1 : View Array/disk Status            ↑, ↓ : Move to next item            Enter : Confirm the selection            ESC : Exit</p>								
<table border="1" style="width: 100%; border-collapse: collapse;"> <thead> <tr> <th style="width: 20%;">Array Name</th> <th style="width: 20%;">Array Mode</th> <th style="width: 20%;">Block Size(GB)</th> <th style="width: 20%;">Size(GB)</th> </tr> </thead> <tbody> <tr> <td>ARRAY 0</td> <td>Stripe</td> <td>64K</td> <td>223.58</td> </tr> </tbody> </table>		Array Name	Array Mode	Block Size(GB)	Size(GB)	ARRAY 0	Stripe	64K	223.58
Array Name	Array Mode	Block Size(GB)	Size(GB)						
ARRAY 0	Stripe	64K	223.58						

## Installing the RAID drivers

To install operating system onto a serial ATA hard disk successfully, you need to install the SATA controller driver during OS installation. Without the driver, the hard disk may not be recognized during the Windows setup process. First of all, copy the driver for the SATA controller from the motherboard driver CD-ROM to a floppy disk. See the instructions below about how to copy the driver in MS-DOS mode<sup>(Note1)</sup>. Prepare a startup disk that has CD-ROM support and a blank formatted floppy disk.

Step 1: Insert the prepared startup disk and motherboard driver CD-ROM in your system. Boot from the startup disk. Once at the A:\> prompt, change to the CD-ROM drive (example: D:\>). At the D:\> prompt, type the following two commands. Press ENTER after each command (Fig.1):

```
cd bootdrv
menu
```

Step 2: When the controller menu (Fig.2) appears, remove the startup disk and insert the blank formatted disk. Select the controller driver by pressing the corresponding letter from the menu. Your system will then automatically zip and transfer this driver file to the floppy disk. Press 0 to exit when finished.

```
D:\DOSKZ  1 10 00 02 7:51p
DISMOR  DLL  94,208 06:15:04 1:19p
DRIVERS  <DIR> 11:23:04 9:24p
HISTORY  TXT  7,703 06:24:04 1:56p
HOBDRV  DLL  53,740 08:21:02 3:11a
ID       LDG  21,077 12:01:04 11:21a
MANUAL  <DIR> 11:23:04 9:17p
NETWORK <DIR> 11:23:04 9:24p
MS      <DIR> 11:23:04 9:26p
OEMSETUP IMP 38,057 10:00:02 7:51p
OTHER  <DIR> 11:23:04 9:26p
PROSETII <DIR> 11:23:04 9:27p
README  TXT  4,551 12:01:04 2:09p
SETUP   EXE  431,888 11:25:04 3:52p
TESTW   EXE  196,608 08:09:04 1:44p
TIP     HT  2,839 09:30:04 10:01a
UTILITY <DIR> 11:23:04 9:27p
VGRFILE TIC  15 03:20:03 1:45p
VGRCA  TXT  7,820 11:24:04 1:51p
      16 file(s)      860,333 bytes free
      0 bytes free

D:\>cd bootdrv
D:\BOOTDRV>menu_
```

Fig.1

```
1)Intel IAA_RAID
2)GIGABYTE
3)SIERRA
4)SIL100ID
5)CSI
6)Promise 20276 ATA
7)Promise 20276 RAID
8)Promise 20265 ATA
9)Promise 20265 ATA(XP)
B)Promise 20265 RAID
D)Promise 20265 RAID(XP)
C)IN 8237 Series ATA
D)S1114
E)S1114 Raid
0)Exit
```

Fig. 2

Step 3: After completing the steps, boot from the Windows installation disk to install the RAID drivers. Press F6 as soon as you see the "Press F6 if you need to install a third party SCSI or RAID driver" message, then supply serial ATA controller driver by this floppy disk. Follow the on-screen instructions to complete the installation.

(Each time you add a new hard drive to a RAID array, the RAID driver will have to be installed under Windows once for that hard drive. After that, the driver will not have to be installed.)



(Note 1): For users without a startup disk.

Use an alternative system and insert the GIGABYTE motherboard drive CD-ROM. From the CD-ROM drive (example: D:\) double click the **MENU.exe** file in the **BootDrv** folder. A command prompt window will open similar to that in Fig. 2.

## 4-1-5 2 / 4 / 6 Channel Audio Function Introduction

### 2 Channel Audio Setup

We recommend that you use speakers with amplifier to get the best sound effect if the stereo output is applied.

STEP 1:

Connect the stereo speakers or earphone to "Line Out."

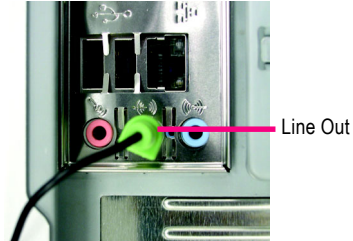

STEP 2:

After installing the audio driver, you'll find a Sound Effect icon  on the lower right hand taskbar. Click the icon to select the function.



STEP 3:

On the AC97 Audio Configuration menu, click the **Speaker Configuration** tab and select the **2-channel mode for stereo speaker output** check box.

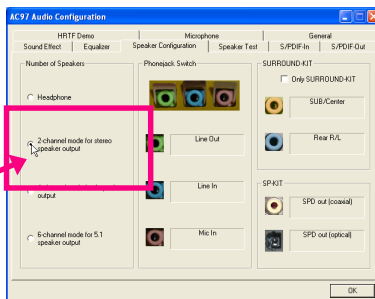
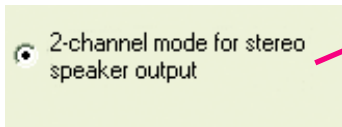

## 4 Channel Analog Audio Output Mode

### STEP 1:

Connect the front channels to "Line Out,"  
the rear channels to "Line In."

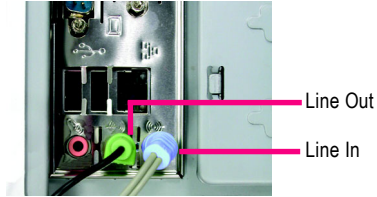

### STEP 2:

After installing the audio driver, you'll find a Sound Effect icon  on the lower right hand taskbar. Click the icon to select the function.

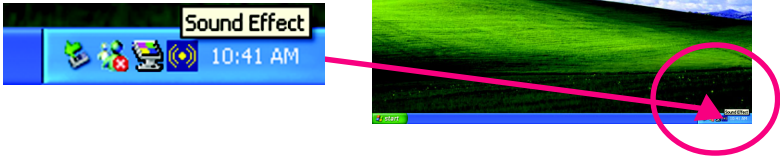

### STEP 3:

On the AC97 Audio Configuration menu, click the **Speaker Configuration** tab and select the **4-channel mode for 4 speaker output** check box. Clear the **Only SURROUND-KIT** check box and press **OK**.

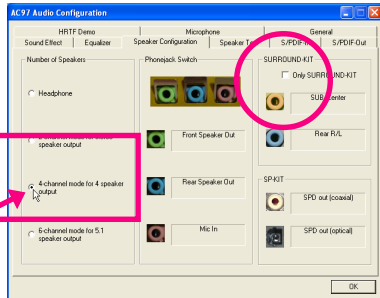
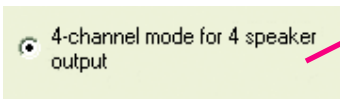

When the **Environment** setting is **None**, the sound would be performed as stereo mode (2-channel output). Please select other settings (ex: **Living Room**) for 4-channel output.

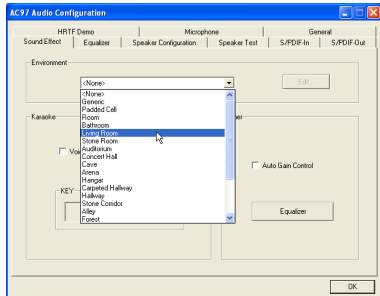

## Basic 6 Channel Analog Audio Output Mode

Use the back audio panel to connect the audio output without any additional module.

STEP 1:

Connect the front channels to "Line Out", the rear channels to "Line In", and the Center/Subwoofer channels to "MIC In".

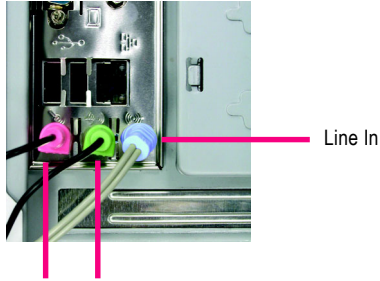

MIC In Line Out

STEP 2:

After installing the audio driver, you'll find a Sound Effect icon on the lower right hand taskbar. Click the icon to select the function.

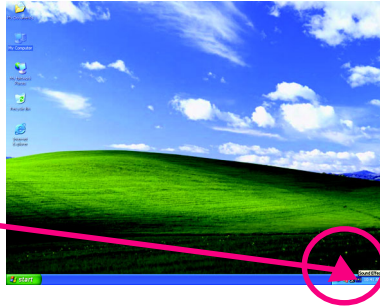

STEP 3:

On the AC97 Audio Configuration menu, click the **Speaker Configuration** tab and select the **6-channel mode for 5.1 speaker output** check box. Clear the **Only SURROUND-KIT** check box and press **OK**.

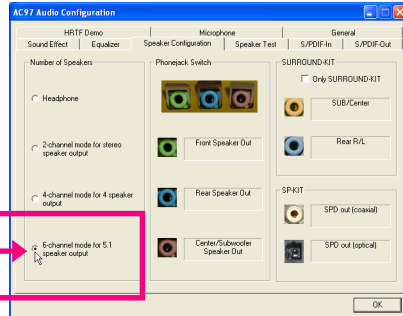
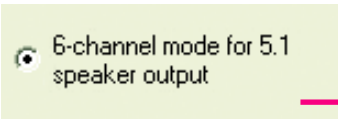

## Basic 6 Channel Analog Audio Output Mode Notes:

When the **Environment** setting is **None**, the sound would be performed as stereo mode (2-channel output). Please select the other settings for 6 channels output.

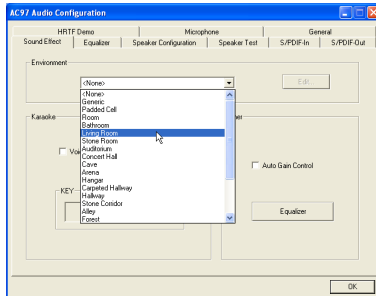



## SPDIF Output Device (Optional Device)

A "SPDIF output" device is an optional device. The SPDIF\_IO cable with rear bracket could link to the "SPDIF\_IO" connector (As picture.) For the further linkage to decoder, rear bracket provides coaxial cable and Fiber connecting port.



### STEP 1:

Secure the metal bracket of the SPDIF Output device to the chassis back panel with a screw.

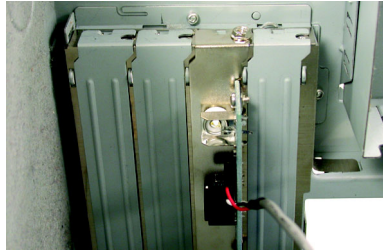

### STEP 2:

Connect the SPDIF device cable to the SPDIF\_IO connector on the motherboard.

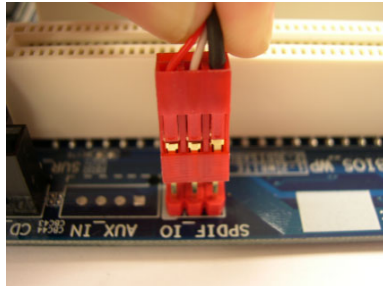

### STEP 3:

Connect SPDIF to the SPDIF decoder.

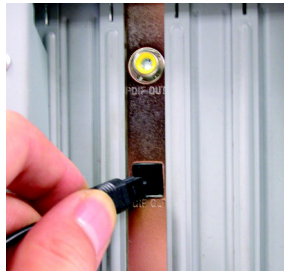

## 4-2 Troubleshooting

Below is a collection of general asked questions. To check general asked questions based on a specific motherboard model, please log on to <http://www.gigabyte.com.tw>

Question 1: I cannot see some options that were included in previous BIOS after updating BIOS. Why?

Answer: Some advanced options are hidden in new BIOS version. Please press Ctrl and F1 keys after entering BIOS menu and you will be able to see these options.

Questions 2: Why is the light of my keyboard/optical mouse still on after computer shuts down?

Answer: In some boards, a small amount of electricity is kept on standby after computer shuts down and that's why the light is still on.

Question 3: How do I clear CMOS?

Answer: If your board has a Clear CMOS jumper, please refer to the Clear CMOS steps in the manual. If your board doesn't have such jumper, you can take off the on-board battery to leak voltage to clear CMOS. Please refer to the steps below:

Steps:

1. Turn off power.
2. Disconnect the power cord from MB.
3. Take out the battery gently and put it aside for about 1 minute (Or you can use a metal object to connect the positive and negative pins in the battery holder to makethem short for 5 seconds).
4. Re-insert the battery to the battery holder.
5. Connect power cord to MB again and turn on power.
6. Press Del to enter BIOS and load Fail-Safe Defaults(or load Optimized Defaults).
7. Save changes and reboot the system.

Question 4: Why do I still get a weak sound after turning up the speaker to the maximum volume?

Answer: Please make sure the speaker you are using is equipped with an internal amplifier. If not, please change another speaker with power/amplifier and try again later.

Question 5: Sometimes I hear different continuous beeps from computer after system boots up. What do these beeps usually stand for?

Answer: The beep codes below may help you identify the possible computer problems. However, they are only for reference purposes. The situations might differ from case to case.

→ AWARD BIOS Beep Codes

1 short: System boots successfully

2 short: CMOS setting error

1 long 1 short: DRAM or M/B error

1 long 2 short: Monitor or display card error

1 long 3 short: Keyboard error

1 long 9 short: BIOS ROM error

Continuous long beeps: DRAM error

Continuous short beeps: Power error

Blank writing area consisting of horizontal lines.









## Contact Us

---

- **Taiwan (Headquarters)**

GIGA-BYTE TECHNOLOGY CO., LTD.

Address: No.6, Bau Chiang Road, Hsin-Tien,

Taipei 231, Taiwan

TEL: +886-2-8912-4888

FAX: +886-2-8912-4003

Tech. and Non-Tech. Support (Sales/Marketing) :

<http://ggts.gigabyte.com.tw>

WEB address (English): <http://www.gigabyte.com.tw>

WEB address (Chinese): <http://www.gigabyte.tw>

---

- **U.S.A.**

G.B.T. INC.

TEL: +1-626-854-9338

FAX: +1-626-854-9339

Tech. Support:

<http://rma.gigabyte-usa.com>

Web address: <http://www.gigabyte.us>

---

- **Mexico**

G.B.T Inc (USA)

Tel: +1-626-854-9338 x 215 (Soporte de habla hispano)

FAX: +1-626-854-9339

Correo: [soporte@gigabyte-usa.com](mailto:soporte@gigabyte-usa.com)

Tech. Support:

<http://rma.gigabyte-usa.com>

Web address: <http://www.gigabyte-latam.com>

---

- **Japan**

NIPPON GIGA-BYTE CORPORATION

WEB address : <http://www.gigabyte.co.jp>

---

- **Singapore**

GIGA-BYTE SINGAPORE PTE. LTD.

WEB address : <http://www.gigabyte.com.sg>

---

---

- **China**

NINGBO G.B.T. TECH. TRADING CO., LTD.

WEB address : <http://www.gigabyte.cn>

- **Shanghai**

TEL: +86-21-63410999

FAX: +86-21-63410100

- **Beijing**

TEL: +86-10-62102838

FAX: +86-10-62102848

- **Wuhan**

TEL: +86-27-87851061

FAX: +86-27-87851330

- **GuangZhou**

TEL: +86-20-87540700

FAX: +86-20-87544306 ext. 333

- **Chengdu**

TEL: +86-28-85236930

FAX: +86-28-85256822 ext. 814

- **Xian**

TEL: +86-29-85531943

FAX: +86-29-85539821

- **Shenyang**

TEL: +86-24-83992901

FAX: +86-24-83992909

---

- **India**

GIGABYTE TECHNOLOGY (INDIA) LIMITED

WEB address : <http://www.gigabyte.in>

---

- **Australia**

GIGABYTE TECHNOLOGY PTY. LTD.

WEB address : <http://www.gigabyte.com.au>

---

---

- **Germany**

G.B.T. TECHNOLOGY TRADING GMBH

WEB address : <http://www.gigabyte.de>

---

- **U.K.**

G.B.T. TECH. CO., LTD.

WEB address : <http://www.giga-byte.co.uk>

---

- **The Netherlands**

GIGA-BYTE TECHNOLOGY B.V.

WEB address : <http://www.giga-byte.nl>

---

- **France**

GIGABYTE TECHNOLOGY FRANCE

WEB address : <http://www.gigabyte.fr>

---

- **Italy**

WEB address : <http://www.giga-byte.it>

---

- **Spain**

GIGA-BYTE SPAIN

WEB address : <http://www.giga-byte.es>

---

- **Czech Republic**

Representative Office Of GIGA-BYTE Technology Co., Ltd.

in CZECH REPUBLIC

WEB address : <http://www.gigabyte.cz>

---

- **Turkey**

Representative Office Of GIGA-BYTE Technology Co., Ltd.

in TURKEY

WEB address : <http://www.gigabyte.com.tr>

---



---

- **Russia**

Moscow Representative Office Of GIGA-BYTE Technology Co., Ltd.

WEB address : <http://www.gigabyte.ru>

---

- **Latvia**

GIGA-BYTE Latvia

WEB address : <http://www.gigabyte.com.lv>

---

- **Poland**

Office of GIGA-BYTE TECHNOLOGY Co., Ltd. in POLAND

WEB address : <http://www.gigabyte.pl>

---

- **Ukraine**

WEB address : <http://www.gigabyte.kiev.ua>

---

- **Romania**

Representative Office Of GIGA-BYTE Technology Co., Ltd.

in Romania

WEB address : <http://www.gigabyte.com.ro>

---

- **Serbia & Montenegro**

Representative Office Of GIGA-BYTE Technology Co., Ltd.

in SERBIA & MONTENEGRO

WEB address : <http://www.gigabyte.co.yu>

---

- **GIGABYTE Global Service System**



To submit a technical or non-technical (Sales/Marketing) question, please link to :

<http://ggts.gigabyte.com.tw>

Then select your language to enter the system.