

GA-K8U

AMD Socket 754 Processor Motherboard

User's Manual

Rev. 1002

12ME-K8U-1002

Declaration of Conformity

We, Manufacturer/Importer

(full address)

G.B.T. Technology Trading GmbH

Ausschlagstr. 109, D-42699 Solingen, Germany

(declare that the product, (description of the apparatus, system, installation to which it refers)

Motherboard

GA-K8U

is in conformity with (reference to the specification under which conformity is declared) in accordance with 90/269 EEC-EMC Directive

EN 55011

Limits and methods of measurement of radio disturbance characteristics of industrial, scientific and medical (ISM) high frequency equipment

EN 61000-3-2

Disturbances in supply systems caused by household appliances and similar electrical equipment "Voltage fluctuations"

EN 55013

Limits and methods of measurement of radio disturbance characteristics of equipment

EN 55024

Information Technology equipment/Immunity measurement

EN 55014-1

Limits and methods of measurement of radio disturbance characteristics of household electrical appliances, portable tools and similar electrical apparatus

EN 50082-1

Generic immunity standard Part 1: Residential, commercial and light industry

EN 50082-2

Generic immunity standard Part 2: Industrial environment

EN 55015

Limits and methods of measurement of radio disturbance characteristics of television sets and luminaires

EN 55014-2

Immunity requirements for household appliances tools and similar apparatus

EN 55020

Immunity from radio interference of equipment, receivers and associated equipment

EN 50091-1, 2

EMC requirements for uninterruptible power systems (UPS)

EN 55022

Limits and methods of measurement of radio disturbance characteristics of information technology equipment

DIN VDE 0885
 Part 1
 Part 2
 Part 12

Cabled distribution systems; Equipment for power lines; Equipment for sound and television signals

CE marking



(EC conformity marking)

The manufacturer also declares the conformity of above mentioned product with the safety requirements in accordance with LVD 73/23 EEC

EN 60065

Safety requirements for mains operated household and similar general use

EN 60950

Safety for information technology equipment including electrical business equipment

EN 60335

Safety of household and similar electrical appliances

EN 50091-1

General and Safety requirements for uninterruptible power systems (UPS)

Manufacturer/Importer

Signature: Jimmy Huang

(Stamp)

Date: Jan. 26, 2005

Name: Timmy Huang

DECLARATION OF CONFORMITY

Per FCC Part 2, Section 2.1077(a)



Responsible Party Name: G.B.T. INC. (U.S.A.)

Address: 17358 Railroad Street

City of Industry, CA 91748

Phone/Fax No: (818) 854-9338 / (818) 854-9339

hereby declares that the product

Product Name: Motherboard

Model Number: GA-K8U

Conforms to the following specifications:

FCC Part 15, Subpart B, Section 15.107(a) and Section 15.109

(a), Class B Digital Device

Supplementary Information:

This device complies with part 15 of the FCC Rules. Operation is subject to the following two conditions: (1) This device may not cause harmful and (2) this device must accept any interference received, including that may cause undesired operation.

Representative Person's Name: ERIC LU

Signature: Eric Lu

Date: Jan. 26, 2005

Copyright

© 2005 GIGA-BYTE TECHNOLOGY CO., LTD. All rights reserved.

The trademarks mentioned in the manual are legally registered to their respective companies.

Notice

The written content provided with this product is the property of Gigabyte.

No part of this manual may be reproduced, copied, translated, or transmitted in any form or by any means without Gigabyte's prior written permission. Specifications and features are subject to change without prior notice.

Product Manual Classification

In order to assist in the use of this product, Gigabyte has categorized the user manual in the following:

- For quick installation, please refer to the "Hardware Installation Guide" included with the product.
- For detailed product information and specifications, please carefully read the "Product User Manual".
- For detailed information related to Gigabyte's unique features, please go to the "Technology Guide" section on Gigabyte's website to read or download the information you need.

For more product details, please click onto Gigabyte's website at www.gigabyte.com.tw

Table of Contents

| | |
|---|----|
| GA-K8U Motherboard Layout | 6 |
| Block Diagram | 7 |
| | |
| Chapter 1 Hardware Installation | 9 |
| 1-1 Considerations Prior to Installation | 9 |
| 1-2 Feature Summary | 10 |
| 1-3 Installation of the CPU and Heatsink | 11 |
| 1-3-1 Installation of the CPU | 11 |
| 1-3-2 Installation of the Heatsink | 12 |
| 1-4 Installation of Memory | 13 |
| 1-5 Installation of Expansion Cards | 14 |
| 1-6 I/O Back Panel Introduction | 15 |
| 1-7 Connectors Introduction | 16 |
| | |
| Chapter 2 BIOS Setup | 27 |
| The Main Menu (For example: BIOS Ver. : D3) | 28 |
| 2-1 Standard CMOS Features | 30 |
| 2-2 Advanced BIOS Features | 32 |
| 2-3 Integrated Peripherals | 33 |
| 2-4 Power Management Setup | 36 |
| 2-5 PnP/PCI Configurations | 38 |
| 2-6 PC Health Status | 39 |
| 2-7 Frequency/Voltage Control | 40 |
| 2-8 Load Fail-Safe Defaults | 41 |
| 2-9 Load Optimized Defaults | 41 |
| 2-10 Set Supervisor/User Password | 42 |
| 2-11 Save & Exit Setup | 43 |
| 2-12 Exit Without Saving | 43 |

| | |
|---|--------|
| Chapter 3 Drivers Installation | 45 |
| 3-1 Install Chipset Drivers | 45 |
| 3-2 Software Application | 46 |
| 3-3 Software Information | 46 |
| 3-4 Hardware Information | 47 |
| 3-5 Contact Us | 47 |
| Chapter 4 Appendix | 49 |
| 4-1 Unique Software Utilities | 49 |
| 4-1-1 EasyTune 5 Introduction | 49 |
| 4-1-2 Xpress Recovery Introduction | 50 |
| 4-1-3 Flash BIOS Method Introduction | 53 |
| 4-1-4 Serial ATA BIOS Setting Utility Introduction | 62 |
| 4-1-5 2- / 4- / 6- / 8- Channel Audio Function Introduction | 70 |
| 4-2 Troubleshooting | 78 |

GA-K8U Motherboard Layout

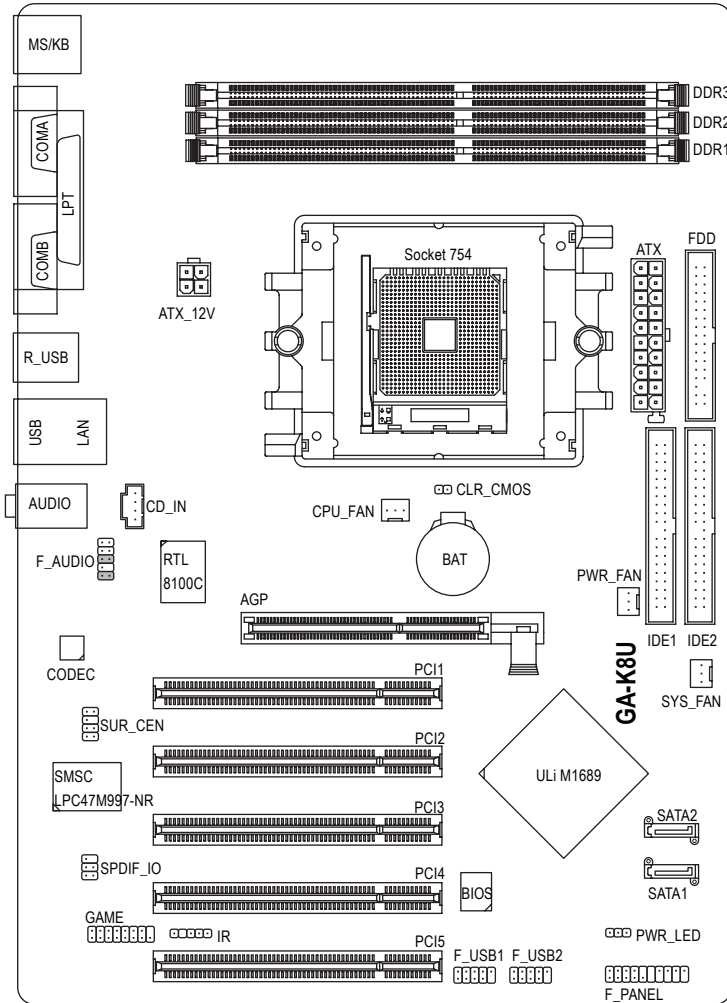

Block Diagram

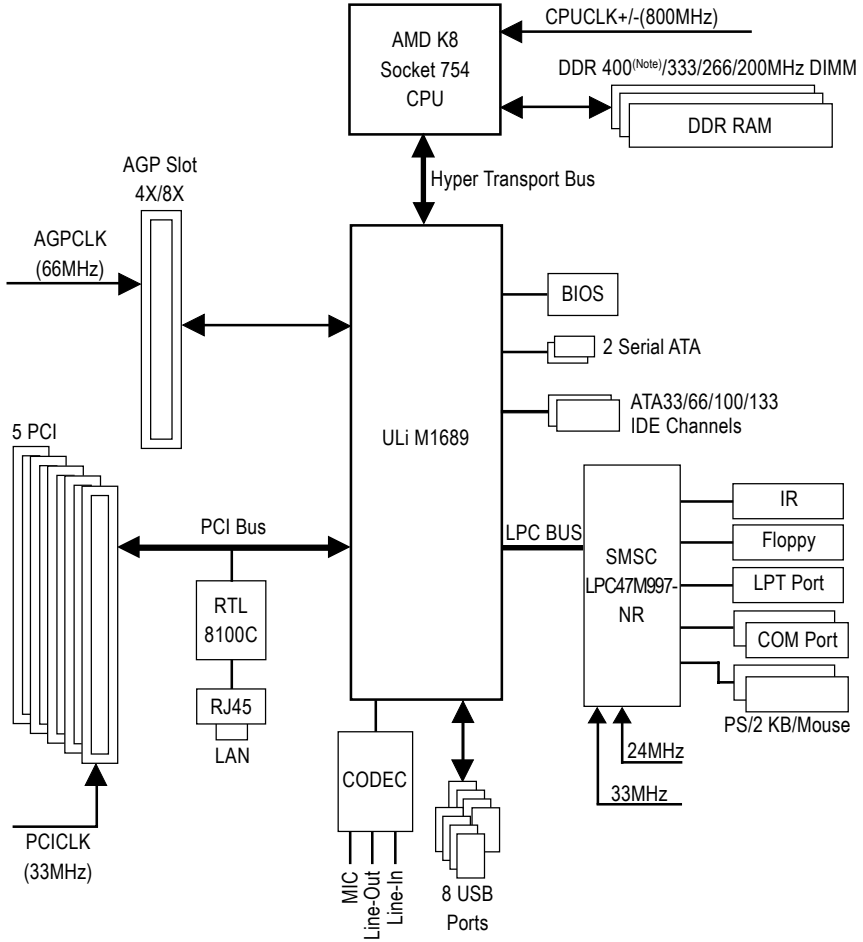

(Note) Because of CPU limitations, if you want to install DDR400 memory modules in your system, please install either one double-sided or two single-sided DDR400 memory modules. The DDR400 speed will drop down to DDR333 if you install two double-sided or three single-sided DDR400 memory modules.

Chapter 1 Hardware Installation

1-1 Considerations Prior to Installation

Preparing Your Computer

The motherboard contains numerous delicate electronic circuits and components which can become damaged as a result of electrostatic discharge (ESD). Thus, prior to installation, please follow the instructions below:

1. Please turn off the computer and unplug its power cord.
2. When handling the motherboard, avoid touching any metal leads or connectors.
3. It is best to wear an electrostatic discharge (ESD) cuff when handling electronic components (CPU, RAM).
4. Prior to installing the electronic components, please have these items on top of an antistatic pad or within a electrostatic shielding container.
5. Please verify that the power supply is switched off before unplugging the power supply connector from the motherboard.

Installation Notices

1. Prior to installation, please do not remove the stickers on the motherboard. These stickers are required for warranty validation.
2. Prior to the installation of the motherboard or any hardware, please first carefully read the information in the provided manual.
3. Before using the product, please verify that all cables and power connectors are connected.
4. To prevent damage to the motherboard, please do not allow screws to come in contact with the motherboard circuit or its components.
5. Please make sure there are no leftover screws or metal components placed on the motherboard or within the computer casing.
6. Please do not place the computer system on an uneven surface.
7. Turning on the computer power during the installation process can lead to damage to system components as well as physical harm to the user.
8. If you are uncertain about any installation steps or have a problem related to the use of the product, please consult a certified computer technician.

Instances of Non-Warranty

1. Damage due to natural disaster, accident or human cause.
2. Damage as a result of violating the conditions recommended in the user manual.
3. Damage due to improper installation.
4. Damage due to use of uncertified components.
5. Damage due to use exceeding the permitted parameters.
6. Product determined to be an unofficial Gigabyte product.

1-2 Feature Summary

| | |
|---------------------|--|
| CPU | <ul style="list-style-type: none"> ♦ Socket 754 for AMD Athlon™ 64 processor (K8) ♦ 1600MH/z system bus ♦ Supports core frequencies in excess of 3000+ and faster |
| Chipset | <ul style="list-style-type: none"> ♦ ULI M1689 Chipset |
| Memory | <ul style="list-style-type: none"> ♦ 3 DDR DIMM memory slots (supports up to 3GB memory) ♦ Supports DDR 400 ^(Note 1)/333/266/200 DIMM |
| Slots | <ul style="list-style-type: none"> ♦ 1 AGP slot supports 8X/4X(1.5V) mode ♦ 5 PCI slots |
| IDE Connections | <ul style="list-style-type: none"> ♦ 2 IDE connection (UDMA 33/ATA 66/ATA 100/ATA 133), allows connection of 4 IDE devices |
| FDD Connections | <ul style="list-style-type: none"> ♦ 1 FDD connection, allows connection of 2 FDD devices |
| Onboard SATA | <ul style="list-style-type: none"> ♦ 2 Serial ATA ports from ULI M1689 (SATA1, SATA2) |
| Peripherals | <ul style="list-style-type: none"> ♦ 1 parallel port supporting Normal/EPP/ECP mode ♦ 2 serial ports (COMA, COMB) ♦ 8 USB 2.0/1.1 ports (rear x 4, front x 4 via cable) ♦ 1 front audio connector ♦ 1 IR connector ♦ 1 PS/2 keyboard port ♦ 1 PS/2 mouse port |
| Onboard LAN | <ul style="list-style-type: none"> ♦ Onboard RTL8100C chip (10/100 Mbit) ♦ 1 RJ 45 port |
| Onboard Audio | <ul style="list-style-type: none"> ♦ ALC850 CODEC (UAJ) ♦ Supports Jack Sensing function ♦ Supports 2 / 4 / 6 / 8 channel audio ^(Note 2) ♦ Supports Line In ; Line Out ; MIC ♦ Surround Back Speaker (by optional Surround-kit) ♦ SPDIF In/Out connection ♦ CD In connection |
| I/O Control | <ul style="list-style-type: none"> ♦ SMSC LPC47M997-NR |
| Hardware Monitor | <ul style="list-style-type: none"> ♦ CPU / System temperature detection ♦ System voltage detection ♦ CPU / System fan speed detection |
| Onboard SATA RAID | <ul style="list-style-type: none"> ♦ Onboard ULI M1689 (SATA1, SATA2) ♦ supports data striping (RAID 0) or mirroring (RAID 1) or JBOD function ♦ supports data transfer rate of up to 150 MB/s ♦ supports a maximum of 2 SATA connections |
| BIOS | <ul style="list-style-type: none"> ♦ Use of licensed AWARD BIOS ♦ Supports Q-Flash |
| Additional Features | <ul style="list-style-type: none"> ♦ Supports @BIOS ♦ Supports EasyTune 5 ^(Note 3) |
| Overclocking | <ul style="list-style-type: none"> ♦ Over Voltage via BIOS (CPU/ DDR/ VCC18/ VCC12/ AGP) ♦ Over Clock via BIOS (CPU/ PCI) |
| Form Factor | <ul style="list-style-type: none"> ♦ ATX form factor; 29.4cm x 21.0cm |

(Note 1) Because of CPU limitations, if you want to install DDR400 memory modules in your system, please install either one double-sided or two single-sided DDR400 memory modules. The DDR400 speed will drop down to DDR333 if you install two double-sided or three single-sided DDR400 memory modules.

(Note 2) To set up an 8 channel audio configuration, you must use Audio Combo Kit (optional device).

(Note 3) EasyTune 5 functions may vary depending on different motherboards.

1-3 Installation of the CPU and Heatsink



Before installing the CPU, please comply with the following conditions:

1. Please make sure that the motherboard supports the CPU.
2. Please take note of the one indented corner of the CPU. If you install the CPU in the wrong direction, the CPU will not insert properly. If this occurs, please change the insert direction of the CPU.
3. Please add an even layer of heat sink paste between the CPU and heatsink.
4. Please make sure the heatsink is installed on the CPU prior to system use, otherwise overheating and permanent damage of the CPU may occur.
5. Please set the CPU host frequency in accordance with the processor specifications. It is not recommended that the system bus frequency be set beyond hardware specifications since it does not meet the required standards for the peripherals. If you wish to set the frequency beyond the proper specifications, please do so according to your hardware specifications including the CPU, graphics card, memory, hard drive, etc.

1-3-1 Installation of the CPU

Check the processor pins to see that none are bent. Move the socket lever to the unlocked position as shown in Figure 1.(90° to the plane of the motherboard) prior to inserting the processor. The pin 1 location is designated on the processor by a copper triangle that matches up to a triangle on the socket as shown in Figure 2. Align the processor to the socket and gently lower it into place. Do not force the processor into the socket.

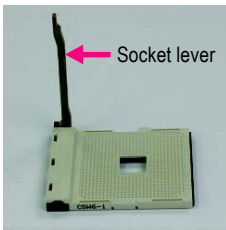

Fig.1
Position lever at a 90 degree angle.

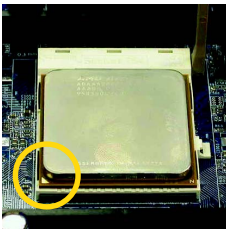

Fig.2
A gold-colored triangle is marked one edge of the CPU. Please align this edge with the socket edge closest to the CPU lever. Gently place the CPU into position making sure that the CPU pins fit perfectly into their holes. Once the CPU is positioned into its socket, place one finger down on the middle of the CPU and gently press the metal lever back into its original position.



Please use extra care when installing the CPU. The CPU will not fit if positioned incorrectly. Rather than applying force, please change the positioning of the CPU.

1-3-2 Installation of the Heatsink



Fig.1

Before installing the heat sink, please first add an even layer of heat sink paste on the surface of the CPU. Install all the heat sink components (Please refer to the heat sink manual for detailed installation instructions).

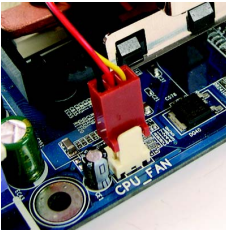

Fig.2

Please connect the heat sink power connector to the CPU_FAN connector located on the motherboard so that the heat sink can properly function to prevent CPU overheating.



NOTE

The heat sink may adhere to the CPU as a result of hardening of the heat sink paste. To prevent such an occurrence, it is suggested that either thermal tape rather than heat sink paste be used for heat dissipation or using extreme care when removing the heat sink.

1-4 Installation of Memory



Before installing the memory modules, please comply with the following conditions:

1. Please make sure that the memory used is supported by the motherboard. It is recommended that memory of similar capacity, specifications and brand be used.
2. Before installing or removing memory modules, please make sure that the computer power is switched off to prevent hardware damage.
3. Memory modules have a foolproof insertion design. A memory module can be installed in only one direction. If you are unable to insert the module, please switch the direction.

The motherboard supports DDR memory modules, whereby BIOS will automatically detect memory capacity and specifications. Memory modules are designed so that they can be inserted only in one direction. The memory capacity used can differ with each slot.

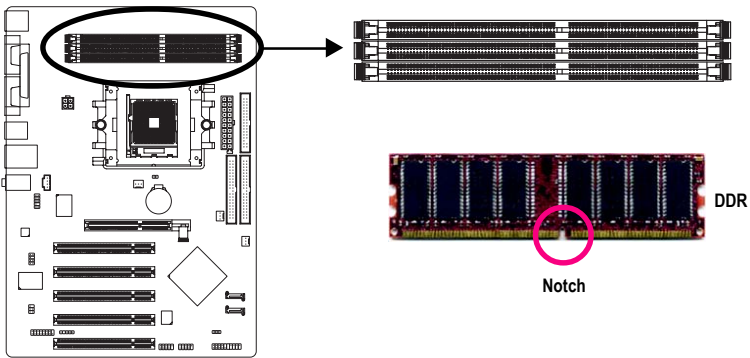

Fig.1

The DIMM socket has a notch, so the DIMM memory module can only fit in one direction. Insert the DIMM memory module vertically into the DIMM socket. Then push it down.



Fig.2

Close the plastic clip at both edges of the DIMM sockets to lock the DIMM module.

Reverse the installation steps when you wish to remove the DIMM module.

1-5 Installation of Expansion Cards

You can install your expansion card by following the steps outlined below:

1. Read the related expansion card's instruction document before install the expansion card into the computer.
2. Remove your computer's chassis cover, screws and slot bracket from the computer.
3. Press the expansion card firmly into expansion slot in motherboard.
4. Be sure the metal contacts on the card are indeed seated in the slot.
5. Replace the screw to secure the slot bracket of the expansion card.
6. Replace your computer's chassis cover.
7. Power on the computer, if necessary, setup BIOS utility of expansion card from BIOS.
8. Install related driver from the operating system.

Installing a AGP VGA card:

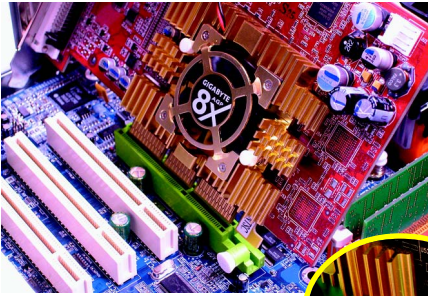

Please carefully pull out the small white-drawable bar at the end of the AGP slot when you try to install/uninstall the VGA card. Please align the VGA card to the onboard AGP slot and press firmly down on the slot. Make sure your VGA card is locked by the small white-drawable bar.

1-6 I/O Back Panel Introduction

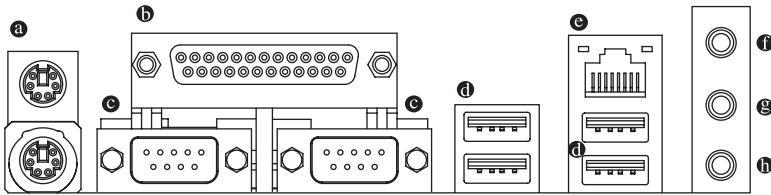

a PS/2 Keyboard and PS/2 Mouse Connector

To install a PS/2 port keyboard and mouse, plug the mouse to the upper port (green) and the keyboard to the lower port (purple).

b Parallel Port

The parallel port allows connection of a printer, scanner and other peripheral devices.

c COM A, COMB (Serial Port)

Connects to serial-based mouse or data processing devices.

d USB port

Before you connect your device(s) into USB connector(s), please make sure your device(s) such as USB keyboard, mouse, scanner, zip, speaker...etc. have a standard USB interface. Also make sure your OS supports USB controller. If your OS does not support USB controller, please contact OS vendor for possible patch or driver upgrade. For more information please contact your OS or device(s) vendors.

e LAN Port

The provided Internet connection is fast Ethernet, providing data transfer speeds of 10/100Mbps.

f Line In

Devices like CD-ROM, walkman etc. can be connected to Line In jack.

Line Out

Connect the stereo speakers, earphone or front surround speakers to this connector.

Line In

Microphone can be connected to MIC In jack.



You can use audio software to configure 2-/4-/6-/8-channel audio functioning.

1-7 Connectors Introduction

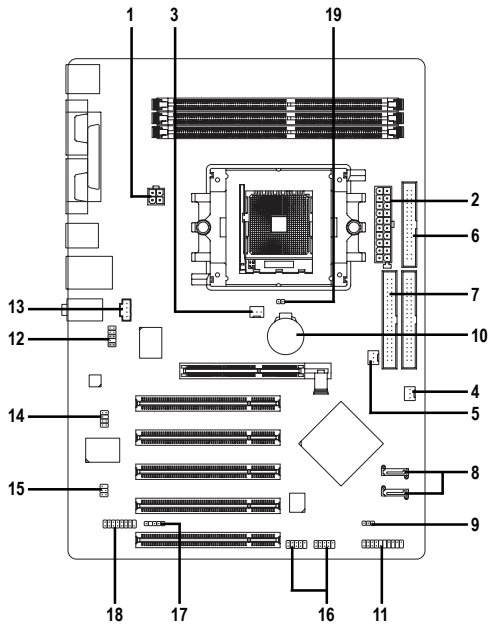

| | |
|--------------------------|---------------------|
| 1) ATX_12V | 11) F_PANEL |
| 2) ATX (Power Connector) | 12) F_AUDIO |
| 3) CPU_FAN | 13) CD_IN |
| 4) SYS_FAN | 14) SUR_CEN |
| 5) PWR_FAN | 15) SPDIF_IO |
| 6) FDD | 16) F_USB1 / F_USB2 |
| 7) IDE1 / IDE2 | 17) IR |
| 8) SATA1 / SATA2 | 18) GAME |
| 9) PWR_LED | 19) CLR_CMOS |
| 10) BAT | |

1/2) ATX_12V / ATX (Power Connector)

With the use of the power connector, the power supply can supply enough stable power to all the components on the motherboard. Before connecting the power connector, please make sure that all components and devices are properly installed. Align the power connector with its proper location on the motherboard and connect tightly.

The ATX_12V power connector mainly supplies power to the CPU. If the ATX_12V power connector is not connected, the system will not start.

Caution!

Please use a power supply that is able to handle the system voltage requirements. It is recommended that a power supply that can withstand high power consumption be used (300W or greater). If a power supply is used that does not provide the required power, the result can lead to an unstable system or a system that is unable to start.

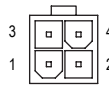
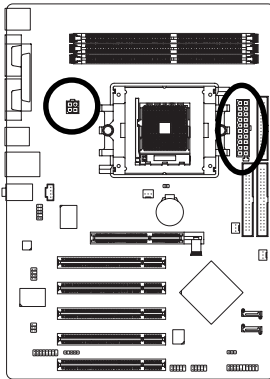

| Pin No. | Definition |
|---------|------------|
| 1 | GND |
| 2 | GND |
| 3 | +12V |
| 4 | +12V |

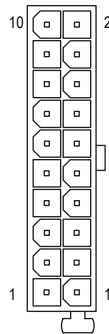

| Pin No. | Definition |
|---------|----------------------|
| 1 | 3.3V |
| 2 | 3.3V |
| 3 | GND |
| 4 | +5V |
| 5 | GND |
| 6 | +5V |
| 7 | GND |
| 8 | Power Good |
| 9 | 5V SB (stand by +5V) |
| 10 | +12V |
| 11 | 3.3V |
| 12 | -12V |
| 13 | GND |
| 14 | PS_ON(soft on/off) |
| 15 | GND |
| 16 | GND |
| 17 | GND |
| 18 | -5V |
| 19 | +5V |
| 20 | +5V |

3/4/5) CPU_FAN / SYS_FAN / PWR_FAN (Cooler Fan Power Connector)

The cooler fan power connector supplies a +12V power voltage via a 3-pin power connector and possesses a foolproof connection design.

Most coolers are designed with color-coded power connector wires. A red power connector wire indicates a positive connection and requires a +12V power voltage. The black connector wire is the ground wire (GND).

Please remember to connect the power to the cooler to prevent system overheating and failure.

Caution!

Please remember to connect the power to the CPU fan to prevent CPU overheating and failure.

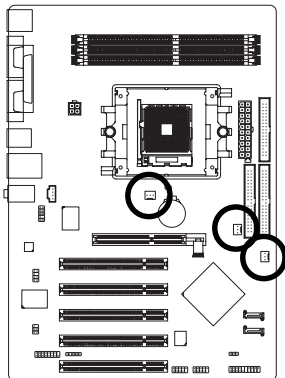

CPU_FAN

| Pin No. | Definition |
|---------|------------|
| 1 | GND |
| 2 | +12V |
| 3 | Sense |



SYS_FAN / PWR_FAN

6) FDD (FDD Connector)

The FDD connector is used to connect the FDD cable while the other end of the cable connects to the FDD drive. The types of FDD drives supported are: 360KB, 720KB, 1.2MB, 1.44MB and 2.88MB.

Please connect the red power connector wire to the pin1 position.

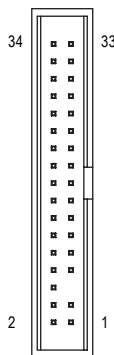
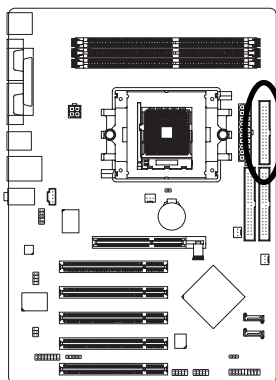

7) IDE1 / IDE2 (IDE Connector)

An IDE device connects to the computer via an IDE connector. One IDE connector can connect to one IDE cable, and the single IDE cable can then connect to two IDE devices (hard drive or optical drive). If you wish to connect two IDE devices, please set the jumper on one IDE device as Master and the other as Slave (for information on settings, please refer to the instructions located on the IDE device).

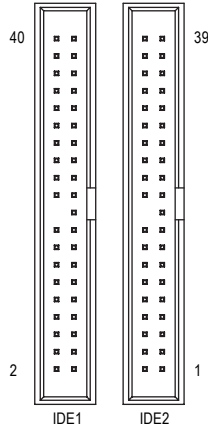
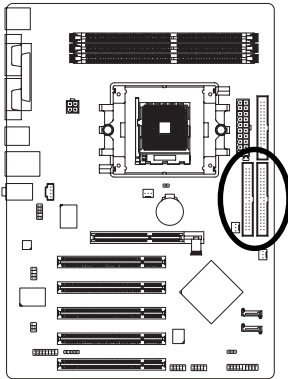

8) SATA1 / SATA2 (Serial ATA Connector)

Serial ATA can provide up to 150MB/s transfer rate. Please refer to the BIOS setting for the Serial ATA and install the proper driver in order to work properly.

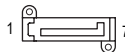
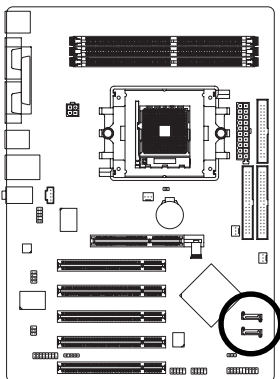

| Pin No. | Definition |
|---------|------------|
| 1 | GND |
| 2 | TXP |
| 3 | TXN |
| 4 | GND |
| 5 | RXN |
| 6 | RXP |
| 7 | GND |

9) PWR_LED

PWR_LED is connect with the system power indicator to indicate whether the system is on/off. It will blink when the system enters suspend mode.

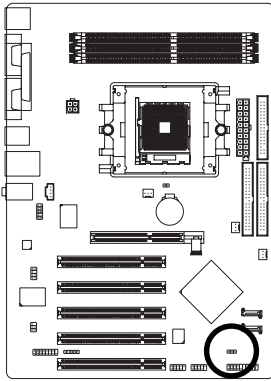

1

| Pin No. | Definition |
|---------|------------|
| 1 | MPD+ |
| 2 | MPD- |
| 3 | MPD- |

10) BAT (Battery)

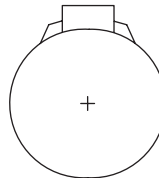
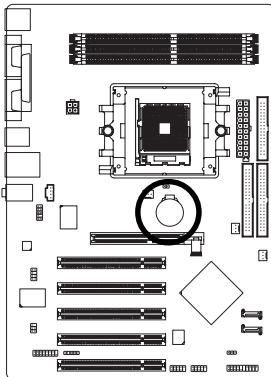

- ❖ Danger of explosion if battery is incorrectly replaced.
- ❖ Replace only with the same or equivalent type recommended by the manufacturer.
- ❖ Dispose of used batteries according to the manufacturer's instructions.

If you want to erase CMOS...

1. Turn off the computer and unplug the power cord.
2. Remove the battery, wait for 30 seconds.
3. Re-install the battery.
4. Plug the power cord and turn on the computer.

11) F_PANEL (Front Panel Jumper)

Please connect the power LED, PC speaker, reset switch and power switch etc of your chassis front panel to the F_PANEL connector according to the pin assignment below.

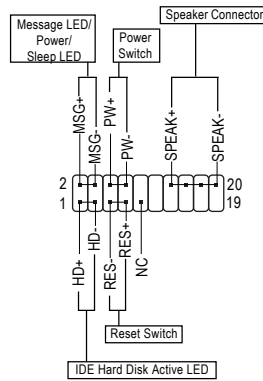
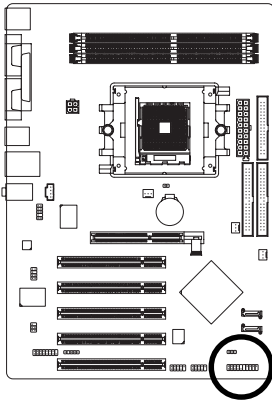

| | |
|-----------------------------------|--|
| MSG (Message LED/Power/Sleep LED) | Pin 1: LED anode(+) Pin 2: LED cathode(-) |
| PW (Power Switch) | Open: Normal Operation Close: Power On/Off |
| SPEAK (Speaker Connector) | Pin 1: VCC(+) Pin 2- Pin 3: NC Pin 4: Data(-) |
| HD (IDE Hard Disk Active LED) | Pin 1: LED anode(+) Pin 2: LED cathode(-) |
| RES (Reset Switch) | Open: Normal Operation Close: Reset Hardware System |
| NC | NC |

12) F_AUDIO (Front Audio Panel Connector)

If you want to use Front Audio connector, you must remove 5-6, 9-10 Jumper.

In order to utilize the front audio header, your chassis must have front audio connector. Also please make sure the pin assignments for the cable are the same as the pin assignments for the front audio header. To find out if the chassis you are buying support front audio connector, please contact your dealer. Please note, you can have the alternative of using front audio connector or of using rear audio connector to play sound.

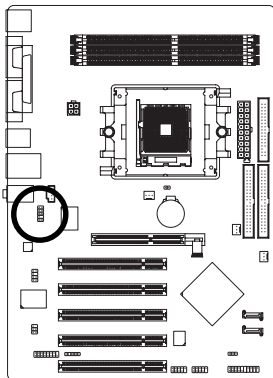

| Pin No. | Definition |
|---------|--------------------------|
| 1 | MIC |
| 2 | GND |
| 3 | MIC_BIAS |
| 4 | Power |
| 5 | Front Audio (R) |
| 6 | Rear Audio (R)/ Return R |
| 7 | NC |
| 8 | No Pin |
| 9 | Front Audio (L) |
| 10 | Rear Audio (L)/ Return L |

13) CD_IN (CD In Connector)

Connect CD-ROM or DVD-ROM audio out to the connector.

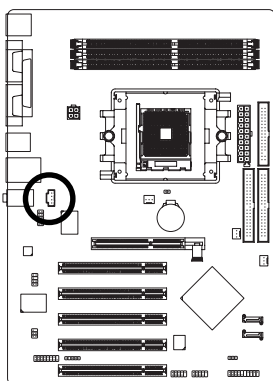

| Pin No. | Definition |
|---------|------------|
| 1 | CD-L |
| 2 | GND |
| 3 | GND |
| 4 | CD-R |

14) SUR_CEN (Surround Center Connector)

Please contact your nearest dealer for optional SUR_CEN cable.

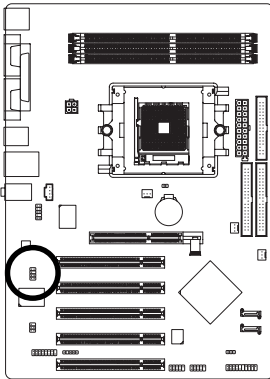

| Pin No. | Definition |
|---------|------------|
| 1 | SUR OUTL |
| 2 | SUR OUTR |
| 3 | GND |
| 4 | No Pin |
| 5 | CENTER_OUT |
| 6 | BASS_OUT |
| 7 | AUX_L |
| 8 | AUX_R |

15) SPDIF_IO (SPDIF In / Out Connector)

The SPDIF output is capable of providing digital audio to external speakers or compressed AC3 data to an external Dolby Digital Decoder. Use this feature only when your stereo system has digital input and output function. Use SPDIF in feature only when your device has digital output function. Be careful with the polarity of the SPDIF_IO connector. Check the pin assignment carefully while you connect the SPDIF cable, incorrect connection between the cable and connector will make the device unable to work or even damage it. For optional SPDIF cable, please contact your local dealer.

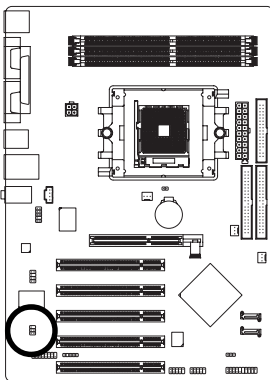

| Pin No. | Definition |
|---------|------------|
| 1 | Power |
| 2 | No Pin |
| 3 | SPDIF |
| 4 | SPDIFI |
| 5 | GND |
| 6 | GND |

16) F_USB1 / F_USB2 (Front USB Connector)

Be careful with the polarity of the front USB connector. Check the pin assignment carefully while you connect the front USB cable, incorrect connection between the cable and connector will make the device unable to work or even damage it. For optional front USB cable, please contact your local dealer.

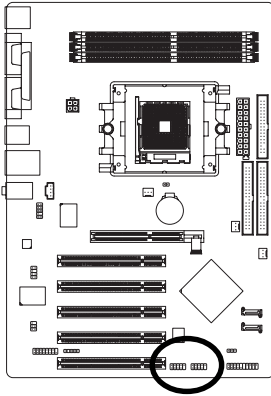

| Pin No. | Definition |
|---------|------------|
| 1 | Power |
| 2 | Power |
| 3 | USB DX- |
| 4 | USB Dy- |
| 5 | USB DX+ |
| 6 | USB Dy+ |
| 7 | GND |
| 8 | GND |
| 9 | No Pin |
| 10 | NC |

17) IR

Be careful with the polarity of the IR connector while you connect the IR. Please contact your nearest dealer for optional IR device.

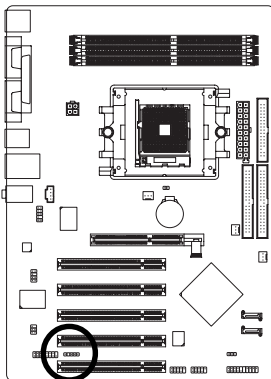

| Pin No. | Definition |
|---------|------------|
| 1 | Power |
| 2 | No Pin |
| 3 | IR RX |
| 4 | GND |
| 5 | IR TX |

18) GAME (Game Connector)

This connector supports joystick, MIDI keyboard and other relate audio devices. Check the pin assignment while you connect the game cables. Please contact your nearest dealer for optional game cables.

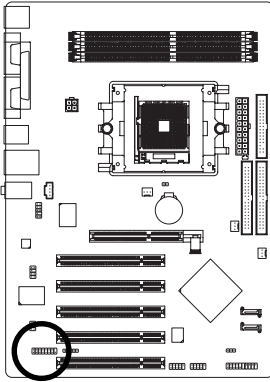

| Pin No. | Definition |
|---------|------------|
| 1 | Power |
| 2 | GRX1_R |
| 3 | GND |
| 4 | GPSA2 |
| 5 | Power |
| 6 | GPX2_R |
| 7 | GPY2_R |
| 8 | MSI_R |
| 9 | GPSA1 |
| 10 | GND |
| 11 | GPY1_R |
| 12 | Power |
| 13 | GPSB1 |
| 14 | MSO_R |
| 15 | GPSB2 |
| 16 | No Pin |



If you want to use a force feedback joystick, go to **Midi Port Address** under the **Integrated Peripherals** menu in BIOS Setup to specify the base I/O address.

19) CLR_CMOS (Clear CMOS)

You may clear the CMOS data to its default values by this jumper. To clear CMOS, temporarily short 1-2 pin. Default doesn't include the "Shunter" to prevent from improper use this jumper.

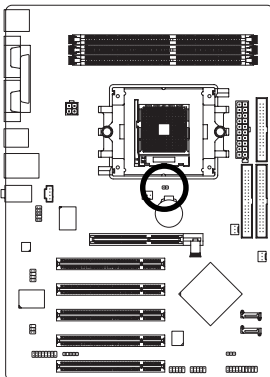

1 Open: Normal

1 Short: Clear CMOS

Chapter 2 BIOS Setup

BIOS (Basic Input and Output System) includes a CMOS SETUP utility which allows user to configure required settings or to activate certain system features.

The CMOS SETUP saves the configuration in the CMOS SRAM of the motherboard.

When the power is turned off, the battery on the motherboard supplies the necessary power to the CMOS SRAM.

When the power is turned on, pushing the button during the BIOS POST (Power-On Self Test) will take you to the CMOS SETUP screen. You can enter the BIOS setup screen by pressing "Ctrl + F1".

When setting up BIOS for the first time, it is recommended that you save the current BIOS to a disk in the event that BIOS needs to be reset to its original settings. If you wish to upgrade to a new BIOS, either GIGABYTE's Q-Flash or @BIOS utility can be used.

Q-Flash allows the user to quickly and easily update or backup BIOS without entering the operating system.

@BIOS is a Windows-based utility that does not require users to boot to DOS before upgrading BIOS but directly download and update BIOS from the Internet.

CONTROL KEYS

| | |
|--------------|---|
| <↑><↓><←><→> | Move to select item |
| <Enter> | Select Item |
| <Esc> | Main Menu - Quit and not save changes into CMOS Status Page Setup Menu and Option Page Setup Menu - Exit current page and return to Main Menu |
| <Page Up> | Increase the numeric value or make changes |
| <Page Down> | Decrease the numeric value or make changes |
| <F1> | General help, only for Status Page Setup Menu and Option Page Setup Menu |
| <F2> | Item Help |
| <F5> | Restore the previous CMOS value from CMOS, only for Option Page Setup Menu |
| <F6> | Load the file-safe default CMOS value from BIOS default table |
| <F7> | Load the Optimized Defaults |
| <F8> | Q-Flash utility |
| <F9> | System Information |
| <F10> | Save all the CMOS changes, only for Main Menu |

Main Menu

The on-line description of the highlighted setup function is displayed at the bottom of the screen.

Status Page Setup Menu / Option Page Setup Menu

Press F1 to pop up a small help window that describes the appropriate keys to use and the possible selections for the highlighted item. To exit the Help Window press <Esc>.

The Main Menu (For example: BIOS Ver. : D3)

Once you enter Award BIOS CMOS Setup Utility, the Main Menu (as figure below) will appear on the screen. Use arrow keys to select among the items and press <Enter> to accept or enter the sub-menu.

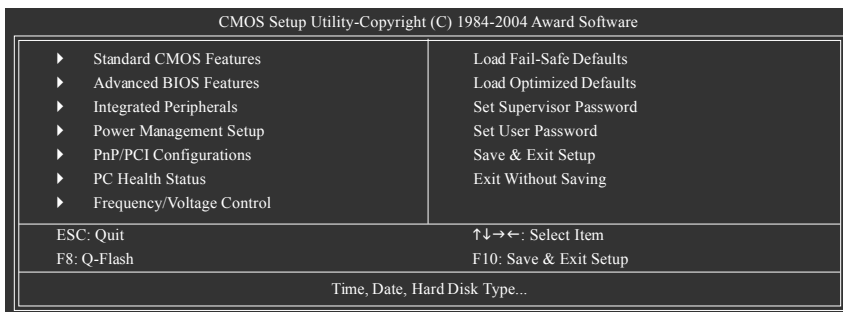

If you can't find the setting you want, please press "Ctrl+F1" to search the advanced option hidden.

■ Standard CMOS Features

This setup page includes all the items in standard compatible BIOS.

■ Advanced BIOS Features

This setup page includes all the items of Award special enhanced features.

■ Integrated Peripherals

This setup page includes all onboard peripherals.

■ Power Management Setup

This setup page includes all the items of Green function features.

■ PnP/PCI Configuration

This setup page includes all the configurations of PCI & PnP ISA resources.

■ PC Health Status

This setup page is the System auto detect Temperature, voltage, fan, speed.

■ Frequency/Voltage Control

This setup page is control CPU clock and frequency ratio.

■ Load Fail-Safe Defaults

Fail-Safe Defaults indicates the value of the system parameters which the system would be in safe configuration.

■ Load Optimized Defaults

Optimized Defaults indicates the value of the system parameters which the system would be in best performance configuration.

■ Set Supervisor Password

Change, set, or disable password. It allows you to limit access to the system and Setup, or just to Setup.

■ Set User Password

Change, set, or disable password. It allows you to limit access to the system.

■ Save & Exit Setup

Save CMOS value settings to CMOS and exit setup.

■ Exit Without Saving

Abandon all CMOS value changes and exit setup.

2-1 Standard CMOS Features

| CMOS Setup Utility-Copyright (C) 1984-2004 Award Software Standard CMOS Features | | |
|--|---------------------|---|
| Date (mm:dd:yy) | Thu, Jan 20 2005 | Item Help |
| Time (hh:mm:ss) | 22:31:24 | Menu Level▶ |
| ▶ IDE Channel 0 Master | [None] | Change the day, month, year |
| ▶ IDE Channel 0 Slave | [None] | <Week> |
| ▶ IDE Channel 1 Master | [None] | Sun. to Sat. |
| ▶ IDE Channel 1 Slave | [None] | <Month> |
| ▶ IDE Channel 2 Master | [None] | Jan. to Dec. |
| ▶ IDE Channel 3 Master | [None] | <Day> |
| Drive A | [1.44M, 3.5"] | 1 to 31 (or maximum allowed in the month) |
| Drive B | [None] | <Year> |
| Floppy 3 Mode Support | [Disabled] | 1999 to 2098 |
| Halt On | [All, But Keyboard] | |
| Base Memory | 640K | |
| Extended Memory | 239M | |
| Total Memory | 240M | |
| ↑↓→←: Move Enter: Select +/-/PU/PD: Value F10: Save ESC: Exit F1: General Help F5: Previous Values F6: Fail-Safe Defaults F7: Optimized Defaults | | |

☞ Date

The date format is <week>, <month>, <day>, <year>.

- ▶▶ Week The week, from Sun. to Sat., determined by the BIOS and is display only
- ▶▶ Month The month, Jan. Through Dec.
- ▶▶ Day The day, from 1 to 31 (or the maximum allowed in the month)
- ▶▶ Year The year, from 1999 through 2098

☞ Time

The times format in <hour> <minute> <second>. The time is calculated base on the 24-hour military-time clock. For example, 1 p.m. is 13:00:00.

☞ IDE Channel 0 Master/Slave; IDE Channel 1 Master/Slave

- ▶▶ IDE HDD Auto-Detection Press "Enter" to select this option for automatic device detection.
- ▶▶ IDE Channel 0 Master/Slave; IDE Channel 1 Master/Slave

IDE devices setup. You can use one of three methods:

- Auto Allows BIOS to automatically detect IDE devices during POST. (Default value)
- None Select this if no IDE devices are used and the system will skip the automatic detection step and allow for faster system start up.
- Manual User can manually input the correct settings.
- ▶▶ Access Mode Use this to set the access mode for the hard drive. The four options are: CHS/LBA/Large/Auto(default:Auto)

☞ IDE Channel 2/3 Master

- ▶▶ IDE HDD Auto-Detection Press "Enter" to select this option for automatic device detection.
- ▶▶ Extended IDE Drive

SATA IDE devices setup. You can use one of two methods:

- Auto Allows BIOS to automatically detect SATA IDE devices during POST(default)
- None Select this if no SATA IDE devices are used and the system will skip the automatic detection step and allow for faster system start up.
- ▶▶ Access Mode Use this to set the access mode for the hard drive. The two options are: Large/Auto(default:Auto)

» Capacity Capacity of correctly installed hard drive.
Hard drive information should be labeled on the outside drive casing. Enter the appropriate option based on this information.

- » Cylinder Number of cylinders
- » Head Number of heads
- » Precomp Write precomp
- » Landing Zone Landing zone
- » Sector Number of sectors

☞ Drive A / Drive B

The category identifies the types of floppy disk drive A or drive B that has been installed in the computer.

- » None No floppy drive installed.
- » 360K, 5.25" 5.25 inch PC-type standard drive; 360K byte capacity.
- » 1.2M, 5.25" 5.25 inch AT-type high-density drive; 1.2M byte capacity.
(3.5 inch when 3 Mode is Enabled).
- » 720K, 3.5" 3.5 inch double-sided drive; 720K byte capacity.
- » 1.44M, 3.5" 3.5 inch double-sided drive; 1.44M byte capacity.
- » 2.88M, 3.5" 3.5 inch double-sided drive; 2.88M byte capacity.

☞ Floppy 3 Mode Support (for Japan Area)

- » Disabled Normal Floppy Drive. (Default value)
- » Drive A Drive A is 3 mode Floppy Drive.
- » Drive B Drive B is 3 mode Floppy Drive.
- » Both Drive A & B are 3 mode Floppy Drives.

☞ Halt on

The category determines whether the computer will stop if an error is detected during power up.

- » No Errors The system boot will not stop for any error that may be detected and you will be prompted.
- » All Errors Whenever the BIOS detects a non-fatal error the system will be stopped.
- » All, But Keyboard The system boot will not stop for a keyboard error; it will stop for all other errors. (Default value)
- » All, But Diskette The system boot will not stop for a disk error; it will stop for all other errors.
- » All, But Disk/Key The system boot will not stop for a keyboard or disk error; it will stop for all other errors.

☞ Memory

The category is display-only which is determined by POST (Power On Self Test) of the BIOS.

» Base Memory

The POST of the BIOS will determine the amount of base (or conventional) memory installed in the system. The value of the base memory is typically 512K for systems with 512K memory installed on the motherboard, or 640K for systems with 640K or more memory installed on the motherboard.

» Extended Memory

The BIOS determines how much extended memory is present during the POST.

This is the amount of memory located above 1 MB in the CPU's memory address map.

» Total Memory

This item displays the memory size that used.

2-2 Advanced BIOS Features

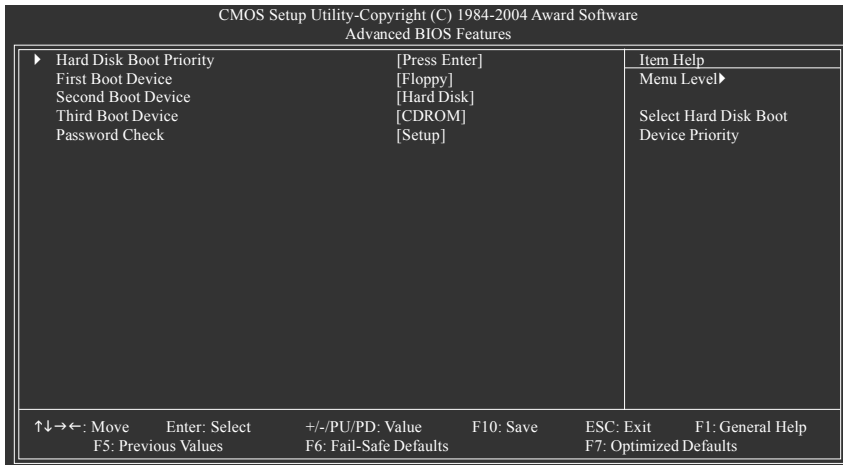

☞ Hard Disk Boot Priority

Select boot sequence for onboard(or add-on cards) SCSI, RAID, etc.

Use <↑> or <↓> to select a device, then press<+> to move it up, or <-> to move it down the list. Press <ESC> to exit this menu.

☞ First / Second / Third Boot Device

- ▶ Floppy Select your boot device priority by Floppy.
- ▶ LS120 Select your boot device priority by LS120.
- ▶ Hard Disk Select your boot device priority by Hard Disk.
- ▶ CDROM Select your boot device priority by CDROM.
- ▶ ZIP Select your boot device priority by ZIP.
- ▶ USB-FDD Select your boot device priority by USB-FDD.
- ▶ USB-ZIP Select your boot device priority by USB-ZIP.
- ▶ USB-CDROM Select your boot device priority by USB-CDROM.
- ▶ USB-HDD Select your boot device priority by USB-HDD.
- ▶ LAN Select your boot device priority by LAN.
- ▶ Disabled Disable this function.

☞ Password Check

- ▶ Setup The system will boot but will not access to Setup page if the correct password is not entered at the prompt. (Default value)
- ▶ System The system will not boot and will not access to Setup page if the correct password is not entered at the prompt.

2-3 Integrated Peripherals

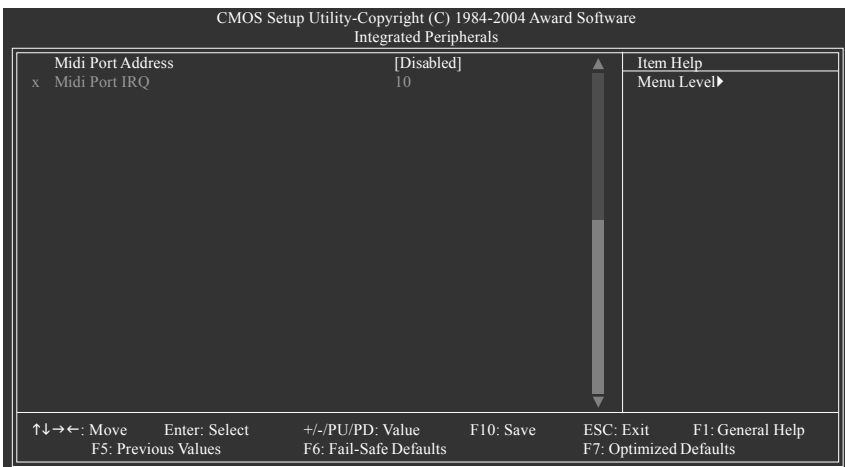
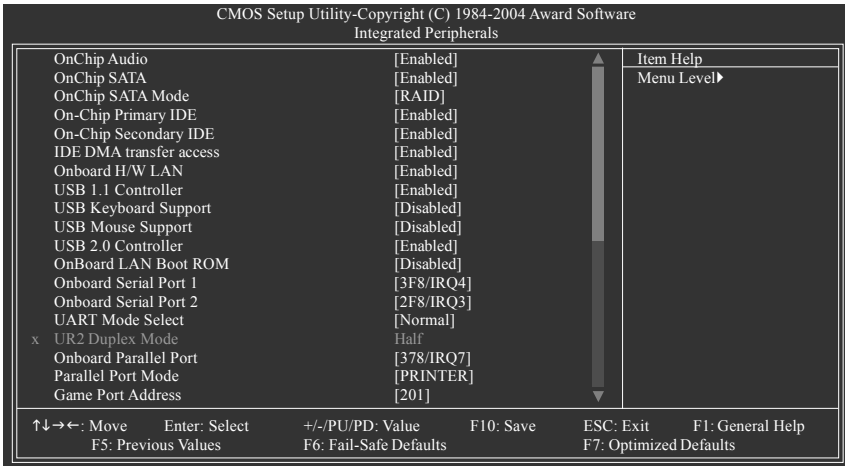

☞ OnChip Audio

- ▶▶ Enabled Enable onboard AC97 audio function. (Default value)
- ▶▶ Disabled Disable onboard AC97 audio function.

☞ OnChip SATA

- ▶▶ Enabled Enable onboard Serial ATA function. (Default value)
- ▶▶ Disabled Disable onboard Serial ATA function.

☞ OnChip SATA Mode

- ▶▶ RAID Set onboard Serial ATA function as RAID. (Default value)
- ▶▶ IDE Set onboard Serial ATA function as IDE.

☞ On-Chip Primary IDE

- ▶▶ Enabled Enable onboard 1st channel IDE port. (Default value)
- ▶▶ Disabled Disable onboard 1st channel IDE port.

☞ On-Chip Secondary IDE

- ▶▶ Enabled Enable onboard 2nd channel IDE port. (Default value)
- ▶▶ Disabled Disable onboard 2nd channel IDE port.

☞ IDE DMA transfer access

- ▶▶ Enabled Enable IDE DMA transfer access. (Default value)
- ▶▶ Disabled Disable this function.

☞ Onboard H/W LAN

- ▶▶ Enabled Enable onboard H/W LAN function. (Default value)
- ▶▶ Disabled Disable this function.

☞ USB 1.1 Controller

- ▶▶ Enabled Enable USB 1.1 controller. (Default value)
- ▶▶ Disabled Disable USB 1.1 controller.

☞ USB Keyboard Support

- ▶▶ Enabled Enable USB keyboard support.
- ▶▶ Disabled Disable USB keyboard support. (Default value)

☞ USB Mouse Support

- ▶▶ Enabled Enable USB mouse support.
- ▶▶ Disabled Disable USB mouse support. (Default value)

☞ USB 2.0 Controller

You can disable this function if you are not using onboard USB 2.0 feature.

- ▶▶ Enabled Enable USB 2.0 controller. (Default value)
- ▶▶ Disabled Disable USB 2.0 controller.

☞ OnBoard LAN Boot ROM

This function decide whether to invoke the boot ROM of the onboard LAN chip.

- ▶▶ Disabled Disable this function. (Default value)
- ▶▶ Enabled Enable this function.

☞ Onboard Serial Port 1

- ▶▶ Auto BIOS will automatically setup the port 1 address.
- ▶▶ 3F8/IRQ4 Enable onboard Serial port 1 and address is 3F8/IRQ4. (Default value)
- ▶▶ 2F8/IRQ3 Enable onboard Serial port 1 and address is 2F8/IRQ3.
- ▶▶ 3E8/IRQ4 Enable onboard Serial port 1 and address is 3E8/IRQ4.
- ▶▶ 2E8/IRQ3 Enable onboard Serial port 1 and address is 2E8/IRQ3.
- ▶▶ Disabled Disable onboard Serial port 1.

☞ Onboard Serial Port 2

- ▶▶ Auto BIOS will automatically setup the port 1 address.
- ▶▶ 3F8/IRQ4 Enable onboard Serial port 2 and address is 3F8/IRQ4.
- ▶▶ 2F8/IRQ3 Enable onboard Serial port 2 and address is 2F8/IRQ3. (Default value)
- ▶▶ 3E8/IRQ4 Enable onboard Serial port 2 and address is 3E8/IRQ4.
- ▶▶ 2E8/IRQ3 Enable onboard Serial port 2 and address is 2E8/IRQ3.
- ▶▶ Disabled Disable onboard Serial port 2.

☞ **UART Mode Select**

This item allows you to determine which Infra Red(IR) function of Onboard I/O chip.

- ▶▶ Normal Set onboard I/O chip UART to normal mode. (Default value)
- ▶▶ IrDA Set onboard I/O chip UART to IrDA mode.
- ▶▶ ASKIR Set onboard I/O chip UART to ASKIR mode.

☞ **UR2 Duplex Mode**

This feature allows you to select IR mode.

This function will be available when "UART Mode Select" is not set at Normal.

- ▶▶ Half IR Function Duplex Half. (Default value)
- ▶▶ Full IR Function Duplex Full.

☞ **Onboard Parallel port**

- ▶▶ Disabled Disable onboard LPT port.
- ▶▶ 378/IRQ7 Enable onboard LPT port and address is 378/IRQ7. (Default value)
- ▶▶ 278/IRQ5 Enable onboard LPT port and address is 278/IRQ5.
- ▶▶ 3BC/IRQ7 Enable onboard LPT port and address is 3BC/IRQ7.

☞ **Parallel Port Mode**

- ▶▶ SPP Using Parallel port as Standard Parallel Port.
- ▶▶ EPP1.9+SPP Using Parallel port as Enhanced Parallel Port 1.9 and SPP mode.
- ▶▶ ECP Using Parallel port as Extended Capabilities Port.
- ▶▶ EPP1.9+ECP Using Parallel port as Enhanced Parallel Port 1.9 and ECP mode.
- ▶▶ PRINTER Using Parallel port as printer port. (Default value)
- ▶▶ EPP1.7+SPP Using Parallel port as Enhanced Parallel Port 1.7 and SPP mode.
- ▶▶ EPP1.7+ECP Using Parallel port as Enhanced Parallel Port 1.7 and ECP mode.

☞ **Game Port Address**

- ▶▶ Disabled Disable this function.
- ▶▶ 201 Set Game Port Address to 201. (Default value)
- ▶▶ 209 Set Game Port Address to 209.

☞ **Midi Port Address** ^(Note)

- ▶▶ Disabled Disable this function. (Default value)
- ▶▶ 330 Set Midi Port Address to 330.
- ▶▶ 300 Set Midi Port Address to 300.

☞ **Midi Port IRQ**

- ▶▶ 10 Set Midi Port IRQ to 10. (Default value)
- ▶▶ 5 Set Midi Port IRQ to 5.

(Note) If you want to use a force feedback joystick, set **Midi Port Address** to **330** or **300**.

2-4 Power Management Setup

| CMOS Setup Utility-Copyright (C) 1984-2004 Award Software Power Management Setup | | |
|---|---------------|-------------|
| ACPI Suspend Type | [S1(POS)] | Item Help |
| AC BACK Function | [Soft-Off] | Menu Level▶ |
| Soft-Off by PWRBTN | [Instant-off] | |
| PME Event Wake Up | [Enabled] | |
| Modem Ring Resume | [Enabled] | |
| USB Dev WakeUp From S3 | [Disabled] | |
| Resume by Alarm | [Disabled] | |
| x Date (of Month) Alarm | Everyday | |
| x Time (hh:mm:ss) Alarm | 0 : 0 : 0 | |
| POWER ON Function | [Disabled] | |

↑↓←→: Move Enter: Select +/-/PU/PD: Value F10: Save ESC: Exit F1: General Help
 F5: Previous Values F6: Fail-Safe Defaults F7: Optimized Defaults

☞ ACPI Suspend Type

- ▶▶ S1(POS) Set ACPI suspend type to S1/POS(Power On Suspend). (Default value)
- ▶▶ S3(STR) Set ACPI suspend type to S3/STR(Suspend To RAM).

☞ AC BACK Function

- ▶▶ Soft-Off When AC-power back to the system, the system will be in "Off" state. (Default value)
- ▶▶ Full-On When AC-power back to the system, the system always in "On" state.
- ▶▶ Memory When AC-power back to the system, the system will return to the Last state before AC-power off.

☞ Soft-Off by PWRBTN

- ▶▶ Instant-off Press power button then Power off instantly. (Default value)
- ▶▶ Delay 4 Sec. Press power button 4 seconds to Power off. Enter suspend if button is pressed less than 4 seconds.

☞ PME Event Wake Up

This feature requires an ATX power supply that provides at least 1A on the 5VSB lead.

- ▶▶ Disabled Disable this function.
- ▶▶ Enabled Enable PME as wake up event. (Default value)

☞ Modem Ring Resume

An incoming call via modem can awake the system from any suspend state.

- ▶▶ Disabled Disable Modem Ring Resume function.
- ▶▶ Enabled Enable Modem Ring Resume function. (Default value)

☞ USB Dev WakeUp From S3

You can enable this function when **ACPI Suspend Type** set to **S3(STR)**.

- ▶▶ Disabled Disable this function. (Default value)
- ▶▶ Enabled Enable USB device can wakeup system from S3.

☞ Resume by Alarm

You can set "Resume by Alarm" item to enabled and key in Date/Time to power on system.

- ▶▶ Disabled Disable this function. (Default value)
- ▶▶ Enabled Enable alarm function to POWER ON system.

If RTC Alarm Lead To Power On is Enabled.

- ▶▶ Date (of Month) Alarm : Everyday, 1~31
- ▶▶ Time (hh: mm: ss) Alarm : (0~23) : (0~59) : (0~59)

☞ POWER ON Function

- ▶▶ Disabled Disable this function. (Default value)
- ▶▶ Any KEY Press any key to power on the system.
- ▶▶ Mouse Double click on mouse left button to power on the system.
- ▶▶ Mouse/Any KEY Press any key or double click on mouse left button to power on the system.

2-5 PnP/PCI Configurations

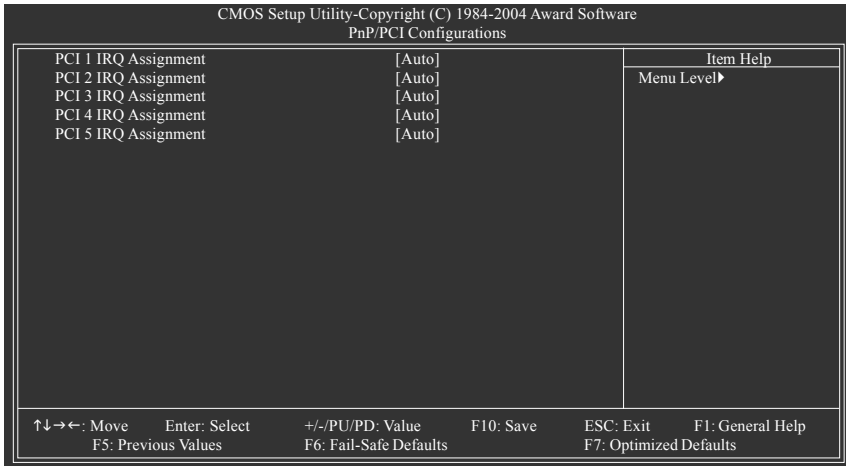

☞ PCI 1 IRQ Assignment

▶▶ Auto

Auto assign IRQ to PCI 1. (Default value)

▶▶ 3,4,5,7,9,10,11,12,14,15

Set IRQ 3,4,5,7,9,10,11,12,14,15 to PCI 1.

☞ PCI 2 IRQ Assignment

▶▶ Auto

Auto assign IRQ to PCI 2. (Default value)

▶▶ 3,4,5,7,9,10,11,12,14,15

Set IRQ 3,4,5,7,9,10,11,12,14,15 to PCI 2.

☞ PCI 3 IRQ Assignment

▶▶ Auto

Auto assign IRQ to PCI 3. (Default value)

▶▶ 3,4,5,7,9,10,11,12,14,15

Set IRQ 3,4,5,7,9,10,11,12,14,15 to PCI 3.

☞ PCI 4 IRQ Assignment

▶▶ Auto

Auto assign IRQ to PCI 4. (Default value)

▶▶ 3,4,5,7,9,10,11,12,14,15

Set IRQ 3,4,5,7,9,10,11,12,14,15 to PCI 4.

☞ PCI 5 IRQ Assignment

▶▶ Auto

Auto assign IRQ to PCI 5. (Default value)

▶▶ 3,4,5,7,9,10,11,12,14,15

Set IRQ 3,4,5,7,9,10,11,12,14,15 to PCI 5.

2-6 PC Health Status

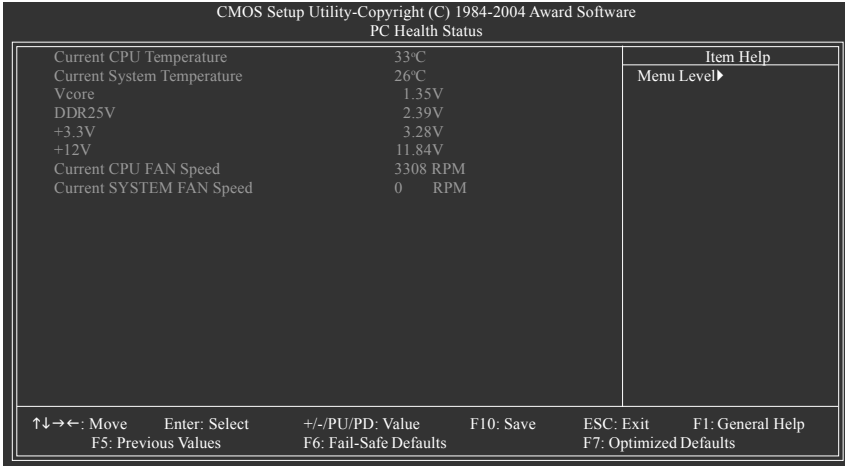

- ☞ **Current CPU/System Temperature**
 - ▶▶ Detect CPU/System temperature automatically.
- ☞ **Current Voltage(V) Vcore / DDR25V / +3.3V / +12V**
 - ▶▶ Detect system's voltage status automatically.
- ☞ **Current CPU/SYSTEM FAN Speed (RPM)**
 - ▶▶ Detect CPU/SYSTEM fan speed status automatically.

2-7 Frequency/Voltage Control

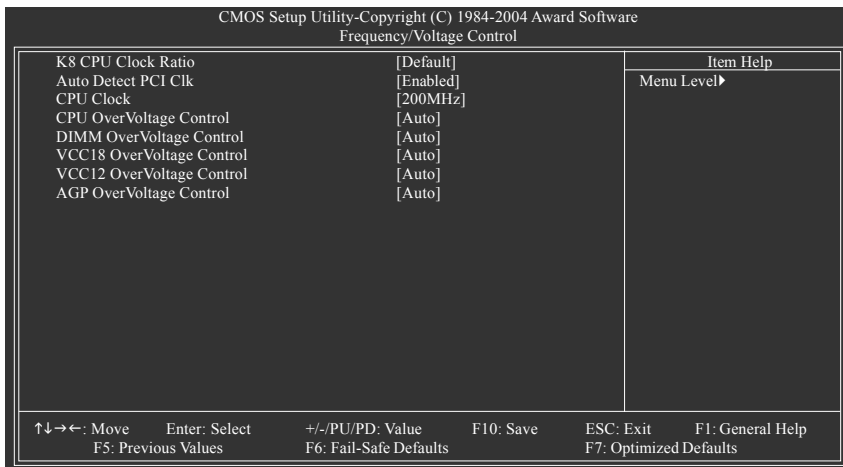

Incorrect using these features may cause your system broken. For power end-user use only.

- ☞ **K8 CPU Clock Ratio**
 - ▶▶ Default Set K8 CPU Clock Ratio to CPU factory default. (Default value)
 - ▶▶ x4 800Mhz ~ x10 2000Mhz. Set K8 CPU Clock Ratio from x4 800Mhz to x10 2000Mhz.
- ☞ **Auto Detect PCI Clk**
 - ▶▶ Enabled Detect PCI clock automatically. (Default value)
 - ▶▶ Disabled Disable this function.
- ☞ **CPU Clock**
 - ▶▶ 200 ~ 232MHz Set CPU clock from 200Mhz to 232Mhz.
- ☞ **CPU OverVoltage Control**
 - ▶▶ Auto Supply voltage as CPU required. (Default value)
 - ▶▶ +5%, +7.5%, +10% Increase voltage range as user selected.
- ☞ **DIMM OverVoltage Control**
 - ▶▶ Auto Supply voltage as DDR module required. (Default value)
 - ▶▶ +0.1V, +0.2V Increase voltage range as user selected.
- ☞ **VCC18 OverVoltage Control**
 - ▶▶ Auto Supply voltage as VCC18 required. (Default value)
 - ▶▶ +5%, +7.5%, +10% Increase voltage range as user selected.
- ☞ **VCC12 OverVoltage Control**
 - ▶▶ Auto Supply voltage as VCC12 required. (Default value)
 - ▶▶ +5%, +7.5%, +10% Increase voltage range as user selected.
- ☞ **AGP OverVoltage Control**
 - ▶▶ Auto Supply voltage as AGP required. (Default value)
 - ▶▶ +5%, +7.5%, +10% Increase voltage range as user selected.

2-8 Load Fail-Safe Defaults

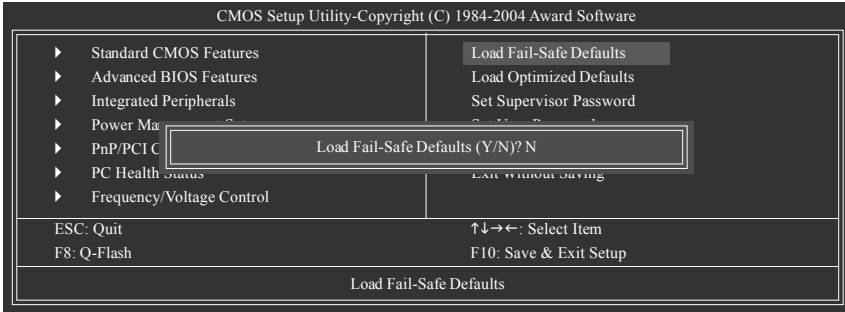

Fail-Safe defaults contain the most appropriate values of the system parameters that allow minimum system performance.

2-9 Load Optimized Defaults

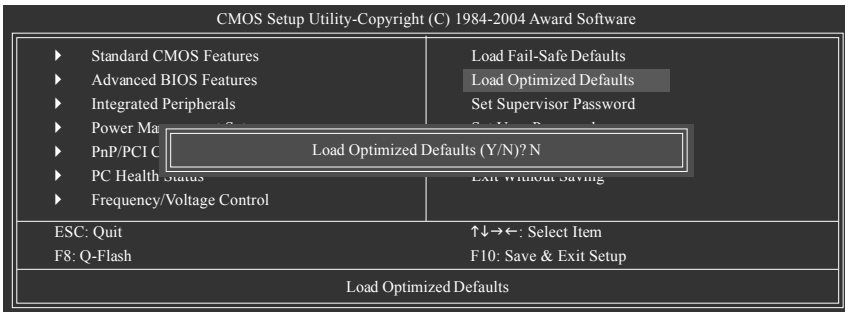

Selecting this field loads the factory defaults for BIOS and Chipset Features which the system automatically detects.

2-10 Set Supervisor/User Password

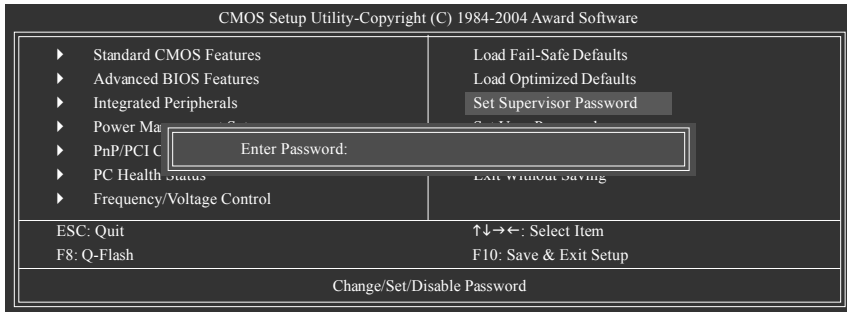

When you select this function, the following message will appear at the center of the screen to assist you in creating a password.

Type the password, up to eight characters, and press <Enter>. You will be asked to confirm the password. Type the password again and press <Enter>. You may also press <Esc> to abort the selection and not enter a password.

To disable password, just press <Enter> when you are prompted to enter password. A message "PASSWORD DISABLED" will appear to confirm the password being disabled. Once the password is disabled, the system will boot and you can enter Setup freely.

The BIOS Setup program allows you to specify two separate passwords:

SUPERVISOR PASSWORD and a USER PASSWORD. When disabled, anyone may access all BIOS Setup program function. When enabled, the Supervisor password is required for entering the BIOS Setup program and having full configuration fields, the User password is required to access only basic items.

If you select "System" at "Password Check" in Advance BIOS Features Menu, you will be prompted for the password every time the system is rebooted or any time you try to enter Setup Menu.

If you select "Setup" at "Password Check" in Advance BIOS Features Menu, you will be prompted only when you try to enter Setup.

2-11 Save & Exit Setup

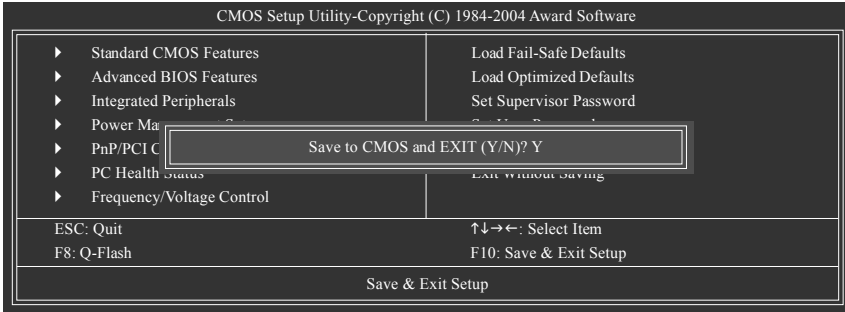

Type "Y" will quit the Setup Utility and save the user setup value to RTC CMOS.

Type "N" will return to Setup Utility.

2-12 Exit Without Saving

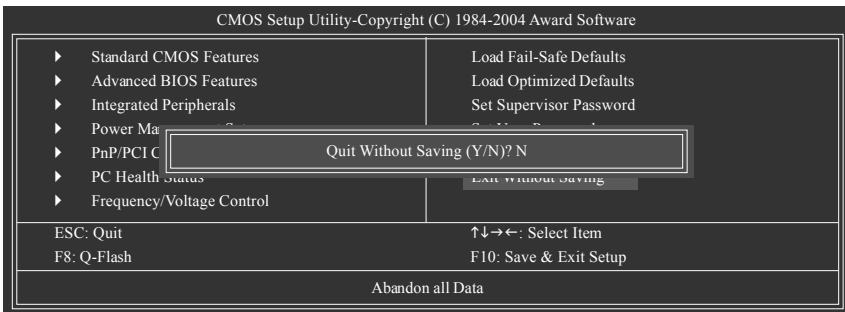

Type "Y" will quit the Setup Utility without saving to RTC CMOS.

Type "N" will return to Setup Utility.

Chapter 3 Drivers Installation



Pictures below are shown in Windows XP.

Insert the driver CD-title that came with your motherboard into your CD-ROM drive, the driver CD-title will auto start and show the installation guide. If not, please double click the CD-ROM device icon in "My computer", and execute the Setup.exe.

3-1 Install Chipset Drivers

After insert the driver CD, "Xpress Install" will scan automatically the system and then list all the drivers that recommended to install. The "Xpress Install" uses the "Click and Go" technology to install the drivers automatically. Just select the drivers you want then click the "GO" button. The "Xpress Install" will execute the installation for you automatically.

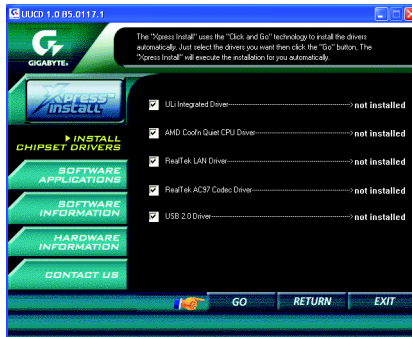

Some device drivers will restart your system automatically. After restarting your system the "Xpress Install" will continue to install other drivers.

System will reboot automatically after install the drivers, afterward you can install others application.



CAUTION

For USB2.0 driver support under Windows XP operating system, please use Windows Service Pack. After install Windows Service Pack, it will show a question mark "?" in "Universal Serial Bus controller" under "Device Manager". Please remove the question mark and restart the system (System will auto-detect the right USB2.0 driver).

3-2 Software Application

This page displays all the tools that Gigabyte developed and some free software, you can choose anyone you want and press "install" to install them.

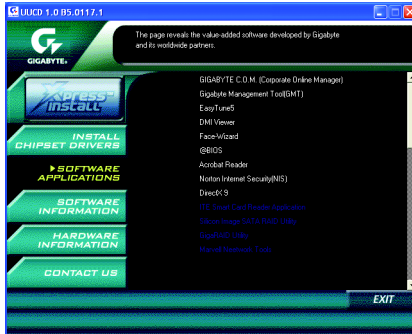

3-3 Software Information

This page lists the contents of software and drivers in this CD-title.

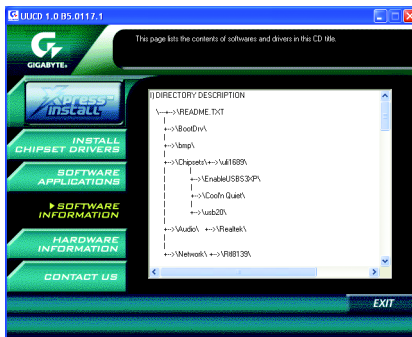

3-4 Hardware Information

This page lists all device you have for this motherboard.

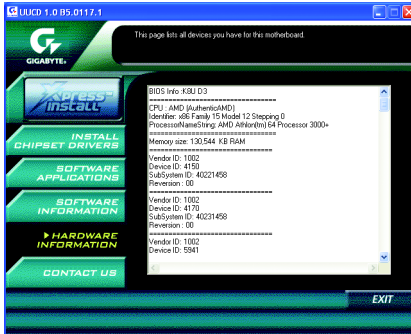

3-5 Contact Us

Please see the last page for details.



Chapter 4 Appendix

4-1 Unique Software Utilities

4-1-1 EasyTune 5 Introduction

EasyTune 5 presents the most convenient Windows based system performance enhancement and manageability utility. Featuring several powerful yet easy to use tools such as 1) Overclocking for enhancing system performance, 2) C.I.A. and M.I.B. for special enhancement for CPU and Memory, 3) Smart-Fan control for managing fan speed control of both CPU cooling fan and North-Bridge Chipset cooling fan, 4) PC health for monitoring system status. ^(Note)

User Interface Overview



| | Button / Display | Description |
|-----|-----------------------------------|---|
| 1. | Overclocking | Enters the Overclocking setting page |
| 2. | C.I.A./C.I.A.2 and M.I.B./M.I.B.2 | Enters the C.I.A./2 and M.I.B./2 setting page |
| 3. | Smart-Fan | Enters the Smart-Fan setting page |
| 4. | PC Health | Enters the PC Health setting page |
| 5. | GO | Confirmation and Execution button |
| 6. | "Easy Mode" & "Advance Mode" | Toggles between Easy and Advance Mode |
| 7. | Display screen | Display panel of CPU frequency |
| 8. | Function display LEDs | Shows the current functions status |
| 9. | GIGABYTE Logo | Log on to GIGABYTE website |
| 10. | Help button | Display EasyTune™ 5 Help file |
| 11. | Exit or Minimize button | Quit or Minimize EasyTune™ 5 software |

(Note) EasyTune 5 functions may vary depending on different motherboards.

4-1-2 Xpress Recovery Introduction



What is Xpress Recovery ?

Xpress Recovery is a utility used to back up and restore an OS partition. If the hard drive is not working properly, the user can restore the drive to its original state.



1. Supports FAT16, FAT32, and NTFS formats
2. Must be connected to the IDE1 Master
3. Allows installation of only one OS
4. Must be used with an IDE hard disk supporting HPA
5. The first partition must be set as the boot partition. When the boot partition is backed up, please do not alter its size.
6. Xpress Recovery is recommended when using Ghost to return boot manager to NTFS format.

How to use the Xpress Recovery

1. Boot from CD-ROM (BMP Mode)

Enter the BIOS menu, select "Advanced BIOS Feature" and set to boot from CD-ROM. Insert the provided driver CD into your CD drive, then save and exit the BIOS menu. Once the computer has restarted, the phrase "Boot from CD:" will appear at the bottom left-hand corner of the screen. When "Boot from CD:" appears, press any key to enter Xpress Recovery.

Once you have completed this step, subsequent access to Xpress Recovery can also function by pressing the F9 key during computer power on.



Boot from CD:

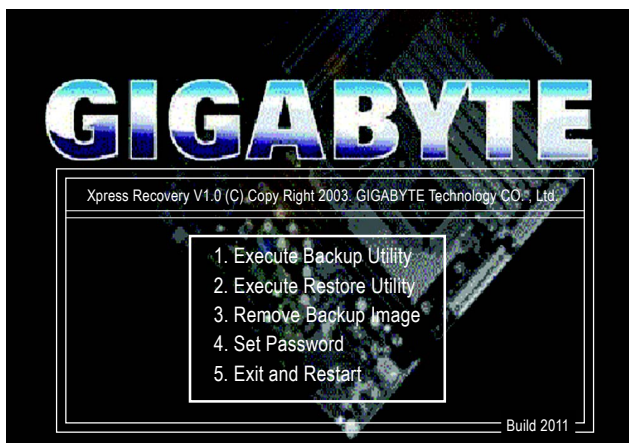

2. Press F9 during powering on the computer. (Text Mode)
Press F9 during powering on the computer .

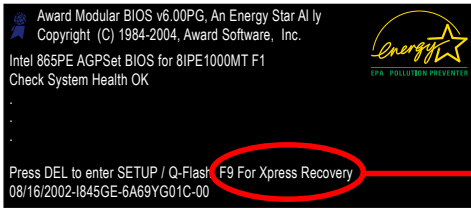

F9 For Xpress Recovery

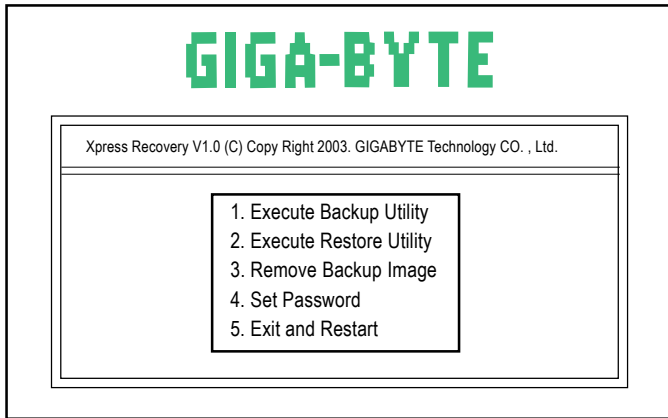

1. If you have already entered Xpress Recovery by booting from the CD-ROM, you can enter Xpress Recovery in the future by pressing the F9 key.
2. System storage capacity as well as drive reading/writing speed will affect backup speed.
3. It is recommended that Xpress Recovery be immediately installed after OS and all required driver and software installations are complete.

1. Execute Backup Utility:

Press B to Backup your System or Esc to Exit

The backup utility will automatically scan your system and back up data as a backup image in your hard drive.



Not all systems support access to Xpress Recovery by pressing the F9 key during computer power on. If this is the case, please use the boot from CD-ROM method to enter Xpress Recovery.

2. Execute Restore Utility:

This program will recover your system to factory default.

Press R to restore your system back to factory default or press Esc to exit

Restores backup image to original state.

3. Remove Backup Image:

Remove backup image. Are you sure? (Y/N)

Remove the backup image.

4. Set Password:

Please input a 4-16 character long password (a-z or 0-9) or press Esc to exit

You can set a password to enter Xpress Recovery to protect your hard disk data. Once this is done, password input will be required to enter Xpress Recovery during the next as well as subsequent system restarts. If you wish to remove the need for password entry, please select "Set Password" and under "New Password/Confirm Password", make sure there is no entry and then press "Enter" to remove password requirement.

5. Exit and Restart:

Exit and restart your computer.

4-1-3 Flash BIOS Method Introduction



Method 1 : Q-Flash™ Utility

Q-Flash™ is a BIOS flash utility embedded in Flash ROM. With this utility, users only have to stay in the BIOS menu when they want to update BIOS. Q-Flash™ allows users to flash BIOS without any utility in DOS or

Windows. Using Q-Flash™ indicating no more fooling around with any complicated instructions and operating system since it is in the BIOS menu.



Please note that because updating BIOS has potential risk, please do it with caution!! We are sorry that Gigabyte Technology Co., Ltd is not responsible for damages of system because of incorrect manipulation of updating BIOS to avoid any claims from end-users.

Before You Begin:

Before you start updating BIOS with the Q-Flash™ utility, please follow the steps below first.

1. Download the latest BIOS for your motherboard from Gigabyte's website.
2. Extract the BIOS file downloaded and save the BIOS file (the one with model name.Fxx. For example, 8KNXPJ.Fba) to a floppy disk.
3. Reboot your PC and press **Del** to enter BIOS menu.

The BIOS upgrading guides below are separated into two parts.

If your motherboard has dual-BIOS, please refer to **Part One**.

If your motherboard has single-BIOS, please refer to **Part Two**.

Part One:

Updating BIOS with Q-Flash™ Utility on Dual BIOS Motherboards.

Some of Gigabyte motherboards are equipped with dual BIOS. In the BIOS menu of the motherboards supporting Q-Flash and Dual BIOS, the Q-Flash utility and Dual BIOS utility are combined in the same screen. This section only deals with how to use Q-Flash utility.

In the following sections, we take GA-8KNXP Ultra as the example to guide you how to flash BIOS from an older version to the latest version. For example, from Fa3 to Fba.

The BIOS file is Fa3
before updating

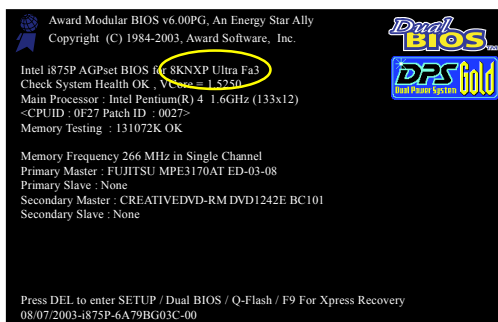

Entering the Q-Flash™ utility:

Step 1: To use Q-Flash utility, you must press **Del** in the boot screen to enter BIOS menu.

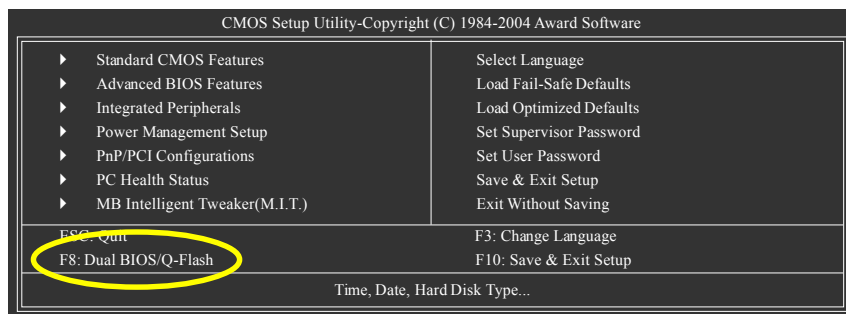

Step 2: Press **F8** button on your keyboard and then **Y** button to enter the Dual BIOS/Q-Flash utility.

Exploring the Q-Flash™ / Dual BIOS utility screen

The Q-Flash / Dual BIOS utility screen consists of the following key components.

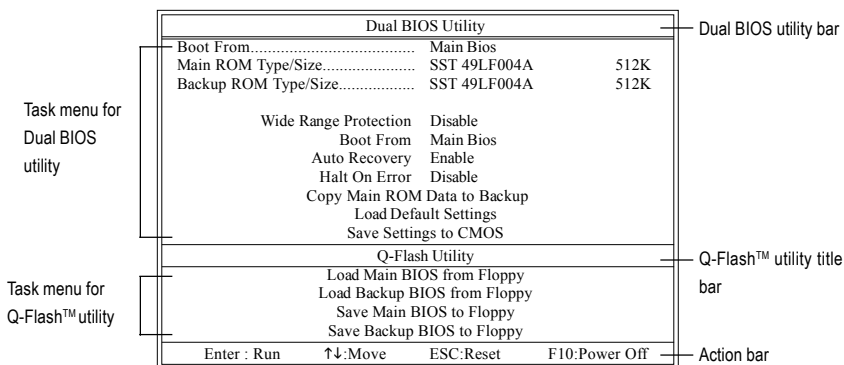

Task menu for Dual BIOS utility:

Contains the names of eight tasks and two item showing information about the BIOS ROM type. Blocking a task and pressing Enter key on your keyboard to enable execution of the task.

Task menu for Q-Flash utility:

Contains the names of four tasks. Blocking a task and pressing Enter key on your keyboard to enable execution of the task.

Action bar:

Contains the names of four actions needed to operate the Q-Flash/Dual BIOS utility. Pressing the buttons mentioned on your keyboards to perform these actions.

Using the Q-Flash™ utility:

This section tells you how to update BIOS using the Q-Flash utility. As described in the "Before you begin" section above, you must prepare a floppy disk having the BIOS file for your motherboard and insert it to your computer. If you have already put the floppy disk into your system and have entered the Q-Flash utility, please follow the steps below to flash BIOS.

Steps:

1. Press arrow buttons on your keyboard to move the light bar to "Load Main BIOS from Floppy" item in the Q-Flash menu and press Enter button.

Later, you will see a box pop up showing the BIOS files you previously downloaded to the floppy disk.



If you want to save the current BIOS for backup purpose, you can begin Step 1 with "Save Main BIOS to Floppy" item.

2. Move to the BIOS file you want to flash and press **Enter**.

In this example, we only download one BIOS file to the floppy disk so only one BIOS file, 8KNXPU.Fba, is listed.



Please confirm again you have the correct BIOS file for your motherboard.

| Dual BIOS Utility | | |
|--|----------------------|------|
| Boot From..... | Main Bios | |
| Main ROM Type/Size..... | SST 49LF004A | 512K |
| Backup ROM Type/Size..... | SST 49LF004A | 512K |
| Wide Range Protection Disable | | |
| 8KNXPU.Fba | 1 file(s) found 512K | |
| Total size : 1.39M | Free size : 911.50K | |
| F5 : Refresh | DEL : Delete | |
| Q-Flash Utility | | |
| Load Main BIOS from Floppy | | |
| Load Backup BIOS from Floppy | | |
| Save Main BIOS to Floppy | | |
| Save Backup BIOS to Floppy | | |
| Enter : Run ↑↓:Move ESC:Reset F10:Power Off | | |

BIOS file in the floppy disk.

After pressing **Enter**, you'll then see the progress of reading the BIOS file from the floppy disk.

| Dual BIOS Utility | | |
|--|--------------|------|
| Boot From..... | Main Bios | |
| Main ROM Type/Size..... | SST 49LF004A | 512K |
| Backup ROM Type/Size..... | SST 49LF004A | 512K |
| Wide Range Protection Disable | | |
| Reading BIOS file from floppy ... | | |
| >>>>>>>>>>..... | | |
| Don't Turn Off Power or Reset System | | |
| Q-Flash Utility | | |
| Load Main BIOS from Floppy | | |
| Load Backup BIOS from Floppy | | |
| Save Main BIOS to Floppy | | |
| Save Backup BIOS to Floppy | | |
| Enter : Run ↑↓:Move ESC:Reset F10:Power Off | | |



Do not trun off power or reset your system at this stage!!

After BIOS file is read, you'll see a confirmation dialog box asking you "Are you sure to update BIOS?"

3. Press Y button on your keyboard after you are sure to update BIOS.
Then it will begin to update BIOS. The progress of updating BIOS will be displayed.



Please do not take out the floppy disk when it begins flashing BIOS.

4. Press any keys to return to the Q-Flash menu when the BIOS updating procedure is completed.

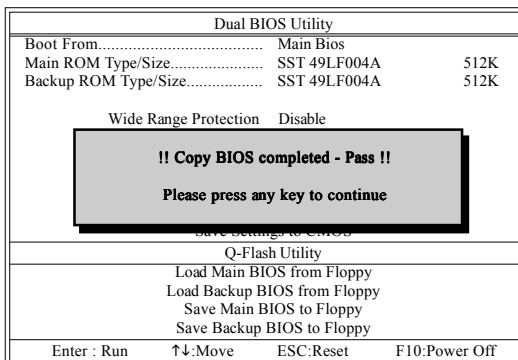

You can repeat Step 1 to 4 to flash the backup BIOS, too.

5. Press Esc and then Y button to exit the Q-Flash utility. The computer will restart automatically after you exit Q-Flash.

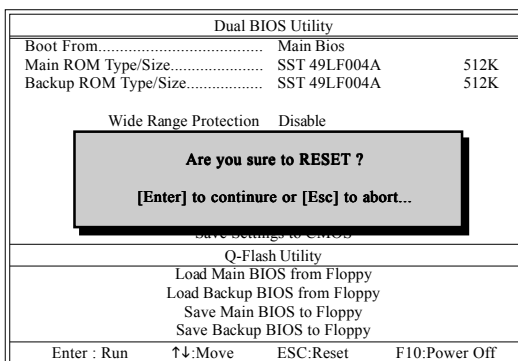

After system reboots, you may find the BIOS version on your boot screen becomes the one you flashed.

The BIOS file becomes Fba after updating.

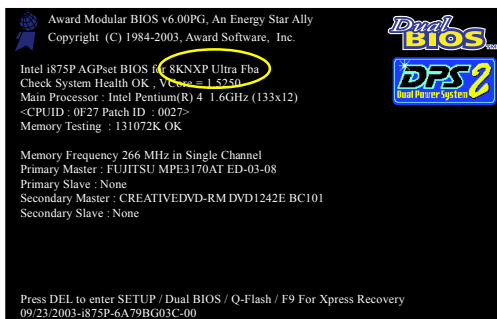

6. Press **Del** to enter BIOS menu after system reboots. When you are in BIOS menu, move to **Load Fail-Safe Defaults** item and press **Enter** to load BIOS Fail-Safe Defaults. Normally the system redetects all devices after BIOS has been upgraded. Therefore, we highly recommend reloading the BIOS defaults after BIOS has been upgraded.

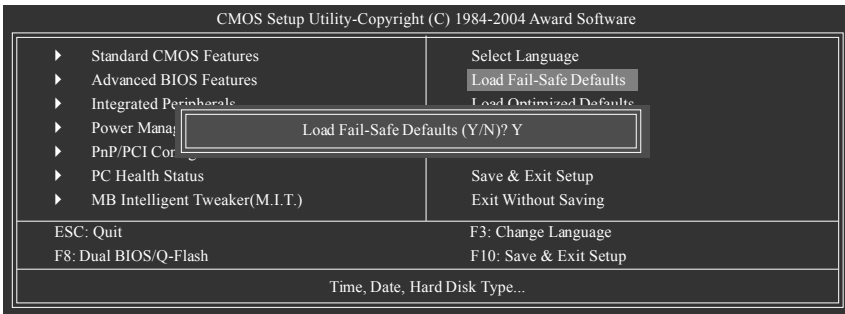

Press **Y** on your keyboard to load defaults.

7. Select **Save & Exit Setup** item to save the settings to CMOS and exit the BIOS menu. System will reboot after you exit the BIOS menu. The procedure is completed.

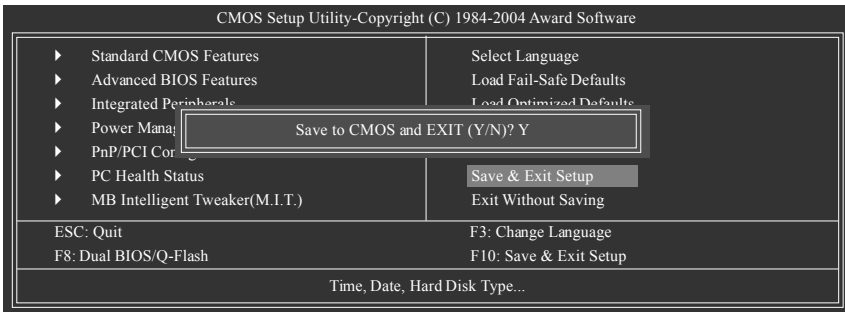

Press **Y** on your keyboard to save and exit.

Part Two:

Updating BIOS with Q-Flash™ Utility on Single-BIOS Motherboards.

This part guides users of single-BIOS motherboards how to update BIOS using the Q-Flash™ utility.

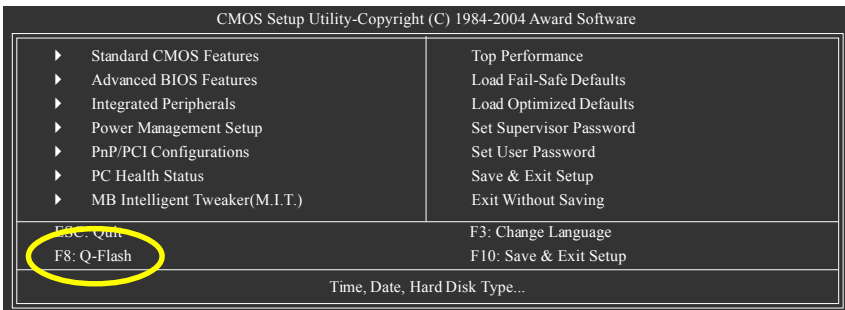

Exploring the Q-Flash™ utility screen

The Q-FlashBIOS utility screen consists of the following key components.

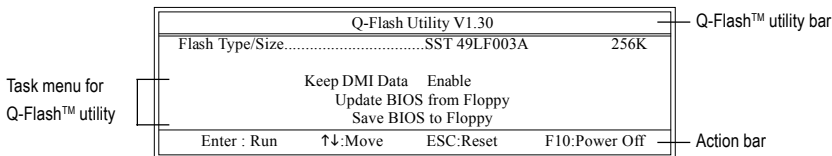

Task menu for Q-Flash utility:

Contains the names of three tasks. Blocking a task and pressing Enter key on your keyboard to enable execution of the task.

Action bar:

Contains the names of four actions needed to operate the Q-Flash utility. Pressing the buttons mentioned on your keyboards to perform these actions.

Using the Q-Flash™ utility:

This section tells you how to update BIOS using the Q-Flash utility. As described in the "Before you begin" section above, you must prepare a floppy disk having the BIOS file for your motherboard and insert it to your computer. If you have already put the floppy disk into your system and have entered the Q-Flash utility, please follow the steps below to flash BIOS.

Steps:

1. Press arrow buttons on your keyboard to move the light bar to "Update BIOS from Floppy" item in the Q-Flash menu and press Enter button.
Later, you will see a box pop up showing the BIOS files you previously downloaded to the floppy disk.



If you want to save the current BIOS for backup purpose, you can begin Step 1 with "Save BIOS to Floppy" item.

2. Move to the BIOS file you want to flash and press Enter.

In this example, we only download one BIOS file to the floppy disk so only one BIOS file, 8GE800.F4, is listed.



Please confirm again you have the correct BIOS file for your motherboard.

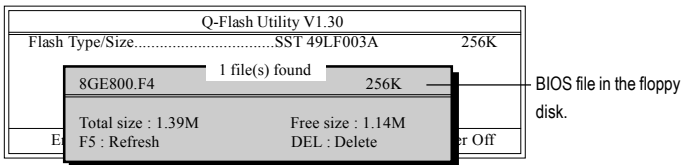

Do not turn off power or reset your system at this stage!!

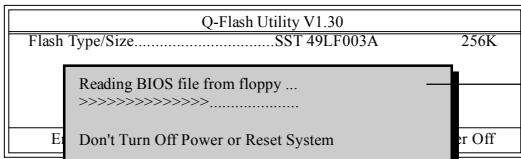

After BIOS file is read, you'll see a confirmation dialog box asking you "Are you sure to update BIOS?"



Please do not take out the floppy disk when it begins flashing BIOS.

- Press Y button on your keyboard after you are sure to update BIOS.
Then it will begin to update BIOS. The progress of updating BIOS will be shown at the same time.

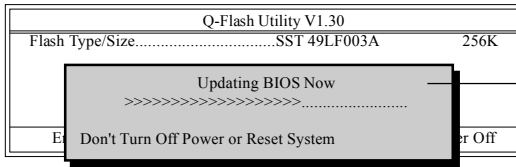

Do not turn off power or reset your system at this stage!!

- Press any keys to return to the Q-Flash menu when the BIOS updating procedure is completed.

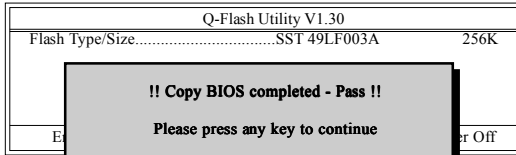

- Press Esc and then Y button to exit the Q-Flash utility. The computer will restart automatically after you exit Q-Flash.

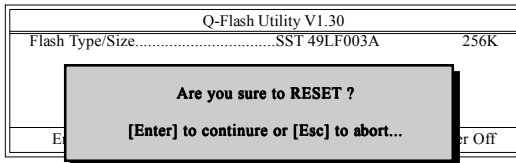

After system reboots, you may find the BIOS version on your boot screen becomes the one you flashed.

The BIOS file becomes F4 after updating

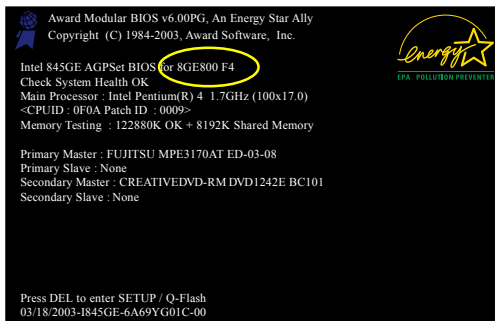

- Press Del to enter BIOS menu after system reboots and "Load BIOS Fail-Safe Defaults". See how to Load BIOS Fail-Safe Defaults, please kindly refer to Step 6 to 7 in **Part One**.

Congratulation!! You have updated BIOS successfully!!



Method 2 : @BIOS™ Utility

If you do not have a DOS startup disk, we recommend that you use the new @BIOS utility. @BIOS allows users to update their BIOS under Windows. Just select the desired @BIOS server to download the latest version of BIOS.

Fig 1. Installing the @BIOS utility

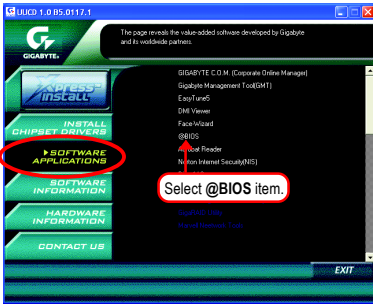

Fig 2. Installation complete and run @BIOS

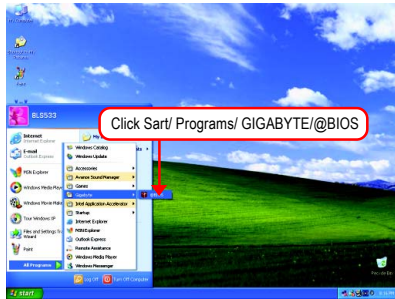

Fig 3. The @BIOS utility

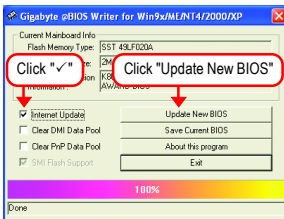

Fig 4. Select the desired @BIOS server



1. Methods and steps:

I. Update BIOS through Internet:

- a. Click "Internet Update" icon.
- b. Click "Update New BIOS" icon.
- c. Select @BIOS™ sever.
- d. Select the exact model name on your motherboard.
- e. System will automatically download and update the BIOS.

II. Update BIOS NOT through Internet:

- a. Do not click "Internet Update" icon.
- b. Click "Update New BIOS".
- c. Please select "All Files" in dialog box while opening the old file.
- d. Please search for BIOS unzip file, downloading from internet or any other methods (such as: K8U.D3).
- e. Complete update process following the instruction.

III. Save BIOS:

In the very beginning, there is "Save Current BIOS" icon shown in dialog box. It means to save the current BIOS version.

IV. Check out supported motherboard and Flash ROM:

In the very beginning, there is "About this program" icon shown in dialog box. It can help you check out which kind of motherboard and which brand of Flash ROM are supported.

2. Note:

- I. In method I, if it shows two or more motherboard's model names to be selected, please make sure your motherboard's model name again. Selecting wrong model name will cause the system unbooted.
- II. In method II, be sure that motherboard's model name in BIOS unzip file are the same as your motherboard's. Otherwise, your system won't boot.
- III. In method I, if the BIOS file you need cannot be found in @BIOS™ server, please go onto Gigabyte's website for downloading and updating it according to method II.
- IV. Please note that any interruption during updating will cause system unbooted.

4-1-4 Serial ATA BIOS Setting Utility Introduction

RAID Levels

RAID (Redundant Array of Independent Disks) is a method of combining two hard disk drives into one logical unit. The advantage of an Array is to provide better performance or data fault tolerance. Fault tolerance is achieved through data redundant operation, where if one drives fails, a mirrored copy of the data can be found on another drive. This can prevent data loss if the operating system fails or hangs. The individual disk drives in an array are called members. The configuration information of each member is recorded in the reserved sector that identifies the drive as a member. All disk members in a formed disk array are recognized as a single physical drive to the operating system.

Hard disk drives can be combined together through a few different methods. The different methods are referred to as different RAID levels. Different RAID levels represent different performance levels, security levels and implementation costs. The RAID levels which the ULI M1689 chipset supports are RAID 0, RAID 1, and JBOD.

RAID 0 (Striping)

RAID 0 reads and writes sectors of data interleaved between multiple drives. If any disk member fails, it affects the entire array. The disk array data capacity is equal to the number of drive members times the capacity of the smallest member. The striping block size can be set from 4KB to 64KB. RAID 0 does not support fault tolerance.

RAID 1 (Mirroring)

RAID 1 writes duplicate data onto a pair of drives and reads both sets of data in parallel. If one of the mirrored drives suffers a mechanical failure or does not respond, the remaining drive will continue to function. Due to redundancy, the drive capacity of the array is the capacity of the smallest drive. Under a RAID 1 setup, an extra drive called the spare drive can be attached. Such a drive will be activated to replace a failed drive that is part of a mirrored array. Due to the fault tolerance, if any RAID 1 drive fails, data access will not be affected as long as there are other working drives in the array.

JBOD (Spanning)

A spanning disk array is equal to the sum of the all drives when the drives used are having different capacities. Spanning stores data onto a drive until it is full, then proceeds to store files onto the next drive in the array. When any disk member fails, the failure affects the entire array. JBOD is not really a RAID and does not support fault tolerance.

Please follow the steps below to construct a complete RAID array:

- 1) Have ready your hard drives for RAID construction.
Note: To achieve best performance, it is recommended that the hard drives used are of similar make and storage capacity.
- 2) Please attach the hard drive connectors to their appropriate location on the motherboard ie. IDE, SCSI, or SATA.
- 3) Enter the motherboard BIOS and locate RAID setup (Please refer to the section on Integrated Peripherals).
- 4) Enter RAID setup in the BIOS and select the RAID type (For instance, enter Ctrl + A to select ULi RAID; Ctrl + S to select Silicon Image).
- 5) Complete driver installation.
- 6) Complete RAID utility installation.

More information on steps 4 and 5 is provided. (For more detailed setup information, please visit our website at <http://www.gigabyte.com.tw> to read or download the information you need.)

Configuring the ULi RAID BIOS

The ULi RAID BIOS setup utility lets you choose the RAID array type and which hard drives you want to make part of the array.

Entering the RAID BIOS Setup

1. After rebooting your computer, wait until you see the RAID software prompting you to press **Ctrl + A**. The RAID prompt appears as part of the system POST and boot process prior to loading the OS. You have a few seconds to press **Ctrl + A** before the window disappears.

```
ALi RAID BIOS V1.04 (M5289)
(c) ALi Corporation 2004, All Rights Reserved.
Identifying IDE drives .o.o.

Channel 1 Master : ST3120026AS      SATA 1   120034 MB
Channel 2 Master : ST3120026AS      SATA 1   120034 MB

Press Ctrl-A to enter ALi RAID BIOS setup utility ...
```

Press **Ctrl + A**.

The ULi RAID BIOS Setup Utility window appears (as Figure below).

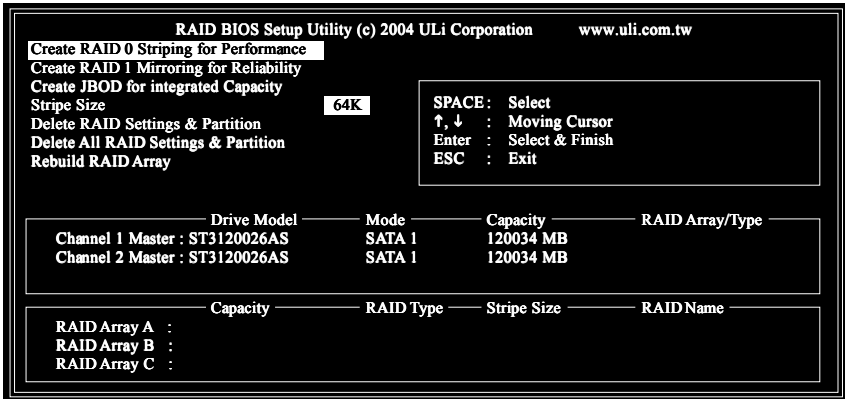

There are three major areas in the RAID BIOS setup screen: **Main Menu**, **Drive Select Menu** and **RAID Array List**. (as Figure below)

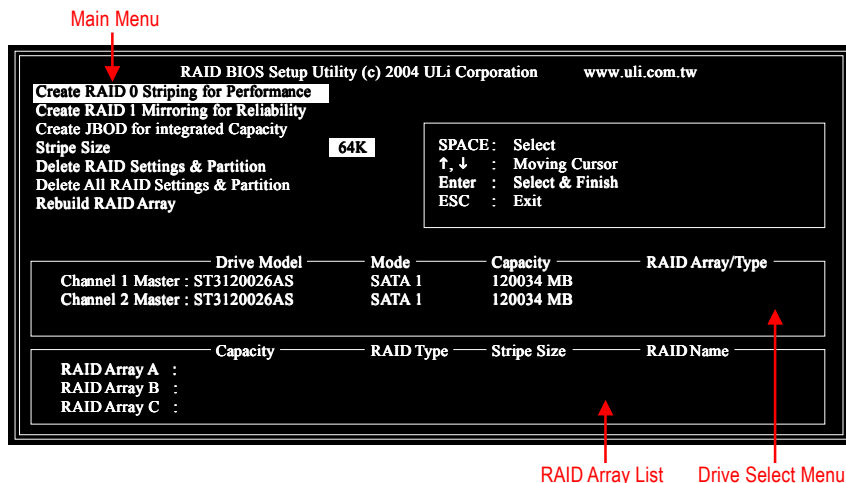

1. Create RAID 0 Striping for Performance

Press **Enter** on **Create RAID 0 Striping for Performance** item. An "S" flash cursor appears at the Drive Select Menu for the user to choose the first drive for RAID 0. Use Space key to select the desired drive for RAID 0. Then the flash cursor changes to an "s" flash cursor for the user to choose the second drive for RAID 0. (as Figure below)

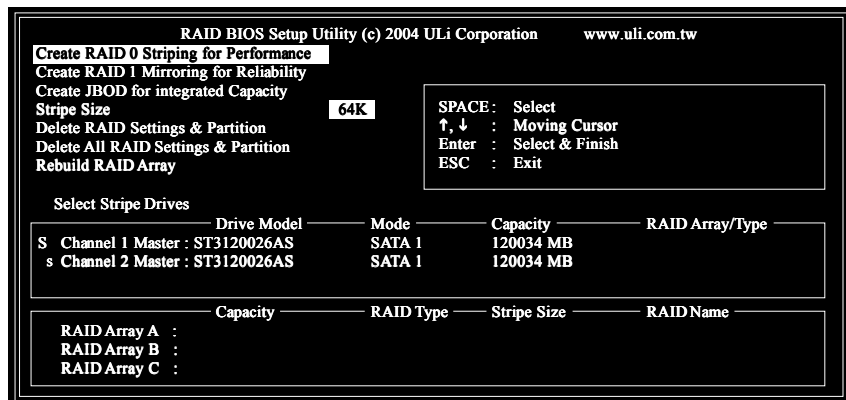

Press Space key to select the second drive. The prompt "Data on RAID Drives will be deleted (Y/N)?" appears after two drives are properly assigned. Press Y, and then some necessary information will be written to the drives, which will destroy the original data in the drives.



Make sure the data in drives is no longer in use before creating RAID 0.

Next, the Array Name input line appears for the user to key in a name for the newly created array. The effective characters for an array name is 0-9, A-Z, a-z, space and underscore.

| RAID BIOS Setup Utility (c) 2004 ULi Corporation | | www.uli.com.tw | |
|---|-----------|----------------|-----------------|
| Create RAID 0 Striping for Performance Create RAID 1 Mirroring for Reliability Create JBOD for integrated Capacity Stripe Size 64K Delete RAID Settings & Partition Delete All RAID Settings & Partition Rebuild RAID Array | | | |
| Input RAID Name (8 characters) : ALI_RAID | | | |
| Drive Model | Mode | Capacity | RAID Array/Type |
| S Channel 1 Master : ST3120026AS | SATA 1 | 120034 MB | |
| s Channel 2 Master : ST3120026AS | SATA 1 | 120034 MB | |
| Capacity | RAID Type | Stripe Size | RAID Name |
| RAID Array A : | | | |
| RAID Array B : | | | |
| RAID Array C : | | | |

After the RAID array has been created successfully, its information shows up at RAID Array List.

| RAID BIOS Setup Utility (c) 2004 ULi Corporation | | www.uli.com.tw | |
|---|-----------|----------------|-----------------|
| Create RAID 0 Striping for Performance Create RAID 1 Mirroring for Reliability Create JBOD for integrated Capacity Stripe Size 64K Delete RAID Settings & Partition Delete All RAID Settings & Partition Rebuild RAID Array | | | |
| Input RAID Name (8 characters) : ALI_RAID | | | |
| Drive Model | Mode | Capacity | RAID Array/Type |
| Channel 1 Master : ST3120026AS | SATA 1 | 120034 MB | |
| Channel 2 Master : ST3120026AS | SATA 1 | 120034 MB | |
| Capacity | RAID Type | Stripe Size | RAID Name |
| RAID Array A : 240 GB | 0 | 64K | ALI_RAID |
| RAID Array B : | | | |
| RAID Array C : | | | |



NOTE

Before create the RAID Array, you can select the Stripe Size first. The Stripe Size is effective for RAID 0. The user can choose a stripe size from 64KByte, 32KByte, 16KByte(default), 8KByte and 4KByte. If the user uses RAID 0 for most A/V editing application or files, 64KByte is recommended.

2. Create RAID 1 Mirroring for Reliability

Press **Enter** on **Create RAID 1 Mirroring for Reliability** item. An "M" flash cursor appears at the Drive Select Menu for the user to choose the first(source) drive for RAID 1. Use Space key to select the desired drive for RAID 1. Then the flash cursor changes to an "m" flash cursor for the user to choose the second (target) drive for RAID 1. (as Figure below)

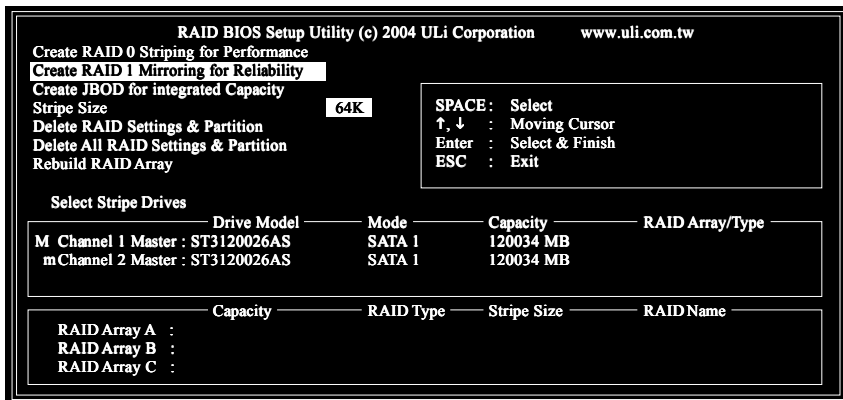

Press Space key to select the second drive. The prompt "**Create RAID 1 (Y/N)?**" appears after two drives are properly assigned. Press Y, and then some necessary information will be written to the drives, which will destroy the original data in the drives.



It is recommended to use new drives to create RAID 1. If existing drive is to be used, backup all necessary data before creating RAID 1.

Next, the Array Name input line appears for the user to key in a name for the newly created array. The effective characters for an array name is 0-9, A-Z, a-z, space and underscore.

Lastly a prompt message "**Duplicate Data from M to m (Y/N)?**" asks whether to do drive copy. The source and target drives are indicated by "M" and "m" in Drive Select Menu respectively. Pressing Y will duplicate the data in source drive to the target drive. Make sure the source drive is the correct one. If you press N, then the data is inconsistent in two drives.

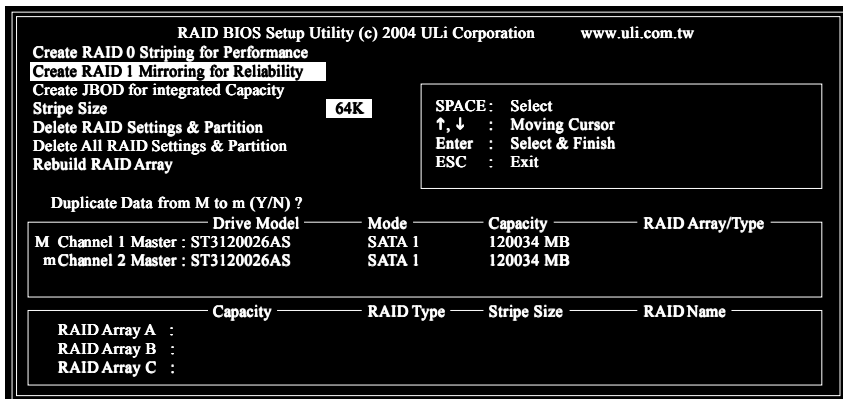

After the RAID array has been created successfully, its information shows up at RAID Array List.

```

RAID BIOS Setup Utility (c) 2004 ULI Corporation      www.uli.com.tw
Create RAID 0 Striping for Performance
Create RAID 1 Mirroring for Reliability
Create JBOD for integrated Capacity
Stripe Size                64K
Delete RAID Settings & Partition
Delete All RAID Settings & Partition
Rebuild RAID Array

SPACE : Select
↑, ↓  : Moving Cursor
Enter : Select & Finish
ESC   : Exit

----- Drive Model ----- Mode ----- Capacity ----- RAID Array/Type -----
Channel 1 Master : ST3120026AS   SATA 1   120034 MB
Channel 2 Master : ST3120026AS   SATA 1   120034 MB

----- Capacity ----- RAID Type ----- Stripe Size ----- RAID Name -----
RAID Array A : 120034 MB           1                64K                ALI_RAID
RAID Array B :
RAID Array C :

```

3. Create JBOD for integrated Capacity

Press **Enter** on **Create JBOD for integrated Capacity** item. A "J" flash cursor appears at the Drive Select Menu for the user to choose the first drive for JBOD. Use Space key to select the desired drive for JBOD. Press **Enter** to finish JBOD drive selection. The maximum number of drives for JBOD array is four and the minimum is two.

```

RAID BIOS Setup Utility (c) 2004 ULI Corporation      www.uli.com.tw
Create RAID 0 Striping for Performance
Create RAID 1 Mirroring for Reliability
Create JBOD for integrated Capacity
Stripe Size                64K
Delete RAID Settings & Partition
Delete All RAID Settings & Partition
Rebuild RAID Array

SPACE : Select
↑, ↓  : Moving Cursor
Enter : Select & Finish
ESC   : Exit

Select JBOD Drives

----- Drive Model ----- Mode ----- Capacity ----- RAID Array/Type -----
J Channel 1 Master : ST3120026AS   SATA 1   120034 MB
J Channel 2 Master : ST3120026AS   SATA 1   120034 MB

----- Capacity ----- RAID Type ----- Stripe Size ----- RAID Name -----
RAID Array A :
RAID Array B :
RAID Array C :

```

The prompt "Data on RAID Drives will be deleted (Y/N)?" appears after two drives are properly assigned. Press **Y**, and then some necessary information will be written to the drives, which will destroy the original data in the drives. Next, the Array Name input line appears for the user to key in a name for the newly created array. The effective characters for an array name is 0-9, A-Z, a-z, space and underscore. After the RAID array has been created successfully, its information shows up at RAID Array List.



Make sure the data in drives is no longer in use before creating JBOD.

4. Delete RAID Settings & Partition

When RAID BIOS detects a broken RAID, the user can use **Delete RAID Setting & Partition** to delete the broken RAID.

Press **Enter** on **Delete RAID Settings & Partition** item. An "E" flash cursor appears at the Drive Select Menu for the user to choose the defined drive to be deleted. "**Data on RAID drives will be deleted (Y/N)?**" message will appear to confirm the user's selection. Press **Y** and then the data in drives is destroyed. RAID Array List automatically updates itself.

5. Delete All RAID Settings & Partition

Press **Enter** on **Delete All RAID Settings & Partition** item. "**Data on RAID drives will be deleted (Y/N)?**" message will appear to confirm the user's selection. Press **Y** and then the data in drives is destroyed. RAID Array List automatically updates itself.

6. Rebuild RAID Array

When a drive is replaced or BIOS detects a broken RAID, the user can use **Rebuild RAID Array** to keep data coherency for RAID 1.

Press **Enter** on **Rebuild RAID Array** item. An "R" flash cursor appears at the Drive Select Menu for the user to choose the valid drive of previously defined RAID 1 to rebuild. BIOS shows the source (marked with "M") and target (marked with "m") drives.

Lastly a prompt message "**Duplicate Data from M to m (Y/N)?**" asks whether to do drive copy. The source and target drives are indicated by "M" and "m" in Drive Select Menu respectively. Press **Y** to start the rebuild process and data duplication. The process status bar shows up during the duplication process.

Installing the RAID drivers

To install Windows 2000/XP onto a Serial ATA hard disk successfully, you need to install required driver for the SATA controller on your motherboard during OS installation. Without the driver, the hard disk may not be recognized during the Windows setup process.

First of all, you have to copy the driver for the SATA controller on your motherboard from the motherboard driver CD to a floppy disk. See the instructions below about how to copy the driver.

Step 1: Find an available Operation System and insert the motherboard driver CD into the CD-ROM drive. The installation utility will appear automatically soon after you insert the driver CD. Quit the installation utility first. Insert a blank formatted floppy disk into the floppy disk drive.

Step 2: Go to My Computer and right-click the CD-ROM icon (This procedure assumes Drive D) and select Open. Then you will see folders and files contained in the driver CD. Double-click the BootDrv folder icon and select **MENU.exe** (refer to Fig.1).

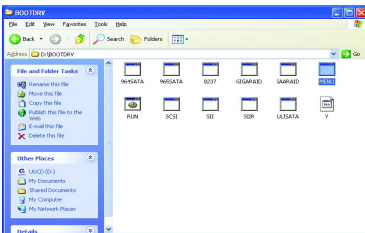

Fig.1

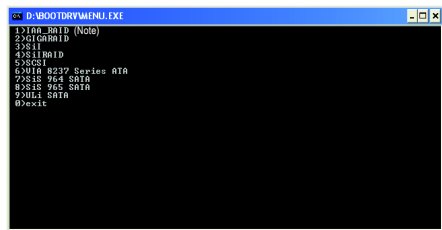

Fig.2

Step 3:

A MS-DOS prompt screen will appear. Information on all chipsets should be listed on the screen (Refer to Fig.2), please select the proper chipset model.

Your system will then automatically zip and transfer this driver file to the floppy disk.

After you complete the steps, boot from the Windows CD to install the RAID drivers.

When install Windows 2000 or Windows XP from HDDs in serial ATA controller, press **F6** as Win2000 or XP boots up, then supply serial ATA controller driver by this floppy disk. Follow on-screen instructions to complete installation.

(Each time you add a new hard drive to a RAID array, the RAID driver will have to be installed under Windows once for that hard drive. After that, the driver will not have to be installed.)

(Note) In the menu list, IAA_RAID is Intel ICH5R chipset.



4-1-5 2- / 4- / 6- / 8- Channel Audio Function Introduction

The installation of audio software is very simple. Follow the steps to install the function. (Following pictures are in Windows XP). Please note that if you want to set up an 8 channel audio configuration, you must use Audio Combo Kit (optional device).

Stereo Speakers Connection and Settings:

We recommend that you use the speaker with amplifier to acquire the best sound effect if the stereo output is applied.

STEP 1:

Connect the stereo speakers or earphone to "Line Out".

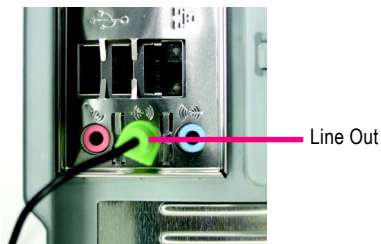

STEP 2:

Following installation of the audio driver, you'll find a Sound Effect icon on the lower right hand taskbar. Click the icon to select the function.

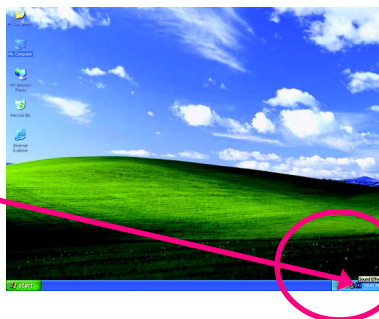

STEP 3:

Click "Speaker Configuration" then click on the left selection bar and select "2CH Speaker" to complete 2 channel audio configuration.

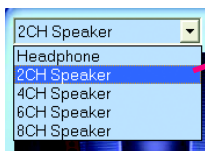

4 Channel Audio Setup

STEP 1:

Connect the Front Speakers to "Line Out", the Rear Speakers to "Line In".

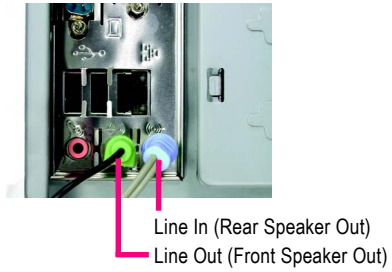

STEP 2:

Following installation of the audio driver, you'll find a Sound Effect  icon on the lower right hand taskbar. Click the icon to select the function.

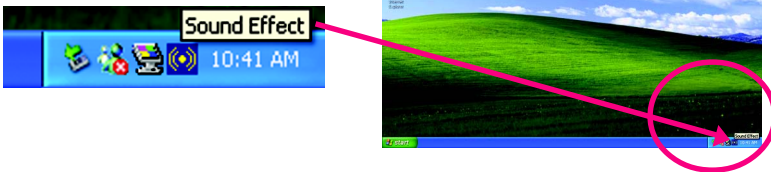

STEP 3:

Click "Speaker Configuration" and select the "UAJ Function". Then click on the left selection bar and select "4CH Speaker" to complete 4 channel audio configuration.

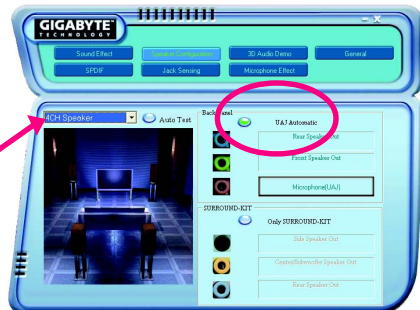
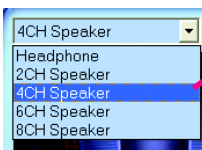

6 Channel Audio Setup

STEP 1:

Connect the Front Speakers to "Line Out", the Rear Speakers to "Line In", and the Center/Subwoofer Speakers to "MIC In".



Line In (Rear Speaker Out)

Line Out (Front Speaker Out)

Mic In (Center/Subwoofer Speaker Out)

STEP 2:

Following installation of the audio driver, you'll find a

Sound Effect  icon on the lower right hand taskbar.

Click the icon to select the function.



STEP 3:

Click "Speaker Configuration" and select the "UAJ Function". Then click on the left selection bar and select "6CH Speaker" to complete 6 channel audio configuration.

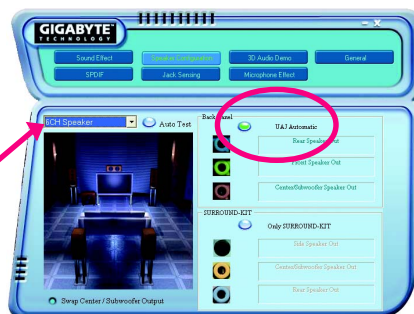

8 Channel Audio Setup (requires Audio Combo Kit, optional device) :

Audio Combo Kit includes a Surround-Kit and a SPDIF output cable (an optical and coaxial cable). If you want to set up an 8 channel configuration, you need to use the Surround-Kit. The Surround-Kit offers R/L surround, center/subwoofer output and rear surround.



STEP 1:

Secure the Audio Combo Kit at the panel on the back of the case.



STEP 2:

Connect the Surround-Kit to the SUR_CEN connector located on the motherboard.

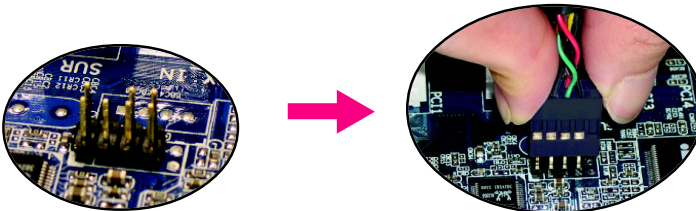

STEP 3:

There are two methods of 8 channel audio configuration:

Method 1:

Connect the front channels to the "Line Out" port located on the audio panel and the rear channels to the Surround-Kit "REAR R/L" port. Connect the center/subwoofer channels to the Surround-Kit "SUB CENTER" and the R/L channels to the Surround-Kit "SUR BACK" port.

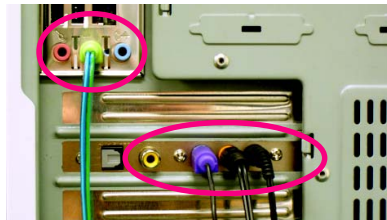

Method 2:

Connect the front channels to the "Line Out" port located on the audio panel and the rear channels to the "Line In" port. Connect the center/subwoofer channels to the "MIC In" port located on the audio panel and the R/L channels to the Surround-Kit "SUR BACK" port. (This method requires UAJ function)

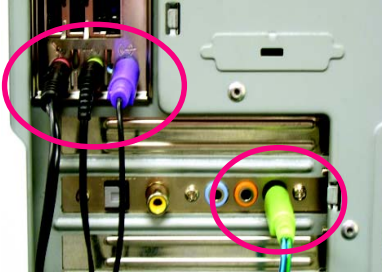

STEP 4:

Following installation of the audio driver, you'll find a Sound Effect icon on the lower right hand taskbar. Click the icon to select the function.

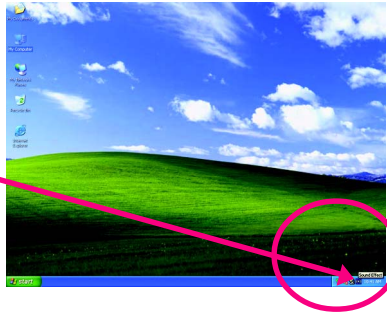

STEP 5:

Click "Speaker Configuration" and select both the "UAJ Function" and "Only Surround-Kit". Then click on the left selection bar and select "8CH Speaker" to complete 8 channel audio configuration.

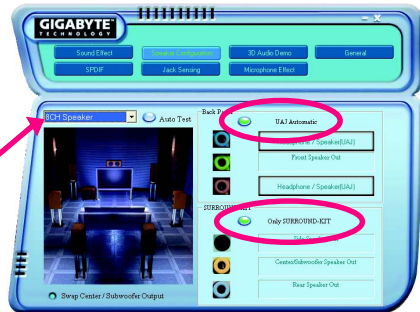

Sound Effect Configuration:

At the sound effect menu, users can adjust sound option settings as desired.

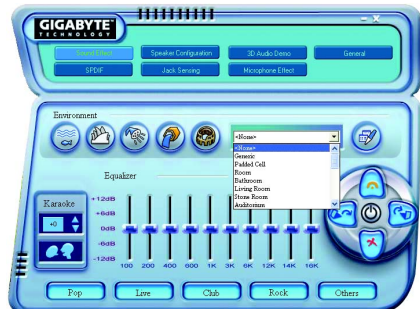

SPDIF Output Device (Optional Device)

A "SPDIF output" connector is available on the motherboard. Cable with rear bracket could link to the "SPDIF output" connector (As picture.) For the further linkage to decoder, rear bracket provides coaxial cable and Fiber connecting port ^(Note).



1. Connect the SPDIF output device to the rear bracket of PC, and fix it with screw.



2. Connect SPDIF device to the motherboard.

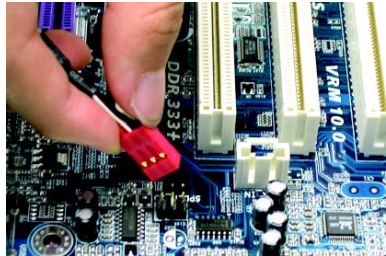

3. Connect SPDIF to the SPDIF decoder.



(Note) If you want to use both of the 8 channel audio function and SPDIF out function, you may buy the Audio Combo Kit (refer to the 8 channel Audio Setup section).

Jack-Sensing and UAJ Introduction

Jack-Sensing provides audio connectors error-detection function.



Install Microsoft DirectX8.1 or later version before to enable Jack-Sensing support for Windows 98/ 98SE/ 2000/ ME.

Jack-Sensing includes 2 parts: AUTO and MANUAL. Following is an example for 2 channels (Following pictures are in Windows XP):

Introduction of audio connectors

You may connect CDROM, Walkman or others audio input devices to Line In jack, speakers, earphone or others output devices to Line Out jack, and microphone to MIC In jack.

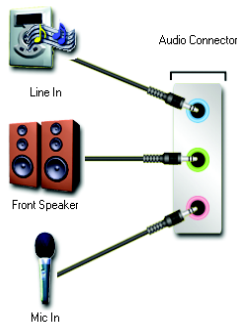

Auto-detecting:

Please connect the devices to the right jacks as above. A window will appear as right picture if you setup the devices properly.

Please note that 3D audio function will only appear when 3D audio inputs.



If you set wrong with the connectors, the warning message will come out as right picture.

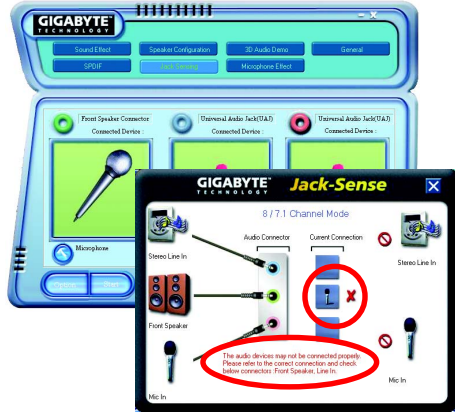

Manual setting:

If the device picture shows different from what you set, please press "Manual Selection" to set.

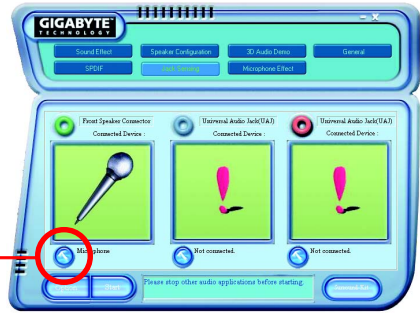
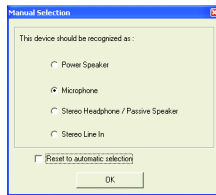

UAJ Introduction

UAJ (Universal Audio Jack) has a very smart feature: It will switch signal automatically when user plugs his audio device to the wrong jack (Line-in/ Line-out). That means users do not need to worry the audio device should be plug in Line-in or Line-out jack, the device will work perfectly after UAJ is activated.

Enable UAJ function:

You can click "UAJ Automatic" button to enable UAJ function.

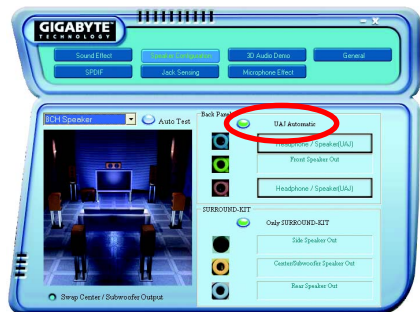

4-2 Troubleshooting

Below is a collection of general asked questions. To check general asked questions based on a specific motherboard model, please log on to <http://www.gigabyte.com.tw>

Question 1: I cannot see some options that were included in previous BIOS after updating BIOS. Why?

Answer: Some advanced options are hidden in new BIOS version. Please press Ctrl and F1 keys after entering BIOS menu and you will be able to see these options.

Questions 2: Why is the light of my keyboard/optical mouse still on after computer shuts down?

Answer: In some boards, a small amount of electricity is kept on standby after computer shuts down and that's why the light is still on.

Question 3: How do I clear CMOS?

Answer: If your board has a Clear CMOS jumper, please refer to the Clear CMOS steps in the manual. If your board doesn't have such jumper, you can take off the on-board battery to leak voltage to clear CMOS. Please refer to the steps below:

Steps:

1. Turn off power.
2. Disconnect the power cord from MB.
3. Take out the battery gently and put it aside for about 10 minutes (Or you can use a metal object to connect the positive and negative pins in the battery holder to makethem short for one minute).
4. Re-insert the battery to the battery holder.
5. Connect power cord to MB again and turn on power.
6. Press Del to enter BIOS and load Fail-Safe Defaults.
7. Save changes and reboot the system.

Question 4: Why does system seem unstable after updating BIOS?

Answer: Please remember to load Fail-Safe Defaults (Or Load BIOS Defaults) after flashing BIOS. However, if the system instability still remains, please clear CMOS to solve the problem.

Question 5: Why do I still get a weak sound after turning up the speaker to the maximum volume?

Answer: Please make sure the speaker you are using is equipped with an internal amplifier. If not, please change another speaker with power/amplifier and try again later.

Question 6: How do I disable onboard VGA card in order to add an external VGA card?

Answer: Gigabyte motherboards will auto-detect the external VGA card after it is plugged in, so you don't need to change any setting manually to disable the onboard VGA.

Question 7: Why cannot I use the IDE 2?

Answer: Please refer to the user manual and check whether you have connected any cable that is not provided with the motherboard package to the USB Over Current pin in the Front USB Panel. If the cable is your own cable, please remove it from this pin and do not connect any of your own cables to it.

Question 8: Sometimes I hear different continuous beeps from computer after system boots up. What do these beeps usually stand for?

Answer: The beep codes below may help you identify the possible computer problems. However, they are only for reference purposes. The situations might differ from case to case.

→ AMI BIOS Beep Codes

*Computer gives 1 short beep when system boots successfully.

*Except for beep code 8, these codes are always fatal.

1 beep: Refresh failure

2 beeps: Parity error

3 beeps: Base 64K memory failure

4 beeps: Timer not operational

5 beeps: Processor error

6 beeps: 8042 - gate A20 failure

7 beeps: Processor exception interrupt error

8 beeps: Display memory read/write failure

9 beeps: ROM checksum error

10 beeps: CMOS shutdown register read/write error

11 beeps: Cache memory bad

→ AWARD BIOS Beep Codes

1 short: System boots successfully

2 short: CMOS setting error

1 long 1 short: DRAM or M/B error

1 long 2 short: Monitor or display card error

1 long 3 short: Keyboard error

1 long 9 short: BIOS ROM error

Continuous long beeps: DRAM error

Continuous short beeps: Power error



Contact Us

● Taiwan (Headquarters)

GIGA-BYTE TECHNOLOGY CO., LTD.

Address: No.6, Bau Chiang Road, Hsin-Tien, Taipei Hsien, Taiwan.

TEL: +886 (2) 8912-4888

FAX: +886 (2) 8912-4003

Tech. Support :

<http://tw.giga-byte.com/TechSupport/ServiceCenter.htm>

Non-Tech. Support(Sales/Marketing) :

<http://ggts.gigabyte.com.tw/nontech.asp>

WEB address (English): <http://www.gigabyte.com.tw>

WEB address (Chinese): <http://chinese.giga-byte.com>

● U.S.A.

G.B.T. INC.

Address: 17358 Railroad St, City of Industry, CA 91748.

TEL: +1 (626) 854-9338

FAX: +1 (626) 854-9339

Tech. Support :

<http://www.giga-byte.com/TechSupport/ServiceCenter.htm>

Non-Tech. Support(Sales/Marketing) :

<http://ggts.gigabyte.com.tw/nontech.asp>

WEB address : <http://www.giga-byte.com>

● Germany

G.B.T. TECHNOLOGY TRADING GMBH

Address: Friedrich-Ebert-Damm 112 22047 Hamburg Deutschland

TEL: +49-40-2533040 (Sales)

+49-1803-428468 (Tech.)

FAX: +49-40-25492343 (Sales)

+49-1803-428329 (Tech.)

Tech. Support :

<http://de.giga-byte.com/TechSupport/ServiceCenter.htm>

Non-Tech. Support(Sales/Marketing) :

<http://ggts.gigabyte.com.tw/nontech.asp>

WEB address : <http://www.gigabyte.de>

● Japan

NIPPON GIGA-BYTE CORPORATION

WEB address : <http://www.gigabyte.co.jp>

● Singapore

GIGA-BYTE SINGAPORE PTE. LTD.

Tech. Support :

<http://tw.giga-byte.com/TechSupport/ServiceCenter.htm>

Non-Tech. Support(Sales/Marketing) :

<http://ggts.gigabyte.com.tw/nontech.asp>

● U.K.

G.B.T. TECH. CO., LTD.

Address: GUnit 13 Avant Business Centre 3 Third Avenue, Denbigh West Bleckley Milton Keynes, MK1 1DR, UK, England

TEL: +44-1908-362700

FAX: +44-1908-362709

Tech. Support :

<http://uk.giga-byte.com/TechSupport/ServiceCenter.htm>

Non-Tech. Support(Sales/Marketing) :

<http://ggts.gigabyte.com.tw/nontech.asp>

WEB address : <http://uk.giga-byte.com>

● The Netherlands

GIGA-BYTE TECHNOLOGY B.V.

TEL: +31 40 290 2088

NL Tech.Support: 0900-GIGABYTE (0900-44422983)

BE Tech.Support: 0900-84034

FAX: +31 40 290 2089

Tech. Support :

<http://nz.giga-byte.com/TechSupport/ServiceCenter.htm>

Non-Tech. Support(Sales/Marketing) :

<http://ggts.gigabyte.com.tw/nontech.asp>

WEB address : <http://www.giga-byte.nl>

- **China**

NINGBO G.B.T. TECH. TRADING CO., LTD.

Tech. Support :

<http://cn.giga-byte.com/TechSupport/ServiceCenter.htm>

Non-Tech. Support(Sales/Marketing) :

<http://ggts.gigabyte.com.tw/nontech.asp>

WEB address : <http://www.gigabyte.com.cn>

Shanghai

TEL: +86-021-63410999

FAX: +86-021-63410100

Beijing

TEL: +86-010-82886651

FAX: +86-010-82888013

Wuhan

TEL: +86-027-87851061

FAX: +86-027-87851330

GuangZhou

TEL: +86-020-87586074

FAX: +86-020-85517843

Chengdu

TEL: +86-028-85236930

FAX: +86-028-85256822

Xian

TEL: +86-029-85531943

FAX: +86-029-85539821

Shenyang

TEL: +86-024-23960918

FAX: +86-024-23960918-809

- **Australia**

GIGABYTE TECHNOLOGY PTY. LTD.

Tech. Support :

<http://www.giga-byte.com.au/TechSupport/ServiceCenter.htm>

Non-Tech. Support(Sales/Marketing) :

<http://ggts.gigabyte.com.tw/nontech.asp>

WEB address : <http://www.giga-byte.com.au>

- **France**

GIGABYTE TECHNOLOGY FRANCES S.A.R.L.

Tech. Support :

<http://tw.giga-byte.com/TechSupport/ServiceCenter.htm>

Non-Tech. Support(Sales/Marketing) :

<http://ggts.gigabyte.com.tw/nontech.asp>

WEB address : <http://www.gigabyte.fr>

- **Russia**

Moscow Representative Office Of Giga-Byte Technology Co., Ltd.

Tech. Support :

<http://tw.giga-byte.com/TechSupport/ServiceCenter.htm>

Non-Tech. Support(Sales/Marketing) :

<http://ggts.gigabyte.com.tw/nontech.asp>

WEB address : <http://www.gigabyte.ru>

- **Poland**

Representative Office Of Giga-Byte Technology Co., Ltd.
POLAND

Tech. Support :

<http://tw.giga-byte.com/TechSupport/ServiceCenter.htm>

Non-Tech. Support(Sales/Marketing) :

<http://ggts.gigabyte.com.tw/nontech.asp>

WEB address : <http://www.gigabyte.pl>
