

# GA-K8NS Pro

AMD Socket 754 Processor Motherboard

## User's Manual

Rev. 1002

12ME-K8NSP-1002

### **Copyright**

© 2005 GIGABYTE TECHNOLOGY CO., LTD

Copyright by **GIGA-BYTE TECHNOLOGY CO., LTD. ("GBT")**. No part of this manual may be reproduced or transmitted in any form without the expressed, written permission of **GBT**.

### **Trademarks**

Third-party brands and names are the property of their respective owners.

### **Notice**

Please do not remove any labels on motherboard, this may void the warranty of this motherboard.

Due to rapid change in technology, some of the specifications might be out of date before publication of this booklet.

The author assumes no responsibility for any errors or omissions that may appear in this document nor does the author make a commitment to update the information contained herein.

# Declaration of Conformity

We, Manufacturer/Importer  
(full address)

**G.B.T. Technology Trading GmbH**  
**Ausschlagler Weg 41, 1F 20537 Hamburg, Germany**

declare that the product  
(description of the apparatus, system, installation to which it refers)

## **Mother Board**

GA-K8NS Pro

is in conformity with

(reference to the specification under which conformity is declared)  
in accordance with 89/336 EEC-EMC Directive

- |   |  |   |   |
|---|--|---|---|
| <input type="checkbox"/> <b>EN 55011</b>            | Limits and methods of measurement of radio disturbance characteristics of industrial, scientific and medical (ISM) high frequency equipment                | <input checked="" type="checkbox"/> <b>EN 61000-3-2</b> | Disturbances in supply systems caused   |
| <input type="checkbox"/> <b>EN 55013</b>            | Limits and methods of measurement of radio disturbance characteristics of broadcast receivers and associated equipment                                     | <input checked="" type="checkbox"/> <b>EN 61000-3-3</b> | Disturbances in supply systems caused by household appliances and similar electrical equipment "Voltage fluctuations" |
| <input type="checkbox"/> <b>EN 55014-1</b>          | Limits and methods of measurement of radio disturbance characteristics of household electrical appliances, portable tools and similar electrical apparatus | <input type="checkbox"/> <b>EN 55024</b>                | Information Technology equipment-Immunity characteristics-Limits and methods of measurement                           |
| <input type="checkbox"/> <b>EN 55015</b>            | Limits and methods of measurement of radio disturbance characteristics of fluorescent lamps and luminaries   | <input type="checkbox"/> <b>EN 50082-1</b>              | Generic immunity standard Part 1: Residual, commercial and light industry   |
| <input type="checkbox"/> <b>EN 55020</b>            | Immunity from radio interference of broadcast receivers and associated equipment   | <input type="checkbox"/> <b>EN 50082-2</b>              | Generic immunity standard Part 2: Industrial environment  |
| <input checked="" type="checkbox"/> <b>EN 55022</b> | Limits and methods of measurement of radio disturbance characteristics of information technology equipment   | <input type="checkbox"/> <b>EN 55014-2</b>              | Immunity requirements for household appliances tools and similar apparatus  |
| <input type="checkbox"/> <b>DIN VDE 0855</b>        | Cabled distribution systems; Equipment for receiving and/or distribution from sound and television signals   | <input type="checkbox"/> <b>EN 50091-2</b>              | EMC requirements for uninterruptible power systems (UPS)  |
| <input type="checkbox"/> <b>part 10</b>             |  |   |   |
| <input type="checkbox"/> <b>part 12</b>             |  |   |   |

**CE marking**



(EC conformity marking)

**The manufacturer also declares the conformity of above mentioned product with the actual required safety standards in accordance with LVD 73/23 EEC**

- |  |   |  |   |
|--|---|--|---|
| <input type="checkbox"/> <b>EN 60065</b> | Safety requirements for mains operated electronic and related apparatus for household and similar general use | <input type="checkbox"/> <b>EN 60950</b>   | Safety for information technology equipment including electrical business equipment |
| <input type="checkbox"/> <b>EN 60335</b> | Safety of household and similar electrical appliances   | <input type="checkbox"/> <b>EN 50091-1</b> | General and Safety requirements for uninterruptible power systems (UPS)             |

**Manufacturer/Importer**

Signature : Timmy Huang

(Stamp)

Date : Apr. 2, 2004

Name : Timmy Huang

# DECLARATION OF CONFORMITY

Per FCC Part 2 Section 2.1077(a)



**Responsible Party Name: G.B.T. INC. (U.S.A.)**

**Address: 17358 Railroad Street  
City of Industry, CA 91748**

**Phone/Fax No: (818) 854-9338/ (818) 854-9339**

hereby declares that the product

**Product Name: Motherboard**

**Model Number: GA-K8NS Pro**

Conforms to the following specifications:

FCC Part 15, Subpart B, Section 15.107(a) and Section 15.109  
(a), Class B Digital Device

## **Supplementary Information:**

This device complies with part 15 of the FCC Rules. Operation is subject to the following two conditions: (1) This device may not cause harmful and (2) this device must accept any interference received, including that may cause undesired operation.

Representative Person's Name: ERIC LU

Signature: *Eric Lu*

Date: Apr. 2, 2004



## Read Me First!

When you installing AGP card, please make sure the following notice is fully understood and practiced. If your AGP card has "AGP 4X/8X (1.5V) notch" (show below), please make sure your AGP card is AGP 4X/8X.



**Caution: AGP 2X card is not supported by nVIDIA® nForce3™ 250. You might experience system unable to boot up normally. Please insert an AGP 4X/8X card.**

**WARNING:** *Never run the processor without the heatsink properly and firmly attached. PERMANENT DAMAGE WILL RESULT!*

**Mise en garde :** *Ne faites jamais tourner le processeur sans que le dissipateur de chaleur soit fixé correctement et fermement. UN DOMMAGE PERMANENT EN RÉSULTERA !*

**Achtung:** *Der Prozessor darf nur in Betrieb genommen werden, wenn der W rmeableiter ordnungsgem ß und fest angebracht ist. DIES HAT EINEN PERMANENTEN SCHADEN ZUR FOLGE!*

**Advertencia:** *Nunca haga funcionar el procesador sin el disipador de calor instalado correcta y firmemente. ¡SE PRODUCIRÁ UN DAÑO PERMANENTE!*

**Aviso:** *Nunca execute o processador sem o dissipador de calor estar adequado e firmemente conectado. O RESULTADO SERÁ UM DANO PERMANENTE!*

**警告:** 將散熱板牢固地安裝到處理器上之前，不要運行處理器。過熱將永遠損壞處理器!

**警告:** 將散熱器牢固地安裝到處理器上之前，不要運行處理器。過熱將永遠損壞處理器!

**경고:** 히트싱크를 제대로 또 단단히 부착시키지 않은 채 프로세서를 구동시키지 마십시오. 영구적 고장이 발생합니다!

**警告:** 永久的な損傷を防ぐため、ヒートシンクを正しくしっかりと取り付けるまでは、プロセッサを動作させないようにしてください。

## Prepare your computer...

Computer motherboards and expansion cards contain very delicate Integrated Circuit (IC) chips. To protect them against damage from static electricity, you should follow some precautions whenever you work on your computer.

1. Unplug your computer when working on the inside.
2. Use a grounded wrist strap before handling computer components. If you do not have one, touch both of your hands to a safely grounded object or to a metal object, such as the power supply case.
3. Hold components by the edges and try not touch the IC chips, leads or connectors, or other components.
4. Place components on a grounded antistatic pad or on the bag that came with the components whenever the components are separated from the system.
5. Ensure that the ATX power supply is switched off before you plug in or remove the ATX power connector on the motherboard.

## Installing the motherboard to the chassis...

If the motherboard has mounting holes, but they don't line up with the holes on the base and there are no slots to attach the spacers, do not become alarmed you can still attach the spacers to the mounting holes. Just cut the bottom portion of the spacers (the spacer may be a little hard to cut off, so be careful of your hands). In this way you can still attach the motherboard to the base without worrying about short circuits. Sometimes you may need to use the plastic springs to isolate the screw from the motherboard PCB surface, because the circuit wire may be near by the hole. Be careful, don't let the screw contact any printed circuit write or parts on the PCB that are near the fixing hole, otherwise it may damage the board or cause board malfunctioning.

# Table of Content

Read Me First! .....	4
Chapter 1 Introduction .....	8
Features Summary .....	8
GA-K8NS Pro Motherboard Layout .....	10
Block Diagram .....	11
Chapter 2 Hardware Installation Process .....	13
Step 1: Install the Central Processing Unit (CPU) .....	14
Step 2: Install Memory Modules .....	16
Step 3: Install Expansion Cards .....	17
Step 4: Install I/O Peripherals Cables .....	18
Step 4-1: I/O Back Panel Introduction .....	18
Step 4-2: Connectors Introduction .....	20
Chapter 3 BIOS Setup .....	35
The Main Menu (For example: BIOS Ver. : E11) .....	36
Standard CMOS Features .....	38
Advanced BIOS Features .....	40
Integrated Peripherals .....	42
Power Management Setup .....	45
PnP/PCI Configurations .....	47
PC Health Status .....	48
Frequency/Voltage Control .....	49
Top Performance .....	50

Load Fail-Safe Defaults .....	50
Load Optimized Defaults .....	51
Set Supervisor/User Password .....	51
Exit Without Saving .....	52
Save & Exit Setup .....	52
Chapter 4 Technical Reference .....	55
@BIOS™ Introduction .....	55
Flash BIOS Method Introduction .....	56
2- / 4- / 6- / 8- Channel Audio Function Introduction .....	63
Jack-Sensing and UAJ Introduction .....	69
Xpress Recovery Introduction .....	71
Serial ATA BIOS Setting Utility Introduction .....	74
Chapter 5 Appendix .....	81

# Chapter 1 Introduction

## Features Summary

CPU	<ul style="list-style-type: none"> <li>• Socket 754 for AMD Althlon™ 64 processor (K8)</li> <li>• 1600MHz system bus</li> <li>• Supports core frequencies in excess of 1.6GHz(2800+) and faster</li> </ul>
Chipset	<ul style="list-style-type: none"> <li>• nVIDIA® nForce3™ 250</li> </ul>
Memory	<ul style="list-style-type: none"> <li>• 3 184-pin DDR DIMM sockets, support up to 3GB DRAM (Max.)</li> <li>• Supports DDR400/333/266 DIMM</li> </ul>
Slots	<ul style="list-style-type: none"> <li>• 1 AGP slot supports 8X/4X(1.5V) mode</li> <li>• 5 PCI slots</li> </ul>
On-Board IDE	<ul style="list-style-type: none"> <li>• 2 IDE controllers provide IDE HDD/CD-ROM (IDE1, IDE2) with PIO, Bus Master(DMA33/ATA66/ATA100/ATA133) operation modes</li> <li>• IDE3 and IDE4 compatible with RAID, Ultra ATA133/100, Built-in GigaRAID IT8212</li> </ul>
On-Board Floppy	<ul style="list-style-type: none"> <li>• 1 Floppy port supports 2 FDD with 360K, 720K, 1.2M, 1.44M and 2.88M bytes</li> </ul>
On-Board SATA	<ul style="list-style-type: none"> <li>• 4 Serial ATA connectors</li> <li>• 2 SATA connectors controlled by nVIDIA® nForce3™ 250 (SATA0_SB, SATA1_SB) ;</li> <li>• 2 SATA connectors controlled by Sil3512(SATA0_SII, SATA1_SII)</li> </ul>
On-Board Peripherals	<ul style="list-style-type: none"> <li>• 1 Parallel port supports Normal/EPP/ECP mode</li> <li>• 2 Serial ports (COMA &amp; COMB)</li> <li>• 8 x USB 2.0/1.1 ports (4 x rear, 4 x front by cable)</li> <li>• 3 x IEEE1394 ports (by cable)</li> <li>• 1 Front audio connector</li> <li>• 1 IrDA connector for IR/CIR</li> <li>• 1 PS/2 keyboard</li> <li>• 1 PS/2 mouse</li> </ul>
On-Board LAN	<ul style="list-style-type: none"> <li>• Built-in Marvell 8001 (10/100/1000 Mbit)</li> <li>• 1 RJ45 port</li> </ul>
On-Board Sound	<ul style="list-style-type: none"> <li>• ALC850 CODEC (UAJ)</li> <li>• Supports Jack Sensing function</li> <li>• Supports 2-/4-/6-/8-channel</li> <li>• Line Out / Line In / Mic In</li> <li>• Surround Back Speaker (by optional Surround-Kit)</li> <li>• SPDIF In / Out</li> <li>• CD In / Game connector</li> </ul>

to be continued...



On-Board SATA RAID (SATA0_SB, SATA1_SB)	<ul style="list-style-type: none"> <li>• Built-in nVIDIA® nForce3™ 250</li> <li>• Supports disk striping (RAID 0) or disk mirroring (RAID 1)</li> <li>• Supports JBOD function</li> <li>• Supports up to 150MB/s data transfer rate</li> <li>• Supports hot plug function</li> <li>• Up to 2 SATA devices</li> </ul>
On-Board SATA RAID (SATA0_SII, SATA1_SII)	<ul style="list-style-type: none"> <li>• Built-in Silicon Image SiI3512</li> <li>• Supports disk striping (RAID 0) or disk mirroring (RAID 1)</li> <li>• Supports up to 150MB/s data transfer rate</li> <li>• Supports hot plug function</li> <li>• Up to 2 SATA devices</li> </ul>
On-Board IDE RAID (IDE3, IDE4)	<ul style="list-style-type: none"> <li>• Built-in GigaRAID IT8212 chipset</li> <li>• Supports disk striping (RAID 0) or disk mirroring (RAID 1) or striping + mirroring (RAID 0 + RAID 1)</li> <li>• Supports JBOD function</li> <li>• Supports concurrent dual ATA133 IDE controller operation</li> <li>• Supports ATAPI mode for HDD</li> <li>• Supports IDE bus master operation</li> <li>• Supports ATA133/RAID mode switch by BIOS</li> <li>• Displays status and error checking messages during boot-up</li> <li>• Mirroring supports automatic background rebuilds</li> <li>• Features LBA and Extended Interrupt 13 drive translation in controller onboard BIOS</li> </ul>
I/O Control	<ul style="list-style-type: none"> <li>• IT8712</li> </ul>
Hardware Monitor	<ul style="list-style-type: none"> <li>• CPU/System/Power fan revolution detect</li> <li>• CPU/System/Power fan fail warning</li> <li>• CPU temperature detect</li> <li>• CPU warning temperature</li> <li>• System voltage detect</li> <li>• CPU smart fan control</li> <li>• Thermal shutdown function</li> </ul>
BIOS	<ul style="list-style-type: none"> <li>• Licensed AWARD BIOS</li> <li>• Supports Dual BIOS/Q-Flash</li> </ul>
Additional Features	<ul style="list-style-type: none"> <li>• Supports @BIOS</li> <li>• Supports EasyTune</li> </ul>
Overclocking	<ul style="list-style-type: none"> <li>• Over clock (CPU/AGP) by BIOS</li> <li>• Over voltage (CPU/VDDQ/VCC12_HT/DDR) by BIOS</li> </ul>
Form Factor	<ul style="list-style-type: none"> <li>• ATX size form factor, 30.5cm x 24.4cm</li> </ul>

# GA-K8NS Pro Motherboard Layout

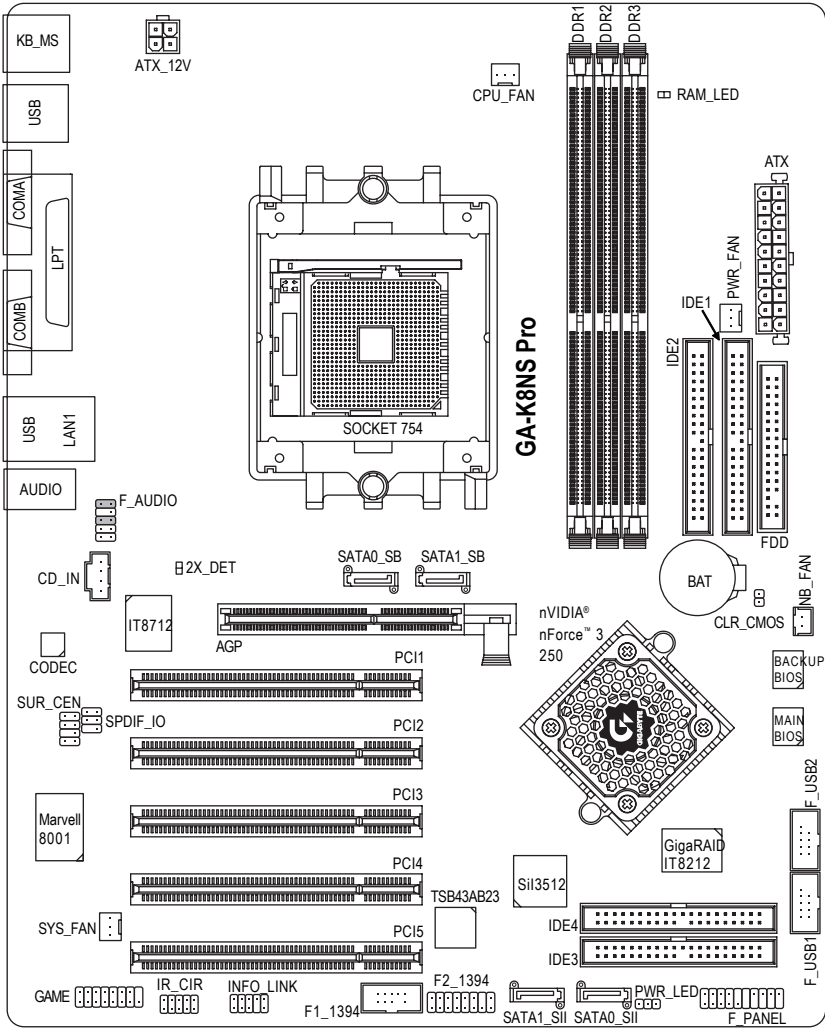

# Block Diagram

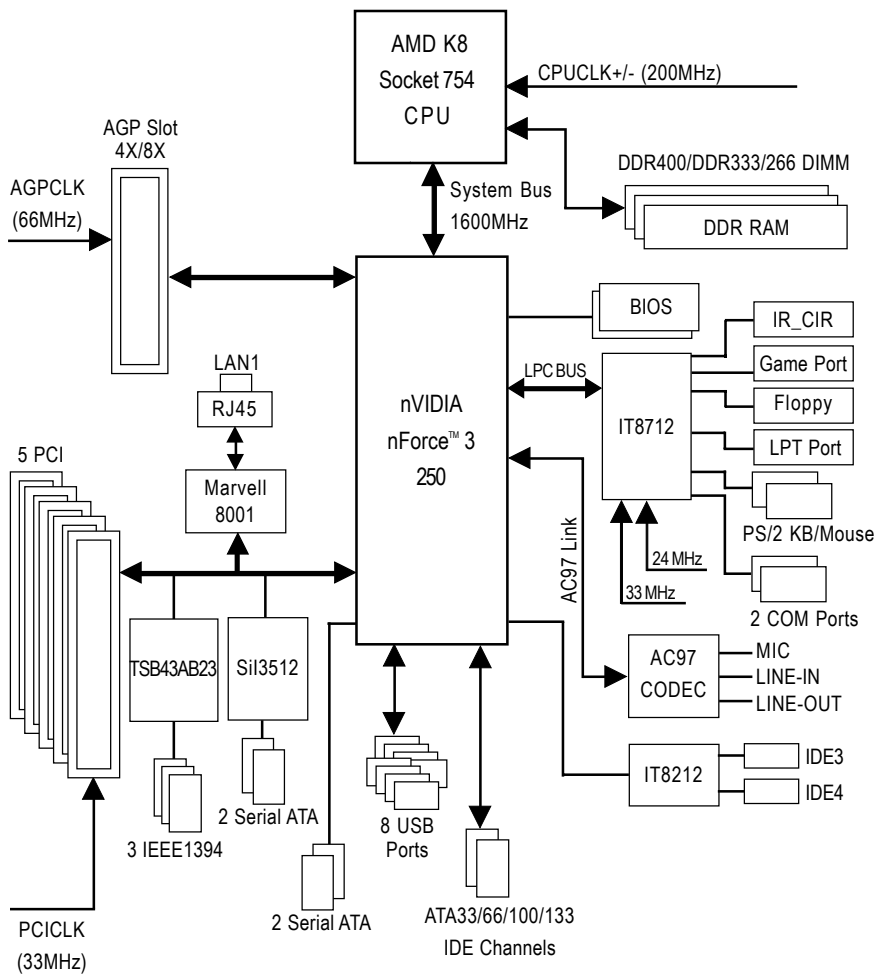



## Chapter 2 Hardware Installation Process

To set up your computer, you must complete the following steps:

- Step 1 - Install the Central Processing Unit (CPU)
- Step 2 - Install Memory Modules
- Step 3 - Install Expansion Cards
- Step 4 - Install I/O Peripherals Cables

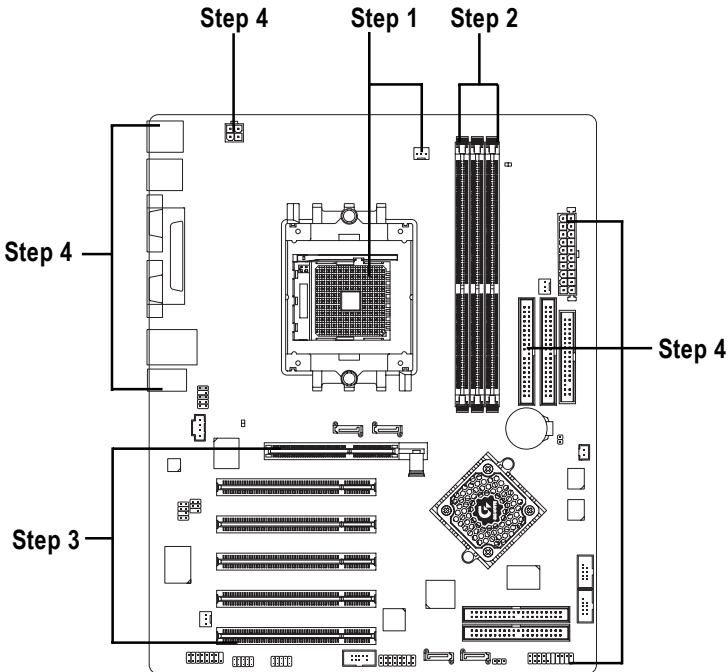

Congratulations! You have accomplished the hardware installation!

Turn on the power supply or connect the power cable to the power outlet. Continue with the BIOS/software installation.

## Step 1: Install the Central Processing Unit (CPU)

Before installing the processor and cooling fan, adhere to the following warning:



1. Please make sure the CPU type is supported by the motherboard.
2. The processor will overheat without the heatsink and/or fan, resulting in permanent irreparable damage.
3. If you do not match the CPU socket Pin 1 and CPU cut edge well, it will cause improper installation. Please change the insert orientation.
4. Apply thermal grease between the processor and cooling fan.
5. Never run the processor without the heatsink properly and firmly attached. Permanent damage will result.
6. Please set the CPU host frequency in accordance with your processor's specifications. We don't recommend you to set the system bus frequency over the CPU's specification because these specific bus frequencies are not the standard specifications for CPU, chipset and most of the peripherals. Whether your system can run under these specific bus frequencies properly will depend on your hardware configurations, including CPU, Memory, Cards...&c.

The installation of the processor and cooling fan is performed in four main steps:

Step1-1. First, check the processor pins to see that none are bent. Move the socket lever to the unlocked position as shown in Figure 1.(90° to the plane of the motherboard) prior to inserting the processor. The pin 1 location is designated on the processor by a copper triangle that matches up to a triangle on the socket as shown in Figure 2. Align the processor to the socket and gently lower it into place. Do not force the processor into the socket.

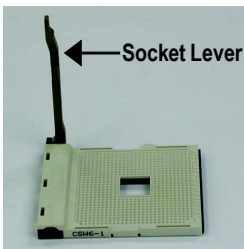

Figure 1.  
Pull the lever to the 90-degree directly.



Figure 2.  
Pin 1 location on the Socket and Processor. Move the socket lever to the locked position while holding pressure on the center of the processor.

Step1-2. When the processor is installed in the socket, apply thermal grease to the processor(as shown in Figure 3) prior to installing the heatsink. Phase change materials develop strong adhesive forces between the heatsink and processor. **Removing the heatsink under such conditions can cause the processor to be removed from the socket without moving the socket lever to the unlocked position and then damage the processor pins or socket contacts.**

\*\* We recommend you to apply the thermal tape to provide better heat conduction between your CPU and heatsink. (The CPU cooling fan might stick to the CPU due to the hardening of the thermal paste. During this condition if you try to remove the cooling fan, you might pull the processor out of the CPU socket along with the cooling fan, and might damage the processor. To avoid this from happening, we suggest you to either use thermal tape instead of thermal paste, or remove the cooling fan with extreme caution.)

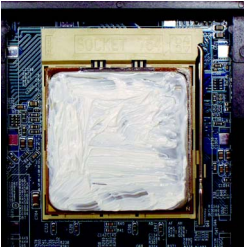

Figure 3.  
Application of thermal grease to the processor.

Step 1-3. Once the thermal grease has been applied to the processor, the heatsink can be attached to the processor. Align the heatsink assembly with the support frame mating with the backer plate standoffs as shown in Figure 4 & 5.

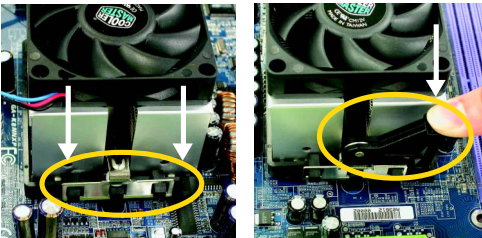

Figure 4 & 5.  
Alignment of heatsink assembly with standoffs.

Step 1-4. Connect the fan power wires to the header on the motherboard as shown in Figure 6.

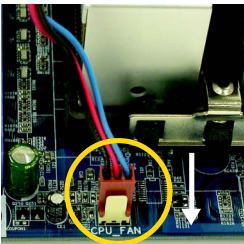

Figure 6.  
Connecting the fan power wires.

## Step 2: Install Memory Modules



Before installing the memory modules, adhere to the following warning:

1. When RAM LED is ON, do not install / remove DIMM from socket.
2. Please note that the DIMM module can only fit in one direction due to the notch. Wrong orientation will cause improper installation. Please change the insert orientation.

The motherboard has 3 dual inline memory module (DIMM) sockets. The BIOS will automatically detects memory type and size. To install the memory module, just push it vertically into the DIMM socket. The DIMM module can only fit in one direction due to the notch. Memory size can vary between sockets.

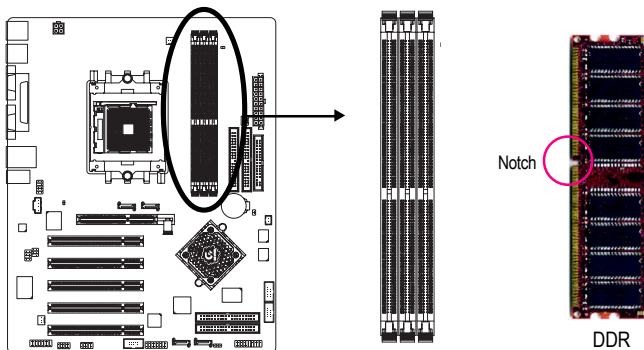

1. The DIMM socket has a notch, so the DIMM memory module can only fit in one direction.



2. Insert the DIMM memory module vertically into the DIMM socket. Then push it down.



3. Close the plastic clip at both edges of the DIMM sockets to lock the DIMM module.  
Reverse the installation steps when you wish to remove the DIMM module.



## Step 3: Install Expansion Cards

1. Read the related expansion card's instruction document before install the expansion card into the computer.
2. Remove your computer's chassis cover, screws and slot bracket from the computer.
3. Press the expansion card firmly into expansion slot in motherboard.
4. Be sure the metal contacts on the card are indeed seated in the slot.
5. Replace the screw to secure the slot bracket of the expansion card.
6. Replace your computer's chassis cover.
7. Power on the computer, if necessary, setup BIOS utility of expansion card from BIOS.
8. Install related driver from the operating system.

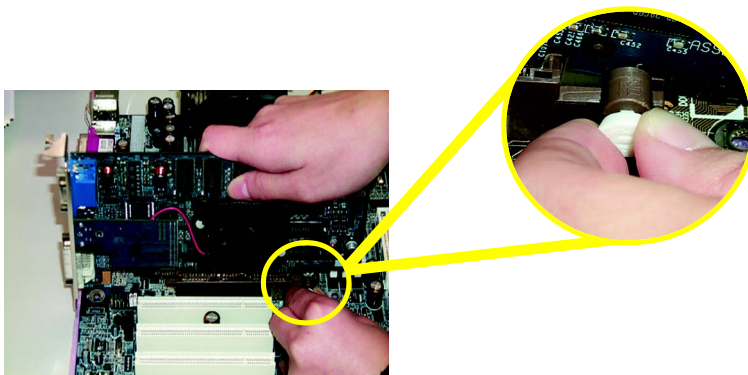

AGP Card

Please carefully pull out the small white-drawable bar at the end of the AGP slot when you try to install / uninstall the AGP card. Please align the AGP card to the onboard AGP slot and press firmly down on the slot. Make sure your AGP card is locked by the small white-drawable bar.



When an AGP 2X (3.3V) card is installed the 2X\_DET will light up, indicating a non-supported graphics card is inserted. Informing users that system might not boot up normally due to AGP 2X (3.3V) is not supported by the chipset.

## Step 4: Install I/O Peripherals Cables

### Step 4-1: I/O Back Panel Introduction

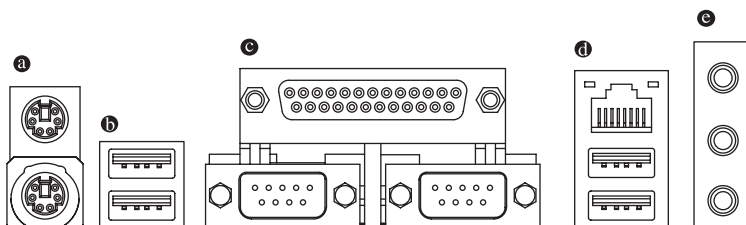

#### **a** PS/2 Keyboard and PS/2 Mouse Connector



PS/2 Mouse Connector  
(6 pin Female)

PS/2 Keyboard Connector  
(6 pin Female)

- This connector supports standard PS/2 keyboard and PS/2 mouse.

#### **b / e** USB/LAN Connector

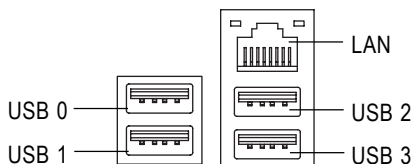

- Before you connect your device(s) into USB connector(s), please make sure your device(s) such as USB keyboard, mouse, scanner, zip, speaker...etc. Have a standard USB interface. Also make sure your OS supports USB controller. If your OS does not support USB controller, please contact OS vendor for possible patch or driver upgrade. For more information please contact your OS or device(s) vendors.
- LAN connector is fast Ethernet with 10/100/1000 Mbps speed.

## ④ Parallel Port, Serial Ports (COMA / COMB)

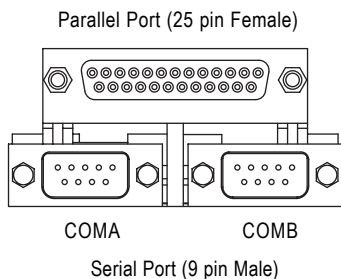

- This connector supports 2 standard COM ports and 1 Parallel port. Devices like printer can be connected to Parallel port; mouse and modem etc. can be connected to Serial ports.

## ④ Audio Connectors

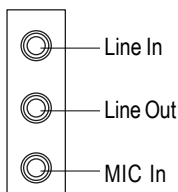

- After install onboard audio driver, you may connect speaker to Line Out jack, microphone to MIC In jack. Devices like CD-ROM, walkman etc. can be connected to Line-In jack.

**Please note:**

You are able to use 2-/4-/6-/8-channel audio feature by S/W selection.

If you want to enable 8-channel function you can refer to page 29, and contact your nearest dealer for optional SUR\_CEN cable.



***If you want the detail information for 2-/4-/6-/8-channel audio setup installation, please refer to page 63.***

## Step 4-2: Connectors Introduction

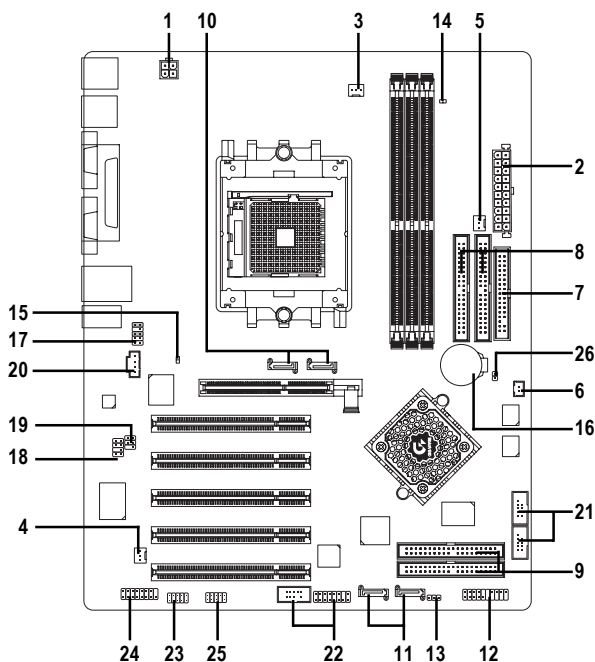

1) ATX_12V	14) RAM_LED
2) ATX (Power Connector)	15) 2X_DET
3) CPU_FAN	16) BATTERY
4) SYS_FAN	17) F_AUDIO
5) PWR_FAN	18) SUR_CEN
6) NB_FAN	19) SPDIF_IO
7) FDD	20) CD_IN
8) IDE1 / IDE2	21) F_USB1 / F_USB2
9) IDE3 / IDE4	22) F1_1394 / F2_1394
10) SATA0_SB / SATA1_SB	23) IR_CIR
11) SATA0_SII / SATA1_SII	24) GAME
12) F_PANEL	25) INFO_LINK
13) PWR_LED	26) CLR_CMOS

## 1) ATX\_12V (+12V Power Connector)

This connector (ATX\_12V) supplies the CPU operation voltage (Vcore).

If this "ATX\_12V connector" is not connected, system cannot boot.

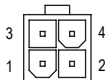
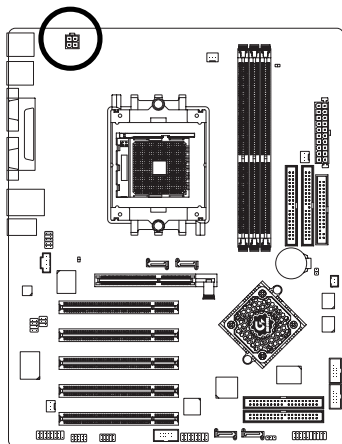

Pin No.	Definition
1	GND
2	GND
3	+12V
4	+12V

## 2) ATX (ATX Power Connector)

AC power cord should only be connected to your power supply unit after ATX power cable and other related devices are firmly connected to the motherboard.

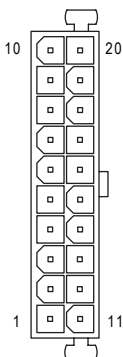
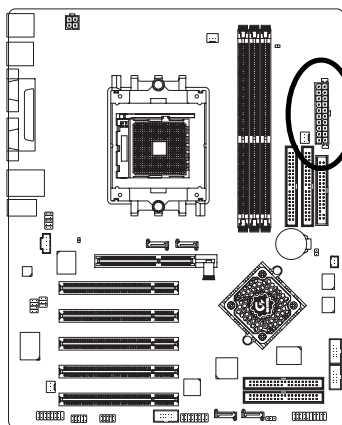

Pin No.	Definition
1	3.3V
2	3.3V
3	GND
4	+5V
5	GND
6	+5V
7	GND
8	Power Good
9	5V SB (stand by +5V)
10	+12V
11	3.3V
12	-12V
13	GND
14	PS_ON(soft on/off)
15	GND
16	GND
17	GND
18	-5V
19	+5V
20	+5V

### 3) CPU\_FAN (CPU Fan Connector)

Please note, a proper installation of the CPU cooler is essential to prevent the CPU from running under abnormal condition or damaged by overheating. The CPU fan connector supports Max. current up to 600 mA.

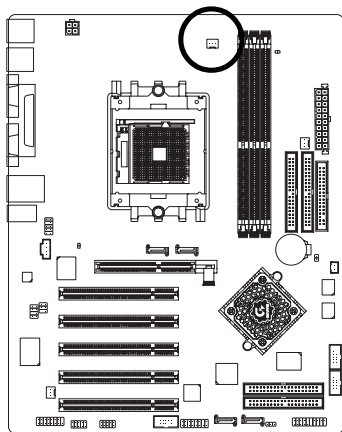

Pin No.	Definition
1	GND
2	+12V
3	Sense

### 4) SYS\_FAN (System Fan Connector)

This connector allows you to link with the cooling fan on the system case to lower the system temperature.

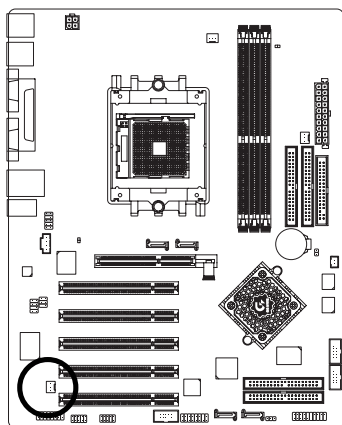

Pin No.	Definition
1	GND
2	+12V
3	Sense

## 5) PWR\_FAN (Power Fan Connector)

This connector allows you to link with the cooling fan on the system case to lower the system temperature.

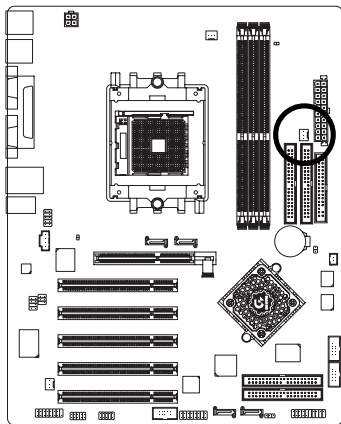

Pin No.	Definition
1	GND
2	+12V
3	NC

## 6) NB\_FAN (Chip Fan Connector)

If you installed wrong direction, the chip fan will not work. Sometimes will damage the chip fan. (Usually black cable is GND)

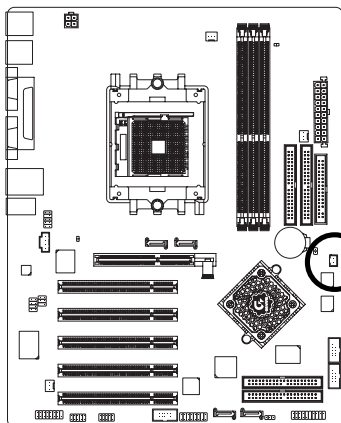

Pin No.	Definition
1	Power
2	GND

## 7) FDD (Floppy Connector)

Please connect the floppy drive ribbon cables to FDD. It supports 360K, 1.2M, 720K, 1.44M and 2.88M bytes floppy disk types.

The red stripe of the ribbon cable must be the same side with the Pin1.

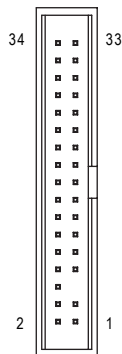
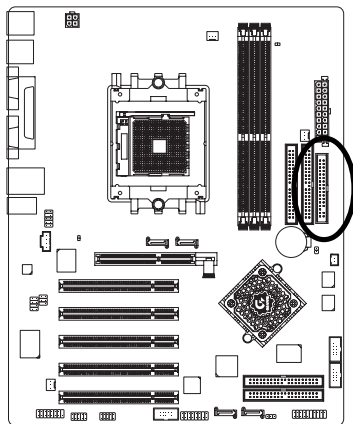

## 8) IDE1 / IDE2 (IDE1 / IDE2 Connector)

Please connect first hard disk to IDE1 and connect CD-ROM to IDE2.

The red stripe of the ribbon cable must be the same side with the Pin1.

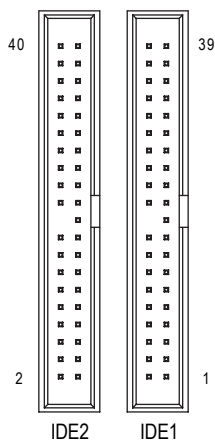
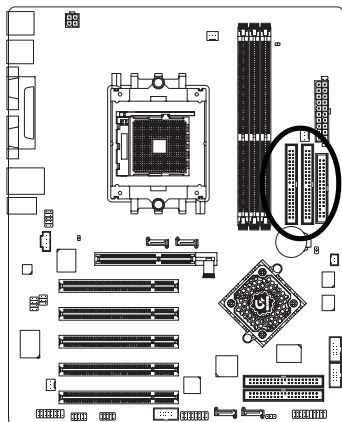



### 9) IDE3 / IDE4 (IDE3 / IDE4 Connector, RAID/ATA133)

The red stripe of the ribbon cable must be the same side with the Pin1. If you wish to use IDE3 and IDE4, please use it in unity with BIOS (either RAID or ATA133). Then, install the correct driver to have proper operation. For details, please refer to the GigaRAID manual.

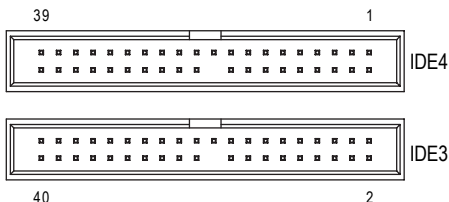
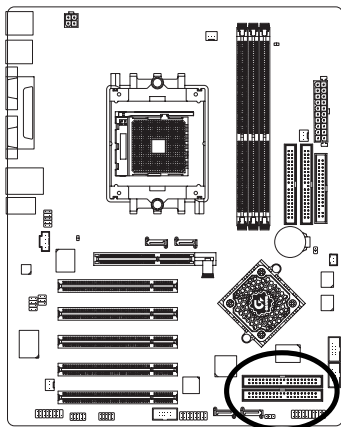

### 10/11) SATA0\_SB / SATA1\_SB; SATA0\_SII / SATA1\_SII (Serial ATA Connector)

You can connect the Serial ATA device to this connector. If you wish to use RAID function, please use it in unity with BIOS and install the correct driver to have proper operation.

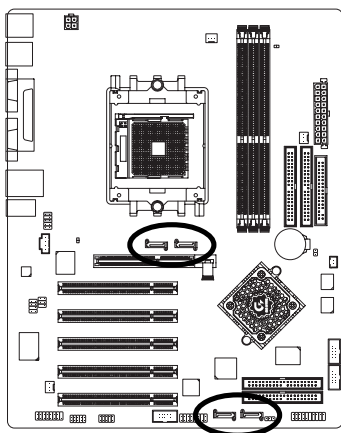

SATA0\_SB / SATA1\_SB

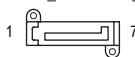

SATA0\_SII / SATA1\_SII

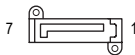

Pin No.	Definition
1	GND
2	TXP
3	TXN
4	GND
5	RXN
6	RXP
7	GND

These SATA connectors support hot plug function.

## 12) F\_PANEL (2 x 10 pins Connector)

Please connect the power LED, PC speaker, reset switch and power switch etc. of your chassis front panel to the F\_PANEL connector according to the pin assignment below.

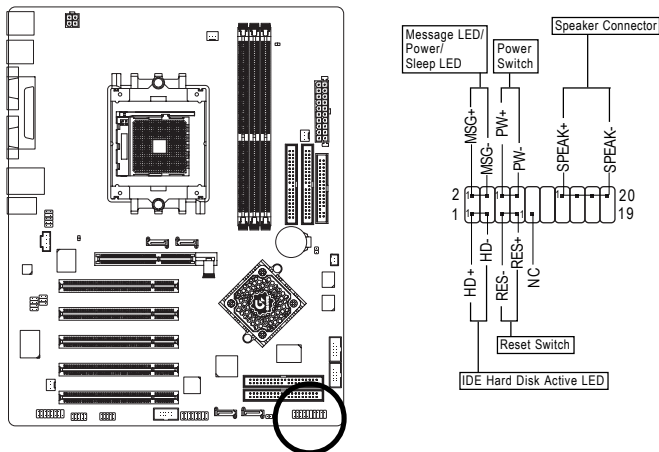

HD (IDE Hard Disk Active LED) (Blue)	Pin 1: LED anode(+) Pin 2: LED cathode(-)
SPK (Speaker Connector) (Amber)	Pin 1: VCC(+) Pin 2- Pin 3: NC Pin 4: Data(-)
RES (Reset Switch) (Green)	Open: Normal Operation Close: Reset Hardware System
PW (Power Switch) (Red)	Open: Normal Operation Close: Power On/Off
MSG (Message LED/ Power/ Sleep LED) (Yellow)	Pin 1: LED anode(+) Pin 2: LED cathode(-)
NC (Purple)	NC

### 13) PWR\_LED

PWR\_LED is connect with the system power indicator to indicate whether the system is on/off. It will blink when the system enters suspend mode. If you use dual color LED, power LED will turn to another color.

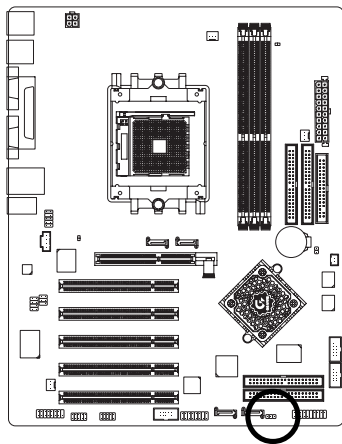

1 

Pin No.	Definition
1	MPD+
2	MPD-
3	MPD-

### 14) RAM\_LED

Do not remove memory modules while RAM\_LED is on. It might cause short or other unexpected damages due to the stand by voltage. Remove memory modules only when AC power cord is disconnected.

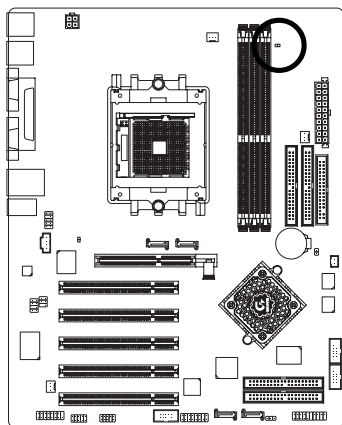

+  -

## 15) 2X\_LED

When an AGP 2X (3.3V) card is installed the 2X\_DET will light up, indicating a non-supported graphics card is inserted. Informing users that system might not boot up normally due to AGP 2X (3.3V) is not supported by the chipset.

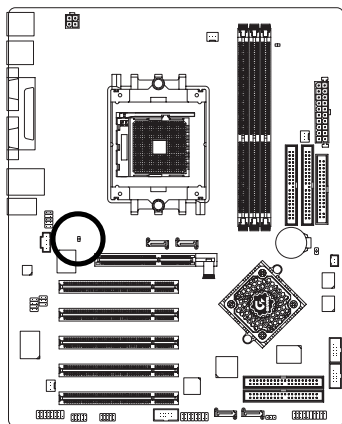

## 16) BATTERY

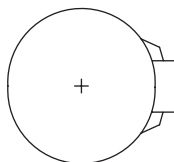
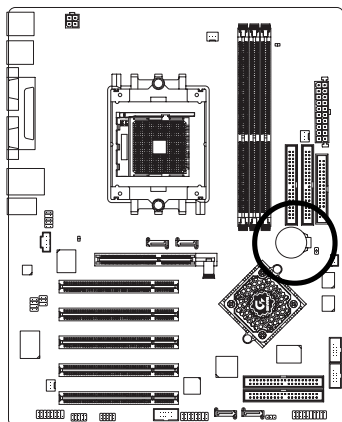

### CAUTION

- ❖ Danger of explosion if battery is incorrectly replaced.
- ❖ Replace only with the same or equivalent type recommended by the manufacturer.
- ❖ Dispose of used batteries according to the manufacturer's instructions.

If you want to erase CMOS...

1. Turn OFF the computer and unplug the power cord.
2. Take out the battery gently and put it aside for about 10 minutes (Or you can use a metal object to connect the positive and negative pins in the battery holder to make them short for one minute).
3. Re-install the battery.
4. Plug the power cord and turn ON the computer.

## 17) F\_AUDIO (Front Audio Connector)

If you want to use Front Audio connector, you must remove 5-6, 9-10 Jumper.

In order to utilize the front audio header, your chassis must have front audio connector. Also please make sure the pin assignment on the cable is the same as the pin assignment on the MB header. To find out if the chassis you are buying support front audio connector, please contact your dealer. Please note, you can have the alternative of using front audio connector or of using rear audio connector to play sound.

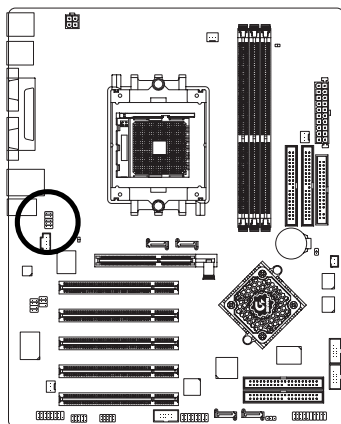

10 9  
2 1

Pin No.	Definition
1	MIC
2	GND
3	MIC_BIAS
4	Power
5	FrontAudio(R)
6	RearAudio(R)/Return R
7	NC
8	No Pin
9	FrontAudio(L)
10	RearAudio(L)/Return L

## 18) SUR\_CEN (Surround Center Connector)

Please contact your nearest dealer for optional SUR\_CEN cable.

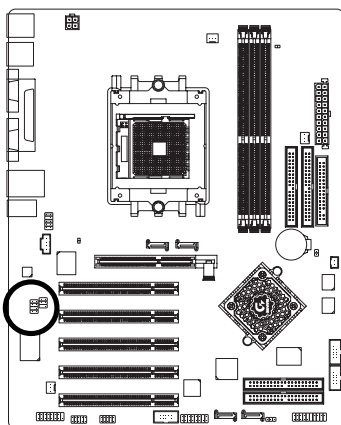

8 7  
2 1

Pin No.	Definition
1	SUR OUTL
2	SUR OUTR
3	GND
4	No Pin
5	CENTER_OUT
6	BASS_OUT
7	AUX_L
8	AUX_R

## 19) SPDIF\_IO (SPDIF In / Out Connector)

The SPDIF output is capable of providing digital audio to external speakers or compressed AC3 data to an external Dolby Digital Decoder. Use this feature only when your stereo system has digital input and output function. Use SPDIF in feature only when your device has digital output function. Be careful with the polarity of the SPDIF\_IO connector. Check the pin assignment carefully while you connect the SPDIF cable, incorrect connection between the cable and connector will make the device unable to work or even damage it. For optional SPDIF cable, please contact your local dealer.

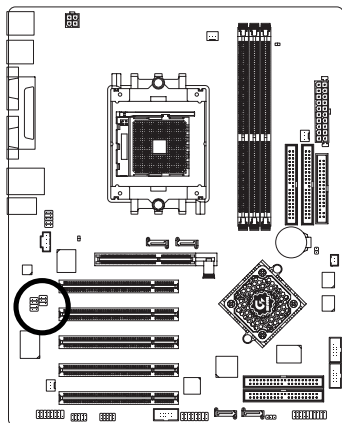

Pin No.	Definition
1	Power
2	No Pin
3	SPDIF
4	SPDIFI
5	GND
6	GND

## 20) CD\_IN (CD In Connector)

Connect CD-ROM or DVD-ROM audio out to the CD\_IN connector.

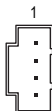
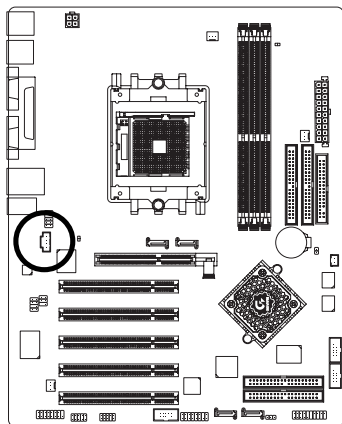

Pin No.	Definition
1	CD-L
2	GND
3	GND
4	CD-R

## 21) F\_USB1 / F\_USB2 (Front USB Connector)

Be careful with the polarity of the front USB connector. Check the pin assignment carefully while you connect the front USB cable, incorrect connection between the cable and connector will make the device unable to work or even damage it. For optional front USB cable, please contact your local dealer.

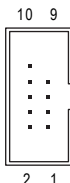
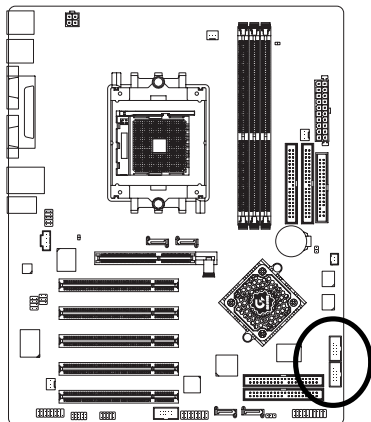

Pin No.	Definition
1	Power
2	Power
3	USB Dx-
4	USB Dy-
5	USB Dx+
6	USB Dy+
7	GND
8	GND
9	No Pin
10	NC

## 22) F1\_1394 / F2\_1394 (Front IEEE1394 Connector)

Serial interface standard set by Institute of Electrical and Electronics Engineers, which has features like high speed, highbandwidth and hot plug. Be careful with the polarity of the IEEE1394 connector. Check the pin assignment carefully while you connect the IEEE1394 cable, incorrect connection between the cable and connector will make the device unable to work or even damage it. For optional IEEE1394 cable, please contact your local dealer.

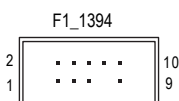
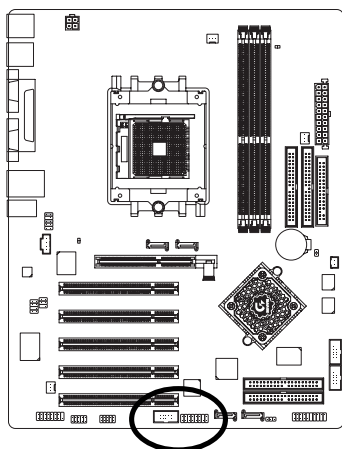

Pin No.	Definition
1	TPA2+
2	TPA2-
3	GND
4	GND
5	TPB2+
6	TPB2-
7	No Pin
8	Power
9	Power
10	GND

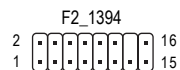

Pin No.	Definition
1	Power
2	Power
3	TPA0+
4	TPA0-
5	GND
6	GND
7	TPB0+
8	TPB0-
9	Power
10	Power
11	TPA1+
12	TPA1-
13	GND
14	No Pin
15	TPB1+
16	TPB1-

## 23) IR\_CIR

Make sure the pin 1 on the IR device is along with pin one the connector. To enable the IR/CIR function, you are required to purchase an optional IR/CIR module. To use IR function only, please connect IR module to Pin1 to Pin5. Be careful with the polarity of the IR/CIR connector. Check the pin assignment carefully while you connect the IR/CIR cable, incorrect connection between the cable and connector will make the device unable to work or even damage it. For optional IR/CIR cable, please contact your local dealer.

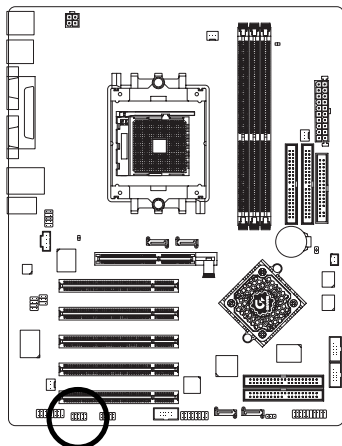

Pin No.	Definition
1	Power
2	NC
3	IRRX
4	GND
5	IRTX
6	NC
7	CIRRX
8	+5VSB
9	CIRTX
10	NC

## 24) GAME (Game Connector)

This connector supports joystick, MIDI keyboard and other relate audio devices. Check the pin assignment while you connect the game cables. Please contact your nearest dealer for optional game cables.

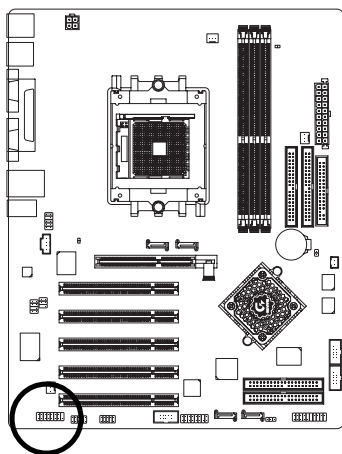

Pin No.	Definition
1	Power
2	GRX1_R
3	GND
4	GPSA2
5	Power
6	GPX2_R
7	GPY2_R
8	MSL_R
9	GPSA1
10	GND
11	GPY1_R
12	Power
13	GPSB1
14	MSO_R
15	GPSB2
16	No Pin



## 25) INFO\_LINK

This connector allows you to connect some external devices to provide you extra function. Check the pin assignment while you connect the external device cable. Please contact your nearest dealer for optional external device cable.

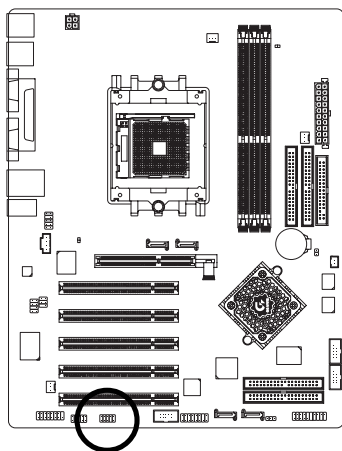

Pin No.	Definition
1	SMBCLK
2	Power
3	SMBDATA
4	GPIO
5	GND
6	GND
7	No Pin
8	NC
9	+12V
10	+12V

## 26) Clear CMOS (Clear CMOS)

You may clear the CMOS data to its default values by this jumper. To clear CMOS, temporarily short 1-2 pin. Default doesn't include the "Shunter" to prevent from improper use this jumper.

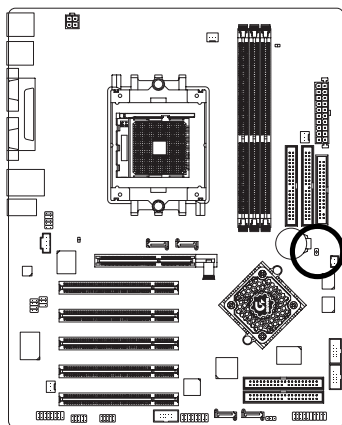

Open: Normal



Short: Clear CMOS



## Chapter 3 BIOS Setup

BIOS Setup is an overview of the BIOS Setup Program. The program that allows users to modify the basic system configuration. This type of information is stored in battery-backed CMOS RAM so that it retains the Setup information when the power is turned off.

### ENTERING SETUP

Powering ON the computer and pressing <Del> immediately will allow you to enter Setup. If you require more advanced BIOS settings, please go to "Advanced BIOS" setting menu. To enter Advanced BIOS setting menu, press "Ctrl+F1" key on the BIOS screen.

### CONTROL KEYS

<↑>	Move to previous item
<↓>	Move to next item
<←>	Move to the item in the left hand
<→>	Move to the item in the right hand
<Enter>	Select Item
<Esc>	Main Menu - Quit and not save changes into CMOS Status Page Setup Menu and Option Page Setup Menu - Exit current page and return to Main Menu
<+/PgUp>	Increase the numeric value or make changes
<-/PgDn>	Decrease the numeric value or make changes
<F1>	General help, only for Status Page Setup Menu and Option Page Setup Menu
<F2>	Item Help
<F3>	Reserved
<F4>	Reserved
<F5>	Restore the previous CMOS value from CMOS, only for Option Page Setup Menu
<F6>	Load the fail-safe default CMOS value from BIOS default table
<F7>	Load the Optimized Defaults
<F8>	Dual BIOS/Q-Flash utility
<F9>	System Information
<F10>	Save all the CMOS changes, only for Main Menu

## Main Menu

The on-line description of the highlighted setup function is displayed at the bottom of the screen.

### Status Page Setup Menu / Option Page Setup Menu

Press F1 to pop up a small help window that describes the appropriate keys to use and the possible selections for the highlighted item. To exit the Help Window press <Esc>.



The BIOS Setup menus described in this chapter are for reference only and may differ from the exact settings for your motherboard.

## The Main Menu (For example: BIOS Ver. : E11)

Once you enter Award BIOS CMOS Setup Utility, the Main Menu (as figure below) will appear on the screen. The Main Menu allows you to select from eight setup functions and two exit choices. Use arrow keys to select among the items and press <Enter> to accept or enter the sub-menu.

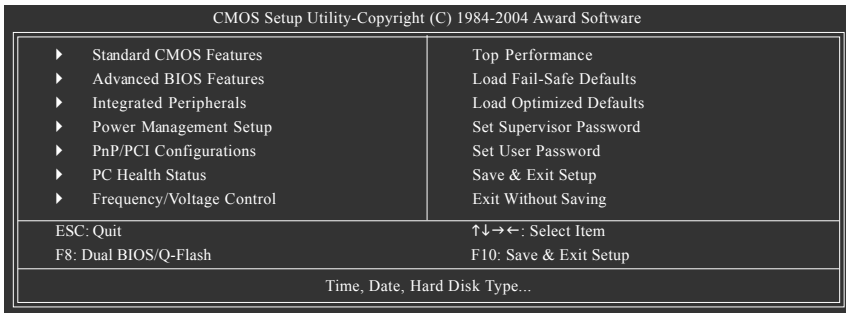

If you can't find the setting you want, please press "Ctrl + F1" to search the advanced option hidden.

- **Standard CMOS Features**

This setup page includes all the items in standard compatible BIOS.

- **Advanced BIOS Features**

This setup page includes all the items of Award special enhanced features.

- **Integrated Peripherals**

This setup page includes all onboard peripherals.

- **Power Management Setup**

This setup page includes all the items of Green function features.

- **PnP/PCI Configurations**

This setup page includes all the configurations of PCI & PnP ISA resources.

- **PC Health Status**

This setup page is the System auto detect Temperature, voltage, fan, speed.

- **Frequency/Voltage Control**

This setup page is control CPU's clock and frequency ratio.

- **Top Performance**

If you wish to maximize the performance of your system, set "Top Performance" as "Enabled".

- **Load Fail-Safe Defaults**

Fail-Safe Defaults indicates the value of the system parameters which the system would be in safe configuration.

- **Load Optimized Defaults**

Optimized Defaults indicates the value of the system parameters which the system would be in best performance configuration.

- **Set Supervisor Password**

Change, set, or disable password. It allows you to limit access to the system and Setup, or just to Setup.

- **Set User Password**

Change, set, or disable password. It allows you to limit access to the system.

- **Save & Exit Setup**

Save CMOS value settings to CMOS and exit setup.

- **Exit Without Saving**

Abandon all CMOS value changes and exit setup.

## Standard CMOS Features

CMOS Setup Utility-Copyright (C) 1984-2004 Award Software		
Standard CMOS Features		
Date (mm:dd:yy)	Mon, Mar 22 2004	Item Help
Time (hh:mm:ss)	22:31:24	Menu Level▶
▶ IDE Channel 0 Master	[None]	Change the day, month, year
▶ IDE Channel 0 Slave	[None]	<Week>
▶ IDE Channel 1 Master	[None]	Sun. to Sat.
▶ IDE Channel 1 Slave	[None]	<Month>
▶ IDE Channel 2 Master	[None]	Jan. to Dec.
▶ IDE Channel 3 Master	[None]	<Day>
Drive A	[1.44M, 3.5"]	1 to 31 (or maximum allowed in the month)
Drive B	[None]	<Year>
Floppy 3 Mode Suport	[Disabled]	1999 to 2098
Hard On	[All, But Keyboard]	
Base Memory	640K	
Extended Memory	127M	
Total Memory	128M	
↑↓→←: Move    Enter: Select    +/-/PU/PD: Value    F10: Save    ESC: Exit    F1: General Help F5: Previous Values    F6: Fail-Safe Default    F7: Optimized Defaults		

### ☞ Date

The date format is <week>, <month>, <day>, <year>.

- ▶▶ Week    The week, from Sun to Sat, determined by the BIOS and is displayed only
- ▶▶ Month    The month, Jan. Through Dec.
- ▶▶ Day        The day, from 1 to 31 (or the maximum allowed in the month)
- ▶▶ Year        The year, from 1999 through 2098

### ☞ Time

The times format in <hour> <minute> <second>. The time is calculated base on the 24-hour military-time clock. For example, 1 p.m. is 13:00:00.

### ☞ IDE Channel 0 Master/Slave; IDE Channel 1 Master/Slave

- ▶▶ IDE HDD Auto-Detection Press "Enter" to select this option for automatic device detection.
- ▶▶ IDE Channel 0 Master/Slave; IDE Channel 1 Master/Slave  
IDE devices setup. You can use one of three methods:
  - Auto        Allows BIOS to automatically detect IDE devices during POST. (Default value)
  - None        Select this if no IDE devices are used and the system will skip the automatic detection step and allow for faster system start up.
  - Manual      User can manually input the correct settings.
- ▶▶ Access Mode Use this to set the access mode for the hard drive. The four options are: CHS/LBA/Large/Auto(default:Auto)

### ☞ IDE Channel 2/3 Master

- ▶▶ IDE HDD Auto-Detection Press "Enter" to select this option for automatic device detection.
- ▶▶ Extended IDE Drive  
SATA IDE devices setup. You can use one of two methods:
  - Auto        Allows BIOS to automatically detect SATA IDE devices during POST(default)
  - None        Select this if no SATA IDE devices are used and the system will skip the automatic detection step and allow for faster system start up.

- » Access Mode      Use this to set the access mode for the hard drive. The two options are: Large/Auto(default:Auto)
- » Capacity          Capacity of currently installed hard drive.  
Hard drive information should be labeled on the outside drive casing. Enter the appropriate option based on this information.
- » Cylinder          Number of cylinders
- » Head              Number of heads
- » Precomp          Write precomp
- » Landing Zone    Landing zone
- » Sector            Number of sectors

### ☞ Drive A / Drive B

The category identifies the types of floppy disk drive A or drive B that has been installed in the computer.

- » None              No floppy drive installed
- » 360K, 5.25"      5.25 inch PC-type standard drive; 360K byte capacity.
- » 1.2M, 5.25"      5.25 inch AT-type high-density drive; 1.2M byte capacity  
(3.5 inch when 3 Mode is Enabled).
- » 720K, 3.5"        3.5 inch double-sided drive; 720K byte capacity
- » 1.44M, 3.5"      3.5 inch double-sided drive; 1.44M byte capacity.
- » 2.88M, 3.5"      3.5 inch double-sided drive; 2.88M byte capacity.

### ☞ Floppy 3 Mode Support (for Japan Area)

- » Disabled          Normal Floppy Drive. (Default value)
- » Drive A           Drive A is 3 mode Floppy Drive.
- » Drive B           Drive B is 3 mode Floppy Drive.
- » Both              Drive A & B are 3 mode Floppy Drives.

### ☞ Halt on

The category determines whether the computer will stop if an error is detected during power up.

- » No Errors          The system boot will not stop for any error that may be detected and you will be prompted.
- » All Errors          Whenever the BIOS detects a non-fatal error the system will be stopped.
- » All, But Keyboard    The system boot will not stop for a keyboard error; it will stop for all other errors. (Default value)
- » All, But Diskette    The system boot will not stop for a disk error; it will stop for all other errors.
- » All, But Disk/Key    The system boot will not stop for a keyboard or disk error; it will stop for all other errors.

### ☞ Memory

The category is display-only which is determined by POST (Power On Self Test) of the BIOS.

#### » Base Memory

The POST of the BIOS will determine the amount of base (or conventional) memory installed in the system.

The value of the base memory is typically 512K for systems with 512K memory installed on the motherboard, or 640K for systems with 640K or more memory installed on the motherboard.

#### » Extended Memory

The BIOS determines how much extended memory is present during the POST.

This is the amount of memory located above 1 MB in the CPU's memory address map.

## Advanced BIOS Features

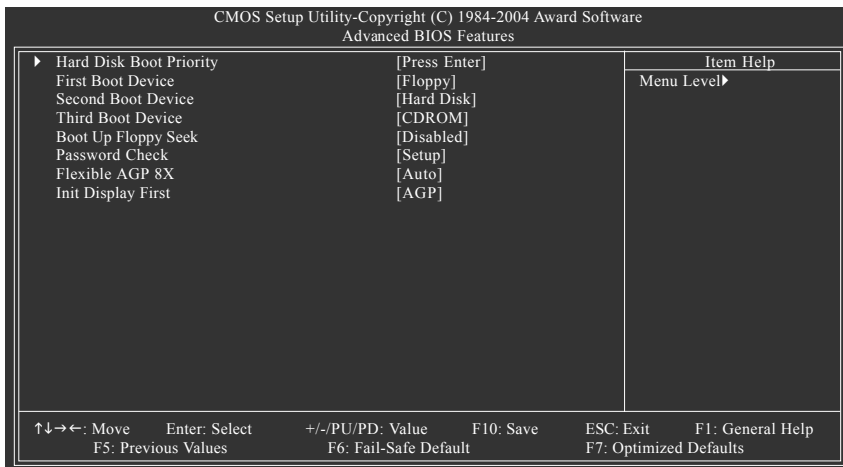

### Hard Disk Boot Priority

Select boot sequence for onboard(or add-on cards) SCSI, RAID, etc.

Use <↑> or <↓> to select a device, then press<+> to move it up, or <-> to move it down the list. Press <ESC> to exit this menu.

### First / Second / Third Boot Device

- ▶ Floppy      Select your boot device priority by Floppy.
- ▶ LS120      Select your boot device priority by LS120.
- ▶ Hard Disk    Select your boot device priority by Hard Disk.
- ▶ CDROM      Select your boot device priority by CDROM.
- ▶ ZIP         Select your boot device priority by ZIP.
- ▶ USB-FDD    Select your boot device priority by USB-FDD.
- ▶ USB-ZIP    Select your boot device priority by USB-ZIP.
- ▶ USB-CDROM Select your boot device priority by USB-CDROM.
- ▶ USB-HDD    Select your boot device priority by USB-HDD.
- ▶ LAN         Select your boot device priority by LAN.
- ▶ Disabled    Select your boot device priority by Disabled.

### Boot Up Floppy Seek

During POST, BIOS will determine the floppy disk drive installed is 40 or 80 tracks. 360K type is 40 tracks 720K, 1.2M and 1.44M are all 80 tracks.

- ▶ Enabled      BIOS searches for floppy disk drive to determine it is 40 or 80 tracks. Note that BIOS can not tell from 720K, 1.2M or 1.44M drive type as they are all 80 tracks.
- ▶ Disabled     BIOS will not search for the type of floppy disk drive by track number. Note that there will not be any warning message if the drive installed is 360K. (Default value)



### ☞ Password Check

- ▶▶ System      The system can not boot and can not access to Setup page will be denied if the correct password is not entered at the prompt.
- ▶▶ Setup        The system will boot, but access to Setup will be denied if the correct password is not entered at the prompt. (Default value)

### ☞ Flexible AGP 8X

- ▶▶ Auto         Automatically set AGP transfer rate according to AGP compatibility and stability. (Default value)
- ▶▶ 8X           Always set AGP transfer rate to 8X mode if the 8X mode supported by the AGP card.
- ▶▶ 4X           Set AGP transfer rate to 4X mode no matter what the AGP transfer rate the card is.

### ☞ Init Display First

This feature allows you to select the first initiation of the monitor display from which card when you install an AGP card and a PCI VGA card on the motherboard.

- ▶▶ AGP          Set Init display first to AGP. (Default value)
- ▶▶ PCI slot      Set Init display first to PCI.

# Integrated Peripherals

CMOS Setup Utility-Copyright (C) 1984-2004 Award Software  
Integrated Peripherals

		Item Help
IDE Function Setup	[Press Enter]	Menu Level▶
On-Chip Primary PCI IDE	[Enabled]	
On-Chip Secondary PCI IDE	[Enabled]	
USB Host Controller	[V1.1+V2.0]	
USB Keyboard Support	[Disabled]	
USB Mouse Support	[Disabled]	
Serial-ATA 2(Internal PHY)	[Enabled]	
AC97 Audio	[Auto]	
Onboard Serial ATA	[Enabled]	
Serial ATA Function	[RAID]	
Onboard 1394	[Enabled]	
Onboard Giga-RAID	[Enabled]	
Onboard LAN Control	[Enabled]	
Onboard LAN Boot ROM	[Disabled]	
Onboard Serial Port 1	[3F8/IRQ4]	
Onboard Serial Port 2	[2F8/IRQ3]	
Onboard Parallel Port	[378/IRQ7]	
Parallel Port Mode	[SPP]	
x ECP Mode Use DMA	3	

↑↓←→: Move    Enter: Select    +/-/PU/PD: Value    F10: Save    ESC: Exit    F1: General Help  
 F5: Previous Values    F6: Fail-Safe Default    F7: Optimized Defaults

CMOS Setup Utility-Copyright (C) 1984-2004 Award Software  
Integrated Peripherals

		Item Help
Game Port Address	[201]	Menu Level▶
Midi Port Address	[Disabled]	
x Midi Port IRQ	10	
CIR Port Address	[Disabled]	
x CIR Port IRQ	11	
IDE DMA transfer	[Enabled]	

↑↓←→: Move    Enter: Select    +/-/PU/PD: Value    F10: Save    ESC: Exit    F1: General Help  
 F5: Previous Values    F6: Fail-Safe Default    F7: Optimized Defaults

## IDE Function Setup

CMOS Setup Utility-Copyright (C) 1984-2004 Award Software  
IDE Function Setup

		Item Help
IDE Channel 0 Master RAID	[Disabled]	Menu Level▶
IDE Channel 0 Slave RAID	[Disabled]	
IDE Channel 1 Master RAID	[Disabled]	
IDE Channel 1 Slave RAID	[Disabled]	
SATA Primary Master RAID	[Disabled]	
SATA Secndry Master RAID	[Disabled]	

↑↓←→: Move    Enter: Select    +/-/PU/PD: Value    F10: Save    ESC: Exit    F1: General Help  
 F5: Previous Values    F6: Fail-Safe Default    F7: Optimized Defaults

- ☞ **IDE Channel 0 Master RAID**
  - ▶▶ Enabled Enable 1st master channel IDE RAID function.
  - ▶▶ Disabled Disable this function. (Default value)
- ☞ **IDE Channel 0 Slave RAID**
  - ▶▶ Enabled Enable 1st slave channel IDE RAID function.
  - ▶▶ Disabled Disable this function. (Default value)
- ☞ **IDE Channel 1 Master RAID**
  - ▶▶ Enabled Enable 2nd master channel IDE RAID function.
  - ▶▶ Disabled Disable this function. (Default value)
- ☞ **IDE Channel 1 Slave RAID**
  - ▶▶ Enabled Enable 2nd slave channel IDE RAID function.
  - ▶▶ Disabled Disable this function. (Default value)
- ☞ **SATA Primary Master RAID**
  - ▶▶ Enabled Enable 1st SATA RAID function.
  - ▶▶ Disabled Disable this function. (Default value)
- ☞ **SATA Secndry Master RAID**
  - ▶▶ Enabled Enable 2nd SATA RAID function.
  - ▶▶ Disabled Disable this function. (Default value)
- ☞ **On-Chip Primary PCI IDE**
  - ▶▶ Enabled Enable onboard 1st channel IDE port. (Default value)
  - ▶▶ Disabled Disable onboard 1st channel IDE port.
- ☞ **On-Chip Secondary PCI IDE**
  - ▶▶ Enabled Enable onboard 2nd channel IDE port. (Default value)
  - ▶▶ Disabled Disable onboard 2nd channel IDE port.
- ☞ **USB Host Controller**
  - ▶▶ Disabled Disable this function if you are not using onboard USB function.
  - ▶▶ V1.1+V2.0 Enable USB 1.1 and USB 2.0 controller. (Default value)
  - ▶▶ V1.1 Only enable USB 1.1 controller.
- ☞ **USB Keyboard Support**
  - ▶▶ Enabled Enable USB keyboard support.
  - ▶▶ Disabled Disable USB keyboard support. (Default value)
- ☞ **USB Mouse Support**
  - ▶▶ Enabled Enable USB mouse support.
  - ▶▶ Disabled Disable USB mouse support. (Default value)
- ☞ **Serial-ATA 2 (Internal PHY)**
  - ▶▶ Enabled Enable Serial ATA supported. (Default value)
  - ▶▶ Disabled Disable Serial ATA supported.
- ☞ **AC97 Audio**
  - ▶▶ Auto Enable onboard AC'97 audio function. (Default value)
  - ▶▶ Disabled Disable this function.
- ☞ **Onboard Serial ATA**
  - ▶▶ Enabled Enable onboard Serial ATA chip function. (Default value)
  - ▶▶ Disabled Disable this function.

- ☞ **Serial ATA Function**
  - ▶▶ RAID Select onboard Serial ATA chip function as RAID. (Default value)
  - ▶▶ BASE Select onboard Serial ATA chip function as base.
- ☞ **Onboard Giga-RAID**
  - ▶▶ Enabled Enable onboard GigaRAID chip function. (Default value)
  - ▶▶ Disabled Disable onboard GigaRAID chip function.
- ☞ **Onboard 1394**
  - ▶▶ Enabled Enable onboard IEEE1394 function. (Default value)
  - ▶▶ Disabled Disable onboard IEEE1394 function.
- ☞ **Onboard LAN Control**
  - ▶▶ Enabled Enable onboard LAN chip function. (Default value)
  - ▶▶ Disabled Disable onboard LAN chip function.
- ☞ **Onboard LAN Boot ROM**

This function decide whether to invoke the boot ROM of the onboard LAN chip.

  - ▶▶ Enabled Enable this function.
  - ▶▶ Disabled Disable this function. (Default value)
- ☞ **Onboard Serial Port 1**
  - ▶▶ Auto BIOS will automatically setup the port 1 address.
  - ▶▶ 3F8/IRQ4 Enable onboard Serial port 1 and address is 3F8. (Default value)
  - ▶▶ 2F8/IRQ3 Enable onboard Serial port 1 and address is 2F8.
  - ▶▶ 3E8/IRQ4 Enable onboard Serial port 1 and address is 3E8.
  - ▶▶ 2E8/IRQ3 Enable onboard Serial port 1 and address is 2E8.
  - ▶▶ Disabled Disable onboard Serial port 1.
- ☞ **Onboard Serial Port 2**
  - ▶▶ Auto BIOS will automatically setup the port 2 address.
  - ▶▶ 3F8/IRQ4 Enable onboard Serial port 2 and address is 3F8.
  - ▶▶ 2F8/IRQ3 Enable onboard Serial port 2 and address is 2F8. (Default value)
  - ▶▶ 3E8/IRQ4 Enable onboard Serial port 2 and address is 3E8.
  - ▶▶ 2E8/IRQ3 Enable onboard Serial port 2 and address is 2E8.
  - ▶▶ Disabled Disable onboard Serial port 2.
- ☞ **Onboard Parallel Port**
  - ▶▶ 378/IRQ7 Enable onboard LPT port and address is 378/IRQ7. (Default value)
  - ▶▶ 278/IRQ5 Enable onboard LPT port and address is 278/IRQ5.
  - ▶▶ Disabled Disable onboard LPT port.
  - ▶▶ 3BC/IRQ7 Enable onboard LPT port and address is 3BC/IRQ7.
- ☞ **Parallel Port Mode**
  - ▶▶ SPP Using Parallel port as Standard Parallel Port. (Default value)
  - ▶▶ EPP Using Parallel port as Enhanced Parallel Port.
  - ▶▶ ECP Using Parallel port as Extended Capabilities Port.
  - ▶▶ ECP+EPP Using Parallel port as ECP & EPP mode.
- ☞ **ECP Mode Use DMA**
  - ▶▶ 3 Set ECP Mode Use DMA to 3. (Default value)
  - ▶▶ 1 Set ECP Mode Use DMA to 1.
- ☞ **Game Port Address**
  - ▶▶ 201 Set Game Port Address to 201. (Default value)
  - ▶▶ 209 Set Game Port Address to 209.
  - ▶▶ Disabled Disable this function.

☞ **Midi Port Address**

- ▶▶ 300 Set Midi Port Address to 300.
- ▶▶ 330 Set Midi Port Address to 330.
- ▶▶ Disabled Disable this function. (Default value)

☞ **Midi Port IRQ**

- ▶▶ 5 Set Midi Port IRQ to 5.
- ▶▶ 10 Set Midi Port IRQ to 10. (Default value)

☞ **CIR Port Address**

- ▶▶ 310 Set CIR Port Address to 310.
- ▶▶ 320 Set CIR Port Address to 320.
- ▶▶ Disabled Disable this function. (Default value)

☞ **CIR Port IRQ**

- ▶▶ 5 Set CIR Port IRQ to 5.
- ▶▶ 11 Set CIR Port IRQ to 11. (Default value)

☞ **IDE DMA transfer access**

- ▶▶ Enabled Enable IDE DMA transfer access. (Default value)
- ▶▶ Disabled Disable this function.

# Power Management Setup

CMOS Setup Utility-Copyright (C) 1984-2004 Award Software  
Power Management Setup

		Item Help
ACPI Suspend Type	[S1(POS)]	Menu Level▶
Soft-Off by PWR-BTTN	[Instant-Off]	
PME Event Wake Up	[Disabled]	
Modem Ring On	[Disabled]	[S1]
S3 Resume by USB device	[Disabled]	Set suspend type to
Resume by Alarm	[Disabled]	Power On Suspend under
x Day of Month Alarm	Everyday	ACPI OS
x Time (hh:mm:ss) Alarm	0 : 0 : 0	
Power On by Mouse	[Disabled]	[S3]
Power On by Keyboard	[Disabled]	Set suspend type to
x KB Power ON Password	Enter	Suspend to RAM under
AC BACK Function	[Soft-Off]	ACPI OS

↑↓→←: Move    Enter: Select    +/-/PU/PD: Value    F10: Save    ESC: Exit    F1: General Help  
F5: Previous Values    F6: Fail-Safe Default    F7: Optimized Defaults

## ACPI Suspend Type

- ▶▶ S1(POS)      Set ACPI suspend type to S1/POS (Power On Suspend). (Default value)
- ▶▶ S3(STR)      Set ACPI suspend type to S3/STR (Suspend To RAM).

## Soft-Off by PWR-BTTN

- ▶▶ Instant-off      Press power button then power off instantly. (Default value)
- ▶▶ Delay 4 Sec.      Press power button 4 seconds to power off. Enter suspend if button is pressed less than 4 seconds.

## PME Event Wake Up

This feature requires an ATX power supply that provides at least 1A on the 5VSB lead.

- ▶▶ Disabled      Disable this function. (Default value)
- ▶▶ Enabled      Enable PME as wake up event.

## Modem Ring On

An incoming call via modem can awake the system from any suspend state.

- ▶▶ Disabled      Disable Modem Ring on function. (Default value)
- ▶▶ Enabled      Enable Modem Ring on function.

## S3 Resume by USB device

- ▶▶ Disabled      Disable this function. (Default value)
- ▶▶ Enable      Enable USB device wake up system from S3 suspend type.

## Resume by Alarm

You can set "Resume by Alarm" item at "Enabled" and key in data/time to power on system.

- ▶▶ Disabled      Disable this function. (Default value)
- ▶▶ Enabled      Enable alarm function to POWER ON system.

If RTC Alarm Lead To Power On is Enabled.

Day of Month Alarm :      Everyday, 1~31

Time (hh: mm: ss) Alarm :      (0~23) : (0~59) : (0~59)

☞ **Power On by Mouse**

- ▶▶ Disabled            Disabled this function. (Default value)
- ▶▶ Double Click        Double click on PS/2 mouse left button to power on system.

☞ **Power On by Keyboard**

- ▶▶ Disabled            Disabled this function. (Default value)
- ▶▶ Password            Enter from 1 to 5 characters to set the keyboard power on password.
- ▶▶ Keyboard 98        If there is a "POWER" button on your keyboard, you can press the key to power on your system.

☞ **KB Power ON Password**

When "Power On by Keyboard" set at Password, you can set the password here.

- ▶▶ Enter                Input password(from 1 to 5 characters) and press Enter to set the password.

☞ **AC BACK Function**

- ▶▶ Soft-Off            Always in off state when AC back. (Default value)
- ▶▶ Full-On             Always power on the system when AC back.

## PnP/PCI Configurations

CMOS Setup Utility-Copyright (C) 1984-2004 Award Software  
PnP/PCI Configurations

PCI 3 IRQ Assignment	[Auto]	Item Help
PCI 4 IRQ Assignment	[Auto]	Menu Level▶
PCI 1/5 IRQ Assignment	[Auto]	Device(s) using this INT:
PCI 2 IRQ Assignment	[Auto]	RAID Cntrlr - Bus 2 Dev12 Func 0

↑↓→←: Move    Enter: Select    +/-/PU/PD: Value    F10: Save    ESC: Exit    F1: General Help  
F5: Previous Values    F6: Fail-Safe Default    F7: Optimized Defaults

### PCI 3 IRQ Assignment

- ▶ Auto    Auto assign IRQ to PCI 3. (Default value)
- ▶ 3,4,5,7,9,10,11,12,14,15    Set IRQ 3,4,5,7,9,10,11,12,14,15 to PCI 3.

### PCI 4 IRQ Assignment

- ▶ Auto    Auto assign IRQ to PCI 4. (Default value)
- ▶ 3,4,5,7,9,10,11,12,14,15    Set IRQ 3,4,5,7,9,10,11,12,14,15 to PCI 4.

### PCI 1/5 IRQ Assignment

- ▶ Auto    Auto assign IRQ to PCI 1/5. (Default value)
- ▶ 3,4,5,7,9,10,11,12,14,15    Set IRQ 3,4,5,7,9,10,11,12,14,15 to PCI 1/PCI5.

### PCI 2 IRQ Assignment

- ▶ Auto    Auto assign IRQ to PCI 2. (Default value)
- ▶ 3,4,5,7,9,10,11,12,14,15    Set IRQ 3,4,5,7,9,10,11,12,14,15 to PCI 2.



## PC Health Status

CMOS Setup Utility-Copyright (C) 1984-2004 Award Software		Item Help
PC Health Status		Menu Level▶
Vcore	OK	
DDR25V	OK	
+3.3V	OK	
+12V	OK	
Current CPU Temperature	51°C	
Current CPU FAN Speed	3125 RPM	
Current POWER FAN Speed	0 RPM	
Current SYSTEM FAN Speed	0 RPM	
CPU Warning Temperature	[Disabled]	
CPU FAN Fail Warning	[Disabled]	
POWER FAN Fail Warning	[Disabled]	
SYSTEM FAN Fail Warning	[Disabled]	
CPU Smart FAN Control	[Enabled]	

↑↓→←: Move    Enter: Select    +/-/PU/PD: Value    F10: Save    ESC: Exit    F1: General Help  
 F5: Previous Values    F6: Fail-Safe Default    F7: Optimized Defaults

### ⌘ Current Voltage (V) Vcore / DDR25V / +3.3V / +12V

▶▶ Detect system's voltage status automatically.

### ⌘ Current CPU Temperature

▶▶ Detect CPU temperature automatically.

### ⌘ Current CPU/POWER/SYSTEM FAN Speed (RPM)

▶▶ Detect CPU/power/system fan speed status automatically.

### ⌘ CPU Warning Temperature

- ▶▶ Disabled      Don't monitor current temperature. (Default value)
- ▶▶ 60°C / 140°F      Monitor CPU temperature at 60°C / 140°F.
- ▶▶ 70°C / 158°F      Monitor CPU temperature at 70°C / 158°F.
- ▶▶ 80°C / 176°F      Monitor CPU temperature at 80°C / 176°F.
- ▶▶ 90°C / 194°F      Monitor CPU temperature at 90°C / 194°F.

### ⌘ CPU/POWER/SYSTEM FAN Fail Warning

- ▶▶ Disabled      Disable fan fail warning function. (Default value)
- ▶▶ Enabled      Enable fan fail warning function.

### ⌘ CPU Smart FAN Control

- ▶▶ Disabled      Disable this function.
- ▶▶ Enabled      Enable CPU Smart Fan control function. (Default value)
  - a. When the CPU temperature is higher than 60 degrees Celsius, CPU fan will run at full speed.
  - b. When the CPU temperature is between 50 and 60 degrees Celsius, CPU fan will run at high speed.
  - c. When the CPU temperature is between 40 and 50 degrees Celsius, CPU fan will run at medium speed.
  - d. When the CPU temperature is lower than 40 degrees Celsius, CPU fan will run at low speed.

## Frequency/Voltage Control

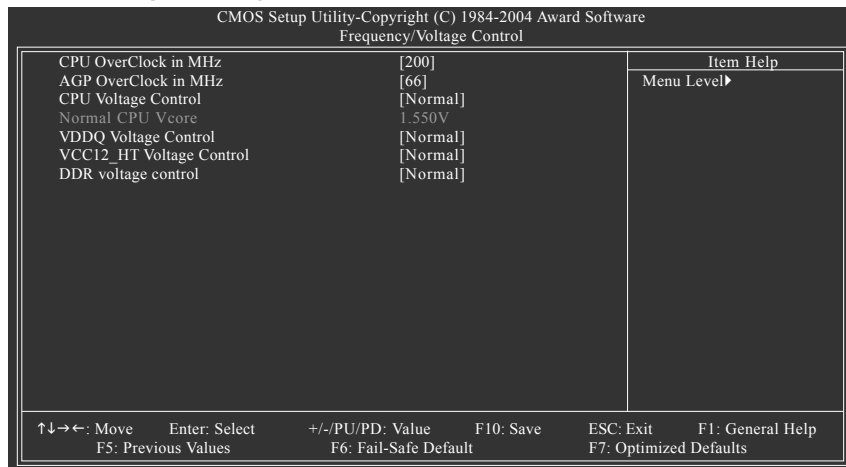

Incorrect using these features may cause your system broken. For power End-User use only!

- ☞ **CPU OverClock in MHz**
  - ▶▶ 200MHz ~ 300MHz    Increase CPU frequency as user selected.
- ☞ **AGP OverClock in MHz**
  - ▶▶ 66MHz ~ 100MHz    Increase AGP frequency as user selected.
- ☞ **CPU Voltage Control**
  - ▶▶ Supports adjustable CPU Vcore from 0.800V to 1.700V by 0.025V step.  
(Default value: Normal)
- ☞ **Normal CPU Vcore**
  - ▶▶ Display your CPU Vcore voltage.
- ☞ **VDDQ Voltage Control**
  - ▶▶ Normal    Set VDDQ voltage as VDDQ required. (Default value)
  - ▶▶ +0.1V    Increase VDDQ voltage +0.1V.
  - ▶▶ +0.2V    Increase VDDQ voltage +0.2V.
  - ▶▶ +0.3V    Increase VDDQ voltage +0.3V.
- ☞ **VCC12\_HT Voltage Control**
  - ▶▶ Normal    Supply VCC12\_HT voltage as VCC12\_HT required. (Default value)
  - ▶▶ +0.1V    Increase VCC12\_HT voltage +0.1V.
  - ▶▶ +0.2V    Increase VCC12\_HT voltage +0.2V.
  - ▶▶ +0.3V    Increase VCC12\_HT voltage +0.3V.
- ☞ **DDR voltage control**
  - ▶▶ Normal    Supply DDR voltage as DDR required. (Default value)
  - ▶▶ +0.1V    Increase DDR voltage +0.1V.
  - ▶▶ +0.2V    Increase DDR voltage +0.2V.

## Top Performance

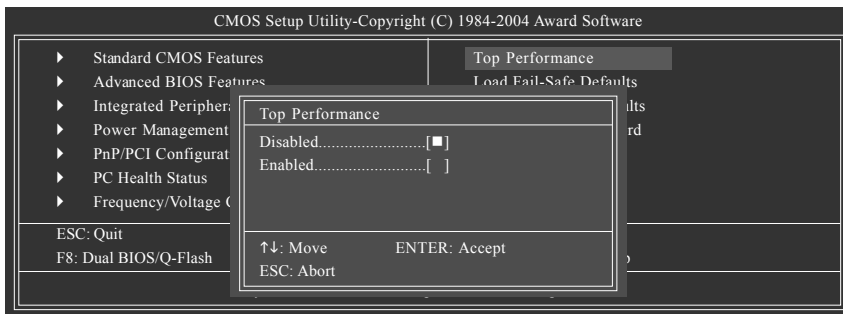

If you wish to maximize the performance of your system, set "Top Performance" as "Enabled".

▶▶ Disabled Disable this function. (Default Value)

▶▶ Enabled Enable Top Performance function.

●\* "Top Performance" will increase H/W working speed. Different system configuration (both H/W component and OS) will effect the result. For example, the same H/W configuration might not run properly with Windows XP, but works smoothly with Windows NT. Therefore, if your system is not perform enough, the reliability or stability problem will appear sometimes, and we will recommend you disabling the option to avoid the problem as mentioned above.

## Load Fail-Safe Defaults

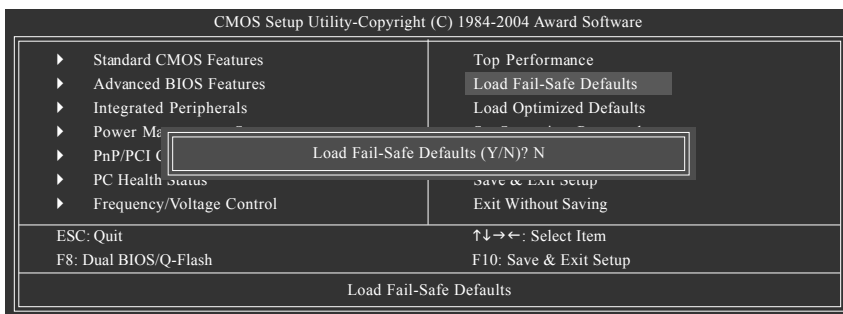

Fail-Safe defaults contain the most appropriate values of the system parameters that allow minimum system performance.

## Load Optimized Defaults

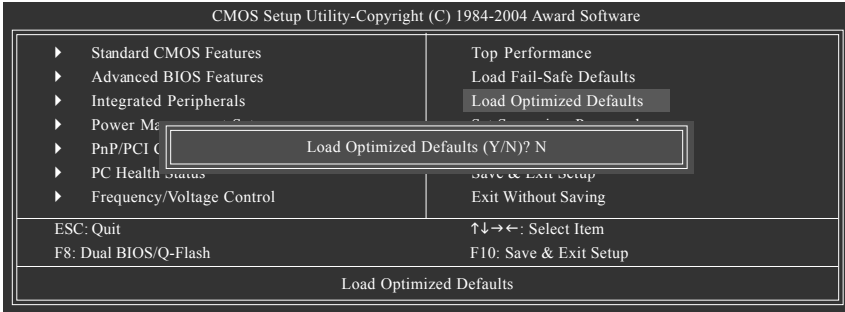

Selecting this field loads the factory defaults for BIOS and Chipset Features which the system automatically detects.

## Set Supervisor/User Password

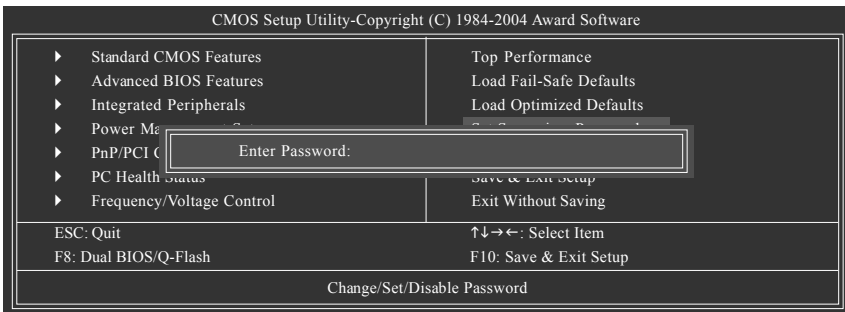

When you select this function, the following message will appear at the center of the screen to assist you in creating a password.

Type the password, up to eight characters, and press <Enter>. You will be asked to confirm the password. Type the password again and press <Enter>. You may also press <Esc> to abort the selection and not enter a password.

To disable password, just press <Enter> when you are prompted to enter password. A message "PASSWORD DISABLED" will appear to confirm the password being disabled. Once the password is disabled, the system will boot and you can enter Setup freely.

The BIOS Setup program allows you to specify two separate passwords: SUPERVISOR PASSWORD and a USER PASSWORD. When disabled, anyone may access all BIOS Setup program function. When enabled, the Supervisor password is required for entering the BIOS Setup program and having full configuration fields, the User password is required to access only basic items.

If you select "System" at "Password Check" in Advance BIOS Features Menu, you will be prompted for the password every time the system is rebooted or any time you try to enter Setup Menu.

If you select "Setup" at "Password Check" in Advance BIOS Features Menu, you will be prompted only when you try to enter Setup.

## Save & Exit Setup

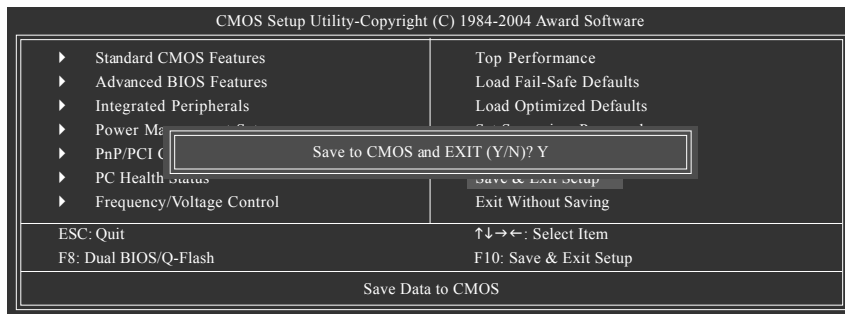

Type "Y" will quit the Setup Utility and save the user setup value to RTC CMOS.  
Type "N" will return to Setup Utility.

## Exit Without Saving

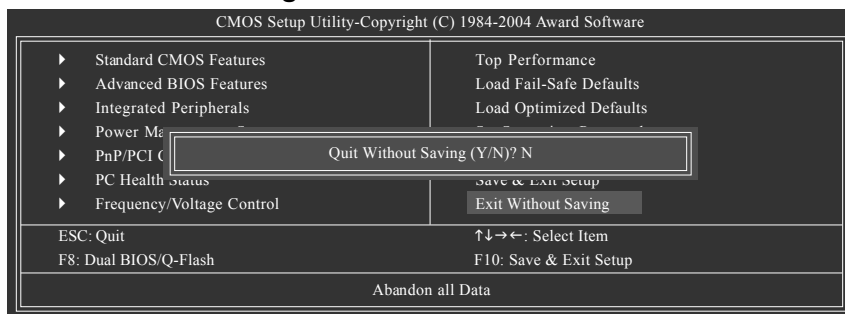

Type "Y" will quit the Setup Utility without saving to RTC CMOS.  
Type "N" will return to Setup Utility.



## Chapter 4 Technical Reference

### @BIOS™ Introduction

#### Gigabyte announces @BIOS Windows BIOS Live Update Utility



Have you ever updated BIOS by yourself? Or like many other people, you just know what BIOS is, but always hesitate to update it? Because you think updating newest BIOS is unnecessary and actually you don't know how to update it.

Maybe not like others, you are very experienced in BIOS updating and spend quite a lot of time to do it. But of course you don't like to do it too much. First, download different BIOS from website and then switch the operating system to DOS mode. Secondly, use different flash utility to update BIOS. The above process is not a interesting job. Besides, always be carefully to store the BIOS source code correctly in your disks as if you update the wrong BIOS, it will be a nightmare.

Certainly, you wonder why motherboard vendors could not just do something right to save your time and effort and save you from the lousy BIOS updating work? Here it comes! Now Gigabyte announces @BIOS - the first Windows BIOS live update utility. This is a smart BIOS update software. It could help you to download the BIOS from internet and update it. Not like the other BIOS update software, it's a Windows utility. With the help of "@BIOS", BIOS updating is no more than a click.

Besides, no matter which mainboard you are using, if it's a Gigabyte's product, @BIOS help you to maintain the BIOS. This utility could detect your correct mainboard model and help you to choose the BIOS accordingly. It then downloads the BIOS from the nearest Gigabyte ftp site automatically. There are several different choices; you could use "Internet Update" to download and update your BIOS directly. Or you may want to keep a backup for your current BIOS, just choose "Save Current BIOS" to save it first. You make a wise choice to use Gigabyte, and @BIOS update your BIOS smartly. You are now worry free from updating wrong BIOS, and capable to maintain and manage your BIOS easily. Again, Gigabyte's innovative product erects a milestone in motherboard industries.

For such a wonderful software, how much it costs? Impossible! It's free! Now, if you buy a Gigabyte's motherboard, you could find this amazing software in the attached driver CD. But please remember, connected to internet at first, then you could have a internet BIOS update from your Gigabyte @BIOS.

# Flash BIOS Method Introduction

## Method 1 : Dual BIOS / Q-Flash

### A. What is Dual BIOS Technology?

Dual BIOS means that there are two system BIOS (ROM) on the motherboard, one is the Main BIOS and the other is Backup BIOS. Under the normal circumstances, the system works on the Main BIOS. If the Main BIOS is corrupted or damaged, the Backup BIOS can take over while the system is powered on. This means that your PC will still be able to run stably as if nothing has happened in your BIOS.

### B. How to use Dual BIOS and Q-Flash Utility?

- 1.) After power on the computer, pressing <Del> immediately during POST (Power On Self Test) it will allow you to enter Award BIOS CMOS SETUP, then press <F8> to enter Flash utility.

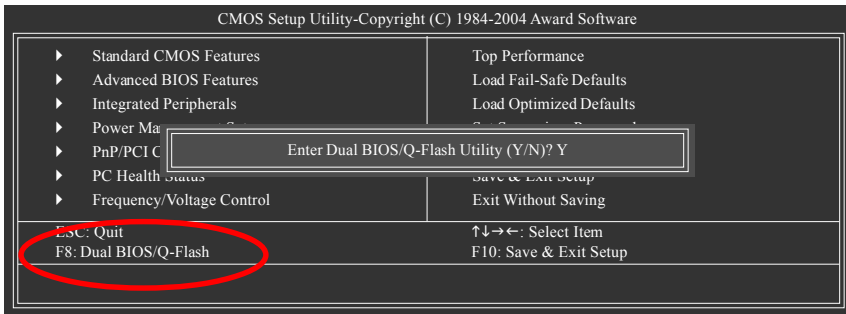

- 2.) Award Dual BIOS Flash ROM Programming Utility

Dual BIOS Utility V1.33		
Boot From.....	Main Bios	
Main ROM Type/Size.....	SST 39SF040	512K
Backup ROM Type/Size.....	SST 39SF040	512K
	Wide Range Protection	Disable
	Boot From	Main Bios
	Auto Recovery	Enable
	Halt On Error	Disable
	Keep DMI Data	Enable
	Copy Main ROM Data to Backup	
	Load Default Settings	
	Save Settings to CMOS	
Q-Flash Utility		
	Update Main BIOS from Floppy	
	Update Backup BIOS from Floppy	
	Save Main BIOS to Floppy	
	Save Backup BIOS to Floppy	
PgDn/PgUp: Modify	↑↓: Move	ESC: Reset F10: Power Off



3.) Dual BIOS Item explanation:

- **Wide Range Protection: Disable(Default), Enable**

Status 1:

If any failure (ex. Update ESCD failure, checksum error or reset...) occurs in the Main BIOS, just before the Operating System is loaded and after the power is on, and that the Wide Range Protection is set to "Enable", the PC will boot from Backup BIOS automatically.

Status 2:

If the ROM BIOS on peripherals cards(ex. SCSI Cards, LAN Cards...) emits signals to request restart of the system after the user make any alteration on it, the boot up BIOS will not be changed to the Backup BIOS.

- **Boot From : Main BIOS(Default), Backup BIOS**

Status 1: The user can set to boot from main BIOS or Backup BIOS.

Status 2: If one of the main BIOS or the Backup BIOS fails, this item "*Boot From : Main BIOS(Default)*" will become gray and will not be changed by user.

- **Auto Recovery : Enable(Default), Disable**

When one of the Main BIOS or Backup BIOS occurs checksum failure, the working BIOS will automatically recover the BIOS of checksum failure.

(In the Power Management Setup of the BIOS Setting, if ACPI Suspend Type is set to Suspend to RAM, the Auto Recovery will be set to Enable automatically.)

(If you want to enter the BIOS setting, please press "Del" key when the boot screen appears.)

- **Halt On Error : Disable(Default), Enable**

If the BIOS occurs a checksum error or the Main BIOS occurs a WIDE RANGE PROTECTION error and Halt On Error set to Enable, the PC will show messages on the boot screen, and the system will pause and wait for the user's instruction.

If Auto Recovery : **Disable**, it will show *<or the other key to continue.>*

If Auto Recovery : **Enable**, it will show *<or the other key to Auto Recover.>*

- **Keep DMI Data : Enable(Default), Disable**

Enable: The DMI data won't be replaced by flashing new BIOS. (recommend)

Disable: The DMI data will be replaced by flashing new BIOS.

- **Copy Main ROM Data to Backup**

(If you boot from Backup ROM, this item will change to "Copy Backup ROM Data to Main")

Auto recovery message:

**BIOS Recovery: Main to Backup**

The means that the Main BIOS works normally and could automatically recover the Backup BIOS.

**BIOS Recovery: Backup to Main**

The means that the Backup BIOS works normally and could automatically recover the Main BIOS. (This auto recovery utility is set by system automatically and can't be changed by user.)

- **Load Default Settings**

Load dual BIOS default value.

- **Save Settings to CMOS**

Save revised setting.

## C. What is Q-Flash Utility?

Q-Flash utility is a pre-O.S. BIOS flash utility enables users to update its BIOS within BIOS mode, no more fooling around any OS.

## D. How to use Q-Flash?

### Update Main BIOS from Floppy / Update Backup BIOS from Floppy

 In the A: drive, insert the "BIOS" diskette, then Press Enter to Run.

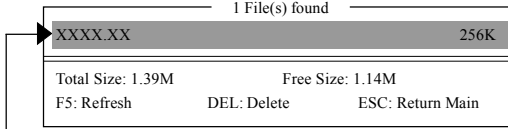

Where XXXX.XX is name of the BIOS file.

 Press Enter to Run.

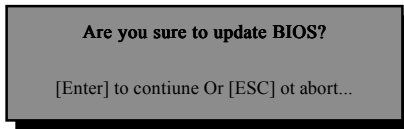

 Press Enter to Run.

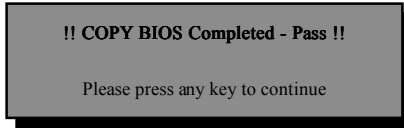

Congratulation! You have completed the flashed and now can restart system.

### Save Main BIOS to Floppy / Save Backup BIOS to Floppy

 In the A:drive, insert the floppy disk, then Press Enter to Run.

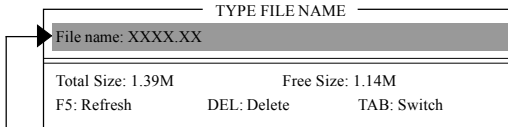

To name the file.

Congratulate you have accomplished the saving.

## CONTROL KEYS

<PgDn/PgUp>	Make changes
<↑>	Move to previous item
<↓>	Move to next item
<Enter>	Run
<Esc>	Reset
<F10>	Power Off



## DualBIOS™ Technology FAQ

GIGABYTE Technology is pleased to introduce DualBIOS technology, a hot spare for your system BIOS. This newest "Value-added" feature, in a long series of innovations from GIGABYTE, is available on this motherboard. Future GIGABYTE motherboards will also incorporate this innovation.

### What's DualBIOS™?

On GIGABYTE motherboards with DualBIOS there are physically two BIOS chips. For simplicity we'll call one your "Main BIOS" and the other we'll call your "Backup BIOS" (your "hot spare"). If your Main BIOS fails, the Backup BIOS almost automatically takes over on your next system boot. Almost automatically and with virtually zero down time! Whether the problem is a failure in flashing your BIOS or a virus or a catastrophic failure of the Main BIOS chip, the result is the same - the Backup BIOS backs you up, almost automatically.

### I. Q: What is DualBIOS™ technology?

#### Answer:

DualBIOS technology is a patented technology from Giga-Byte Technology. The concept of this technology is based on the redundancy and fault tolerance theory. DualBIOS™ technology simply means there are two system BIOSes (ROM) integrated onto the motherboard. One is a main BIOS, and the other is a backup BIOS. The mainboard will operate normally with the main BIOS, however, if the main BIOS is corrupt or damaged for various reasons, the backup BIOS will be automatically used when the system powered-On. Your PC will operate as before the main BIOS was damaged, and is completely transparent to the user.

### II. Q: Why does anyone need a motherboard with DualBIOS™ technology?

#### Answer:

In today's systems there are more and more BIOS failures. The most common reasons are virus attacks, BIOS upgrade failures, and/or deterioration of the BIOS (ROM) chip itself.

1. New computer viruses are being found that attack and destroy the system BIOS. They may corrupt your BIOS code, causing your PC to be unstable or even not boot normally.
2. BIOS data will be corrupted if a power loss/surge occurs, or if a user resets the system, or if the power button is pressed during the process of performing a system BIOS upgrade.
3. If a user mistakenly updates their mainboard with the incorrect BIOS file, then the system may not be able to boot correctly. This may cause the PC system hang in operation or during boot.
4. A flash ROM's life cycle is limited according to electronic characteristics. The modern PC utilizes the Plug and Play BIOS, and is updated regularly. If a user changes peripherals often, there is a slight chance of damage to the flash ROM.

With Giga-Byte Technology's patented DualBIOS™ technology you can reduce the possibility of hangs during system boot up, and/or loss BIOS data due to above reasons.

This new technology will eliminate valuable system down time and costly repair bills cause by BIOS failures.

### III. Q: How does DualBIOS™ technology work?

#### Answer:

This new technology will eliminate valuable system down time and costly repair bills cause by BIOS failures.

1. DualBIOS™ technology provides a wide range of protection during the boot up procedure. It protects your BIOS during system POST, ESCD update, and even all the way to PNP detection/assignment.
2. DualBIOS™ provides automatic recovery for the BIOS. When the first BIOS used during boot up does not complete or if a BIOS checksum error occurs, boot-up is still possible. In the DualBIOS™ utility, the "Auto Recovery" option will guarantee that if either the main BIOS or backup BIOS is corrupted, the DualBIOS™ technology will use the good BIOS and correct the wrong BIOS automatically.
3. DualBIOS™ provides manual recovery for the BIOS. DualBIOS™ technology contains a built-in flash utility, which can flash your system BIOS from backup to main and/or visa versa. There is no need for an OS-dependent flash utility program.
4. DualBIOS™ contains a one-way flash utility. The built-in one-way flash utility will ensure that the corrupt BIOS is not mistaken as the good BIOS during recovery and that the correct BIOS (main vs. backup) will be flashed. This will prevent the good BIOS from being flashed.

### IV. Q: Who Needs DualBIOS™ technology?

#### Answer:

This new technology will eliminate valuable system down time and costly repair bills cause by BIOS failures.

1. Every user should have DualBIOS™ technology due to the advancement of computer viruses. Everyday, there are new BIOS-type viruses discovered that will destroy your system BIOS. Most commercial products on the market do not have solutions to guard against this type of virus intrusion. The DualBIOS™ technology will provide a state-of-the-art solution to protect your PC:

Case I.) Vicious computer viruses may wipe out your entire system BIOS. With a conventional single system BIOS PC, the PC will not be functional until it is sent for repairs.

Case II.) If the "Auto Recovery" option is enabled in the DualBIOS™ utility, and if a virus corrupts your system BIOS, the backup BIOS will automatically reboot the system and correct the main BIOS.

Case III.) A user may override booting from the main system BIOS. The DualBIOS™ utility may be entered to manually change the boot sequence to boot from the backup BIOS.

2. During or after a BIOS upgrade, if DualBIOS™ detects that the main BIOS is corrupt, the backup BIOS will take over the boot-up process automatically. Moreover, it will verify the main and backup BIOS checksums when booting-up. DualBIOS™ technology examines the checksum of the main and backup BIOS while the system is powered on to guarantee your BIOS operates properly.
3. Power Users will have the advantage of having two BIOS versions on their motherboard. The benefit is being able to select either version BIOS to suit the performance system needs.
4. Flexibility for high-end desktop PCs and workstation/servers. In the DualBIOS™ utility, the option can be set, "Halt On When BIOS Defects" to be enabled to halt your system with awarning message that the main BIOS has been corrupted. Most workstation/servers require constant operation to guarantee services have not been interrupted. In this situation, the "Halt On When BIOS Defects" message may be disabled to avoid system pauses during normal booting. Another advantage you gain from Giga-Byte's DualBIOS™ technology is the ability to upgrade from dual 2 Mbit BIOS to dual 4 Mbit BIOS in the future if extra BIOS storage is need.

## Method 2 : @BIOS™ Utility

If you don't have DOS boot disk, we recommend that you used Gigabyte @BIOS™ program to flash BIOS.



(1)

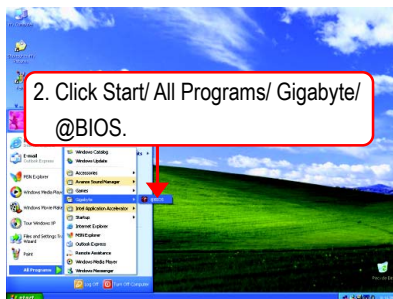

(2)

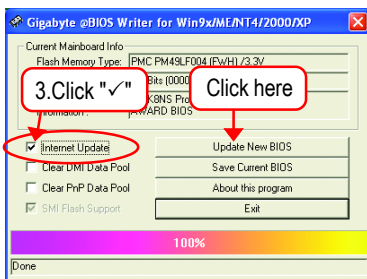

(3)

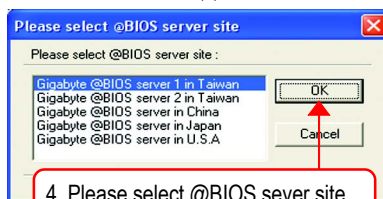

(4)

### Methods and steps:

1. Update BIOS through Internet:
  - a. Click "Internet Update" icon
  - b. Click "Update New BIOS" icon
  - c. Select @BIOS™ sever
  - d. Select the exact model name on your motherboard
  - e. System will automatically download and update the BIOS.
2. Update BIOS NOT through Internet:
  - a. Do not click "Internet Update" icon
  - b. Click "Update New BIOS"
  - c. Please select "All Files" in dialog box while opening the old file.
  - d. Please search for BIOS unzip file, downloading from internet or any other methods.  
(such as: K8NSP.E11).
  - e. Complete update process following the instruction.

### 3. Save BIOS

In the very beginning, there is "Save Current BIOS" icon shown in dialog box. It means to save the current BIOS version.

### 4. Check out supported motherboard and Flash ROM:

In the very beginning, there is "About this program" icon shown in dialog box. It can help you check out which kind of motherboard and which brand of Flash ROM are supported.

#### **Note:**

- a. In method I, if it shows two or more motherboard's model names to be selected, please make sure your motherboard's model name again. Selecting wrong model name will cause the system unbooted.
- b. In method II, be sure that motherboard's model name in BIOS unzip file are the same as your motherboard's. Otherwise, your system won't boot.
- c. In method I, if the BIOS file you need cannot be found in @BIOS™ server, please go onto Gigabyte's web site for downloading and updating it according to method II.
- d. Please note that any interruption during updating will cause system unbooted.
- e. Do not use @BIOS and C.O.M. (Corporate Online Management) at the same time.

The installation of audio software for Windows 2000/ XP is very simple. Follow the steps to install the function. (Following pictures are in Windows XP). Please note that if you want to set up an 8 channel audio configuration, you must use Audio Combo Kit (optional device).

### Stereo Speakers Connection and Settings:

We recommend that you use the speaker with amplifier to acquire the best sound effect if the stereo output is applied.

#### STEP 1:

Connect the stereo speakers or earphone to "Line Out".



Line Out

#### STEP 2 :

Following installation of the audio driver, you'll find an icon a Sound Effect  icon on the lower right hand taskbar. Click the icon to select the function.



#### STEP 3:

Click "Speaker Configuration" then click on the left selection bar and select "2CH Speaker" to complete 2 channel audio configuration.

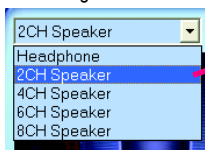

## 4 Channel Analog Audio Output Mode

STEP 1 :

Connect the front channels to "Line Out", the rear channels to "Line In".



Line Out Line In

STEP 2 :

Following installation of the audio driver, you'll find an icon a Sound Effect  icon on the lower right hand taskbar. Click the icon to select the function.

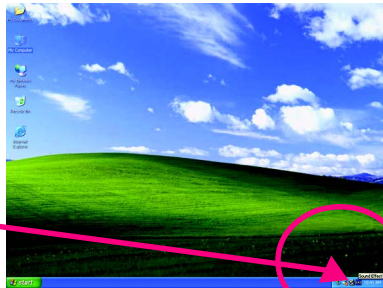

STEP 3 :

Click "Speaker Configuration" and select the "UAJ Function". Then click on the left selection bar and select "4CH Speaker" to complete 4 channel audio configuration.

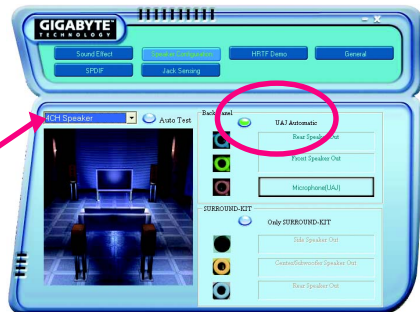



## 6 Channel Analog Audio Output Mode

Use the back audio panel to connect the audio output without any additional module.

STEP 1 :

Connect the front channels to "Line Out", the rear channels to "Line In", and the Center/Subwoofer channels to "MIC In".

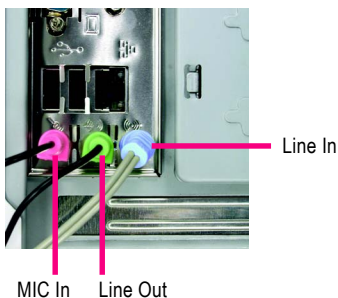

STEP 2 :

Following installation of the audio driver, you'll find an icon a Sound Effect icon on the lower right taskbar. Click the icon to select the function.

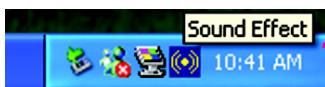

STEP 3 :

Click "Speaker Configuration" and select the "UAJ Function". Then click on the left selection bar and select "6CH Speaker" to complete 6 channel audio configuration.

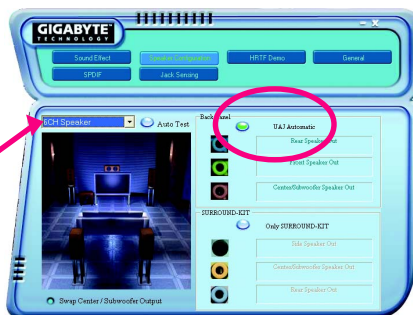

## 8 Channel Audio Setup (requires Audio Combo Kit, optional device) :

Audio Combo Kit includes a Surround-Kit and a SPDIF output cable (an optical and coaxial cable). If you want to set up an 8 channel configuration, you need to use the Surround-Kit. The Surround-Kit offers R/L surround, center/subwoofer output and rear surround.



### STEP 1 :

Secure the Audio Combo Kit at the panel on the back of the case.



### STEP 2 :

Connect the Surround-Kit to the SUR\_CEN connector located on the motherboard.

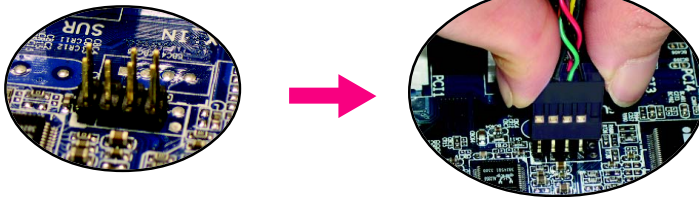

### STEP 3 :

There are two methods of 8 channel audio configuration:

#### Method 1:

Connect the front channels to the "LINE OUT" port located on the audio panel and the rear channels to the Surround-Kit "REAR R/L" port. Connect the center/subwoofer channels to the Surround-Kit "SUB CENTER" and the R/L channels to the Surround-Kit "SUR BACK" port.

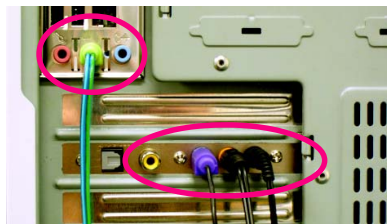

Method 2:

Connect the front channels to the "LINE OUT" port located on the audio panel and the rear channels to the "LINE IN" port. Connect the center/subwoofer channels to the "MIC IN" port located on the audio panel and the R/L channels to the Surround-Kit "SUR BACK" port. (This method requires UAJ function)

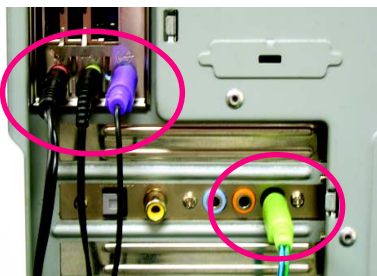

STEP 4 :

Following installation of the audio driver, you'll find an icon a Sound Effect  icon on the lower right hand taskbar. Click the icon to select the function.



STEP 5 :

Click "Speaker Configuration" and select both the "UAJ Function" and "Only Surround-Kit". Then click on the left selection bar and select "8CH Speaker" to complete 8 channel audio configuration.

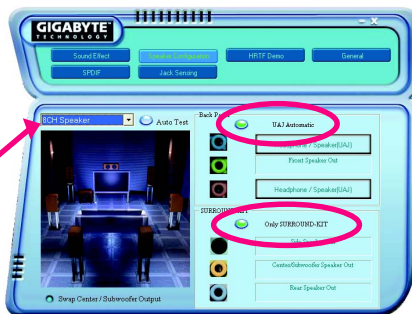

Sound Effect Configuration:

At the sound effect menu, users can adjust sound option settings as desired.



## SPDIF Output Device (Optional Device)

A "SPDIF output" connector is available on the motherboard. Cable with rear bracket could link to the "SPDIF output" connector (As picture.) For the further linkage to decoder, rear bracket provides coaxial cable and Fiber connecting port <sup>(Note)</sup>.



1. Connect the SPDIF output device to the rear bracket of PC, and fix it with screw.

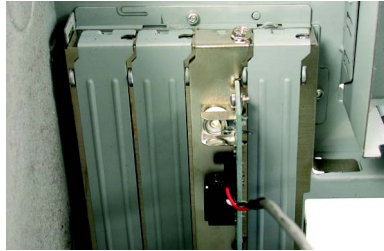

2. Connect SPDIF device to the motherboard.

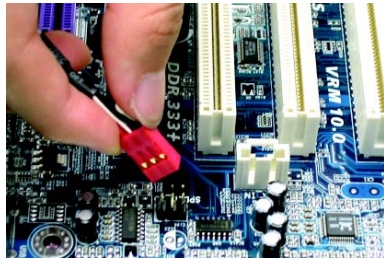

3. Connect SPDIF to the SPDIF decoder.

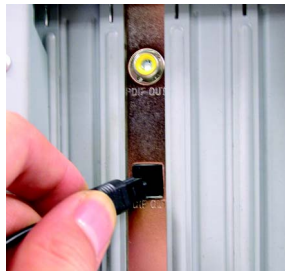

(Note) If you want to use both of the 8 channel audio function and SPDIF out function, you may buy the Audio Combo Kit (refer to the 8 channel Audio Setup section).

## Jack-Sensing and UAJ Introduction

Jack-Sensing provides audio connectors error-detection function.



Install Microsoft DirectX8.1 or later version before to enable Jack-Sensing support for Windows 2000.

Jack-Sensing includes 2 parts: AUTO and MANUAL. Following pictures are in Windows XP:

### Introduction of audio connectors

You may connect CDROM, Walkman or others audio input devices to Line In jack, speakers, earphone or others output devices to Line Out jack, and microphone to MIC In jack.

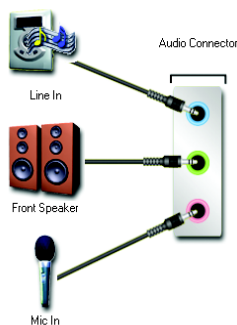

### Auto-detecting:

Please connect the devices to the right jacks as above. A window will appear as right picture if you setup the devices properly.

Please note that 3D audio function will only appear when 3D audio inputs.



If you set wrong with the connectors, the warning message will come out as right picture.

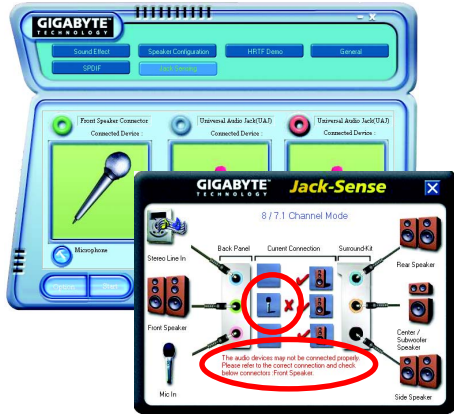

**Manual setting:**

If the device picture shows different from what you set, please press "Manual Selection" to set.

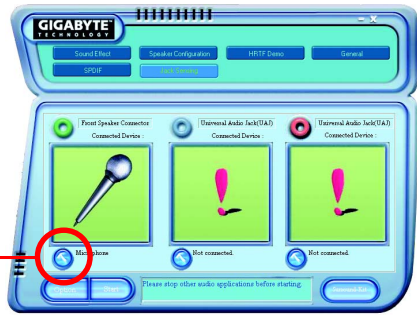
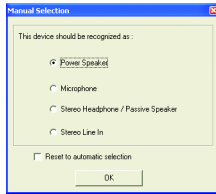

**UAJ Introduction**

UAJ (Universal Audio Jack) has a very smart feature: It will switch signal automatically when user plugs his audio device to the wrong jack (Line-in/ Line-out). That means users do not need to worry the audio device should be plug in Line-in or Line-out jack, the device will work perfectly after UAJ is activated.

**Enable UAJ function:**

You can click "UAJ Automatic" button to enable UAJ function.

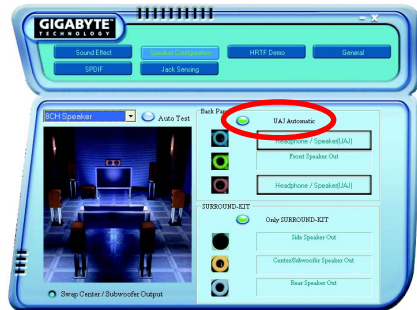

# Xpress Recovery Introduction

## What is Xpress Recovery ?

Xpress Recovery is a utility used to back up and restore an OS partition. If the hard drive is not working properly, the user can restore the drive to its original state.



1. Supports FAT16, FAT32, and NTFS formats
2. Must be connected to the IDE1 Master
3. Allows installation of only one OS
4. Must be used with an IDE hard disk supporting HPA
5. The first partition must be set as the boot partition. When the boot partition is backed up, please do not alter its size.
6. Xpress Recovery is recommended when using Ghost to return boot manager to NTFS format.

## How to use the Xpress Recovery

### 1. Boot from CD-ROM (BMP Mode)

Enter the BIOS menu, select "Advanced BIOS Feature" and set to boot from CD-ROM. Insert the provided driver CD into your CD drive, then save and exit the BIOS menu. Once the computer has restarted, the phrase "Boot from CD:" will appear at the bottom left-hand corner of the screen. When "Boot from CD:" appears, press any key to enter Xpress Recovery. Once you have completed this step, subsequent access to Xpress Recovery can also function by pressing the F9 key during computer power on.

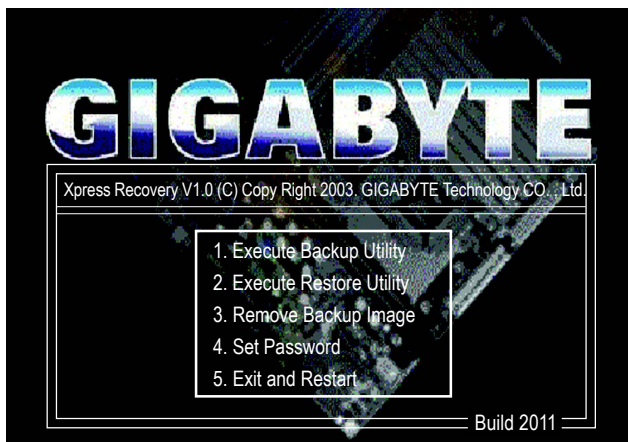

2. Press F9 during powering on the computer. (Text Mode)

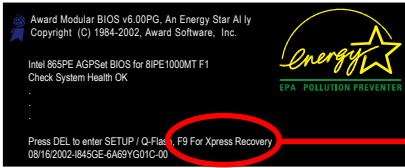

F9 For Xpress Recovery

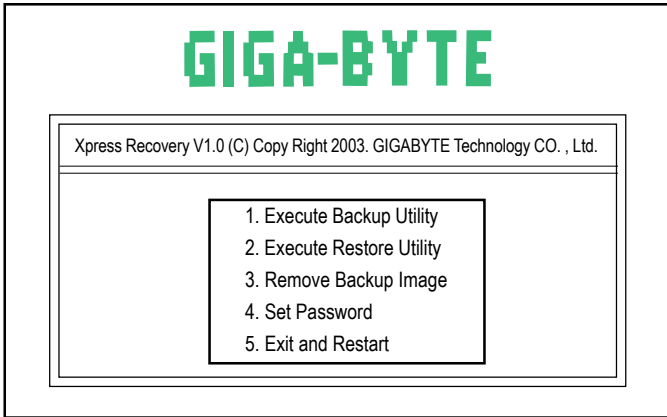

1. If you have already entered Xpress Recovery by booting from the CD-ROM, you can enter Xpress Recovery in the future by pressing the F9 key.
2. System storage capacity as well as drive reading/writing speed will affect backup speed.
3. It is recommended that Xpress Recovery be immediately installed after OS and all required driver and software installations are complete.



## 1. Execute Backup Utility:

### **Press B to Backup your System or Esc to Exit**

The backup utility will automatically scan your system and back up data as a backup image in your hard drive.



Not all systems support access to Xpress Recovery by pressing the F9 key during computer power on. If this is the case, please use the boot from CD-ROM method to enter Xpress Recovery.

## 2. Execute Restore Utility:

### **This program will recover your system to factory default.**

**Press R to restore your system back to factory default or press Esc to exit**

Restores backup image to original state.

## 3. Remove Backup Image:

### **Remove backup image. Are you sure? (Y/N)**

Remove the backup image.

## 4. Set Password:

### **Please input a 4-16 character long password (a-z or 0-9) or press Esc to exit**

You can set a password to enter Xpress Recovery to protect your hard disk data. Once this is done, password input will be required to enter Xpress Recovery during the next as well as subsequent system restarts. If you wish to remove the need for password entry, please select "Set Password" and under "New Password/Confirm Password", make sure there is no entry and then press "Enter" to remove password requirement.

## 5. Exit and Restart:

Exit and restart your computer.

# Serial ATA BIOS Setting Utility Introduction

## RAID Levels

RAID (Redundant Array of Independent Disks) is a method of combining two hard disk drives into one logical unit. The advantage of an Array is to provide better performance or data fault tolerance. Fault tolerance is achieved through data redundant operation, where if one drives fails, a mirrored copy of the data can be found on another drive. This can prevent data loss if the operating system fails or hangs. The individual disk drives in an array are called members. The configuration information of each member is recorded in the reserved sector that identifies the drive as a member. All disk members in a formed disk array are recognized as a single physical drive to the operating system.

Hard disk drives can be combined together through a few different methods. The different methods are referred to as different RAID levels. Different RAID levels represent different performance levels, security levels and implementation costs. The RAID levels which the nVIDIA nForce3 250 chipset supports are RAID 0, RAID 1, and JBOD.

### RAID 0 (Striping)

RAID 0 reads and writes sectors of data interleaved between multiple drives. If any disk member fails, it affects the entire array. The disk array data capacity is equal to the number of drive members times the capacity of the smallest member. The striping block size can be set from 4KB to 128KB. RAID 0 does not support fault tolerance.

### RAID 1 (Mirroring)

RAID 1 writes duplicate data onto a pair of drives and reads both sets of data in parallel. If one of the mirrored drives suffers a mechanical failure or does not respond, the remaining drive will continue to function. Due to redundancy, the drive capacity of the array is the capacity of the smallest drive. Under a RAID 1 setup, an extra drive called the spare drive can be attached. Such a drive will be activated to replace a failed drive that is part of a mirrored array. Due to the fault tolerance, if any RAID 1 drive fails, data access will not be affected as long as there are other working drives in the array.

### JBOD (Spanning)

A spanning disk array is equal to the sum of the all drives when the drives used are having different capacities. Spanning stores data onto a drive until it is full, then proceeds to store files onto the next drive in the array. When any disk member fails, the failure affects the entire array. JBOD is not really a RAID and does not support fault tolerance.

## Please follow the steps below to construct a complete RAID array:

- 1) Have ready your hard drives for RAID construction.  
Note: To achieve best performance, it is recommended that the hard drives used are of similar make and storage capacity.
- 2) Please attach the hard drive connectors to their appropriate location on the motherboard ie. IDE, SCSI, or SATA.
- 3) Enter the motherboard BIOS and locate RAID setup (Please refer to the section on Integrated Peripherals).
- 4) Enter RAID setup in the BIOS and select the RAID type (For instance, enter F10 to select NVIDIA RAID; Ctrl + S to select Silicon Image).
- 5) Complete driver installation.
- 6) Complete RAID utility installation.

More information on steps 4 and 5 is provided. (For more detailed setup information, please visit our website at <http://www.gigabyte.com.tw>)

## Configuring the NVIDIA RAID BIOS

The NVRAID BIOS setup lets you choose the RAID array type and which hard drives you want to make part of the array.

### Entering the RAID BIOS Setup

1. After rebooting your computer, wait until you see the RAID software prompting you to press **F10**. The RAID prompt appears as part of the system POST and boot process prior to loading the OS. You have a few seconds to press F10 before the window disappears.

NVIDIA RAID IDE ROM BIOS 4.22  
Copyright (C) 2003 NVIDIA Corp.  
Detecting array ...  
Press F10 to enter RAID setup utility ...

2. Press F10.

The NVIDIA RAID Utility - **Define a New Array** window appears (as Figure below).

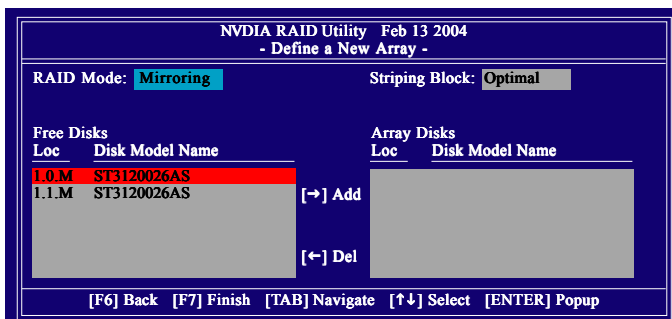

## Using the "Define a New Array" Window

If necessary, press the tab key to move from field to field until the appropriate field is highlighted.

### Selecting the RAID Mode

By default, this is set to Mirroring. To change to a different RAID mode, press the down arrow key until the mode that you want appears in the RAID Mode box - either Mirroring, Striping, or Spanning.

### Selecting the Striping Block Size

Striping block size is given in kilobytes, and affects how data is arranged on the disk. It is recommended to leave this value at the default Optimal, which is 32KB, but the values can be between 4 KB and 128 KB.

### Assigning the Disks

The disks that you enabled from the RAID Config BIOS setup page appear in the Free Disks block. These are the drives that are available for use as RAID array disks. To designate a free disk to be used as a RAID array disk,

1. Tab to the Free Disks section. The first disk in the list is selected.
2. Move it from the Free Disks block to the Array Disks block by pressing the rightarrow key (→). The first disk in the list is moved, and the next disk in the list is selected and ready to be moved.
3. Continue pressing the right-arrow key (→) until all the disks that you want to use as RAID array disks appear in the Array Disks block.

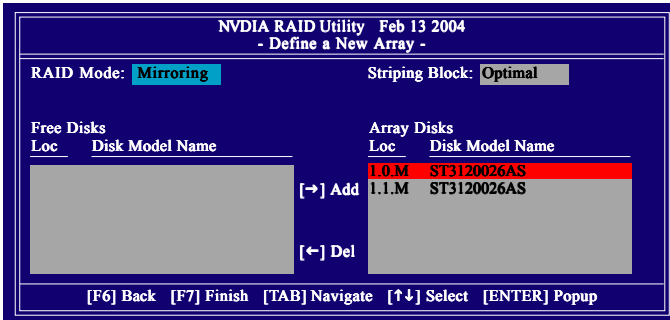

## Completing the RAID BIOS Setup

After assigning your RAID array disks, press F7. The **Clear disk data** prompt appears.

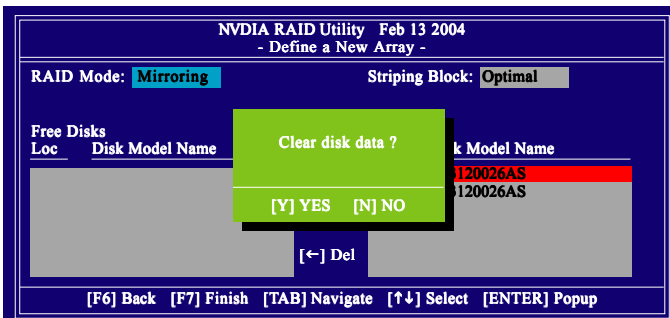

Press **Y** if you want to wipe out all the data from the RAID array, otherwise press **N**. You must choose **Yes** if the drives were previously used as RAID drives. The **Array List** window appears, where you can review the RAID arrays that you have set up.

You can select a disk array as boot device if you want to boot operating system from an array. Use the arrow keys to select the array, then press **B** to specify the array as bootable.

NVIDIA RAID Utility Feb 13 2004					
- Array List -					
Boot	Id	Status	Vendor	Array Model Name	
BBS	2	Health	NVIDIA	MIRROR	111.79G

[Ctrl-X] Exit [↑↓] Select [B] Set Boot [N] New Array [ENTER] Detail

Press **Enter** to view and verify details. The **Array Detail** screen appears.

The Array Detail screen shows various information about the array that you selected, such as Striping Block used, RAID Mode, Striping Width, Disk Model Name, and disk capacity.

Array 2 : NVIDIA MIRROR 111.79G					
- Array Detail -					
RAID Mode: Mirroring			Striping Block 32K		
Striping Width : 1					
Adapt	Channel	M/S	Index	Disk Model Name	Capacity
1	0	Master	0	ST3120026AS	111.79GB
1	1	Master	1	ST3120026AS	111.79GB

[R] Rebuild [D] Delete [C] Clear Disk [ENTER] Return

If you want to mark this disk as empty and wipe out all its contents, press **C**.

At the prompt, press **Y** to wipe out all the data, otherwise press **N**.

Press **Enter** again to go back to the previous screen and then press **Ctrl + X** to exit the RAID setup.

Now that the RAID setup has been configured from the RAID BIOS, the next step is to configure and load drivers under Windows.

## Installing the RAID drivers

To install operating system onto a serial ATA hard disk successfully, you need to install the SATA controller driver during OS installation. Without the driver, the hard disk may not be recognized during the Windows setup process. First of all, copy the driver for the SATA controller from the motherboard driver CD-ROM to a floppy disk. See the instructions below about how to copy the driver in MS-DOS mode<sup>(Note 1)</sup>. Prepare a startup disk that has CD-ROM support and a blank formatted floppy disk.

Step 1: Insert the prepared startup disk and motherboard driver CD-ROM in your system. Boot from the startup disk. Once at the A:\> prompt, change to the CD-ROM drive (example: D:\>). At the D:\> prompt, type the following two commands. Press ENTER after each command (Fig.1):

```
cd bootdrv
menu
```

Step 2: When the controller menu (Fig.2) appears, remove the startup disk and insert the blank formatted disk. Select the controller driver by pressing the corresponding letter from the menu. Your system will then automatically zip and transfer this driver file to the floppy disk. Press 0 to exit when finished.

```
10:08/2002 12:51 PM D:\000\32
06/25/2004 06:29 AM 94,208 DiskMgr1.dll
04/29/2005 09:43 AM <DIR> Drivers
06/24/2004 06:26 AM 2,704 HLLIBN_TBI
08/21/2002 03:11 AM 53,248 HURDDrv.DLL
02/03/2004 03:48 AM 21,294 ID.LOG
04/29/2005 09:46 AM <DIR> MS
04/29/2005 09:43 AM <DIR> Network
10/08/2002 12:51 PM 38,857 OMBSTDP_INF
04/29/2005 09:46 AM <DIR> Other
04/29/2005 09:46 AM <DIR> PDS\atl
04/29/2005 08:09 AM 4,602 Readme.txt
04/29/2005 08:42 AM 405,394 Setup.exe
02/11/2004 10:50 AM 2,613 TIP.INI
02/11/2005 10:27 AM 192,512 TestDrive
04/29/2005 09:46 AM <DIR> 13 Utility
02/20/2005 06:45 AM 13 UERR16.TIC
02/23/2005 03:01 AM 7,449 Xacd.txt
04/25/2005 11:17 AM 61,440 VCC.DLL
04/25/2005 11:17 AM 920,000 bytes
0 bytes free
B:\>cd bootdrv
B:\bootdrv>
```

Fig.1

```
02/23/2005 03:01 AM 7,449 Xacd.txt
04/25/2005 11:17 AM 61,440 VCC.DLL
19 File(s)
920,000 bytes
10 Dir(s)
0 bytes free
D:\>cd bootdrv
D:\bootdrv>
1) BootDrvMenu
2) IAA_RAID (ICH5R)
3) IAA_RAID
4) IAA_RAID
5) Promise 20276 ATA
6) Promise 20276 RAID
7) Promise 20265 ATA
8) Promise 20265 RAID
9) Promise 20265 RAID(CRP)
A) Promise 20265 RAID(CRP)
B) Promise 20265 RAID(CRP)
C) IAA_RAID Serial ATA
D) IAA_RAID Serial ATA(CRP)
E) IAA_RAID Serial ATA(CRP)
0) Exit
```

Fig. 2

Step 3: After completing the steps, boot from the Windows installation disk to install the RAID drivers. Press **F6** as soon as you see the "Press F6 if you need to install a third party SCSI or RAID driver" message, then supply serial ATA controller driver by this floppy disk. Follow the on-screen instructions to complete the installation.

(Each time you add a new hard drive to a RAID array, the RAID driver will have to be installed under Windows once for that hard drive. After that, the driver will not have to be installed.)



(Note 1) For users without a startup disk.

Use an alternative system and insert the GIGABYTE motherboard drive CD-ROM. From the CD-ROM drive (example: D:\) double click the **MENU.exe** file in the **BootDrv** folder. A command prompt window will open similar to that in Fig. 2.

(Note2) In the menu list, Intel IAA\_RAID is Intel ICH5R chipset.







# Chapter 5 Appendix

## Install Drivers





### Pictures below are shown in Windows XP

Insert the driver CD-title that came with your motherboard into your CD-ROM drive, the driver CD-title will auto start and show the installation guide. If not, please double click the CD-ROM device icon in "My computer", and execute the setup.exe.

### INSTALL CHIPSET DRIVER

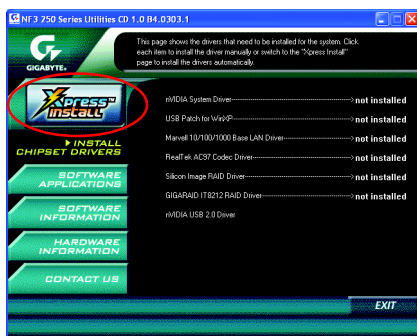
This page shows the drivers that need to be installed for the system. Click each item to install the driver manually or switch to the  page to install the drivers automatically.



The "Xpress Install" uses the "Click and Go" technology to install the drivers automatically. Just select the drivers you want then click the "GO" button. The  will execute the installation for you automatically.

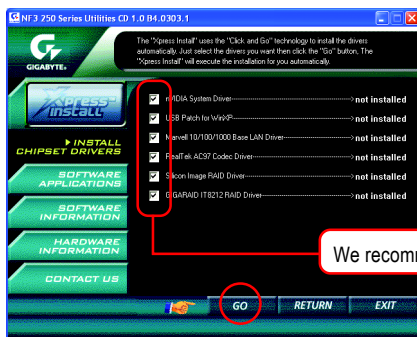

Message: Some device drivers will restart your system automatically. After restarting your system the "Xpress Install" will continue to install other drivers.

We recommend that you install all components in the list.

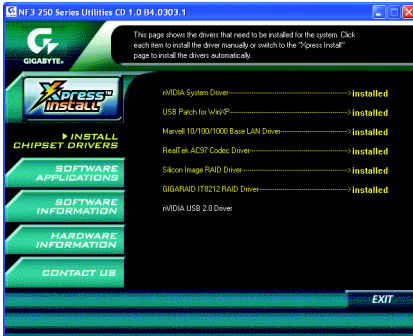

Driver installation finished !  
You have to reboot system !

## Item Description

- nVIDIA System Driver <sup>(Note)</sup>  
For nVIDIA chipset driver.
- USB Patch for WinXP  
This patch driver can help you to resolve the USB device wake up S3 hang up issue in XP.
- Marvell 10/100/1000 Base LAN Driver  
Marvell 10/100/1000 LAN chip driver.
- RealTek AC97 Codec Driver  
Realtek audio driver.
- Silicon Image RAID Driver  
Serial-ATA RAID driver for Silicon Image.
- GIGARAID IT8212 RAID Driver  
For ITE IT8212 RAID IDE controller.
- nVIDIA USB 2.0 Driver  
For nVIDIA USB 2.0 enhanced host controller.



*For USB2.0 driver support under Windows XP operating system, please use Windows Service Pack. After install Windows Service Pack, it will show a question mark "?" in "Universal Serial Bus controller" under "Device Manager". Please remove the question mark and restart the system (System will auto-detect the right USB2.0 driver).*

Note: If an Error message appears during the installation of the nVIDIA System Driver, ignore the message and continue on with driver installation.

## SOFTWARE APPLICATION

This page reveals the value-added software developed by Gigabyte and its worldwide partners.

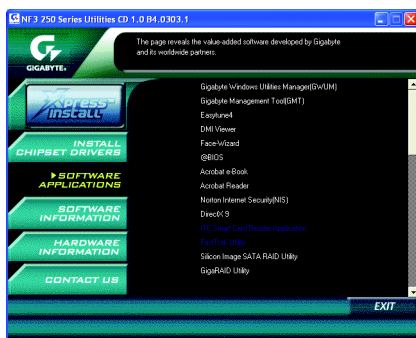

- Gigabyte Windows Utilities Manager (GWUM)  
This utility can integrate the Gigabyte's applications in the system tray.
- Gigabyte Management Tool (GMT)  
A useful tool which can manage the computer via the network.
- EasyTune 4  
Powerful utility that integrates the overclocking and hardware monitoring functions.
- DMI Viewer  
Windows based utility which is used to browse the DMI/SMBIOS information of the system.
- Face-Wizard  
New utility for adding BIOS logo.
- @BIOS  
Gigabyte windows flash BIOS utility.
- Acrobat e-Book  
Useful utility from Adobe.
- Acrobat Reader  
Popular utility from Adobe for reading .PDF file format documents.
- Norton Internet Security (NIS)  
Integrated utility which includes anti-virus, ads, etc.
- DirectX 9  
Install Microsoft DirectX 9 to enable 3D hardware acceleration that support for operating system to achieve better 3D performance.
- Silicon Image SATA RAID Utility  
RAID utility for Silicon Image Serial-ATA function.
- GigaRAID Utility  
RAID utility for GigaRAID IT8212 chip.

## SOFTWARE INFORMATION

This page list the contents of softwares and drivers in this CD title.

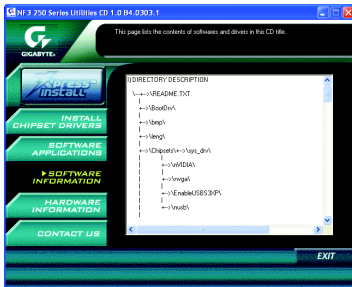

## HARDWARE INFORMATION

This page lists all device you have for this motherboard.

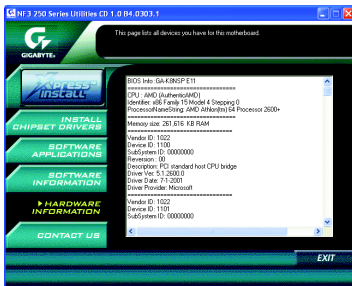

## CONTACT US

Please see the last page for details.



## FAQ

Below is a collection of general asked questions. To check general asked questions based on a specific motherboard model, please log on to <http://www.gigabyte.com.tw>

Question 1: I cannot see some options that were included in previous BIOS after updating BIOS. Why?

Answer: Some advanced options are hidden in new BIOS version. Please press Ctrl and F1 keys after entering BIOS menu and you will be able to see these options.

Questions 2: Why is the light of my keyboard/optical mouse still on after computer shuts down?

Answer: In some boards, a small amount of electricity is kept on standby after computer shuts down and that's why the light is still on.

Question 3: How do I clear CMOS?

Answer: If your board has a Clear CMOS jumper, please refer to the Clear CMOS steps in the manual. If your board doesn't have such jumper, you can take off the on-board battery to leak voltage to clear CMOS. Please refer to the steps below:

Steps:

1. Turn off power.
2. Disconnect the power cord from MB.
3. Take out the battery gently and put it aside for about 10 minutes (Or you can use a metal object to connect the positive and negative pins in the battery holder to makethem short for one minute).
4. Re-insert the battery to the battery holder.
5. Connect power cord to MB again and turn on power.
6. Press Del to enter BIOS and load Fail-Safe Defaults(or load Optimized Defaults).
7. Save changes and reboot the system.

Question 4: Why do I still get a weak sound after turning up the speaker to the maximum volume?

Answer: Please make sure the speaker you are using is equipped with an internal amplifier. If not, please change another speaker with power/amplifier and try again later.

Question 5: Sometimes I hear different continuous beeps from computer after system boots up. What do these beeps usually stand for?

Answer: The beep codes below may help you identify the possible computer problems. However, they are only for reference purposes. The situations might differ from case to case.

→ AMI BIOS Beep Codes

\*Computer gives 1 short beep when system boots successfully.

\*Except for beep code 8, these codes are always fatal.

- 1 beep Refresh failure
- 2 beeps Parity error
- 3 beeps Base 64K memory failure
- 4 beeps Timer not operational
- 5 beeps Processor error
- 6 beeps 8042 - gate A20 failure
- 7 beeps Processor exception interrupt error
- 8 beeps Display memory read/write failure
- 9 beeps ROM checksum error
- 10 beeps CMOS shutdown register read/write error
- 11 beeps Cache memory bad

→ AWARD BIOS Beep Codes

1 short: System boots successfully

2 short: CMOS setting error

1 long 1 short: DRAM or M/B error

1 long 2 short: Monitor or display card error

1 long 3 short: Keyboard error

1 long 9 short: BIOS ROM error

Continuous long beeps: DRAM error

Continuous short beeps: Power error

# Troubleshooting



If you encounter any trouble during boot up, please follow the troubleshooting procedures.

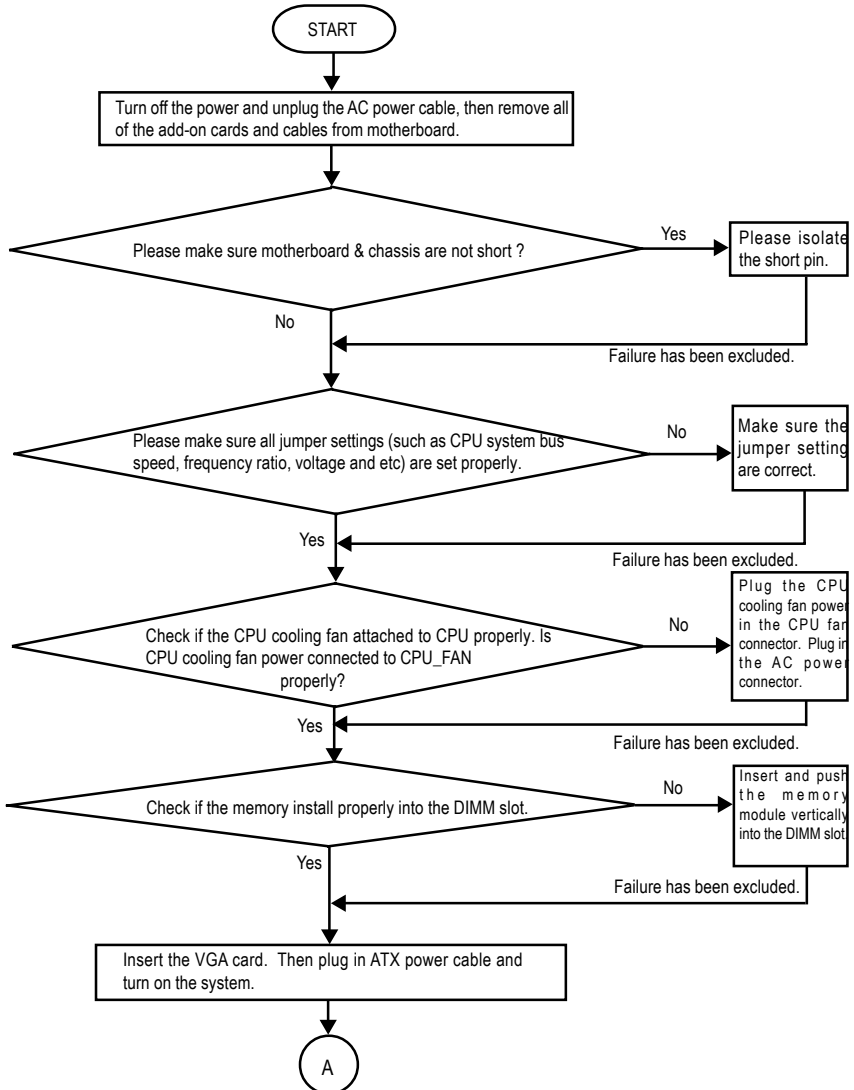

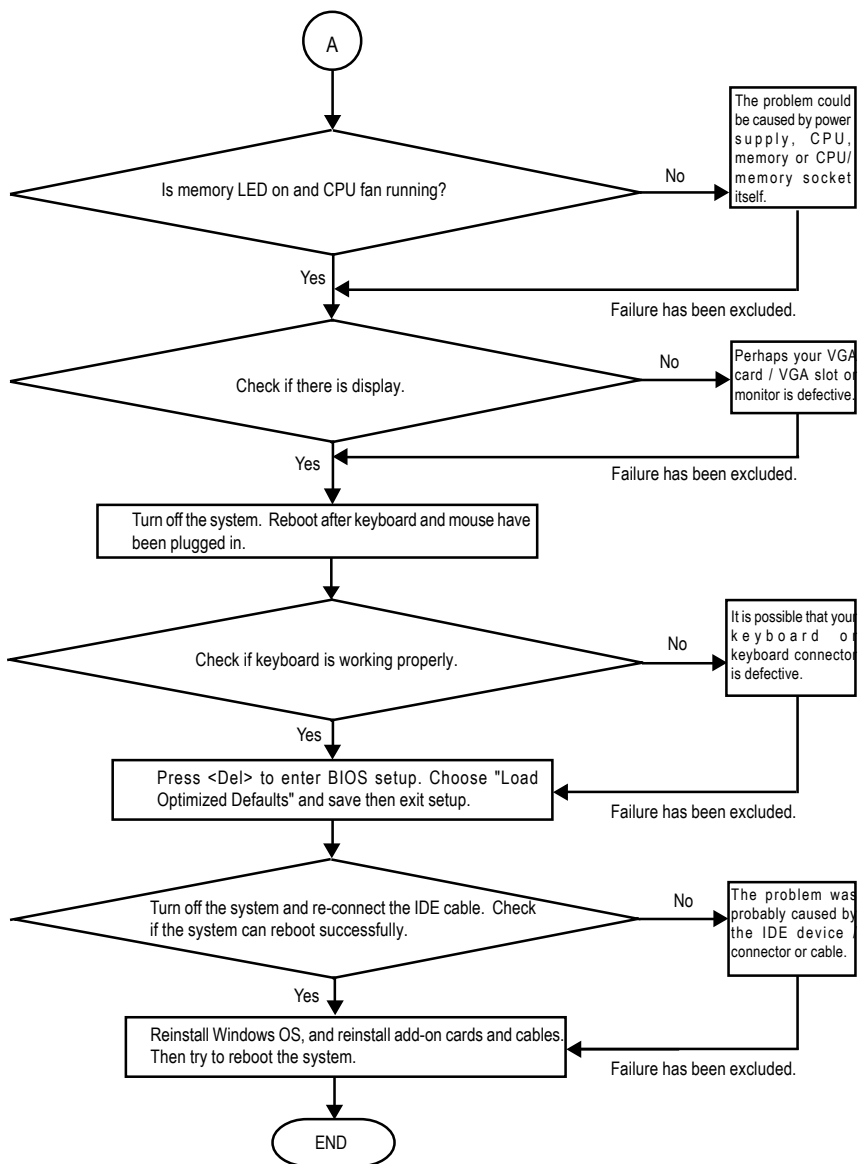

If the above procedure unable to solve your problem, please contact with your local retailer or national distributor for help. Or, you could submit your question to the service mail via Gigabyte website technical support zone (<http://www.gigabyte.com.tw>). The appropriate response will be provided ASAP.

# Technical Support/RMA Sheet

Customer/Country:	Company:	Phone No.:
Contact Person:	E-mail Add. :	

Model name/Lot Number:	PCB revision:
BIOS version:	O.S./A.S.:

Hardware Configuration	Mfs.	Model name	Size:	Driver/Utility:
CPU				
Memory				
Brand				
Video Card				
Audio Card				
HDD				
CD-ROM / DVD-ROM				
Modem				
Network				
AMR / CNR				
Keyboard				
Mouse				
Power supply				
Other Device				

Problem Description:

---



---



# Acronyms

Acronyms	Meaning
ACPI	Advanced Configuration and Power Interface
APM	Advanced Power Management
AGP	Accelerated Graphics Port
AMR	Audio Modem Riser
ACR	Advanced Communications Riser
BIOS	Basic Input / Output System
CPU	Central Processing Unit
CMOS	Complementary Metal Oxide Semiconductor
CRIMM	Continuity RIMM
CNR	Communication and Networking Riser
DMA	Direct Memory Access
DMI	Desktop Management Interface
DIMM	Dual Inline Memory Module
DRM	Dual Retention Mechanism
DRAM	Dynamic Random Access Memory
DDR	Double Data Rate
ECP	Extended Capabilities Port
ESCD	Extended System Configuration Data
ECC	Error Checking and Correcting
EMC	Electromagnetic Compatibility
EPP	Enhanced Parallel Port
ESD	Electrostatic Discharge
FDD	Floppy Disk Device
FSB	Front Side Bus
HDD	Hard Disk Device
IDE	Integrated Dual Channel Enhanced
IRQ	Interrupt Request

to be continued.....

Acronyms	Meaning
IOAPIC	Input Output Advanced Programmable Input Controller
ISA	Industry Standard Architecture
LAN	Local Area Network
I/O	Input / Output
LBA	Logical Block Addressing
LED	Light Emitting Diode
MHz	Megahertz
MIDI	Musical Instrument Digital Interface
MTH	Memory Translator Hub
MPT	Memory Protocol Translator
NIC	Network Interface Card
OS	Operating System
OEM	Original Equipment Manufacturer
PAC	PCI A.G.P. Controller
POST	Power-On Self Test
PCI	Peripheral Component Interconnect
RIMM	Rambus in-line Memory Module
SCI	Special Circumstance Instructions
SECC	Single Edge Contact Cartridge
SRAM	Static Random Access Memory











## Contact Us

---

### ● Taiwan (Headquarters)

GIGA-BYTE TECHNOLOGY CO., LTD.

Address: No.6, Bau Chiang Road, Hsin-Tien, Taipei 231, Taiwan

TEL: +886-2-8912-4888

FAX: +886-2-8912-4003

Tech. Support :

<http://tw.giga-byte.com/TechSupport/ServiceCenter.htm>

Non-Tech. Support(Sales/Marketing) :

<http://ggts.gigabyte.com.tw/nontech.asp>

WEB address (English): <http://www.gigabyte.com.tw>

WEB address (Chinese): <http://chinese.giga-byte.com>

---

### ● U.S.A.

G.B.T. INC.

TEL: +1-626-854-9338

FAX: +1-626-854-9339

Tech. Support :

<http://tw.giga-byte.com/TechSupport/ServiceCenter.htm>

Non-Tech. Support(Sales/Marketing) :

<http://ggts.gigabyte.com.tw/nontech.asp>

WEB address : <http://www.giga-byte.com>

---

### ● Germany

G.B.T. TECHNOLOGY TRADING GMBH

TEL: +49-40-2533040 (Sales)

+49-1803-428468 (Tech.)

FAX: +49-40-25492343 (Sales)

+49-1803-428329 (Tech.)

Tech. Support :

<http://tw.giga-byte.com/TechSupport/ServiceCenter.htm>

Non-Tech. Support(Sales/Marketing) :

<http://ggts.gigabyte.com.tw/nontech.asp>

WEB address : <http://www.gigabyte.de>

---

---

### ● Japan

NIPPON GIGA-BYTE CORPORATION

WEB address : <http://www.gigabyte.co.jp>

---

### ● Singapore

GIGA-BYTE SINGAPORE PTE. LTD.

Tech. Support :

<http://tw.giga-byte.com/TechSupport/ServiceCenter.htm>

Non-Tech. Support(Sales/Marketing) :

<http://ggts.gigabyte.com.tw/nontech.asp>

WEB address: <http://www.gigabyte.com.sg>

---

### ● U.K.

G.B.T. TECH. CO., LTD.

Tech. Support :

<http://tw.giga-byte.com/TechSupport/ServiceCenter.htm>

Non-Tech. Support(Sales/Marketing) :

<http://ggts.gigabyte.com.tw/nontech.asp>

WEB address : <http://uk.giga-byte.com>

---

### ● The Netherlands

GIGA-BYTE TECHNOLOGY B.V.

TEL: +31-40-290-2088

NL Tech.Support: 0900-GIGABYTE (0900-44422983)

BE Tech.Support: 0900-84034

FAX: +31-40-290-2089

Tech. Support :

<http://tw.giga-byte.com/TechSupport/ServiceCenter.htm>

Non-Tech. Support(Sales/Marketing) :

<http://ggts.gigabyte.com.tw/nontech.asp>

WEB address : <http://www.giga-byte.nl>

---

---

- **China**

NINGBO G.B.T. TECH. TRADING CO., LTD.

Tech. Support :

<http://tw.giga-byte.com/TechSupport/ServiceCenter.htm>

Non-Tech. Support(Sales/Marketing) :

<http://ggts.gigabyte.com.tw/nontech.asp>

WEB address : <http://www.gigabyte.com.cn>

**Shanghai**

TEL: +86-021-63410999

FAX: +86-021-63410100

**Beijing**

TEL: +86-10-62102838

FAX: +86-10-62102848

**Wuhan**

TEL: +86-27-87851061

FAX: +86-27-87851330

**GuangZhou**

TEL: +86-20-87586074

FAX: +86-20-85517843

**Chengdu**

TEL: +86-28-85236930

FAX: +86-28-85256822

**Xian**

TEL: +86-29-85531943

FAX: +86-29-85539821

**Shenyang**

TEL: +86-24-23960918

FAX: +86-24-23960918-809

---

- **Australia**

GIGABYTE TECHNOLOGY PTY. LTD.

Tech. Support :

<http://tw.giga-byte.com/TechSupport/ServiceCenter.htm>

Non-Tech. Support(Sales/Marketing) :

<http://ggts.gigabyte.com.tw/nontech.asp>

WEB address : <http://www.giga-byte.com.au>

---

- **France**

GIGABYTE TECHNOLOGY FRANCE S.A.R.L.

Tech. Support :

<http://tw.giga-byte.com/TechSupport/ServiceCenter.htm>

Non-Tech. Support(Sales/Marketing) :

<http://ggts.gigabyte.com.tw/nontech.asp>

WEB address : <http://www.gigabyte.fr>

---



---

- **Russia**

Moscow Representative Office Of GIGA-BYTE Technology Co., Ltd.

Tech. Support :

<http://tw.giga-byte.com/TechSupport/ServiceCenter.htm>

Non-Tech. Support(Sales/Marketing) :

<http://ggts.gigabyte.com.tw/nontech.asp>

WEB address : <http://www.gigabyte.ru>

---

- **Poland**

Office of GIGA-BYTE TECHNOLOGY Co., Ltd. in POLAND

Tech. Support :

<http://tw.giga-byte.com/TechSupport/ServiceCenter.htm>

Non-Tech. Support(Sales/Marketing) :

<http://ggts.gigabyte.com.tw/nontech.asp>

WEB address : <http://www.gigabyte.pl>

---

- **Serbia & Montenegro**

Representative Office Of GIGA-BYTE Technology Co., Ltd. in SERBIA & MONTENEGRO

Tech. Support :

<http://tw.giga-byte.com/TechSupport/ServiceCenter.htm>

Non-Tech. Support(Sales/Marketing) :

<http://ggts.gigabyte.com.tw/nontech.asp>

WEB address: <http://www.gigabyte.co.yu>

---

- **Czech Republic**

Representative Office Of GIGA-BYTE Technology Co., Ltd. in CZECH REPUBLIC

Tech. Support :

<http://tw.giga-byte.com/TechSupport/ServiceCenter.htm>

Non-Tech. Support(Sales/Marketing) :

<http://ggts.gigabyte.com.tw/nontech.asp>

WEB address: <http://www.gigabyte.cz>

---

- **Romania**

Representative Office Of GIGA-BYTE Technology Co., Ltd. in Romania

Tech. Support :

<http://tw.giga-byte.com/TechSupport/ServiceCenter.htm>

Non-Tech. Support(Sales/Marketing) :

<http://ggts.gigabyte.com.tw/nontech.asp>

WEB address: <http://www.gigabyte.com.ro>

---