

# GA-M55SLI-S4

AMD Socket AM2 Processor Motherboard

## User's Manual

Rev. 1001

12ME-M55SLIS4-1001R



\* The WEEE marking on the product indicates this product must not be disposed of with user's other household waste and must be handed over to a designated collection point for the recycling of waste electrical and electronic equipment!!



\* The WEEE marking applies only in European Union's member states.

## Declaration of Conformity

G.B.T. Technology, Inc.  
The Manufacturer/Importer  
Ausselshager Weg 41, P.O. 20327 Hamburg, Germany

(description of the apparatus, system, installation to which it refers)

**Motherboard**

GA-M55SL-S4

(reference to the specification with which conformity is declared)  
in accordance with 90/269 EEC Directive

EN 55011  
Limits and methods of measurement of radio disturbance characteristics of industrial, scientific and medical (ISM) high frequency equipment

EN 61000-3-2  
 EN 61000-3-3

Disturbances in supply systems caused by household appliances and similar electrical equipment. Voltage fluctuations\*

EN 55013  
Limits and methods of measurement of radio disturbance characteristics of equipment

EN 55024

Information Technology equipment/Immunity requirements

EN 55014-1  
Limits and methods of measurement of radio disturbance characteristics of portable tools and similar electrical apparatus

EN 50082-1  
 EN 50082-2

Generic immunity standard Part 1: Residential, commercial and light industry  
Generic immunity standard Part 2: Industrial environment

EN 55015  
Limits and methods of measurement of radio disturbance characteristics of fluorescent lamps and luminaires

EN 55014-2  
 EN 50091-2

Immunity requirements for household appliances tools and similar apparatus  
EMC requirements for uninterruptible power systems (UPS)

EN 55022  
Limits and methods of measurement of radio disturbance characteristics of information technology equipment  
 EN VDE 0855  
 EN 50170  
 Part 12  
Cabled distribution systems. Equipment for power supply systems for sound and television signals



(EEC conformity marking)

The manufacturer/ importer declares the conformity of above standard product with the actual required safety standards in accordance with LVD 73/23 EEC

EN 60085

Safety requirements for mains operated household and similar general use

EN 60950

Safety for information technology equipment including electrical business equipment

EN 60335

Safety of household and similar electrical appliances

EN 50091-1

General and Safety requirements for uninterruptible power systems (UPS)

Manufacturer/Importer

Signature: Jimmy Huang

Date: Jun. 8, 2006

Name: Timmy Huang

(Stamp)

## DECLARATION OF CONFORMITY

Per FCC Part 2, Section 2.1077(a)



Responsible Party Name: G.B.T. INC. (U.S.A.)

Address: 17358 Railroad Street

City of Industry, CA 91748

Phone/Fax No: (818) 854-9338 / (818) 854-9339

hereby declares that the product

Product Name: **Motherboard**

Model Number: GA-M55SL-S4

Conforms to the following specifications:

FCC Part 15, Subpart B, Section 15.107(a) and Section 15.109

(a), Class B Digital Device

### Supplementary Information:

This device complies with part 15 of the FCC Rules. Operation is subject to the following two conditions: (1) This device may not cause harmful and (2) this device must accept any interference received, including that may cause undesired operation.

Representative Person's Name: ERIC LU

Signature: Eric Lu

Date: Jun. 8, 2006

## Copyright

© 2006 GIGA-BYTE TECHNOLOGY CO., LTD. All rights reserved.

The trademarks mentioned in the manual are legally registered to their respective companies.

## Notice

The written content provided with this product is the property of Gigabyte.

No part of this manual may be reproduced, copied, translated, or transmitted in any form or by any means without Gigabyte's prior written permission. Specifications and features are subject to change without prior notice.

## Product Manual Classification

In order to assist in the use of this product, Gigabyte has categorized the user manual in the following:

- For quick installation, please refer to the "Hardware Installation Guide" included with the product.
- For detailed product information and specifications, please carefully read the "Product User Manual".
- For detailed information related to Gigabyte's unique features, please go to the "Technology Guide" section on Gigabyte's website to read or download the information you need.

For more product details, please click onto Gigabyte's website at [www.gigabyte.com.tw](http://www.gigabyte.com.tw)

# Table of Contents

Item Checklist .....	6
Optional Accessories .....	6
GA-M55SLI-S4 Motherboard Layout .....	7
Block Diagram .....	8
Chapter 1 Hardware Installation .....	9
1-1 Considerations Prior to Installation .....	9
1-2 Feature Summary .....	10
1-3 Installation of the CPU and CPU Cooler .....	12
1-3-1 Installation of the CPU .....	12
1-3-2 Installation of the CPU cooler .....	13
1-4 Installation of Memory .....	14
1-5 Installation of Expansion Cards .....	16
1-6 Setup of SLI (Scalable Link Interface) Configuration .....	17
1-7 I/O Back Panel Introduction .....	21
1-8 Connectors Introduction .....	22
Chapter 2 BIOS Setup .....	33
The Main Menu (For example: BIOS Ver. :D8) .....	34
2-1 Standard CMOS Features .....	36
2-2 Advanced BIOS Features .....	38
2-3 Integrated Peripherals .....	40
2-4 Power Management Setup .....	44
2-5 PnP/PCI Configurations .....	46
2-6 PC Health Status .....	47
2-7 MB Intelligent Tweaker(M.I.T.) .....	49
2-8 Top Performance .....	51
2-9 Load Optimized Defaults .....	51
2-10 Set Supervisor/User Password .....	52
2-11 Save & Exit Setup .....	53
2-12 Exit Without Saving .....	53



Chapter 3 Drivers Installation .....	55
3-1 Install Chipset Drivers .....	55
3-2 Software Applications .....	56
3-3 Driver CD Information .....	56
3-4 Hardware Information .....	57
3-5 Contact Us .....	57
 Chapter 4 Appendix .....	 59
4-1-1 EasyTune 5 Introduction .....	59
4-1-2 Xpress Recovery2 Introduction .....	60
4-1-3 Flash BIOS Method Introduction .....	62
4-1-4 Configuring SATA Hard Drive(s) .....	71
4-1-5 2- / 4- / 6- / 8- Channel Audio Function Introduction .....	85
4-2 Troubleshooting .....	89

## Item Checklist

- IDE Cable x 1 & FDD Cable x 1
- Serial ATAII Cable x 2
- I/O Shield
- SLI Bridge (GC-DGBR2-RH) x 1
- Retention Bracket x 1

\* The items listed above are for reference only, and are subject to change without notice.

---

## Optional Accessories

- ◆ 2 Ports USB2.0 Cable (Part Number: 12CR1-1UB030-51/R)
- ◆ 4 Ports USB2.0 Cable (Part Number: 12CR1-1UB030-21/R)
- ◆ 2 Ports IEEE1394 Cable (Part Number: 12CF1-1IE008-01R)

# GA-M55SLI-S4 Motherboard Layout

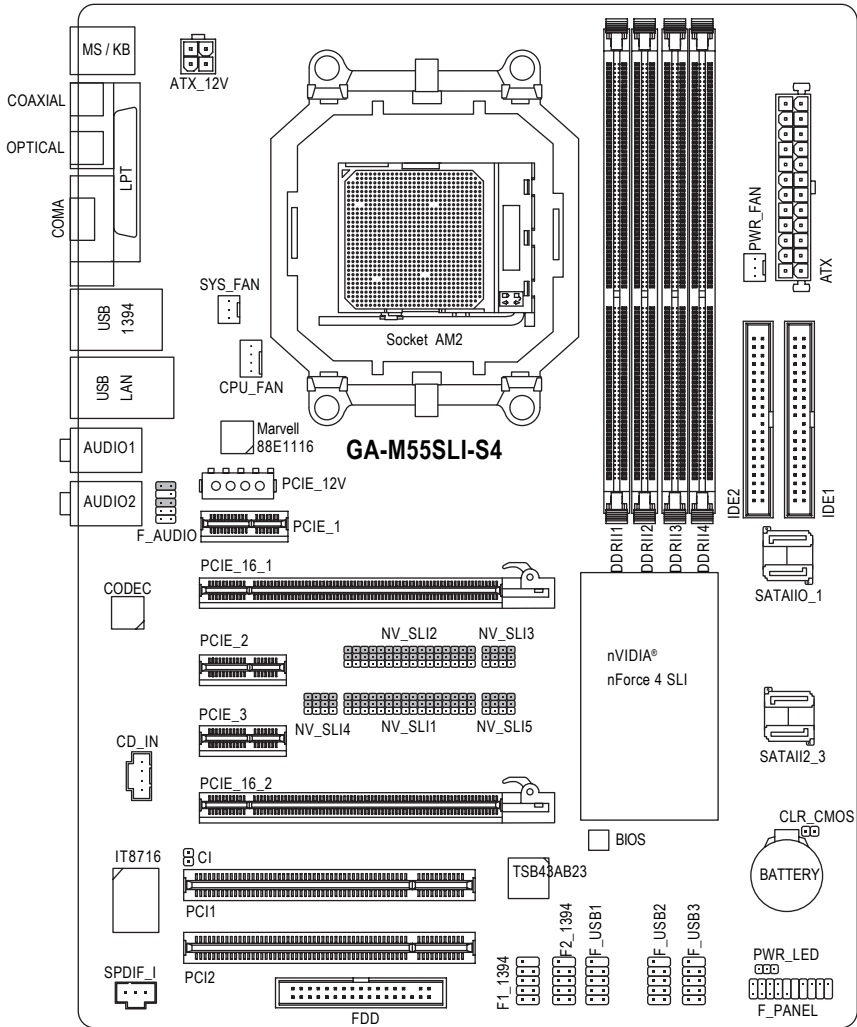

# Block Diagram

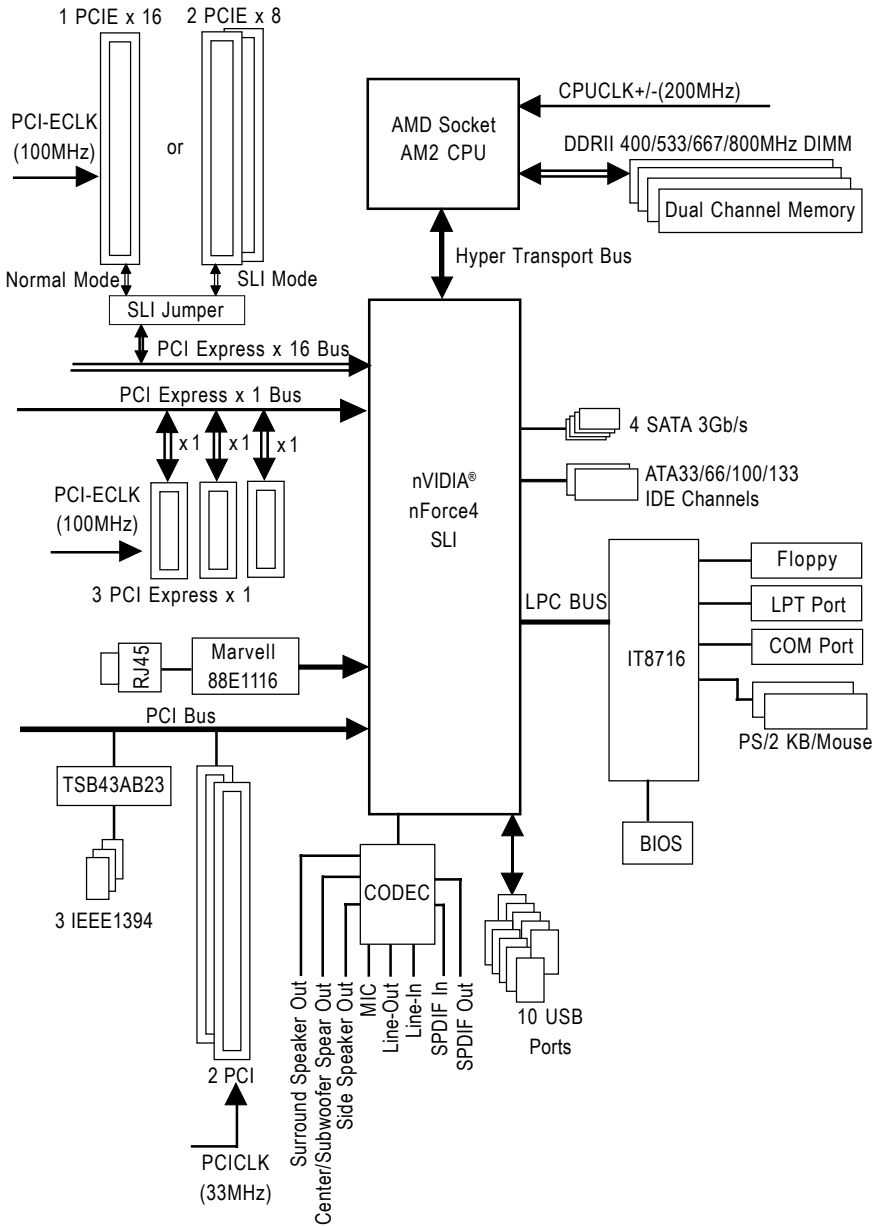

# Chapter 1 Hardware Installation

## 1-1 Considerations Prior to Installation

### Preparing Your Computer

The motherboard contains numerous delicate electronic circuits and components which can become damaged as a result of electrostatic discharge (ESD). Thus, prior to installation, please follow the instructions below:

1. Please turn off the computer and unplug its power cord.
2. When handling the motherboard, avoid touching any metal leads or connectors.
3. It is best to wear an electrostatic discharge (ESD) cuff when handling electronic components (CPU, RAM).
4. Prior to installing the electronic components, please have these items on top of an antistatic pad or within a electrostatic shielding container.
5. Please verify that the power supply is switched off before unplugging the power supply connector from the motherboard.

### Installation Notices

1. Prior to installation, please do not remove the stickers on the motherboard. These stickers are required for warranty validation.
2. Prior to the installation of the motherboard or any hardware, please first carefully read the information in the provided manual.
3. Before using the product, please verify that all cables and power connectors are connected.
4. To prevent damage to the motherboard, please do not allow screws to come in contact with the motherboard circuit or its components.
5. Please make sure there are no leftover screws or metal components placed on the motherboard or within the computer casing.
6. Please do not place the computer system on an uneven surface.
7. Turning on the computer power during the installation process can lead to damage to system components as well as physical harm to the user.
8. If you are uncertain about any installation steps or have a problem related to the use of the product, please consult a certified computer technician.

### Instances of Non-Warranty

1. Damage due to natural disaster, accident or human cause.
2. Damage as a result of violating the conditions recommended in the user manual.
3. Damage due to improper installation.
4. Damage due to use of uncertified components.
5. Damage due to use exceeding the permitted parameters.
6. Product determined to be an unofficial Gigabyte product.

## 1-2 Feature Summary

CPU	<ul style="list-style-type: none"> <li>◆ Socket AM2 for AMD Athlon™ 64 FX / Athlon™ 64 X2 Dual-Core / Athlon™ 64 / Sempron™ processor</li> </ul>
Front Side Bus	<ul style="list-style-type: none"> <li>◆ 2000MHz</li> </ul>
Chipset	<ul style="list-style-type: none"> <li>◆ nVIDIA® nForce4 SLI chipset</li> </ul>
LAN	<ul style="list-style-type: none"> <li>◆ Onboard Marvell 88E1116 PHY(10/100/1000Mbit)</li> </ul>
Audio	<ul style="list-style-type: none"> <li>◆ Onboard Realtek ALC850 CODEC</li> <li>◆ Supports 2 / 4 / 6/ 8 channel audio</li> <li>◆ Supports Jack Sensing (Connector Sensing)</li> <li>◆ Supports SPDIF In/Out connection</li> <li>◆ Supports CD In connection</li> </ul>
IEEE 1394	<ul style="list-style-type: none"> <li>◆ Onboard TI TSB43AB23 chip</li> <li>◆ 3 IEEE1394a ports</li> </ul>
Storage	<ul style="list-style-type: none"> <li>◆ nVIDIA® nForce4 SLI chipset</li> <li>- 1 FDD connector, allowing connection of 2 FDD devices</li> <li>- 2 IDE connectors (IDE1, IDE2) with UDMA 33/ATA 66/ATA 100/ATA 133 support, allowing connection of 4 IDE devices</li> <li>- 4 SATA 3Gb/s connectors (S_ATA1/0/1/2/3), allowing connection of 4 SATA 3Gb/s devices</li> <li>- Supports data striping (RAID 0), mirroring (RAID 1), striping + mirroring (RAID 0+1), and RAID 5 for Serial ATA</li> </ul>
O.S Support	<ul style="list-style-type: none"> <li>◆ Microsoft Windows 2000/XP</li> </ul>
Memory	<ul style="list-style-type: none"> <li>◆ 4 DDRII DIMM memory slots (supports up to 16GB memory)<sup>(Note 1)</sup></li> <li>◆ Supports dual channel DDRII 800/667/533/400 DIMMs</li> <li>◆ Supports 1.8V DDRII DIMMs</li> </ul>
Expansion Slots	<ul style="list-style-type: none"> <li>◆ 2 PCI Express x 16 slots</li> <li>◆ 3 PCI Express x 1 slots</li> <li>◆ 2 PCI slots</li> </ul>
Internal Connectors	<ul style="list-style-type: none"> <li>◆ 1 24-pin ATX power connector</li> <li>◆ 1 4-pin ATX 12V power connector</li> <li>◆ 1 4-pin PCIE 12V power connector</li> <li>◆ 1 floppy connector</li> <li>◆ 2 IDE connectors</li> <li>◆ 4 SATA 3Gb/s connectors</li> <li>◆ 1 CPU fan connector</li> <li>◆ 1 system fan connector</li> <li>◆ 1 power fan connector</li> <li>◆ 1 front panel connector</li> <li>◆ 1 front audio connector</li> <li>◆ 1 CD In connector</li> <li>◆ 3 USB 2.0/1.1 connectors for additional 6 USB 2.0/1.1 ports by cables</li> <li>◆ 1 power LED connector</li> <li>◆ 2 IEEE1394a connectors for additional 2 port by cable</li> <li>◆ 1 SPDIF In connector</li> <li>◆ 1 CI connector</li> </ul>

Rear Panel I/O	<ul style="list-style-type: none"> <li>◆ 1 PS/2 keyboard port</li> <li>◆ 1 PS/2 mouse port</li> <li>◆ 1 parallel port</li> <li>◆ 1 SPDIF In jack</li> <li>◆ 1 SPDIF Out jack</li> <li>◆ 1 serial port (COMA)</li> <li>◆ 4 USB 2.0/1.1 ports</li> <li>◆ 1 RJ-45 port</li> <li>◆ 1 IEEE1394 port</li> <li>◆ 6 audio jacks (Line In / Line Out / MIC In / Surround Speaker Out (Rear Speaker Out) / Center/Subwoofer Speaker Out / Side Speaker Out)</li> </ul>
I/O Control	<ul style="list-style-type: none"> <li>◆ IT8716 chip</li> </ul>
Hardware Monitor	<ul style="list-style-type: none"> <li>◆ System voltage detection</li> <li>◆ CPU / System temperature detection</li> <li>◆ CPU / Power / System fan speed detection</li> <li>◆ CPU / System warning temperature</li> <li>◆ CPU fan failure warning</li> <li>◆ Supports CPU Smart Fan function<sup>(Note 2)</sup></li> </ul>
BIOS	<ul style="list-style-type: none"> <li>◆ 1 4Mbit flash ROM</li> <li>◆ Use of licensed AWARD BIOS</li> </ul>
Additional Features	<ul style="list-style-type: none"> <li>◆ Supports @BIOS</li> <li>◆ Supports Download Center</li> <li>◆ Supports Q-Flash</li> <li>◆ Supports EasyTune<sup>(Note 3)</sup></li> <li>◆ Supports Xpress Install</li> <li>◆ Supports Xpress Recovery2</li> <li>◆ Supports Xpress BIOS Rescue</li> </ul>
Bundle Software	<ul style="list-style-type: none"> <li>◆ Norton Internet Security (OEM version)</li> </ul>
Form Factor	<ul style="list-style-type: none"> <li>◆ ATX form factor; 30.5cm x 23.4cm</li> </ul>

(Note 1) Due to the limitation of Windows 32-bit operating system, when more than 4GB of physical memory is installed, the actual memory available for the operating system will be less than 4GB; Windows 64-bit operating system doesn't have such limitation.

(Note 2) Whether the CPU Smart FAN Control function is supported will depend on the CPU you install.

(Note 3) EasyTune functions may vary depending on different motherboards.

## 1-3 Installation of the CPU and CPU Cooler



Before installing the CPU, please comply with the following conditions:

1. Please make sure that the motherboard supports the CPU.
2. Please take note of the pin 1 marking (the small triangle) on the CPU. If you install the CPU in the wrong direction, the CPU will not insert properly. If this occurs, please change the insert direction of the CPU.
3. Please add an even layer of heat paste between the CPU and CPU cooler.
4. Please make sure the CPU cooler is installed on the CPU prior to system use, otherwise overheating and permanent damage of the CPU may occur.
5. Please set the CPU host frequency in accordance with the processor specifications. It is not recommended that the system bus frequency be set beyond hardware specifications since it does not meet the required standards for the peripherals. If you wish to set the frequency beyond the proper specifications, please do so according to your hardware specifications including the CPU, graphics card, memory, hard drive, etc.

### 1-3-1 Installation of the CPU

Check the CPU pins to see that none are bent. Move the socket lever to the unlocked position as shown in Fig. 1 (90° to the plane of the motherboard) prior to inserting the CPU. The pin 1 location is designated on the CPU by a small triangle that corresponds to a triangle marking on the socket as shown in Fig. 2. Align the CPU to the socket and gently lower it into place. Do not force the CPU into the socket.

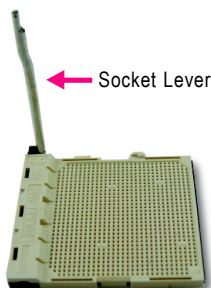

Fig.1  
Position lever at a 90 degree angle.



Fig.2  
Pin 1 location on the socket and processor.  
Gently place the CPU into position making sure that the CPU pins fit perfectly into their holes. Once the CPU is positioned into its socket, place one finger down on the middle of the CPU and gently press the metal lever back into its original position.

Pin One



Please use extra care when installing the CPU. The CPU will not fit if positioned incorrectly. Rather than applying force, please change the positioning of the CPU.



### 1-3-2 Installation of the CPU cooler

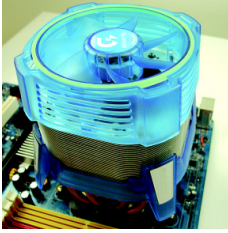

Fig.1

Before installing the CPU cooler, please first add an even layer of heat paste on the surface of the CPU. Install all the CPU cooler components (Please refer to the heat sink manual for detailed installation instructions).

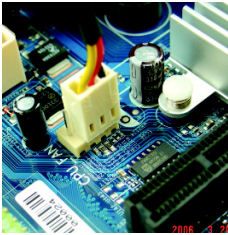

Fig.2

Please connect the CPU cooler power connector to the CPU\_FAN connector located on the motherboard so that the CPU cooler can properly function to prevent CPU overheating.



The CPU cooler may adhere to the CPU as a result of hardening of the heat paste. To prevent such an occurrence, it is suggested that either thermal tape rather than heat paste be used for heat dissipation or using extreme care when removing the CPU cooler.

## 1-4 Installation of Memory



Before installing the memory modules, please comply with the following conditions:

1. Please make sure that the memory used is supported by the motherboard. It is recommended that memory of similar capacity, specifications and brand be used.
2. Before installing or removing memory modules, please make sure that the computer power is switched off to prevent hardware damage.
3. Memory modules have a foolproof insertion design. A memory module can be installed in only one direction. If you are unable to insert the module, please switch the direction.

The motherboard supports DDR II memory modules, whereby BIOS will automatically detect memory capacity and specifications. Memory modules are designed so that they can be inserted only in one direction. The memory capacity used can differ with each slot.

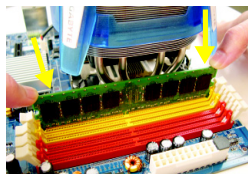
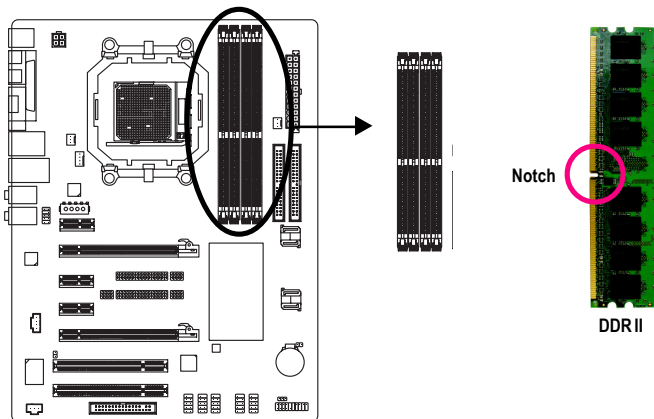

Fig.1

The DIMM socket has a notch, so the DIMM memory module can only fit in one direction. Insert the DIMM memory module vertically into the DIMM socket. Then push it down.

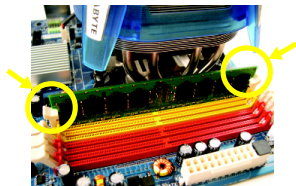

Fig.2

Close the plastic clip at both edges of the DIMM sockets to lock the DIMM module.

Reverse the installation steps when you wish to remove the DIMM module.



## Dual Channel Memory Configuration

The GA-M55SLI-S4 supports the Dual Channel Technology. After operating the Dual Channel Technology, the bandwidth of Memory Bus will add double. Due to CPU limitation, if you wish to operate the Dual Channel Technology,

follow the guidelines below:

1. Dual Channel mode will not be enabled if only one memory module is installed.
2. To enable Dual Channel mode with two memory modules (it is recommended to use memory modules of identical brand, size, chips, and speed), you must install them into DIMM sockets of the same color.
3. To enable Dual Channel mode with four memory modules, it is recommended to use memory modules of identical brand, size, chips, and speed.

The following is a Dual Channel Memory configuration table:

(DS: Double Side, SS: Single Side, "--": Empty)

	DDR II 1	DDR II 2	DDR II 3	DDR II 4
2 memory modules	DS/SS	DS/SS	--	--
	--	--	DS/SS	DS/SS
4 memory modules	DS/SS	DS/SS	DS/SS	DS/SS



If two memory modules are to be used to achieve Dual Channel mode, we recommend installing them in DDRII 1 and DDRII 2 DIMM sockets.

## 1-5 Installation of Expansion Cards

You can install your expansion card by following the steps outlined below:

1. Read the related expansion card's instruction document before install the expansion card into the computer.
2. Remove your computer's chassis cover, screws and slot bracket from the computer.
3. Press the expansion card firmly into expansion slot in motherboard.
4. Be sure the metal contacts on the card are indeed seated in the slot.
5. Replace the screw to secure the slot bracket of the expansion card.
6. Replace your computer's chassis cover.
7. Power on the computer, if necessary, setup BIOS utility of expansion card from BIOS.
8. Install related driver from the operating system.

Installing a PCI Express x 16 expansion card:

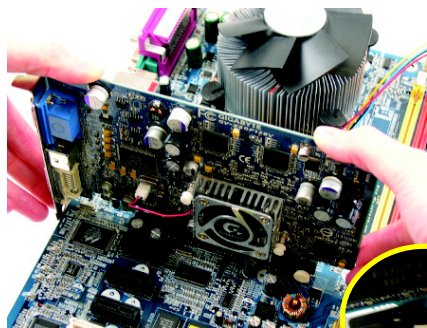

CAUTION

Please align the VGA card to the onboard PCI Express x 16 slot and press firmly down on the slot. Make sure your VGA card is locked by the latch at the end of the PCI Express x 16 slot. When you try uninstall the VGA card, please press the latch as the picture to the left shows to release the card.

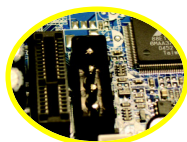

NOTE

The PCIE\_12V power connector supplies extra power to the PCIe x 16 slots. Connect this connector depending on your system requirements.

## 1-6 Setup of SLI (Scalable Link Interface) Configuration

NVIDIA nForce4 SLI offers blistering graphics performance with the ability to bridge two NVIDIA SLI-ready PCI Express™ graphics cards! The SLI design takes advantage of the increased bandwidth of the PCI Express™ bus architecture, features hardware and software innovations within NVIDIA GPU (graphics processing unit) and the NVIDIA nForce4 chipset. Together, the NVIDIA SLI technologies work seamlessly to allow two graphics cards to operate in parallel and share the work and deliver heart-pounding PC performance. This section introduces steps to configure an SLI system on the GA-M55SLI-S4 motherboard.

### Before You Begin--

#### I. Understanding the GIGABYTE SLI Jumper:

You can find an SLI switch module socket inserted with an SLI switch module between the first and second PCIE x16 slots. 1-2 close for SLI mode, 2-3 close for Normal mode.

#### 1-2 close: SLI mode

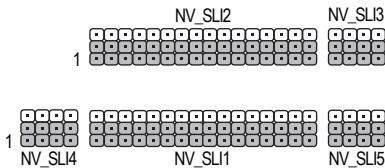

#### SLI Mode:

In SLI Mode, the two PCIE x16 slots can run in two modes. You can either use them as two individual x8 slots or install two SLI-ready PCIE x16 cards (Example: GIGABYTE GV-NX66T128D) of the same model and link them together with an SLI bridge connector to enable SLI function to provide enhanced performance.

#### 2-3 close: Normal mode (Default)

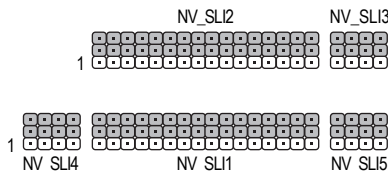

#### Normal Mode:

Only the first PCIE x16 slot is available and can operate at up to x16 in Normal Mode.

As not all PCIE slots are available while in SLI or Normal Mode, please refer to the table below to check PCIE slots available in SLI or Normal Mode before installation.

	PCIE_1	PCIE_16_1	PCIE_2	PCIE_3	PCIE_16_2
SLI Mode	Available	Available *	Not available	Available	Available *
Normal Mode	Available	Available	Available	Available	Not available

\* \* \* can run at up to PCIE x8 mode.



Please double check SLI jumper setting when it's not available might damage the system.

## II. Power Requirements:

The exact power requirements will depend on your overall system configurations. You need a power supply that can provide sufficient and stable power to your system and the two SLI graphics cards. Please refer to the table below to check recommended power for different systems.

System configurations	System A	System B
Processors	AMD Athlon 64 FX-53	AMD Athlon 64 4000+
PCIe x 16 video cards	2 NVIDIA 6800 Ultra cards	2 NVIDIA 6600 GT cards
DDR memory modules	4 DIMMs	2 DIMMs
Hard drives/Optical drives	4 hard drives + 2 optical drives	1 hard drives + 1 optical drives
Expansion cards	1 PCIe x1 card + 2 PCI cards	0
USB devices	10	4
IEEE1394 devices	1	0
<b>Required +12V current</b>	<b>25A or above</b>	<b>20A or above</b>
<b>Power supply requirement</b>	<b>500W or above</b>	<b>350W or above</b>

## III. Supported Operating Systems:

Only Windows XP operating system is currently supported by the NVIDIA SLI technology.

### Enabling SLI Mode--

Step 1: 2-3 close : Normal (Default)

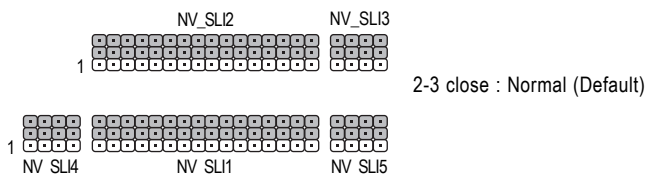

Step 2: 1-2 close : SLI mode

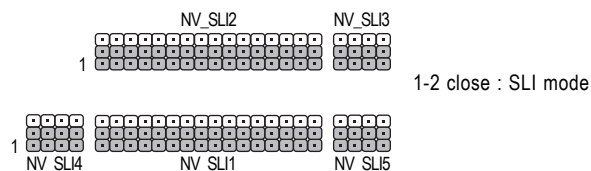

Please double check SLI jumper setting when it's not available might damage the system.

### Connecting Two Graphics Cards:

Step 1: Observe the steps in "1-5 Installation of Expansion Cards" and install two SLI-ready graphics cards of the same model to the PCIE\_16\_1 and PCIE\_16\_2 slots.

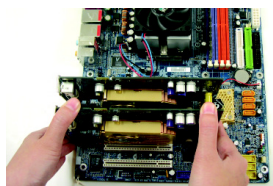

Step 2: Insert the SLI bridge (the GC-SLICON) to the SLI gold edge connector on top of both cards. Make sure the two mini female slots on the bridge connector securely fit onto the SLI gold edge connectors of both cards.

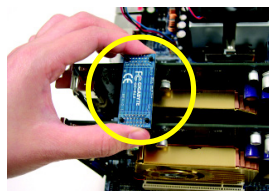

Female slots on the bridge connector



Gold edge connector on the top of graphics card



Step 3: In order to securely fix the bridge connector between the two cards, you must install the retention bracket included with the motherboard and secure the retention bracket to the chassis back panel with a screw.

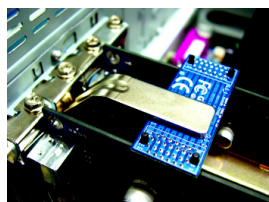

retention bracket

— place this part on the top of the bridge connector.

Step 4: Plug the display cable into either one of the two graphics cards for display output. If you plug the display cable to the card on the PCIE\_16\_1 slot, make sure to set **Init Display First** in BIOS Setup to **PEG**; if you plug the display cable to the card on the PCIE\_16\_2 slot, set **Init Display First** to **PEG(Slot2)**.

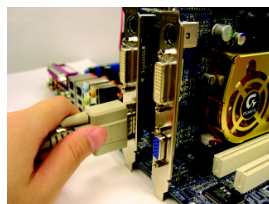

### Graphics Card Driver Setting:

Step 1: After installing graphics card driver in operating system, right-click the NVIDIA icon in your system tray and then select **NVIDIA Display**. The NVIDIA control panel will appear.



Step 2: Select **SLI multi-GPU** from the side menu and then select the **Enable SLI multi-GPU** checkbox in the SLI multi-GPU dialog box. System will restart after you click **Apply**. Then the SLI configuration is completed.

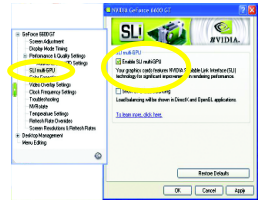



## 1-7 I/O Back Panel Introduction

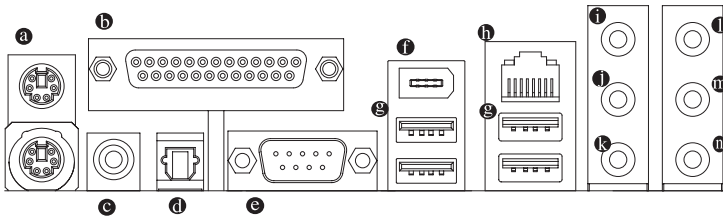

### Ⓐ PS/2 Keyboard and PS/2 Mouse Connector

To install a PS/2 port keyboard and mouse, plug the mouse to the upper port (green) and the keyboard to the lower port (purple).

### Ⓑ Parallel Port

The parallel port allows connection of a printer, scanner and other peripheral devices.

### Ⓒ COAXIAL

The S/PDIF coaxial output port is capable of providing digital audio to external speakers or compressed AC3 data to an external Dolby Digital Decoder via a coaxial cable.

### Ⓓ OPTICAL

The S/PDIF optical output port is capable of providing digital audio to external speakers or compressed AC3 data to an external Dolby Digital Decoder via an optical cable.

### Ⓔ COMA (Serial Port)

Connects to serial-based mouse or data processing devices.

### Ⓕ IEEE 1394a Port

Serial interface standard set by Institute of Electrical and Electronics Engineers, which has features like high speed, high bandwidth and hot plug.

### Ⓖ USB port

Before you connect your device(s) into USB connector(s), please make sure your device(s) such as USB keyboard, mouse, scanner, zip, speaker...etc. have a standard USB interface. Also make sure your OS supports USB controller. If your OS does not support USB controller, please contact OS vendor for possible patch or driver upgrade. For more information please contact your OS or device(s) vendors.

### Ⓗ LAN Port

The provided Internet connection is Gigabit Ethernet, providing data transfer speeds of 10/100/1000 Mbps.

### Ⓘ Line In

Devices like CD-ROM, walkman etc. can be connected to Line In jack.

### Ⓛ Line Out (Front Speaker Out)

The default Line Out (Front Speaker Out) jack. Stereo speakers, earphone or front surround speakers can be connected to Line Out (Front Speaker Out) jack.

### Ⓜ MIC In

The default MIC In jack. Microphone must be connected to MIC In jack.

### ① Center/Subwoofer Speaker Out

The default Center/Subwoofer Speaker Out jack. Center/Subwoofer speakers can be connected to Center/Subwoofer Speaker Out jack.

### ② Surround Speaker Out (Rear Speaker Out)

The default Surround Speaker Out (Rear Speaker Out) jack. Rear surround speakers can be connected to Surround Speaker Out (Rear Speaker Out) jack.

### ③ Side Speaker Out

The default Side Speaker Out jack. Surround side speakers can be connected to Side Speaker Out jack.



NOTE

Please refer to the 2-/4-/6-/8- channel audio setup steps for detailed software configuration information.

## 1-8 Connectors Introduction

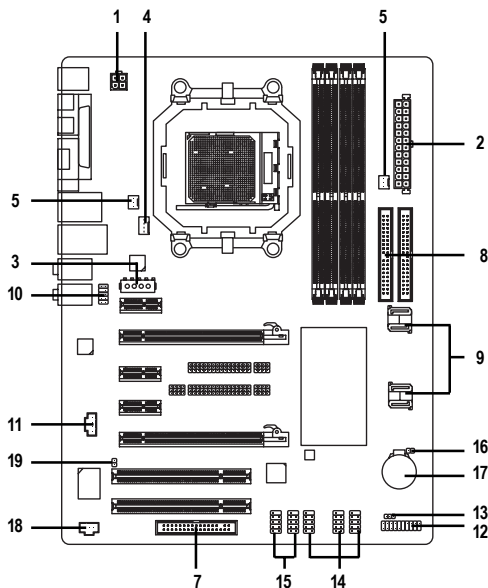

1) ATX_12V	11) CD_IN
2) ATX (Power Connector)	12) F_PANEL
3) PCIE_12V	13) PWR_LED
4) CPU_FAN	14) F_USB1 / F_USB2 / F_USB3
5) SYS_FAN	15) F1_1394 / F2_1394
6) PWR_FAN	16) CLR_CMOS
7) FDD	17) BATTERY
8) IDE1 / IDE2	18) SPDIF_I
9) SATAII0_1/ SATAII2_3	19) CI
10) F_AUDIO	

## 1/2) ATX\_12V/ATX (Power Connector)

With the use of the power connector, the power supply can supply enough stable power to all the components on the motherboard. Before connecting the power connector, please make sure that all components and devices are properly installed. Align the power connector with its proper location on the motherboard and connect tightly.

The ATX\_12V power connector mainly supplies power to the CPU. If the ATX\_12V power connector is not connected, the system will not start.

Caution!

Please use a power supply that is able to handle the system voltage requirements. It is recommended that a power supply that can withstand high power consumption be used (300W or greater). If a power supply is used that does not provide the required power, the result can lead to an unstable system or a system that is unable to start.

If you use a 24-pin ATX power supply, please remove the small cover on the power connector on the motherboard before plugging in the power cord ; otherwise, please do not remove it.

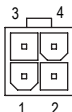
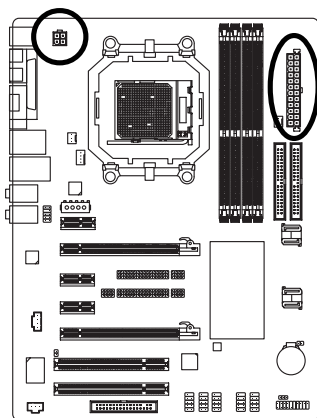

Pin No.	Definition
1	GND
2	GND
3	+12V
4	+12V

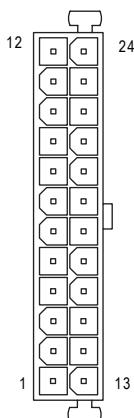

Pin No.	Definition	Pin No.	Definition
1	3.3V	13	3.3V
2	3.3V	14	-12V
3	GND	15	GND
4	+5V	16	PS_ON(soft On/Off)
5	GND	17	GND
6	+5V	18	GND
7	GND	19	GND
8	Power Good	20	-5V
9	5V SB(stand by +5V)	21	+5V
10	+12V	22	+5V
11	+12V(Only for 24-pin ATX)	23	+5V (Only for 24-pin ATX)
12	3.3V(Only for 24-pin ATX)	24	GND(Only for 24-pin ATX)

### 3) PCIE\_12V (Power Connector)

The PCIE\_12V power connector supplies extra power to the PCIe x16 slot. Connect this connector depending on your system requirements.

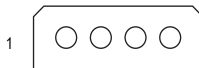
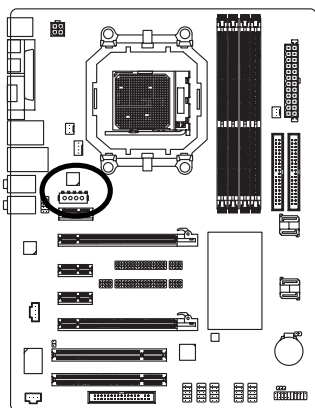

Pin No.	Definition
1	NC
2	GND
3	GND
4	+12V

### 4/5/6) CPU\_FAN / SYS\_FAN / PWR\_FAN (Cooler Fan Power Connector)

The cooler fan power connector supplies a +12V power voltage via a 3-pin/4-pin (only for CPU\_FAN) power connector and possesses a fool-proof connection design.

Most coolers are designed with color-coded power connector wires. A red power connector wire indicates a positive connection and requires a +12V power voltage. The black connector wire is the ground wire (GND).

Please remember to connect the CPU/system fan cable to the CPU\_FAN/SYS\_FAN/PWR\_FAN connector to prevent the CPU/system/power from overheating and failure.

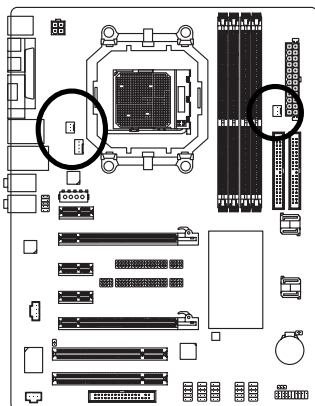

CPU\_FAN



SYS\_FAN



PWR\_FAN

Pin No.	Definition
1	GND
2	+12V
3	Sense
4	Speed Control (Only for CPU_FAN)

## 7) FDD (FDD Connector)

The FDD connector is used to connect the FDD cable while the other end of the cable connects to the FDD drive. The types of FDD drives supported are: 360KB, 720KB, 1.2MB, 1.44MB and 2.88MB. Please connect the red power connector wire to the pin1 position.

Before attaching the FDD cable, please take note of the foolproof groove in the FDD connector.

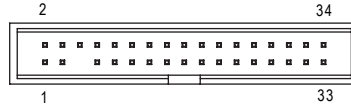
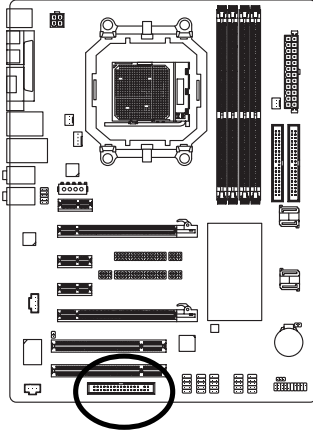

## 8) IDE1 / IDE2 (IDE Connector)

An IDE device connects to the computer via an IDE connector. One IDE connector can connect to one IDE cable, and the single IDE cable can then connect to two IDE devices (hard drive or optical drive). If you wish to connect two IDE devices, please set the jumper on one IDE device as Master and the other as Slave (for information on settings, please refer to the instructions located on the IDE device). Before attaching the IDE cable, please take note of the foolproof groove in the IDE connector.

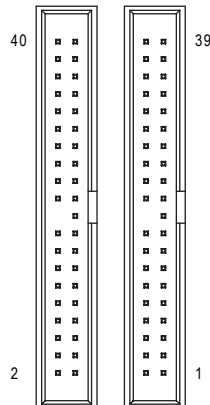
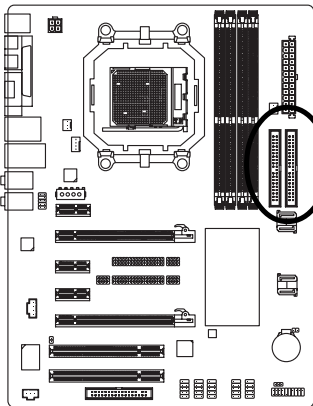

## 9) SATAII0\_1 / SATAII2\_3 (SATA 3Gb/s Connectors, Controlled by nForce4 SLI)

SATA 3Gb/s can provide up to 300MB/s transfer rate. Please refer to the BIOS setting for the Serial ATA controller and install the proper driver in order to work properly.

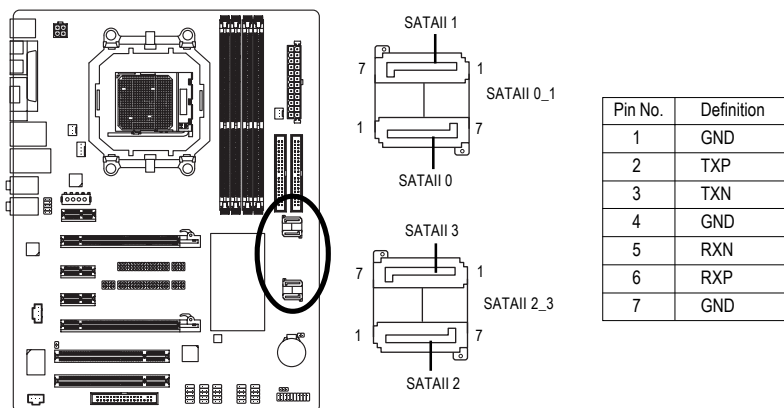

## 10) F\_AUDIO (Front Audio Panel Connector)

If you want to use Front Audio connector, you must remove 5-6, 9-10 Jumper.

In order to utilize the front audio header, your chassis must have front audio connector. Also please make sure the pin assignment on the cable is the same as the pin assignment on the MB header. To find out if the chassis you are buying support front audio connector, please contact your dealer. Please note, you can have the alternative of using front audio connector or of using rear audio connector to play sound.

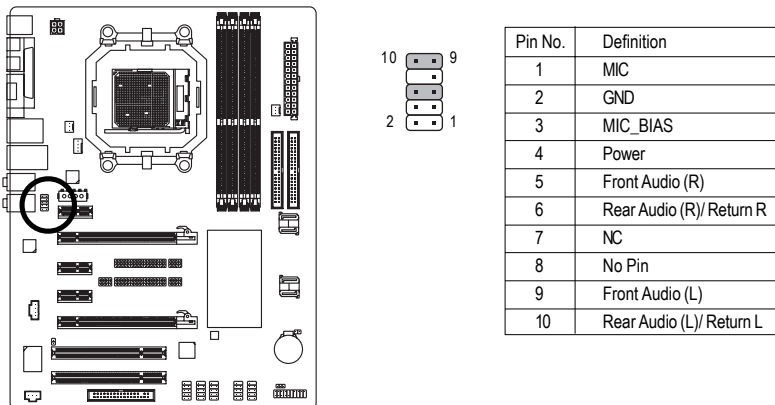

### 11) CD\_IN (CD In Connector)

Connect CD-ROM or DVD-ROM audio out to the connector.

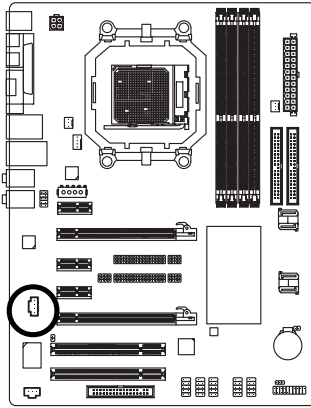

Pin No.	Definition
1	CD-L
2	GND
3	GND
4	CD-R

### 12) F\_PANEL (Front Panel Jumper)

Please connect the power LED, PC speaker, reset switch and power switch etc of your chassis front panel to the F\_PANEL connector according to the pin assignment below.

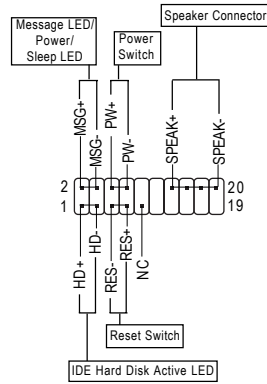
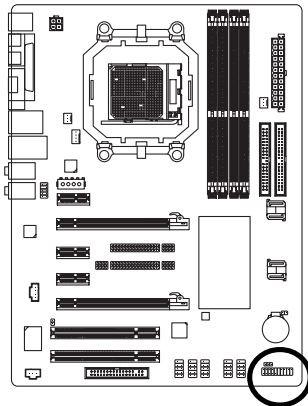

HD (IDE Hard Disk Active LED) (Blue)	Pin 1: LED anode(+) Pin 2: LED cathode(-)
SPEAK (Speaker Connector) (Amber)	Pin 1: Power Pin 2- Pin 3: NC Pin 4: Data(-)
RES (Reset Switch) (Green)	Open: Normal Close: Reset Hardware System
PW (Power Switch) (Red)	Open: Normal Close: Power On/Off
MSG(Message LED/Power/Sleep LED) (Yellow)	Pin 1: LED anode(+) Pin 2: LED cathode(-)
NC (Purple)	NC

### 13) PWR\_LED

The PWR\_LED connector is connected with the system power indicator to indicate whether the system is on/off. It will blink when the system enters suspend mode.

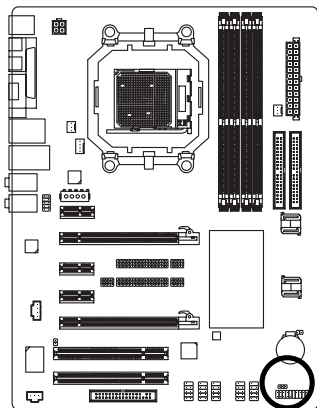

1 

Pin No.	Definition
1	MPD+
2	MPD-
3	MPD-

### 14) F\_USB1 / F\_USB2 / F\_USB3 (Front USB Connector)

Be careful with the polarity of the front USB connector. Check the pin assignment carefully while you connect the front USB cable, incorrect connection between the cable and connector will make the device unable to work or even damage it. For optional front USB cable, please contact your local dealer.

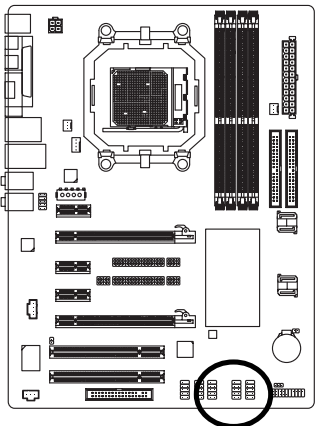

10  9  
2  1

Pin No.	Definition
1	Power (5V)
2	Power (5V)
3	USB DX-
4	USB Dy-
5	USB DX+
6	USB Dy+
7	GND
8	GND
9	No Pin
10	NC



**15) F1\_1394 / F2\_1394 (IEEE 1394 Connector)**

Serial interface standard set by Institute of Electrical and Electronics Engineers, which has features like high speed, highbandwidth and hot plug. Be careful with the polarity of the IEEE1394 connector. Check the pin assignment carefully while you connect the IEEE1394 cable, incorrect connection between the cable and connector will make the device unable to work or even damage it. For optional IEEE1394 cable, please contact your local dealer.

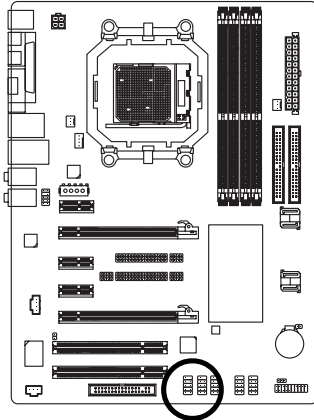

Pin No.	Definition
1	TPA+
2	TPA-
3	GND
4	GND
5	TPB+
6	TPB-
7	Power(12V)
8	Power(12V)
9	No Pin
10	GND

**16) CLR\_CMOS (Clear CMOS)**

You may clear the CMOS data to its default values by this header. To clear CMOS, temporarily short the two pins. Default doesn't include the jumper to avoid improper use of this header.

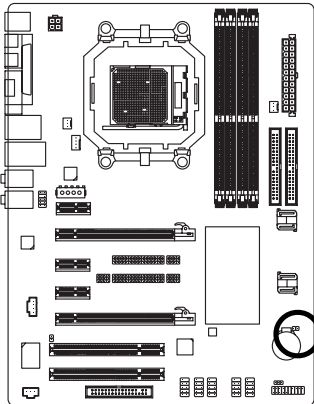

 Open: Normal

 Short: Clear CMOS

## 17) BATTERY

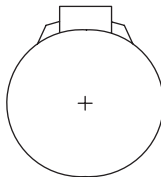
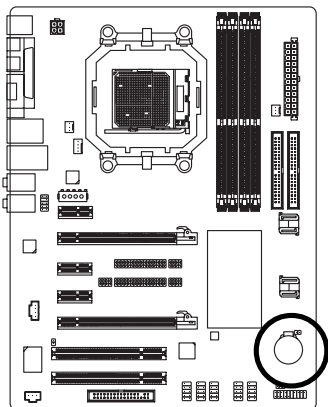

- ❖ Danger of explosion if battery is incorrectly replaced.
- ❖ Replace only with the same or equivalent type recommended by the manufacturer.
- ❖ Dispose of used batteries according to the manufacturer's instructions.

If you want to erase CMOS...

1. Turn off the computer and unplug the power cord.
2. Gently take out the battery and put it aside for about one minute. (Or you can use a metal object to connect the positive and negative pins in the battery holder to make them short for five seconds.)
3. Re-install the battery.
4. Plug the power cord in and turn on the computer.

## 18) SPDIF\_I (SPDIF In)

Use SPDIF IN feature only when your device has digital output function. Be careful with the polarity of the SPDIF\_IN connector. Check the pin assignment carefully while you connect the SPDIF cable, incorrect connection between the cable and connector will make the device unable to work or even damage it. For optional SPDIF cable, please contact your local dealer.

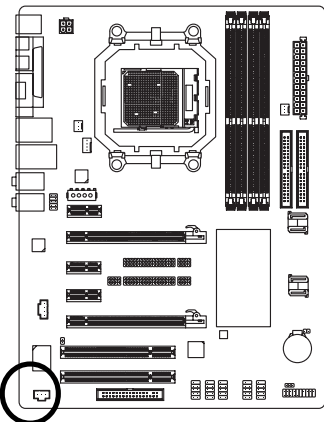

Pin No.	Definition
1	Power
2	SPDIFI
3	GND

## 19) CI (Chassis Intrusion, Case Open)

This 2-pin connector allows your system to detect if the chassis cover is removed. You can check the "Case Open" status in BIOS Setup.

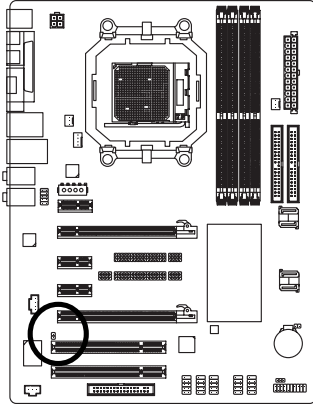

Pin No.	Definition
1	Signal
2	GND



## Chapter 2 BIOS Setup

BIOS (Basic Input and Output System) includes a CMOS SETUP utility which allows user to configure required settings or to activate certain system features.

The CMOS SETUP saves the configuration in the CMOS SRAM of the motherboard.

When the power is turned off, the battery on the motherboard supplies the necessary power to the CMOS SRAM.

When the power is turned on, pressing the <Del> button during the BIOS POST (Power-On Self Test) will take you to the CMOS SETUP screen. You can enter the BIOS setup screen by pressing "Ctrl + F1". If you wish to upgrade to a new BIOS, either GIGABYTE's Q-Flash or @BIOS utility can be used. Q-Flash allows the user to quickly and easily update or backup BIOS without entering the operating system.

@BIOS is a Windows-based utility that does not require users to boot to DOS before upgrading BIOS but directly download and update BIOS from the Internet.

### CONTROL KEYS

<↑><↓><←><→>	Move to select item
<Enter>	Select Item
<Esc>	Main Menu - Quit and not save changes into CMOS Status Page Setup Menu and Option Page Setup Menu - Exit current page and return to Main Menu
<Page Up>	Increase the numeric value or make changes
<Page Down>	Decrease the numeric value or make changes
<F1>	General help, only for Status Page Setup Menu and Option Page Setup Menu
<F2>	Item Help
<F5>	Restore the previous CMOS value from CMOS, only for Option Page Setup Menu
<F7>	Load the Optimized Defaults
<F8>	Q-Flash utility
<F9>	System Information
<F10>	Save all the CMOS changes, only for Main Menu

### Main Menu

The on-line description of the highlighted setup function is displayed at the bottom of the screen.

### Status Page Setup Menu / Option Page Setup Menu

Press <F1> to pop up a small help window that describes the appropriate keys to use and the possible selections for the highlighted item. To exit the Help Window press <Esc>.



Because BIOS flashing is potentially risky, please do it with caution and avoid inadequate operation that may result in system malfunction.

**<F12> : For Boot Menu**

Select boot sequence for onboard (or add-on cards) device.

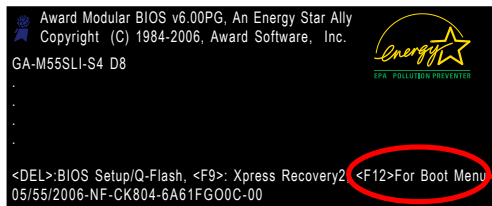

**<F12> For Boot Menu**

Use <↑> or <↓> to select a device, then press enter to accept . Press <ESC> to exit this menu.

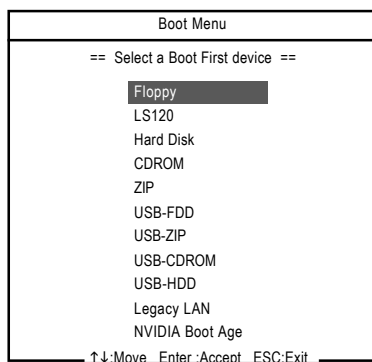

NOTE

The BIOS Setup menus described in this chapter are for reference only and may differ from the exact settings for your motherboard.

**The Main Menu (For example: BIOS Ver. :D8)**

Once you enter Award BIOS CMOS Setup Utility, the Main Menu (as figure below) will appear on the screen. Use arrow keys to select among the items and press <Enter> to accept or enter the sub-menu.

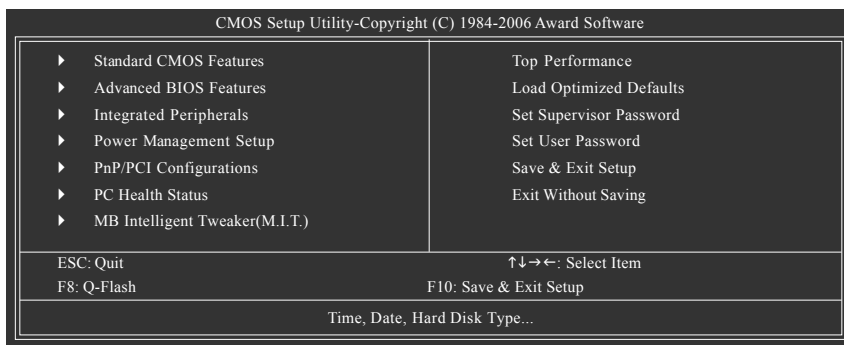

NOTE

If you can't find the setting you want, please press "Ctrl+F1" to search the advanced option hidden.

- **Standard CMOS Features**

This setup page includes all the items in standard compatible BIOS.

- **Advanced BIOS Features**

This setup page includes all the items of Award special enhanced features.

- **Integrated Peripherals**

This setup page includes all onboard peripherals.

- **Power Management Setup**

This setup page includes all the items of Green function features.

- **PnP/PCI Configuration**

This setup page includes all the configurations of PCI & PnP ISA resources.

- **PC Health Status**

This setup page is the System auto detect Temperature, voltage, fan, speed.

- **MB Intelligent Tweaker(M.I.T.)**

This setup page is control CPU clock and frequency ratio.

- **Top Performance**

If you wish to maximize the performance of your system, enable **Top Performance**.

- **Load Optimized Defaults**

Optimized Defaults indicates the value of the system parameters which the system would be in bestperformance configuration.

- **Set Supervisor Password**

Change, set, or disable password. It allows you to limit access to the system and Setup, or just to Setup.

- **Set User Password**

Change, set, or disable password. It allows you to limit access to the system.

- **Save & Exit Setup**

Save CMOS value settings to CMOS and exit setup.

- **Exit Without Saving**

Abandon all CMOS value changes and exit setup.





- ▶▶ Cylinder                    Number of cylinders
- ▶▶ Head                        Number of heads
- ▶▶ Precomp                    Write precomp
- ▶▶ Landing Zone              Landing zone
- ▶▶ Sector                      Number of sectors

#### ☞ Drive A

The category identifies the types of floppy disk drive A or drive B that has been installed in the computer.

- ▶▶ None                        No floppy drive installed
- ▶▶ 360K, 5.25"                5.25 inch PC-type standard drive; 360K byte capacity.
- ▶▶ 1.2M, 5.25"                5.25 inch AT-type high-density drive; 1.2M byte capacity  
(3.5 inch when 3 Mode is Enabled).
- ▶▶ 720K, 3.5"                 3.5 inch double-sided drive; 720K byte capacity
- ▶▶ 1.44M, 3.5"                3.5 inch double-sided drive; 1.44M byte capacity. (Default value)
- ▶▶ 2.88M, 3.5"                3.5 inch double-sided drive; 2.88M byte capacity.

#### ☞ Halt on

The category determines whether the computer will stop if an error is detected during power up.

- ▶▶ No Errors                    The system boot will not stop for any error that may be detected and you will be prompted.
- ▶▶ All Errors                    Whenever the BIOS detects a non-fatal error the system will be stopped.
- ▶▶ All, But Keyboard            The system boot will not stop for a keyboard error; it will stop for all other errors. (Default value)
- ▶▶ All, But Diskette            The system boot will not stop for a disk error; it will stop for all other errors.
- ▶▶ All, But Disk/Key            The system boot will not stop for a keyboard or disk error; it will stop for all other errors.

#### ☞ Floppy 3 Mode Support (for Japan Area)

- ▶▶ Disabled                    Normal Floppy Drive. (Default value)
- ▶▶ Drive A                      Drive A is 3 mode Floppy Drive.



### ☞ Password Check

- ▶▶ System      The system can not boot and can not access to Setup page will be denied if the correct password is not entered at the prompt.
- ▶▶ Setup        The system will boot, but access to Setup will be denied if the correct password is not entered at the prompt. (Default value)

### ☞ Away Mode

- ▶▶ Disabled     Disable this function. (Default value)
- ▶▶ Enabled      Enable Away Mode in Windows XP Media Center operating system.  
(Away Mode: Enables the system to silently perform unattended tasks while in a low-power mode that appears off. )

### ☞ Init Display First

This feature allows you to select the first initiation of the monitor display from which card when you install a PCI card and a PCI Express VGA card on the motherboard.

- ▶▶ PEG            Set Init display first to PCI Express VGA card. (Default value)
- ▶▶ PCI slot        Set Init display first to PCI.
- ▶▶ PEG (Slot2)    Set Init display first to PCI Express VGA card (Slot 2).

## 2-3 Integrated Peripherals

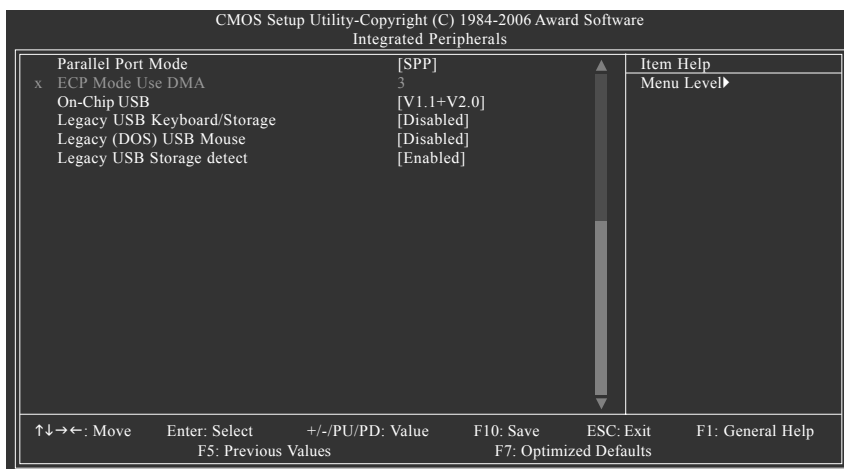
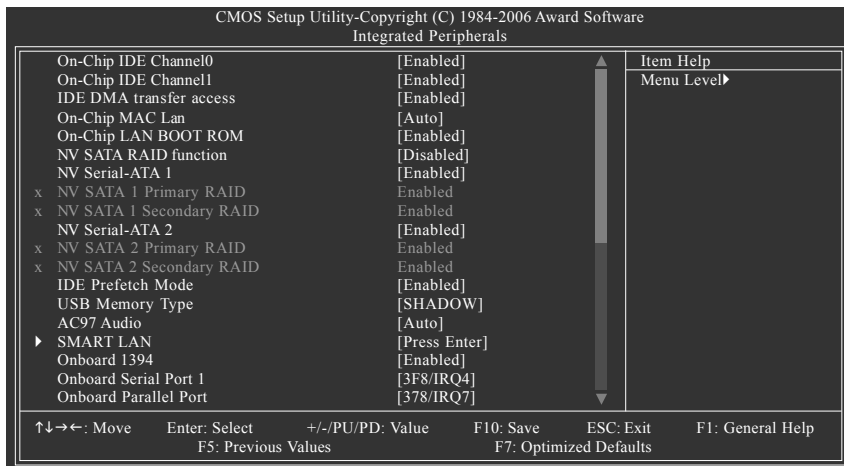

- ☞ **On-Chip IDE Channel0**
  - ▶▶ Enabled      Enable onboard 1st channel IDE port. (Default value)
  - ▶▶ Disabled     Disable onboard 1st channel IDE port.
- ☞ **On-Chip IDE Channel1**
  - ▶▶ Enabled      Enable onboard 2nd channel IDE port. (Default value)
  - ▶▶ Disabled     Disable onboard 2nd channel IDE port.
- ☞ **IDE DMA transfer access**
  - ▶▶ Enabled      Enable IDE DMA transfer access. (Default value)
  - ▶▶ Disabled     Disable this function.

### ☞ **On-Chip MAC Lan**

- ▶▶ Auto            Auto-detect onboard LAN chip function. (Default value)
- ▶▶ Disabled        Disable onboard LAN chip function.

### ☞ **On-Chip LAN BOOT ROM**

This function decide whether to invoke the boot ROM of the onboard LAN chip.

- ▶▶ Enabled        Enable this function. (Default value)
- ▶▶ Disabled        Disable this function.

### ☞ **NV SATA RAID function**

- ▶▶ Enabled        Enable NV SATA RAID function.
- ▶▶ Disabled        Disable this function. (Default value)

### ☞ **NV Serial-ATA 1**

- ▶▶ Enabled        Enable Serial ATA 1 supported. (Default value)
- ▶▶ Disabled        Disable Serial ATA 1 supported.

### ☞ **NV SATA 1 Primary RAID**

- ▶▶ Enabled        Enable 1st SATA primary RAID function.(Default value)
- ▶▶ Disabled        Disable this function.

### ☞ **NV SATA 1 Secondary RAID**

- ▶▶ Enabled        Enable 1st SATA secondary RAID function. (Default value)
- ▶▶ Disabled        Disable this function.

### ☞ **NV Serial-ATA 2**

- ▶▶ Enabled        Enable Serial ATA 2 supported. (Default value)
- ▶▶ Disabled        Disable Serial ATA 2 supported.

### ☞ **NV SATA 2 Primary RAID**

- ▶▶ Enabled        Enable 2nd SATA primary RAID function. (Default value)
- ▶▶ Disabled        Disable this function.

### ☞ **NV SATA 2 Secondary RAID**

- ▶▶ Enabled        Enable 2nd SATA secondary RAID function. (Default value)
- ▶▶ Disabled        Disable this function.

### ☞ **IDE Prefetch Mode**

- ▶▶ Enabled        Enable IDE Prefetch mode. (Default value)
- ▶▶ Disabled        Disable IDE Prefetch mode.

### ☞ **USB Memory Type**

- ▶▶ SHADOW            Set USB memory type to SHADOW. (Default value)
- ▶▶ Base Memory(640K)    Set USB memory type to base memory(640K).

### ☞ **AC97 Audio**

- ▶▶ Auto            Enable onboard AC'97 audio function. (Default value)
- ▶▶ Disabled        Disable this function.

## SMART LAN (LAN Cable Diagnostic Function)

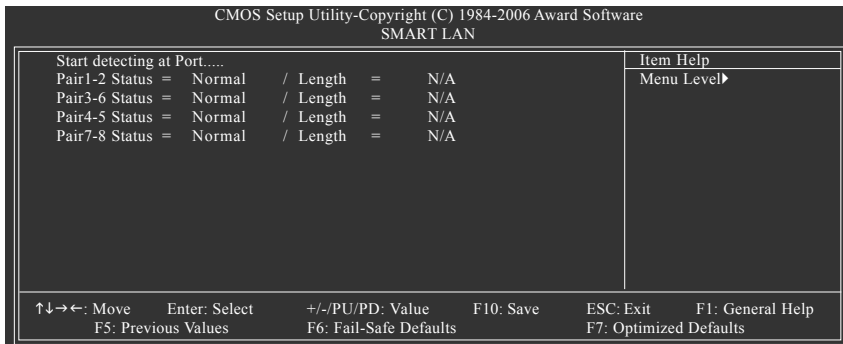

This motherboard incorporates cable diagnostic feature designed to detect the status of the attached LAN cable. This feature will detect cabling issue and report the approximate distance to the fault or short. Refer to the following information for diagnosing your LAN cable:

### ▶ When LAN Cable Is Functioning Normally...

1. If no cable problem is detected on the LAN cable connected to a Gigabit hub, the **Status** fields of Pair 1-2, Pair 3-6, Pair 4-5, and Pair 7-8 will show **Normal** and the **Length** fields will show **N/A**, as shown in the figure above.
2. If no cable problem is detected on the LAN cable connected to a 10/100 Mbps hub, the **Status** fields of Pair 1-2 and Pair 3-6 will show **Normal** and the **Length** fields will show **N/A**. However, because Pair 4-5 and Pair 7-8 are not used in a 10/100 Mbps environment, their **Status** fields will show **Short** or **Open**, and the length shown is the approximate length of the attached LAN cable.

### ▶ When a Cable Problem Occurs...

If a cable problem occurs on a specified pair of wires, the **Status** field will show **Short** or **Open** and the length shown will be the approximate distance to the fault or short. For example, if it shows `Pair1-2 Status = Short / Length = 1.6m`, it means that a fault or short might occur at about 1.6m on Pair 1-2.

### ▶ When No LAN Cable Is Attached...

If no LAN cable is attached to the motherboard, the **Status** fields of all four pairs of wires will show **Open**.

### ☞ Onboard 1394 Function

- ▶▶ Enabled Enable onboard IEEE1394 function.(Default value)
- ▶▶ Disabled Disable onboard IEEE1394 function.

### ☞ Onboard Serial Port 1

- ▶▶ Auto BIOS will automatically setup the Serial port 1 address.
- ▶▶ 3F8/IRQ4 Enable onboard Serial port 1 and address is 3F8/IRQ4. (Default value)
- ▶▶ 2F8/IRQ3 Enable onboard Serial port 1 and address is 2F8/IRQ3.
- ▶▶ 3E8/IRQ4 Enable onboard Serial port 1 and address is 3E8/IRQ4.
- ▶▶ 2E8/IRQ3 Enable onboard Serial port 1 and address is 2E8/IRQ3.
- ▶▶ Disabled Disable onboard Serial port 1.

### ☞ Onboard Parallel Port

- ▶▶ Disabled Disable onboard LPT port.
- ▶▶ 378/IRQ7 Enable onboard LPT port and address is 378/IRQ7. (Default value)
- ▶▶ 278/IRQ5 Enable onboard LPT port and address is 278/IRQ5.
- ▶▶ 3BC/IRQ7 Enable onboard LPT port and address is 3BC/IRQ7.

### ☞ Parallel Port Mode

- ▶▶ SPP Using Parallel port as Standard Parallel Port. (Default value)
- ▶▶ EPP Using Parallel port as Enhanced Parallel Port.
- ▶▶ ECP Using Parallel port as Extended Capabilities Port.
- ▶▶ ECP+EPP Using Parallel port as ECP and EPP mode.

### ☞ ECP Mode Use DMA

- ▶▶ 3 Set ECP Mode Use DMA to 3. (Default value)
- ▶▶ 1 Set ECP Mode Use DMA to 1.

### ☞ On-Chip USB

- ▶▶ Disabled Disable this function if you are not using onboard USB function.
- ▶▶ V1.1+V2.0 Enable USB 1.1 and USB 2.0 controller. (Default value)
- ▶▶ V1.1 Enable only USB 1.1 controller.

### ☞ Legacy USB Keyboard/Storage

- ▶▶ Enabled Enable USB keyboard support in the MS-DOS environment.
- ▶▶ Disabled Disable this function. (Default value)

### ☞ Legacy (DOS) USB Mouse

- ▶▶ Enabled Enable USB mouse support in the MS-DOS environment.
- ▶▶ Disabled Disable this function. (Default value)

### ☞ Legacy USB Storage detect

- ▶▶ Enabled Enable USB storage detection in the MS-DOS environment. (Default value)
- ▶▶ Disabled Disable this function.

## 2-4 Power Management Setup

CMOS Setup Utility-Copyright (C) 1984-2006 Award Software Power Management Setup		
ACPI Suspend Type	[S1(POS)]	Item Help
Soft-Off by Power button	[Instant-off]	Menu Level▶
PME Event Wake Up	[Enabled]	
Modem Ring On	[Disabled]	
USB Resume from Suspend	[Disabled]	
Power-On by Alarm	[Disabled]	
x Day of Month Alarm	Everyday	
x Time (hh:mm:ss) Alarm	0 : 0 : 0	
Power On By Mouse	[Disabled]	
Power On By Keyboard	[Disabled]	
x KB Power ON Password	Enter	
AC BACK Function	[Soft-Off]	

↑↓←→: Move    Enter: Select    +/-/PU/PD: Value    F10: Save    ESC: Exit    F1: General Help  
F5: Previous Values    F7: Optimized Defaults

### ACPI Suspend Type

- ▶▶ S1(POS)      Set ACPI suspend type to S1/POS(Power On Suspend). (Default value)
- ▶▶ S3(STR)      Set ACPI suspend type to S3/STR(Suspend To RAM).

### Soft-Off by Power button

- ▶▶ Instant-off      Press power button then Power off instantly. (Default value)
- ▶▶ Delay 4 Sec      Press power button 4 seconds to Power off. Enter suspend if button is pressed less than 4 seconds.

### PME Event Wake Up

This feature requires an ATX power supply that provides at least 1A on the 5VSB lead.

- ▶▶ Disabled      Disable this function.
- ▶▶ Enabled      Enable PME as wake up event. (Default value)

### Modem Ring On

An incoming call via modem can awake the system from any suspend state.

- ▶▶ Disabled      Disable Modem Ring on function. (Default value)
- ▶▶ Enabled      Enable Modem Ring on function.

### USB Resume from Suspend

- ▶▶ Disabled      Disable this function. (Default value)
- ▶▶ Enabled      Enable USB device wake up system from suspend type.

### Power-On by Alarm

You can set "Resume by Alarm" item to enabled and key in Date/Time to power on system.

- ▶▶ Disabled      Disable this function. (Default value)
- ▶▶ Enabled      Enable alarm function to POWER ON system.

If Power-On by Alarm is Enabled.

- ▶▶ Day of Month Alarm :      Everyday, 1~31
- ▶▶ Time (hh: mm: ss) Alarm :      (0~23) : (0~59) : (0~59)



☞ **Power On By Mouse**

- ▶▶ Disabled      Disable this function. (Default value)
- ▶▶ Double Click    Double click on PS/2 mouse left button to power on the system.

☞ **Power On By Keyboard**

- ▶▶ Disabled      Disable this function. (Default value)
- ▶▶ Password      Enter from 1 to 5 characters to set the Keyboard Power On Password.
- ▶▶ Any KEY       Press any key to power on the system.
- ▶▶ Keyboard 98    If your keyboard have "POWER Key" button, you can press the key to power on the system.

☞ **KB Power ON Password**

When "Power On by Keyboard" set at Password, you can set the password here.

- ▶▶ Enter            Input password (from 1 to 5 characters) and press Enter to set the Keyboard Power On password.

☞ **AC BACK Function**

- ▶▶ Soft-Off        When AC-power back to the system, the system will be in "Off" state. (Default value)
- ▶▶ Full-On         When AC-power back to the system, the system always in "On" state.





### ☞ CPU Warning Temperature

- ▶▶ 60°C / 140°F Monitor CPU temperature at 60°C / 140°F.
- ▶▶ 70°C / 158°F Monitor CPU temperature at 70°C / 158°F.
- ▶▶ 80°C / 176°F Monitor CPU temperature at 80°C / 176°F.
- ▶▶ 90°C / 194°F Monitor CPU temperature at 90°C / 194°F.
- ▶▶ Disabled Disable this function. (Default value)

### ☞ CPU Smart FAN Control (Note)

- ▶▶ Disabled Disable this function.
- ▶▶ Enabled When this function is enabled, CPU fan will run at different speed depending on CPU temperature. Users can adjust the fan speed with Easy Tune based on their requirements. (Default value)

### ☞ CPU Smart FAN Mode

This option is available only when CPU Smart FAN Control is enabled.

- ▶▶ Auto BIOS autodetects the type of CPU fan you installed and sets the optimal CPU Smart FAN control mode for it. (Default Value)
- ▶▶ Voltage Set to Voltage when you use a CPU fan with a 3-pin fan power cable.
- ▶▶ PWM Set to PWM when you use a CPU fan with a 4-pin fan power cable.

(Note) Whether the CPU Smart FAN Control function is supported will depend on the CPU you install.

## 2-7 MB Intelligent Tweaker(M.I.T.)

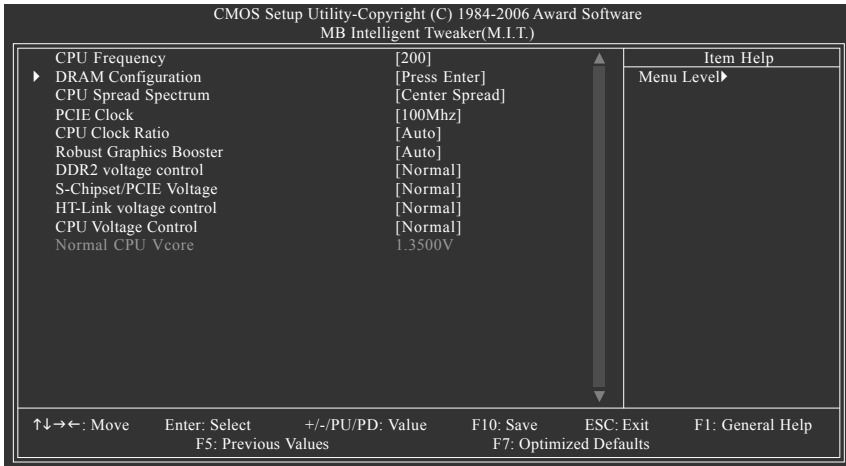

### ☞ DRAM Configuration

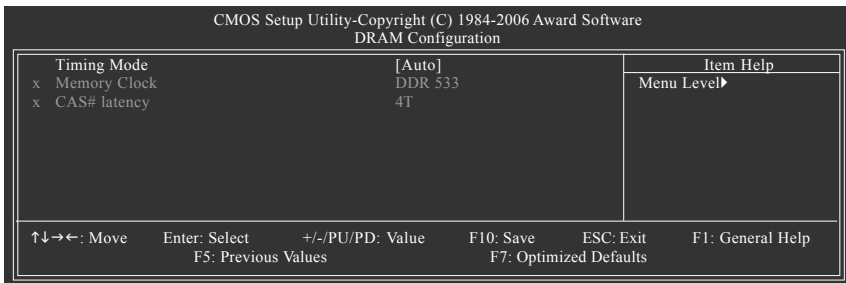

Incorrect using these features may cause your system broken. For power end-user use only.

### ☞ CPU Frequency

▶▶ 200 ~ 456 Set CPU frequency from 200Mhz to 456Mhz.

### ☞ Timing Mode

▶▶ Auto Set DDR Timing Mode automatically. (Default value)  
▶▶ Manual Set DDR Timing Mode manually.

### ☞ Memory Clock

▶▶ 400Mhz ~ 800Mhz Set Memory clock from 400Mhz to 800Mhz.

### ☞ CAS# latency

▶▶ 3T/4T/5T/6T Set CAS Latency to 3T/4T/5T/6T (Default value:4T)

### ☞ CPU Spread Spectrum

- ▶▶ Disabled                      Disable CPU Spread Spectrum.
- ▶▶ Center Spread                Set CPU Spread Spectrum to Center Spread. (Default value)

### ☞ PCIE Clock

- ▶▶ 100Mhz ~ 150Mhz            Set PCI-E clock from 100Mhz to 150Mhz.

### ☞ CPU clock Ratio

This setup option will automatically assign by CPU detection. The option will display "Locked" and read only or will not show up if the CPU ratio is not changeable.

### ☞ Robust Graphics Booster

Select the options can enhance the VGA graphics card bandwidth to get higher performance.

- ▶▶ Auto                              Set Robust Graphics Booster to Auto. (Default value)
- ▶▶ Fast                                Set Robust Graphics Booster to Fast.
- ▶▶ Turbo                              Set Robust Graphics Booster to Turbo.

### ☞ DDR2 voltage control

- ▶▶ Normal                            Supply DDR2 voltage as DDR2 required. (Default value)
- ▶▶ +0.1v                            Increase DDR2 voltage +0.1V.
- ▶▶ +0.2v                            Increase DDR2 voltage +0.2V.
- ▶▶ +0.3v                            Increase DDR2 voltage +0.3V.

### ☞ S-Chipset / PCI-E voltage

- ▶▶ Normal                            Set South Chipset / PCI-E voltage as Chipset core PCI-E required.(Default value)
- ▶▶ +0.1v                            Increase South Chipset / PCI-E voltage +0.1V.
- ▶▶ +0.2v                            Increase South Chipset / PCI-E voltage +0.2V.
- ▶▶ +0.3v                            Increase South Chipset / PCI-E voltage +0.3V.

### ☞ HT-Link voltage control

- ▶▶ Normal                            Supply HT-Link voltage as HT-Link required. (Default value)
- ▶▶ +0.1v                            Increase HT-Link voltage +0.1V.
- ▶▶ +0.2v                            Increase HT-Link voltage +0.2V.
- ▶▶ +0.3v                            Increase HT-Link voltage +0.2V.

### ☞ CPU Voltage Control

- ▶▶ Supports adjustable CPU Vcore from 0.800V to 1.750V. (Default value: Normal)

### ☞ Normal CPU Vcore

- ▶▶ Display your CPU Vcore voltage.

## 2-8 Top Performance

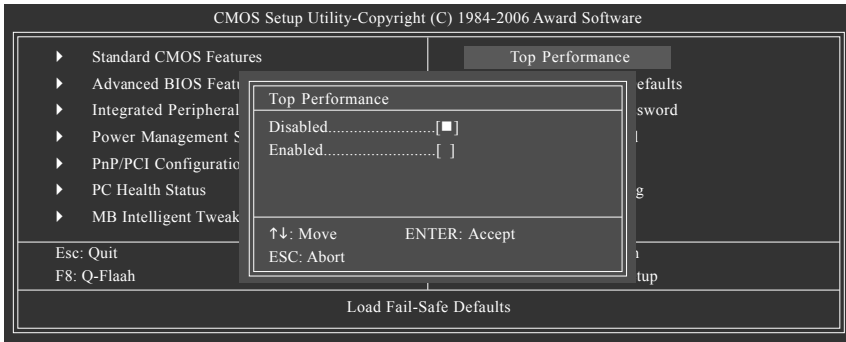

If you wish to maximize the performance of your system, enable "Top Performance."

- ▶▶ Disabled Disable this function. (Default Value)
- ▶▶ Enabled Enable Top Performance function.

☛\* "Top Performance" will increase H/W working speed. Different system configuration (both H/W component and OS) will effect the result. For example, the same H/W configuration might not run properly with Windows XP, but works smoothly with Windows NT. Therefore, if your system is not perform enough, the reliability or stability problem will appear sometimes, and we will recommend you disabling the option to avoid the problem as mentioned above.

## 2-9 Load Optimized Defaults

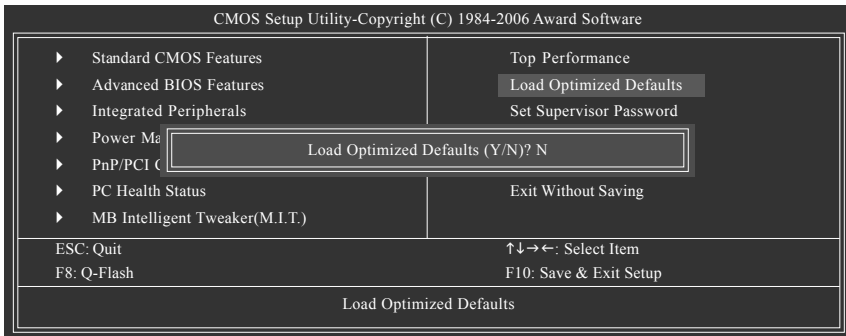

Selecting this field loads the factory defaults for BIOS and Chipset Features which the system automatically detects.

## 2-10 Set Supervisor/User Password

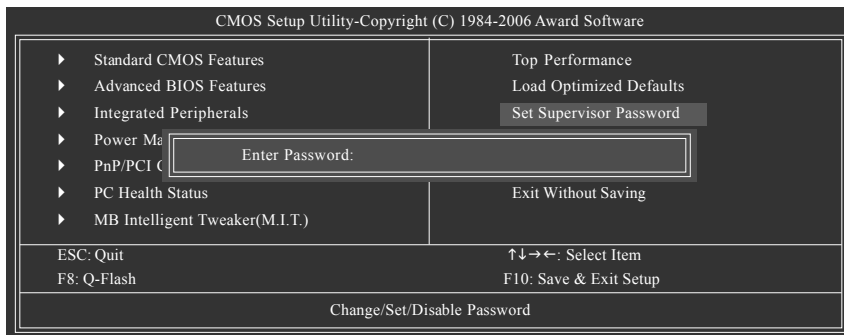

When you select this function, the following message will appear at the center of the screen to assist you in creating a password.

Type the password, up to eight characters, and press <Enter>. You will be asked to confirm the password. Type the password again and press <Enter>. You may also press <Esc> to abort the selection and not enter a password.

To disable password, just press <Enter> when you are prompted to enter password. A message "PASSWORD DISABLED" will appear to confirm the password being disabled. Once the password is disabled, the system will boot and you can enter Setup freely.

The BIOS Setup program allows you to specify two separate passwords: SUPERVISOR PASSWORD and a USER PASSWORD. When disabled, anyone may access all BIOS Setup program function. When enabled, the Supervisor password is required for entering the BIOS Setup program and having full configuration fields, the User password is required to access only basic items.

If you select "System" at "Password Check" in Advance BIOS Features Menu, you will be prompted for the password every time the system is rebooted or any time you try to enter Setup Menu.

If you select "Setup" at "Password Check" in Advance BIOS Features Menu, you will be prompted only when you try to enter Setup.



## 2-11 Save & Exit Setup

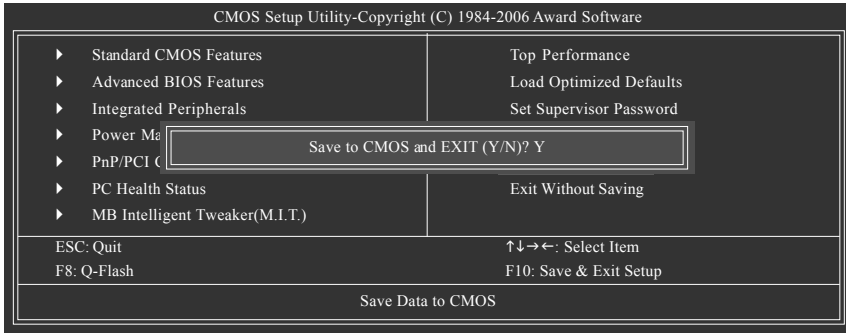

Type "Y" will quit the Setup Utility and save the user setup value to RTC CMOS.  
Type "N" will return to Setup Utility.

## 2-12 Exit Without Saving

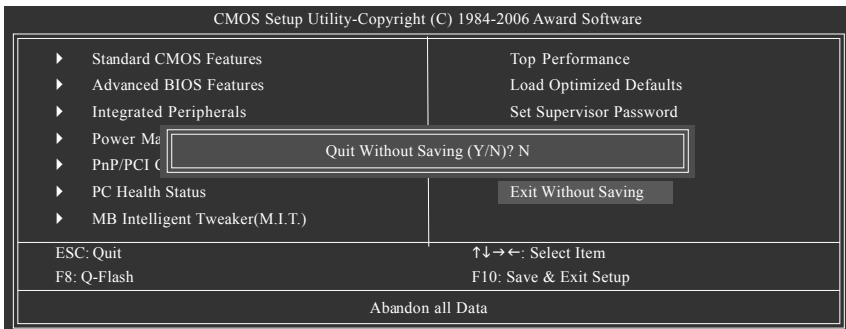

Type "Y" will quit the Setup Utility without saving to RTC CMOS.  
Type "N" will return to Setup Utility.



## Chapter 3 Drivers Installation



Pictures below are shown in Windows XP.

Insert the driver CD-title that came with your motherboard into your CD-ROM drive, the driver CD-title will auto start and show the installation guide. If not, please double click the CD-ROM device icon in "My computer", and execute the Run.exe.

### 3-1 Install Chipset Drivers

**"Xpress Install " is now analyzing your computer...99%**

After insert the driver CD, "Xpress Install" will scan automatically the system and then list all the drivers that recommended to install. Please pick the item that you want and press "install" followed the item; or you can press "Xpress Install" to install all items defaulted.

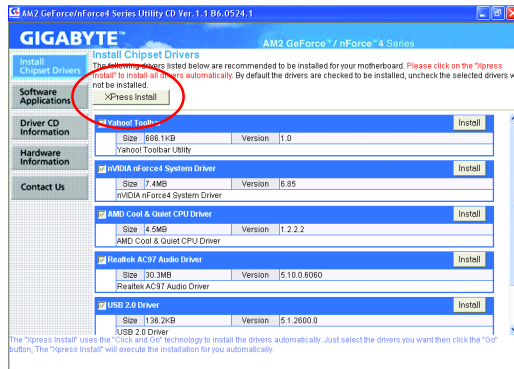

Some device drivers will restart your system automatically. After restarting your system the "Xpress Install" will continue to install other drivers.

System will reboot automatically after install the drivers, afterward you can install others application.



For USB2.0 driver support under Windows XP operating system, please use Windows Service Pack. After install Windows Service Pack, it will show a question mark "?" in "Universal Serial Bus controller" under "Device Manager". Please remove the question mark and restart the system (System will auto-detect the right USB2.0 driver).

## 3-2 Software Applications

This page displays all the tools that Gigabyte developed and some free software, you can choose anyone you want and press "install" to install them.

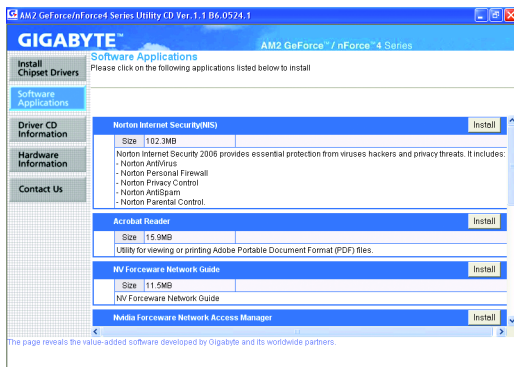

## 3-3 Driver CD Information

This page lists the contents of software and drivers in this CD-title.

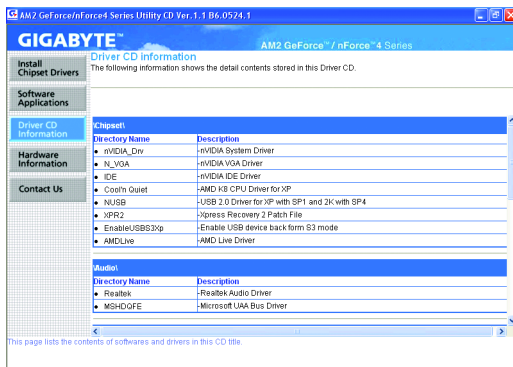

## 3-4 Hardware Information

This page lists all device you have for this motherboard.

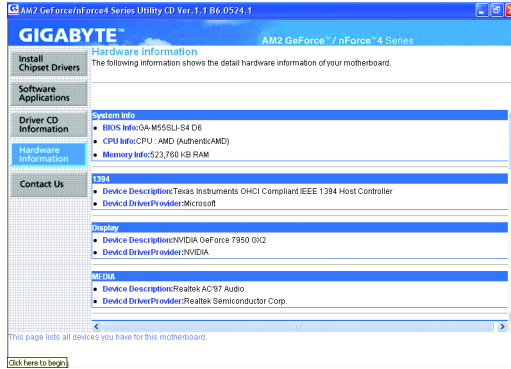

## 3-5 Contact Us

Please see the last page for details.





## Chapter 4 Appendix

### 4-1-1 EasyTune 5 Introduction

EasyTune 5 presents the most convenient Windows based system performance enhancement and manageability utility. Featuring several powerful yet easy to use tools such as 1) Overclocking for enhancing system performance, 2) C.I.A. and M.I.B. for special enhancement for CPU and Memory, 3) Smart-Fan control for managing fan speed control of both CPU cooling fan and North-Bridge Chipset cooling fan, 4) PC health for monitoring system status.<sup>(Note)</sup>

#### User Interface Overview



	Button / Display	Description
1.	Overclocking	Enters the Overclocking setting page
2.	C.I.A./C.I.A.2 and M.I.B.	Enters the C.I.A./2 and M.I.B. setting page
3.	Smart-Fan	Enters the Smart-Fan setting page
4.	PC Health	Enters the PC Health setting page
5.	GO	Confirmation and Execution button
6.	"Easy Mode" & "Advance Mode"	Toggles between Easy and Advance Mode
7.	Display screen	Display panel of CPU frequency
8.	Function display LEDs	Shows the current functions status
9.	GIGABYTE Logo	Log on to GIGABYTE website
10.	Help button	Display EasyTune™ 5 Help file
11.	Exit or Minimize button	Quit or Minimize EasyTune™ 5 software

(Note) EasyTune 5 functions may vary depending on different motherboards.

## 4-1-2 Xpress Recovery2 Introduction



Xpress Recovery2 is designed to provide quick backup and restoration of hard disk data. Supporting Microsoft operating systems including Windows XP/2000/NT/98/Me and DOS, and file systems including FAT16, FAT32, and NTFS, Xpress Recovery2 is able to back up data on hard disks on PATA and SATA IDE controllers. After Xpress Recovery2 is executed from CD-ROM for the first time, it will stay permanent in your hard disk. If you wish to run Xpress Recovery2 later, you can simply press F9 during system bootup to enter Xpress Recovery2 without the CD-ROM.

### System requirements:

1. Intel x86 platforms
2. At least 64M bytes of system memory
3. VESA-supported VGA cards

### How to use the Xpress Recovery2

Initial access by booting from CD-ROM and subsequent access by pressing the F9 key:

Steps: After entering BIOS Setup, go to **Advanced BIOS Feature** and set to boot from CD-ROM. Save the settings and exit the BIOS Setup. Insert the provided driver CD into your CD-ROM drive. Upon system restart, the message which says "Boot from CD/DVD:" will appear in the bottom left corner of the screen. Press any key to enter Xpress Recovery2.

After the steps above are completed, subsequent access to Xpress Recovery2 can be made by simply pressing the <F9> key during system power-on.



Boot from CD/DVD:

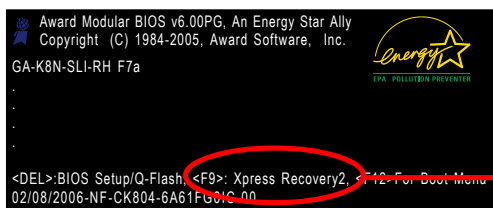

<F9> Xpress Recovery2



1. If you have already entered Xpress Recovery2 by booting from the CD-ROM, you can enter Xpress Recovery2 by pressing the <F9> key in the future.
2. System storage capacity and the reading/writing speed of the hard disk will affect the data backup speed.
3. It is recommended that Xpress Recovery2 be immediately installed once you complete installations of OS and all required drivers as well as software.



## The Main Screen of Xpress Recovery2



### 1. RESTORE:

Restore the backed-up data to your hard disk.  
(This button will not appear if there is no backup file.)

### 2. BACKUP:

Back up data from hard disk.

### 3. REMOVE:

Remove previously-created backup files to release disk space.  
(This button will not appear if there is no backup file.)

### 4. REBOOT:

Exit the main screen and restart the system.

## Limitations:

1. Not compatible to Xpress Recovery.
2. For the use of Xpress Recovery2, a primary partition must be reserved.
3. Xpress Recovery2 will store the backup file at the end of the hard disk, so free space available on the hard disk for the backup file must be allocated in advance. (A minimum 4GB is recommended but the actual space is dependent on the size of the data to be backed up)
4. Capable of backing up hard disks installed with Windows operating systems including DOS and Windows XP/2000/NT/9x/Me.
5. USB hard disks are currently not supported.
6. Does not support RAID/AHCI (class code 0104/0106) hard disks.
7. Capable of backing up and restoring only the first physical hard disk.

Hard disks detection sequence is as follows:

- a. PATA IDE primary channel
- b. PATA IDE secondary channel
- c. SATA IDE channel 1
- d. SATA IDE channel 2
- e. SATA IDE channel 3
- f. SATA IDE channel 4

## Precautions:

1. When using hard disks with more than 128G under Windows 2000, be sure to execute the EnableBigLba.exe program from the driver CD before data backup.
2. It is normal that data backup takes longer time than data restoration.
3. Xpress Recovery2 is compliant with the GPL regulations.
4. On a few motherboards based on Nvidia chipsets, BIOS update is required for Xpress Recovery2 to correctly identify RAID and SATA IDE mode. Please contact your motherboard manufacturer.

### 4-1-3 Flash BIOS Method Introduction



#### Method 1 : Q-Flash™ Utility

Q-Flash™ is a BIOS flash utility embedded in Flash ROM. With this utility, users only have to stay in the BIOS menu when they want to update BIOS. Q-Flash™ allows users to flash BIOS without any utility in DOS or Windows. Using Q-Flash™ indicating no more fooling around with any complicated instructions and operating system since it is in the BIOS menu.



Please note that because updating BIOS has potential risk, please do it with caution!! We are sorry that Gigabyte Technology Co., Ltd is not responsible for damages of system because of incorrect manipulation of updating BIOS to avoid any claims from end-users.

#### Before You Begin:

Before you start updating BIOS with the Q-Flash™ utility, please follow the steps below first.

1. Download the latest BIOS for your motherboard from Gigabyte's website.
2. Extract the BIOS file downloaded and save the BIOS file (the one with model name.Fxx. For example, 8KNXP.U.Fba) to a floppy disk.
3. Reboot your PC and press **Del** to enter BIOS menu.

The BIOS upgrading guides below are separated into two parts.

If your motherboard has dual-BIOS, please refer to **Part One**.

If your motherboard has single-BIOS, please refer to **Part Two**.

#### Part One:

#### Updating BIOS with Q-Flash™ Utility on Dual BIOS Motherboards.

Some of Gigabyte motherboards are equipped with dual BIOS. In the BIOS menu of the motherboards supporting Q-Flash and Dual BIOS, the Q-Flash utility and Dual BIOS utility are combined in the same screen. This section only deals with how to use Q-Flash utility.

**In the following sections, we take GA-8KNXP Ultra as the example to guide you how to flash BIOS from an older version to the latest version. For example, from Fa3 to Fba.**

The BIOS file is Fa3  
before updating

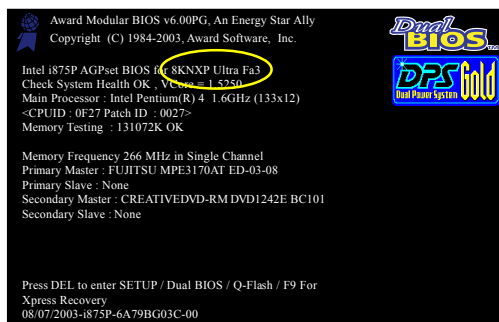

**Entering the Q-Flash™ utility:**

Step1: To use Q-Flash utility, you must press **Del** in the boot screen to enter BIOS menu.

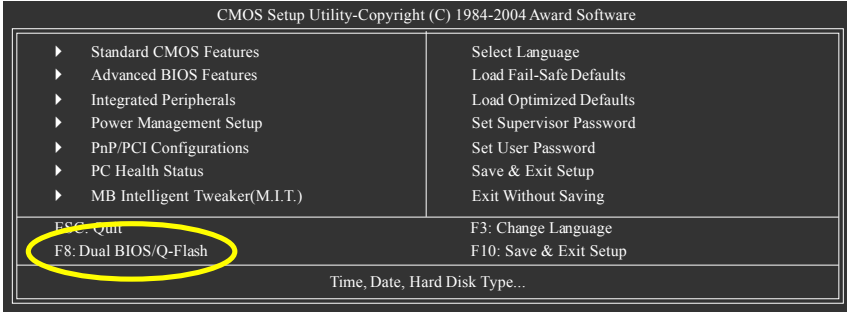

Step 2: Press **F8** button on your keyboard and then **Y** button to enter the Dual BIOS/Q-Flash utility.

**Exploring the Q-Flash™ / Dual BIOS utility screen**

The Q-Flash / Dual BIOS utility screen consists of the following key components.

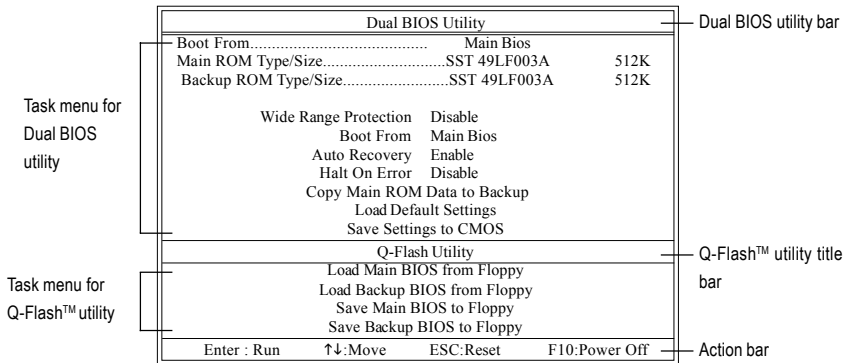

**Task menu for Dual BIOS utility:**

Contains the names of eight tasks and two item showing information about the BIOS ROM type. Blocking a task and pressing Enter key on your keyboard to enable execution of the task.

**Task menu for Q-Flash utility:**

Contains the names of four tasks. Blocking a task and pressing Enter key on your keyboard to enable execution of the task.

**Action bar:**

Contains the names of four actions needed to operate the Q-Flash/Dual BIOS utility. Pressing the buttons mentioned on your keyboards to perform these actions.



- Press Y button on your keyboard after you are sure to update BIOS.  
Then it will begin to update BIOS. The progress of updating BIOS will be displayed.



Please do not take out the floppy disk when it begins flashing BIOS.

- Press any keys to return to the Q-Flash menu when the BIOS updating procedure is completed.

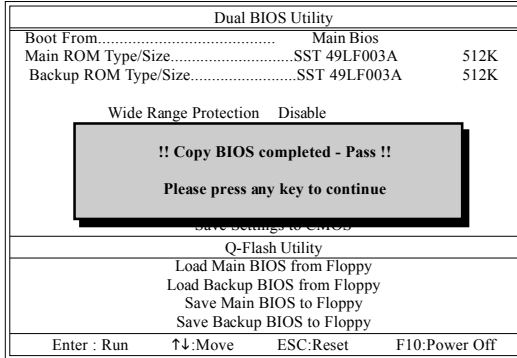

You can repeat Step 1 to 4 to flash the backup BIOS, too.

- Press Esc and then Y button to exit the Q-Flash utility. The computer will restart automatically after you exit Q-Flash.

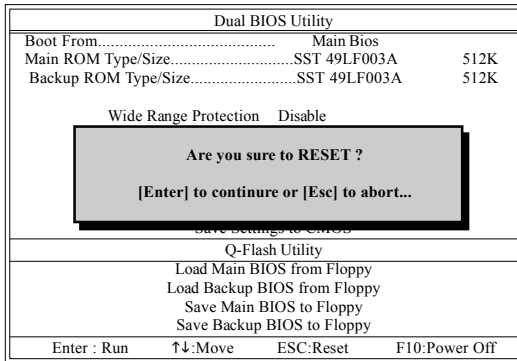

After system reboots, you may find the BIOS version on your boot screen becomes the one you flashed.

The BIOS file becomes Fab after updating.

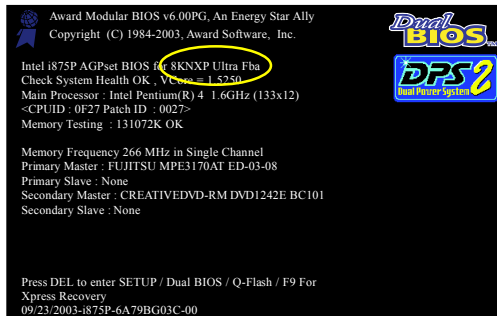

6. Press **Del** to enter BIOS menu after system reboots. When you are in BIOS menu, move to **Load Optimized Defaults** item and press **Enter** to load BIOS Optimized Defaults. Normally the system redetects all devices after BIOS has been upgraded. Therefore, we highly recommend reloading the BIOS defaults after BIOS has been upgraded.

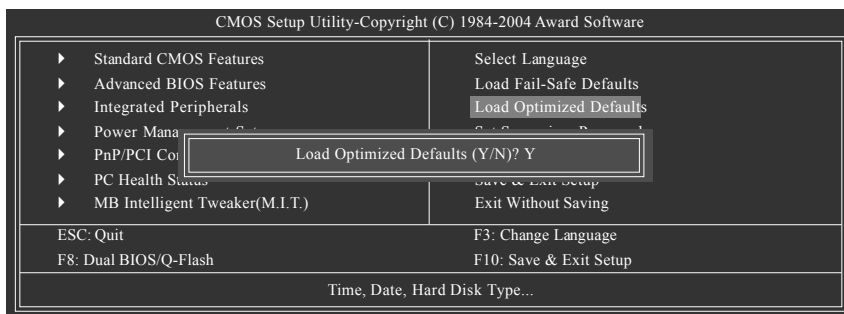

Press **Y** on your keyboard to load defaults.

7. Select **Save & Exit Setup** item to save the settings to CMOS and exit the BIOS menu. System will reboot after you exit the BIOS menu. The procedure is completed.

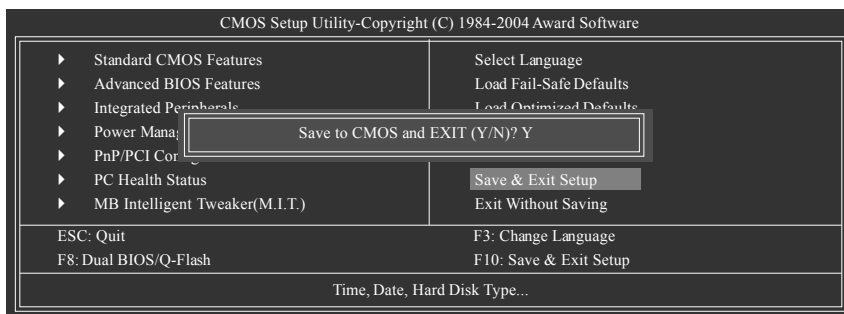

Press **Y** on your keyboard to save and exit.

## Part Two:

### Updating BIOS with Q-Flash™ Utility on Single-BIOS Motherboards.

This part guides users of single-BIOS motherboards how to update BIOS using the Q-Flash™ utility.

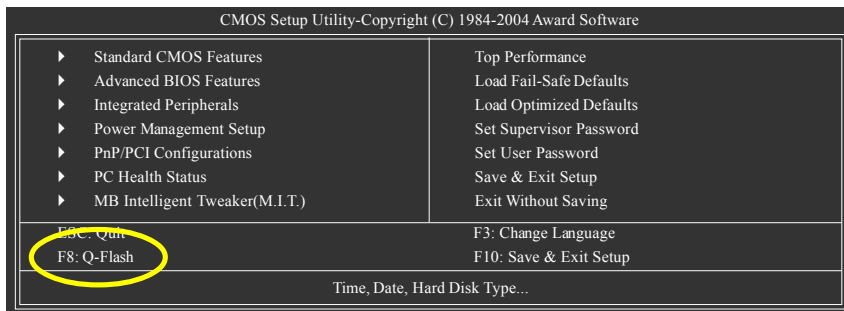

## Exploring the Q-Flash™ utility screen

The Q-FlashBIOS utility screen consists of the following key components.

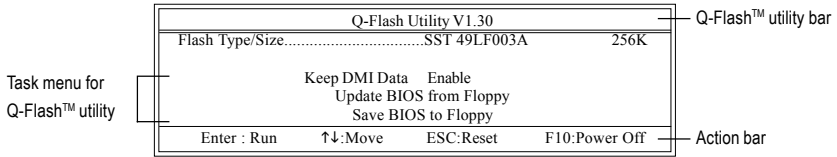

### Task menu for Q-Flash utility:

Contains the names of three tasks. Blocking a task and pressing Enter key on your keyboard to enable execution of the task.

### Action bar:

Contains the names of four actions needed to operate the Q-Flash utility. Pressing the buttons mentioned on your keyboards to perform these actions.

### Using the Q-Flash™ utility:

This section tells you how to update BIOS using the Q-Flash utility. As described in the "Before you begin" section above, you must prepare a floppy disk having the BIOS file for your motherboard and insert it to your computer. If you have already put the floppy disk into your system and have entered the Q-Flash utility, please follow the steps below to flash BIOS.

### Steps:

1. Press arrow buttons on your keyboard to move the light bar to "Update BIOS from Floppy" item in the Q-Flash menu and press Enter button.  
Later, you will see a box pop up showing the BIOS files you previously downloaded to the floppy disk.



If you want to save the current BIOS for backup purpose, you can begin Step 1 with "Save BIOS to Floppy" item.

2. Move to the BIOS file you want to flash and press Enter.

**In this example, we only download one BIOS file to the floppy disk so only one BIOS file, 8GE800.F4, is listed.**



Please confirm again you have the correct BIOS file for your motherboard.

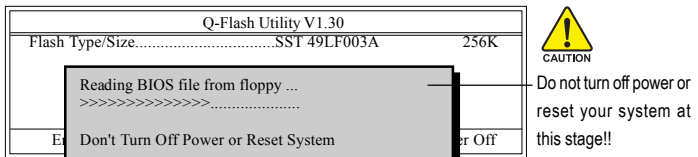
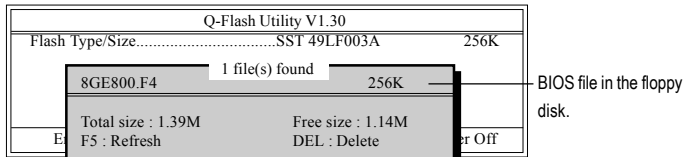

After BIOS file is read, you'll see a confirmation dialog box asking you "Are you sure to update BIOS?"



Please do not take out the floppy disk when it begins flashing BIOS.

- Press Y button on your keyboard after you are sure to update BIOS.  
Then it will begin to update BIOS. The progress of updating BIOS will be shown at the same time.

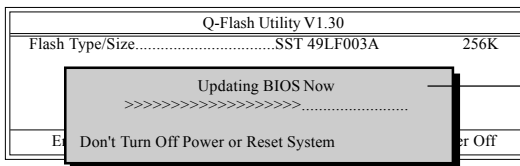

Do not turn off power or reset your system at this stage!!

- Press any keys to return to the Q-Flash menu when the BIOS updating procedure is completed.

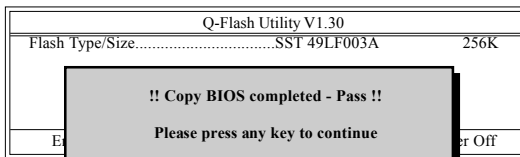

- Press Esc and then Y button to exit the Q-Flash utility. The computer will restart automatically after you exit Q-Flash.

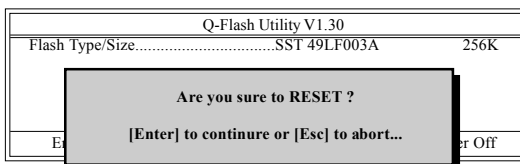

After system reboots, you may find the BIOS version on your boot screen becomes the one you flashed.

The BIOS file becomes F4 after updating

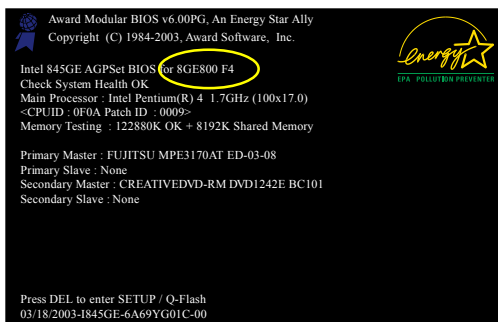

- Press Del to enter BIOS menu after system reboots and "Load BIOS Fail-Safe Defaults". See how to Load BIOS Fail-Safe Defaults, please kindly refer to Step 6 to 7 in **Part One**.

**Congratulation!! You have updated BIOS successfully!!**



## Method 2 : @BIOS™ Utility

If you do not have a DOS startup disk, we recommend that you use the new @BIOS utility. @BIOS allows users to update their BIOS under Windows. Just select the desired @BIOS server to download the latest version of BIOS.

Fig 1. Installing the @BIOS utility

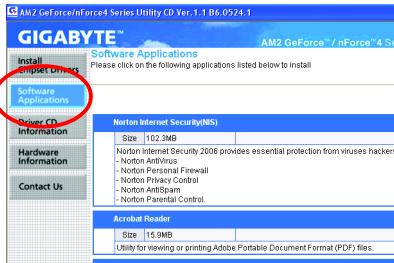

Fig 2. Installation Complete and Run @BIOS

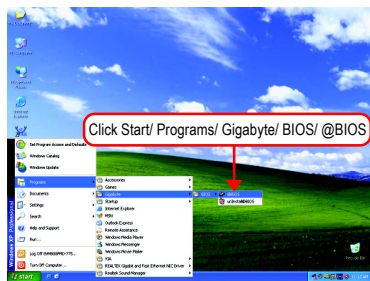

Fig 3. The @BIOS Utility

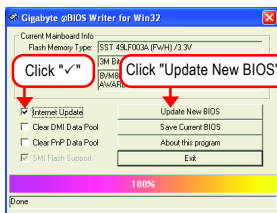
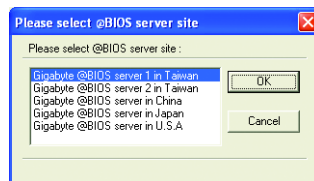

Fig 4. Select the desired @BIOS server



## 1. Methods and steps:

### I. Update BIOS through Internet

- a. Click "Internet Update" icon
- b. Click "Update New BIOS" icon
- c. Select @BIOS™ sever
- d. Select the exact model name on your motherboard
- e. System will automatically download and update the BIOS.

### II. Update BIOS NOT through Internet:

- a. Do not click "Internet Update" icon
- b. Click "Update New BIOS"
- c. Please select "All Files" in dialog box while opening the old file.
- d. Please search for BIOS unzip file, downloading from internet or any other methods (such as: M55SLIS4.F1).
- e. Complete update process following the instruction.

### III. Save BIOS

In the very beginning, there is "Save Current BIOS" icon shown in dialog box. It means to save the current BIOS version.

### IV. Check out supported motherboard and Flash ROM:

In the very beginning, there is "About this program" icon shown in dialog box. It can help you check out which kind of motherboard and which brand of Flash ROM are supported.

## 2. Note:

- I. In method I, if it shows two or more motherboard's model names to be selected, please make sure your motherboard's model name again. Selecting wrong model name will cause the system unbooted.
- II. In method II, be sure that motherboard's model name in BIOS unzip file are the same as your motherboard's. Otherwise, your system won't boot.
- III. In method I, if the BIOS file you need cannot be found in @BIOS™ server, please go onto Gigabyte's web site for downloading and updating it according to method II.
- IV. Please note that any interruption during updating will cause system unbooted.
- V. Do not use @BIOS and C.O.M. (Corporate Online Management) at the same time.

## 4-1-4 Configuring SATA Hard Drive(s)

**To configure SATA hard drive(s), follow the steps below:**

- (1) Install SATA hard drive(s) in your system.
- (2) Configure SATA controller mode and boot sequence in BIOS Setup.
- (3)\* Configure RAID set in RAID BIOS.
- (4) Make a floppy disk containing the SATA controller driver.
- (5) Install the SATA controller driver during OS installation.

### **Before you begin**

Please prepare:

- (a) At least two SATA hard drives (to ensure optimal performance, it is recommended that you use two hard drives with identical model and capacity). If you do not want to create RAID, you may prepare only one hard drive.
- (b) An empty formatted floppy disk.
- (c) Windows XP/2000 setup disk.
- (d) Driver CD for your motherboard.

### **(1) Installing SATA hard drive(s) in your computer**

Attach one end of the SATA signal cable to the rear of the SATA hard drive and the other end to available SATA port(s) on the motherboard. If there are more than one SATA controller on your motherboard, you may refer to the motherboard user's manual to identify the SATA controller for the connector. Then connect the power connector from your power supply to the hard drive.

\*\*\*\* Skip this step if you do not want to create RAID array on the SATA controller.

## (2) Configuring SATA controller mode and boot sequence in BIOS Setup

You have to make sure whether the SATA controller is configured correctly in system BIOS Setup and set BIOS boot sequence for the SATA hard drive(s)/RAID array.

### Step 1:

Turn on your computer and press Del to enter BIOS Setup during POST (Power-On Self Test). If you want to create RAID, make sure that **NV SATA RAID function** under the **Integrated Peripherals** menu is enabled (Figure 1). Also make sure that the **NV Serial-ATA 1/Serial-ATA 2** are enabled (including **NV SATA 1 Primary/Secondary RAID/SATA 2 Primary/Secondary RAID**), depending on which SATA ports you connect. For example, if you wish to create RAID with the hard disks on connectors S\_ATA0 and S\_ATA1, assure that the **Serial-ATA 1** is enabled and **SATA 1 Primary/Secondary RAID** are enabled. **Serial-ATA 2** is for S\_ATA2 and S\_ATA3 connectors.

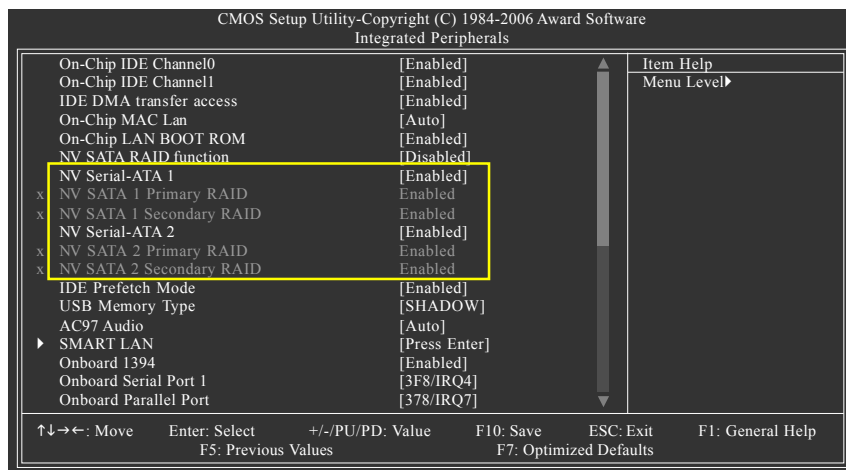

Figure 1



The BIOS Setup menus described in this section may not show the exact settings for your motherboard. The actual BIOS Setup menu options you will see shall depend on the motherboard you have and the BIOS version.

## Step 2:

If you do not create RAID, select **Hard Disk Boot Priority** under the **Advanced BIOS Features** menu. In the **Hard Disk Boot Priority** submenu, select the model of the SATA hard drive onto which you wish to install Microsoft Windows 2000/XP. You should see a screen similar to Figure 2 below.

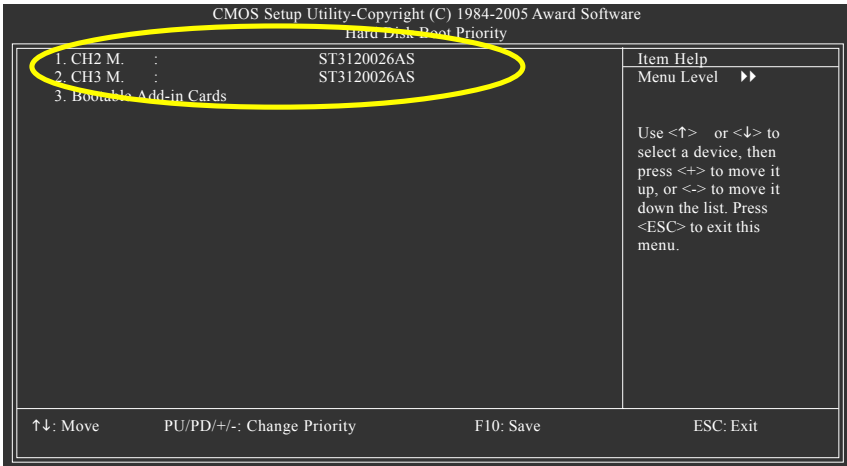

Figure 2

If you wish to create RAID, configure the RAID array in RAID BIOS (refer to Section 3) first. After finished, re-enter the system BIOS Setup to set hard disk boot priority before OS installation. Select **Hard Disk Boot Priority** under the **Advanced BIOS Features** menu. In the **Hard Disk Boot Priority** submenu, select the RAID array onto which you wish to install Microsoft Windows 2000/XP. You should see a screen similar to Figure 3 below.

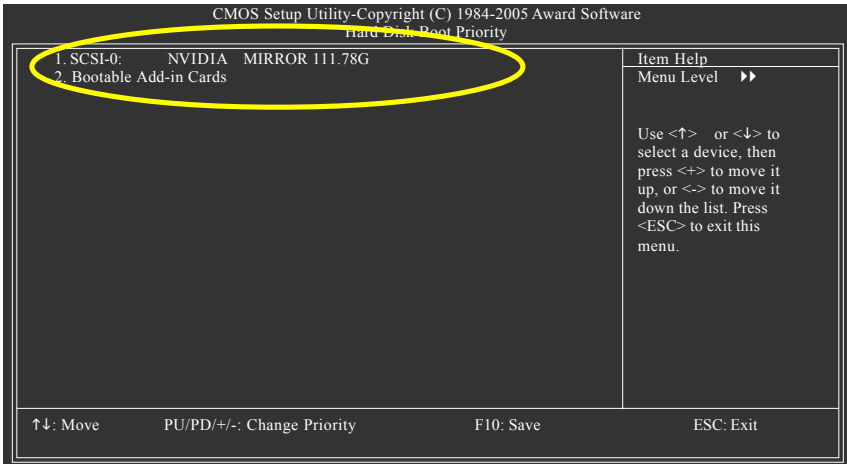

Figure 3

Step 3:

To boot from Windows installation CD-ROM, set **First Boot Device** under the **Advanced BIOS Features** menu to **CD-ROM** (Figure 4).

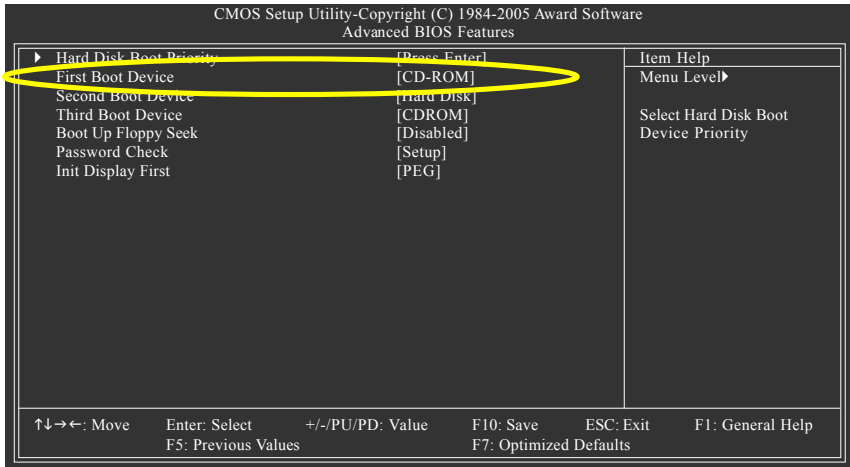

Figure 4

Step 4:

Save and exit BIOS Setup.

### (3) Configuring RAID set in RAID BIOS

Enter the RAID BIOS setup utility to configure a RAID array. Skip this step and proceed to Section 4 if you do not want to create RAID.

#### Step 1:

After the POST memory test begins and before the operating system boot begins, look for a message which says "Press F10 to enter RAID setup utility" (Figure 5). Hit the **F10** key to enter the RAID BIOS setup utility.

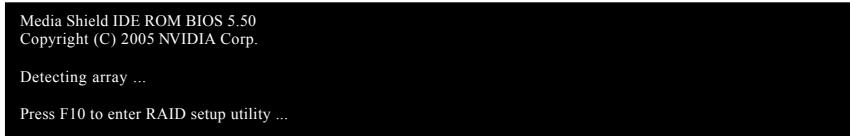

Figure 5

#### Step 2:

The Define a New Array screen is the first option screen when you enter the NVIDIA RAID setup utility. (Figure 6). You can press the TAB key to highlight through options.

#### Step 3:

In the RAID Mode field, use the UP or DOWN ARROW key to select a RAID mode. The supported RAID modes include Mirroring, Striping, Stripe Mirroring, Spanning, and Raid 5. The following is an example of RAID 0 array creation.

#### Step 4:

If RAID 0 (Striping) is selected, you can manually set the striping block size. In the Striping Block field, use the UP or DOWN ARROW key to set the Striping Block size. The KB is the standard unit of Striping Block size. We recommend you leaving it to the default setting--Optimal (64K). The size range is from 4K to 128K.

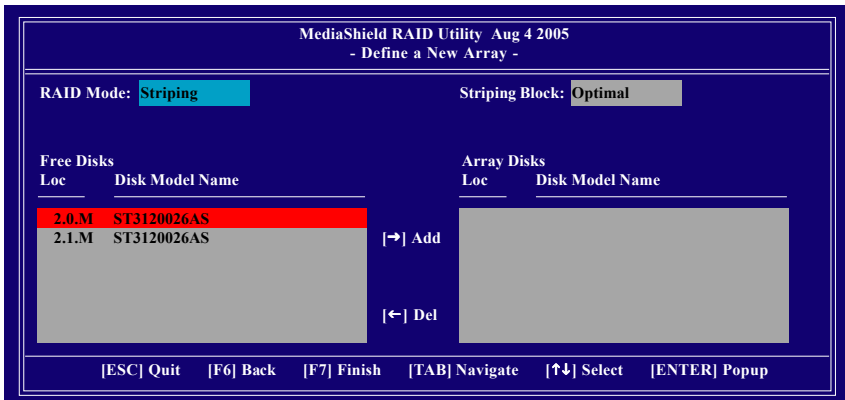

Figure 6

## Step 5:

Next, select the hard drives which you wish to be included in the disk array. The Free Disks section displays the information about the currently installed SATA hard drives. Press the TAB key to move to the Free Disks section. Select the target hard drives using the UP or DOWN ARROW key and use the RIGHT ARROW key to add the hard drives to the Array Disks section (Figure 7).

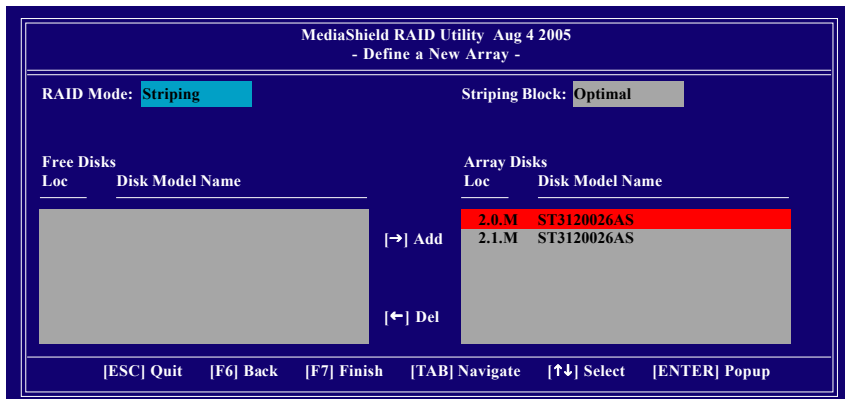

Figure 7

## Step 6:

Press F7 after selecting the target hard disks. A message which says "Clear disk data?" will appear. If you are sure to clear the data in the selected hard drives, press Y. (If the hard drives contain previously created RAID array, you need to press Y to clear the data from the hard drives.)

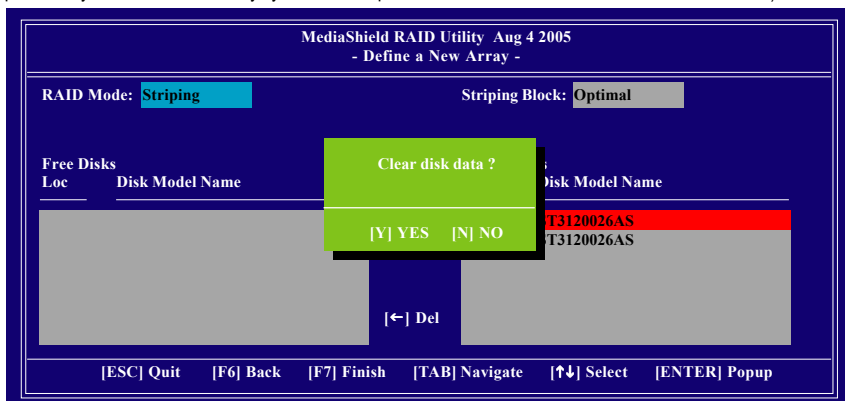

Figure 8



After that, the Array List screen displaying the RAID array you created will appear (Figure 9). If you want to set the disk array as boot device, use the UP or DOWN ARROW key to select the array and press B. The **Boot** section will show **Yes**.

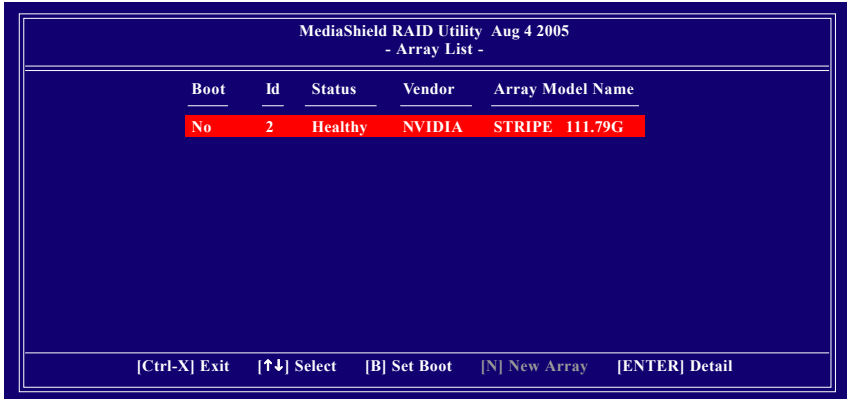

Figure 9

To read more information about the RAID array, press ENTER to enter the Array Detail screen (Figure 10), where you should see detailed information about RAID mode, disk block size, disk model name, and disk capacity, etc.

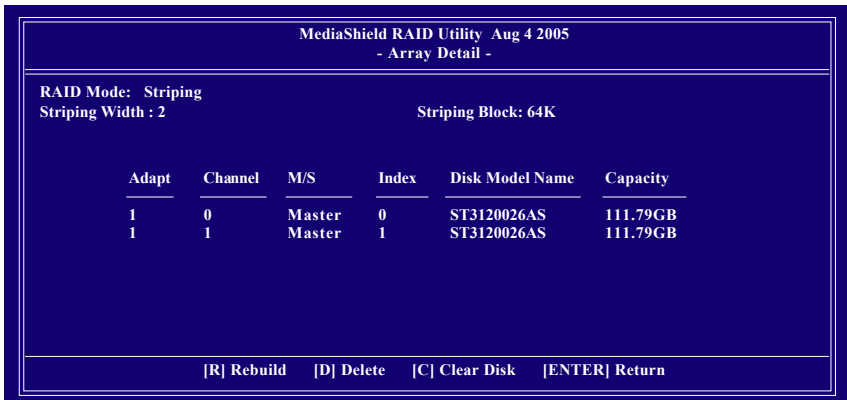

Figure 10

To delete the array, press D in the Array Detail screen. When the "Delete this array?" message appears, press Y to confirm or N to cancel. Press ENTER to return to the Array List screen.

To exit the Nvidia RAID utility, press ESC in the main menu or Ctrl+X in the Array List screen.

Now, you can proceed to install the SATA controller driver and operating system.

## (4) Making a SATA Driver Disk

To install operating system onto a serial ATA hard disk successfully, you need to install the SATA controller driver during OS installation. Without the driver, the hard disk may not be recognized during the Windows setup process. First of all, copy the driver for the SATA controller from the motherboard driver CD-ROM to a floppy disk. See the instructions below about how to copy the driver in MS-DOS mode<sup>(Note 1)</sup>. Prepare a startup disk that has CD-ROM support and a blank formatted floppy disk.

Step 1: Insert the prepared startup disk and motherboard driver CD-ROM in your system. Boot from the startup disk. Once at the A:\> prompt, change to the CD-ROM drive (example: D:\>). At the D:\> prompt, type the following two commands. Press ENTER after each command (Figure 11):

```
cd bootdrv
menu
```

Step 2: When the controller menu (Figure 12) appears, remove the startup disk and insert the blank formatted disk. Select the controller driver by pressing the corresponding letter from the menu<sup>(Note 2)</sup>. For example, from the menu in Figure 12, press C to select **C) nVIDIA CK804 Series Raid(XP)** if you wish to install Windows XP. Your system will then automatically zip and transfer this driver file to the floppy disk. Press 0 to exit when finished.

```

D:\BOOTDRV 1 10:00:02 7.51p
DISMHL DLL 94,268 06-15-04 1.19p
DRIVER5 11-23-04 9:26p
HISTORY TXT <DIR> 7,763 05-24-04 1.56p
HONDRU DLL 51,248 08-21-02 10.11a
ID 21,877 12-01-04 11.02a
MMDML <DIR> 11-23-04 9:17p
NETWORK <DIR> 11-23-04 9:26p
NMS <DIR> 11-23-04 9:26p
OTHER <DIR> 30,857 10-08-02 7.51p
PROSET1 <DIR> 11-23-04 9:26p
PROSET11 <DIR> 11-23-04 9:26p
R00MS TXT 4,551 12-01-04 2.99p
SETUP EXE 421,888 11-25-04 3.32p
TESTM EXE 190,488 08-09-04 1.84p
TIP INI 2,839 09-30-04 10.01a
UTILITY <DIR> 11-23-04 9:27p
VERFILE TIC 13 03-20-03 1.45p
XUCD TXT 7,828 11-24-04 1.51p
Total file(s) 860,853 bytes
Total free 0 bytes free
D:\>cd bootdrv
D:\BOOTDRV>menu

```

Figure 11

```

1)Promise 20276 ATA
2)Promise 20276 RAID
3)Promise 20265 ATA
4)Promise 20265 ATA(XP)
5)Promise 20265 RAID
6)Promise 20265 RAID(XP)
7)Promise 20779 SATA
8)Promise 20779 RAID
9)S11314 RAID
A)S11314 RAID
B)S11314 RAID5
C)nVIDIA CK804 Series Raid(XP)
D)nVIDIA CR804 Series Raid(XP)
E)nVIDIA CR804 Series Raid(64 bit)
F)nVIDIA C19 Series Raid(XP)
G)nVIDIA C19 Series Raid(XP)
H)nVIDIA C51 Series Raid(XP)
I)nVIDIA C51 Series Raid(XP)
J)nVIDIA C51 Series Raid(64Bit)
0)exit

```

Figure 12

(Note 1) For users without a startup disk:

Use an alternative system and insert the GIGABYTE motherboard driver CD-ROM. From the CD-ROM drive folder, double click the **MENU.exe** file in the **BootDrv** folder (Figure 13). A command prompt window will open similar to that in Figure 12.

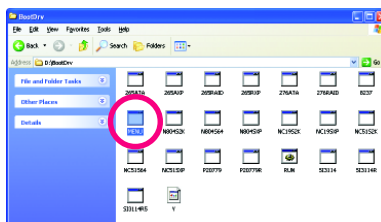

Figure 13

(Note 2) Select the driver by pressing the corresponding letter according to the operating system you wish to install.

## (5) Installing SATA controller driver during OS installation

Now that you have prepared the SATA driver disk and configured BIOS settings, you are ready to install Windows 2000/XP onto your SATA hard drive with the SATA driver. The following is an example of Windows XP installation.

Step 1: Restart your system to boot from the Windows 2000/XP Setup disk and press F6 as soon as you see the "Press F6 if you need to install a 3rd party SCSI or RAID driver" message (Figure 14). After pressing F6, there will be a few moments of some files being loaded before you see the next screen.

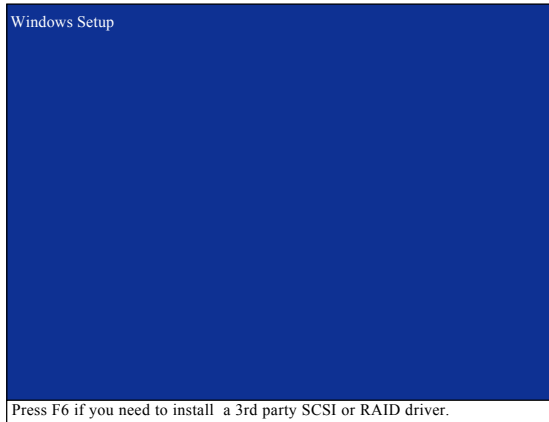

Figure 14

Step 2:

When a screen similar to that below appears, insert the floppy disk containing the SATA driver and press S (Figure 15).

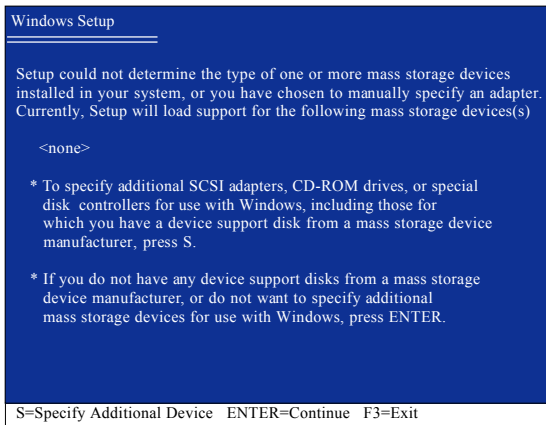

Figure 15

## Step 3:

If Setup correctly recognizes the driver in the floppy disk, a controller menu similar to Figure 16 below will appear. Use the ARROW keys to select **NVIDIA RAID CLASS DRIVER\*** and press ENTER. Later, when a screen similar to Figure 17 appears, you must press S to select additional driver. The screen will return to previous screen as shown in Figure 16. Select **NVIDIA nForce Storage Controller** and press ENTER.

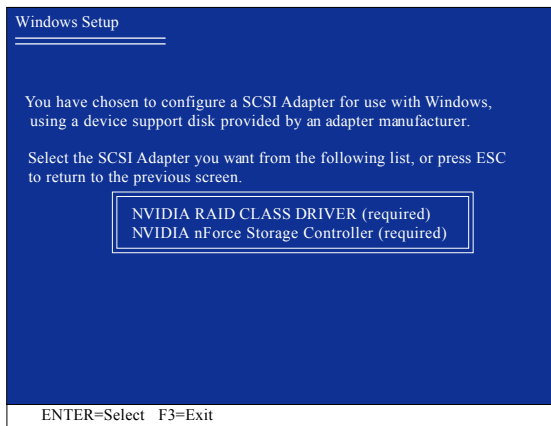

Figure 16

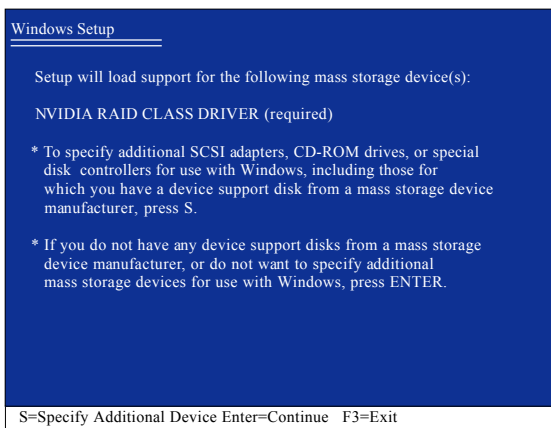

Figure 17



If a message appears saying one or some file(s) cannot be found, please check the floppy disk or copy the correct SATA driver again from the motherboard driver CD.

\*\*\* If you want to create RAID, select both **NVIDIA RAID CLASS DRIVER** and then **NVIDIA nForce Storage Controller**.

If you do not create RAID, select **NVIDIA nForce Storage Controller** only.

**Step 4:**

When the next screen (Figure 18) appears, press ENTER to continue the SATA driver installation from the floppy disk.

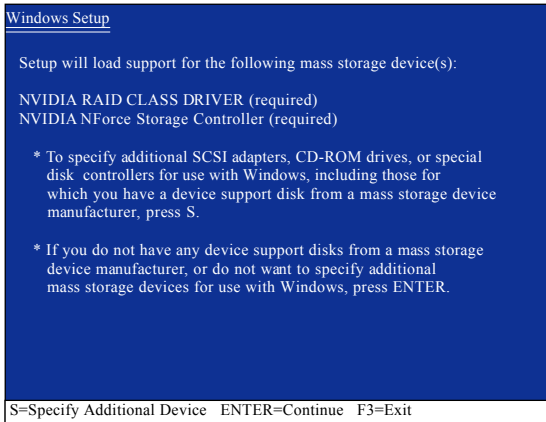

Figure 18

Finally, after the SATA controller driver installation is completed, you can proceed with the Windows 2000/XP installation.

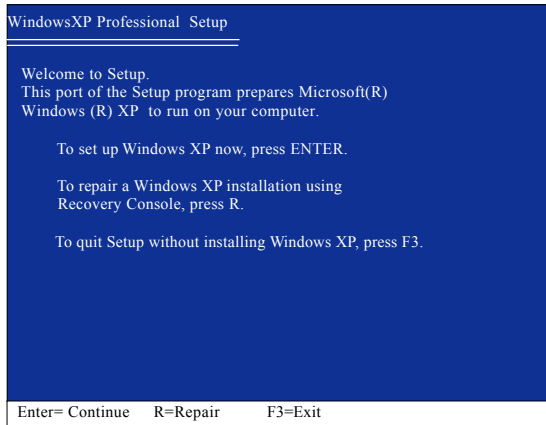

Figure 19

(Note: Each time you add a new hard drive to a RAID array, the RAID driver will have to be installed under Windows once for that hard drive. After that, the driver will not have to be installed.)

## (6) Configuring a bootable RAID array with Microsoft Windows 2000

**Problem:** Users cannot install Windows 2000 with Service Pack 2 (or previous versions) to a bootable RAID volume.

There are two solutions to resolve this issue.

### Solutions 1:

Use the NVRAID tool (nForce Driver Version 5.xx) to convert the boot volume to a RAID array. Here are the detailed step-by-step instructions:

#### Step 1:

Install Windows 2000 onto a selected hard drive. Download and install Windows 2000 Service Pack 4 from Microsoft's website.

#### Step 2:

After system restarts, press Del to enter system BIOS Setup during POST (Power-On Self Test). Under the **Integrated Peripherals** menu assure the SATA port connecting the SATA hard disk (the one containing the Windows 2000) is **Enabled** (Figure 20). Save settings and exit the BIOS setup.

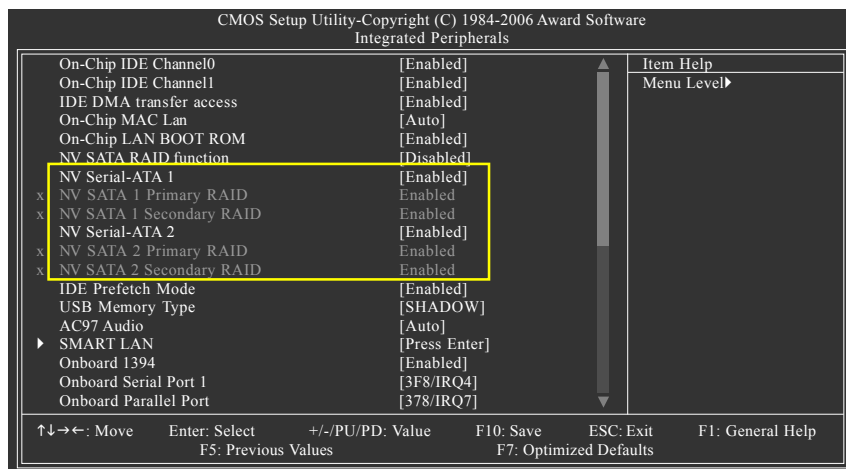

Figure 20

## Step 3:

After system restarts, press F10 to enter the NVIDIA RAID setup utility. Select Striping in the RAID Mode field (Figure 21). Move to the Free Disks section with the TAB key. Select the desired disk and use the RIGHT ARROW key to add it to Array Disks menu.

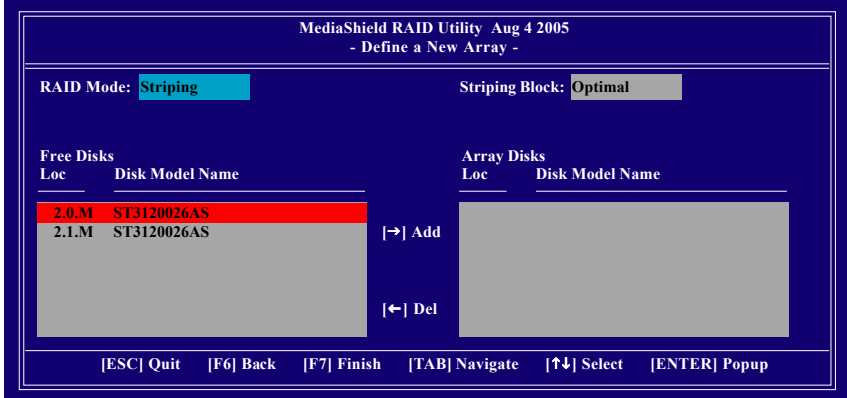

Figure 21

## Step 4:

After all the settings, press F7 to complete the configuration. When prompted to **Clear Disk Data** (Figure 22), press N. Then press CTRL+X to exit the NVIDIA RAID BIOS. Restart the computer to boot into Windows 2000.

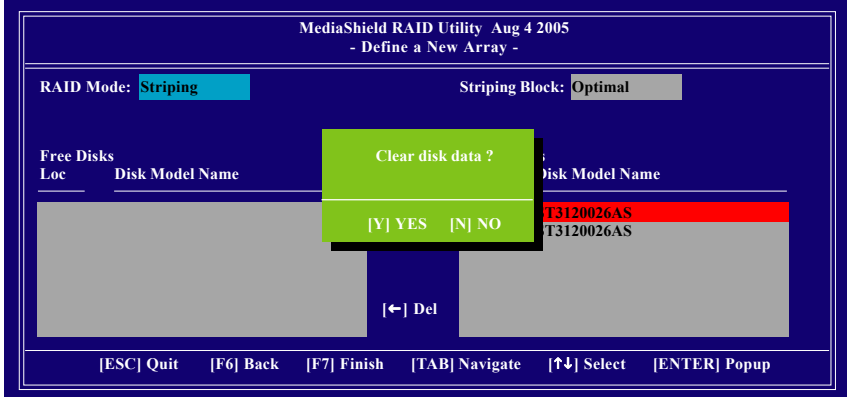

Figure 22

**Step 5:**

Install the NVIDIA nForce Driver Package while in Windows 2000 and reboot the system. Go to **START> Programs>Nvidia Corporation** and select **NVRAID manager**. You should see the single disk RAID array (in striping mode) that was created from the boot disk. Select the single boot disk RAID Array by clicking on it. Select **Convert Array** under the **System Tasks** and select **Next** following the instructions. Select the desired type of RAID array you want to convert and then select **Next**. You are prompted to select the desired Free Disk(s) to add to the bootable RAID array. Press **Finish** then NVRAID will start converting the single disk RAID array into a multi-disk RAID array in a bootable format.

Note: Conversion may take 1~2 hours depending on disk size.

**Solutions 2:**

Users must create a combination installation CD that includes Windows 2000 and Service Pack 3 or Service Pack 4 fixes integrated in. To create the combination installation CD, refer to the following website:

<http://www.microsoft.com/windows2000/downloads/servicepacks/sp4/HFdeploy.htm>

Note: If users choose not to install Windows 2000 Service Pack 3 or 4, RAID is still supported on Windows 2000. However, users will not be able to create a bootable RAID volume.



### Introduction of audio connectors:

You may connect CD-ROM/DVD-ROM, walkman or others audio input to Line In.

The front channels or earphone can be connected to Line Out (Front Speaker Out).

Connect microphone to Mic In.

Connect the Center/Subwoofer channels to Center/Subwoofer Speaker Out.

Connect the rear channels to Rear Speaker Out.

Connect the side channels to Side Speaker Out.

The installation of audio software is very simple. Please follow the steps to install the function. (Following pictures are in Windows XP)

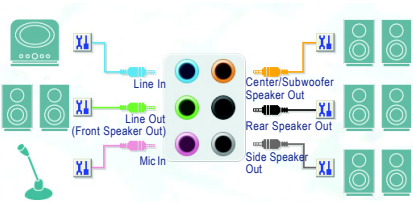

### Stereo Speakers Connection and Settings:

We recommend that you use the speaker with amplifier to acquire the best sound effect if the stereo output is applied.

#### STEP 1:

Connect the stereo speakers or earphone to "Line Out".

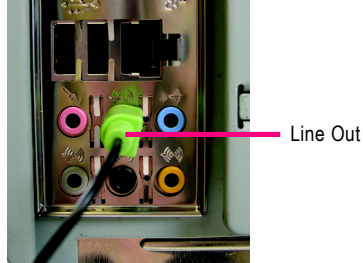

#### STEP 2 :

Following installation of the audio driver, you find a Sound Effect  icon on the lower right hand taskbar. Click the icon to select the function.



STEP 3:

Click "Speaker Configuration" then click on the left selection bar and select "2CH Speaker" to complete 2 channel audio configuration.

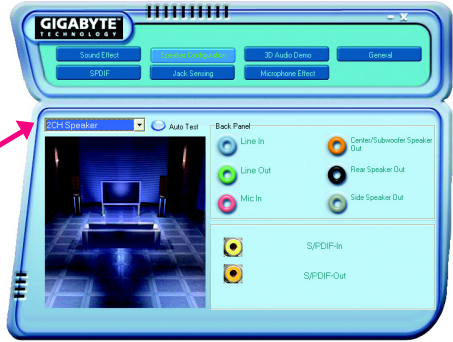

4 Channel Audio Setup

STEP 1 :

Connect the front channels to "Front Speaker Out", the rear channels to "Rear Speaker Out".

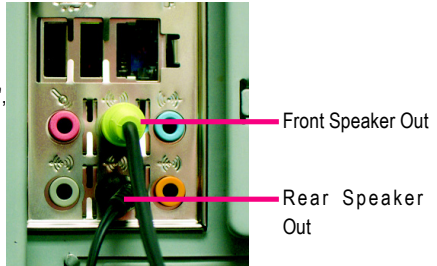

STEP 2 :

Following installation of the audio driver, you find a Sound Effect icon on the lower right hand taskbar. Click the icon to select the function.

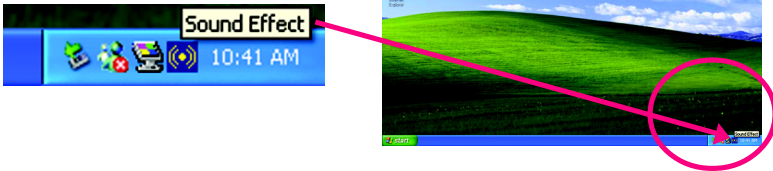

STEP 3:

Click "Speaker Configuration" then click on the left selection bar and select "4CH Speaker" to complete 4 channel audio configuration.

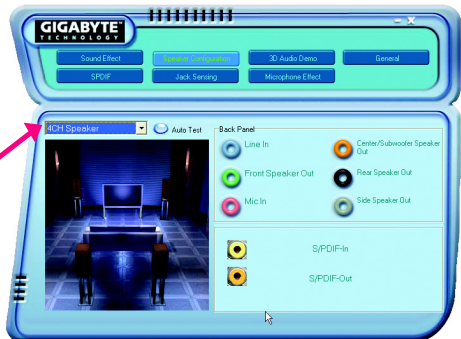
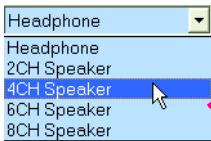

## 6 Channel Audio Setup

### STEP 1 :

Connect the front channels to "Front Speaker Out", the rear channels to "Rear Speaker Out", and the Center/Subwoofer channels to "Center/Subwoofer Speaker Out".

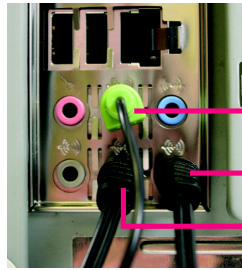

Front Speaker Out

Center/Subwoofer Speaker Out

Rear Speaker Out

### STEP 2 :

Following installation of the audio driver, you find a Sound Effect  icon on the lower right hand taskbar. Click the icon to select the function.



### STEP 3:

Click "Speaker Configuration" then click on the left selection bar and select "6CH Speaker" to complete 6 channel audio configuration.

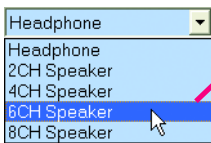

## 8 Channel Audio Setup

### STEP 1 :

Connect the front channels to "Front Speaker Out", the rear channels to "Rear Speaker Out", the Center/Subwoofer channels to "Center/Subwoofer Speaker Out", and the side channels to "Side Speaker Out".

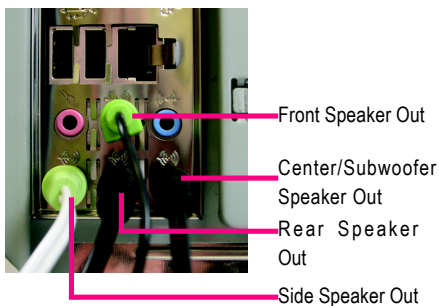

### STEP 2 :

Following installation of the audio driver, you find a Sound Effect  icon on the lower right hand taskbar. Click the icon to select the function.

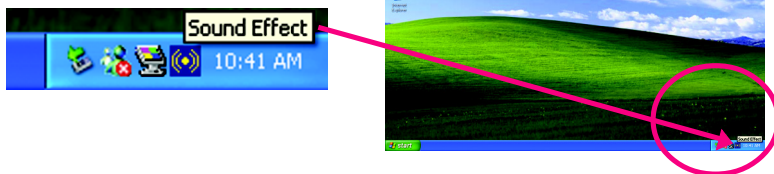

### STEP 3:

Click "Speaker Configuration" then click on the left selection bar and select "8CH Speaker" to complete 8 channel audio configuration.



### Sound Effect Configuration:

At the sound effect menu, users can adjust sound option settings as desired.

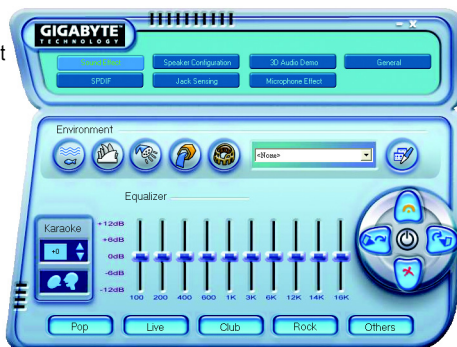

## 4-2 Troubleshooting

Below is a collection of general asked questions. To check general asked questions based on a specific motherboard model, please log on to [www.gigabyte.com.tw](http://www.gigabyte.com.tw)

Question 1: I cannot see some options that were included in previous BIOS after updating BIOS. Why?  
 Answer: Some advanced options are hidden in new BIOS version. Please press Ctrl and F1 keys after entering BIOS menu and you will be able to see these options.

Questions 2: Why is the light of my keyboard/optical mouse still on after computer shuts down?  
 Answer: In some boards, a small amount of electricity is kept on standby after computer shuts down and that's why the light is still on.

Question 3: How do I clear CMOS?  
 Answer: If your board has a Clear CMOS jumper, please refer to the Clear CMOS steps in the manual. If your board doesn't have such jumper, you can take off the on-board battery to leak voltage to clear CMOS. Please refer to the steps below:

Steps:

1. Turn off power.
2. Disconnect the power cord from MB.
3. Take out the battery gently and put it aside for about 1 minute (Or you can use a metal object to connect the positive and negative pins in the battery holder to makethem short for five seconds).
4. Re-insert the battery to the battery holder.
5. Connect power cord to MB again and turn on power.
6. Press Del to enter BIOS and load Fail-Safe Defaults(or load Optimized Defaults).
7. Save changes and reboot the system.

Question 4: Why do I still get a weak sound after turning up the speaker to the maximum volume?  
 Answer: Please make sure the speaker you are using is equipped with an internal amplifier. If not, please change another speaker with power/amplifier and try again later.

Question 5: Sometimes I hear different continuous beeps from computer after system boots up. What do these beeps usually stand for?

Answer: The beep codes below may help you identify the possible computer problems. However, they are only for reference purposes. The situations might differ from case to case.

- AWARD BIOS Beep Codes
- 1 short: System boots successfully
  - 2 short: CMOS setting error
  - 1 long 1 short: DRAM or M/B error
  - 1 long 2 short: Monitor or display card error
  - 1 long 3 short: Keyboard error
  - 1 long 9 short: BIOS ROM error
  - Continuous long beeps: DRAM error
  - Continuous short beeps: Power error















## Contact Us

---

- **Taiwan (Headquarters)**

GIGA-BYTE TECHNOLOGY CO., LTD.

Address: No.6, Bau Chiang Road, Hsin-Tien,

Taipei 231, Taiwan

TEL: +886-2-8912-4888

FAX: +886-2-8912-4003

Tech. and Non-Tech. Support (Sales/Marketing) :

<http://ggts.gigabyte.com.tw>

WEB address (English) : <http://www.gigabyte.com.tw>

WEB address (Chinese) : <http://www.gigabyte.tw>

---

- **U.S.A.**

G.B.T. INC.

TEL: +1-626-854-9338

FAX: +1-626-854-9339

Tech. Support:

<http://rma.gigabyte-usa.com>

Web address: <http://www.gigabyte.us>

---

- **Mexico**

G.B.T Inc (USA)

Tel: +1-626-854-9338 x 215 (Soporte de habla hispano)

FAX: +1-626-854-9339

Correo: [soporte@gigabyte-usa.com](mailto:soporte@gigabyte-usa.com)

Tech. Support:

<http://rma.gigabyte-usa.com>

Web address: <http://www.gigabyte-latam.com>

---

- **Japan**

NIPPON GIGA-BYTE CORPORATION

WEB address : <http://www.gigabyte.co.jp>

---

- **Singapore**

GIGA-BYTE SINGAPORE PTE. LTD.

WEB address : <http://www.gigabyte.com.sg>

---

---

- **China**

NINGBO G.B.T. TECH. TRADING CO., LTD.

WEB address : <http://www.gigabyte.cn>

- **Shanghai**

TEL: +86-21-63410999

FAX: +86-21-63410100

- **Beijing**

TEL: +86-10-62102838

FAX: +86-10-62102848

- **Wuhan**

TEL: +86-27-87851061

FAX: +86-27-87851330

- **GuangZhou**

TEL: +86-20-87540700

FAX: +86-20-87544306 ext. 333

- **Chengdu**

TEL: +86-28-85236930

FAX: +86-28-85256822 ext. 814

- **Xian**

TEL: +86-29-85531943

FAX: +86-29-85539821

- **Shenyang**

TEL: +86-24-83992901

FAX: +86-24-83992909

---

- **India**

GIGABYTE TECHNOLOGY (INDIA) LIMITED

WEB address : <http://www.gigabyte.in>

---

- **Australia**

GIGABYTE TECHNOLOGY PTY. LTD.

WEB address : <http://www.gigabyte.com.au>

---

---

- **Germany**

G.B.T. TECHNOLOGY TRADING GMBH

WEB address : <http://www.gigabyte.de>

- **U.K.**

G.B.T. TECH. CO., LTD.

WEB address : <http://www.giga-byte.co.uk>

- **The Netherlands**

GIGA-BYTE TECHNOLOGY B.V.

WEB address : <http://www.giga-byte.nl>

- **France**

GIGABYTE TECHNOLOGY FRANCE

WEB address : <http://www.gigabyte.fr>

- **Italy**

WEB address : <http://www.giga-byte.it>

- **Spain**

GIGA-BYTE SPAIN

WEB address : <http://www.giga-byte.es>

- **Czech Republic**

Representative Office Of GIGA-BYTE Technology Co., Ltd.  
in CZECH REPUBLIC

WEB address : <http://www.gigabyte.cz>

- **Turkey**

Representative Office Of GIGA-BYTE Technology Co., Ltd.  
in TURKEY

WEB address : <http://www.gigabyte.com.tr>

---



---

- **Russia**

Moscow Representative Office Of GIGA-BYTE Technology Co., Ltd.

WEB address : <http://www.gigabyte.ru>

- **Latvia**

GIGA-BYTE Latvia

WEB address : <http://www.gigabyte.com.lv>

- **Poland**

Office of GIGA-BYTE TECHNOLOGY Co., Ltd. in POLAND

WEB address : <http://www.gigabyte.pl>

- **Ukraine**

WEB address : <http://www.gigabyte.kiev.ua>

- **Romania**

Representative Office Of GIGA-BYTE Technology Co., Ltd.  
in Romania

WEB address : <http://www.gigabyte.com.ro>

- **Serbia & Montenegro**

Representative Office Of GIGA-BYTE Technology Co., Ltd.  
in SERBIA & MONTENEGRO

WEB address : <http://www.gigabyte.co.yu>

---

- **GIGABYTE Global Service System**



To submit a technical or non-technical (Sales/Marketing) question, please link to :

<http://ggts.gigabyte.com.tw>

Then select your language to enter the system.