

GA-K8N Ultra-SLI / GA-K8N Pro-SLI / GA-K8N-SLI

AMD Socket 939 Processor Motherboard

User's Manual

Rev. 1004

12ME-K8NUSLI-1004

Declaration of Conformity

G.B.T. Technology, Inc.
The Manufacturer/Importer
Ausselshager Weg 41, P.O. 20327 Hamburg, Germany

(description of the apparatus, system, installation to which it refers)
Motherboard
GA-K8N Ultra-SLI
is in conformity with (reference to the specification in accordance with 901338 EEC EMC Directive)

- | | | | |
|--|--|---|---|
| <input type="checkbox"/> EN 55011 | Limits and methods of measurement of radio disturbance characteristics of industrial, scientific and medical (ISM) high frequency equipment | <input checked="" type="checkbox"/> EN 61000-3-2 | Disturbances in supply systems caused by household appliances and similar electrical equipment. Voltage fluctuations* |
| <input type="checkbox"/> EN 55013 | Limits and methods of measurement of radio disturbance characteristics of equipment | <input checked="" type="checkbox"/> EN 55024 | Information Technology equipment |
| <input type="checkbox"/> EN 55014-1 | Limits and methods of measurement of radio disturbance characteristics of household electrical appliances, portable tools and similar electrical apparatus | <input type="checkbox"/> EN 55022-1 | Generic immunity standard Part 1: Residential, commercial and light industry |
| <input type="checkbox"/> EN 55015 | Limits and methods of measurement of radio disturbance characteristics of equipment | <input type="checkbox"/> EN 55022-2 | Generic immunity standard Part 2: Industrial environment |
| <input type="checkbox"/> EN 55020 | Immunity from radio interference of equipment | <input type="checkbox"/> EN 55014-2 | Immunity requirements for household appliances tools and similar apparatus |
| <input checked="" type="checkbox"/> EN 55022 | Limits and methods of measurement of radio disturbance characteristics of information technology equipment | <input type="checkbox"/> EN 50091-2 | EMC requirements for uninterruptible power systems (UPS) |
| <input type="checkbox"/> EN VDE 0855 | Cabled distribution systems. Equipment | | |
| <input type="checkbox"/> EN 50118 | Power supply systems for television sound and television signals | | |
| <input checked="" type="checkbox"/> CE marking | |  | (EEC conformity marking) |
| <input type="checkbox"/> EN 50095 | Safety requirements for mains operated household and similar general use electrical appliances | <input type="checkbox"/> EN 60950 | Safety for information technology equipment including electrical business equipment |
| <input type="checkbox"/> EN 60335 | Safety of household and similar electrical appliances | <input type="checkbox"/> EN 50091-1 | General and Safety requirements for uninterruptible power systems (UPS) |

Manufacturer/Importer

(Stamp)

Date: Jan. 12, 2005

Signature: Timmy Huang
Name: Timmy Huang

DECLARATION OF CONFORMITY

Per FCC Part 2, Section 2.1077(a)



Responsible Party Name: G.B.T. INC. (U.S.A.)

Address: 17358 Railroad Street

City of Industry, CA 91748

Phone/Fax No: (818) 854-9338 / (818) 854-9339

hereby declares that the product

Product Name: **Motherboard**

Model Number: GA-K8N Ultra-SLI

Conforms to the following specifications:

FCC Part 15, Subpart B, Section 15.107(a) and Section 15.109

(a), Class B Digital Device

Supplementary Information:

This device complies with part 15 of the FCC Rules. Operation is subject to the following two conditions: (1) This device may not cause harmful and (2) this device must accept any interference received, including that may cause undesired operation.

Representative Person's Name: ERIC LU

Signature: Eric Lu

Date: Jan. 12, 2005

Declaration of Conformity

G.B.T. Technology, Inc.
We, Manufacturer/Importer
Ausehschler Weg 41, P 20327 Hamburg, Germany

(description of the apparatus, system, installation to which it refers)
Motherboard

(reference to the specification with conformity is declared)
is in conformity with CE marking
in accordance with 93/38 EEC Directive

- | | | | |
|--|--|--|---|
| <input type="checkbox"/> EN 55011 | Limits and methods of measurement of radio disturbance characteristics of industrial, scientific and medical (ISM) high frequency equipment | <input checked="" type="checkbox"/> EN 61000-3-2 | Disturbances in supply systems caused by household appliances and similar electrical equipment. Voltage fluctuations* |
| <input type="checkbox"/> EN 55013 | Limits and methods of measurement of radio disturbance characteristics of equipment | <input checked="" type="checkbox"/> EN 55024 | Information Technology equipment/Immunity requirements |
| <input type="checkbox"/> EN 55014-1 | Limits and methods of measurement of radio disturbance characteristics of household electrical appliances, portable tools and similar electrical apparatus | <input type="checkbox"/> EN 55082-1 | Generic immunity standard Part 1: Residential, commercial and light industry |
| <input type="checkbox"/> EN 55015 | Limits and methods of measurement of radio disturbance characteristics of fluorescent lamps and luminaires | <input type="checkbox"/> EN 55082-2 | Generic immunity standard Part 2: Industrial environment |
| <input type="checkbox"/> EN 55020 | Immunity from radio interference of equipment | <input type="checkbox"/> EN 55014-2 | Immunity requirements for household appliances tools and similar apparatus |
| <input checked="" type="checkbox"/> EN 55022 | Limits and methods of measurement of radio disturbance characteristics of information technology equipment | <input type="checkbox"/> EN 50091-2 | EMC requirements for uninterruptible power systems (UPS) |
| <input type="checkbox"/> EN VDE 0855 | Cabled distribution systems. Equipment | | |
| <input type="checkbox"/> EN 50174 | Power supply systems for television sound and television signals | | |
| <input type="checkbox"/> EN 60085 | Safety requirements for mains operated household and similar general use electrical appliances | | |
| <input type="checkbox"/> EN 60335 | Safety of household and similar electrical appliances | | |
| <input type="checkbox"/> EN 50091-1 | General and Safety requirements for uninterruptible power systems (UPS) | | |



(EC conformity marking)

The manufacturer/declarer declares the conformity of above mentioned product with the actual required safety standards in accordance with LVD 73/23 EEC

EN 60950

EN 60950

EN 50091-1

Manufacturer/Importer

Signature: *Jimmy Huang*

Date: Feb. 25, 2005

Name: Timmy Huang

(Stamp)

DECLARATION OF CONFORMITY

Per FCC Part 2, Section 2.1077(a)



Responsible Party Name: G.B.T. INC. (U.S.A.)

Address: 17358 Railroad Street

City of Industry, CA 91748

Phone/Fax No: (818) 854-9338 / (818) 854-9339

hereby declares that the product

Product Name: **Motherboard**

Model Number: GA-K8N Pro-SLI

Conforms to the following specifications:

FCC Part 15, Subpart B, Section 15.107(a) and Section 15.109

(a), Class B Digital Device

Supplementary Information:

This device complies with part 15 of the FCC Rules. Operation is subject to the following two conditions: (1) This device may not cause harmful and (2) this device must accept any interference received, including that may cause undesired operation.

Representative Person's Name: ERIC LU

Signature: *Eric Lu*

Date: Feb. 25, 2005

Declaration of Conformity

G.B.T. Technology, Inc.
We, Manufacturer/Importer
(full address)
Ausselshager Weg 41, Ff 20327 Hamburg, Germany

(description of the apparatus, system, installation to which it refers)
I declare that the product
GA-K8N-SLI
Motherboard
is in conformity with (reference to the specification in accordance with 90/269 EEC EMC Directive)

- | | | | |
|--|---|--|---|
| <input type="checkbox"/> EN 55011 | Limits and methods of measurement of radio disturbance characteristics of industrial, scientific and medical (ISM) high frequency equipment | <input checked="" type="checkbox"/> EN 61000-3-2 | Disturbances in supply systems caused by household appliances and similar electrical equipment. Voltage fluctuations* |
| <input type="checkbox"/> EN 55013 | Limits and methods of measurement of radio disturbance characteristics of equipment | <input checked="" type="checkbox"/> EN 55024 | Information Technology equipment/Immunity requirements |
| <input type="checkbox"/> EN 55014-1 | Limits and methods of measurement of radio disturbance characteristics of portable tools and similar electrical apparatus | <input type="checkbox"/> EN 55082-1 | Generic immunity standard Part 1: Residential, commercial and light industry |
| <input type="checkbox"/> EN 55015 | Limits and methods of measurement of radio disturbance characteristics of fluorescent lamps and luminaires | <input type="checkbox"/> EN 55082-2 | Generic immunity standard Part 2: Industrial environment |
| <input type="checkbox"/> EN 55020 | Immunity from radio interference of equipment | <input type="checkbox"/> EN 55014-2 | Immunity requirements for household appliances tools and similar apparatus |
| <input checked="" type="checkbox"/> EN 55022 | Limits and methods of measurement of radio disturbance characteristics of information technology equipment | <input type="checkbox"/> EN 50091-2 | EMC requirements for uninterruptible power systems (UPS) |
| <input type="checkbox"/> EN VDE 0855 | Cabled distribution systems. Equipment | | |
| <input type="checkbox"/> EN 50174 | Power supply systems from sound and television signals | | |
| <input type="checkbox"/> EN 60335 | Safety of household and similar electrical appliances | <input type="checkbox"/> EN 50091-1 | General and Safety requirements for uninterruptible power systems (UPS) |
| <input type="checkbox"/> EN 60085 | Safety requirements for mains operated household and similar general use | <input type="checkbox"/> EN 60950 | Safety for information technology equipment including electrical business equipment |
| <input checked="" type="checkbox"/> CE marking | The manufacturer/ importer declares the conformity of above standard product with the actual required safety standards in accordance with LVD 73/23 EEC | | |



(EEC conformity marking)

Manufacturer/Importer

(Stamp)

Date: Aug 8, 2005

Signature: Timmy Huang
Name: Timmy Huang

DECLARATION OF CONFORMITY

Per FCC Part 2, Section 2.1077(a)



Responsible Party Name: G.B.T. INC. (U.S.A.)

Address: 17358 Railroad Street

City of Industry, CA 91748

Phone/Fax No: (818) 854-9338 / (818) 854-9339

hereby declares that the product

Product Name: **Motherboard**

Model Number: **GA-K8N-SLI**

Conforms to the following specifications:

FCC Part 15, Subpart B, Section 15.107(a) and Section 15.109

(a), Class B Digital Device

Supplementary Information:

This device complies with part 15 of the FCC Rules. Operation is subject to the following two conditions: (1) This device may not cause harmful and (2) this device must accept any interference received, including that may cause undesired operation.

Representative Person's Name: ERIC LU

Signature: Eric Lu

Date: Aug. 8, 2005

Copyright

© 2006 GIGA-BYTE TECHNOLOGY CO., LTD. All rights reserved.

The trademarks mentioned in the manual are legally registered to their respective companies.

Notice

The written content provided with this product is the property of Gigabyte.

No part of this manual may be reproduced, copied, translated, or transmitted in any form or by any means without Gigabyte's prior written permission. Specifications and features are subject to change without prior notice.

Product Manual Classification

In order to assist in the use of this product, Gigabyte has categorized the user manual in the following:

- For quick installation, please refer to the "Hardware Installation Guide" included with the product.
- For detailed product information and specifications, please carefully read the "Product User Manual".
- For detailed information related to Gigabyte's unique features, please go to the "Technology Guide" section on Gigabyte's website to read or download the information you need.

For more product details, please click onto Gigabyte's website at www.gigabyte.com.tw

Table of Contents

GA-K8N Ultra-SLI / GA-K8N Pro-SLI / GA-K8N-SLI Motherboard Layout	8
Block Diagram	9
Chapter 1 Hardware Installation	11
1-1 Considerations Prior to Installation	11
1-2 Feature Summary	12
1-3 Installation of the CPU and Fan Heat Sink	14
1-3-1 Installation of the CPU	14
1-3-2 Installation of the Fan Heat Sink	15
1-4 Installation of Memory	16
1-5 Installation of Expansion Cards	18
1-6 Setup of SLI (Scalable Link Interface) Configuration	19
1-7 I/O Back Panel Introduction	22
1-8 Connectors Introduction	23
Chapter 2 BIOS Setup	33
The Main Menu (For example: BIOS Ver. : F6a)	34
2-1 Standard CMOS Features	36
2-2 Advanced BIOS Features	38
2-3 Integrated Peripherals	40
2-4 Power Management Setup	44
2-5 PnP/PCI Configurations	45
2-6 PC Health Status	46
2-7 MB Intelligent Tweaker(M.I.T.)	49
2-8 Top Performance	52
2-9 Load Optimized Defaults	52
2-10 Set Supervisor/User Password	53
2-11 Save & Exit Setup	54
2-12 Exit Without Saving	54

Chapter 3 Drivers Installation	55
3-1 Install Chipset Drivers	55
3-2 Software Application	56
3-3 Software Information	56
3-4 Hardware Information	57
3-5 Contact Us	57
 Chapter 4 Appendix	 59
4-1 Unique Software Utilities	59
4-1-1 EasyTune 5 Introduction	59
4-1-2 Xpress Recovery2 Introduction	60
4-1-3 Flash BIOS Method Introduction	62
4-1-4 Serial ATA BIOS Setting Utility Introduction	73
4-1-5 2- / 4- / 6- / 8- Channel Audio Function Introduction	79
4-2 Troubleshooting	85

GA-K8N Ultra-SLI/ GA-K8N Pro-SLI/ GA-K8N-SLI Motherboard Layout

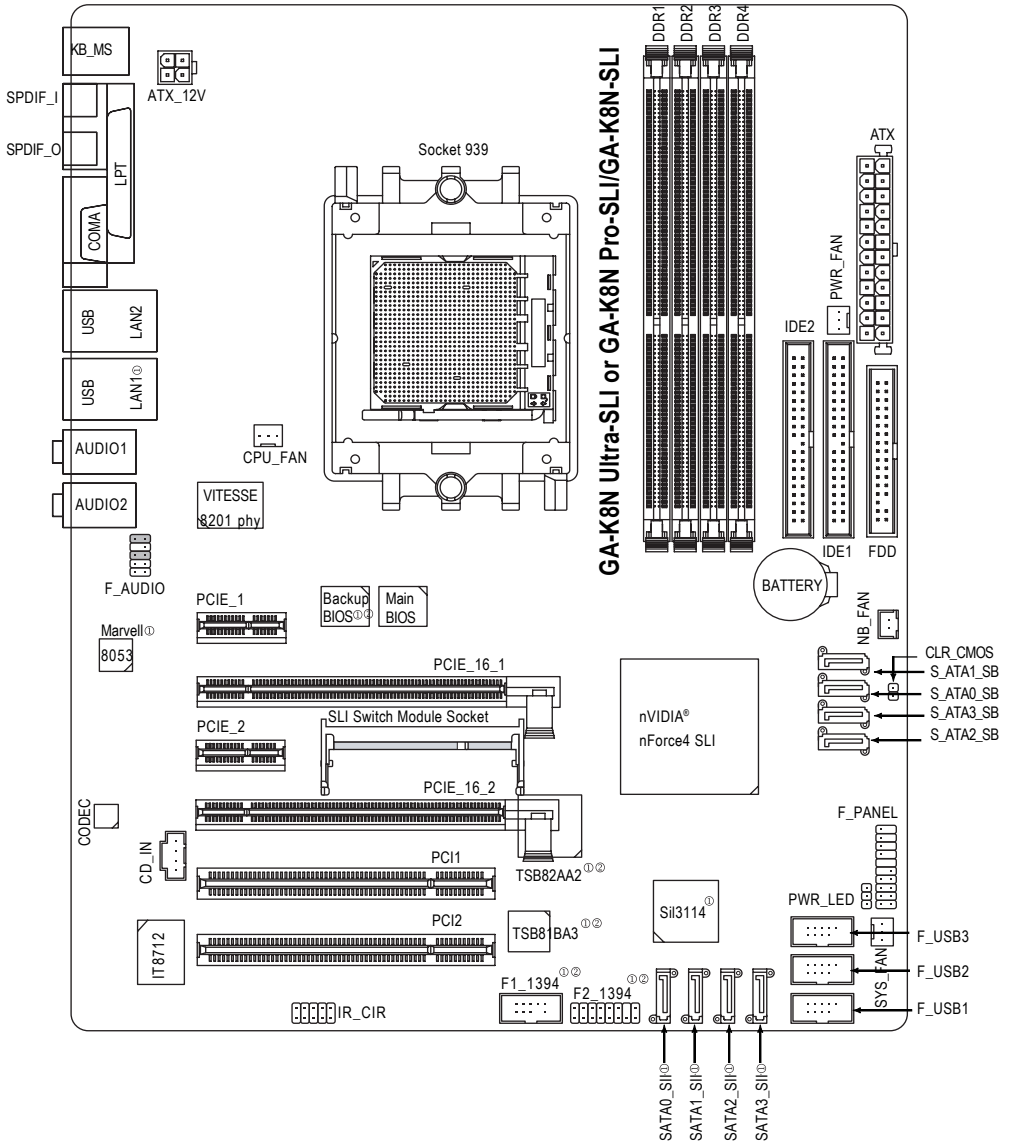

① Only for GA-K8N Ultra-SLI.

② Only for GA-K8N Pro-SLI.

Chapter 1 Hardware Installation

1-1 Considerations Prior to Installation

Preparing Your Computer

The motherboard contains numerous delicate electronic circuits and components which can become damaged as a result of electrostatic discharge (ESD). Thus, prior to installation, please follow the instructions below:

1. Please turn off the computer and unplug its power cord.
2. When handling the motherboard, avoid touching any metal leads or connectors.
3. It is best to wear an electrostatic discharge (ESD) cuff when handling electronic components (CPU, RAM).
4. Prior to installing the electronic components, please have these items on top of an antistatic pad or within a electrostatic shielding container.
5. Please verify that the power supply is switched off before unplugging the power supply connector from the motherboard.

Installation Notices

1. Prior to installation, please do not remove the stickers on the motherboard. These stickers are required for warranty validation.
2. Prior to the installation of the motherboard or any hardware, please first carefully read the information in the provided manual.
3. Before using the product, please verify that all cables and power connectors are connected.
4. To prevent damage to the motherboard, please do not allow screws to come in contact with the motherboard circuit or its components.
5. Please make sure there are no leftover screws or metal components placed on the motherboard or within the computer casing.
6. Please do not place the computer system on an uneven surface.
7. Turning on the computer power during the installation process can lead to damage to system components as well as physical harm to the user.
8. If you are uncertain about any installation steps or have a problem related to the use of the product, please consult a certified computer technician.

Instances of Non-Warranty

1. Damage due to natural disaster, accident or human cause.
2. Damage as a result of violating the conditions recommended in the user manual.
3. Damage due to improper installation.
4. Damage due to use of uncertified components.
5. Damage due to use exceeding the permitted parameters.
6. Product determined to be an unofficial Gigabyte product.

1-2 Feature Summary

Motherboard	<ul style="list-style-type: none"> GA-K8N Ultra-SLI or GA-K8N Pro-SLI or GA-K8N-SLI
CPU	<ul style="list-style-type: none"> Socket 939 for AMD Athlon™ 64 / 64 FX processor (K8) 2000MT/s system bus Supports core frequencies in excess of 3000+ and faster
Chipset	<ul style="list-style-type: none"> nVIDIA® nForce4 SLI Chipset
Memory	<ul style="list-style-type: none"> 4 DDR DIMM memory slots (supports up to 4GB memory) ^(Note 1) Supports dual channel DDR 400/333/266/200 DIMM
Slots	<ul style="list-style-type: none"> 2 PCI Express x 16 slots 2 PCI Express x 1 slots 2 PCI slots
IDE Connections	<ul style="list-style-type: none"> 2 IDE connection (UDMA 33/ATA 66/ATA 100/ATA 133), allows connection of 4 IDE devices
FDD Connections	<ul style="list-style-type: none"> 1 FDD connection, allows connection of 2 FDD devices
Onboard SATA	<ul style="list-style-type: none"> 4 SATA 3Gb/s ports from nVIDIA® nForce4 SLI controller (S_ATA0_SB, S_ATA1_SB, S_ATA2_SB, S_ATA3_SB); 4 SATA ports from SiI3114 controller (SATA0_SII, SATA1_SII, SATA2_SII, SATA3_SII)^①
Peripherals	<ul style="list-style-type: none"> 1 parallel port supporting Normal/EPP/ECP mode 1 serial port (COMA) 10 USB 2.0/1.1 ports (rear x 4, front x 6 via cable) 3 IEEE1394b ports (requires cable) ^② 1 front audio connector 1 IR/CIR connector 1 PS/2 keyboard port 1 PS/2 mouse port
Onboard LAN	<ul style="list-style-type: none"> Onboard Marvell 8053 chip (10/100/1000 Mbit) (LAN1)^① Onboard VITESSE 8201 phy (10/100/1000 Mbit) (LAN2) 2 RJ45 ports
Onboard Audio	<ul style="list-style-type: none"> ALC850 CODEC Supports Jack Sensing function Supports 2 / 4 / 6 / 8 channel audio Supports Line In ; Line Out (Front Speaker Out) ; MIC ; Surround Speaker Out (Rear Speaker Out) ; Center/Subwoofer Speaker Out ; Side Speaker Out connection SPDIF In/Out connection CD In connection

(Note 1) Due to standard PC architecture, a certain amount of memory is reserved for system usage and therefore the actual memory size is less than the stated amount.

For example, 4 GB of memory size will instead be shown as 3.xxGB memory during system startup.

① Only for GA-K8N Ultra-SLI.

② Only for GA-K8N Pro-SLI.

I/O Control	♦ IT8712
Hardware Monitor	<ul style="list-style-type: none"> ♦ System voltage detection ♦ CPU temperature detection ♦ CPU / System / Power fan speed detection ♦ CPU warning temperature ♦ CPU fan failure warning ♦ CPU smart fan control
Onboard SATA RAID	<ul style="list-style-type: none"> ♦ Onboard nForce4 SLI chipset (S_ATA0_SB, S_ATA1_SB, S_ATA2_SB, S_ATA3_SB) <ul style="list-style-type: none"> - supports data striping (RAID 0), mirroring (RAID 1), or striping + mirroring (RAID 0+1) - supports data transfer rate of up to 300 MB/s - supports hot plugging function - supports a maximum of 4 SATA 3Gb/s connections ♦ Onboard Silicon Image SiI3114 chip[®] (SATA0_SII, SATA1_SII, SATA2_SII, SATA3_SII) <ul style="list-style-type: none"> - supports data striping (RAID 0), mirroring (RAID 1), striping + mirroring (RAID 0+1) or RAID 5 - supports data transfer rate of up to 150 MB/s - supports hot plugging function - supports a maximum of 4 SATA connections - supported on the Win 2003/2000/XP operating systems
BIOS	<ul style="list-style-type: none"> ♦ Use of licensed AWARD BIOS ♦ Supports Dual BIOS[®]/Q-Flash
Additional Features	<ul style="list-style-type: none"> ♦ Supports @BIOS ♦ Supports EasyTune 5 ^(Note 2)
Overclocking	<ul style="list-style-type: none"> ♦ Over Voltage via BIOS (CPU/ DDR/ HT-Link/ Chipset core PCI-E) ♦ Over Clock via BIOS (CPU/ PCI-E)
Form Factor	♦ ATX form factor; 30.5cm x 24.4cm

(Note 2) EasyTune 5 functions may vary depending on different motherboards.

① Only for GA-K8N Ultra-SLI. ② Only for GA-K8N Pro-SLI.

1-3 Installation of the CPU and Fan Heat Sink



Before installing the CPU, please comply with the following conditions:

1. Please make sure that the motherboard supports the CPU.
2. Please take note of the one indented corner of the CPU. If you install the CPU in the wrong direction, the CPU will not insert properly. If this occurs, please change the insert direction of the CPU.
3. Please add an even layer of heat sink paste between the CPU and fan heat sink.
4. Please make sure the fan heat sink is installed on the CPU prior to system use, otherwise overheating and permanent damage of the CPU may occur.
5. Please set the CPU host frequency in accordance with the processor specifications. It is not recommended that the system bus frequency be set beyond hardware specifications since it does not meet the required standards for the peripherals. If you wish to set the frequency beyond the proper specifications, please do so according to your hardware specifications including the CPU, graphics card, memory, hard drive, etc.

1-3-1 Installation of the CPU

Check the processor pins to see that none are bent. Move the socket lever to the unlocked position as shown in Figure 1.(90° to the plane of the motherboard) prior to inserting the processor. The pin 1 location is designated on the processor by a copper triangle that matches up to a triangle on the socket as shown in Figure 2. Align the processor to the socket and gently lower it into place. Do not force the processor into the socket.

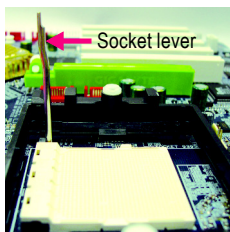

Fig.1

Position lever at a 90 degree angle.

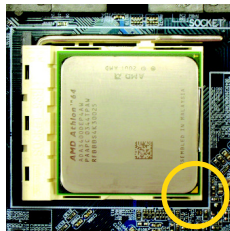

Fig.2

Pin 1 location on the socket and processor.

Gently place the CPU into position making sure that the CPU pins fit perfectly into their holes. Once the CPU is positioned into its socket, place one finger down on the middle of the CPU and gently press the metal lever back into its original position.



Please use extra care when installing the CPU. The CPU will not fit if positioned incorrectly. Rather than applying force, please change the positioning of the CPU.

1-3-2 Installation of the Fan Heat Sink

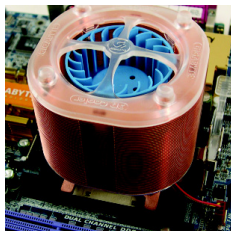

Fig.1

Before installing the CPU fan heat sink, please first add an even layer of heat sink paste on the surface of the CPU. Install all the fan heat sink components (Please refer to the fan heat sink manual for detailed installation instructions).

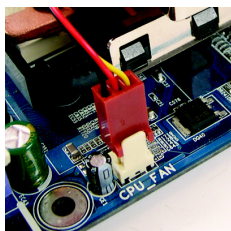

Fig.2

Please connect the fan heat sink power connector to the CPU_FAN connector located on the motherboard so that the fan heat sink can properly function to prevent CPU overheating.



NOTE

The fan heat sink may adhere to the CPU as a result of hardening of the heat sink paste. To prevent such an occurrence, it is suggested that either thermal tape rather than heat sink paste be used for heat dissipation or using extreme care when removing the fan heat sink.

1-4 Installation of Memory



Before installing the memory modules, please comply with the following conditions:

1. Please make sure that the memory used is supported by the motherboard. It is recommended that memory of similar capacity, specifications and brand be used.
2. Before installing or removing memory modules, please make sure that the computer power is switched off to prevent hardware damage.
3. Memory modules have a foolproof insertion design. A memory module can be installed in only one direction. If you are unable to insert the module, please switch the direction.

The motherboard supports DDR memory modules, whereby BIOS will automatically detect memory capacity and specifications. Memory modules are designed so that they can be inserted only in one direction. The memory capacity used can differ with each slot.

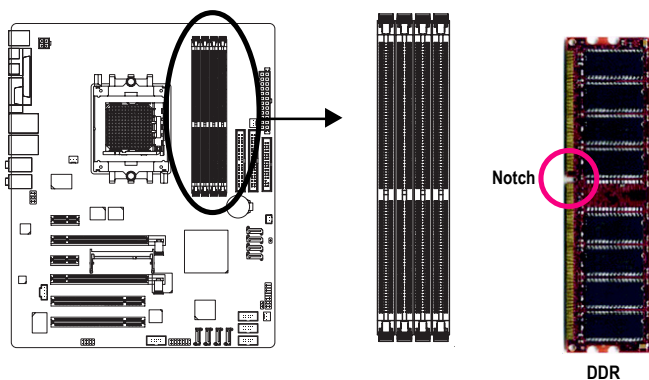

Fig.1

The DIMM socket has a notch, so the DIMM memory module can only fit in one direction. Insert the DIMM memory module vertically into the DIMM socket. Then push it down.



Fig.2

Close the plastic clip at both edges of the DIMM sockets to lock the DIMM module.

Reverse the installation steps when you wish to remove the DIMM module.

Dual Channel Memory Configuration

The GA-K8N Ultra-SLI/GA-K8N Pro-SLI/GA-K8N-SLI supports the Dual Channel Technology. When the Dual Channel Technology is activated, the bandwidth of memory bus will be double the original one.

Due to CPU limitation, if you want to operate the Dual Channel Technology, please follow the guidelines below for Dual Channel memory configuration.

1. Dual Channel mode will not be enabled if only one DDR memory module is installed.
2. To enable Dual Channel mode with 2 memory modules (it is recommended to use memory modules of identical brand, size, chips, and speed), you must install them into DIMM sockets of the same color.
3. To enable Dual Channel mode with 4 memory modules, it is recommended to use memory modules of identical brand, size, chips, and speed.

The following is a Dual Channel Memory configuration table: (DS: Double Side, SS: Single Side)

	DDR1	DDR2	DDR3	DDR4
2 memory modules	DS/SS	DS/SS	X	X
	X	X	DS/SS	DS/SS
4 memory modules	DS/SS	DS/SS	DS/SS	DS/SS



NOTE

If two memory modules are to be used to achieve Dual Channel mode, we recommend installing them in DDR1 and DDR2 DIMM sockets.



CAUTION

All of the memory configurations below will cause system unable to boot.
(DS: Double Side, SS: Single Side)

	DDR1	DDR2	DDR3	DDR4
1 memory module	X	DS/SS	X	X
	X	X	X	DS/SS
2 memory modules	X	DS/SS	DS/SS	X
	DS/SS	X	X	DS/SS
	X	DS/SS	X	DS/SS
3 memory modules	DS/SS	DS/SS	DS/SS	X
	X	DS/SS	DS/SS	DS/SS
	DS/SS	X	DS/SS	DS/SS
	DS/SS	DS/SS	X	DS/SS

1-5 Installation of Expansion Cards

You can install your expansion card by following the steps outlined below:

1. Read the related expansion card's instruction document before install the expansion card into the computer.
2. Remove your computer's chassis cover, screws and slot bracket from the computer.
3. Press the expansion card firmly into expansion slot in motherboard.
4. Be sure the metal contacts on the card are indeed seated in the slot.
5. Replace the screw to secure the slot bracket of the expansion card.
6. Replace your computer's chassis cover.
7. Power on the computer, if necessary, setup BIOS utility of expansion card from BIOS.
8. Install related driver from the operating system.

Installing a PCI Express x 16 expansion card:

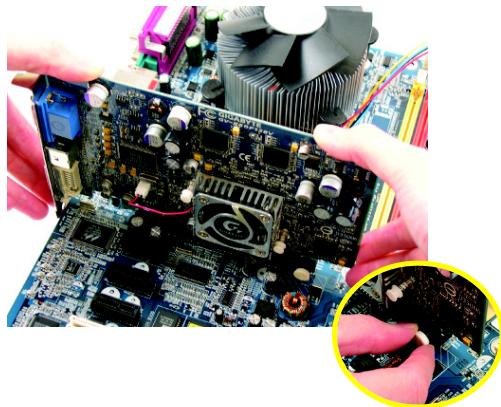

Please carefully pull out the small white-drawable bar at the end of the PCI Express x 16 slot when you try to install/uninstall the VGA card. Please align the VGA card to the onboard PCI Express x 16 slot and press firmly down on the slot. Make sure your VGA card is locked by the small white-drawable bar.

1-6 Setup of SLI (Scalable Link Interface) Configuration

NVIDIA nForce4 SLI offers blistering graphics performance with the ability to bridge two NVIDIA SLI-ready PCI Express™ graphics cards! The SLI design takes advantage of the increased bandwidth of the PCI Express™ bus architecture, features hardware and software innovations within NVIDIA GPU (graphics processing unit) and the NVIDIA nForce4 chipset. Together, the NVIDIA SLI technologies work seamlessly to allow two graphics cards to operate in parallel and share the work and deliver heart-pounding PC performance. This section introduces steps to configure an SLI system on the GA-K8N Ultra-SLI/GA-K8N Pro-SLI/GA-K8N-SLI motherboard.

Before You Begin--

I. Understanding the GIGABYTE SLI switch module:

You can find an SLI switch module socket inserted with an SLI switch module between the first and second PCIE x 16 slots. The SLI switch module has gold edge connectors on the top and bottom of it. One connector is SLI Mode and the other is Normal Mode.



Normal Mode: Only the first PCIE x 16 slot is available and can operate at up to x 16 in Normal Mode.

SLI Mode: In SLI Mode, the two PCIE x 16 slots can run in two modes. You can either use them as two individual x 8 slots or install two SLI-ready PCIE x 16 cards (Example: GIGABYTE GV-NX66T128D) of the same model and link them together with an SLI bridge connector to enable SLI function to provide enhanced performance.

To change to a mode, you need to insert the switch module into the switch socket with the gold edge connector on the top. As not all PCIE slots are available while in SLI or Normal Mode, please refer to the table below to check PCIE slots available in SLI or Normal Mode before installation.

	PCIE_1	PCIE_16_1	PCIE_2	PCIE_16_2
SLI Mode	Available	Available*	Not available	Available*
Normal Mode	Available	Available	Available	Not available

*** can run at up to PCIE x 8 mode.



1. Installing a device to a PCIE slot when it's not available might damage the system.
2. We do not recommend removing the SLI switch module from the motherboard because in that case, all PCIE slots will not be available except for the PCIE_16_1 slot, and the slot can be used only as a PCIE x 8 slot.

II. Power Requirements:

The exact power requirements will depend on your overall system configurations. You need a power supply that can provide sufficient and stable power to your system and the two SLI graphics cards. Please refer to the table below to check recommended power for different systems.

System configurations	System A	System B
Processors	AMD Athlon 64 FX-53	AMD Athlon 64 4000+
PCIE x 16 video cards	2 NVIDIA 6800 Ultra cards	2 NVIDIA 6600 GT cards
DDR memory modules	4 DIMMs	2 DIMMs
Hard drives/Optical drives	4 hard drives + 2 optical drives	1 hard drives + 1 optical drives
Expansion cards	1 PCIE x1 card + 2 PCI cards	0
USB devices	10	4
IEEE1394 devices	1	0
Required +12V current	25A or above	20A or above
Power supply requirement	500W or above	350W or above

III. Supported Operating Systems:

Only Windows XP operating system is currently supported by the NVIDIA SLI technology.

Enabling SLI Mode--

Follow the steps below to enable SLI Mode. Note that as the switch module is inserted in the socket in the Normal Mode direction by factory default, the first step to enable SLI mode on your system is to take out the module from the socket and insert it in the SLI Mode direction.

Step 1: Gently spread the retaining clips of the socket and the module may then be removed from the socket. Hold the module by the edges and lift it away from the socket.

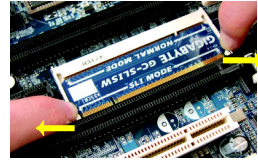

Step 2: Position the SLI Mode side of the module above the socket at a 25° angle. Align the small notch at the top edge of the module with the key in the socket.



Step 3: Insert the top edge of the module into the socket. Make sure the gold edge connectors are fully inserted.

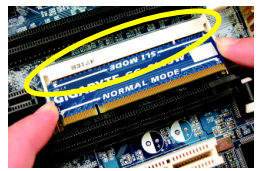

Step 4: Gently press down on the two ends of the module until it is locked in place by the socket clips. (You should hear a "click" when the module is attached.)

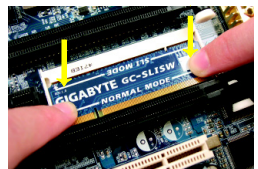

Connecting Two Graphics Cards:

Step 1: Observe the steps in "1-5 Installation of Expansion Cards" on page 16 and install two SLI-ready graphics cards of the same model to the PCIE_16_1 and PCIE_16_2 slots.

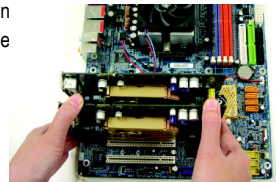

Step 2: Insert the SLI bridge (the GC-SLICON) to the SLI gold edge connector on top of both cards. Make sure the two mini female slots on the bridge connector securely fit onto the SLI gold edge connectors of both cards.

Female slots on the bridge connector



Gold edge connector on the top of graphics card

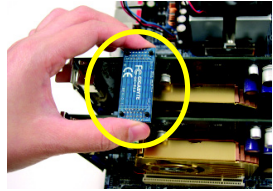
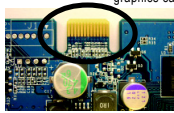

Step 3: In order to securely fix the bridge connector between the two cards, you must install the retention bracket included with the motherboard and secure the retention bracket to the chassis back panel with a screw.



retention bracket

place this part on the top of the bridge connector.

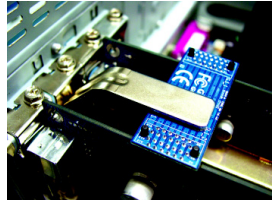

Step 4: Plug the display cable into either one of the two graphics cards for display output. If you plug the display cable to the card on the PCIe_16_1 slot, make sure to set **Init Display First** in BIOS Setup to **PEG**; if you plug the display cable to the card on the PCIe_16_2 slot, set **Init Display First** to **PEG(Slot2)**.

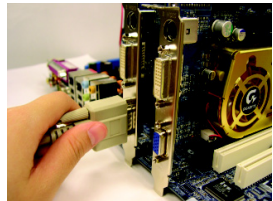

Graphics Card Driver Setting:

Step 1: After installing graphics card driver in operating system, right-click the NVIDIA icon in your system tray and then select **NVIDIA Display**. The NVIDIA control panel will appear.



Step 2: Select **SLI multi-GPU** from the side menu and then select the **Enable SLI multi-GPU** checkbox in the SLI multi-GPU dialog box. System will restart after you click **Apply**. Then the SLI configuration is completed.

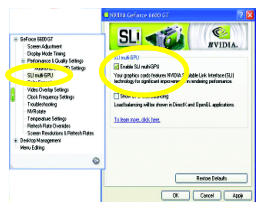

1-7 I/O Back Panel Introduction

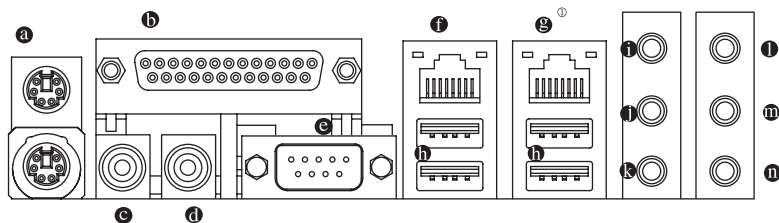

❶ PS/2 Keyboard and PS/2 Mouse Connector

To install a PS/2 port keyboard and mouse, plug the mouse to the upper port (green) and the keyboard to the lower port (purple).

❷ Parallel Port

The parallel port allows connection of a printer, scanner and other peripheral devices.

❸ SPDIF_I (SPDIF In)

Use SPDIF In feature only when your device has digital output function.

❹ SPDIF_O (SPDIF Out)

The SPDIF output is capable of providing digital audio to external speakers or compressed AC3 data to an external Dolby Digital Decoder.

❺ COMA (Serial Port)

Connects to serial-based mouse or data processing devices.

❻ LAN Port 2

The provided Internet connection is Gigabit Ethernet, providing data transfer speeds of 10/100/1000Mbps.

❼ LAN Port 1^①

The provided Internet connection is Gigabit Ethernet (PCI Express Gigabit), providing data transfer speeds of 10/100/1000Mbps.

❽ USB port

Before you connect your device(s) into USB connector(s), please make sure your device(s) such as USB keyboard, mouse, scanner, zip, speaker...etc. have a standard USB interface. Also make sure your OS supports USB controller. If your OS does not support USB controller, please contact OS vendor for possible patch or driver upgrade. For more information please contact your OS or device(s) vendors.

❾ Line In

Devices like CD-ROM, walkman etc. can be connected to Line In jack.

❿ Line Out (Front Speaker Out)

Connect the stereo speakers, earphone or front surround speakers to this connector.

⓫ MIC In

Microphone can be connected to MIC In jack.

① Only for GA-K8N Ultra-SLI.

① Center/Subwoofer Speaker Out

Connect the Center/Subwoofer speakers to this connector.

⑩ Rear Speaker Out

Connect the rear surround speakers to this connector.

⑪ Side Speaker Out

Connect the side surround speakers to this connector.



You can use audio software to configure 2-/4-/6-/8-channel audio functioning.

1-8 Connectors Introduction

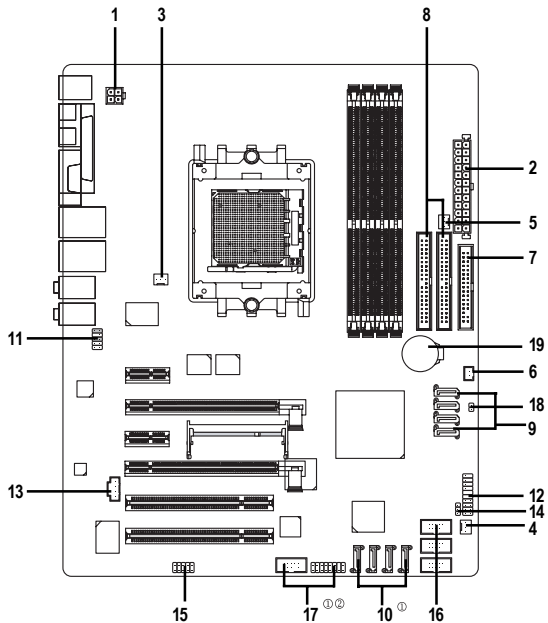

1) ATX_12V	11) F_AUDIO
2) ATX (Power Connector)	12) F_PANEL
3) CPU_FAN	13) CD_IN
4) SYS_FAN	14) PWR_LED
5) PWR_FAN	15) IR/CIR
6) NB_FAN	16) F_USB1 / F_USB2/F_USB3
7) FDD	17) F1_1394/F2_1394 ^{①②}
8) IDE1 / IDE2	18) CLR_CMOS
9) S_ATA0/1/2/3_SB	19) BATTERY
10) SATA0/1/2/3_SII ^①	

① Only for GA-K8N Ultra-SLI.

② Only for GA-K8N Pro-SLI.

1/2) ATX_12V/ATX (Power Connector)

With the use of the power connector, the power supply can supply enough stable power to all the components on the motherboard. Before connecting the power connector, please make sure that all components and devices are properly installed. Align the power connector with its proper location on the motherboard and connect tightly.

The ATX_12V power connector mainly supplies power to the CPU. If the ATX_12V power connector is not connected, the system will not start.

Caution!

Please use a power supply that is able to handle the system voltage requirements. It is recommended that a power supply that can withstand high power consumption be used (300W or greater). If a power supply is used that does not provide the required power, the result can lead to an unstable system or a system that is unable to start.

If you use a 24-pin ATX power supply, please remove the small cover on the power connector on the motherboard before plugging in the power cord ; otherwise, please do not remove it.

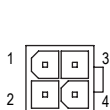
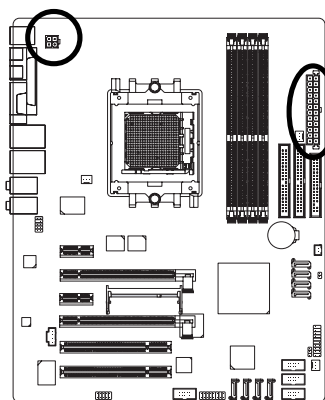

Pin No.	Definition
1	GND
2	GND
3	+12V
4	+12V

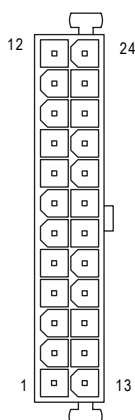

Pin No.	Definition	Pin No.	Definition
1	3.3V	13	3.3V
2	3.3V	14	-12V
3	GND	15	GND
4	+5V	16	PS_ON(soft On/Off)
5	GND	17	GND
6	+5V	18	GND
7	GND	19	GND
8	Power Good	20	-5V
9	5V SB(stand by +5V)	21	+5V
10	+12V	22	+5V
11	+12V(Only for 24-pin ATX)	23	+5V (Only for 24-pin ATX)
12	3.3V(Only for 24-pin ATX)	24	GND(Only for 24-pin ATX)

3/4/5) CPU_FAN / SYS_FAN/ PWR_FAN (Cooler Fan Power Connector)

The cooler fan power connector supplies a +12V power voltage via a 3-pin power connector and possesses a foolproof connection design.

Most coolers are designed with color-coded power connector wires. A red power connector wire indicates a positive connection and requires a +12V power voltage. The black connector wire is the ground wire (GND).

Please remember to connect the power to the cooler to prevent system overheating and failure.

Caution!

Please remember to connect the power to the CPU fan to prevent CPU overheating and failure.

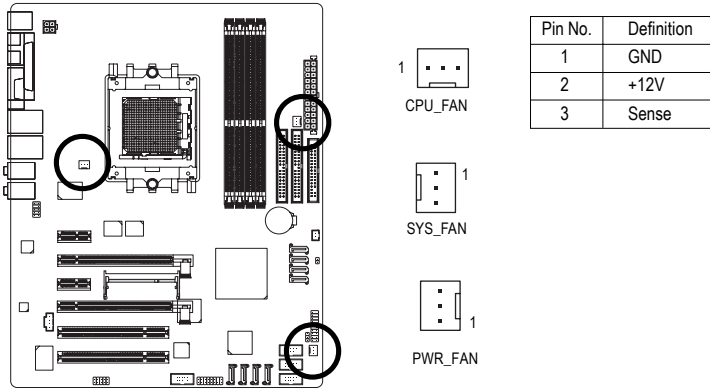

6) NB_FAN (Chip Fan Power Connector)

If you installed wrong direction, the chip fan will not work. Sometimes will damage the chip fan. (Usually black cable is GND)

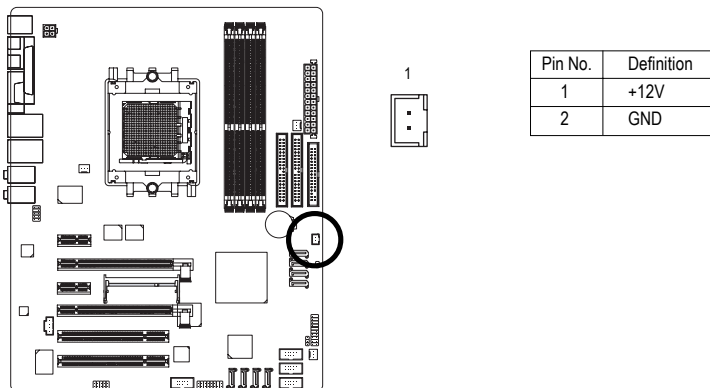

7) FDD (FDD Connector)

The FDD connector is used to connect the FDD cable while the other end of the cable connects to the FDD drive. The types of FDD drives supported are: 360KB, 720KB, 1.2MB, 1.44MB and 2.88MB. Please connect the red power connector wire to the pin1 position.

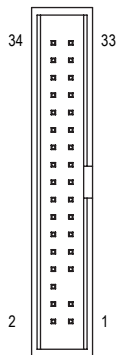
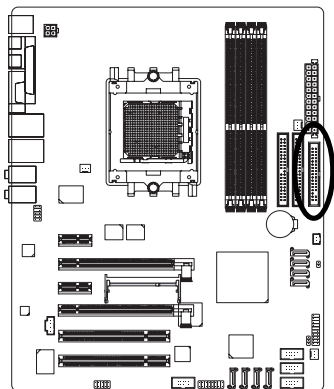

8) IDE1 / IDE2 (IDE Connector)

An IDE device connects to the computer via an IDE connector. One IDE connector can connect to one IDE cable, and the single IDE cable can then connect to two IDE devices (hard drive or optical drive). If you wish to connect two IDE devices, please set the jumper on one IDE device as Master and the other as Slave (for information on settings, please refer to the instructions located on the IDE device).

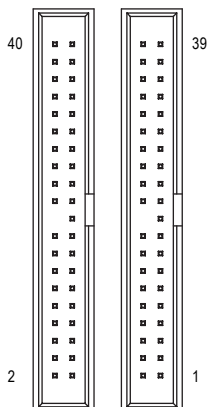
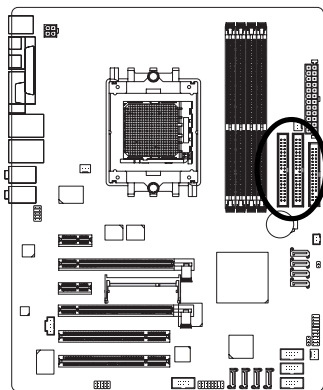

9) S_ATA0/1/2/3_SB (SATA 3Gb/s Connectors, Controlled by nForce4 SLI)

10) SATA0/1/2/3_SII (SATA Connectors, Controlled by SiI3114)①

SATA 3Gb/s can provide up to 300MB/s transfer rate while SATA provides up to 150MB/s transfer rate. Please refer to the BIOS setting for the Serial ATA controller(s) and install the proper driver in order to work properly.

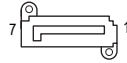
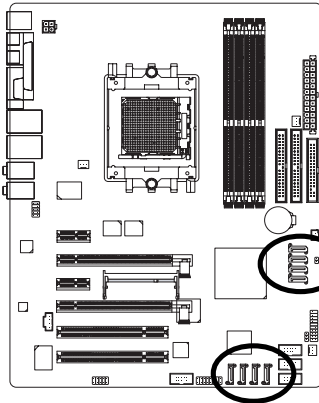

S_ATA_SB
(Controlled by nForce4 SLI)



SATA_SII
(Controlled by SiI3114)

Pin No.	Definition
1	GND
2	TXP
3	TXN
4	GND
5	RXN
6	RXP
7	GND

11) F_AUDIO (Front Audio Panel Connector)

If you want to use Front Audio connector, you must remove 5-6, 9-10 Jumper.

In order to utilize the front audio header, your chassis must have front audio connector. Also please make sure the pin assignment on the cable is the same as the pin assignment on the MB header. To find out if the chassis you are buying support front audio connector, please contact your dealer. Please note, you can have the alternative of using front audio connector or of using rear audio connector to play sound.

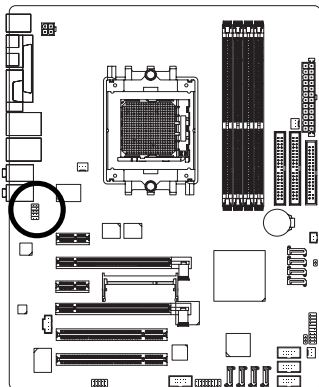

Pin No.	Definition
1	MIC
2	GND
3	MIC_BIAS
4	Power
5	Front Audio (R)
6	Rear Audio (R)/ Return R
7	NC
8	No Pin
9	Front Audio (L)
10	Rear Audio (L)/ Return L

① Only for GA-K8N Ultra-SLI.

12) F_PANEL (Front Panel Jumper)

Please connect the power LED, PC speaker, reset switch and power switch etc of your chassis front panel to the F_PANEL connector according to the pin assignment below.

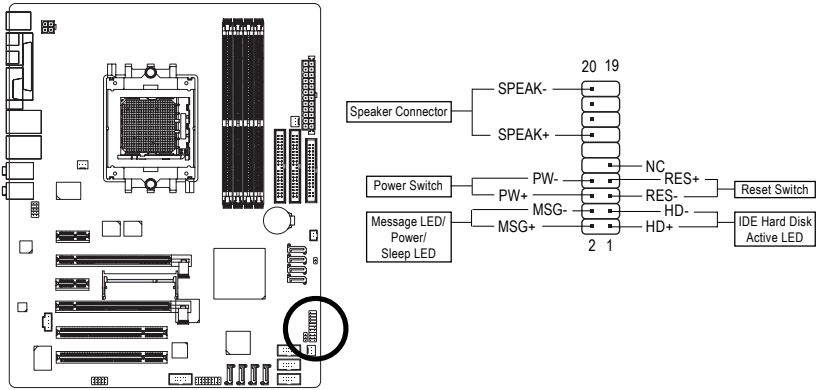

HD (IDE Hard Disk Active LED) (Blue)	Pin 1: LED anode(+) Pin 2: LED cathode(-)
SPEAK (Speaker Connector) (Amber)	Pin 1: Power Pin 2- Pin 3: NC Pin 4: Data(-)
RES (Reset Switch) (Green)	Open: Normal Close: Reset Hardware System
PW (Power Switch) (Red)	Open: Normal Close: Power On/Off
MSG(Message LED/Power/Sleep LED) (Yellow)	Pin 1: LED anode(+) Pin 2: LED cathode(-)
NC (Purple)	NC

13) CD_IN (CD In Connector)

Connect CD-ROM or DVD-ROM audio out to the connector.

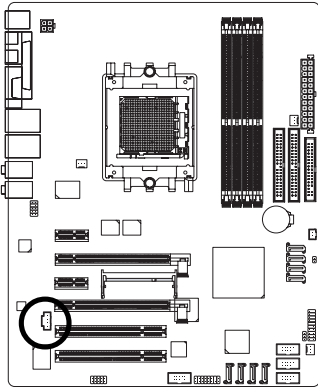

Pin No.	Definition
1	CD-L
2	GND
3	GND
4	CD-R

14) PWR_LED

PWR_LED is connect with the system power indicator to indicate whether the system is on/off. It will blink when the system enters suspend mode.

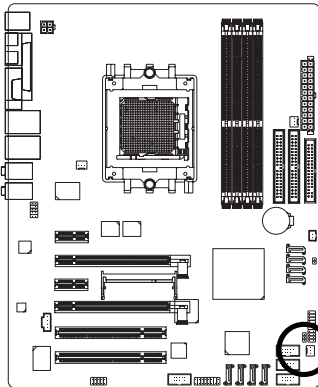

Pin No.	Definition
1	MPD+
2	MPD-
3	MPD-

15) IR_CIR

Make sure the pin 1 on the IR device is align with pin one the connector. To enable the IR/CIR function, you are required to purchase an optional IR/CIR module. To use IR function only, please connect IR module to Pin1 to Pin5. Be careful with the polarity of the IR/CIR connector. Check the pin assignment carefully while you connect the IR/CIR cable, incorrect connection between the cable and connector will make the device unable to work or even damage it. For optional IR/CIR cable, please contact your local dealer.

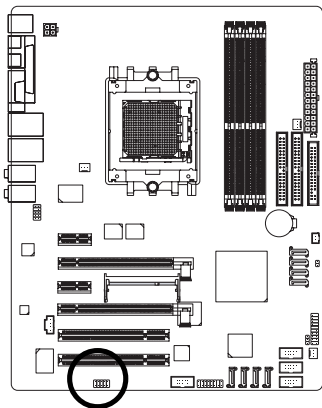

Pin No.	Definition
1	Power
2	NC
3	IRRX
4	GND
5	IRTX
6	NC
7	CIRRX
8	+5VSB
9	CIRTX
10	NC

16) F_USB1 / F_USB2/F_USB3 (Front USB Connector)

Be careful with the polarity of the front USB connector. Check the pin assignment carefully while you connect the front USB cable, incorrect connection between the cable and connector will make the device unable to work or even damage it. For optional front USB cable, please contact your local dealer.

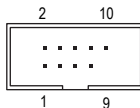
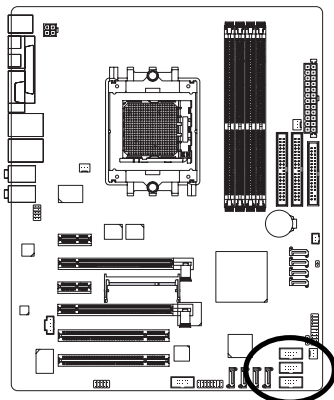

Pin No.	Definition
1	Power
2	Power
3	USB DX-
4	USB Dy-
5	USB DX+
6	USB Dy+
7	GND
8	GND
9	No Pin
10	NC

17) F1_1394/F2_1394 (IEEE 1394 Connectors) ①②

Serial interface standard set by Institute of Electrical and Electronics Engineers, which has features like high speed, high bandwidth and hot plug. Be careful with the polarity of the IEEE1394 connector. Check the pin assignment carefully while you connect the IEEE1394 cable, incorrect connection between the cable and connector will make the device unable to work or even damage it. For optional IEEE1394 cable, please contact your local dealer. IEEE1394b can approach the maximum speed to 800Mb/S, but the speed can be achieved only when you use particular IEEE1394b cable.

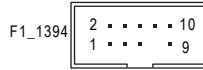
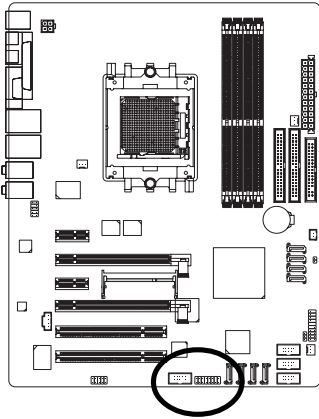

Pin No.	Definition
1	TPA0+
2	TPA0-
3	GND
4	GND
5	TPB0+
6	TPB0-
7	No Pin
8	Power
9	Power
10	GND

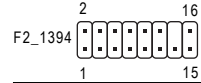

Pin No.	Definition
1	Power
2	Power
3	TPA1+
4	TPA1-
5	GND
6	GND
7	TPB1+
8	TPB1-
9	Power
10	Power
11	TPA2+
12	TPA2-
13	GND
14	No Pin
15	TPB2+
16	TPB2-

18) CLR_CMOS (Clear CMOS)

You may clear the CMOS data to its default values by this header. To clear CMOS, temporarily short 1-2 pin. Default doesn't include the jumper to prevent from improper use of this header.

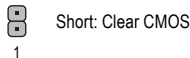
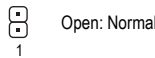
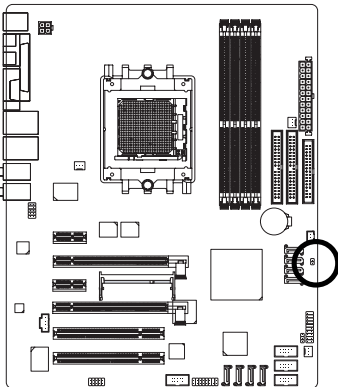

① Only for GA-K8N Ultra-SLI.

② Only for GA-K8N Pro-SLI.

19) BATTERY

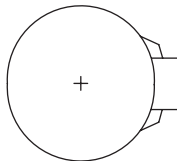
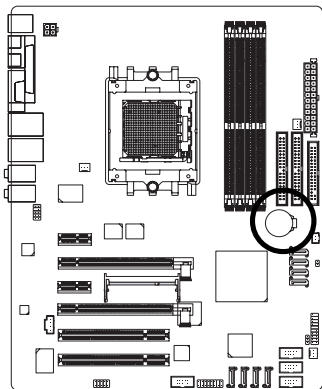

- ❖ Danger of explosion if battery is incorrectly replaced.
- ❖ Replace only with the same or equivalent type recommended by the manufacturer.
- ❖ Dispose of used batteries according to the manufacturer's instructions.

If you want to erase CMOS...

1. Turn OFF the computer and unplug the power cord.
2. Take out the battery gently and put it aside for about 10 minutes.
(Or you can use a metal object to connect the positive and negative pins in the battery holder to makethem short for one minute.)
3. Re-install the battery.
4. Plug the power cord and turn ON the computer.

Chapter 2 BIOS Setup

BIOS (Basic Input and Output System) includes a CMOS SETUP utility which allows user to configure required settings or to activate certain system features.

The CMOS SETUP saves the configuration in the CMOS SRAM of the motherboard.

When the power is turned off, the battery on the motherboard supplies the necessary power to the CMOS SRAM.

When the power is turned on, pushing the button during the BIOS POST (Power-On Self Test) will take you to the CMOS SETUP screen. You can enter the BIOS setup screen by pressing "Ctrl + F1".

When setting up BIOS for the first time, it is recommended that you save the current BIOS to a disk in the event that BIOS needs to be reset to its original settings. If you wish to upgrade to a new BIOS, either GIGABYTE's Q-Flash or @BIOS utility can be used.

Q-Flash allows the user to quickly and easily update or backup BIOS without entering the operating system. @BIOS is a Windows-based utility that does not require users to boot to DOS before upgrading BIOS but directly download and update BIOS from the Internet.

CONTROL KEYS

<↑><↓><←><→>	Move to select item
<Enter>	Select Item
<Esc>	Main Menu - Quit and not save changes into CMOS Status Page Setup Menu and Option Page Setup Menu - Exit current page and return to Main Menu
<Page Up>	Increase the numeric value or make changes
<Page Down>	Decrease the numeric value or make changes
<F1>	General help, only for Status Page Setup Menu and Option Page Setup Menu
<F2>	Item Help
<F5>	Restore the previous CMOS value from CMOS, only for Option Page Setup Menu
<F7>	Load the Optimized Defaults
<F8>	Dual BIOS [®] /Q-Flash utility
<F9>	System Information
<F10>	Save all the CMOS changes, only for Main Menu

Main Menu

The on-line description of the highlighted setup function is displayed at the bottom of the screen.

Status Page Setup Menu / Option Page Setup Menu

Press <F1> to pop up a small help window that describes the appropriate keys to use and the possible selections for the highlighted item. To exit the Help Window press <Esc>.



Because BIOS flashing is potentially risky, please do it with caution and avoid inadequate operation that may result in system malfunction.

① Only for GA-K8N Ultra-SLI.

② Only for GA-K8N Pro-SLI.



The BIOS Setup menus described in this chapter are for reference only and may differ from the exact settings for your motherboard.

The Main Menu (For example: BIOS Ver. : F6a)

Once you enter Award BIOS CMOS Setup Utility, the Main Menu (as figure below) will appear on the screen. Use arrow keys to select among the items and press <Enter> to accept or enter the sub-menu.

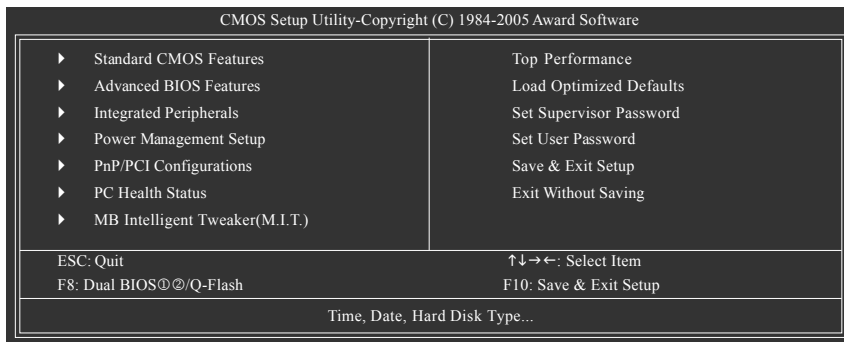

If you can't find the setting you want, please press "Ctrl+F1" to search the advanced option hidden.

■ Standard CMOS Features

This setup page includes all the items in standard compatible BIOS.

■ Advanced BIOS Features

This setup page includes all the items of Award special enhanced features.

■ Integrated Peripherals

This setup page includes all onboard peripherals.

■ Power Management Setup

This setup page includes all the items of Green function features.

■ PnP/PCI Configuration

This setup page includes all the configurations of PCI & PnP ISA resources.

■ PC Health Status

This setup page is the System auto detect Temperature, voltage, fan, speed.

■ MB Intelligent Tweaker(M.I.T.)

This setup page is control CPU clock and frequency ratio.

■ Top Performance

If you wish to maximize the performance of your system, enable **Top Performance**.

■ Load Optimized Defaults

Optimized Defaults indicates the value of the system parameters which the system would be in bestperformance configuration.

① Only for GA-K8N Ultra-SLI.

② Only for GA-K8N Pro-SLI.

- **Set Supervisor Password**

Change, set, or disable password. It allows you to limit access to the system and Setup, or just to Setup.

- **Set User Password**

Change, set, or disable password. It allows you to limit access to the system.

- **Save & Exit Setup**

Save CMOS value settings to CMOS and exit setup.

- **Exit Without Saving**

Abandon all CMOS value changes and exit setup.

» Cylinder	Number of cylinders
» Head	Number of heads
» Precomp	Write precomp
» Landing Zone	Landing zone
» Sector	Number of sectors

☞ Drive A / Drive B

The category identifies the types of floppy disk drive A or drive B that has been installed in the computer.

» None	No floppy drive installed
» 360K, 5.25"	5.25 inch PC-type standard drive; 360K byte capacity.
» 1.2M, 5.25"	5.25 inch AT-type high-density drive; 1.2M byte capacity (3.5 inch when 3 Mode is Enabled).
» 720K, 3.5"	3.5 inch double-sided drive; 720K byte capacity
» 1.44M, 3.5"	3.5 inch double-sided drive; 1.44M byte capacity. (Default value)
» 2.88M, 3.5"	3.5 inch double-sided drive; 2.88M byte capacity.

☞ Halt on

The category determines whether the computer will stop if an error is detected during power up.

» No Errors	The system boot will not stop for any error that may be detected and you will be prompted.
» All Errors	Whenever the BIOS detects a non-fatal error the system will be stopped.
» All, But Keyboard	The system boot will not stop for a keyboard error; it will stop for all other errors. (Default value)
» All, But Diskette	The system boot will not stop for a disk error; it will stop for all other errors.
» All, But Disk/Key	The system boot will not stop for a keyboard or disk error; it will stop for all other errors.

☞ Floppy 3 Mode Support (for Japan Area)

» Disabled	Normal Floppy Drive. (Default value)
» Drive A	Drive A is 3 mode Floppy Drive.
» Drive B	Drive B is 3 mode Floppy Drive.
» Both	Drive A & B are 3 mode Floppy Drives.

2-2 Advanced BIOS Features

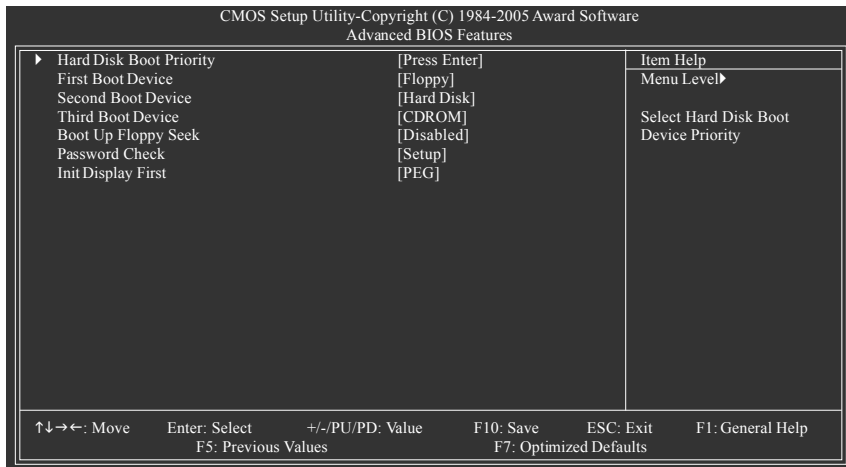

☞ Hard Disk Boot Priority

Select boot sequence for onboard(or add-on cards) SCSI, RAID, etc.

Use <↑> or <↓> to select a device, then press<+> to move it up, or <-> to move it down the list. Press <ESC> to exit this menu.

☞ First / Second / Third Boot Device

- ▶ Floppy Select your boot device priority by Floppy.
- ▶ LS120 Select your boot device priority by LS120.
- ▶ Hard Disk Select your boot device priority by Hard Disk.
- ▶ CDROM Select your boot device priority by CDROM.
- ▶ ZIP Select your boot device priority by ZIP.
- ▶ USB-FDD Select your boot device priority by USB-FDD.
- ▶ USB-ZIP Select your boot device priority by USB-ZIP.
- ▶ USB-CDROM Select your boot device priority by USB-CDROM.
- ▶ USB-HDD Select your boot device priority by USB-HDD.
- ▶ Legacy LAN Select your boot device priority by Legacy LAN.
- ▶ NVIDIA Boot Age Select your boot device priority by NVIDIA Boot Age.
- ▶ Disabled Disable this function.

☞ Boot Up Floppy Seek

During POST, BIOS will determine the floppy disk drive installed is 40 or 80 tracks. 360K type is 40 tracks 720K, 1.2M and 1.44M are all 80 tracks.

- ▶ Enabled BIOS searches for floppy disk drive to determine it is 40 or 80 tracks. Note that BIOS can not tell from 720K, 1.2M or 1.44M drive type as they are all 80 tracks.
- ▶ Disabled BIOS will not search for the type of floppy disk drive by track number. Note that there will not be any warning message if the drive installed is 360K. (Default value)

🔑 Password Check

- ▶▶ System The system can not boot and can not access to Setup page will be denied if the correct password is not entered at the prompt.
- ▶▶ Setup The system will boot, but access to Setup will be denied if the correct password is not entered at the prompt. (Default value)

🔑 Init Display First

This feature allows you to select the first initiation of the monitor display from which card when you install a PCI card and a PCI Express VGA card on the motherboard.

- ▶▶ PEG Set Init display first to PCI Express VGA card (PCIE_16_1). (Default value)
- ▶▶ PCI slot Set Init display first to PCI.
- ▶▶ PEG (Slot2) Set Init display first to PCI Express VGA card (PCIE_16_2).

2-3 Integrated Peripherals

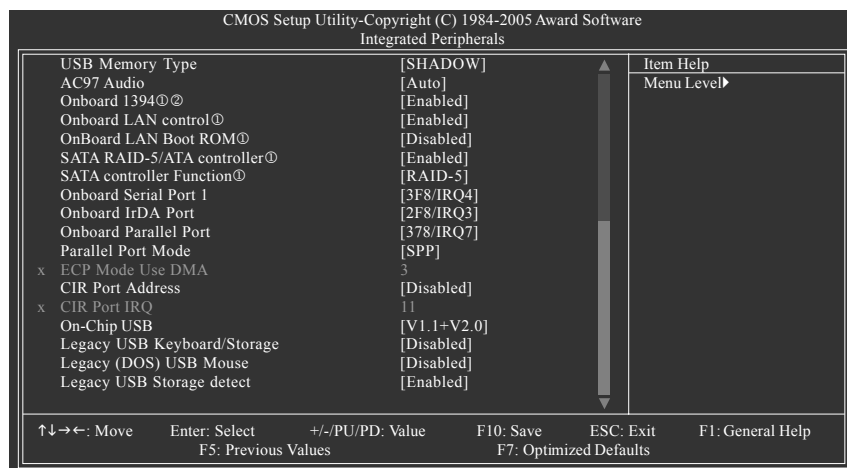
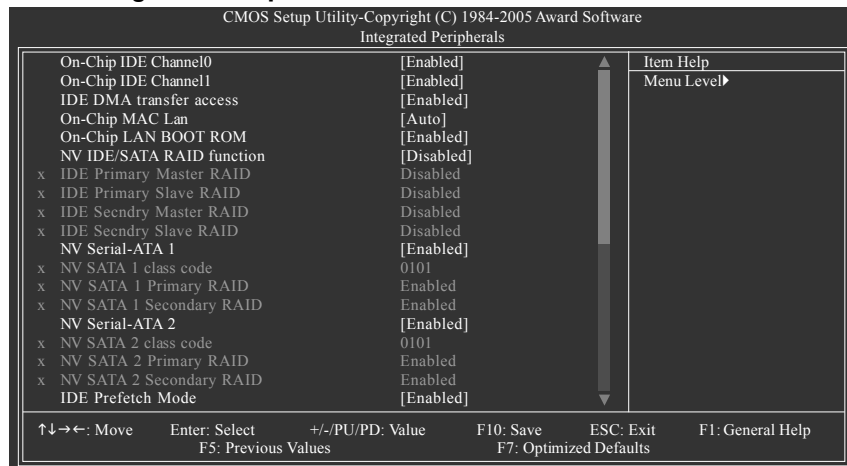

☞ On-Chip IDE Channel0

- ▶▶ Enabled Enable onboard 1st channel IDE port. (Default value)
- ▶▶ Disabled Disable onboard 1st channel IDE port.

☞ On-Chip IDE Channel1

- ▶▶ Enabled Enable onboard 2nd channel IDE port. (Default value)
- ▶▶ Disabled Disable onboard 2nd channel IDE port.

☞ IDE DMA transfer access

- ▶▶ Enabled Enable IDE DMA transfer access. (Default value)
- ▶▶ Disabled Disable this function.

① Only for GA-K8N Ultra-SLI.

② Only for GA-K8N Pro-SLI.

☞ On-Chip MAC Lan

- ▶▶ Auto Auto-detect onboard LAN chip function. (Default value)
- ▶▶ Disabled Disable onboard LAN chip function.

☞ On-Chip LAN BOOT ROM

This function decide whether to invoke the boot ROM of the onboard LAN chip.

- ▶▶ Enabled Enable this function. (Default value)
- ▶▶ Disabled Disable this function.

☞ NV IDE/SATA RAID function ^(Note)

- ▶▶ Enabled Enable NV IDE/SATA RAID function.
- ▶▶ Disabled Disable this function. (Default value)

☞ IDE Primary Master RAID

- ▶▶ Enabled Enable 1st master channel IDE RAID function.
- ▶▶ Disabled Disable this function. (Default value)

☞ IDE Primary Slave RAID

- ▶▶ Enabled Enable 1st slave channel IDE RAID function.
- ▶▶ Disabled Disable this function. (Default value)

☞ IDE Secndry Master RAID

- ▶▶ Enabled Enable 2nd master channel IDE RAID function.
- ▶▶ Disabled Disable this function. (Default value)

☞ IDE Secndry Slave RAID

- ▶▶ Enabled Enable 2nd slave channel IDE RAID function.
- ▶▶ Disabled Disable this function. (Default value)

☞ NV Serial-ATA 1

- ▶▶ Enabled Enable Serial ATA 1 supported. (Default value)
- ▶▶ Disabled Disable Serial ATA 1 supported.

☞ NV SATA 1 class code ^(Note)

- ▶▶ 0101 Set NV SATA 1 class code to 0101. (Default value)
- ▶▶ 0104 Set NV SATA 1 class code to 0104.

☞ NV SATA 1 Primary RAID

- ▶▶ Enabled Enable 1st SATA primary RAID function. (Default value)
- ▶▶ Disabled Disable this function.

☞ NV SATA 1 Secondary RAID

- ▶▶ Enabled Enable 1st SATA secondary RAID function.(Default value)
- ▶▶ Disabled Disable this function.

☞ NV Serial-ATA 2

- ▶▶ Enabled Enable Serial ATA 2 supported. (Default value)
- ▶▶ Disabled Disable Serial ATA 2 supported.

(Note) When using driver version 1.2, please enable "NV IDE/SATA RAID function" if you wish to create RAID data drive or install O.S. on the RAID drive.

And manually set "NV SATA1/NV SATA 2 class code" from 0101 to 0104.

If your SATA hard drive is connected to the SATA0 or SATA1 connector , please set "NV SATA1 class code" to 0104. If your SATA hard drive is connected to the SATA2 or SATA3 connector , please set "NV SATA2 class code" to 0104.

- ☞ **NV SATA 2 class code**^(Note)
 - ▶▶ 0101 Set NV SATA 2 class code to 0101. (Default value)
 - ▶▶ 0104 Set NV SATA 2 class code to 0104.
- ☞ **NV SATA 2 Primary RAID**
 - ▶▶ Enabled Enable 2nd SATA primary RAID function. (Default value)
 - ▶▶ Disabled Disable this function.
- ☞ **NV SATA 2 Secondary RAID**
 - ▶▶ Enabled Enable 2nd SATA secondary RAID function. (Default value)
 - ▶▶ Disabled Disable this function.
- ☞ **IDE Prefetch Mode**
 - ▶▶ Enabled Enable IDE Prefetch mode. (Default value)
 - ▶▶ Disabled Disable IDE Prefetch mode.
- ☞ **USB Memory Type**
 - ▶▶ SHADOW Set USB memory type to SHADOW. (Default value)
 - ▶▶ Base Memory(640K) Set USB memory type to base memory(640K).
- ☞ **AC97 Audio**
 - ▶▶ Auto Enable onboard AC'97 audio function. (Default value)
 - ▶▶ Disabled Disable this function.
- ☞ **Onboard 1394**^{①②}
 - ▶▶ Enabled Enable onboard IEEE1394 function.(Default value)
 - ▶▶ Disabled Disable onboard IEEE1394 function.
- ☞ **Onboard LAN control (LAN1)**^②
 - ▶▶ Enabled Enable onboard LAN chip function.(Default value)
 - ▶▶ Disabled Disable onboard LAN chip function.
- ☞ **OnBoard LAN Boot ROM**^②

This function decide whether to invoke the boot ROM of the onboard LAN chip.

 - ▶▶ Enabled Enable this function.
 - ▶▶ Disabled Disable this function. (Default value)
- ☞ **SATA RAID-5/ATA controller (Controlled by SiI3114 chip)**^②

This option is to enable or disable the SiI3114 controller.

 - ▶▶ Enabled Enable onboard Serial ATA Chip.(Default value)
 - ▶▶ Disabled Disable onboard Serial ATA Chip.
- ☞ **SATA controller Function (Controlled by SiI3114 chip)**^②
 - ▶▶ RAID-5 Set SiI3114 Serial ATA Chip to RAID mode.(Default value)
 - ▶▶ ATA Set SiI3114 Serial ATA Chip to ATA mode.

(Note) When using driver version 1.2, please enable "NV IDE/SATA RAID function" if you wish to create RAID data drive or install O.S. on the RAID drive.

And manually set "NV SATA1/NV SATA 2 class code" from 0101 to 0104.

If your SATA hard drive is connected to the SATA0 or SATA1 connector , please set "NV SATA1 class code" to 0104. If your SATA hard drive is connected to the SATA2 or SATA3 connector , please set "NV SATA2 class code" to 0104.

① Only for GA-K8N Ultra-SLI.

② Only for GA-K8N Pro-SLI.

☞ Onboard Serial Port 1

- ▶▶ Auto BIOS will automatically setup the Serial port 1 address.
- ▶▶ 3F8/IRQ4 Enable onboard Serial port 1 and address is 3F8/IRQ4. (Default value)
- ▶▶ 2F8/IRQ3 Enable onboard Serial port 1 and address is 2F8/IRQ3.
- ▶▶ 3E8/IRQ4 Enable onboard Serial port 1 and address is 3E8/IRQ4.
- ▶▶ 2E8/IRQ3 Enable onboard Serial port 1 and address is 2E8/IRQ3.
- ▶▶ Disabled Disable onboard Serial port 1.

☞ Onboard IrDA Port

- ▶▶ Auto BIOS will automatically setup the IrDA port address.
- ▶▶ 3F8/IRQ4 Enable onboard IrDA port and address is 3F8/IRQ4.
- ▶▶ 2F8/IRQ3 Enable onboard IrDA port and address is 2F8/IRQ3. (Default value)
- ▶▶ 3E8/IRQ4 Enable onboard IrDA port and address is 3E8/IRQ4.
- ▶▶ 2E8/IRQ3 Enable onboard IrDA port and address is 2E8/IRQ3.

☞ Onboard Parallel Port

- ▶▶ Disabled Disable onboard LPT port.
- ▶▶ 378/IRQ7 Enable onboard LPT port and address is 378/IRQ7. (Default value)
- ▶▶ 278/IRQ5 Enable onboard LPT port and address is 278/IRQ5.
- ▶▶ 3BC/IRQ7 Enable onboard LPT port and address is 3BC/IRQ7.

☞ Parallel Port Mode

- ▶▶ SPP Using Parallel port as Standard Parallel Port. (Default value)
- ▶▶ EPP Using Parallel port as Enhanced Parallel Port.
- ▶▶ ECP Using Parallel port as Extended Capabilities Port.
- ▶▶ ECP+EPP Using Parallel port as ECP and EPP mode.

☞ ECP Mode Use DMA

- ▶▶ 3 Set ECP Mode Use DMA to 3. (Default value)
- ▶▶ 1 Set ECP Mode Use DMA to 1.

☞ CIR Port Address

- ▶▶ 310 Set CIR Port Address to 310.
- ▶▶ 320 Set CIR Port Address to 320.
- ▶▶ Disabled Disable this function. (Default value)

☞ CIR Port IRQ

- ▶▶ 5 Set CIR Port IRQ to 5.
- ▶▶ 11 Set CIR Port IRQ to 11. (Default value)

☞ On-Chip USB

- ▶▶ Disabled Disable this function if you are not using onboard USB function.
- ▶▶ V1.1+V2.0 Enable USB 1.1 and USB 2.0 controller. (Default value)
- ▶▶ V1.1 Enable only USB 1.1 controller.

☞ Legacy USB Keyboard/Storage

- ▶▶ Enabled Enable USB keyboard support in the MS-DOS environment.
- ▶▶ Disabled Disable this function. (Default value)

☞ Legacy (DOS) USB Mouse

- ▶▶ Enabled Enable USB mouse support in the MS-DOS environment.
- ▶▶ Disabled Disable this function. (Default value)

☞ Legacy USB Storage detect

- ▶▶ Enabled Enable USB storage detection in the MS-DOS environment. (Default value)
- ▶▶ Disabled Disable this function.

2-4 Power Management Setup

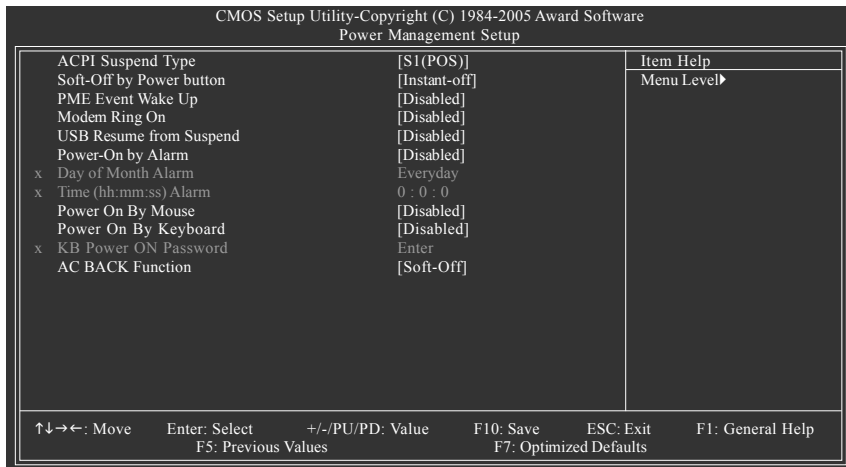

☞ ACPI Suspend Type

- ▶▶ S1(POS) Set ACPI suspend type to S1/POS(Power On Suspend). (Default value)
- ▶▶ S3(STR) Set ACPI suspend type to S3/STR(Suspend To RAM).

☞ Soft-Off by Power button

- ▶▶ Instant-off Press power button then Power off instantly. (Default value)
- ▶▶ Delay 4 Sec Press power button 4 seconds to Power off. Enter suspend if button is pressed less than 4 seconds.

☞ PME Event Wake Up

This feature requires an ATX power supply that provides at least 1A on the 5VSB lead.

- ▶▶ Disabled Disable this function. (Default value)
- ▶▶ Enabled Enable PME as wake up event.

☞ Modem Ring On

An incoming call via modem can awake the system from any suspend state.

- ▶▶ Disabled Disable Modem Ring on function. (Default value)
- ▶▶ Enabled Enable Modem Ring on function.

☞ USB Resume from Suspend

- ▶▶ Disabled Disable this function. (Default value)
- ▶▶ Enabled Enable USB device wake up system from suspend type.

☞ Power-On by Alarm

You can set "Resume by Alarm" item to enabled and key in Date/Time to power on system.

- ▶▶ Disabled Disable this function. (Default value)
- ▶▶ Enabled Enable alarm function to POWER ON system.

If Power-On by Alarm is Enabled.

- ▶▶ Day of Month Alarm : Everyday, 1~31
- ▶▶ Time (hh: mm: ss) Alarm : (0~23) : (0~59) : (0~59)

☞ Power On By Mouse

- ▶▶ Disabled Disable this function. (Default value)
- ▶▶ Double Click Double click on PS/2 mouse left button to power on the system.

☞ Power On By Keyboard

- ▶▶ Disabled Disable this function. (Default value)
- ▶▶ Password Enter from 1 to 5 characters to set the Keyboard Power On Password.
- ▶▶ Any KEY Press any key to power on the system.
- ▶▶ Keyboard 98 If your keyboard have "POWER Key" button, you can press the key to power on the system.

☞ KB Power ON Password

When "Power On by Keyboard" set at Password, you can set the password here.

- ▶▶ Enter Input password (from 1 to 5 characters) and press Enter to set the Keyboard Power On password.

☞ AC BACK Function

- ▶▶ Soft-Off When AC-power back to the system, the system will be in "Off" state. (Default value)
- ▶▶ Full-On When AC-power back to the system, the system always in "On" state.

2-5 PnP/PCI Configurations

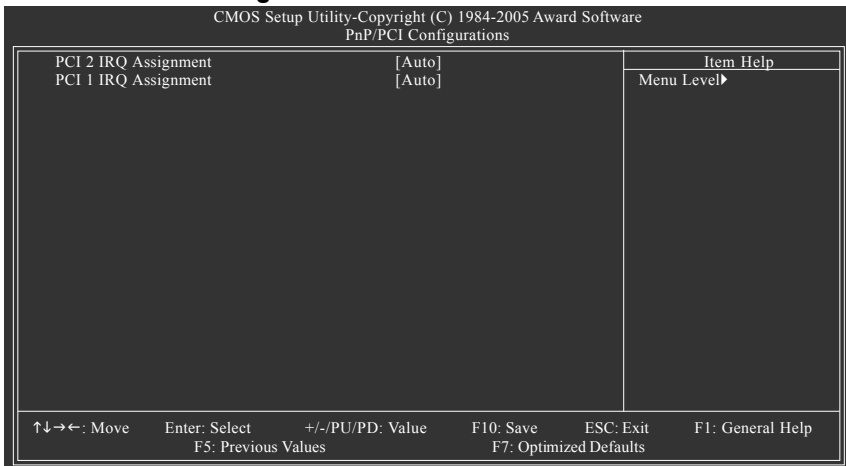

☞ PCI 2 IRQ Assignment

- ▶▶ Auto Auto assign IRQ to PCI 2. (Default value)
- ▶▶ 3,4,5,7,9,10,11,12,14,15 Set IRQ 3,4,5,7,9,10,11,12,14,15 to PCI 2.

☞ PCI 1 IRQ Assignment

- ▶▶ Auto Auto assign IRQ to PCI 1. (Default value)
- ▶▶ 3,4,5,7,9,10,11,12,14,15 Set IRQ 3,4,5,7,9,10,11,12,14,15 to PCI 1.

2-6 PC Health Status

CMOS Setup Utility-Copyright (C) 1984-2005 Award Software
PC Health Status

Vcore	OK		Item Help
DDR25V	OK		Menu Level▶
+3.3V	OK		
+12V	OK		
Current CPU Temperature	34°C		
Current CPU FAN Speed	3183 RPM		
Current POWER FAN Speed	0 RPM		
Current SYSTEM FAN Speed	0 RPM		
CPU Warning Temperature	[Disabled]		
CPU FAN Fail Warning	[Disabled]		
CPU Smart FAN Control	[Disabled]		
CPU FAN Manual Control	[Disabled]		
x CPU FAN: Low speed	8		
x CPU FAN: Mid speed	12		
x CPU FAN: High speed	80		
x Temp of FAN turn off	0		
x Temp Limit of Low Speed	20		
x Temp Limit of Mid Speed	50		

↑↓→←: Move Enter: Select +/-/PU/PD: Value F10: Save ESC: Exit F1: General Help
F5: Previous Values F7: Optimized Defaults

CMOS Setup Utility-Copyright (C) 1984-2005 Award Software
PC Health Status

x Temp Limit of High Speed	60		Item Help
x Temp of full FAN speed	70		Menu Level▶

↑↓→←: Move Enter: Select +/-/PU/PD: Value F10: Save ESC: Exit F1: General Help
F5: Previous Values F7: Optimized Defaults



NOTE The CPU fan runs at full speed when both **CPU Smart FAN Control** and **CPU FAN Manual Control** are disabled.

- ☞ **Current Voltage(V) Vcore / DDR25V / +3.3V / +12V**
 - ▶▶ Detect system's voltage status automatically.
- ☞ **Current CPU Temperature**
 - ▶▶ Detect CPU temperature automatically.
- ☞ **Current CPU/POWER/SYSTEM FAN Speed (RPM)**
 - ▶▶ Detect CPU/Power/System fan speed status automatically.
- ☞ **CPU Warning Temperature**
 - ▶▶ 60°C / 140°F Monitor CPU temperature at 60°C / 140°F.
 - ▶▶ 70°C / 158°F Monitor CPU temperature at 70°C / 158°F.
 - ▶▶ 80°C / 176°F Monitor CPU temperature at 80°C / 176°F.
 - ▶▶ 90°C / 194°F Monitor CPU temperature at 90°C / 194°F.
 - ▶▶ Disabled Disable this function. (Default value)
- ☞ **CPU FAN Fail Warning**
 - ▶▶ Disabled Disable CPU fan fail warning function. (Default value)
 - ▶▶ Enabled Enable CPU fan fail warning function.
- ☞ **CPU Smart FAN Control** ^(Note)
 - ▶▶ Disabled Disable this function. (Default Value)
 - ▶▶ Enabled When this function is enabled, CPU fan will run at different speed depending on CPU temperature. Users can adjust the fan speed with Easy Tune based on their requirements.
- ☞ **CPU FAN Manual Control**

CPU Smart Fan Control will become disabled when this item is enabled.

 - ▶▶ Enabled Enable the CPU fan manual control function.
 - ▶▶ Disabled Disable the CPU fan manual control function. (Default value)
- ☞ **CPU FAN: Low Speed**
 - ▶▶ Set the parameter of the CPU fan speed.

The CPU FAN: Low Speed option configures the speed of the CPU fan when the CPU temperature is below the temperature set in Temp Limit of Mid Speed. The parameter can be adjusted from 0~127. Higher parameter means faster CPU fan speed. (Default parameter: 8)
- ☞ **CPU FAN: Mid Speed**
 - ▶▶ Set the parameter of the CPU fan speed.

The CPU FAN: Mid Speed option configures the speed of the CPU fan when the CPU temperature exceeds the temperature set in Temp Limit of Mid Speed. The parameter can be adjusted from 0~127. Higher parameter means faster CPU fan speed. (Default parameter: 12)
- ☞ **CPU FAN: High Speed**
 - ▶▶ Set the parameter of the CPU fan speed.

The CPU FAN: High Speed option configures the speed of the CPU fan when the CPU temperature exceeds the temperature set in Temp Limit of High Speed. The parameter can be adjusted from 0~127. Higher parameter means faster CPU fan speed. (Default parameter: 80)



The CPU fan runs at full speed when both **CPU Smart FAN Control** and **CPU FAN Manual Control** are disabled.

(Note) Whether the CPU Smart FAN Control function is supported will depend on the CPU you install. For more detailed information please check at the FAQ section on GIGABYTE's website.

- ☞ **Temp of FAN turn off (Default temperature: 0°C)**
 - » When the CPU temperature is below the value set in this option, the CPU fan will stop spinning.
- ☞ **Temp Limit of Low Speed (Default temperature: 20°C)**
 - » The CPU fan will stop spinning when the CPU temperature is below the value set in Temp of FAN turn off option. The CPU fan will start to spin again with the parameter set in CPU FAN: Low Speed when the CPU temperature exceeds the value set in Temp Limit of Low Speed.
- ☞ **Temp Limit of Mid Speed (Default temperature: 50°C)**
 - » When the CPU temperature exceeds the value set in this option, the CPU fan spins with the parameter specified in CPU FAN: Mid Speed. For example, by default, when the CPU temperature exceeds 50°C, CPU fan runs with parameter 12.
- ☞ **Temp Limit of High Speed (Default temperature: 60°C)**
 - » When the CPU temperature exceeds the value set in this option, the CPU fan rotates with the parameter specified in CPU FAN: High Speed. For example, by default, when the CPU temperature exceeds 60°C, CPU fan runs with parameter 80.
- ☞ **Temp of full FAN Speed (Default temperature: 70°C)**
 - » When the CPU temperature exceeds the value set in this option, the CPU fan runs at full speed.

2-7 MB Intelligent Tweaker(M.I.T.)

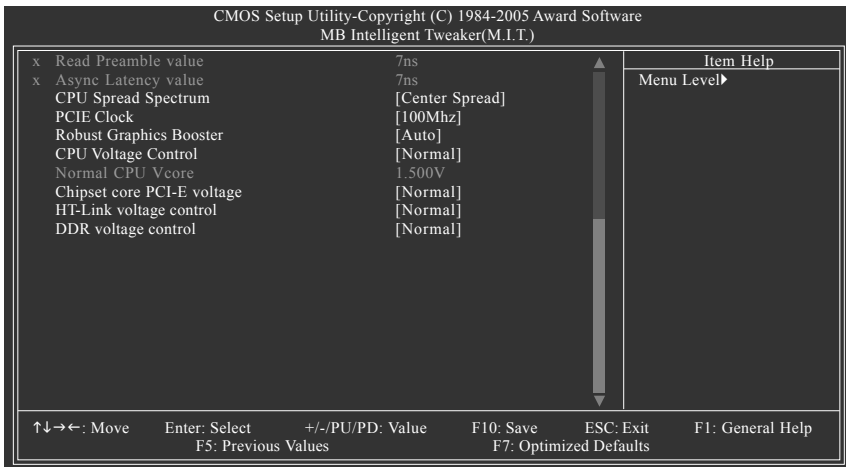
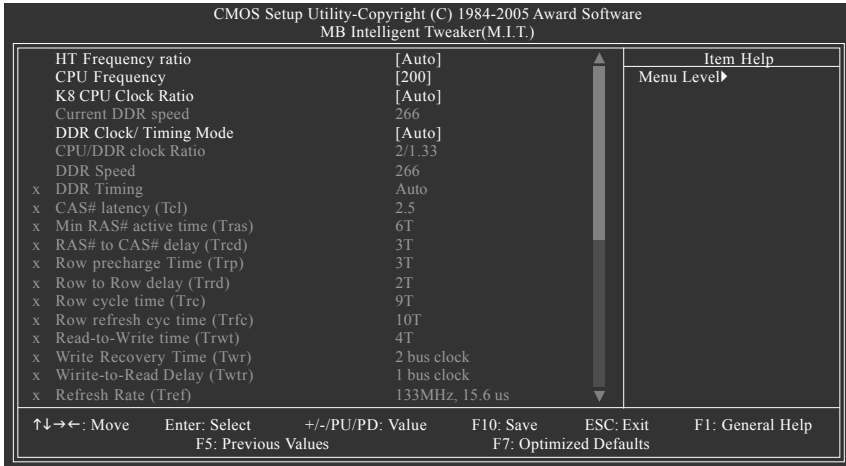

CAUTION

Incorrect using these features may cause your system broken. For power end-user use only.

HT Frequency ratio

Set HT Frequency ratio to 1x, 1.5x, 2x, 2.5x, 3x, 4x, or 5x. (Default: Auto)

CPU Frequency

▶▶ 200 ~ 456 Set CPU frequency from 200Mhz to 456Mhz.

K8 CPU Clock Ratio

This setup option will automatically assign by CPU detection. The option will display "Locked" and read only or will not show up if the CPU ratio is not changeable.

- ☞ **Refresh Rate (Tref)**
 - ▶▶ Set the Refresh Rate.
- ☞ **Read Preamble value**
 - ▶▶ 2~9.5ns Set the Read Preamble value. (Default value: 7ns)
- ☞ **Async Latency value**
 - ▶▶ 2~9ns Set the Async Latency value (Default value: 7ns)
- ☞ **CPU Spread Spectrum**
 - ▶▶ Disabled Disable CPU Spread Spectrum.
 - ▶▶ Center Spread Set CPU Spread Spectrum to Center Spread. (Default value)
- ☞ **PCIE Clock**
 - ▶▶ 100Mhz ~ 150Mhz Set PCI-E clock from 100Mhz to 150Mhz.
- ☞ **Robust Graphics Booster**

Select the options can enhance the VGA graphics card bandwidth to get higher performance.

 - ▶▶ Auto Set Robust Graphics Booster to Auto. (Default value)
 - ▶▶ Fast Set Robust Graphics Booster to Fast.
 - ▶▶ Turbo Set Robust Graphics Booster to Turbo.
- ☞ **CPU Voltage Control**
 - ▶▶ Supports adjustable CPU Vcore from 0.800V to 1.750V. (Default value: Normal)
- ☞ **Normal CPU Vcore**
 - ▶▶ Display your CPU Vcore voltage.
- ☞ **Chipset core PCI-E voltage**
 - ▶▶ Normal Set Chipset core PCI-E voltage as Chipset core PCI-E required. (Default value)
 - ▶▶ +0.1v Increase Chipset core PCI-E voltage +0.1V.
 - ▶▶ +0.2v Increase Chipset core PCI-E voltage +0.2V.
 - ▶▶ +0.3v Increase Chipset core PCI-E voltage +0.3V.
- ☞ **HT-Link voltage control**
 - ▶▶ Normal Supply HT-Link voltage as HT-Link required. (Default value)
 - ▶▶ +0.1v Increase HT-Link voltage +0.1V.
 - ▶▶ +0.2v Increase HT-Link voltage +0.2V.
 - ▶▶ +0.3v Increase HT-Link voltage +0.2V.
- ☞ **DDR voltage control**
 - ▶▶ Normal Supply DDR voltage as DDR required. (Default value)
 - ▶▶ +0.1v Increase DDR voltage +0.1V.
 - ▶▶ +0.2v Increase DDR voltage +0.2V.

2-8 Top Performance

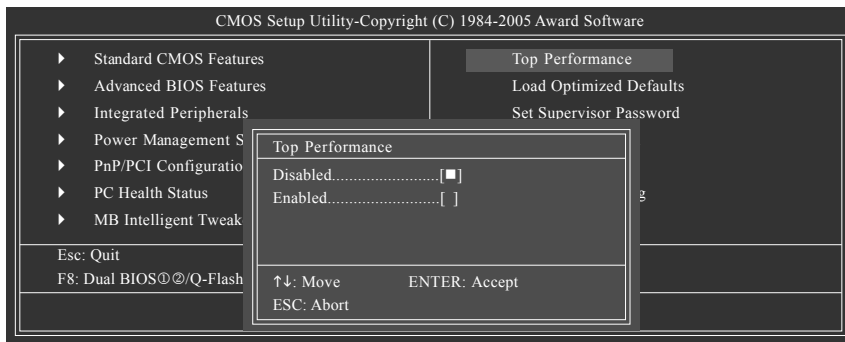

If you wish to maximize the performance of your system, enable "Top Performance."

- ▶▶ Disabled Disable this function. (Default Value)
- ▶▶ Enabled Enable Top Performance function.

❗* "Top Performance" will increase H/W working speed. Different system configuration (both H/W component and OS) will effect the result. For example, the same H/W configuration might not run properly with Windows XP, but works smoothly with Windows NT. Therefore, if your system is not perform enough, the reliability or stability problem will appear sometimes, and we will recommend you disabling the option to avoid the problem as mentioned above.

2-9 Load Optimized Defaults

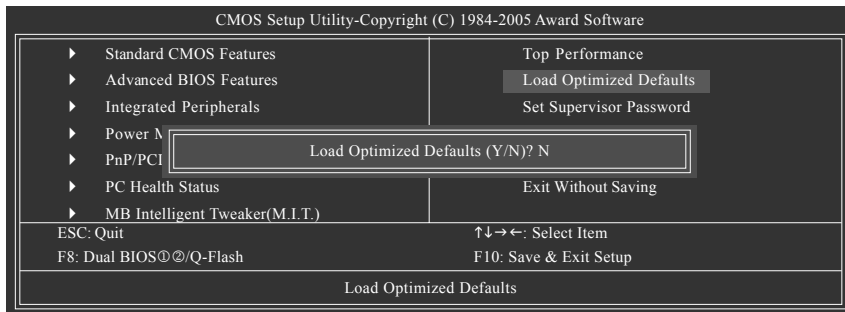

Selecting this field loads the factory defaults for BIOS and Chipset Features which the system automatically detects.

① Only for GA-K8N Ultra-SLI. ② Only for GA-K8N Pro-SLI.

2-10 Set Supervisor/User Password

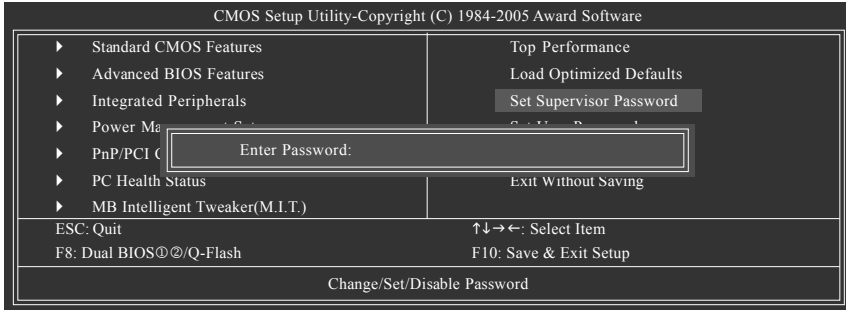

When you select this function, the following message will appear at the center of the screen to assist you in creating a password.

Type the password, up to eight characters, and press <Enter>. You will be asked to confirm the password. Type the password again and press <Enter>. You may also press <Esc> to abort the selection and not enter a password.

To disable password, just press <Enter> when you are prompted to enter password. A message "PASSWORD DISABLED" will appear to confirm the password being disabled. Once the password is disabled, the system will boot and you can enter Setup freely.

The BIOS Setup program allows you to specify two separate passwords:

SUPERVISOR PASSWORD and a USER PASSWORD. When disabled, anyone may access all BIOS Setup program function. When enabled, the Supervisor password is required for entering the BIOS Setup program and having full configuration fields, the User password is required to access only basic items.

If you select "System" at "Password Check" in Advance BIOS Features Menu, you will be prompted for the password every time the system is rebooted or any time you try to enter Setup Menu.

If you select "Setup" at "Password Check" in Advance BIOS Features Menu, you will be prompted only when you try to enter Setup.

① Only for GA-K8N Ultra-SLI.

② Only for GA-K8N Pro-SLI.

2-11 Save & Exit Setup

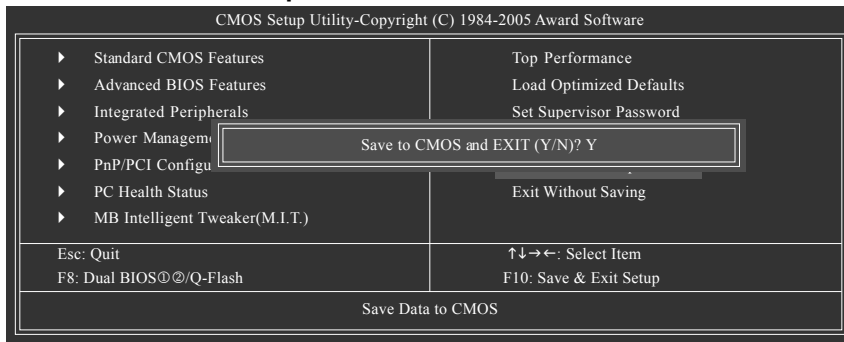

Type "Y" will quit the Setup Utility and save the user setup value to RTC CMOS.
Type "N" will return to Setup Utility.

2-12 Exit Without Saving

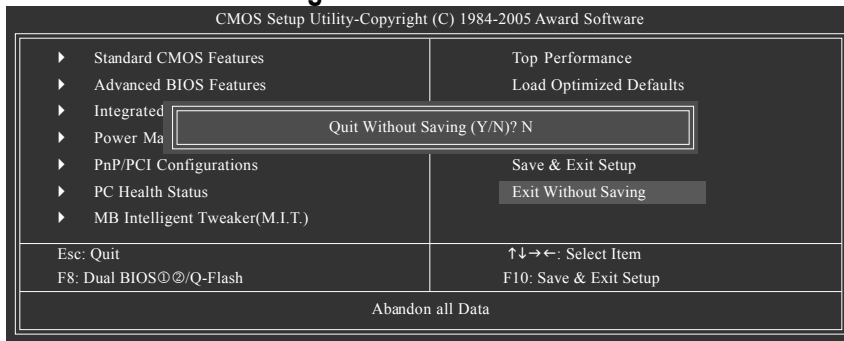

Type "Y" will quit the Setup Utility without saving to RTC CMOS.
Type "N" will return to Setup Utility.

① Only for GA-K8N Ultra-SLI.

② Only for GA-K8N Pro-SLI.

Chapter 3 Drivers Installation



Pictures below are shown in Windows XP.

Insert the driver CD-title that came with your motherboard into your CD-ROM drive, the driver CD-title will auto start and show the installation guide. If not, please double click the CD-ROM device icon in "My computer", and execute the Setup.exe.

3-1 Install Chipset Drivers

After insert the driver CD, "Xpress Install" will scan automatically the system and then list all the drivers that recommended to install. The "Xpress Install" uses the "Click and Go" technology to install the drivers automatically. Just select the drivers you want then click the "GO" button. The "Xpress Install" will execute the installation for you automatically.

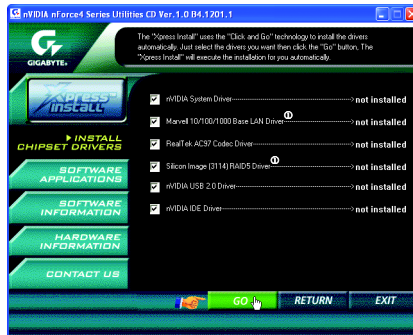

Some device drivers will restart your system automatically. After restarting your system the "Xpress Install" will continue to install other drivers.

System will reboot automatically after install the drivers, afterward you can install others application.



For USB2.0 driver support under Windows XP operating system, please use Windows Service Pack. After install Windows Service Pack, it will show a question mark "?" in "Universal Serial Bus controller" under "Device Manager". Please remove the question mark and restart the system (System will auto-detect the right USB2.0 driver).

① Only for GA-K8N Ultra-SLI.

3-4 Hardware Information

This page lists all device you have for this motherboard.

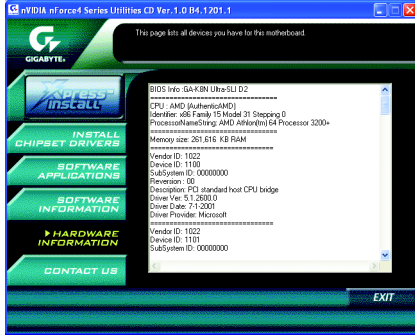

3-5 Contact Us

Please see the last page for details.



Chapter 4 Appendix

4-1 Unique Software Utilities

4-1-1 EasyTune 5 Introduction

EasyTune 5 presents the most convenient Windows based system performance enhancement and manageability utility. Featuring several powerful yet easy to use tools such as 1) Overclocking for enhancing system performance, 2) C.I.A. and M.I.B. for special enhancement for CPU and Memory, 3) Smart-Fan control for managing fan speed control of both CPU cooling fan and North-Bridge Chipset cooling fan, 4) PC health for monitoring system status.^(Note)

User Interface Overview



	Button / Display	Description
1.	Overclocking	Enters the Overclocking setting page
2.	C.I.A./C.I.A.2 and M.I.B./M.I.B.2	Enters the C.I.A./2 and M.I.B./2 setting page
3.	Smart-Fan	Enters the Smart-Fan setting page
4.	PC Health	Enters the PC Health setting page
5.	GO	Confirmation and Execution button
6.	"Easy Mode" & "Advance Mode"	Toggles between Easy and Advance Mode
7.	Display screen	Display panel of CPU frequency
8.	Function display LEDs	Shows the current functions status
9.	GIGABYTE Logo	Log on to GIGABYTE website
10.	Help button	Display EasyTune™ 5 Help file
11.	Exit or Minimize button	Quit or Minimize EasyTune™ 5 software

(Note) EasyTune 5 functions may vary depending on different motherboards.

4-1-2 Xpress Recovery2 Introduction



Xpress Recovery2 is designed to provide quick backup and restoration of hard disk data. Supporting Microsoft operating systems including Windows XP/2000/NT/98/Me and DOS, and file systems including FAT16, FAT32, and NTFS, Xpress Recovery2 is able to back up data on hard disks on PATA and SATA IDE controllers. After Xpress Recovery2 is executed from CD-ROM for the first time, it will stay permanent in your hard disk. If you wish to run Xpress Recovery2 later, you can simply press F9 during system bootup to enter Xpress Recovery2 without the CD-ROM.

System requirements:

1. Intel x86 platforms
2. At least 64M bytes of system memory
3. VESA-supported VGA cards

How to use the Xpress Recovery2

Initial access by booting from CD-ROM and subsequent access by pressing the F9 key:

Steps: After entering BIOS Setup, go to **Advanced BIOS Feature** and set to boot from CD-ROM. Save the settings and exit the BIOS Setup. Insert the provided driver CD into your CD-ROM drive. Upon system restart, the message which says "Boot from CD/DVD:" will appear in the bottom left corner of the screen. Press any key to enter Xpress Recovery2.

After the steps above are completed, subsequent access to Xpress Recovery2 can be made by simply pressing the <F9> key during system power-on.



Boot from CD/DVD:

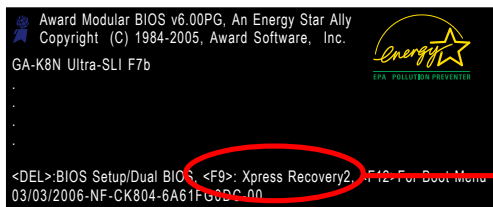

<F9> Xpress Recovery2



1. If you have already entered Xpress Recovery2 by booting from the CD-ROM, you can enter Xpress Recovery2 by pressing the <F9> key in the future.
2. System storage capacity and the reading/writing speed of the hard disk will affect the data backup speed.
3. It is recommended that Xpress Recovery2 be immediately installed once you complete installations of OS and all required drivers as well as software.

The Main Screen of Xpress Recovery2



1. RESTORE:

Restore the backed-up data to your hard disk.
(This button will not appear if there is no backup file.)

2. BACKUP:

Back up data from hard disk.

3. REMOVE:

Remove previously-created backup files to release disk space.
(This button will not appear if there is no backup file.)

4. REBOOT:

Exit the main screen and restart the system.

Limitations:

1. Not compatible to Xpress Recovery.
2. For the use of Xpress Recovery2, a primary partition must be reserved.
3. Xpress Recovery2 will store the backup file at the end of the hard disk, so free space available on the hard disk for the backup file must be allocated in advance. (A minimum 4GB is recommended but the actual space is dependent on the size of the data to be backed up)
4. Capable of backing up hard disks installed with Windows operating systems including DOS and Windows XP/2000/NT/9x/Me.
5. USB hard disks are currently not supported.
6. Does not support RAID/AHCI (class code 0104/0106) hard disks.
7. Capable of backing up and restoring only the first physical hard disk.

Hard disks detection sequence is as follows:

- a. PATA IDE primary channel
- b. PATA IDE secondary channel
- c. SATA IDE channel 1
- d. SATA IDE channel 2
- e. SATA IDE channel 3
- f. SATA IDE channel 4

Precautions:

1. When using hard disks with more than 128G under Windows 2000, be sure to execute the EnableBigLba.exe program from the driver CD before data backup.
2. It is normal that data backup takes longer time than data restoration.
3. Xpress Recovery2 is compliant with the GPL regulations.
4. On a few motherboards based on Nvidia chipsets, BIOS update is required for Xpress Recovery2 to correctly identify RAID and SATA IDE mode. Please contact your motherboard manufacturer.
5. Xpress Recovery2 supports only PATA hard disks and not SATA hard disks on the following motherboards (As this is a BIOS-related issue, it can be solved by BIOS update)

GA-K8U	GA-K8NXP-9	GA-8N-SLI Royal
GA-K8U-9	GA-K8N Ultra-9	GA-8N-SLI Pro
GA-K8NXP-SLI	GA-K8NF-9 (PCB Ver. 1.0)	GA-8N-SLI
GA-K8N Ultra-SLI	GA-K8NE (PCB Ver. 1.0)	
GA-K8N Pro-SLI	GA-K8NMF-9	

4-1-3 Flash BIOS Method Introduction



A. What is Dual BIOS Technology? ①②

Dual BIOS means that there are two system BIOS (ROM) on the motherboard, one is the Main BIOS and the other is Backup BIOS.

Under the normal circumstances, the system works on the Main BIOS. If the Main BIOS is corrupted or damaged, the Backup BIOS can take over while the system is powered on. This means that your PC will still be able to run stably as if nothing has happened in your BIOS.

B. How to use Dual BIOS and Q-Flash Utility?

a. After power on the computer, pressing immediately during POST (Power On Self Test) it will allow you to enter Award BIOS CMOS SETUP, then press <F8> to enter Flash utility.

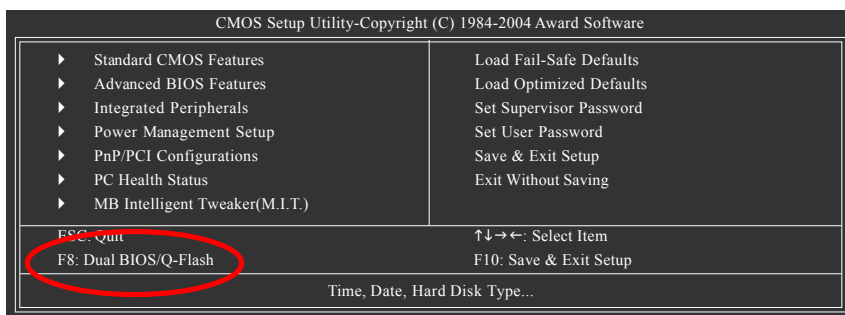

b. Dual BIOS / Q-Flash Programming Utility

Dual BIOS Utility V1.33			
Boot From.....	Main Bios		
Main ROM Type/Size.....	SST 49LF004A	512K	
Backup ROM Type/Size.....	SST 49LF004A	512K	
Wide Range Protection	Disable		
Boot From	Main Bios		
Auto Recovery	Enable		
Halt On Error	Disable		
Keep DMI Data	Enable		
Copy Main ROM Data to Backup			
Load Default Settings			
Save Settings to CMOS			
Q-Flash Utility			
Update Main BIOS from Floppy			
Update Backup BIOS from Floppy			
Save Main BIOS to Floppy			
Save Backup BIOS to Floppy			
PgDn/PgUp: Modify	↑↓: Move	ESC: Reset	F10: Power Off

① Only for GA-K8N Ultra-SLI.

② Only for GA-K8N Pro-SLI.

c. Dual BIOS Item explanation:

Wide Range Protection: Disable(Default), Enable

Status 1:

If any failure (ex. Update ESCD failure, checksum error or reset? occurs in the Main BIOS, just before the Operating System is loaded and after the power is on, and that the Wide Range Protection is set to "Enable", the PC will boot from Backup BIOS automatically.

Status 2:

If the ROM BIOS on peripherals cards(ex. SCSI Cards, LAN Cards,..) emits signals to request restart of the system after the user make any alteration on it, the boot up BIOS will not be changed to the Backup BIOS.

Boot From : Main BIOS(Default), Backup BIOS

Status 1:

The user can set to boot from main BIOS or Backup BIOS.

Status 2:

If one of the main BIOS or the Backup BIOS fails, this item "Boot From : Main BIOS(Default)" will become gray and will not be changed by user.

Auto Recovery : Enable(Default), Disable

When one of the Main BIOS or Backup BIOS occurs checksum failure, the working BIOS will automatically recover the BIOS of checksum failure.

(In the Power Management Setup of the BIOS Setting, if ACPI Suspend Type is set to Suspend to RAM, the Auto Recovery will be set to Enable automatically.)

(If you want to enter the BIOS setting, please press "Del" key when the boot screen appears.)

Halt On Error : Disable(Default), Enable

If the BIOS occurs a checksum error or the Main BIOS occurs a WIDE RANGE PROTECTION error and Halt On Error set to Enable, the PC will show messages on the boot screen, and the system will pause and wait for the user's instruction.

If Auto Recovery :Disable, it will show <or the other key to continue.>

If Auto Recovery :Enable, it will show <or the other key to Auto Recover.>

Keep DMI Data : Enable(Default), Disable

Enable: The DMI data won't be replaced by flashing new BIOS.(recommend)

Disable: The DMI data will be replaced by flashing new BIOS.

Copy Main ROM Data to Backup

(If you boot from Backup ROM, this item will change to Copy Backup ROM Data to Main)

Auto recovery message:

BIOS Recovery: Main to Backup

The means that the Main BIOS works normally and could automatically recover the Backup BIOS.

BIOS Recovery: Backup to Main

The means that the Backup BIOS works normally and could automatically recover the Main BIOS.

(This auto recovery utility is set by system automatically and can't be changed by user.)

Load Default Settings

Load dual BIOS default value.

Save Settings to CMOS

Save revised setting.



Method 1 : Q-Flash™ Utility

Q-Flash™ is a BIOS flash utility embedded in Flash ROM. With this utility, users only have to stay in the BIOS menu when they want to update BIOS. Q-Flash™ allows users to flash BIOS without any utility in DOS or

Windows. Using Q-Flash™ indicating no more fooling around with any complicated instructions and operating system since it is in the BIOS menu.



Please note that because updating BIOS has potential risk, please do it with caution!! We are sorry that Gigabyte Technology Co., Ltd is not responsible for damages of system because of incorrect manipulation of updating BIOS to avoid any claims from end-users.

Before You Begin:

Before you start updating BIOS with the Q-Flash™ utility, please follow the steps below first.

1. Download the latest BIOS for your motherboard from Gigabyte's website.
2. Extract the BIOS file downloaded and save the BIOS file (the one with model name.Fxx. For example, 8KNXP.UFba) to a floppy disk.
3. Reboot your PC and press **Del** to enter BIOS menu.

The BIOS upgrading guides below are separated into two parts.

If your motherboard has dual-BIOS, please refer to **Part One**.

If your motherboard has single-BIOS, please refer to **Part Two**.

Part One:

Updating BIOS with Q-Flash™ Utility on Dual BIOS Motherboards.

Some of Gigabyte motherboards are equipped with dual BIOS. In the BIOS menu of the motherboards supporting Q-Flash and Dual BIOS, the Q-Flash utility and Dual BIOS utility are combined in the same screen. This section only deals with how to use Q-Flash utility.

In the following sections, we take GA-8KNXP Ultra as the example to guide you how to flash BIOS from an older version to the latest version. For example, from Fa3 to Fba.

The BIOS file is Fa3
before updating

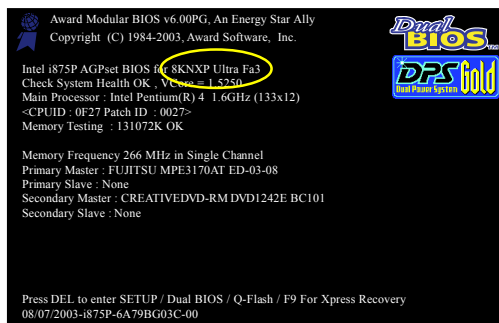

Entering the Q-Flash™ utility:

Step 1: To use Q-Flash utility, you must press **Del** in the boot screen to enter BIOS menu.

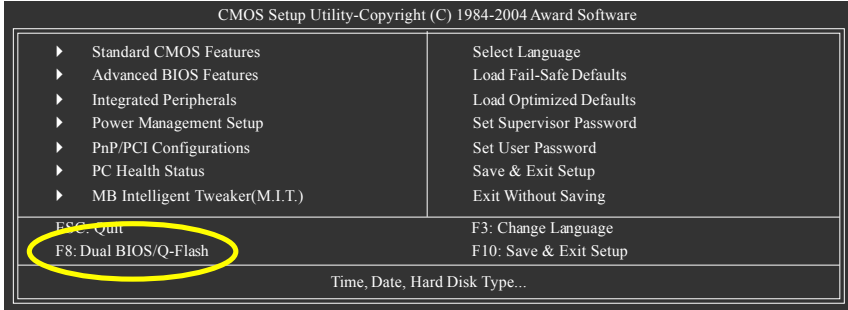

Step 2: Press **F8** button on your keyboard and then **Y** button to enter the Dual BIOS/Q-Flash utility.

Exploring the Q-Flash™ / Dual BIOS utility screen

The Q-Flash / Dual BIOS utility screen consists of the following key components.

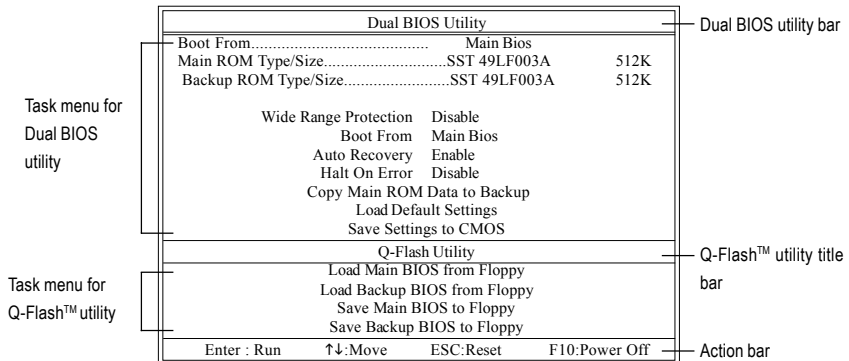

Task menu for Dual BIOS utility:

Contains the names of eight tasks and two item showing information about the BIOS ROM type. Blocking a task and pressing Enter key on your keyboard to enable execution of the task.

Task menu for Q-Flash utility:

Contains the names of four tasks. Blocking a task and pressing Enter key on your keyboard to enable execution of the task.

Action bar:

Contains the names of four actions needed to operate the Q-Flash/Dual BIOS utility. Pressing the buttons mentioned on your keyboards to perform these actions.

- Press Y button on your keyboard after you are sure to update BIOS.
Then it will begin to update BIOS. The progress of updating BIOS will be displayed.



Please do not take out the floppy disk when it begins flashing BIOS.

- Press any keys to return to the Q-Flash menu when the BIOS updating procedure is completed.

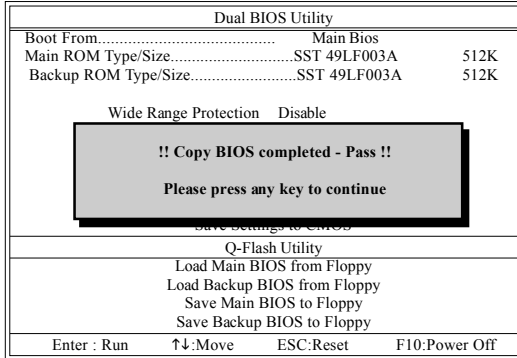

You can repeat Step 1 to 4 to flash the backup BIOS, too.

- Press Esc and then Y button to exit the Q-Flash utility. The computer will restart automatically after you exit Q-Flash.

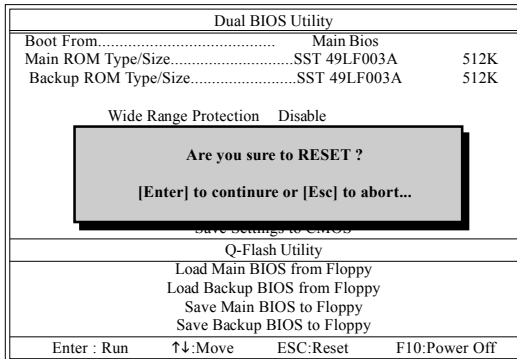

After system reboots, you may find the BIOS version on your boot screen becomes the one you flashed.

The BIOS file becomes Fba after updating.

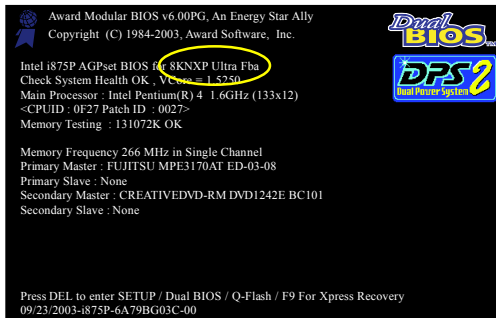

6. Press **Del** to enter BIOS menu after system reboots. When you are in BIOS menu, move to **Load Fail-Safe Defaults** item and press **Enter** to load BIOS Fail-Safe Defaults. Normally the system redetects all devices after BIOS has been upgraded. Therefore, we highly recommend reloading the BIOS defaults after BIOS has been upgraded.

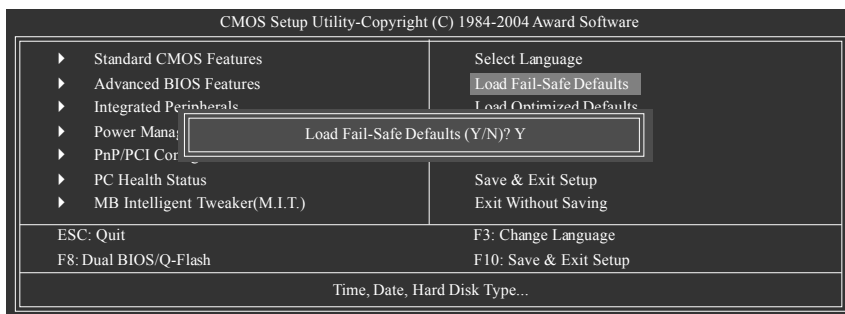

Press **Y** on your keyboard to load defaults.

7. Select **Save & Exit Setup** item to save the settings to CMOS and exit the BIOS menu. System will reboot after you exit the BIOS menu. The procedure is completed.

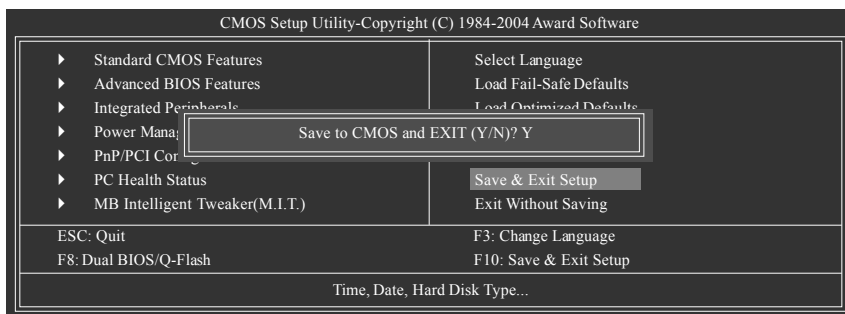

Press **Y** on your keyboard to save and exit.

Part Two:

Updating BIOS with Q-Flash™ Utility on Single-BIOS Motherboards.

This part guides users of single-BIOS motherboards how to update BIOS using the Q-Flash™ utility.

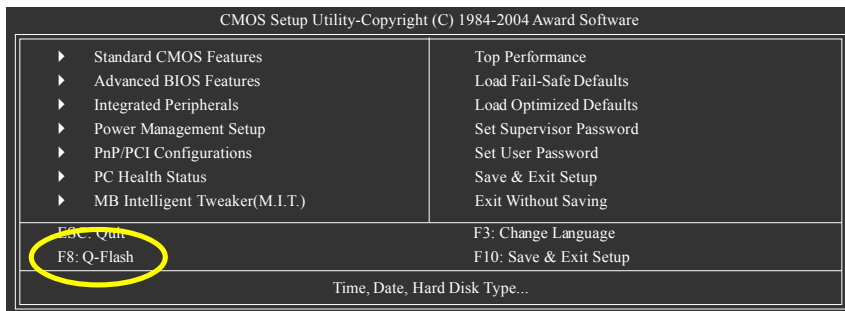

Exploring the Q-Flash™ utility screen

The Q-FlashBIOS utility screen consists of the following key components.

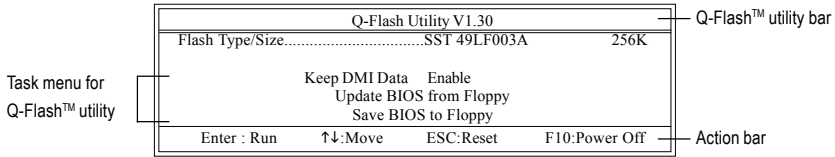

Task menu for Q-Flash utility:

Contains the names of three tasks. Blocking a task and pressing Enter key on your keyboard to enable execution of the task.

Action bar:

Contains the names of four actions needed to operate the Q-Flash utility. Pressing the buttons mentioned on your keyboards to perform these actions.

Using the Q-Flash™ utility:

This section tells you how to update BIOS using the Q-Flash utility. As described in the "Before you begin" section above, you must prepare a floppy disk having the BIOS file for your motherboard and insert it to your computer. If you have already put the floppy disk into your system and have entered the Q-Flash utility, please follow the steps below to flash BIOS.

Steps:

1. Press arrow buttons on your keyboard to move the light bar to "Update BIOS from Floppy" item in the Q-Flash menu and press Enter button.
Later, you will see a box pop up showing the BIOS files you previously downloaded to the floppy disk.



If you want to save the current BIOS for backup purpose, you can begin Step 1 with "Save BIOS to Floppy" item.

2. Move to the BIOS file you want to flash and press Enter.

In this example, we only download one BIOS file to the floppy disk so only one BIOS file, 8GE800.F4, is listed.



Please confirm again you have the correct BIOS file for your motherboard.

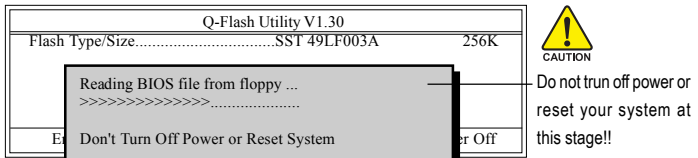
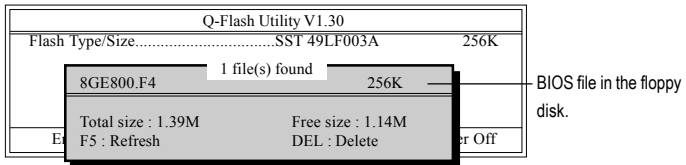

After BIOS file is read, you'll see a confirmation dialog box asking you "Are you sure to update BIOS?"



Please do not take out the floppy disk when it begins flashing BIOS.

- Press Y button on your keyboard after you are sure to update BIOS.
Then it will begin to update BIOS. The progress of updating BIOS will be shown at the same time.

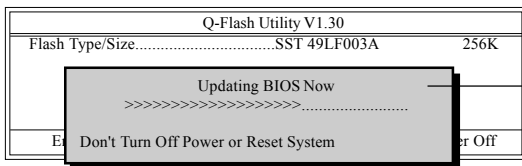

Do not turn off power or reset your system at this stage!!

- Press any keys to return to the Q-Flash menu when the BIOS updating procedure is completed.

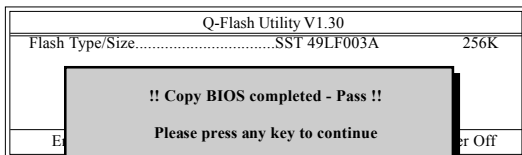

- Press Esc and then Y button to exit the Q-Flash utility. The computer will restart automatically after you exit Q-Flash.

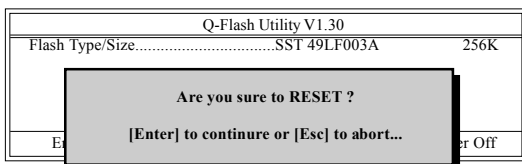

After system reboots, you may find the BIOS version on your boot screen becomes the one you flashed.

The BIOS file becomes F4 after updating

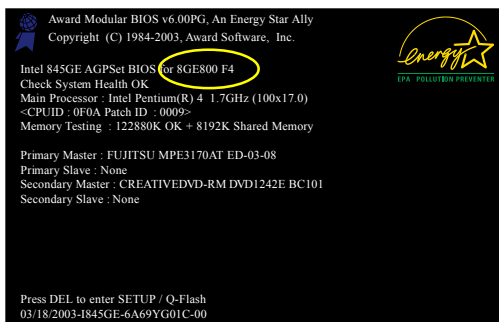

- Press Del to enter BIOS menu after system reboots and "Load BIOS Fail-Safe Defaults". See how to Load BIOS Fail-Safe Defaults, please kindly refer to Step 6 to 7 in **Part One**.

Congratulation!! You have updated BIOS successfully!!

Method 2 : @BIOS™ Utility

If you do not have a DOS startup disk, we recommend that you use the new @BIOS utility. @BIOS allows users to update their BIOS under Windows. Just select the desired @BIOS server to download the latest version of BIOS.

Fig 1. Installing the @BIOS utility

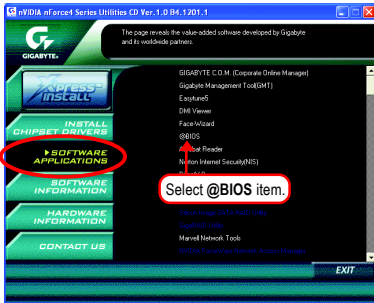

Fig 2. Installation complete and run @BIOS

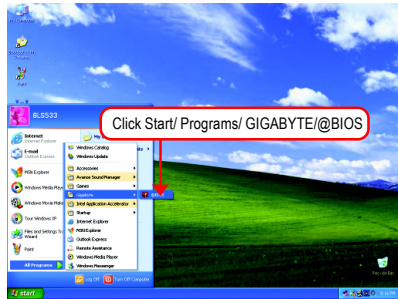

Fig 3. The @BIOS utility

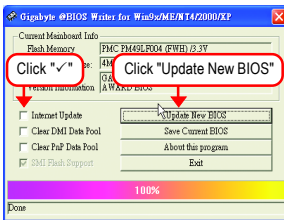
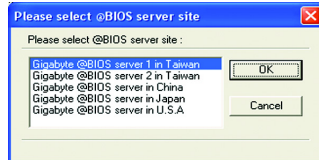

Fig 4. Select the desired @BIOS server



1. Methods and steps:

I. Update BIOS through Internet:

- a. Click "Internet Update" icon.
- b. Click "Update New BIOS" icon.
- c. Select @BIOS™ sever.
- d. Select the exact model name on your motherboard.
- e. System will automatically download and update the BIOS.

II. Update BIOS NOT through Internet:

- a. Do not click "Internet Update" icon.
- b. Click "Update New BIOS".
- c. Please select "All Files" in dialog box while opening the old file.
- d. Please search for BIOS unzip file, downloading from internet or any other methods (such as: K8NS939.D2).
- e. Complete update process following the instruction.

III. Save BIOS:

In the very beginning, there is "Save Current BIOS" icon shown in dialog box. It means to save the current BIOS version.

IV. Check out supported motherboard and Flash ROM:

In the very beginning, there is "About this program" icon shown in dialog box. It can help you check out which kind of motherboard and which brand of Flash ROM are supported.

2. Note:

- I. In method I, if it shows two or more motherboard's model names to be selected, please make sure your motherboard's model name again. Selecting wrong model name will cause the system unbooted.
- II. In method II, be sure that motherboard's model name in BIOS unzip file are the same as your motherboard's. Otherwise, your system won't boot.
- III. In method I, if the BIOS file you need cannot be found in @BIOS™ server, please go onto Gigabyte's website for downloading and updating it according to method II.
- IV. Please note that any interruption during updating will cause system unbooted.
- V. Do not use @BIOS and C.O.M. (Corporate Online Management) at the same time.

4-1-4 Serial ATA BIOS Setting Utility Introduction

RAID Levels

RAID (Redundant Array of Independent Disks) is a method of combining two hard disk drives into one logical unit. The advantage of an Array is to provide better performance or data fault tolerance. Fault tolerance is achieved through data redundant operation, where if one drives fails, a mirrored copy of the data can be found on another drive. This can prevent data loss if the operating system fails or hangs. The individual disk drives in an array are called members. The configuration information of each member is recorded in the reserved sector that identifies the drive as a member. All disk members in a formed disk array are recognized as a single physical drive to the operating system.

Hard disk drives can be combined together through a few different methods. The different methods are referred to as different RAID levels. Different RAID levels represent different performance levels, security levels and implementation costs. The RAID levels which the nVIDIA® nForce4 SLI chipset supports are RAID 0, RAID 1, RAID 0+RAID 1 and JBOD.

RAID 0 (Striping)

RAID 0 reads and writes sectors of data interleaved between multiple drives. If any disk member fails, it affects the entire array. The disk array data capacity is equal to the number of drive members times the capacity of the smallest member. The striping block size can be set from 4KB to 64KB. RAID 0 does not support fault tolerance.

RAID 1 (Mirroring)

RAID 1 writes duplicate data onto a pair of drives and reads both sets of data in parallel. If one of the mirrored drives suffers a mechanical failure or does not respond, the remaining drive will continue to function. Due to redundancy, the drive capacity of the array is the capacity of the smallest drive. Under a RAID 1 setup, an extra drive called the spare drive can be attached. Such a drive will be activated to replace a failed drive that is part of a mirrored array. Due to the fault tolerance, if any RAID 1 drive fails, data access will not be affected as long as there are other working drives in the array.

RAID 0+1 (Striping + Mirroring)

RAID 0+1 combines the performance of data striping (RAID 0) and the fault tolerance of disk mirroring (RAID 1). Data is striped across multiple drives and duplicated on another set of drives.

JBOD (Spanning)

A spanning disk array is equal to the sum of the all drives when the drives used are having different capacities. Spanning stores data onto a drive until it is full, then proceeds to store files onto the next drive in the array. When any disk member fails, the failure affects the entire array. JBOD is not really a RAID and does not support fault tolerance.

Please follow the steps below to construct a complete RAID array:

- 1) Have ready your hard drives for RAID construction.
Note: To achieve best performance, it is recommended that the hard drives used are of similar make and storage capacity.
- 2) Please attach the hard drive connectors to their appropriate location on the motherboard ie. IDE, SCSI, or SATA.
- 3) Enter the motherboard BIOS and locate RAID setup (Please refer to the section on Integrated Peripherals).
- 4) Enter RAID setup in the BIOS and select the RAID type (For instance, enter F10 to select NVIDIA RAID; Ctrl + S to select Silicon Image).
- 5) Complete driver installation.
- 6) Complete RAID utility installation.

More information on steps 4 and 5 is provided. (For more detailed setup information, please visit "Support\ Motherboard\ Technology Guide section" on our website at <http://www.gigabyte.com.tw> to read or download the information you need.)

Configuring the Nvidia RAID BIOS

The NVRAID BIOS setup lets you choose the RAID array type and which hard drives you want to make part of the array.

Entering the RAID BIOS Setup

1. After rebooting your computer, wait until you see the RAID software prompting you to press **F10**. The RAID prompt appears as part of the system POST and boot process prior to loading the OS. You have a few seconds to press **F10** before the window disappears.

```
NVIDIA RAID IDE ROM BIOS 4.76
Copyright (C) 2004 NVIDIA Corp.
```

```
Detecting array ...
```

```
Press F10 to enter RAID setup utility ...
```

Press **F10**.

The NVIDIA RAID Utility - **Define a New Array** window appears (as Figure below).

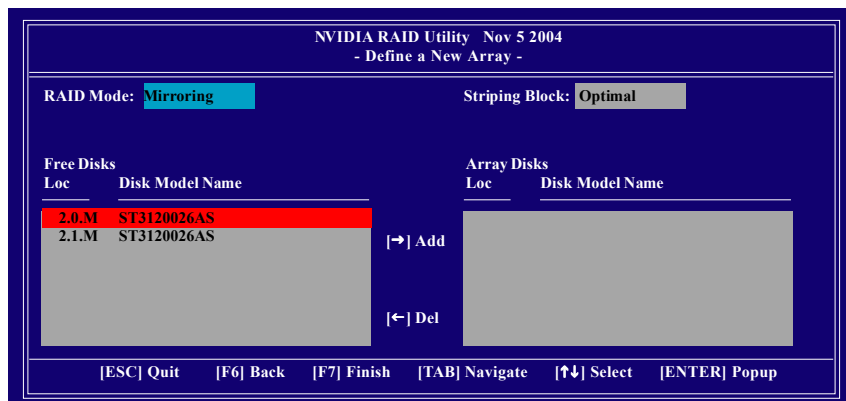

Using the "Define a New Array" Window

If necessary, press the tab key to move from field to field until the appropriate field is highlighted.

Selecting the RAID Mode

By default, this is set to Mirroring. To change to a different RAID mode, press the down arrow key until the mode that you want appears in the RAID Mode box - either Mirroring, Striping, Spanning, or Stripe Mirroring.

Selecting the Striping Block Size

Striping block size is given in kilobytes, and affects how data is arranged on the disk. It is recommended to leave this value at the default Optimal, which is 64KB, but the values can be between 4 KB and 128 KB.

Assigning the Disks

The disks that you enabled from the RAID Config BIOS setup page appear in the Free Disks block. These are the drives that are available for use as RAID array disks. To designate a free disk to be used as a RAID array disk,

1. Tab to the Free Disks section. The first disk in the list is selected.
2. Move it from the Free Disks block to the Array Disks block by pressing the right arrow key (→). The first disk in the list is moved, and the next disk in the list is selected and ready to be moved.
3. Continue pressing the right-arrow key (→) until all the disks that you want to use as RAID array disks appear in the Array Disks block.

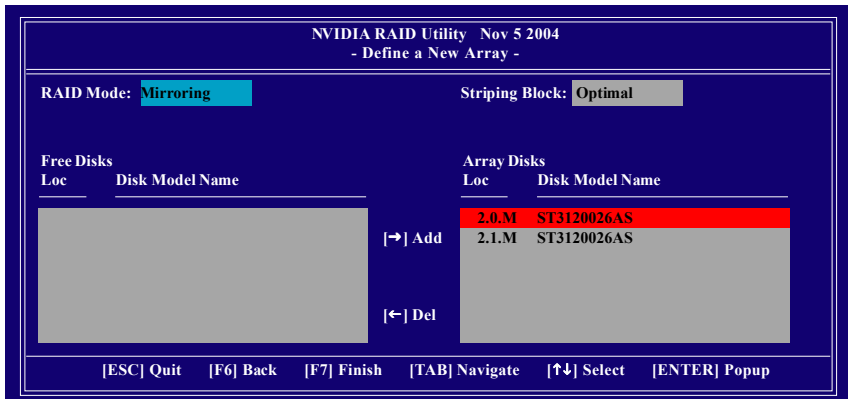

Completing the RAID BIOS Setup

After assigning your RAID array disks, press F7. The **Clear disk data** prompt appears.

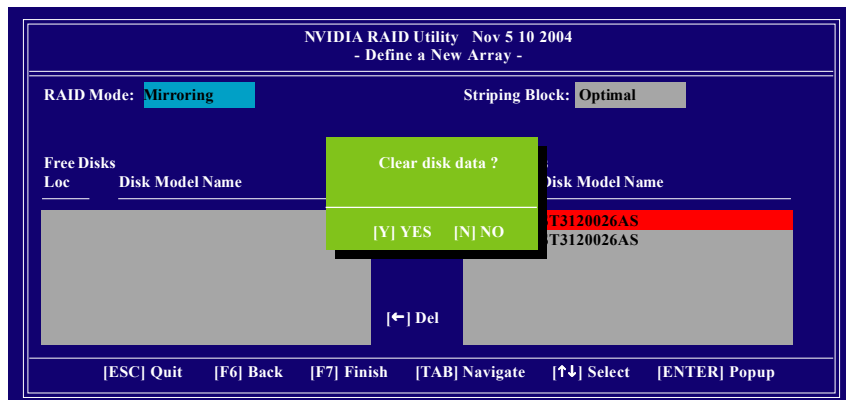

Press **Y** if you want to wipe out all the data from the RAID array, otherwise press **N**. You must choose **Yes** if the drives were previously used as RAID drives. The **Array List** window appears, where you can review the RAID arrays that you have set up.

You can select a disk array as boot device if you want to boot operating system from an array. Use the arrow keys to select the array, then press **B** to specify the array as bootable.

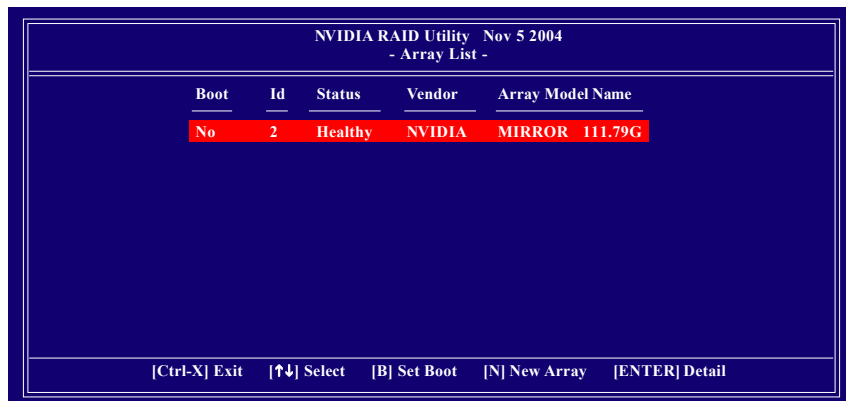

Press **Enter** to view and verify details. The **Array Detail** screen appears.

The Array Detail screen shows various information about the array that you selected, such as Striping Block used, RAID Mode, Striping Width, Disk Model Name, and disk capacity.

Array 2 : NVIDIA MIRROR 111.79G - Array Detail -					
RAID Mode: Mirroring			Striping Block: 64K		
Striping Width : 1					
Adapt	Channel	M/S	Index	Disk Model Name	Capacity
2	0	Master	0	ST3120026AS	111.79GB
2	1	Master	1	ST3120026AS	111.79GB
[R] Rebuild [D] Delete [C] Clear Disk [ENTER] Return					

If you want to mark this disk as empty and wipe out all its contents, press **C**.

At the prompt, press **Y** to wipe out all the data, otherwise press **N**.

Press **Enter** again to go back to the previous screen and then press **Ctrl + X** to exit the RAID setup.

Now that the RAID setup has been configured from the RAID BIOS, the next step is to configure and load drivers under Windows.

Installing the RAID drivers

To install operating system onto a serial ATA hard disk successfully, you need to install the SATA controller driver during OS installation. Without the driver, the hard disk may not be recognized during the Windows setup process. First of all, copy the driver for the SATA controller from the motherboard driver CD-ROM to a floppy disk. See the instructions below about how to copy the driver in MS-DOS mode^(Note1). Prepare a startup disk that has CD-ROM support and a blank formatted floppy disk.

Step 1: Insert the prepared startup disk and motherboard driver CD-ROM in your system. Boot from the startup disk. Once at the A:\> prompt, change to the CD-ROM drive (example: D:\>). At the D:\> prompt, type the following two commands. Press ENTER after each command (Fig.1):

```
cd bootdrv
menu
```

Step 2: When the controller menu (Fig.2) appears, remove the startup disk and insert the blank formatted disk. Select the controller driver by pressing the corresponding letter from the menu^(Note2). Your system will then automatically zip and transfer this driver file to the floppy disk. Press 0 to exit when finished.

```
D:\DOSK8Z
DISMQL  DLL          1 10-08-02 7:51p
DRIVERS  <DIR>      94,208 06-15-04 1:19p
HISTORY  TXT         2,703 05-24-04 1:56p
HMOBRU  DLL         53,248 08-21-02 10:11a
IO       EDC         21,877 12-01-04 11:21a
MANUAL  <DIR>      <DIR>      11-23-04 9:24p
MTHDRK  <DIR>      <DIR>      11-23-04 9:24p
MS      <DIR>      <DIR>      10-08-02 7:51p
OEMSETUP INF       30,057 10-08-02 7:51p
OTHER  <DIR>      <DIR>      11-23-04 9:24p
PROSETII <DIR>     <DIR>      11-23-04 9:27p
RAWPME  TXT         4,551 12-01-04 2:09p
SETUP   EXE        421,888 11-25-04 3:32p
TESTM  EXE         196,608 08-09-04 1:44p
TIF     INF         2,139 09-10-04 18:01a
UTILITY <DIR>     <DIR>      11-23-04 9:27p
USERFILE TIC        13 03-28-03 1:45p
XMC9   TXT         7,828 11-24-04 1:51p
-----
             11 411 060,333 bytes free
D:\>cd bootdrv
D:\BOOTDRV>menu
```

Fig.1

```
D:\>cd bootdrv
D:\BOOTDRV>menu
1)Iaa RAID
2)GIGABYTE
3)SII
4)SII RAID
5)SCSI
6)Promise 20276 ATA
7)Promise 20276 RAID
8)Promise 20265 ATA
9)Promise 20265 ATA(XP)
A)Promise 20265 RAID
B)Promise 20265 RAID(XP)
C)Mar 8237 Series ATA
D)SIS 964 SATA
E)ALIUDA Series ATA(XP)
F)ALIUDA Series ATA(2K)
G)SII3114
H)SII3114 Raid
I)SII3114 Raid5
0)Exit
```

Fig.2

Step 3: After completing the steps, boot from the Windows installation disk to install the RAID drivers. Press **F6** as soon as you see the "Press F6 if you need to install a third party SCSI or RAID driver" message, then supply serial ATA controller driver by this floppy disk. Follow the on-screen instructions to complete the installation.

(Each time you add a new hard drive to a RAID array, the RAID driver will have to be installed under Windows once for that hard drive. After that, the driver will not have to be installed.)



(Note 1): For users without a startup disk.

Use an alternative system and insert the GIGABYTE motherboard driver CD-ROM. From the CD-ROM drive (example: D:\) double click the **MENU.exe** file in the **BootDrv** folder. A command prompt window will open similar to that in Fig. 2.

(Note 2)^{D)}: If you wish to install operating system to SATA hard disks on the SiI3114 controller, you must select the **SiI3114 Raid5** item. Please refer to the provided SiI3114 SATA RAID (RAID 5) function manual for detailed information about SiI3114 SATA RAID configuration.

① Only for GA-K8N Ultra-SLI.

Introduction of audio connectors:

You may connect CD-ROM/DVD-ROM, walkman or others audio input to Line In.

The front channels or earphone can be connected to Line Out (Front Speaker Out).

Connect microphone to Mic In.

Connect the Center/Subwoofer channels to Center/Subwoofer Speaker Out.

Connect the rear channels to Rear Speaker Out.

Connect the side channels to Side Speaker Out.

The installation of audio software is very simple. Please follow the steps to install the function. (Following pictures are in Windows XP)

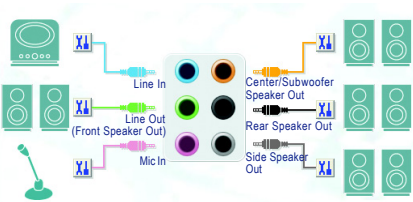

Stereo Speakers Connection and Settings:

We recommend that you use the speaker with amplifier to acquire the best sound effect if the stereo output is applied.

STEP 1:

Connect the stereo speakers or earphone to "Line Out".

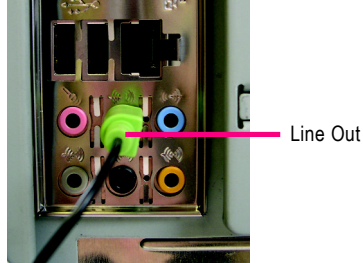

STEP 2 :

Following installation of the audio driver, you find a Sound Effect icon on the lower right hand taskbar. Click the icon to select the function.

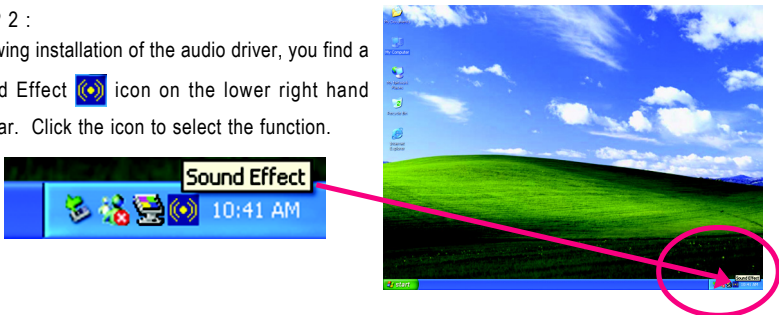

STEP 3:

Click "Speaker Configuration" then click on the left selection bar and select "2CH Speaker" to complete 2 channel audio configuration.

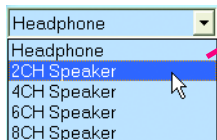

4 Channel Audio Setup

STEP 1 :

Connect the front channels to "Front Speaker Out", the rear channels to "Rear Speaker Out".

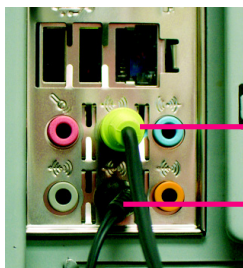

STEP 2 :

Following installation of the audio driver, you find a Sound Effect icon on the lower right hand taskbar. Click the icon to select the function.



STEP 3:

Click "Speaker Configuration" then click on the left selection bar and select "4CH Speaker" to complete 4 channel audio configuration.

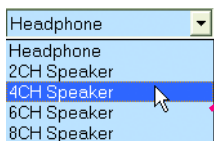

6 Channel Audio Setup

STEP 1 :

Connect the front channels to "Front Speaker Out", the rear channels to "Rear Speaker Out", and the Center/Subwoofer channels to "Center/Subwoofer Speaker Out".

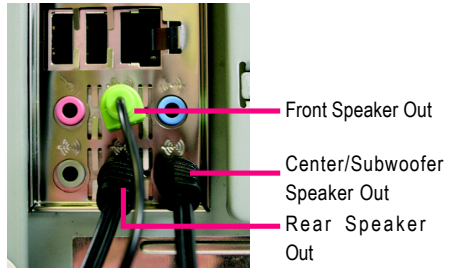

STEP 2 :

Following installation of the audio driver, you find a Sound Effect  icon on the lower right hand taskbar. Click the icon to select the function.

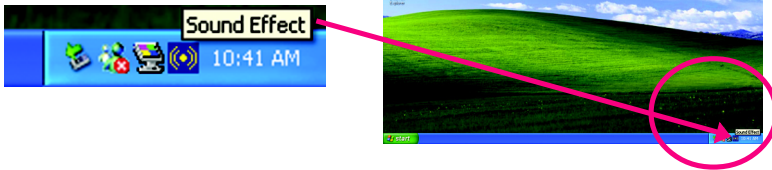

STEP 3:

Click "Speaker Configuration" then click on the left selection bar and select "6CH Speaker" to complete 6 channel audio configuration.

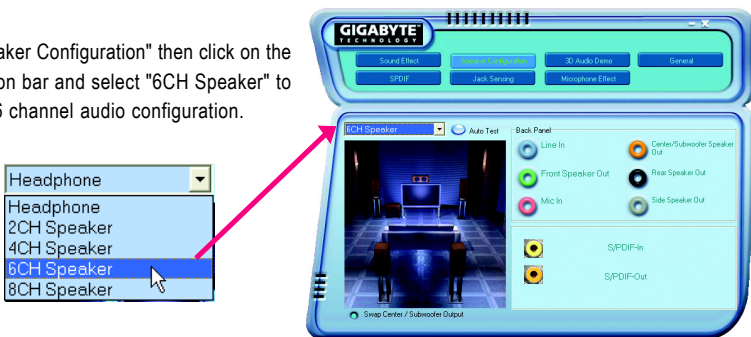

8 Channel Audio Setup

STEP 1 :

Connect the front channels to "Front Speaker Out", the rear channels to "Rear Speaker Out", the Center/Subwoofer channels to "Center/Subwoofer Speaker Out", and the side channels to "Side Speaker Out".

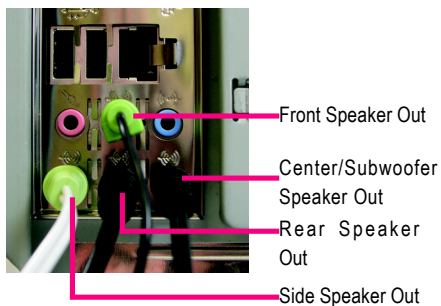

STEP 2 :

Following installation of the audio driver, you find a Sound Effect icon on the lower right hand taskbar. Click the icon to select the function.

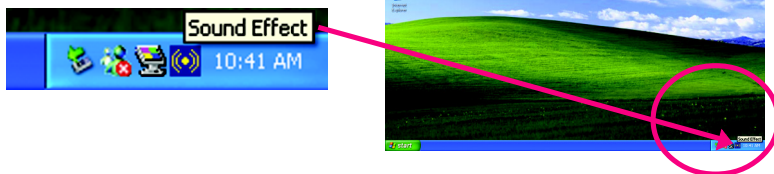

STEP 3:

Click "Speaker Configuration" then click on the left selection bar and select "8CH Speaker" to complete 8 channel audio configuration.

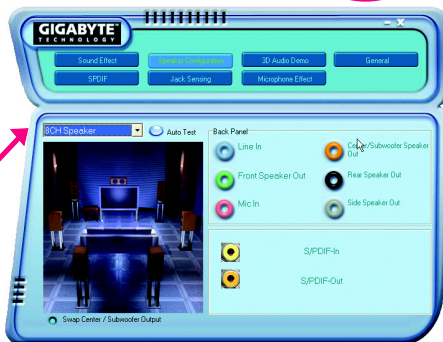
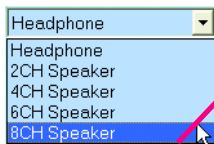

Sound Effect Configuration:

At the sound effect menu, users can adjust sound option settings as desired.

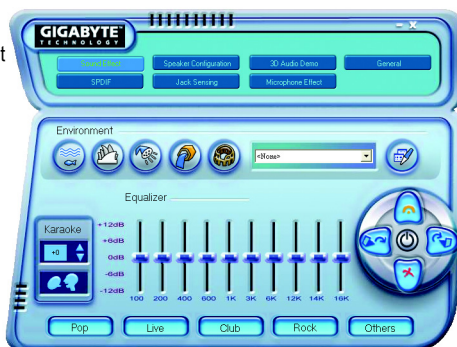

Jack-Sensing Introduction

Jack-Sensing provides audio connectors error-detection function.



Install Microsoft DirectX8.1 or later version before to enable Jack-Sensing support for Windows 98/ 98SE/ 2000/ ME.

Jack-Sensing includes 2 parts: AUTO and MANUAL. Following is an example for 2 channels (Following pictures are in Windows XP):

Introduction of audio connectors

You may connect CDROM, Walkman or others audio input devices to Line In jack, speakers, earphone or others output devices to Line Out jack, and microphone to MIC In jack.

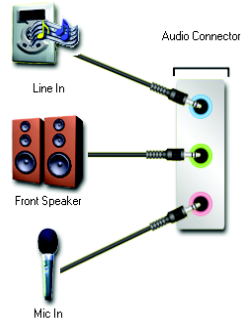

Auto-detecting:

Please connect the devices to the right jacks as above. A window will appear as right picture if you setup the devices properly.

Please note that 3D audio function will only appear when 3D audio inputs.

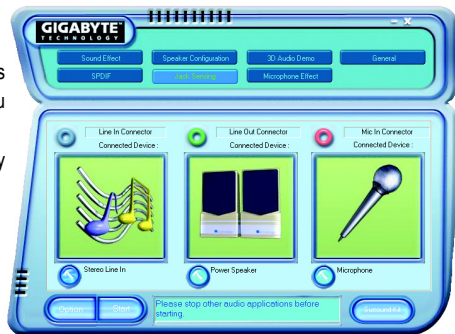

If you set wrong with the connectors, the warning message will come out as right picture.



Manual setting:

If the device picture shows different from what you set, please press "Manual Selection" to set.

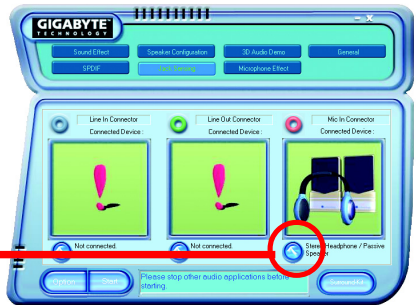
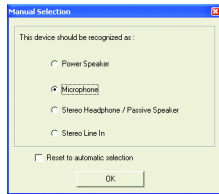

4-2 Troubleshooting

Below is a collection of general asked questions. To check general asked questions based on a specific motherboard model, please log on to www.gigabyte.com.tw

Question 1: I cannot see some options that were included in previous BIOS after updating BIOS. Why?
 Answer: Some advanced options are hidden in new BIOS version. Please press Ctrl and F1 keys after entering BIOS menu and you will be able to see these options.

Questions 2: Why is the light of my keyboard/optical mouse still on after computer shuts down?
 Answer: In some boards, a small amount of electricity is kept on standby after computer shuts down and that's why the light is still on.

Question 3: How do I clear CMOS?
 Answer: If your board has a Clear CMOS jumper, please refer to the Clear CMOS steps in the manual. If your board doesn't have such jumper, you can take off the on-board battery to leak voltage to clear CMOS. Please refer to the steps below:

Steps:

1. Turn off power.
2. Disconnect the power cord from MB.
3. Take out the battery gently and put it aside for about 10 minutes (Or you can use a metal object to connect the positive and negative pins in the battery holder to makethem short for one minute).
4. Re-insert the battery to the battery holder.
5. Connect power cord to MB again and turn on power.
6. Press Del to enter BIOS and load Fail-Safe Defaults(or load Optimized Defaults).
7. Save changes and reboot the system.

Question 4: Why do I still get a weak sound after turning up the speaker to the maximum volume?
 Answer: Please make sure the speaker you are using is equipped with an internal amplifier. If not, please change another speaker with power/amplifier and try again later.

Question 5: Sometimes I hear different continuous beeps from computer after system boots up. What do these beeps usually stand for?

Answer: The beep codes below may help you identify the possible computer problems. However, they are only for reference purposes. The situations might differ from case to case.

→ AMI BIOS Beep Codes

*Computer gives 1 short beep when system boots successfully.

*Except for beep code 8, these codes are always fatal.

- 1 beep Refresh failure
- 2 beeps Parity error
- 3 beeps Base 64K memory failure
- 4 beeps Timer not operational
- 5 beeps Processor error
- 6 beeps 8042 - gate A20 failure
- 7 beeps Processor exception interrupt error
- 8 beeps Display memory read/write failure
- 9 beeps ROM checksum error
- 10 beeps CMOS shutdown register read/write error
- 11 beeps Cache memory bad

→ AWARD BIOS Beep Codes

- 1 short: System boots successfully
- 2 short: CMOS setting error
- 1 long 1 short: DRAM or M/B error
- 1 long 2 short: Monitor or display card error
- 1 long 3 short: Keyboard error
- 1 long 9 short: BIOS ROM error
- Continuous long beeps: DRAM error
- Continuous short beeps: Power error



Contact Us

- **Taiwan (Headquarters)**

GIGA-BYTE TECHNOLOGY CO., LTD.

Address: No.6, Bau Chiang Road, Hsin-Tien, Taipei 231, Taiwan

TEL: +886-2-8912-4888

FAX: +886-2-8912-4003

Tech. Support :

<http://tw.giga-byte.com/TechSupport/ServiceCenter.htm>

Non-Tech. Support(Sales/Marketing) :

<http://ggts.gigabyte.com.tw/nontech.asp>

WEB address (English) : <http://www.gigabyte.com.tw>

WEB address (Chinese) : <http://chinese.giga-byte.com>

- **U.S.A.**

G.B.T. INC.

TEL: +1-626-854-9338

FAX: +1-626-854-9339

Tech. Support :

<http://tw.giga-byte.com/TechSupport/ServiceCenter.htm>

Non-Tech. Support(Sales/Marketing) :

<http://ggts.gigabyte.com.tw/nontech.asp>

WEB address : <http://www.giga-byte.com>

- **Germany**

G.B.T. TECHNOLOGY TRADING GMBH

Tech. Support :

<http://tw.giga-byte.com/TechSupport/ServiceCenter.htm>

Non-Tech. Support(Sales/Marketing) :

<http://ggts.gigabyte.com.tw/nontech.asp>

WEB address : <http://www.gigabyte.de>

- **Japan**

NIPPON GIGA-BYTE CORPORATION

WEB address : <http://www.gigabyte.co.jp>

- **Singapore**

GIGA-BYTE SINGAPORE PTE. LTD.

Tech. Support :

<http://tw.giga-byte.com/TechSupport/ServiceCenter.htm>

Non-Tech. Support(Sales/Marketing) :

<http://ggts.gigabyte.com.tw/nontech.asp>

WEB address : <http://www.gigabyte.com.sg>

- **U.K.**

G.B.T. TECH. CO., LTD.

Tech. Support :

<http://tw.giga-byte.com/TechSupport/ServiceCenter.htm>

Non-Tech. Support(Sales/Marketing) :

<http://ggts.gigabyte.com.tw/nontech.asp>

WEB address : <http://uk.giga-byte.com>

- **The Netherlands**

GIGA-BYTE TECHNOLOGY B.V.

Tech. Support :

<http://tw.giga-byte.com/TechSupport/ServiceCenter.htm>

Non-Tech. Support(Sales/Marketing) :

<http://ggts.gigabyte.com.tw/nontech.asp>

WEB address : <http://www.giga-byte.nl>

- **China**

NINGBO G.B.T. TECH. TRADING CO., LTD.

Tech. Support :

<http://tw.giga-byte.com/TechSupport/ServiceCenter.htm>

Non-Tech. Support(Sales/Marketing) :

<http://ggts.gigabyte.com.tw/nontech.asp>

WEB address : <http://www.gigabyte.com.cn>

Shanghai

TEL: +86-021-63410999

FAX: +86-021-63410100

Beijing

TEL: +86-10-62102838

FAX: +86-10-62102848

Wuhan

TEL: +86-27-87851061

FAX: +86-27-87851330

GuangZhou

TEL: +86-20-87586074

FAX: +86-20-85517843

Chengdu

TEL: +86-28-85236930

FAX: +86-28-85256822

Xian

TEL: +86-29-85531943

FAX: +86-29-85539821

Shenyang

TEL: +86-24-23960918

FAX: +86-24-23960918-809

- **Australia**

GIGABYTE TECHNOLOGY PTY. LTD.

Tech. Support :

<http://tw.giga-byte.com/TechSupport/ServiceCenter.htm>

Non-Tech. Support(Sales/Marketing) :

<http://ggts.gigabyte.com.tw/nontech.asp>

WEB address : <http://www.giga-byte.com.au>

- **France**

GIGABYTE TECHNOLOGY FRANCE S.A.R.L.

Tech. Support :

<http://tw.giga-byte.com/TechSupport/ServiceCenter.htm>

Non-Tech. Support(Sales/Marketing) :

<http://ggts.gigabyte.com.tw/nontech.asp>

WEB address : <http://www.gigabyte.fr>

- **Russia**

Moscow Representative Office Of GIGA-BYTE Technology Co., Ltd.

Tech. Support :

<http://tw.giga-byte.com/TechSupport/ServiceCenter.htm>

Non-Tech. Support(Sales/Marketing) :

<http://ggts.gigabyte.com.tw/nontech.asp>

WEB address : <http://www.gigabyte.ru>

- **Poland**

Office of GIGA-BYTE TECHNOLOGY Co., Ltd. in POLAND

Tech. Support :

<http://tw.giga-byte.com/TechSupport/ServiceCenter.htm>

Non-Tech. Support(Sales/Marketing) :

<http://ggts.gigabyte.com.tw/nontech.asp>

WEB address : <http://www.gigabyte.pl>

- **Serbia & Montenegro**

Representative Office Of GIGA-BYTE Technology Co., Ltd. in SERBIA & MONTENEGRO

Tech. Support :

<http://tw.giga-byte.com/TechSupport/ServiceCenter.htm>

Non-Tech. Support(Sales/Marketing) :

<http://ggts.gigabyte.com.tw/nontech.asp>

WEB address: <http://www.gigabyte.co.yu>

- **Czech Republic**

Representative Office Of GIGA-BYTE Technology Co., Ltd. in CZECH REPUBLIC

Tech. Support :

<http://tw.giga-byte.com/TechSupport/ServiceCenter.htm>

Non-Tech. Support(Sales/Marketing) :

<http://ggts.gigabyte.com.tw/nontech.asp>

WEB address: <http://www.gigabyte.cz>

- **Romania**

Representative Office Of GIGA-BYTE Technology Co., Ltd. in Romania

Tech. Support :

<http://tw.giga-byte.com/TechSupport/ServiceCenter.htm>

Non-Tech. Support(Sales/Marketing) :

<http://ggts.gigabyte.com.tw/nontech.asp>

WEB address: <http://www.gigabyte.com.ro>
