

# GA-EX58-UD4P

LGA1366 socket motherboard for Intel® Core™ i7 processor family

## User's Manual

Rev. 1004

12ME-EX58UD4-1004R



## **Copyright**

© 2009 GIGA-BYTE TECHNOLOGY CO., LTD. All rights reserved.

The trademarks mentioned in this manual are legally registered to their respective owners.

## **Disclaimer**

Information in this manual is protected by copyright laws and is the property of GIGABYTE.

Changes to the specifications and features in this manual may be made by GIGABYTE without prior notice. No part of this manual may be reproduced, copied, translated, transmitted, or published in any form or by any means without GIGABYTE's prior written permission.

## **Documentation Classifications**

In order to assist in the use of this product, GIGABYTE provides the following types of documentations:

- For quick set-up of the product, read the Quick Installation Guide included with the product.
- For detailed product information, carefully read the User's Manual.
- For instructions on how to use GIGABYTE's unique features, read or download the information on/from the Support\Motherboard\Technology Guide page on our website.

For product-related information, check on our website at:

<http://www.gigabyte.com.tw>

## **Identifying Your Motherboard Revision**

The revision number on your motherboard looks like this: "REV: X.X." For example, "REV: 1.0" means the revision of the motherboard is 1.0. Check your motherboard revision before updating motherboard BIOS, drivers, or when looking for technical information.

Example:

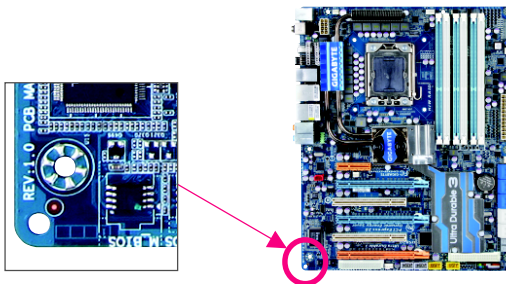

# Table of Contents

Box Contents .....	6
Optional Items .....	6
GA-EX58-UD4P Motherboard Layout .....	7
Block Diagram .....	8
Chapter 1 Hardware Installation .....	9
1-1 Installation Precautions .....	9
1-2 Product Specifications .....	10
1-3 Installing the CPU and CPU Cooler .....	13
1-3-1 Installing the CPU .....	13
1-3-2 Installing the CPU Cooler .....	15
1-4 Installing the Memory .....	16
1-4-1 Dual/3 Channel Memory Configuration .....	16
1-4-2 Installing a Memory .....	17
1-5 Installing an Expansion Card .....	18
1-6 Setup of NVIDIA SLI (Scalable Link Interface)/ATI CrossFireX Configuration ...	19
1-7 Installing the SATA Bracket .....	22
1-8 Back Panel Connectors .....	23
1-9 Onboard LEDs and Switches .....	25
1-10 Internal Connectors .....	27
Chapter 2 BIOS Setup .....	41
2-1 Startup Screen .....	42
2-2 The Main Menu .....	43
2-3 MB Intelligent Tweaker(M.I.T.) .....	45
2-4 Standard CMOS Features .....	55
2-5 Advanced BIOS Features .....	57
2-6 Integrated Peripherals .....	59
2-7 Power Management Setup .....	62
2-8 PC Health Status .....	64
2-9 Load Fail-Safe Defaults .....	66
2-10 Load Optimized Defaults .....	66
2-11 Set Supervisor/User Password .....	67
2-12 Save & Exit Setup .....	68
2-13 Exit Without Saving .....	68
2-14 Security Chip Configuration .....	69

Chapter 3 Drivers Installation .....	71
3-1 Installing Chipset Drivers .....	71
3-2 Application Software .....	72
3-3 Technical Manuals .....	72
3-4 Contact .....	73
3-5 System .....	73
3-6 Download Center .....	74
Chapter 4 Unique Features .....	75
4-1 Xpress Recovery2 .....	75
4-2 BIOS Update Utilities .....	78
4-2-1 Updating the BIOS with the Q-Flash Utility .....	78
4-2-2 Updating the BIOS with the @BIOS Utility .....	81
4-3 EasyTune 6 .....	82
4-4 Dynamic Energy Saver Advanced .....	83
4-5 Ultra TPM .....	85
4-6 Q-Share .....	86
4-7 Time Repair .....	87
Chapter 5 Appendix .....	89
5-1 Configuring SATA Hard Drive(s) .....	89
5-1-1 Configuring Intel ICH10R SATA Controllers .....	89
5-1-2 Configuring GIGABYTE SATA2 SATA Controller .....	95
5-1-3 Making a SATA RAID/AHCI Driver Diskette .....	101
5-1-4 Installing the SATA RAID/AHCI Driver and Operating System .....	102
5-2 Configuring Audio Input and Output .....	112
5-2-1 Configuring 2/4/5.1/7.1-Channel Audio .....	112
5-2-2 Configuring S/PDIF In/Out .....	114
5-2-3 Enabling the Dolby Home Theater Function .....	116
5-2-4 Configuring Microphone Recording .....	117
5-2-5 Using the Sound Recorder .....	119
5-3 Troubleshooting .....	120
5-3-1 Frequently Asked Questions .....	120
5-3-2 Troubleshooting Procedure .....	121
5-4 Regulatory Statements .....	123

## Box Contents

- GA-EX58-UD4P motherboard
- Motherboard driver disk
- User's Manual
- Quick Installation Guide
- One IDE cable
- Four SATA 3Gb/s cables
- One SATA bracket
- I/O shield
- 2-Way SLI bridge connector
- 3-Way SLI bridge connector

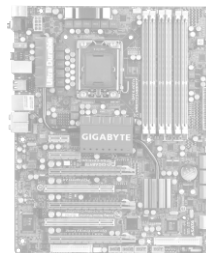

- The box contents above are for reference only and the actual items shall depend on product package you obtain. The box contents are subject to change without notice.
- The motherboard image is for reference only.

## Optional Items

- Floppy disk drive cable (Part No. 12CF1-1FD001-7\*R)
- 2-port USB 2.0 bracket (Part No. 12CR1-1UB030-5\*R)
- 2-port IEEE 1394a bracket (Part No. 12CF1-1IE008-0\*R)
- 2-port SATA power cable (Part No. 12CF1-2SERPW-0\*R)
- S/PDIF in cable (Part No. 12CR1-1SPDIN-0\*R)



# Block Diagram

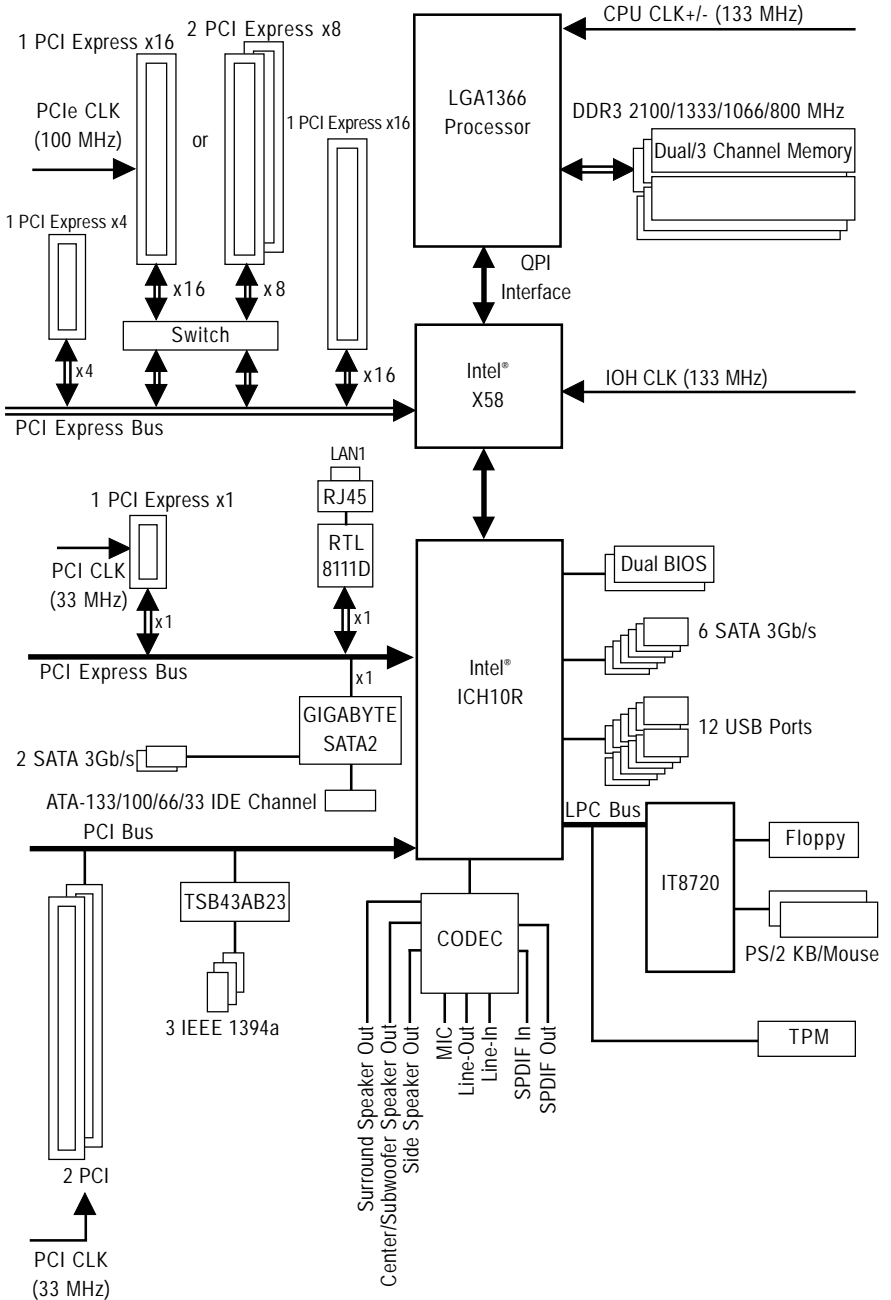



# Chapter 1 Hardware Installation

## 1-1 Installation Precautions

The motherboard contains numerous delicate electronic circuits and components which can become damaged as a result of electrostatic discharge (ESD). Prior to installation, carefully read the user's manual and follow these procedures:

- Prior to installation, do not remove or break motherboard S/N (Serial Number) sticker or warranty sticker provided by your dealer. These stickers are required for warranty validation.
- Always remove the AC power by unplugging the power cord from the power outlet before installing or removing the motherboard or other hardware components.
- When connecting hardware components to the internal connectors on the motherboard, make sure they are connected tightly and securely.
- When handling the motherboard, avoid touching any metal leads or connectors.
- It is best to wear an electrostatic discharge (ESD) wrist strap when handling electronic components such as a motherboard, CPU or memory. If you do not have an ESD wrist strap, keep your hands dry and first touch a metal object to eliminate static electricity.
- Prior to installing the motherboard, please have it on top of an antistatic pad or within an electrostatic shielding container.
- Before unplugging the power supply cable from the motherboard, make sure the power supply has been turned off.
- Before turning on the power, make sure the power supply voltage has been set according to the local voltage standard.
- Before using the product, please verify that all cables and power connectors of your hardware components are connected.
- To prevent damage to the motherboard, do not allow screws to come in contact with the motherboard circuit or its components.
- Make sure there are no leftover screws or metal components placed on the motherboard or within the computer casing.
- Do not place the computer system on an uneven surface.
- Do not place the computer system in a high-temperature environment.
- Turning on the computer power during the installation process can lead to damage to system components as well as physical harm to the user.
- If you are uncertain about any installation steps or have a problem related to the use of the product, please consult a certified computer technician.

## 1-2 Product Specifications

CPU	<ul style="list-style-type: none"><li>◆ Support for an Intel® Core™ i7 series processor in the LGA 1366 package (Go to GIGABYTE's website for the latest CPU support list.)</li><li>◆ L3 cache varies with CPU</li></ul>
QPI	<ul style="list-style-type: none"><li>◆ 4.8GT/s / 6.4GT/s</li></ul>
Chipset	<ul style="list-style-type: none"><li>◆ North Bridge: Intel® X58 Express Chipset</li><li>◆ South Bridge: Intel® ICH10R</li></ul>
Memory	<ul style="list-style-type: none"><li>◆ 6 x 1.5V DDR3 DIMM sockets supporting up to 24 GB of system memory <sup>(Note 1)</sup></li><li>◆ Dual/3 channel memory architecture</li><li>◆ Support for DDR3 2100/1333/1066/800 MHz memory modules (Go to GIGABYTE's website for the latest memory support list.)</li></ul>
Audio	<ul style="list-style-type: none"><li>◆ Realtek ALC889A codec</li><li>◆ High Definition Audio</li><li>◆ 2/4/5.1/7.1-channel</li><li>◆ Support for Dolby® Home Theater</li><li>◆ Support for S/PDIF In/Out</li><li>◆ Support for CD In</li></ul>
LAN	<ul style="list-style-type: none"><li>◆ 1 x Realtek 8111D chip (10/100/1000 Mbit)</li></ul>
Expansion Slots	<ul style="list-style-type: none"><li>◆ 2 x PCI Express x16 slots, running at x16 (PCIEX16_1/PCIEX16_2) <sup>(Note 2)</sup></li><li>◆ 1 x PCI Express x16 slot, running at x8 (PCIEX8_1) <sup>(Note 3)</sup> (The PCIEX16_1, PCIEX16_2 and PCIEX8_1 slots support 2-Way/3-Way NVIDIA SLI/ATI CrossFireX™ technology and conform to PCI Express 2.0 standard.)</li><li>◆ 1 x PCI Express x4 slot</li><li>◆ 1 x PCI Express x1 slot</li><li>◆ 2 x PCI slots</li></ul>
Storage Interface	<ul style="list-style-type: none"><li>◆ South Bridge:<ul style="list-style-type: none"><li>- 6 x SATA 3Gb/s connectors (SATA2_0, SATA2_1, SATA2_2, SATA2_3, SATA2_4, SATA2_5) supporting up to 6 SATA 3Gb/s devices</li><li>- Support for SATA RAID 0, RAID 1, RAID 5, and RAID 10</li></ul></li><li>◆ GIGABYTE SATA2 chip:<ul style="list-style-type: none"><li>- 1 x IDE connector supporting ATA-133/100/66/33 and up to 2 IDE devices</li><li>- 2 x SATA 3Gb/s connectors (GSATA2_0, GSATA2_1) supporting up to 2 SATA 3Gb/s devices</li><li>- Support for SATA RAID 0, RAID 1 and JBOD</li></ul></li><li>◆ iTE IT8720 chip:<ul style="list-style-type: none"><li>- 1 x floppy disk drive connector supporting up to 1 floppy disk drive</li></ul></li></ul>
IEEE 1394	<ul style="list-style-type: none"><li>◆ T.I. TSB43AB23 chip</li><li>◆ Up to 3 IEEE 1394a ports (1 on the back panel, 2 via the IEEE 1394a brackets connected to the internal IEEE 1394a headers)</li></ul>

USB	<ul style="list-style-type: none"> <li>◆ Integrated in the South Bridge</li> <li>◆ Up to 12 USB 2.0/1.1 ports (8 on the back panel, 4 via the USB brackets connected to the internal USB headers)</li> </ul>
Internal Connectors	<ul style="list-style-type: none"> <li>◆ 1 x 24-pin ATX main power connector</li> <li>◆ 1 x 8-pin ATX 12V power connector</li> <li>◆ 1 x floppy disk drive connector</li> <li>◆ 1 x IDE connector</li> <li>◆ 8 x SATA 3Gb/s connectors</li> <li>◆ 1 x CPU fan header</li> <li>◆ 3 x system fan headers</li> <li>◆ 1 x power fan header</li> <li>◆ 1 x North Bridge fan header</li> <li>◆ 1 x front panel header</li> <li>◆ 1 x front panel audio header</li> <li>◆ 1 x CD In connector</li> <li>◆ 1 x S/PDIF In header</li> <li>◆ 1 x S/PDIF Out header</li> <li>◆ 2 x USB 2.0/1.1 headers</li> <li>◆ 2 x IEEE 1394a headers</li> <li>◆ 1 x power LED header</li> <li>◆ 1 x chassis intrusion header</li> <li>◆ 1 x power switch</li> <li>◆ 1 x reset switch</li> </ul>
Back Panel Connectors	<ul style="list-style-type: none"> <li>◆ 1 x PS/2 keyboard port</li> <li>◆ 1 x PS/2 mouse port</li> <li>◆ 1 x coaxial S/PDIF Out connector</li> <li>◆ 1 x optical S/PDIF Out connector</li> <li>◆ 1 x IEEE 1394a port</li> <li>◆ 1 x clearing CMOS switch</li> <li>◆ 8 x USB 2.0/1.1 ports</li> <li>◆ 1 x RJ-45 port</li> <li>◆ 6 x audio jacks (Center/Subwoofer Speaker Out/Rear Speaker Out/Side Speaker Out/Line In/Line Out/Microphone)</li> </ul>
I/O Controller	<ul style="list-style-type: none"> <li>◆ iTE IT8720 chip</li> </ul>
Hardware Monitor	<ul style="list-style-type: none"> <li>◆ System voltage detection</li> <li>◆ CPU/System/North Bridge temperature detection</li> <li>◆ CPU/System/Power fan speed detection</li> <li>◆ CPU overheating warning</li> <li>◆ CPU/System/Power fan fail warning</li> <li>◆ CPU/System fan speed control <sup>(Note 4)</sup></li> </ul>

BIOS	<ul style="list-style-type: none"> <li>◆ 2 x 8 Mbit flash</li> <li>◆ Use of licensed AWARD BIOS</li> <li>◆ Support for DualBIOS™</li> <li>◆ PnP 1.0a, DMI 2.0, SM BIOS 2.4, ACPI 1.0b</li> </ul>
Unique Features	<ul style="list-style-type: none"> <li>◆ Support for @BIOS</li> <li>◆ Support for Q-Flash</li> <li>◆ Support for Virtual Dual BIOS</li> <li>◆ Support for Download Center</li> <li>◆ Support for Xpress Install</li> <li>◆ Support for Xpress Recovery2</li> <li>◆ Support for EasyTune <sup>(Note 5)</sup></li> <li>◆ Support for Dynamic Energy Saver Advanced</li> <li>◆ Support for Ultra TPM</li> <li>◆ Support for Time Repair</li> <li>◆ Support for Q-Share</li> </ul>
Bundled Software	<ul style="list-style-type: none"> <li>◆ Norton Internet Security (OEM version)</li> </ul>
Operating System	<ul style="list-style-type: none"> <li>◆ Support for Microsoft® Windows® Vista/XP</li> </ul>
Form Factor	<ul style="list-style-type: none"> <li>◆ ATX Form Factor; 30.5cm x 24.4cm</li> </ul>

(Note 1) Due to Windows Vista/XP 32-bit operating system limitation, when more than 4 GB of physical memory is installed, the actual memory size displayed will be less than 4 GB.

(Note 2) For optimum performance, if only one PCI Express graphics card is to be installed, be sure to install it in the PCIEX16\_1 slot; if you are installing two PCI Express graphics cards, it is recommended that you install them in the PCIEX16\_1 and PCIEX16\_2 slots.

(Note 3) The PCIEX8\_1 slot shares bandwidth with the PCIEX16\_2 slot. When PCIEX8\_1 is populated with a PCI Express graphics card, the PCIEX16\_2 slot will operate at up to x8 mode.

(Note 4) Whether the CPU/system fan speed control function is supported will depend on the CPU/system cooler you install.

(Note 5) Available functions in EasyTune may differ by motherboard model.

## 1-3 Installing the CPU and CPU Cooler



Read the following guidelines before you begin to install the CPU:

- Make sure that the motherboard supports the CPU.  
(Go to GIGABYTE's website for the latest CPU support list.)
- Always turn off the computer and unplug the power cord from the power outlet before installing the CPU to prevent hardware damage.
- Locate the pin one of the CPU. The CPU cannot be inserted if oriented incorrectly. (Or you may locate the notches on both sides of the CPU and alignment keys on the CPU socket.)
- Apply an even and thin layer of thermal grease on the surface of the CPU.
- Do not turn on the computer if the CPU cooler is not installed, otherwise overheating and damage of the CPU may occur.
- Set the CPU host frequency in accordance with the CPU specifications. It is not recommended that the system bus frequency be set beyond hardware specifications since it does not meet the standard requirements for the peripherals. If you wish to set the frequency beyond the standard specifications, please do so according to your hardware specifications including the CPU, graphics card, memory, hard drive, etc.

### 1-3-1 Installing the CPU

A. Locate the alignment keys on the motherboard CPU socket and the notches on the CPU.

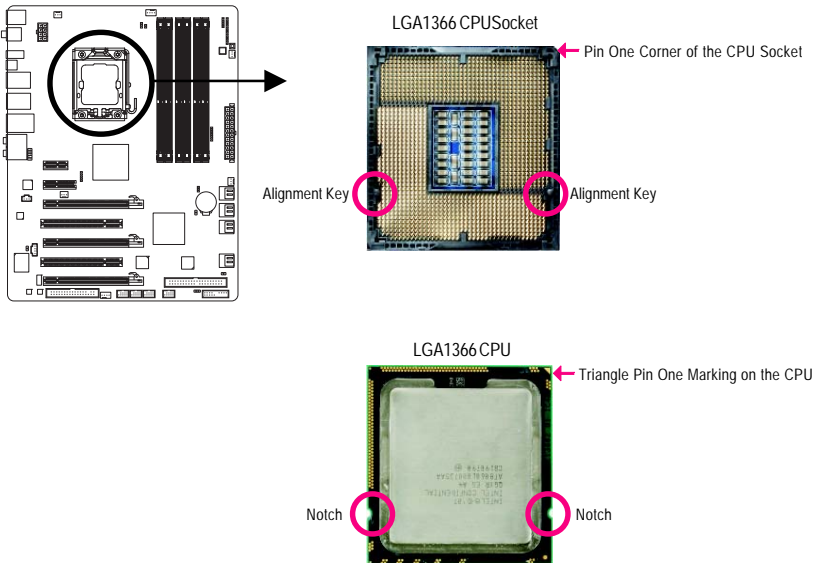

B. Follow the steps below to correctly install the CPU into the motherboard CPU socket.



Before installing the CPU, make sure to turn off the computer and unplug the power cord from the power outlet to prevent damage to the CPU.

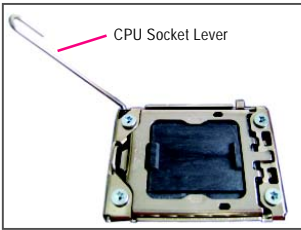

Step 1:  
Completely raise the CPU socket lever.

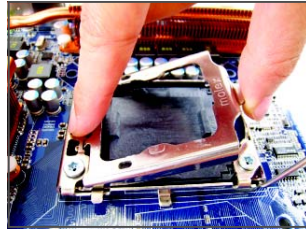

Step 2:  
Lift the metal load plate from the CPU socket.

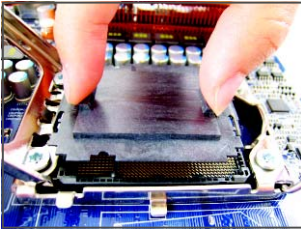

Step 3:  
Use your thumb and index finger to hold the protective socket cover as indicated and lift it up vertically. (DO NOT touch socket contacts. To protect the CPU socket, always replace the protective socket cover when the CPU is not installed.)

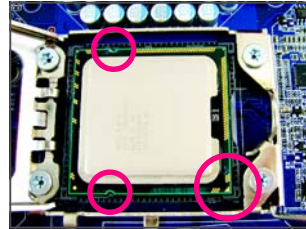

Step 4:  
Hold the CPU with your thumb and index finger. Align the CPU pin one marking (triangle) with the pin one corner of the CPU socket (or you may align the CPU notches with the socket alignment keys) and gently insert the CPU into position.



Step 5:  
Once the CPU is properly inserted, replace the load plate and push the CPU socket lever back into its locked position.

### 1-3-2 Installing the CPU Cooler

Follow the steps below to correctly install the CPU cooler on the motherboard. (The following procedure uses Intel® boxed cooler as the example cooler.)



#### Step 1:

Apply an even and thin layer of thermal grease on the surface of the installed CPU.

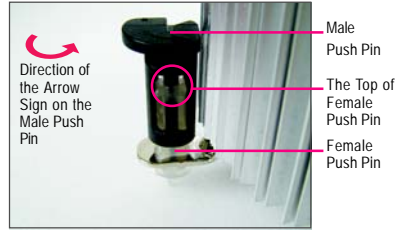

#### Step 2:

Before installing the cooler, note the direction of the arrow sign  on the male push pin. (Turning the push pin along the direction of arrow is to remove the cooler, on the contrary, is to install.)

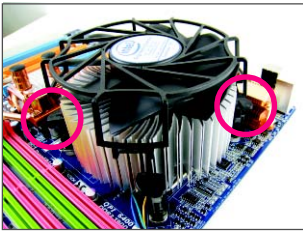

#### Step 3:

Place the cooler atop the CPU, aligning the four push pins through the pin holes on the motherboard. Push down on the push pins diagonally.



#### Step 4:

You should hear a "click" when pushing down each push pin. Check that the Male and Female push pins are joined closely. (Refer to your CPU cooler installation manual for instructions on installing the cooler.)

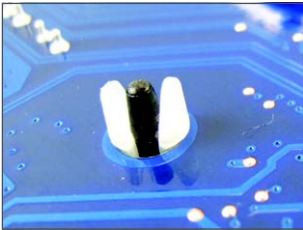

#### Step 5:

After the installation, check the back of the motherboard. If the push pin is inserted as the picture above shows, the installation is complete.

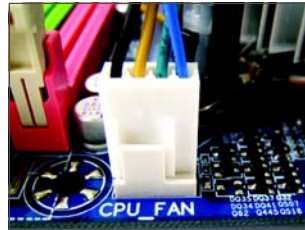

#### Step 6:

Finally, attach the power connector of the CPU cooler to the CPU fan header (CPU\_FAN) on the motherboard.



**NOTE** Use extreme care when removing the CPU cooler because the thermal grease/tape between the CPU cooler and CPU may adhere to the CPU. Inadequately removing the CPU cooler may damage the CPU.

## 1-4 Installing the Memory



Read the following guidelines before you begin to install the memory:

- Make sure that the motherboard supports the memory. It is recommended that memory of the same capacity, brand, speed, and chips be used. (Go to GIGABYTE's website for the latest memory support list.)
- Always turn off the computer and unplug the power cord from the power outlet before installing the memory to prevent hardware damage.
- Memory modules have a foolproof design. A memory module can be installed in only one direction. If you are unable to insert the memory, switch the direction.

### 1-4-1 Dual/3 Channel Memory Configuration



This motherboard provides six DDR3 memory sockets and supports Dual/3 Channel Technology. After the memory is installed, the BIOS will automatically detect the specifications and capacity of the memory. Dual or 3 Channel memory mode may double or triple the original memory bandwidth.

The six DDR3 memory sockets are divided into three channels and each channel has two memory sockets as following:

- ▶▶ Channel 0: DDR3\_1, DDR3\_2
- ▶▶ Channel 1: DDR3\_3, DDR3\_4
- ▶▶ Channel 2: DDR3\_5, DDR3\_6

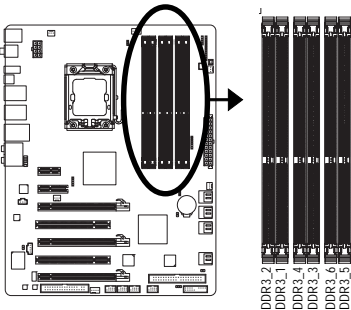

▶▶ Dual Channel Memory Configurations Table

	DDR3_2	DDR3_1	DDR3_4	DDR3_3	DDR3_6	DDR3_5
Two Modules	--	DS/SS	--	DS/SS	--	--
Four Modules	DS/SS	DS/SS	DS/SS	DS/SS	--	--

▶▶ 3 Channel Memory Configurations Table

	DDR3_2	DDR3_1	DDR3_4	DDR3_3	DDR3_6	DDR3_5
Three Modules	--	DS/SS	--	DS/SS	--	DS/SS
Four Modules	DS/SS	DS/SS	--	DS/SS	--	DS/SS
Six Modules	DS/SS	DS/SS	DS/SS	DS/SS	DS/SS	DS/SS

(SS=Single-Sided, DS=Double-Sided, "--"=No Memory)

Due to chipset limitation, read the following guidelines before installing the memory in Dual or 3 Channel mode.

Dual Channel--

1. Dual Channel mode cannot be enabled if only one DDR3 memory module is installed.
2. When enabling Dual Channel mode with two or four modules, it is recommended that memory of the same capacity, brand, speed, and chips be used. When enabling Dual Channel mode with two memory modules, be sure to install them in the DDR3\_1 and DDR3\_3 sockets.

3 Channel--

1. 3 Channel mode cannot be enabled if only one or two DDR3 memory modules are installed.
2. When enabling 3 Channel mode with three, four or six modules, it is recommended that memory of the same capacity, brand, speed, and chips be used.
  - When enabling 3 Channel mode with three memory modules, be sure to install them in the DDR3\_1, DDR3\_3 and DDR3\_5 sockets.
  - When enabling 3 Channel mode with four memory modules, be sure to install them in the DDR3\_1, DDR3\_2, DDR3\_3 and DDR3\_5 sockets.



NOTE

- If only one DDR3 memory module is installed, be sure to install it in the DDR3\_1 or DDR3\_3.
- When memory modules of different capacity and chips are installed, a message which says memory is operating in Flex Memory Mode will appear during the POST. Intel® Flex Memory Technology offers greater flexibility to upgrade by allowing different memory sizes to be populated and remain in Dual/3 Channel mode/performance.



## 1-4-2 Installing a Memory



Before installing a memory module, make sure to turn off the computer and unplug the power cord from the power outlet to prevent damage to the memory module.

DDR3 and DDR2 DIMMs are not compatible to each other or DDR DIMMs. Be sure to install DDR3 DIMMs on this motherboard.

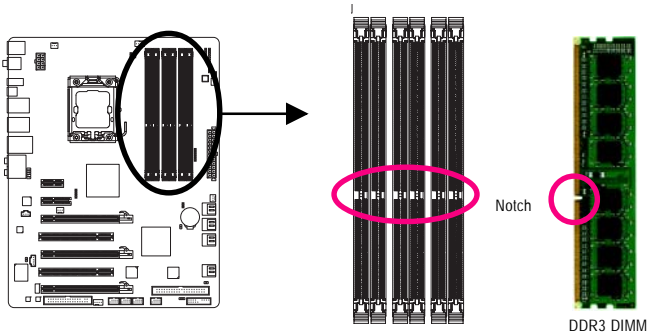

A DDR3 memory module has a notch, so it can only fit in one direction. Follow the steps below to correctly install your memory modules in the memory sockets.



### Step 1:

Note the orientation of the memory module. Spread the retaining clips at both ends of the memory socket. Place the memory module on the socket. As indicated in the picture on the left, place your fingers on the top edge of the memory, push down on the memory and insert it vertically into the memory socket.

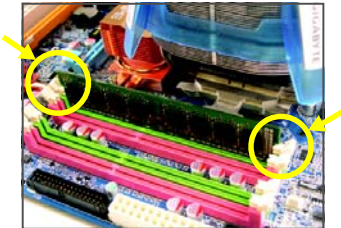

### Step 2:

The clips at both ends of the socket will snap into place when the memory module is securely inserted.

## 1-5 Installing an Expansion Card



Read the following guidelines before you begin to install an expansion card:

- Make sure the motherboard supports the expansion card. Carefully read the manual that came with your expansion card.
- Always turn off the computer and unplug the power cord from the power outlet before installing an expansion card to prevent hardware damage.

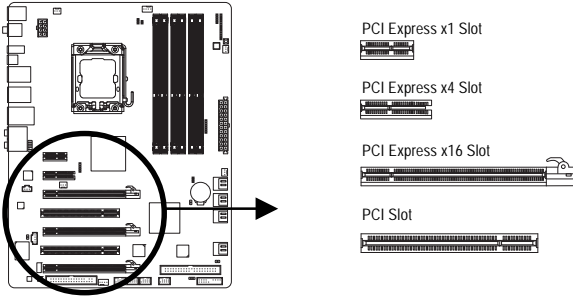

Follow the steps below to correctly install your expansion card in the expansion slot.

1. Locate an expansion slot that supports your card. Remove the metal slot cover from the chassis back panel.
2. Align the card with the slot, and press down on the card until it is fully seated in the slot.
3. Make sure the metal contacts on the card are completely inserted into the slot.
4. Secure the card's metal bracket to the chassis back panel with a screw.
5. After installing all expansion cards, replace the chassis cover(s).
6. Turn on your computer. If necessary, go to BIOS Setup to make any required BIOS changes for your expansion card(s).
7. Install the driver provided with the expansion card in your operating system.

Example: Installing and Removing a PCI Express x16 Graphics Card:



- **Installing a Graphics Card:**  
Gently push down on the top edge of the card until it is fully inserted into the PCI Express slot. Make sure the card is securely seated in the slot and does not rock.



- **Removing the Card:**  
Press the white latch at the end of the PCI Express slot to release the card and then pull the card straight up from the slot.

## 1-6 Setup of NVIDIA SLI (Scalable Link Interface)/ATI CrossFireX Configuration

The SLI and CrossFireX technologies offer blistering graphics performance with the ability to bridge two or three PCI Express™ graphics cards! This section provides instructions on configuring an SLI/ CrossFireX system.

### A. Before You Begin

#### 1. Power Requirements:

Before installation, assure that the power supply you use is able to provide sufficient power to fully support an SLI/CrossFireX configuration and other components in your system. We recommend a power supply that provides at least 20A 5V and 12V current and a minimum of 600W (a 3-Way SLI/ CrossFireX platform requires minimum 1000W peak power). Note that the exact power requirements will depend on your overall system configurations.

#### 2. Supported Operation Systems:

Windows XP and Windows Vista operating systems are currently supported by the 2-Way SLI and 2-Way CrossFireX technologies.

Only Windows Vista operating systems are currently supported by the 3-Way SLI and 3-Way CrossFireX technologies.

#### 3. Installation Notices:

- 3-1 If you want to set up a single graphics card system, we recommend installing the graphics card on the PCIEX16\_1 slot.
- 3-2 To set up a 2-Way configuration, we recommend installing the graphics cards on the PCIEX16\_1 and PCIEX16\_2 slots. (Using graphics cards of identical brand and chips is recommended.)
- 3-3 To set up a 3-Way SLI configuration (Figure 1) or a 3-Way CrossFireX configuration (Figure 2), be sure to use three identical graphics cards based on the following GPUs and a power supply of at least 1000W. Current NVIDIA GPUs that support 3-Way SLI technology include the 8800 GTX, 8800 Ultra, 9800 GTX, GTX 260 and GTX 280. Current ATI GPUs that support 3-Way CrossFireX technology include the Radeon HD 3800 series and Radeon HD 4800 series.



Figure 1

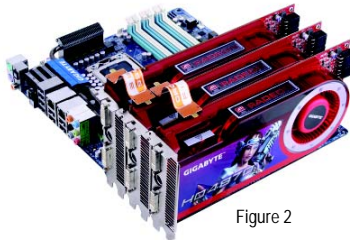

Figure 2

(Note) To set up a 3-Way CrossFireX configuration, install the bridge connector (optional) shown in Figure 2.

## B. Connecting Three Graphics Cards:

(The procedure below demonstrates how to set up a 3-Way SLI system)



For 3-Way SLI System



### Step 1:

Observe the steps in "1-5 Installing an Expansion Card" and install three SLI-ready graphics cards of the same model on the PCIEX16\_1, PCIEX16\_2 and PCIEX8\_1 slots. Then, insert the SLI bridge in the SLI gold edge connectors on top of the three cards. Make sure the mini female slots on the bridge connector securely fit onto the SLI gold edge connectors of three cards.

Female slots on the bridge connector

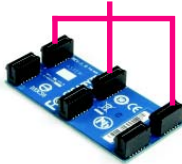

Gold edge connector on the top of the graphics card



### Step 2:

Connect power cables to the three graphics cards.

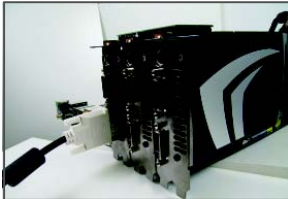

### Step 3:

Plug the display cable into the graphics card on the PCIEX16\_1 slot.

(Note) To set up a 2-Way SLI system, insert the bridge into the SLI gold edge connectors on top of the two graphics cards.

## C. Configuring the Graphics Card Driver:

### C-1 To enable SLI function

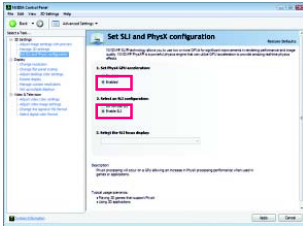

#### For 2-Way/3-Way SLI:

After installing graphics card driver in the operating system, go to the **NVIDIA Control Panel**. Browse to the **SLI and PhysX configuration** screen. Ensure SLI configuration and PhysX are enabled.

### C-2 To enable CrossFireX function

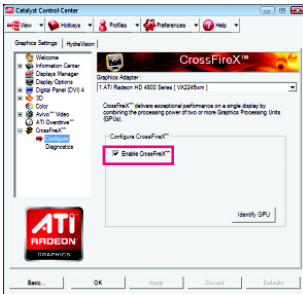

#### For 2-Way CrossFireX:

After installing graphics card driver in the operating system, go to the **Catalyst Control Center**. Browse to the **CrossFireX** screen and select the **Enable CrossFireX** check box to complete the configuration.

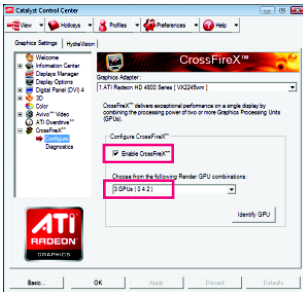

#### For 3-Way CrossFireX:

Browse to the **CrossFireX** screen and select the **Enable CrossFireX** check box and also select **3 GPUS** for the GPU combination.

(Note) Procedure for enabling SLI/CrossFireX technology may slightly differ by graphics cards. Refer to the manual that came with your graphics cards for more information about enabling SLI/CrossFireX technology.

# 1-7 Installing the SATA Bracket

The SATA bracket allows you to connect external SATA device(s) to your system by expanding the internal SATA port(s) to the chassis back panel.



- Turn off your system and the power switch on the power supply before installing or removing the SATA bracket and SATA power cable to prevent damage to hardware.
- Insert the SATA signal cable and SATA power cable securely into the corresponding connectors when installing.

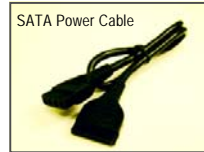
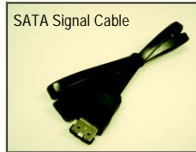
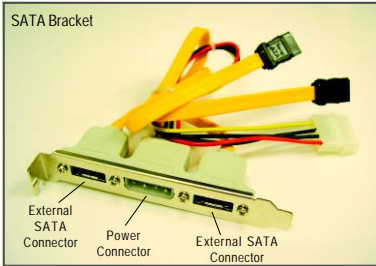

The SATA bracket includes one SATA bracket, one SATA signal cable, and one SATA power cable.

Follow the steps below to install the SATA bracket:

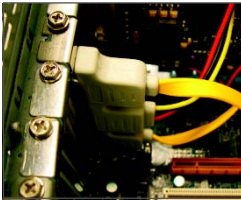

**Step 1:** Locate one free PCI slot and secure the SATA bracket to the chassis back panel with a screw.



**Step 2:** Connect the SATA cable from the bracket to the SATA port on your motherboard.

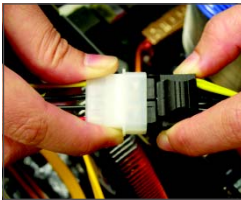

**Step 3:** Connect the power cable from the bracket to the power supply.



**Step 4:** Plug one end of the SATA signal cable into the external SATA connector on the bracket. Then attach the SATA power cable to the power connector on the bracket.



**Step 5:** Connect the other ends of the SATA signal cable and SATA power cable to your SATA device. For SATA device in external enclosure, you only need to connect the SATA signal cable. Before connecting the SATA signal cable, make sure to turn off the power of the external enclosure.

# 1-8 Back Panel Connectors

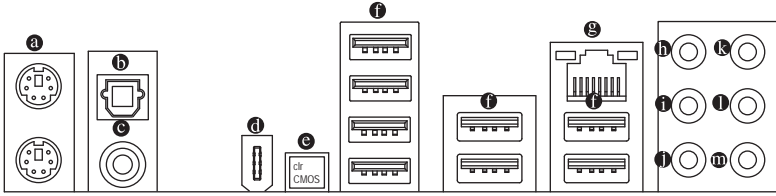

**a PS/2 Keyboard and PS/2 Mouse Port**

Use the upper port (green) to connect a PS/2 mouse and the lower port (purple) to connect a PS/2 keyboard.

**b Optical S/PDIF Out Connector**

This connector provides digital audio out to an external audio system that supports digital optical audio. Before using this feature, ensure that your audio system provides an optical digital audio in connector.

**c Coaxial S/PDIF Out Connector**

This connector provides digital audio out to an external audio system that supports digital coaxial audio. Before using this feature, ensure that your audio system provides a coaxial digital audio in connector.

**d IEEE 1394a Port**

The IEEE 1394 port supports the IEEE 1394a specification, featuring high speed, high bandwidth and hotplug capabilities. Use this port for an IEEE 1394a device.

**e Clearing CMOS Switch**

Press the clearing CMOS switch to clear CMOS values.

**f USB Port**

The USB port supports the USB 2.0/1.1 specification. Use this port for USB devices such as an USB keyboard/mouse, USB printer, USB flash drive and etc.

**g RJ-45 LAN Port**

The Gigabit Ethernet LAN port provides Internet connection at up to 1 Gbps data rate. The following describes the states of the LAN port LEDs.

Connection/  
Speed LED

Activity LED



LAN Port

Connection/Speed LED:

State	Description
Orange	1 Gbps data rate
Green	100 Mbps data rate
Off	10 Mbps data rate

Activity LED:

State	Description
Blinking	Data transmission or receiving is occurring
Off	No data transmission or receiving is occurring



- When removing the cable connected to a back panel connector, first remove the cable from your device and then remove it from the motherboard.
- When removing the cable, pull it straight out from the connector. Do not rock it side to side to prevent an electrical short inside the cable connector.

① **Center/Subwoofer Speaker Out Jack (Orange)**

Use this audio jack to connect center/subwoofer speakers in a 5.1/7.1-channel audio configuration.

② **Rear Speaker Out Jack (Black)**

Use this audio jack to connect rear speakers in a 4/5.1/7.1-channel audio configuration.

③ **Side Speaker Out Jack (Gray)**

Use this audio jack to connect side speakers in a 7.1-channel audio configuration.

④ **Line In Jack (Blue)**

The default line in jack. Use this audio jack for line in devices such as an optical drive, walkman, etc.

⑤ **Line Out Jack (Green)**

The default line out jack. Use this audio jack for a headphone or 2-channel speaker. This jack can be used to connect front speakers in a 4/5.1/7.1-channel audio configuration.

⑥ **Mic In Jack (Pink)**

The default Mic in jack. Microphones must be connected to this jack.



In addition to the default speakers settings, the ① ~ ⑥ audio jacks can be reconfigured to perform different functions via the audio software. Only microphones still **MUST** be connected to the default Mic in jack (⑥). Refer to the instructions on setting up a 2/4/5.1/7.1-channel audio configuration in Chapter 5, "Configuring 2/4/5.1/7.1-Channel Audio."



# 1-9 Onboard LEDs and Switches

## Overvoltage LEDs

This motherboard contains 4 sets of overvoltage LEDs which indicate the overvoltage level of the CPU, memory, North Bridge, and South Bridge.

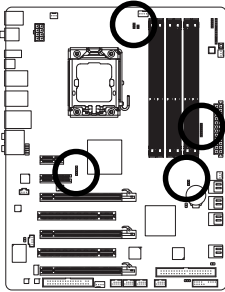

### CPU (CPU Voltage)

- Off: Normal condition
- L1: Level 1 (Slight, green)
- L2: Level 2 (Moderate, yellow)
- L3: Level 3 (High, red)

### Memory (DDR Voltage)

- Off: Normal condition
- L1: Level 1 (Slight, green)
- L2: Level 2 (Moderate, yellow)
- L3: Level 3 (High, red)

### North Bridge (NB Voltage)

- Off: Normal condition
- L1: Level 1 (Slight, green)
- L2: Level 2 (Moderate, yellow)
- L3: Level 3 (High, red)

### South Bridge (SB Voltage)

- Off: Normal condition
- L1: Level 1 (Slight, green)
- L2: Level 2 (Moderate, yellow)
- L3: Level 3 (High, red)

## Overclock LEDs

The onboard CPU overclock LEDs indicate on which level the CPU is overclocked. The higher the overclock level, the more the number of lighted LEDs.

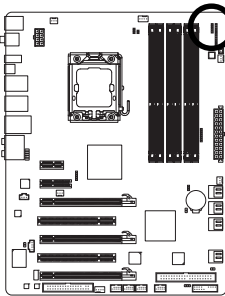

### CPU (FREQUENCY LED)

- Off: Normal condition
- F\_LED1-F\_LED5 : Blue

## Temperature Indicator LEDs

The two sets of temperature indicator LEDs indicate the temperature level of the CPU and North Bridge. The LEDs are off when the temperature is below 60°C; the green LED lights up when the temperature is between 61-80°C; the red LED is illuminated when the temperature exceeds 80°C.

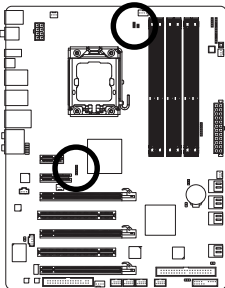

### CPU (CPU Temp)

- Off: Below 60°C
- L1: 61-80°C (green)
- L2: Over 80°C (red)

### North Bridge (NB Temp)

- Off: Below 60°C
- L1: 61-80°C (green)
- L2: Over 80°C (red)

## Quick Switches

This motherboard has 3 quick switches: power switch, reset switch and clearing CMOS switch, allowing users to quickly turn on/off or reset the system or clear the CMOS values.

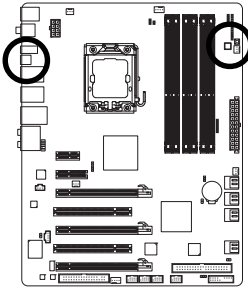

- PW\_SW: Power switch
- RST\_SW: Reset switch
- CMOS\_SW: Clearing CMOS switch

# 1-10 Internal Connectors

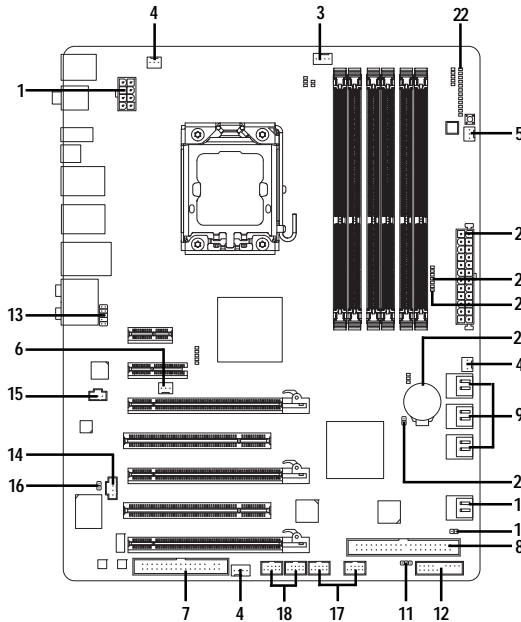

1)	ATX_12V_2X	13)	F_AUDIO
2)	ATX	14)	CD_IN
3)	CPU_FAN	15)	SPDIF_I
4)	SYS_FAN1/2/3	16)	SPDIF_O
5)	PWR_FAN	17)	F_USB1/F_USB2
6)	NB_FAN	18)	F1_1394/F2_1394
7)	FDD	19)	CI
8)	IDE	20)	CLR_CMOS
9)	SATA2_0/1/2/3/4/5	21)	BAT
10)	GSATA2_0/1	22)	PHASE_LED
11)	PWR_LED	23)	NB PHASE LED
12)	F_PANEL	24)	DDR PHASE LED



Read the following guidelines before connecting external devices:

- First make sure your devices are compliant with the connectors you wish to connect.
- Before installing the devices, be sure to turn off the devices and your computer. Unplug the power cord from the power outlet to prevent damage to the devices.
- After installing the device and before turning on the computer, make sure the device cable has been securely attached to the connector on the motherboard.

## 1/2) ATX\_12V\_2X/ATX (2x4 12V Power Connector and 2x12 Main Power Connector)

With the use of the power connector, the power supply can supply enough stable power to all the components on the motherboard. Before connecting the power connector, first make sure the power supply is turned off and all devices are properly installed. The power connector possesses a foolproof design. Connect the power supply cable to the power connector in the correct orientation. The 12V power connector mainly supplies power to the CPU. If the 12V power connector is not connected, the computer will not start.



- Use of a power supply providing a 2x4 12V power connector is recommended by the CPU manufacturer when using an Intel Extreme Edition CPU (130W).
- To meet expansion requirements, it is recommended that a power supply that can withstand high power consumption be used (500W or greater). If a power supply is used that does not provide the required power, the result can lead to an unstable or unbootable system.
- The power connectors are compatible with power supplies with 2x2 12V and 2x10 power connectors. When using a power supply providing a 2x4 12V and a 2x12 power connector, remove the protective covers from the 12V power connector and the main power connector on the motherboard. Do not insert the power supply cables into pins under the protective covers when using a power supply providing a 2x2 12V and a 2x10 power connector.

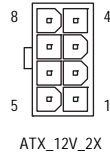
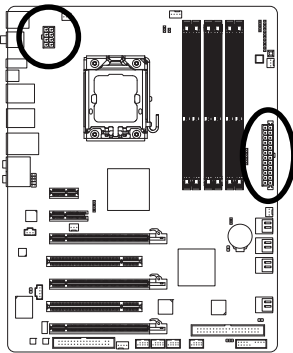

ATX\_12V\_2X:

Pin No.	Definition
1	GND (Only for 2x4 pin 12V)
2	GND (Only for 2x4 pin 12V)
3	GND
4	GND
5	+12V (Only for 2x4 pin 12V)
6	+12V (Only for 2x4 pin 12V)
7	+12V
8	+12V

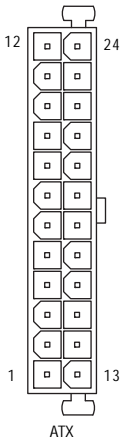

ATX:

Pin No.	Definition	Pin No.	Definition
1	3.3V	13	3.3V
2	3.3V	14	-12V
3	GND	15	GND
4	+5V	16	PS_ON(soft On/Off)
5	GND	17	GND
6	+5V	18	GND
7	GND	19	GND
8	Power Good	20	-5V
9	5V SB(stand by +5V)	21	+5V
10	+12V	22	+5V
11	+12V (Only for 2x12 pin ATX)	23	+5V (Only for 2x12 pin ATX)
12	3.3V (Only for 2x12 pin ATX)	24	GND (Only for 2x12 pin ATX)

### 3/4/5) CPU\_FAN / SYS\_FAN1 / SYS\_FAN2 / SYS\_FAN3 / PWR\_FAN (Fan Headers)

The motherboard has a 4-pin CPU fan header (CPU\_FAN), a 4-pin (SYS\_FAN2) and two 3-pin (SYS\_FAN1/SYS\_FAN3) system fan headers, and a 3-pin power fan header (PWR\_FAN). Most fan headers possess a foolproof insertion design. When connecting a fan cable, be sure to connect it in the correct orientation (the black connector wire is the ground wire). The motherboard supports CPU fan speed control, which requires the use of a CPU fan with fan speed control design. For optimum heat dissipation, it is recommended that a system fan be installed inside the chassis.

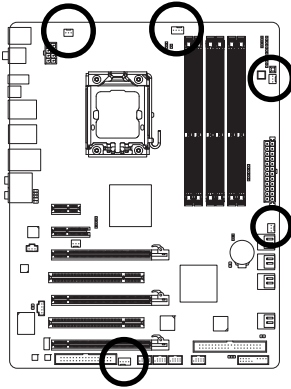

CPU\_FAN



SYS\_FAN2



SYS\_FAN3



SYS\_FAN1/  
PWR\_FAN

CPU\_FAN:

Pin No.	Definition
1	GND
2	+12V / Speed Control
3	Sense
4	Speed Control

SYS\_FAN2:

Pin No.	Definition
1	GND
2	+12V / Speed Control
3	Sense
4	Reserve

SYS\_FAN1/SYS\_FAN3/PWR\_FAN:

Pin No.	Definition
1	GND
2	+12V
3	Sense

### 6) NB\_FAN (North Bridge Fan Header)

Connect the North Bridge fan cable to this header. The fan header has a foolproof insertion design. When connecting a fan cable, be sure to connect it in the correct orientation. Most fans are designed with color-coded power connector wires. A red power connector wire indicates a positive connection and requires a +12V voltage. The black connector wire is the ground wire.

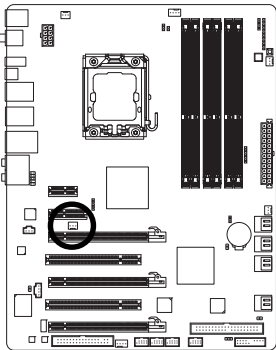

Pin No.	Definition
1	GND
2	+12V
3	NC



- Be sure to connect fan cables to the fan headers to prevent your CPU, North Bridge and system from overheating. Overheating may result in damage to the CPU/North Bridge or the system may hang.
- These fan headers are not configuration jumper blocks. Do not place a jumper cap on the headers.

### 7) FDD (Floppy Disk Drive Connector)

This connector is used to connect a floppy disk drive. The types of floppy disk drives supported are: 360 KB, 720 KB, 1.2 MB, 1.44 MB, and 2.88 MB. Before connecting a floppy disk drive, be sure to locate pin 1 of the connector and the floppy disk drive cable. The pin 1 of the cable is typically designated by a stripe of different color.

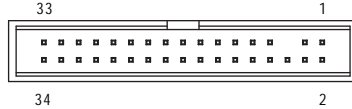
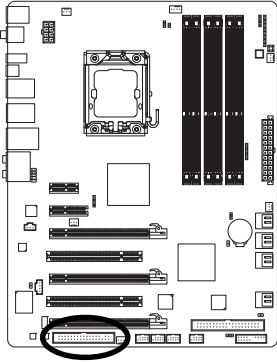

### 8) IDE (IDE Connector)

The IDE connector supports up to two IDE devices such as hard drives and optical drives. Before attaching the IDE cable, locate the foolproof groove on the connector. If you wish to connect two IDE devices, remember to set the jumpers and the cabling according to the role of the IDE devices (for example, master or slave). (For information about configuring master/slave settings for the IDE devices, read the instructions from the device manufacturers.)

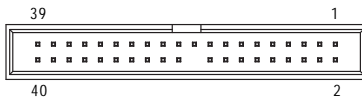
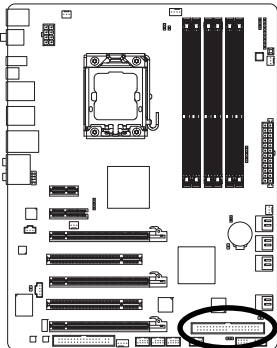

**9) SATA\_0/1/2/3/4/5 (SATA 3Gb/s Connectors, Controlled by ICH10R, Blue)**

The SATA connectors conform to SATA 3Gb/s standard and are compatible with SATA 1.5Gb/s standard. Each SATA connector supports a single SATA device. The ICH10R controller supports RAID 0, RAID 1, RAID 5 and RAID 10. Refer to Chapter 5, "Configuring SATA Hard Drive(s)," for instructions on configuring a RAID array.

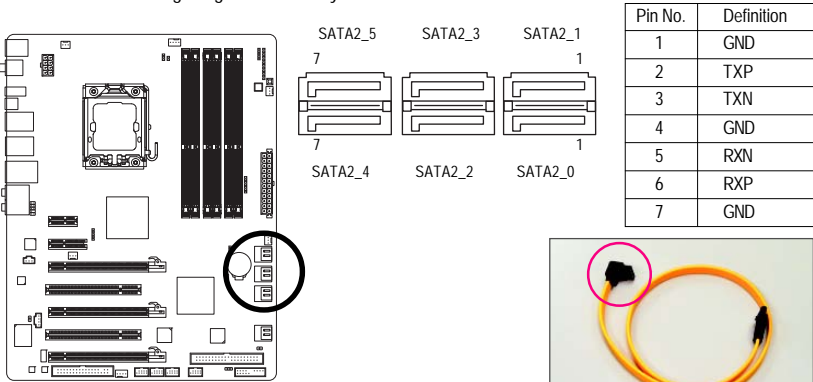

Please connect the L-shaped end of the SATA 3Gb/s cable to your SATA hard drive.



- A RAID 0 or RAID 1 configuration requires at least two hard drives. If more than two hard drives are to be used, the total number of hard drives must be an even number.
- A RAID 5 configuration requires at least three hard drives. (The total number of hard drives does not have to be an even number.)
- A RAID 10 configuration requires at least four hard drives and the total number of hard drives must be an even number.

### 10) GSATA2\_0/1 (SATA 3Gb/s Connectors, Controlled by GIGABYTE SATA2, White)

The SATA connectors conform to SATA 3Gb/s standard and are compatible with SATA 1.5Gb/s standard. Each SATA connector supports a single SATA device. The GIGABYTE SATA2 controller supports RAID 0, RAID 1 and JBOD. Refer to Chapter 5, "Configuring SATA Hard Drive(s)," for instructions on configuring a RAID array.

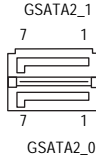
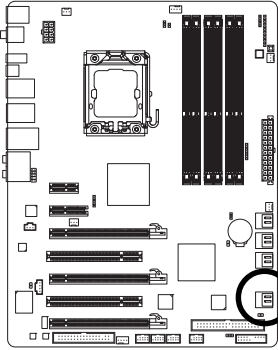

Pin No.	Definition
1	GND
2	TXP
3	TXN
4	GND
5	RXN
6	RXP
7	GND

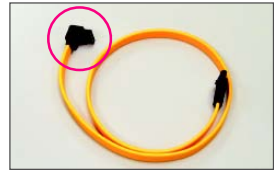

Please connect the L-shaped end of the SATA3Gb/s cable to your SATA hard drive.



A RAID 0 or RAID 1 configuration requires at least two hard drives.

### 11) PWR\_LED (System Power LED Header)

This header can be used to connect a system power LED on the chassis to indicate system power status. The LED is on when the system is operating. The LED keeps blinking when the system is in S1 sleep state. The LED is off when the system is in S3/S4 sleep state or powered off (S5).

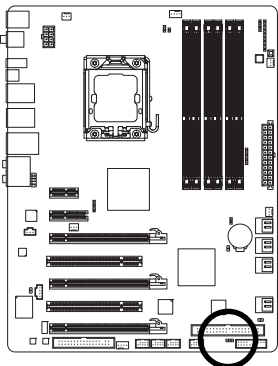

Pin No.	Definition
1	MPD+
2	MPD-
3	MPD-

System Status	LED
S0	On
S1	Blinking
S3/S4/S5	Off



## 12) F\_PANEL (Front Panel Header)

Connect the power switch, reset switch, speaker and system status indicator on the chassis front panel to this header according to the pin assignments below. Note the positive and negative pins before connecting the cables.

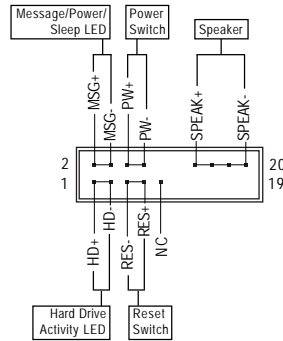
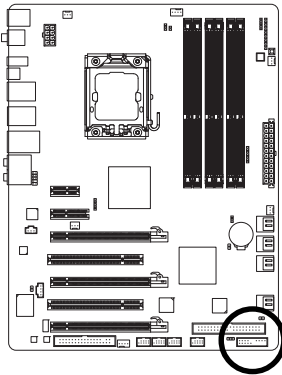

- MSG (Message/Power/Sleep LED, Yellow):

System Status	LED
S0	On
S1	Blinking
S3/S4/S5	Off

Connects to the power status indicator on the chassis front panel. The LED is on when the system is operating. The LED keeps blinking when the system is in S1 sleep state. The LED is off when the system is in S3/S4 sleep state or powered off (S5).

- PW (Power Switch, Red):  
Connects to the power switch on the chassis front panel. You may configure the way to turn off your system using the power switch (refer to Chapter 2, "BIOS Setup," "Power Management Setup," for more information).
- SPEAK (Speaker, Orange):  
Connects to the speaker on the chassis front panel. The system reports system startup status by issuing a beep code. One single short beep will be heard if no problem is detected at system startup. If a problem is detected, the BIOS may issue beeps in different patterns to indicate the problem. Refer to Chapter 5, "Troubleshooting," for information about beep codes.
- HD (Hard Drive Activity LED, Blue)  
Connects to the hard drive activity LED on the chassis front panel. The LED is on when the hard drive is reading or writing data.
- RES (Reset Switch, Green):  
Connects to the reset switch on the chassis front panel. Press the reset switch to restart the computer if the computer freezes and fails to perform a normal restart.
- NC (Purple):  
No connection



The front panel design may differ by chassis. A front panel module mainly consists of power switch, reset switch, power LED, hard drive activity LED, speaker and etc. When connecting your chassis front panel module to this header, make sure the wire assignments and the pin assignments are matched correctly.

### 13) F\_AUDIO (Front Panel Audio Header)

The front panel audio header supports Intel High Definition audio (HD) and AC'97 audio. You may connect your chassis front panel audio module to this header. Make sure the wire assignments of the module connector match the pin assignments of the motherboard header. Incorrect connection between the module connector and the motherboard header will make the device unable to work or even damage it.

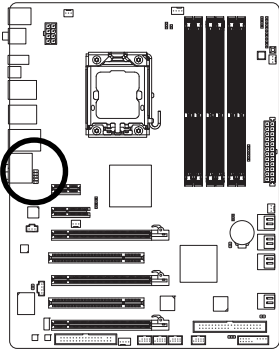

For HD Front Panel Audio:

Pin No.	Definition
1	MIC2_L
2	GND
3	MIC2_R
4	-ACZ_DET
5	LINE2_R
6	GND
7	AUDIO_JD
8	No Pin
9	LINE2_L
10	GND

For AC'97 Front Panel Audio:

Pin No.	Definition
1	MIC
2	GND
3	MIC Power
4	NC
5	Line Out (R)
6	NC
7	NC
8	No Pin
9	Line Out (L)
10	NC



- The front panel audio header supports HD audio by default. If your chassis provides an AC'97 front panel audio module, refer to the instructions on how to activate AC'97 functionality via the audio software in Chapter 5, "Configuring 2/4/5.1/7.1-Channel Audio."
- Audio signals will be present on both of the front and back panel audio connections simultaneously. If you want to mute the back panel audio (only supported when using an HD front panel audio module), refer to Chapter 5, "Configuring 2/4/5.1/7.1-Channel Audio."
- Some chassis provide a front panel audio module that has separated connectors on each wire instead of a single plug. For information about connecting the front panel audio module that has different wire assignments, please contact the chassis manufacturer.

### 14) CD\_IN (CD In Connector, Black)

You may connect the audio cable that came with your optical drive to the header.

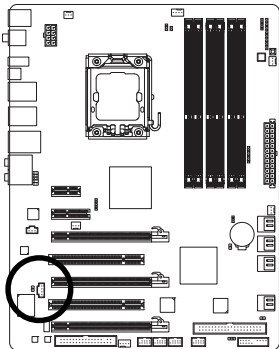

Pin No.	Definition
1	CD-L
2	GND
3	GND
4	CD-R

### 15) SPDIF\_I (S/PDIF In Header, Red)

This header supports digital S/PDIF in and can connect to an audio device that supports digital audio out via an optional S/PDIF in cable. For purchasing the optional S/PDIF in cable, please contact the local dealer.

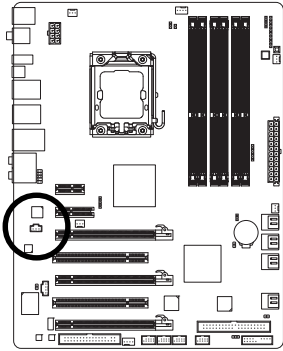

Pin No.	Definition
1	Power
2	SPDIFI
3	GND

### 16) SPDIF\_O (S/PDIF Out Header)

This header supports digital S/PDIF out and connects a S/PDIF digital audio cable (provided by expansion cards) for digital audio output from your motherboard to certain expansion cards like graphics cards and sound cards. For example, some graphics cards may require you to use a S/PDIF digital audio cable for digital audio output from your motherboard to your graphics card if you wish to connect an HDMI display to the graphics card and have digital audio output from the HDMI display at the same time. For information about connecting the S/PDIF digital audio cable, carefully read the manual for your expansion card.

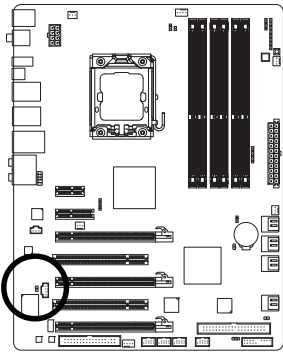

Pin No.	Definition
1	SPDIFO
2	GND

### 17) F\_USB1/F\_USB2 (USB Headers, Yellow)

The headers conform to USB 2.0/1.1 specification. Each USB header can provide two USB ports via an optional USB bracket. For purchasing the optional USB bracket, please contact the local dealer.

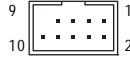
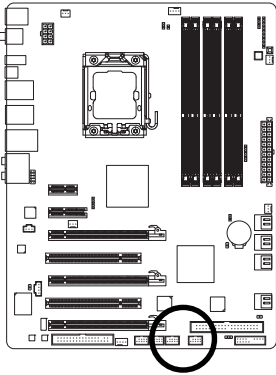

Pin No.	Definition
1	Power (5V)
2	Power (5V)
3	USB DX-
4	USB DY-
5	USB DX+
6	USB DY+
7	GND
8	GND
9	No Pin
10	NC



- Do not plug the IEEE 1394 bracket (2x5-pin) cable into the USB header.
- Prior to installing the USB bracket, be sure to turn off your computer and unplug the power cord from the power outlet to prevent damage to the USB bracket.

### 18) F1\_1394/F2\_1394 (IEEE 1394a Headers, Gray)

The headers conform to IEEE 1394a specification. Each IEEE 1394a header can provide one IEEE 1394a port via an optional IEEE 1394a bracket. For purchasing the additional IEEE 1394a bracket(s), please contact the local dealer.

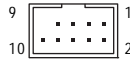
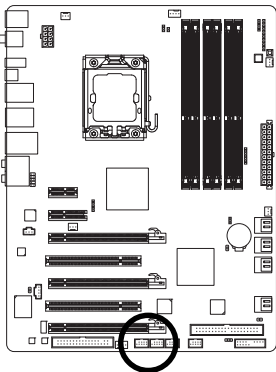

Pin No.	Definition
1	TPA+
2	TPA-
3	GND
4	GND
5	TPB+
6	TPB-
7	Power (12V)
8	Power (12V)
9	No Pin
10	GND



- Do not plug the USB bracket cable into the IEEE 1394a header.
- Prior to installing the IEEE 1394a bracket, be sure to turn off your computer and unplug the power cord from the power outlet to prevent damage to the IEEE 1394a bracket.
- To connect an IEEE 1394a device, attach one end of the device cable to your computer and then attach the other end of the cable to the IEEE 1394a device. Ensure that the cable is securely connected.

## 19) CI (Chassis Intrusion Header)

This motherboard provides a chassis detection feature that detects if the chassis cover has been removed. This function requires a chassis with chassis intrusion detection design.

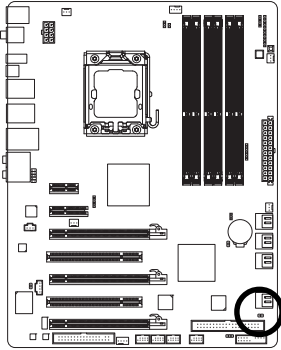

 1

Pin No.	Definition
1	Signal
2	GND

## 20) CLR\_CMOS (Clearing CMOS Jumper)

Use this jumper to clear the CMOS values (e.g. date information and BIOS configurations) and reset the CMOS values to factory defaults. To clear the CMOS values, place a jumper cap on the two pins to temporarily short the two pins or use a metal object like a screwdriver to touch the two pins for a few seconds.

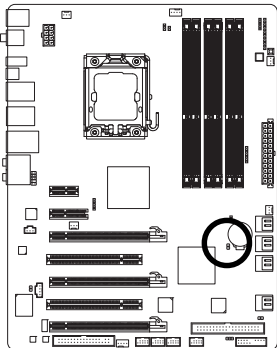

 Open: Normal

 Short: Clear CMOS Values



- Always turn off your computer and unplug the power cord from the power outlet before clearing the CMOS values.
- After clearing the CMOS values and before turning on your computer, be sure to remove the jumper cap from the jumper. Failure to do so may cause damage to the motherboard.
- After system restart, go to BIOS Setup to load factory defaults (select **Load Optimized Defaults**) or manually configure the BIOS settings (refer to Chapter 2, "BIOS Setup," for BIOS configurations).

## 21) BAT (BATTERY)

The battery provides power to keep the values (such as BIOS configurations, date, and time information) in the CMOS when the computer is turned off. Replace the battery when the battery voltage drops to a low level, or the CMOS values may not be accurate or may be lost.

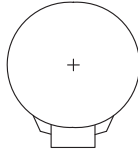
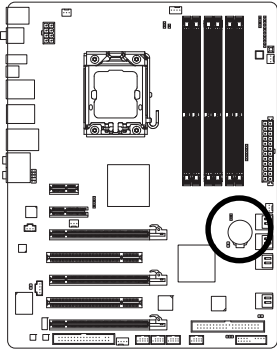

You may clear the CMOS values by removing the battery:

1. Turn off your computer and unplug the power cord.
2. Gently remove the battery from the battery holder and wait for one minute.  
(Or use a metal object like a screwdriver to touch the positive and negative terminals of the battery holder, making them short for 5 seconds.)
3. Replace the battery.
4. Plug in the power cord and restart your computer.



- Always turn off your computer and unplug the power cord before replacing the battery.
- Replace the battery with an equivalent one. Danger of explosion if the battery is replaced with an incorrect model.
- Contact the place of purchase or local dealer if you are not able to replace the battery by yourself or uncertain about the battery model.
- When installing the battery, note the orientation of the positive side (+) and the negative side (-) of the battery (the positive side should face up).
- Used batteries must be handled in accordance with local environmental regulations.

## 22) PHASE LED

The number of lighted LEDs indicates the CPU loading. The higher the CPU loading, the more the number of lighted LEDs. To enable the Phase LED display function, please first enable Dynamic Energy Saver Advanced. Refer to Chapter 4, "Dynamic Energy Saver Advanced," for more details.

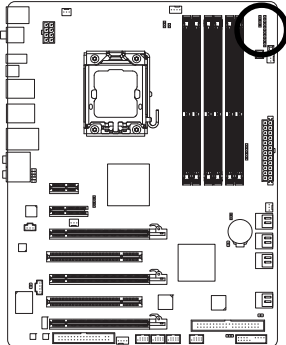

### 23) NB PHASE LED

The number of lighted LEDs indicates the North Bridge loading. The higher the North Bridge loading, the more the number of lighted LEDs.

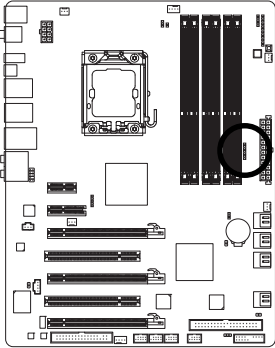

### 24) DDR PHASE LED

The number of lighted LEDs indicates the memory loading. The higher the memory loading, the more the number of lighted LEDs.

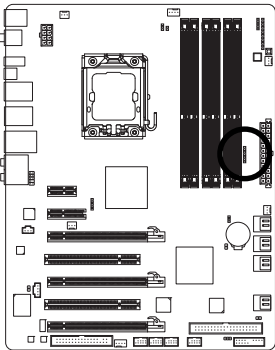





## Chapter 2 BIOS Setup

BIOS (Basic Input and Output System) records hardware parameters of the system in the CMOS on the motherboard. Its major functions include conducting the Power-On Self-Test (POST) during system startup, saving system parameters and loading operating system, etc. BIOS includes a BIOS Setup program that allows the user to modify basic system configuration settings or to activate certain system features. When the power is turned off, the battery on the motherboard supplies the necessary power to the CMOS to keep the configuration values in the CMOS.

To access the BIOS Setup program, press the <Delete> key during the POST when the power is turned on. To see more advanced BIOS Setup menu options, you can press <Ctrl> + <F1> in the main menu of the BIOS Setup program.

To upgrade the BIOS, use either the GIGABYTE Q-Flash or @BIOS utility.

- Q-Flash allows the user to quickly and easily upgrade or back up BIOS without entering the operating system.
- @BIOS is a Windows-based utility that searches and downloads the latest version of BIOS from the Internet and updates the BIOS.

For instructions on using the Q-Flash and @BIOS utilities, refer to Chapter 4, "BIOS Update Utilities."



- Because BIOS flashing is potentially risky, if you do not encounter problems using the current version of BIOS, it is recommended that you not flash the BIOS. To flash the BIOS, do it with caution. Inadequate BIOS flashing may result in system malfunction.
- BIOS will emit a beep code during the POST. Refer to Chapter 5, "Troubleshooting," for the beep codes description.
- It is recommended that you not alter the default settings (unless you need to) to prevent system instability or other unexpected results. Inadequately altering the settings may result in system's failure to boot. If this occurs, try to clear the CMOS values and reset the board to default values. (Refer to the "Load Optimized Defaults" section in this chapter or introductions of the battery/clearing CMOS jumper in Chapter 1 for how to clear the CMOS values.)

## 2-1 Startup Screen

The following screens may appear when the computer boots.

### A. The LOGO Screen (Default)



Function Keys

### B. The POST Screen

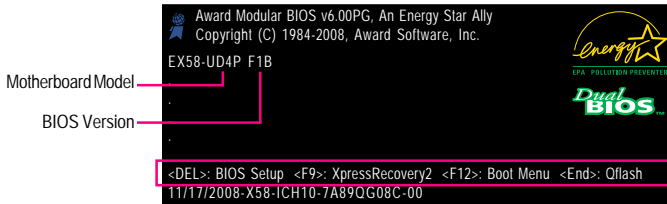

Motherboard Model

BIOS Version

Function Keys

### Function Keys:

#### <TAB>: POST SCREEN

Press the <Tab> key to show the BIOS POST screen. To show the BIOS POST screen at system startup, refer to the instructions on the **Full Screen LOGO Show** item on page 58.

#### <DEL>: BIOS SETUP/Q-FLASH

Press the <Delete> key to enter BIOS Setup or to access the Q-Flash utility in BIOS Setup.

#### <F9>: XPRESS RECOVERY2

If you have ever entered Xpress Recovery2 to back up hard drive data using the driver disk, the <F9> key can be used for subsequent access to XpressRecovery2 during the POST. For more information, refer to Chapter 4, "Xpress Recovery2."

#### <F12>: BOOT MENU

Boot Menu allows you to set the first boot device without entering BIOS Setup. In Boot Menu, use the up arrow key <↑> or the down arrow key <↓> to select the first boot device, then press <Enter> to accept. To exit Boot Menu, press <Esc>. The system will directly boot from the device configured in Boot Menu. Note: The setting in Boot Menu is effective for one time only. After system restart, the device boot order will still be based on BIOS Setup settings. You can access Boot Menu again to change the first boot device setting as needed.

#### <End>: Q-FLASH

Press the <End> key to access the Q-Flash utility directly without having to enter BIOS Setup first.

## 2-2 The Main Menu

Once you enter the BIOS Setup program, the Main Menu (as shown below) appears on the screen. Use arrow keys to move among the items and press <Enter> to accept or enter a sub-menu.

(Sample BIOS Version: F1B)

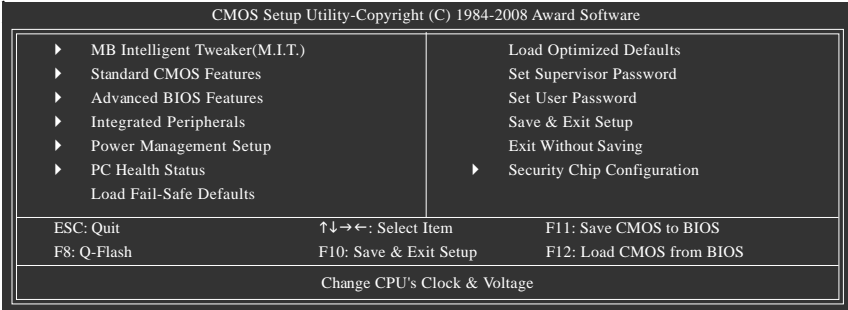

### BIOS Setup Program Function Keys

<↑><↓><←><→>	Move the selection bar to select an item
<Enter>	Execute command or enter the submenu
<Esc>	Main Menu: Exit the BIOS Setup program Submenus: Exit current submenu
<Page Up>	Increase the numeric value or make changes
<Page Down>	Decrease the numeric value or make changes
<F1>	Show descriptions of the function keys
<F2>	Move cursor to the Item Help block on the right (submenu only)
<F5>	Restore the previous BIOS settings for the current submenu
<F6>	Load the Fail-Safe BIOS default settings for the current submenu
<F7>	Load the Optimized BIOS default settings for the current submenu
<F8>	Access the Q-Flash utility
<F9>	Display system information
<F10>	Save all the changes and exit the BIOS Setup program
<F11>	Save CMOS to BIOS
<F12>	Load CMOS from BIOS

### Main Menu Help

The onscreen description of a highlighted setup option is displayed on the bottom line of the Main Menu.

### Submenu Help

While in a submenu, press <F1> to display a help screen (General Help) of function keys available for the menu. Press <Esc> to exit the help screen. Help for each item is in the Item Help block on the right side of the submenu.



NOTE

- If you do not find the settings you want in the Main Menu or a submenu, press <Ctrl>+<F1> to access more advanced options.
- When the system is not stable as usual, select the **Load Optimized Defaults** item to set your system to its defaults.
- The BIOS Setup menus described in this chapter are for reference only and may differ by BIOS version.

## ■ The Functions of the <F11> and <F12> keys (For the Main Menu Only)

### ▶ F11 : Save CMOS to BIOS

This function allows you to save the current BIOS settings to a profile. You can create up to 8 profiles (Profile 1-8) and name each profile. First enter the profile name (to erase the default profile name, use the SPACE key) and then press <Enter> to complete.

### ▶ F12 : Load CMOS from BIOS

If your system becomes unstable and you have loaded the BIOS default settings, you can use this function to load the BIOS settings from a profile created before, without the hassles of reconfiguring the BIOS settings. First select the profile you wish to load, then press <Enter> to complete.

## ■ MB Intelligent Tweaker(M.I.T.)

Use this menu to configure the clock, frequency and voltages of your CPU, memory, etc.

## ■ Standard CMOS Features

Use this menu to configure the system time and date, hard drive types, floppy disk drive types, and the type of errors that stop the system boot, etc.

## ■ Advanced BIOS Features

Use this menu to configure the device boot order, advanced features available on the CPU, and the primary display adapter.

## ■ Integrated Peripherals

Use this menu to configure all peripheral devices, such as IDE, SATA, USB, integrated audio, and integrated LAN, etc.

## ■ Power Management Setup

Use this menu to configure all the power-saving functions.

## ■ PC Health Status

Use this menu to see information about autodetected system/CPU temperature, system voltage and fan speed, etc.

## ■ Load Fail-Safe Defaults

Fail-Safe defaults are factory settings for the most stable, minimal-performance system operations.

## ■ Load Optimized Defaults

Optimized defaults are factory settings for optimal-performance system operations.

## ■ Set Supervisor Password

Change, set, or disable password. It allows you to restrict access to the system and BIOS Setup. A supervisor password allows you to make changes in BIOS Setup.

## ■ Set User Password

Change, set, or disable password. It allows you to restrict access to the system and BIOS Setup. An user password only allows you to view the BIOS settings but not to make changes.

## ■ Save & Exit Setup

Save all the changes made in the BIOS Setup program to the CMOS and exit BIOS Setup. (Pressing <F10> can also carry out this task.)

## ■ Exit Without Saving

Abandon all changes and the previous settings remain in effect. Pressing <Y> to the confirmation message will exit BIOS Setup. (Pressing <Esc> can also carry out this task.)

## ■ Security Chip Configuration

Use this menu to configure the TPM function.

## 2-3 MB Intelligent Tweaker(M.I.T.)

CMOS Setup Utility-Copyright (C) 1984-2008 Award Software  
MB Intelligent Tweaker(M.I.T.)

CPU Clock Ratio <sup>(Note 1)</sup>	[22X]		Item Help
CPU Frequency	2.93GHz(133x22)		Menu Level▶
▶ Advanced CPU Features	[Press Enter]		
QPI Link Speed	[Auto]		
QPI Link Speed	4.8GHz		
▶ UnCore & QPI Features	[Press Enter]		
Base Clock(BCLK) Control	[Disabled]		
x BCLK Frequency (Mhz)	133		
▶ Advanced Clock Control	[Press Enter]		
Performance Enhance	[Turbo]		
Extreme Memory Profile (X.M.P.) <sup>(Note 2)</sup>	[Disabled]		
System Memory Multiplier (SPD)	[Auto]		
Memory Frequency (Mhz)	1066		
DRAM Timing Selectable (SPD)	[Auto]		
Profile DDR Voltage	1.5V		
Profile QPI Voltage	1.2V		
>>>> Channel A			
x CAS Latency Time	8	Auto	
x tRCD	7	Auto	

↑↓→←: Move    Enter: Select    +/-/PU/PD: Value    F10: Save    ESC: Exit    F1: General Help  
 F5: Previous Values    F6: Fail-Safe Defaults    F7: Optimized Defaults

CMOS Setup Utility-Copyright (C) 1984-2008 Award Software  
MB Intelligent Tweaker(M.I.T.)

x tRP	7	Auto	Item Help
x tRAS	20	Auto	Menu Level▶
>>>> Channel B			
x CAS Latency Time	8	Auto	
x tRCD	7	Auto	
x tRP	7	Auto	
x tRAS	20	Auto	
>>>> Channel C			
x CAS Latency Time	8	Auto	
x tRCD	7	Auto	
x tRP	7	Auto	
x tRAS	20	Auto	
▶ Advanced DRAM Features		[Press Enter]	
Voltage Types	Normal	Current	
-----			
Load-Line Calibration		[Disabled]	
CPU Vcore	1.22500V	[Auto]	
QPI Vtt Voltage	1.200V	[Auto]	
IOH Core	1.100V	[Auto]	
DRAM Voltage	1.500V	[Auto]	
▶ Advanced Voltage Control		[Press Enter]	

↑↓→←: Move    Enter: Select    +/-/PU/PD: Value    F10: Save    ESC: Exit    F1: General Help  
 F5: Previous Values    F6: Fail-Safe Defaults    F7: Optimized Defaults



**CAUTION**

Whether the system will work stably with the overclock/overvoltage settings you made is dependent on your overall system configurations. Incorrectly doing overclock/overvoltage may result in damage to CPU, chipset, or memory and reduce the useful life of these components. This page is for advanced users only and we recommend you not to alter the default settings to prevent system instability or other unexpected results. (Inadequately altering the settings may result in system's failure to boot. If this occurs, clear the CMOS values and reset the board to default values.)

(Note 1) This item appears only if you install a CPU that supports this feature.

(Note 2) This item appears only if you install a memory module that supports this feature.

\*\*\*\*\* Advanced CPU Features \*\*\*\*\*

CMOS Setup Utility-Copyright (C) 1984-2008 Award Software Advanced CPU Features		Item Help Menu Level▶
CPU Clock Ratio <small>(Note)</small>	[22X]	
CPU Frequency	2.93GHz(133x22)	
Intel(R) Turbo Boost Tech.	[Enabled]	
CPU Cores Enabled <small>(Note)</small>	[All]	
CPU Multi-Threading <small>(Note)</small>	[Enabled]	
CPU Enhanced Halt (C1E) <small>(Note)</small>	[Enabled]	
C3/C6/C7 State Support <small>(Note)</small>	[Disabled]	
CPU Thermal Monitor 2(TM2) <small>(Note)</small>	[Enabled]	
CPU EIST Function <small>(Note)</small>	[Enabled]	
Virtualization Technology <small>(Note)</small>	[Enabled]	
Bi-Directional PROCHOT <small>(Note)</small>	[Enabled]	

↑↓→←: Move    Enter: Select    +/-/PU/PD: Value    F10: Save    ESC:Exit    F1: General Help  
 F5: Previous Values    F6: Fail-Safe Defaults    F7: Optimized Defaults

☞ **CPU Clock Ratio** (Note)

Allows you to alter the clock ratio for the installed CPU.  
The item is present only if a CPU with unlocked clock ratio is installed.

☞ **CPU Frequency**

Displays the current operating CPU frequency.

☞ **Intel(R) Turbo Boost Tech.**

Allows you to determine whether to enable the Intel CPU Turbo Boost technology.  
(Default: Enabled)

☞ **CPU Cores Enabled** (Note)

Allows you to determine whether to enable all CPU cores.

- ▶▶ All                Enables all CPU cores. (Default)
- ▶▶ 1                 Enables only one CPU core.
- ▶▶ 2                 Enables only two CPU cores.
- ▶▶ 3                 Enables only three CPU cores.

☞ **CPU Multi-Threading** (Note)

Allows you to determine whether to enable multi-threading technology when using an Intel® CPU that supports this function. This feature only works for operating systems that support multi-processor mode. (Default: Enabled)

☞ **CPU Enhanced Halt (C1E)** (Note)

Enables or disables Intel® CPU Enhanced Halt (C1E) function, a CPU power-saving function in system halt state. When enabled, the CPU core frequency and voltage will be reduced during system halt state to decrease power consumption. (Default: Enabled)

☞ **C3/C6/C7 State Support** (Note)

Allows you to determine whether to let the CPU enter C3/C6/C7 mode in system halt state. When enabled, the CPU core frequency and voltage will be reduced during system halt state to decrease power consumption. The C3/C6/C7 state is a more enhanced power-saving state than C1. (Default: Disabled)

(Note) This item is present only if you install a CPU that supports this feature. For more information about Intel CPUs' unique features, please visit Intel's website.

☞ **CPU Thermal Monitor** <sup>(Note)</sup>

Enables or disables Intel® CPU Thermal Monitor function, a CPU overheating protection function. When enabled, the CPU core frequency and voltage will be reduced when the CPU is overheated. (Default: Enabled)

☞ **CPU EIST Function** <sup>(Note)</sup>

Enables or disables Enhanced Intel SpeedStep Technology (EIST). Depending on CPU loading, Intel® EIST technology can dynamically and effectively lower the CPU voltage and core frequency to decrease average power consumption and heat production. (Default: Enabled)

☞ **Virtualization Technology** <sup>(Note)</sup>

Enables or disables Intel® Virtualization Technology. Virtualization enhanced by Intel® Virtualization Technology will allow a platform to run multiple operating systems and applications in independent partitions. With virtualization, one computer system can function as multiple virtual systems. (Default: Enabled)

☞ **Bi-Directional PROCHOT** <sup>(Note)</sup>

- ▶ Enabled When the CPU or chipset detects that an overheating is occurring, PROCHOT signals will be emitted to lower CPU performance to decrease heat production. (Default)
- ▶ Disabled Only allows the CPU to detect whether an overheating is occurring to emit PROCHOT signals.

\*\*\*\*\* UnCore & QPI Features \*\*\*\*\*

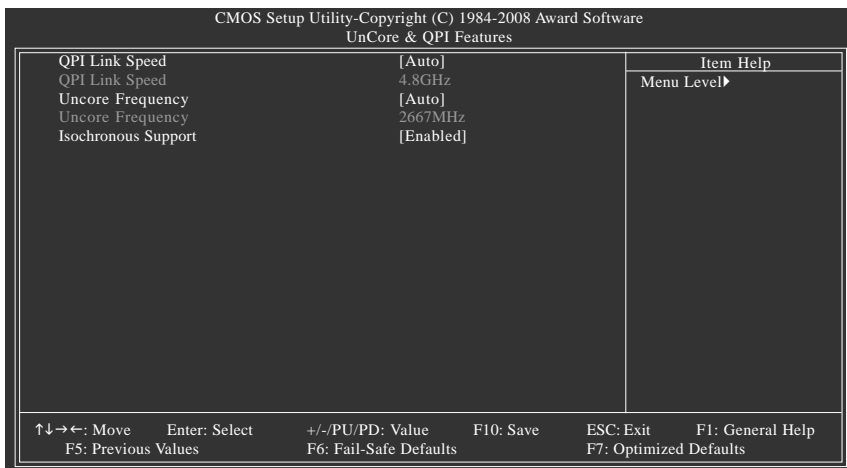

☞ **QPI Link Speed**

Allows you to set the QPI Link speed. Options are: Auto (default), x36, x44, x48, Slow Mode.

☞ **Uncore Frequency**

Allows you to set the UnCore frequency. Options are: Auto (default), x12-x48.

☞ **Isochronous Support**

Determines whether to enable specific streams between the IOH and ICH. (Default: Enabled)

(Note) This item is present only if you install a CPU that supports this feature. For more information about Intel CPUs' unique features, please visit Intel's website.

\*\*\*\*\* Advanced Clock Control \*\*\*\*\*

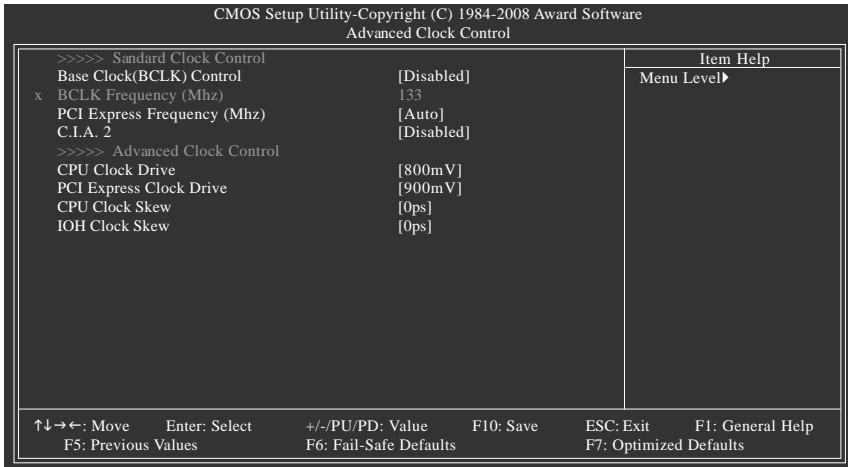

>>>> Standard Clock Control

☞ Base Clock(BCLK) Control

Enables or disables the control of CPU base clock. **Enabled** will allow the **BCLK Frequency (Mhz)** item below to be configurable. Note: If your system fails to boot after overclocking, please wait for 20 seconds to allow for automated system reboot, or clear the CMOS values to reset the board to default values. (Default: Disabled)

☞ BCLK Frequency (Mhz)

Allows you to manually set the CPU base clock. The adjustable range is from 100 MHz to 1200 MHz. This item is configurable only if the **Base Clock(BCLK) Control** option is enabled. **Important** It is highly recommended that the CPU frequency be set in accordance with the CPU specifications.

☞ PCI Express Frequency (Mhz)

Allows you to manually set the PCIe clock frequency. The adjustable range is from 90 MHz to 150 MHz. **Auto** sets the PCIe clock frequency to standard 100 MHz. (Default: Auto)

☞ C.I.A.2

CPU Intelligent Accelerator 2 (C.I.A.2) is designed to automatically adjust CPU computing power to maximize system performance. C.I.A.2 allows your system bus to be changed dynamically based on CPU loading through the use of 5 preset states.

Note: System stability varies, depending on your system hardware components.

- ▶▶ Disabled Disables the use of C.I.A.2. (Default)
- ▶▶ Cruise Increases CPU frequency by 5% or 7% depending on CPU loading.
- ▶▶ Sports Increases CPU frequency by 7% or 9% depending on CPU loading.
- ▶▶ Racing Increases CPU frequency by 9% or 11% depending on CPU loading.
- ▶▶ Turbo Increases CPU frequency by 15% or 17% depending on CPU loading.
- ▶▶ Full Thrust Increases CPU frequency by 17% or 19% depending on CPU loading.

Warning: Before using C.I.A.2, please first verify the overclocking capability of your CPU. As stability is highly dependent on system components, when system instability occurs after overclocking, lower the overclocking ratio.



## >>>> Advanced Clock Control

### ☞ CPU Clock Drive

Allows you to adjust the amplitude of the CPU and North Bridge clock.  
Options are: 700mV, 800mV (default), 900mV, 1000mV.

### ☞ PCI Express Clock Drive

Allows you to adjust the amplitude of the PCI Express and North Bridge clock.  
Options are: 700mV, 800mV, 900mV (default), 1000mV.

### ☞ CPU Clock Skew

Allows you to set the CPU clock prior to the North Bridge clock.  
Options are: 0ps-750ps. (Default: 0ps)

### ☞ IOH Clock Skew

Allows you to set the North Bridge clock prior to the CPU clock.  
Options are: 0ps-750ps. (Default: 0ps)

## \*\*\*\*\* Advanced DRAM Features \*\*\*\*\*

CMOS Setup Utility-Copyright (C) 1984-2008 Award Software	
Advanced DRAM Features	
	Item Help
Performance Enhance	[Turbo]
Extreme Memory Profile (X.M.P.) <sup>(Note)</sup>	[Disabled]
System Memory Multiplier (SPD)	[Auto]
Memory Frequency (Mhz)	1066 1066
DRAM Timing Selectable (SPD)	[Auto]
Profile DDR Voltage	1.5V
Profile QPI Voltage	1.2V
>>>>> Channel A	
▶ Channel A Timing Settings	[Press Enter]
▶ Channel A Turnaround Settings	[Press Enter]
>>>>> Channel B	
▶ Channel B Timing Settings	[Press Enter]
▶ Channel B Turnaround Settings	[Press Enter]
>>>>> Channel C	
▶ Channel C Timing Settings	[Press Enter]
▶ Channel C Turnaround Settings	[Press Enter]

↑↓→←: Move    Enter: Select    +/-/PU/PD: Value    F10: Save    ESC: Exit    F1: General Help  
F5: Previous Values    F6: Fail-Safe Defaults    F7: Optimized Defaults

### ☞ Performance Enhance

Allows the system to operate at three different performance levels.

- ▶▶ Standard    Lets the system operate at its basic performance level.
- ▶▶ Turbo       Lets the system operate at its good performance level. (Default)
- ▶▶ Extreme     Lets the system operate at its best performance level.

### ☞ Extreme Memory Profile (X.M.P.)<sup>(Note)</sup>

Allows the BIOS to read the SPD data on XMP memory module(s) to enhance memory performance when enabled.

- ▶▶ Disabled    Disables this function. (Default)
- ▶▶ Profile1    Uses Profile 1 settings.

(Note) This item appears only if you install a memory module that supports this feature.

### ☞ System Memory Multiplier (SPD)

Allows you to set the system memory multiplier. **Auto** sets memory multiplier according to memory SPD data. (Default: Auto)

### ☞ Memory Frequency (Mhz)

The first memory frequency value is the normal operating frequency of the memory being used; the second is the memory frequency that is automatically adjusted according to the **BCLK Frequency (Mhz)** and **System Memory Multiplier** settings.

### ☞ DRAM Timing Selectable (SPD)

**Manual** allows all DRAM Timing items below to be configurable.

Options are: Auto (default), Manual.

### ☞ Profile DDR Voltage

When using a non-XMP memory module or **Extreme Memory Profile (X.M.P.)** is set to **Disabled**, this item will display as **1.5V**. When **Extreme Memory Profile (X.M.P.)** is set to **Profile1**, this item will display the value based on the SPD data on the XMP memory.

### ☞ Profile QPI Voltage

The value displayed here is dependent on the CPU being used.

## >>>> Channel A/B/C Timing Settings

CMOS Setup Utility-Copyright (C) 1984-2008 Award Software  
Channel A Timing Settings

>>>>> Channel A Standard Timing Control			Item Help
x CAS Latency Time	6	Auto	Menu Level▶
x tRCD	6	Auto	
x tRP	6	Auto	
x tRAS	16	Auto	
>>>>> Channel A Advanced Timing Control			
x tRC	22	Auto	
x tRRD	4	Auto	
x tWTR	4	Auto	
x tWR	8	Auto	
x tRFC	48	Auto	
x tRTP	3	Auto	
x tFAW	13	Auto	
x Command Rate (CMD)	1	Auto	
>>>>> Channel A Misc Timing Control			
x Round Trip Latency	51	Auto	

↑↓←→: Move    Enter: Select    +/-/PU/PD: Value    F10: Save    ESC: Exit    F1: General Help  
F5: Previous Values    F6: Fail-Safe Defaults    F7: Optimized Defaults

## >>>>> Channel A/B/C Standard Timing Control

### ☞ CAS Latency Time

Options are: Auto (default), 6~16.

### ☞ tRCD

Options are: Auto (default), 1~15.

### ☞ tRP

Options are: Auto (default), 1~15.

### ☞ tRAS

Options are: Auto (default), 1~63.

>>>> Channel A/B/C Advanced Timing Control

☞ **tRC**

Options are: Auto (default), 1-63.

☞ **tRRD**

Options are: Auto (default), 1-15.

☞ **tWTR**

Options are: Auto (default), 1-31.

☞ **tWR**

Options are: Auto (default), 1-31.

☞ **tRFC**

Options are: Auto (default), 1-255.

☞ **tRTP**

Options are: Auto (default), 1-15.

☞ **tFAW**

Options are: Auto (default), 1-63.

☞ **Command Rate(CMD)**

Options are: Auto (default), 1-2.

>>>> Channel A/B/C Misc Timing Control

☞ **Round Trip Latency**

Options are: Auto (default), 1-255.

>>>> Channel A/B/C Turnaround Settings

CMOS Setup Utility-Copyright (C) 1984-2008 Award Software  
Channel A Turnaround Settings

	Item Help
>>>> Channel A Writes Followed by Reads	
x Different DIMMs	6 Auto
x Different Ranks	6 Auto
x On The Same Rank	6 Auto
>>>> Channel A Reads Followed by Writes	
x Different DIMMs	8 Auto
x Different Ranks	8 Auto
x On The Same Rank	8 Auto
>>>> Channel A Reads Followed by Reads	
x Different DIMMs	6 Auto
x Different Ranks	5 Auto
x On The Same Rank	1 Auto
>>>> Channel A Writes Followed by Writes	
x Different DIMMs	6 Auto
x Different Ranks	6 Auto
x On The Same Rank	1 Auto

↑↓←→: Move    Enter: Select    +/-/PU/PD: Value    F10: Save    ESC: Exit    F1: General Help  
 F5: Previous Values    F6: Fail-Safe Defaults    F7: Optimized Defaults

>>>> Channel A/B/C Writes Followed by Reads

☞ **Different DIMMs**

Options are: Auto (default), 1-8.

☞ **Different Ranks**

Options are: Auto (default), 1-8.

☞ **On The Same Rank**

Options are: Auto (default), 1-13.

>>>>> **Channel A/B/C Reads Followed by Writes**

☞ **Different DIMMs**

Options are: Auto (default), 1-15.

☞ **Different Ranks**

Options are: Auto (default), 1-15.

☞ **On The Same Rank**

Options are: Auto (default), 1-15.

>>>>> **Channel A/B/C Reads Followed by Reads**

☞ **Different DIMMs**

Options are: Auto (default), 1-8.

☞ **Different Ranks**

Options are: Auto (default), 1-8.

☞ **On The Same Rank**

Options are: Auto (default), 1-2.

>>>>> **Channel A/B/C Writes Followed by Writes**

☞ **Different DIMMs**

Options are: Auto (default), 1-8.

☞ **Different Ranks**

Options are: Auto (default), 1-8.

☞ **On The Same Rank**

Options are: Auto (default), 1-2.

\*\*\*\*\* Advanced Voltage Control \*\*\*\*\*

CMOS Setup Utility-Copyright (C) 1984-2008 Award Software  
Advanced Voltage Control

Voltage Types	Normal	Current	Item Help
-----			
>>> CPU			Menu Level▶
Load-Line Calibration		[Disabled]	
CPU Vcore	1.12500V	[Auto]	
QPI/Vtt Voltage	1.200V	[Auto]	
CPU PLL	1.800V	[Auto]	
>>> MCH/ICH			
PCIE	1.500V	[Auto]	
QPI PLL	1.100V	[Auto]	
IOH Core	1.100V	[Auto]	
ICH I/O	1.500V	[Auto]	
ICH Core	1.100V	[Auto]	
>>> DRAM			
DRAM Voltage	1.500V	[Auto]	
DRAM Termination	0.750V	[Auto]	
Ch-A Data VRef.	0.750V	[Auto]	
Ch-B Data VRef.	0.750V	[Auto]	
Ch-C Data VRef.	0.750V	[Auto]	

↑↓→←: Move    Enter: Select    +/-/PU/PD: Value    F10: Save    ESC: Exit    F1: General Help  
 F5: Previous Values    F6: Fail-Safe Defaults    F7: Optimized Defaults

CMOS Setup Utility-Copyright (C) 1984-2008 Award Software  
Advanced Voltage Control

Voltage Types	Normal	Current	Item Help
-----			
Ch-A Address VRef.	0.750V	[Auto]	Menu Level▶
Ch-B Address VRef.	0.750V	[Auto]	
Ch-C Address VRef.	0.750V	[Auto]	

↑↓→←: Move    Enter: Select    +/-/PU/PD: Value    F10: Save    ESC: Exit    F1: General Help  
 F5: Previous Values    F6: Fail-Safe Defaults    F7: Optimized Defaults

>>> CPU

☞ Load-Line Calibration

Enables or disables Load-Line Calibration. Enabling this feature adjusts Vdroop, keeping the CPU voltage more constant under light and heavy CPU load. **Disabled** sets the CPU voltage following Intel specifications. (Default: Disabled)

☞ CPU Vcore

The default is **Auto**.

☞ QPI/Vtt Voltage

The default is **Auto**.

☞ CPU PLL

The default is **Auto**.

>>> **MCH/ICH**

☞ **PCIE**

The default is **Auto**.

☞ **QPI PLL**

The default is **Auto**.

☞ **IOH Core**

The default is **Auto**.

☞ **ICH I/O**

The default is **Auto**.

☞ **ICH Core**

The default is **Auto**.

>>> **DRAM**

☞ **DRAM Voltage**

The default is **Auto**.

☞ **DRAM Termination**

The default is **Auto**.

☞ **Ch-A Data VRef.**

The default is **Auto**.

☞ **Ch-B Data VRef.**

The default is **Auto**.

☞ **Ch-C Data VRef.**

The default is **Auto**.

☞ **Ch-A Address VRef.**

The default is **Auto**.

☞ **Ch-B Address VRef.**

The default is **Auto**.

☞ **Ch-C Address VRef.**

The default is **Auto**.

## 2-4 Standard CMOS Features

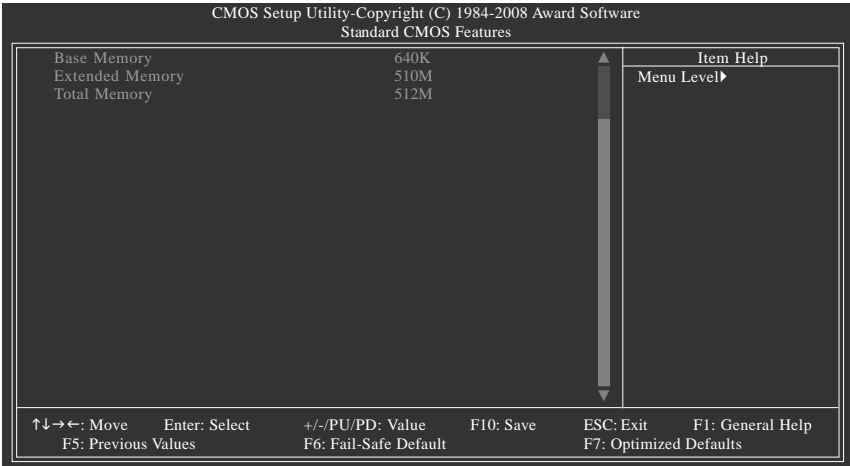
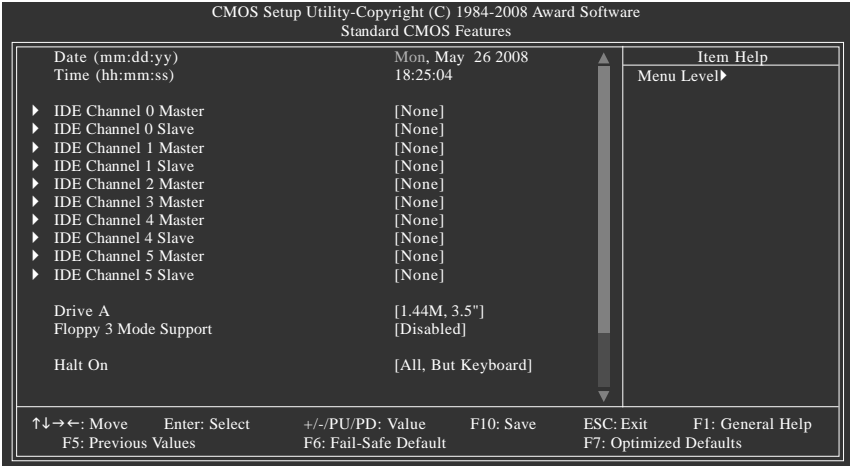

### ☞ Date

Sets the system date. The date format is week (read-only), month, date and year. Select the desired field and use the up arrow or down arrow key to set the date.

### ☞ Time

Sets the system time. For example, 1 p.m. is 13:0:0. Select the desired field and use the up arrow or down arrow key to set the time.

### ☞ IDE Channel 0/1 Master/Slave

#### » IDE HDD Auto-Detection

Press <Enter> to autodetect the parameters of the IDE/SATA device on this channel.

#### » IDE Channel 0/1 Master/Slave

Configure your IDE/SATA devices by using one of the three methods below:

- Auto Lets BIOS automatically detect IDE/SATA devices during the POST. (Default)
  - None If no IDE/SATA devices are used, set this item to **None** so the system will skip the detection of the device during the POST for faster system startup.
  - Manual Allows you to manually enter the specifications of the hard drive when the hard drive access mode is set to **CHS**.
- ▶▶ Access Mode Sets the hard drive access mode. Options are: Auto (default), CHS, LBA, Large.

### ☞ IDE Channel 2/3 Master, IDE Channel 4/5 Master/Slave

#### ▶▶ IDE Auto-Detection

Press <Enter> to autodetect the parameters of the IDE/SATA device on this channel.

#### ▶▶ Extended IDE Drive

Configure your IDE/SATA devices by using one of the two methods below:

- Auto Lets BIOS automatically detect IDE/SATA devices during the POST. (Default)
  - None If no IDE/SATA devices are used, set this item to **None** so the system will skip the detection of the device during the POST for faster system startup.
- ▶▶ Access Mode Sets the hard drive access mode. Options are: Auto (default), Large.

The following fields display your hard drive specifications. If you wish to enter the parameters manually, refer to the information on the hard drive.

- ▶▶ Capacity Approximate capacity of the currently installed hard drive.
- ▶▶ Cylinder Number of cylinders.
- ▶▶ Head Number of heads.
- ▶▶ Precomp Write precompensation cylinder.
- ▶▶ Landing Zone Landing zone.
- ▶▶ Sector Number of sectors.

### ☞ Drive A

Allows you to select the type of floppy disk drive installed in your system. If you do not install a floppy disk drive, set this item to **None**. Options are: None, 360K/5.25", 1.2M/5.25", 720K/3.5", 1.44M/3.5", 2.88M/3.5".

### ☞ Floppy 3 Mode Support

Allows you to specify whether the installed floppy disk drive is 3-mode floppy disk drive, a Japanese standard floppy disk drive. Options are: Disabled (default), Drive A.

### ☞ Halt On

Allows you to determine whether the system will stop for an error during the POST.

- ▶▶ No Errors The system boot will not stop for any error.
- ▶▶ All Errors Whenever the BIOS detects a non-fatal error the system boot will stop.
- ▶▶ All, But Keyboard The system boot will not stop for a keyboard error but stop for all other errors. (Default)
- ▶▶ All, But Diskette The system boot will not stop for a floppy disk drive error but stop for all other errors.
- ▶▶ All, But Disk/Key The system boot will not stop for a keyboard or a floppy disk drive error but it will stop for all other errors.

### ☞ Memory

These fields are read-only and are determined by the BIOS POST.

- ▶▶ Base Memory Also called conventional memory. Typically, 640 KB will be reserved for the MS-DOS operating system.
- ▶▶ Extended Memory The amount of extended memory.
- ▶▶ Total Memory The total amount of memory installed on the system.



## 2-5 Advanced BIOS Features

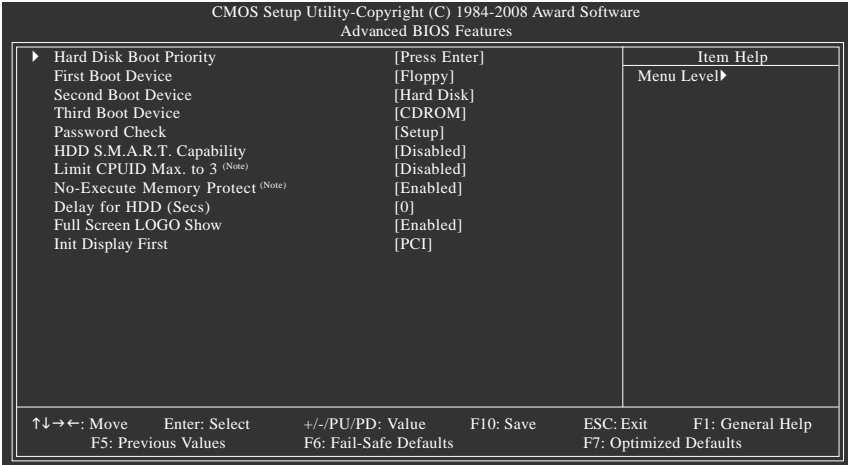

### ☞ Hard Disk Boot Priority

Specifies the sequence of loading the operating system from the installed hard drives. Use the up or down arrow key to select a hard drive, then press the plus key <+> (or <PageUp>) or the minus key <-> (or <PageDown>) to move it up or down on the list. Press <Esc> to exit this menu when finished.

### ☞ First/Second/Third Boot Device

Specifies the boot order from the available devices. Use the up or down arrow key to select a device and press <Enter> to accept. Options are: Floppy, LS120, Hard Disk, CDROM, ZIP, USB-FDD, USB-ZIP, USB-CDROM, USB-HDD, Legacy LAN, Disabled.

### ☞ Password Check

Specifies whether a password is required every time the system boots, or only when you enter BIOS Setup. After configuring this item, set the password(s) under the **Set Supervisor/User Password** item in the BIOS Main Menu.

- ▶▶ Setup      A password is only required for entering the BIOS Setup program. (Default)
- ▶▶ System     A password is required for booting the system and for entering the BIOS Setup program.

### ☞ HDD S.M.A.R.T. Capability

Enables or disables the S.M.A.R.T. (Self Monitoring and Reporting Technology) capability of your hard drive. This feature allows your system to report read/write errors of the hard drive and to issue warnings when a third party hardware monitor utility is installed. (Default: Disabled)

### ☞ Limit CPUID Max. to 3 <sup>(Note)</sup>

Allows you to determine whether to limit CPUID maximum value. Set this item to **Disabled** for Windows XP operating system; set this item to **Enabled** for legacy operating system such as Windows NT4.0. (Default: Disabled)

(Note) This item is present only if you install a CPU that supports this feature. For more information about Intel CPUs' unique features, please visit Intel's website.

☞ **No-Execute Memory Protect** <sup>(Note)</sup>

Enables or disables Intel® Execute Disable Bit function. This function may enhance protection for the computer, reducing exposure to viruses and malicious buffer overflow attacks when working with its supporting software and system. (Default: Enabled)

☞ **Delay For HDD (Secs)**

Allows you to set a delay time for the BIOS to initialize the hard drive as the system boots up. The adjustable range is from 0 to 15 seconds. (Default: 0)

☞ **Full Screen LOGO Show**

Allows you to determine whether to display the GIGABYTE Logo at system startup. **Disabled** displays normal POST message. (Default: Enabled)

☞ **Init Display First**

Specifies the first initiation of the monitor display from the installed PCI graphics card or PCI Express graphics card.

- ▶▶ PCI            Sets the PCI graphics card as the first display. (Default)
- ▶▶ PEG           Sets PCI Express graphics card on the first PCI Express x16 slot (PCIEX16\_1) as the first display.
- ▶▶ PEG2          Sets PCI Express graphics card on the second PCI Express x16 slot (PCIEX16\_2) as the first display.
- ▶▶ PEG3          Sets PCI Express graphics card on the PCI Express x8 slot (PCIEX8\_1) as the first display.
- ▶▶ PEG4          Sets PCI Express graphics card on the PCI Express x4 slot (PCIEX4\_1) as the first display.

(Note) This item is present only if you install a CPU that supports this feature. For more information about Intel CPUs' unique features, please visit Intel's website.

## 2-6 Integrated Peripherals

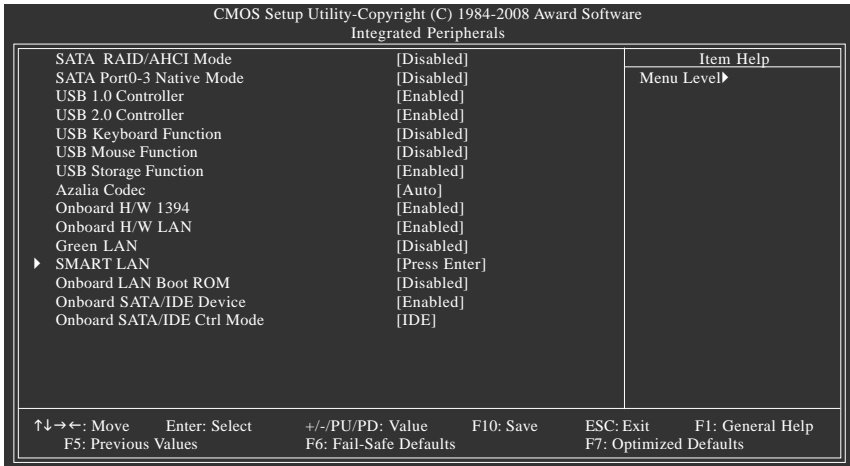

### ☞ SATA RAID/AHCI Mode (ICH10R South Bridge)

Enables or disables RAID for the SATA controllers or configures the SATA controllers to AHCI mode.

- ▶ Disabled      Disables RAID for the SATA controllers and configures the SATA controllers to PATA mode. (Default)
- ▶ AHCI          Configures the SATA controllers to AHCI mode. Advanced Host Controller Interface (AHCI) is an interface specification that allows the storage driver to enable advanced Serial ATA features such as Native Command Queuing and hot plug.
- ▶ RAID          Enables RAID for the SATA controllers.

### ☞ SATA Port0-3 Native Mode (ICH10R South Bridge)

Specifies the operating mode of the integrated SATA controllers.

- ▶ Disabled      Allows the SATA controllers to operate in Legacy IDE mode. In Legacy mode the SATA controllers use dedicated IRQs that cannot be shared with other device. Set this option to **Disabled** if you wish to install operating systems that do not support Native mode. (Default)
- ▶ Enabled        Allows the SATA controllers to operate in Native IDE mode. Enable Native IDE mode if you wish to install operating systems that support Native mode.

### ☞ USB 1.0 Controller

Enables or disables the integrated USB 1.0 controller. (Default: Enabled)  
**Disabled** will turn off all of the USB functionalities below.

### ☞ USB 2.0 Controller

Enables or disables the integrated USB 2.0 controller. (Default: Enabled)

### ☞ USB Keyboard Function

Allows USB keyboard to be used in MS-DOS. (Default: Disabled)

### ☞ USB Mouse Function

Allows USB mouse to be used in MS-DOS. (Default: Disabled)

### ☞ USB Storage Function

Determines whether to detect USB storage devices, including USB flash drives and USB hard drives during the POST. (Default: Enabled)

### ☞ Azalia Codec

Enables or disables the onboard audio function. (Default: Auto)

If you wish to install a 3rd party add-in audio card instead of using the onboard audio, set this item to **Disabled**.

### ☞ Onboard H/W 1394

Enables or disables the onboard IEEE 1394 function. (Default: Enabled)

### ☞ Onboard H/W LAN

Enables or disables the onboard LAN function. (Default: Enabled)

If you wish to install a 3rd party add-in network card instead of using the onboard LAN, set this item to **Disabled**.

### ☞ Green LAN

When the onboard LAN function and **Green LAN** are enabled, the system will dynamically detect if LAN cable(s) is connected or not. If not, the corresponding LAN controller will be disabled automatically. (Default: Disabled)

### ☞ SMART LAN (LAN Cable Diagnostic Function)

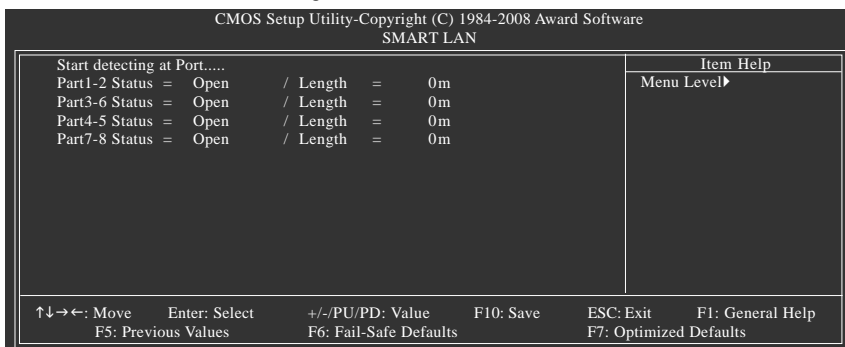

This motherboard incorporates cable diagnostic feature designed to detect the status of the attached LAN cable. This feature will detect cabling issue and report the approximate distance to the fault or short. Refer to the following information for diagnosing your LAN cable:

#### ☞ When No LAN Cable Is Attached...

If no LAN cable is attached to the motherboard, the **Status** fields of all four pairs of wires will show **Open** and the **Length** fields show **0m**, as shown in the figure above.

#### ☞ When LAN Cable Is Functioning Normally...

If no cable problem is detected on the LAN cable connected to a Gigabit hub or a 10/100 Mbps hub, the following message will appear:

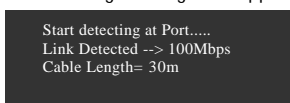

- ▶▶ Link Detected      Displays transmission speed
- ▶▶ Cable Length      Displays the approximate length of the attached LAN cable.

Note: The Gigabit hub will only operate at a speed of 10/100 Mbps in MS-DOS mode; it will operate at a normal speed of 10/100/1000 Mbps in Windows mode or when the LAN Boot ROM is activated.

#### ☞ When a Cable Problem Occurs...

If a cable problem occurs on a specified pair of wires, the **Status** field will show **Short** and then length shown will be the approximate distance to the fault or short.

Example: Part1-2 Status = Short / Length = 2m

Explanation: A fault or short might occur at about 2m on Part 1-2.

Note: Part 4-5 and Part 7-8 are not used in a 10/100 Mbps environment, so their **Status** fields will show **Open**, and the length shown is the approximate length of the attached LAN cable.

#### ☞ Onboard LAN Boot ROM

Allows you to decide whether to activate the boot ROM integrated with the onboard LAN chip.  
(Default: Disabled)

#### ☞ Onboard SATA/IDE Device (GIGABYTE SATA2 Chip)

Enables or disables the IDE and SATA controllers integrated in the GIGABYTE SATA2 chip.  
(Default: Enabled)

#### ☞ Onboard SATA/IDE Ctrl Mode (GIGABYTE SATA2 Chip)

Enables or disables RAID for the SATA controller integrated in the GIGABYTE SATA2 chip or configures the SATA controller to AHCI mode.

- ▶▶ IDE                      Disables RAID for the SATA controller and configures the SATA controller to PATA mode. (Default)
- ▶▶ AHCI                     Configures the SATA controller to AHCI mode. Advanced Host Controller Interface (AHCI) is an interface specification that allows the storage driver to enable advanced Serial ATA features such as Native Command Queuing and hot plug.
- ▶▶ RAID/IDE                Enables RAID for the SATA controller. (The IDE controller still operates in PATA mode)

## 2-7 Power Management Setup

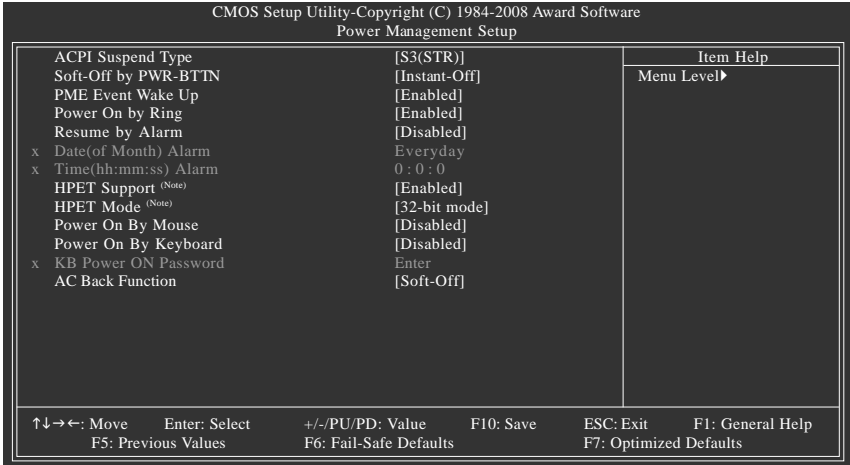

### ACPI Suspend Type

Specifies the ACPI sleep state when the system enters suspend.

- ▶ S1(POS) Enables the system to enter the ACPI S1 (Power on Suspend) sleep state. In S1 sleep state, the system appears suspended and stays in a low power mode. The system can be resumed at any time.
- ▶ S3(STR) Enables the system to enter the ACPI S3 (Suspend to RAM) sleep state (default). In S3 sleep state, the system appears to be off and consumes less power than in the S1 state. When signaled by a wake-up device or event, the system resumes to its working state exactly where it was left off.

### Soft-Off by PWR-BTTN

Configures the way to turn off the computer in MS-DOS mode using the power button.

- ▶ Instant-Off Press the power button and then the system will be turned off instantly. (Default)
- ▶ Delay 4 Sec. Press and hold the power button for 4 seconds to turn off the system. If the power button is pressed for less than 4 seconds, the system will enter suspend mode.

### PME Event Wake Up

Allows the system to be awakened from an ACPI sleep state by a wake-up signal from a PCI or PCIe device. Note: To use this function, you need an ATX power supply providing at least 1A on the +5VSB lead. (Default: Enabled)

### Power On by Ring

Allows the system to be awakened from an ACPI sleep state by a wake-up signal from a modem that supports wake-up function. (Default: Enabled)

(Note) Supported on Windows® Vista® operating system only.

### ☞ **Resume by Alarm**

Determines whether to power on the system at a desired time. (Default: Disabled)

If enabled, set the date and time as following:

▶▶ **Date(of Month) Alarm:** Turn on the system at a specific time on each day or on a specific day in a month.

▶▶ **Time(hh: mm: ss) Alarm:** Set the time at which the system will be powered on automatically.

Note: When using this function, avoid inadequate shutdown from the operating system or removal of the AC power, or the settings may not be effective.

### ☞ **HPET Support** (Note)

Enables or disables High Precision Event Timer (HPET) for Windows® Vista® operating system. (Default: Enabled)

### ☞ **HPET Mode** (Note)

Allows you to select the HPET mode for your Windows® Vista® operating system. Select **32-bit mode** when you install 32-bit Windows® Vista®; select **64-bit mode** when you install 64-bit Windows® Vista®. (Default: 32-bit mode)

### ☞ **Power On By Mouse**

Allows the system to be turned on by a PS/2 mouse wake-up event.

Note: To use this function, you need an ATX power supply providing at least 1A on the +5VSB lead.

▶▶ **Disabled** Disables this function. (Default)

▶▶ **Double Click** Double click on left button on the PS/2 mouse to turn on the system.

### ☞ **Power On By Keyboard**

Allows the system to be turned on by a PS/2 keyboard wake-up event.

Note: you need an ATX power supply providing at least 1A on the +5VSB lead.

▶▶ **Disabled** Disables this function. (Default)

▶▶ **Password** Set a password with 1~5 characters to turn on the system.

▶▶ **Keyboard 98** Press POWER button on the Windows 98 keyboard to turn on the system.

### ☞ **KB Power ON Password**

Set the password when **Power On by Keyboard** is set to **Password**. Press <Enter> on this item and set a password with up to 5 characters and then press <Enter> to accept. To turn on the system, enter the password and press <Enter>.

Note: To cancel the password, press <Enter> on this item. When prompted for the password, press <Enter> again without entering the password to clear the password settings.

### ☞ **AC Back Function**

Determines the state of the system after the return of power from an AC power loss.

▶▶ **Soft-Off** The system stays off upon the return of the AC power. (Default)

▶▶ **Full-On** The system is turned on upon the return of the AC power.

▶▶ **Memory** The system returns to its last known awake state upon the return of the AC power.

(Note) Supported on Windows® Vista® operating system only.

## 2-8 PC Health Status

CMOS Setup Utility-Copyright (C) 1984-2008 Award Software		PC Health Status	
Reset Case Open Status	[Disabled]	Item Help	
Case Opened	No	Menu Level▶	
Vcore	1.220V		
DDR15V	1.504V		
+5V	4.972V		
Current System Temperature	30°C		
Current CPU Temperature	47°C		
Current MCH Temperature	42°C		
Current CPU FAN Speed	3375 RPM		
Current SYSTEM FAN2 Speed	0 RPM		
Current POWER FAN Speed	0 RPM		
Current SYSTEM FAN1 Speed	0 RPM		
CPU Warning Temperature	[Disabled]		
CPU FAN Fail Warning	[Disabled]		
SYSTEM FAN2 Fail Warning	[Disabled]		
POWER FAN Fail Warning	[Disabled]		
SYSTEM FAN1 Fail Warning	[Disabled]		
CPU Smart FAN Control	[Enabled]		
CPU Smart FAN Mode	[Auto]		
↑↓→←: Move    Enter: Select    +/-/PU/PD: Value    F10: Save    ESC: Exit    F1: General Help F5: Previous Values    F6: Fail-Safe Defaults    F7: Optimized Defaults			

### Reset Case Open Status

Keeps or clears the record of previous chassis intrusion status. **Enabled** clears the record of previous chassis intrusion status and the **Case Opened** field will show "No" at next boot. (Default: Disabled)

### Case Opened

Displays the detection status of the chassis intrusion detection device attached to the motherboard CI header. If the system chassis cover is removed, this field will show "Yes", otherwise it will show "No". To clear the chassis intrusion status record, set **Reset Case Open Status** to **Enabled**, save the settings to CMOS, and then restart your system.

### Current Voltage(V) Vcore/DDR15V/+5V

Displays the current system voltages.

### Current System/CPU/MCH Temperature

Displays current system/CPU/North Bridge temperature.

### Current CPU/SYSTEM/POWER FAN Speed (RPM)

Displays current CPU/system/power fan speed.

### CPU Warning Temperature

Sets the warning threshold for CPU temperature. When CPU temperature exceeds the threshold, BIOS will emit warning sound. Options are: Disabled (default), 60°C/140°F, 70°C/158°F, 80°C/176°F, 90°C/194°F.

### CPU/SYSTEM/POWER FAN Fail Warning

Allows the system to emit warning sound if the CPU/system/power fan is not connected or fails. Check the fan condition or fan connection when this occurs. (Default: Disabled)



### ☞ CPU Smart FAN Control

Enables or disables the CPU fan speed control function. **Enabled** allows the CPU fan to run at different speed according to the CPU temperature. You can adjust the fan speed with EasyTune based on system requirements. If disabled, CPU fan runs at full speed. (Default: Enabled)

### ☞ CPU Smart FAN Mode

Specifies how to control CPU fan speed. This item is configurable only if **CPU Smart FAN Control** is set to **Enabled**.

- ▶▶ Auto            Lets BIOS autodetect the type of CPU fan installed and sets the optimal CPU fan control mode. (Default)
- ▶▶ Voltage        Sets Voltage mode for a 3-pin CPU fan.
- ▶▶ PWM            Sets PWM mode for a 4-pin CPU fan.

Note: The **Voltage** mode can be set for a 3-pin CPU fan or a 4-pin CPU fan. However, for a 4-pin CPU fan that is not designed following Intel PWM fan specifications, selecting PWM mode may not effectively reduce the fan speed.

## 2-9 Load Fail-Safe Defaults

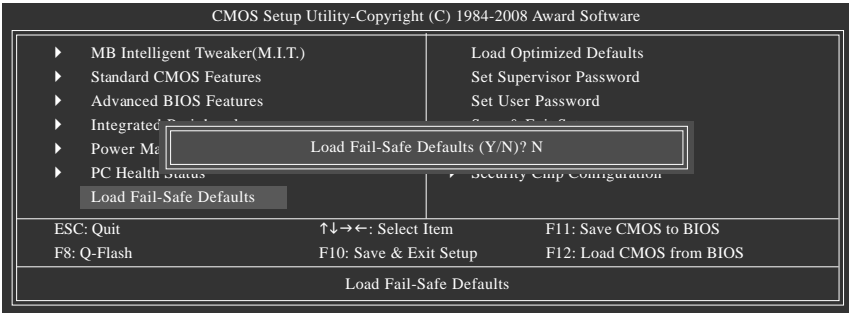

Press <Enter> on this item and then press the <Y> key to load the safest BIOS default settings. In case system instability occurs, you may try to load Fail-Safe defaults, which are the safest and most stable BIOS settings for the motherboard.

## 2-10 Load Optimized Defaults

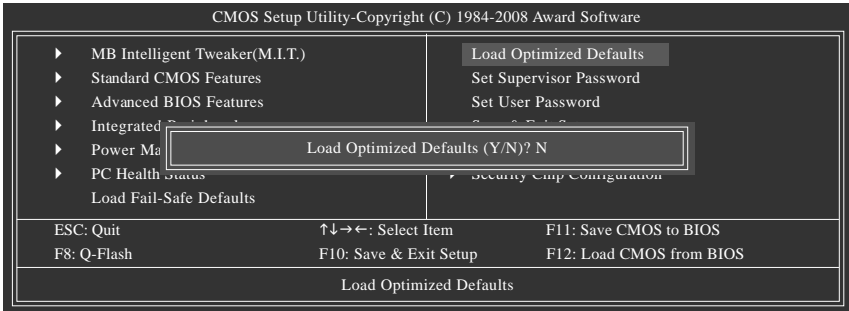

Press <Enter> on this item and then press the <Y> key to load the optimal BIOS default settings. The BIOS defaults settings helps the system to operate in optimum state. Always load the Optimized defaults after updating the BIOS or after clearing the CMOS values.

## 2-11 Set Supervisor/User Password

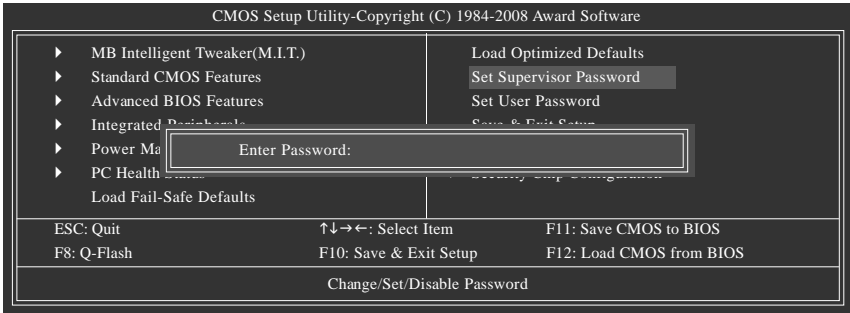

Press <Enter> on this item and type the password with up to 8 characters and then press <Enter>. You will be requested to confirm the password. Type the password again and press <Enter>.

The BIOS Setup program allows you to specify two separate passwords:

### Supervisor Password

When a system password is set and the **Password Check** item in **Advanced BIOS Features** is set to **Setup**, you must enter the supervisor password for entering BIOS Setup and making BIOS changes.

When the **Password Check** item is set to **System**, you must enter the supervisor password (or user password) at system startup and when entering BIOS Setup.

### User Password

When the **Password Check** item is set to **System**, you must enter the supervisor password (or user password) at system startup to continue system boot. In BIOS Setup, you must enter the supervisor password if you wish to make changes to BIOS settings. The user password only allows you to view the BIOS settings but not to make changes.

To clear the password, press <Enter> on the password item and when requested for the password, press <Enter> again. The message "PASSWORD DISABLED" will appear, indicating the password has been cancelled.

## 2-12 Save & Exit Setup

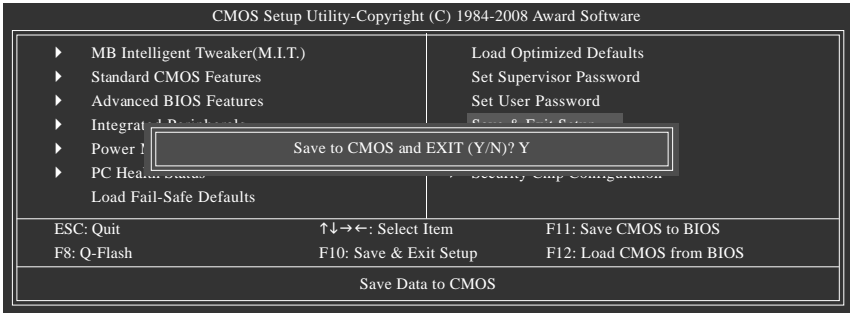

Press <Enter> on this item and press the <Y> key. This saves the changes to the CMOS and exits the BIOS Setup program. Press <N> or <Esc> to return to the BIOS Setup Main Menu.

## 2-13 Exit Without Saving

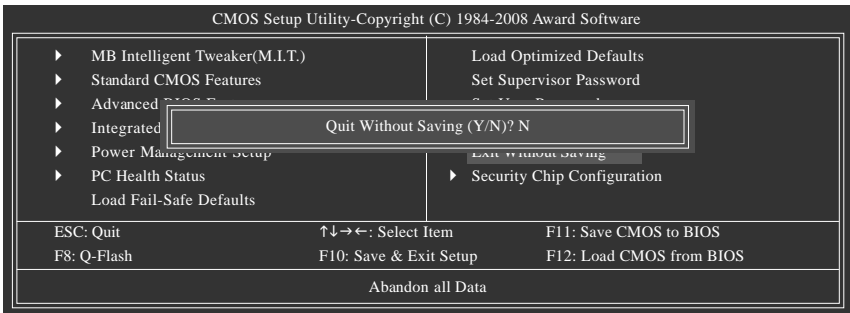

Press <Enter> on this item and press the <Y> key. This exits the BIOS Setup without saving the changes made in BIOS Setup to the CMOS. Press <N> or <Esc> to return to the BIOS Setup Main Menu.

## 2-14 Security Chip Configuration

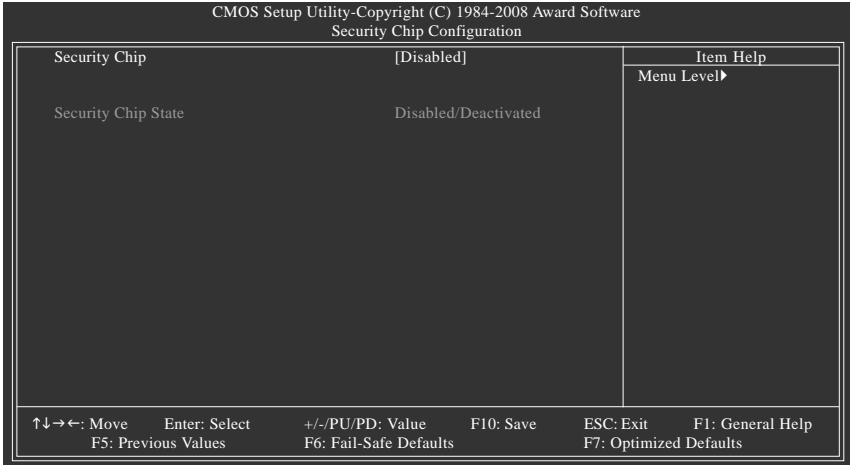

### ☞ Security Chip

Enables or disables the security chip. It is recommended that you use this function with the Supervisor/User password.

- ▶▶ Enabled            Enables the security chip.
- ▶▶ Enabled/Activate    Enables the security chip and initializes the Security Platform.
- ▶▶ Disabled            Disables the security chip. (Default)

### ☞ Security Chip State

Displays the current settings in the security chip.



# Chapter 3 Drivers Installation



- Before installing the drivers, first install the operating system.
- After installing the operating system, insert the motherboard driver disk into your optical drive. The driver Autorun screen is automatically displayed which looks like that shown in the screen shot below. (If the driver Autorun screen does not appear automatically, go to My Computer, double-click the optical drive and execute the **Run.exe** program.)

## 3-1 Installing Chipset Drivers



Now Loading Please wait...

After inserting the driver disk, "Xpress Install" will automatically scan your system and then list all the drivers that are recommended to install. You can click the **Install All** button and "Xpress Install" will install all the recommended drivers. Or click **Install Single Items** to manually select the drivers you wish to install.

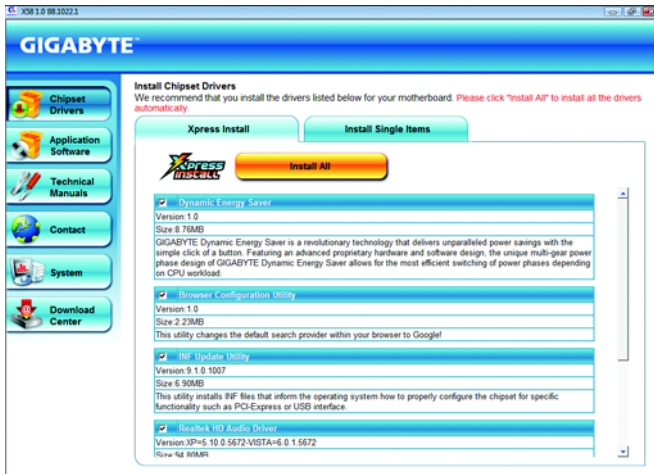

- Please ignore the popup dialog box(es) (e.g. the **Found New Hardware Wizard**) displayed when "Xpress Install" is installing the drivers. Failure to do so may affect the driver installation.
- Some device drivers will restart your system automatically during the driver installation. After the system restart, "Xpress Install" will continue to install other drivers.
- After the drivers are installed, follow the onscreen instructions to restart your system. You can install other applications included in the motherboard driver disk.
- For USB 2.0 driver support under the Windows XP operating system, please install the Windows XP Service Pack 1 or later. After installing the SP1 (or later), if a question mark still exists in **Universal Serial Bus Controller** in **Device Manager**, please remove the question mark (by right-clicking your mouse and select **Uninstall**) and restart the system. (The system will then autodetect and install the USB 2.0 driver.)

### 3-2 Application Software

This page displays all the utilities and applications that GIGABYTE develops and some free software. You can click the **Install** button on the right of an item to install it.

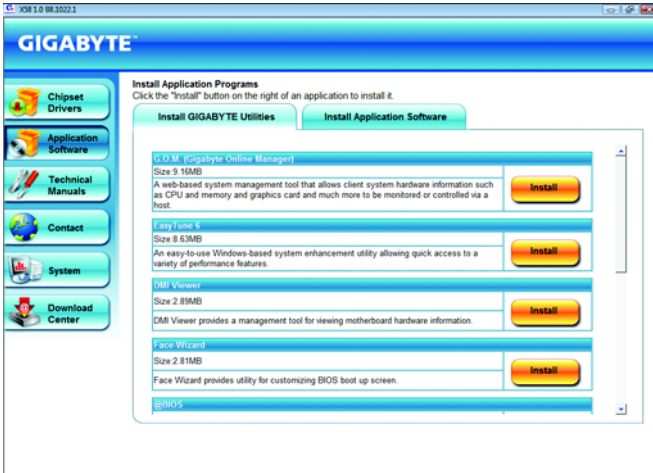

### 3-3 Technical Manuals

This page provides GIGABYTE's application guides, content descriptions for this driver disk, and the motherboard manuals.

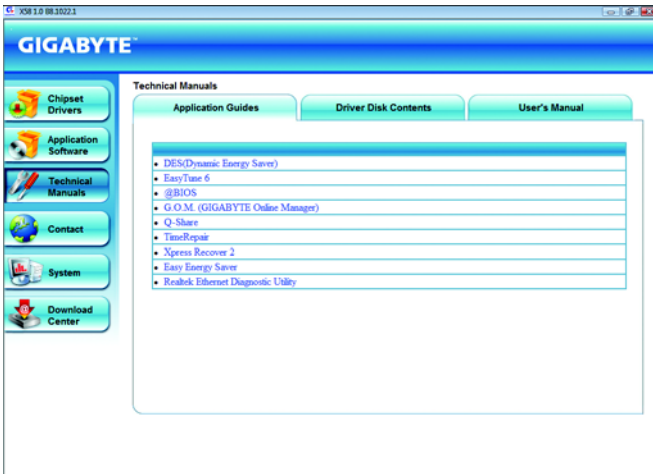



### 3-4 Contact

For the detailed contact information of the GIGABYTE Taiwan headquarter or worldwide branch offices, click the URL on this page to link to the GIGABYTE Website.

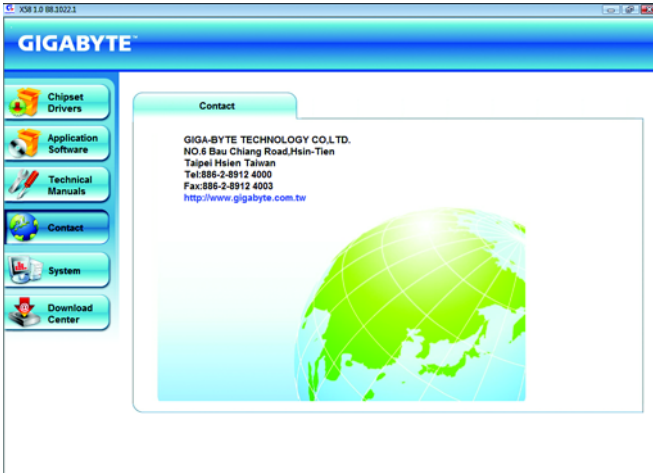

### 3-5 System

This page provides the basic system information.

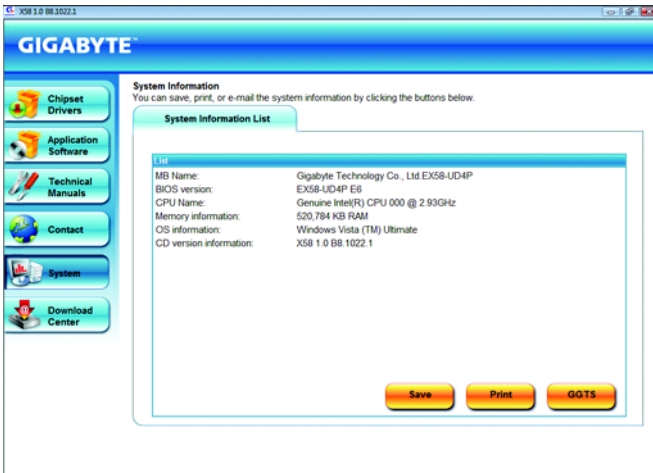

### 3-6 Download Center

To update the BIOS, drivers, or applications, click the **Download Center** button to link to the GIGABYTE Web site. The latest version of the BIOS, drivers, or applications will be displayed.

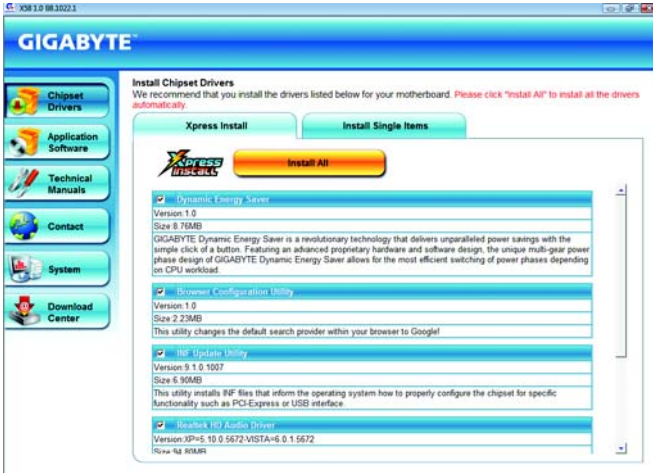

# Chapter 4 Unique Features

## 4-1 Xpress Recovery2



Xpress Recovery2 is a utility that allows you to quickly compress and back up your system data and perform restoration of it. Supporting NTFS, FAT32, and FAT16 file systems, Xpress Recovery2 can back up data on PATA and SATA hard drives and restore it.

### Before You Begin:

- Xpress Recovery2 will check the first physical hard drive\* for the operating system. Xpress Recovery2 can only back up/restore the first physical hard drive that has the operating system installed.
- As Xpress Recovery2 will save the backup file at the end of the hard drive, make sure to leave enough unallocated space in advanced (10 GB or more is recommended; actual size requirements vary, depending on the amount of data).
- It is recommended to back up your system soon after the operating system and drivers are installed.
- The amount of data and hard drive access speed may affect the speed at which the data is backed up/restored.
- It takes longer to back up a hard drive than to restore it.

### System Requirements:

- Intel® platform
- At least 512 MB of system memory
- VESA compatible graphics card
- Windows® XP with SP1 or later, Windows® Vista



- Xpress Recovery and Xpress Recovery2 are different utilities. For example, a backup file created with Xpress Recovery cannot be restored using Xpress Recovery2.
- USB hard drives are not supported.
- Hard drives in RAID/AHCI mode are not supported.

### Installation and Configuration

Turn on your system to boot from the Windows Vista setup disk.

#### A. Installing Windows Vista and Partitioning the Hard Drive

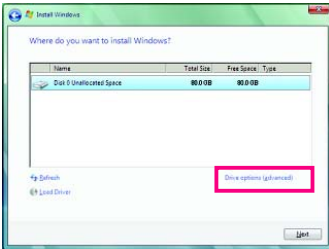

Step 1:  
Click **Drive options**.

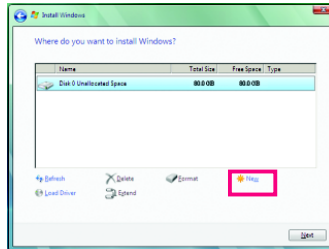

Step 2:  
Click **New**.

\*\*\* Xpress Recovery2 checks the first physical hard drive in the following sequence: The first PATA IDE connector, the second PATA IDE connector, the first SATA connector, the second SATA connector and so forth. For example, when hard drives are attached to the first IDE and the first SATA connectors, the hard drive on the first IDE connector is the first physical drive. When hard drives are attached to the first and second SATA connectors, the hard drive on the first SATA connector is the first physical drive.

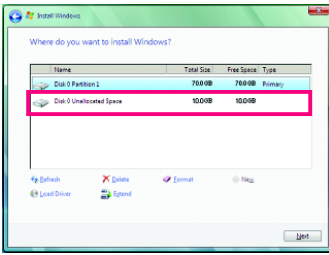

### Step 3:

When partitioning your hard drive, make sure to leave unallocated space (10 GB or more is recommended; actual size requirements vary, depending on the amount of data) and begin the installation of the operating system.



### Step 4:

After the operating system is installed, right-click the **Computer** icon on your desktop and select **Manage**. Go to **Disk Management** to check disk allocation.

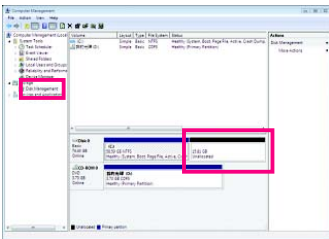

### Step 5:

Xpress Recovery2 will save the backup file to the unallocated space (black stripe along the top). Please note that if there is not enough unallocated space, Xpress Recovery2 cannot save the backup file.

## B. Accessing Xpress Recovery2

1. Boot from the motherboard driver disk to access Xpress Recovery2 for the first time. When you see the following message: `Press any key to startup Xpress Recovery2`, press any key to enter Xpress Recovery2.
2. After you use the backup function in Xpress Recovery2 for the first time, Xpress Recovery2 will stay permanent in your hard drive. If you wish to enter Xpress Recovery2 later, simply press <F9> during the POST.

## C. Using the Backup Function in Xpress Recovery2



### Step 1:

Select **BACKUP** to start backing up your hard drive data.

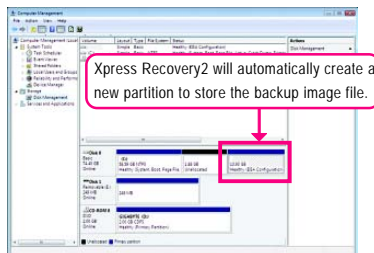

### Step 2:

When finished, go to **Disk Management** to check disk allocation.

## D. Using the Restore Function in Xpress Recovery2



Select **RESTORE** to restore the backup to your hard drive in case the system breaks down. The **RESTORE** option will not be present if no backup is created before.

## E. Removing the Backup



Step 1:

If you wish to remove the backup file, select **REMOVE**.



Step 2:

After the backup file is removed, no backup image file will be present in **Disk Management** and hard drive space will be freed up.

## F. Exiting Xpress Recovery2

Select **REBOOT** to exit Xpress Recovery2.



## 4-2 BIOS Update Utilities

GIGABYTE motherboards provide two unique BIOS update tools, Q-Flash™ and @BIOS™. GIGABYTE Q-Flash and @BIOS are easy-to-use and allow you to update the BIOS without the need to enter MS-DOS mode. Additionally, this motherboard features the DualBIOS™ design, which enhances protection for the safety and stability of your computer by adding one more physical BIOS chip.



### What is DualBIOS™?

Motherboards that support DualBIOS have two BIOS onboard, a main BIOS and a backup BIOS. Normally, the system works on the main BIOS.

However, if the main BIOS is corrupted or damaged, the backup BIOS will take over on the next system boot and copy the BIOS file to the main BIOS to ensure normal system operation. For the sake of system safety, users cannot update the backup BIOS manually.



### What is Q-Flash™?

With Q-Flash you can update the system BIOS without having to enter operating systems like MS-DOS or Window first. Embedded in the BIOS, the

Q-Flash tool frees you from the hassles of going through complicated BIOS flashing process.



### What is @BIOS™?

@BIOS allows you to update the system BIOS while in the Windows environment. @BIOS will download the latest BIOS file from the nearest

@BIOS server site and update the BIOS.

### 4-2-1 Updating the BIOS with the Q-Flash Utility

#### A. Before You Begin:

1. From GIGABYTE's website, download the latest compressed BIOS update file that matches your motherboard model.
2. Extract the file and save the new BIOS file (e.g. ex58ud4p.f1) to your floppy disk, USB flash drive, or hard drive. Note: The USB flash drive or hard drive must use FAT32/16/12 file system.
3. Restart the system. During the POST, press the <End> key to enter Q-Flash. Note: You can access Q-Flash by either pressing the <End> key during the POST or pressing the <F8> key in BIOS Setup. However, if the BIOS update file is saved to a hard drive in RAID/AHCI mode or a hard drive attached to an independent IDE/SATA controller, use the <End> key during the POST to access Q-Flash.

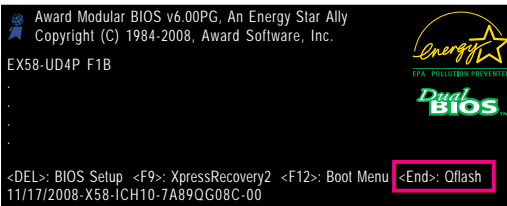

Because BIOS flashing is potentially risky, please do it with caution. Inadequate BIOS flashing may result in system malfunction.

## B. Updating the BIOS

When updating the BIOS, choose the location where the BIOS file is saved. The follow procedure assumes that you save the BIOS file to a floppy disk.

Step 1:

1. Insert the floppy disk containing the BIOS file into the floppy disk drive. In the main menu of Q-Flash, use the up or down arrow key to select **Update BIOS from Drive** and press <Enter>.



- The **Save Main BIOS to Drive** option allows you to save the current BIOS file.
- Q-Flash only supports USB flash drive or hard drives using FAT32/16/12 file system.
- If the BIOS update file is saved to a hard drive in RAID/AHCI mode or a hard drive attached to an independent IDE/SATA controller, use the <End> key during the POST to access Q-Flash.

2. Select **Floppy A** and press <Enter>.

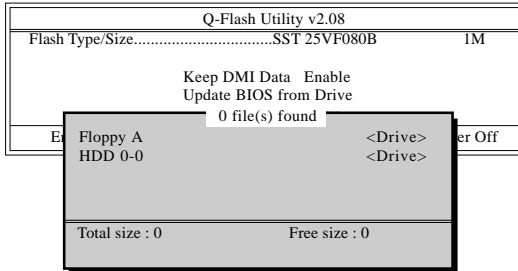

3. Select the BIOS update file and press <Enter>.



Make sure the BIOS update file matches your motherboard model.

Step 2:

The process of the system reading the BIOS file from the floppy disk is displayed on the screen. When the message "Are you sure to update BIOS?" appears, press <Enter> to begin the BIOS update. The monitor will display the update process.



- Do not turn off or restart the system when the system is reading/updating the BIOS.
- Do not remove the floppy disk, USB flash drive, or hard drive when the system is updating the BIOS.

Step 3:

When the update process is complete, press any key to return to the main menu.

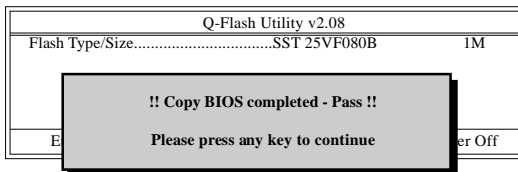

**Step 4:**

Press <Esc> and then <Enter> to exit Q-Flash and reboot the system. As the system boots, you should see the new BIOS version is present on the POST screen.

**Step 5:**

During the POST, press <Delete> to enter BIOS Setup. Select **Load Optimized Defaults** and press <Enter> to load BIOS defaults. System will re-detect all peripherals devices after a BIOS update, so we recommend that you reload BIOS defaults.

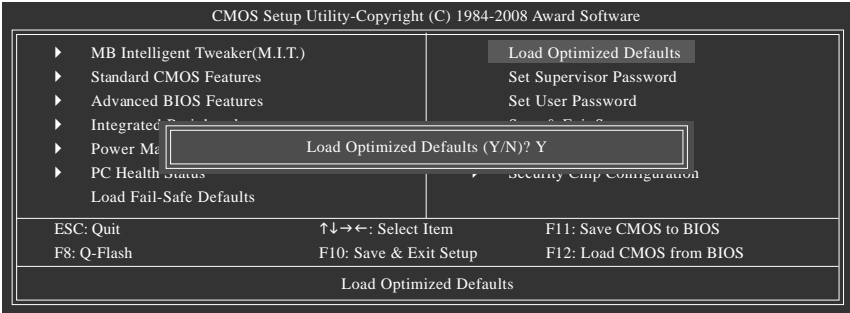

Press <Y> to load BIOS defaults

**Step 6:**

Select **Save & Exit Setup** and then press <Y> to save settings to CMOS and exit BIOS Setup. The procedure is complete after the system restarts.



## 4-2-2 Updating the BIOS with the @BIOS Utility

### A. Before You Begin:

1. In Windows, close all applications and TSR (Terminate and Stay Resident) programs. This helps prevent unexpected failures when performing a BIOS update.
2. During the BIOS update process, ensure the Internet connection is stable and do NOT interrupt the Internet connection (for example, avoid a power loss or switching off the Internet). Failure to do so may result in a corrupted BIOS or a system that is unable to start.
3. Do not use the G.O.M. (GIGABYTE Online Management) function when using @BIOS.
4. GIGABYTE product warranty does not cover any BIOS damage or system failure resulting from an inadequate BIOS flashing.

### B. Using @BIOS:



#### 1. Update the BIOS Using the Internet Update Function:

Click **Update BIOS from GIGABYTE Server**, select the @BIOS server site closest to your location and then download the BIOS file that matches your motherboard model. Follow the on-screen instructions to complete.



If the BIOS update file for your motherboard is not present on the @BIOS server site, please manually download the BIOS update file from GIGABYTE's website and follow the instructions in "Update the BIOS without Using the Internet Update Function" below.

#### 2. Update the BIOS without Using the Internet Update Function:

Click **Update BIOS from File**, then select the location where you save the BIOS update file obtained from the Internet or through other source. Follow the on-screen instructions to complete.

#### 3. Save Current BIOS to File:

Click **Save Current BIOS** to save the current BIOS file.

#### 4. Load BIOS defaults after BIOS Update:

Select the **Load CMOS default after BIOS update** check box and then the system will automatically load BIOS defaults after BIOS update and after the system restarts.

### C. After Updating the BIOS:

Restart your system after updating the BIOS.



Make sure that the BIOS file to be flashed matches your motherboard model. Updating the BIOS with an incorrect BIOS file could cause your system not to boot.

### 4-3 EasyTune 6

GIGABYTE's EasyTune 6 is a simple and easy-to-use interface that allows users to fine-tune their system settings or do overclock/overvoltage in Windows environment. The user-friendly EasyTune 6 interface also includes tabbed pages for CPU and memory information, letting users read their system-related information without the need to install additional software.

#### The EasyTune 6 Interface



#### Tabs Information

Tab	Function
	The <b>CPU</b> tab provides information on the installed CPU and motherboard.
	The <b>Memory</b> tab provides information on the installed memory module(s). You can select memory module on a specific slot to see its information.
	<p>The <b>Tuner</b> tab allows you to adjust system clock settings and voltages.</p> <ul style="list-style-type: none"> <li><b>Quick Boost mode</b> provides you with 3 levels of CPU frequency/base clock to choose to achieve desired system performance. <small>(Note)</small> After making changes in <b>Quick Boost mode</b> or clicking <b>Default</b> to restore to default values, be sure to restart your system for these changes to take effect.</li> <li><b>Easy mode</b> allows you to adjust the CPU base clock only.</li> <li><b>Advanced mode</b> allows you to individually change system clock settings and voltages settings using the sliders.</li> <li><b>Save</b> allows you to save the current settings to a new profile (.txt file).</li> <li><b>Load</b> allows you to load previous settings from a profile.</li> </ul> <p>After making changes in <b>Easy mode/Advanced mode</b>, be sure to click <b>Set</b> for these changes to take effect or click <b>Default</b> to restore to default values.</p>
	The <b>Graphics</b> tab allows you to change the core clock and memory clock for your ATI or NVIDIA graphics card.
	The <b>Smart</b> tab allows you to specify a C.I.A.2 level and a Smart Fan mode. <b>Smart Fan Advance Mode</b> allows the CPU fan speed to be changed linearly based on the CPU temperature thresholds you set.
	The <b>HW Monitor</b> tab allows you to monitor hardware temperature, voltage and fan speed and set temperature/fan speed alarm. You can choose the alert sound from the buzzer or use your own sound file (.wav file).

(Note) Due to the hardware limitation, you must install a DDR3 1066 MHz memory module(s) (or above) to enable support for Quick Boost.

Available functions in EasyTune 6 may differ by motherboard model. Grayed-out area(s) indicates that the item is not configurable or the function is not supported.

Incorrectly doing overclock/overvoltage may result in damage to the hardware components such as CPU, chipset, and memory and reduce the useful life of these components. Before you do the overclock/overvoltage, make sure that you fully know each function of EasyTune 6, or system instability or other unexpected results may occur.

# 4-4 Dynamic Energy Saver Advanced

GIGABYTE Dynamic Energy Saver Advanced<sup>(Note 1)</sup> is a revolutionary technology that delivers unparalleled power savings with a click of the button. Featuring an advanced proprietary hardware and software design, GIGABYTE Dynamic Energy Saver Advanced is able to provide exceptional power savings and enhanced power efficiency without sacrificing computing performance.

## The Dynamic Energy Saver Advanced Interface

### A. Meter Mode

In Meter Mode, GIGABYTE Dynamic Energy Saver Advanced shows how much power they have saved in a set period of time.

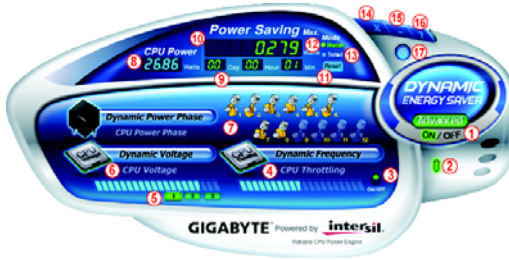

### Meter Mode - Button Information Table

	Button Description
1	Dynamic Energy Saver On/Off Switch (Default: Off)
2	Motherboard Phase LED On/Off Switch (Default: On)
3	Dynamic CPU Frequency Function On/Off Switch (Default: Off) <sup>(Note 2)</sup>
4	CPU Throttling Display
5	3-Level CPU Voltage Switch (Default: 1) <sup>(Note 3)</sup>
6	CPU Voltage Display
7	Dynamic Power Phase Status
8	Current CPU Power Consumption
9	Meter Time
10	Power Saving (Calculate power savings based on time)
11	Meter/Timer Reset Switch
12	Meter Mode Switch
13	Total Mode Switch
14	Close (Application will enter Stealth Mode)
15	Minimize (Application will continue to run in taskbar)
16	INFO/Help
17	Live Utility Update (Check for the latest utility version)

- The above data is for reference only. Actual performance may vary depending on motherboard model.
- CPU Power and Power Scores are for reference only. Actual results may vary based on testing method.

## B. Total Mode

In Total Mode, users are able to see how much total power savings they have accumulated in a set period of time since activating Dynamic Energy Saver Advanced for the first time (Note 4).

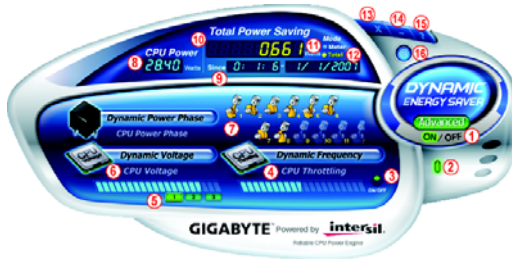

### Total Mode - Button Information Table

	Button Description
1	Dynamic Energy Saver On/Off Switch (Default: Off)
2	Motherboard Phase LED On/Off Switch (Default: On)
3	Dynamic CPU Frequency Function On/Off Switch (Default: Off)
4	CPU Throttling Display
5	3-Level CPU Voltage Switch (Default:1) (Note 3)
6	CPU Voltage Display
7	Dynamic Power Phase Status
8	Current CPU Power Consumption
9	Time/Date Dynamic Energy Saver Enabled
10	Total Power Savings (Total power saving with Dynamic Energy Saver enabled) (Note 5)
11	Dynamic Energy Saver Meter Mode Switch
12	Dynamic Energy Saver Total Mode Switch
13	Close (Application will enter Stealth Mode)
14	Minimize (Application will continue to run in taskbar)
15	INFO/Help
16	Live Utility Update (Check for the latest utility version)

## C. Stealth Mode

In Stealth Mode, the system continues to work with the user-defined power saving settings, even after the system is restarted. Re-enter the application only if you want to make any changes or completely close the application.

(Note 1) Before using the DES function, make sure the **CPU Enhanced Halt (C1E)** and **CPU EIST Function** items in the BIOS Setup program are set to **Enabled**.

(Note 2) Maximize system power saving with Dynamic Frequency Function; system performance may be affected.

(Note 3) 1: Normal Power Saving (default); 2: Advanced Power Saving; 3: Extreme Power Saving.

(Note 4) The total amount of power saved will be recorded until re-activated when only the Dynamic Power Saver is under the enable status, and power savings meter is unable to reset to zero.

(Note 5) Dynamic Energy Saver Meter will automatically reset when the total power saving reaches 99999999 Watts.

# 4-5 Ultra TPM

GIGABYTE's unique Ultra TPM (Trusted Platform Module) features the industry's most advanced hardware-based data encryption design. With the easy-to-use Ultra TPM user interface, users can store/back up their TPM keys on a USB flash drive or in the system BIOS. The TPM key(s) will be removed from the computer after being stored on a USB flash drive (or in the system BIOS), protecting against unauthorized access to the computer. By simply plugging or unplugging the USB flash drive, users are able to open or close their PSD files without the hassles of complicated configurations. In addition, Ultra TPM's key backup function allows users to still have a way to access their data in case the keys are lost.



- After creating the password(s) and key(s) associated the TPM, be sure to store them in a secure location and back them up. Loss of the password(s) or the key(s) will render the files encrypted via the TPM unable to be cracked or read.
- Though the TPM delivers the latest data security technology, it does not guarantee data integrity or give hardware protection. GIGABYTE is not liable for loss of encrypted data as a result of hardware damage.

## A. Before installing Ultra TPM, follow the steps below in sequence:

Step 1:

Turn on your computer and enter the BIOS Setup program. Go to **Security Chip Configuration** and set **Security Chip** to **Enabled**. Then enter **Clear Security Chip** to clear all settings in the TPM chip. (Refer to Chapter 2, "BIOS Setup," for more information.) Save changes and then restart your computer.



Encrypted files will become inaccessible after the TPM chip is cleared. Be sure to back up the encrypted files first.

Step 2:

Install the Infineon TPM driver from the motherboard driver disk (select **Infineon TPM Driver**).

Step 3:

Install the Ultra TPM utility from the motherboard driver disk (select **Ultra TPM**).

## B. Instructions for using Ultra TPM:

1. Before launching Ultra TPM, go to the Infineon Security Platform Settings Tool to initialize the TPM chip and then encrypt the files you want. (You have to at least set up a Personal Secure Drive (PSD). Refer to the Infineon Security Platform Help file to see how to set up the PSD.)
2. The Ultra TPM utility appears in the system tray after it is installed. To create a TPM key and save it to USB flash drive(s), right-click on the Ultra TPM icon  and select **Initialize**. A screen in Figure 1 will appear. Select a USB flash drive and click the **Enable Backup to BIOS**<sup>(Note 1)</sup> check box, or select at least two USB flash drives. Click **OK** and then enter the user password<sup>(Note 2)</sup> created with Infineon Security Platform Settings Tool. Click **OK** to store the key on your USB flash drive or in the BIOS.

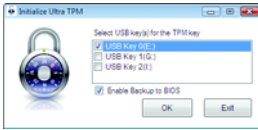



DO NOT turn off or restart the computer when a TPM key is being created.

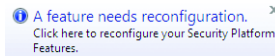

After completing the settings and when removing the USB flash drive(s), the Infineon Security Platform Settings Tool will give the following warning message, which is normal.

Figure 1



3. To duplicate a TPM key to another USB flash drive, right-click on the Ultra TPM icon  and select **Duplicate**. A screen in Figure 2 will appear. Select the drive letter of the source USB flash drive and then select the drive letter of the destination USB flash drive. Click **OK** to complete.

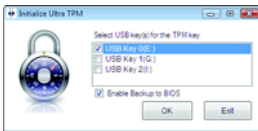

Figure 2

- (Note 1) When more than one user stores their TPM keys in the BIOS, the latter key will replace the former key.
- (Note 2) If you incorrectly enter the password three times, Ultra TPM will be locked. To be able to enter the password again, go to the **Security Chip Configuration** menu in BIOS Setup and then set **Security Chip** to **Enabled/Activate**.
- (Note 3) If you want to uninstall the Ultra TPM utility, be sure to insert the USB flash drive containing the TPM key into your computer before the uninstallation.

## 4-6 Q-Share

Q-Share is an easy and convenient data sharing tool. After configuring your LAN connection settings and Q-Share, you are able to share your data with computers on the same network, making full use of Internet resources.



### Directions for using Q-Share

After installing Q-Share from the motherboard driver disk, go to Start>All Programs>GIGABYTE>Q-Share.exe to launch the Q-Share tool. Find the **Q-Share** icon  in your system tray and right-click on this icon to configure the data sharing settings.



Figure 1. Data Sharing Disabled



Figure 2. Data Sharing Enabled

### Options Descriptions

Option	Description
Connect ...	Displays the computers with data sharing enabled
Enable Incoming Folder ...	Enables data sharing
Disable Incoming Folder ...	Disables data sharing
Open Incoming Folder : C:\Q-ShareFolder	Accesses the shared data folder
Change Incoming Folder : C:\Q-ShareFolder	Changes the data folder to be shared <sup>(Note)</sup>
Update Q-Share ...	Updates Q-Share online
About Q-Share ...	Displays the current Q-Share version
Exit...	Exits Q-Share

(Note) This option is available only when data sharing is NOT enabled.

# 4-7 Time Repair

Based on the Microsoft Volume Shadow Copy Services technology, Time Repair allows you to quickly back up and restore your system data in the Windows Vista operating system. Time Repair supports NTFS file system and can restore system data on PATA and SATA hard drives.

## System Restore

Choose a system restore point using the navigation bar on the right or at the bottom of the screen to view the system data backed up at different time. You can choose file(s)/directory(ies) and click the **Copy** button to restore the file(s)/directory(ies) or click **Restore** to restore the entire system.



## Preference Screen:

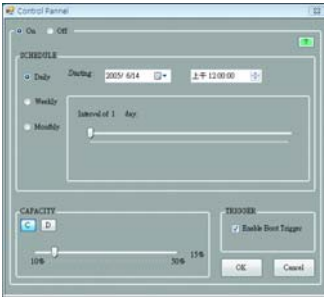

Button	Function
ON	Automatically creates system restore points
OFF	DO NOT automatically create system restore points
SCHEDULE	Sets a regular interval for creating system restore points
CAPACITY	Sets the percentage of hard drive space used for saving shadow copies
TRIGGER	Creates a system restore point upon the first boot up of the day
?	Displays the Time Repair help file



- The hard drive used must have more than 1 GB of capacity and over 300 MB of available space.
- Each storage volume can accommodate 64 shadow copies. When this limit is reached, the oldest shadow copy will be deleted and unable to be restored. Shadow copies are read-only so you cannot edit the contents of a shadow copy.





## Chapter 5 Appendix

### 5-1 Configuring SATA Hard Drive(s)

To configure SATA hard drive(s), follow the steps below:

- A. Install SATA hard drive(s) in your computer.
- B. Configure SATA controller mode in BIOS Setup.
- C. Configure a RAID array in RAID BIOS. <sup>(Note 1)</sup>
- D. Make a floppy disk containing the SATA RAID/AHCI driver. <sup>(Note 2)</sup>
- E. Install the SATA RAID/AHCI driver and operating system. <sup>(Note 2)</sup>

#### Before you begin

Please prepare:

- At least two SATA hard drives (to ensure optimal performance, it is recommended that you use two hard drives with identical model and capacity). If you do not want to create RAID, you may prepare only one hard drive.
- An empty formatted floppy disk.
- Windows Vista/XP setup disk.
- Motherboard driver disk.

#### 5-1-1 Configuring Intel ICH10R SATA Controllers

##### A. Installing SATA hard drive(s) in your computer

Attach one end of the SATA signal cable to the rear of the SATA hard drive and the other end to available SATA port on the motherboard. If there is more than one SATA controller on your motherboard, refer to "Chapter 1," "Hardware Installation," to identify the SATA controller for the SATA port. (For example, on this motherboard, the SATA2\_0, SATA2\_1, SATA2\_2, SATA2\_3, SATA2\_4 and SATA2\_5 ports are supported by ICH10R Southbridge.) Then connect the power connector from your power supply to the hard drive.

(Note 1) Skip this step if you do not want to create RAID array on the SATA controller.

(Note 2) Required when the SATA controller is set to AHCI or RAID mode.

## B. Configuring SATA controller mode in BIOS Setup

Make sure to configure the SATA controller mode correctly in system BIOS Setup .

### Step 1:

Turn on your computer and press <Delete> to enter BIOS Setup during the POST (Power-On Self-Test). To create RAID, set **SATA RAID/AHCI Mode** under the **Integrated Peripherals** menu to **RAID** (Figure 1)(Disabled by default). If you do not want to create RAID, set this item to **Disabled** or **AHCI**.

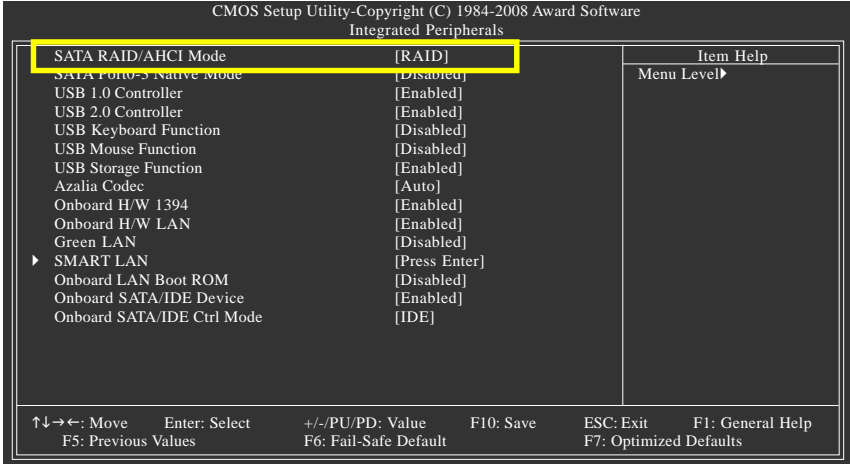

Figure 1

### Step 2:

Save changes and exit BIOS Setup.



The BIOS Setup menus described in this section may differ from the exact settings for your motherboard. The actual BIOS Setup menu options you will see shall depend on the motherboard you have and the BIOS version.

### C. Configuring a RAID array in RAID BIOS

Enter the RAID BIOS setup utility to configure a RAID array. Skip this step and proceed with the installation of Windows operating system for a non-RAID configuration.

#### Step 1:

After the POST memory test begins and before the operating system boot begins, look for a message which says "Press <Ctrl-I> to enter Configuration Utility" (Figure 2). Press <Ctrl> + <I> to enter the RAID Configuration Utility.

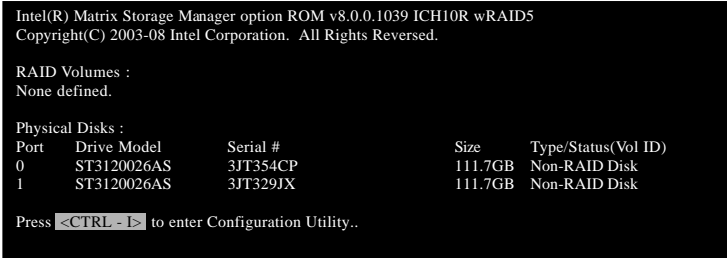

Figure 2

#### Step 2:

After you press <Ctrl> + <I>, the **MAIN MENU** screen will appear (Figure 3).

#### Create RAID Volume

If you want to create a RAID array, select **Create RAID Volume** in **MAIN MENU** and press <Enter>.

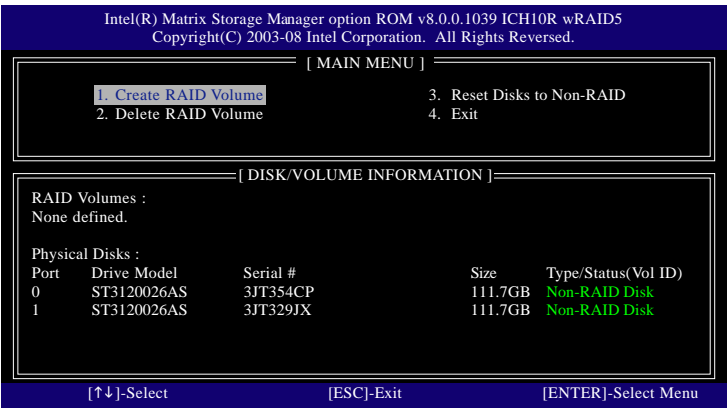

Figure 3

Step 3:

After entering the **CREATE VOLUME MENU** screen, enter a volume name with 1-16 letters (letters cannot be special characters) under the **Name** item and press <Enter>. Then, select a RAID level (Figure 4). There are four RAID levels supported: RAID 0, RAID 1, RAID 10 and RAID 5 (the selections available depend on the number of the hard drives being installed). Press <Enter> to proceed.

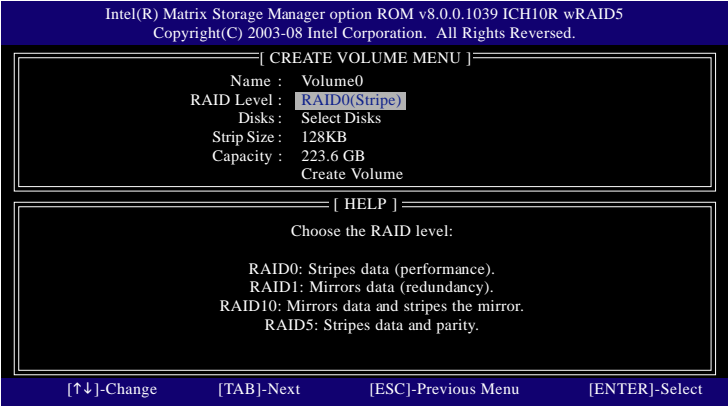

Figure 4

Step 4:

Under **Disks** item, select the hard drives to be included in the RAID array. If only two hard drives are installed, they will be automatically assigned to the array. Set the stripe block size (Figure 5) if necessary. The stripe block size can be set from 4 KB to 128 KB. Once you have selected the stripe block size, press <Enter>.

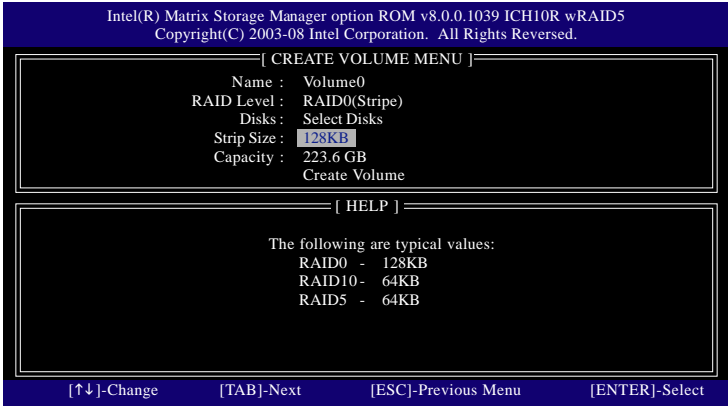

Figure 5

Step 5:

Enter the array capacity and press <Enter>. Finally press <Enter> on the **Create Volume** item to begin creating the RAID array. When prompted to confirm whether to create this volume, press <Y> to confirm or <N> to cancel (Figure 6).

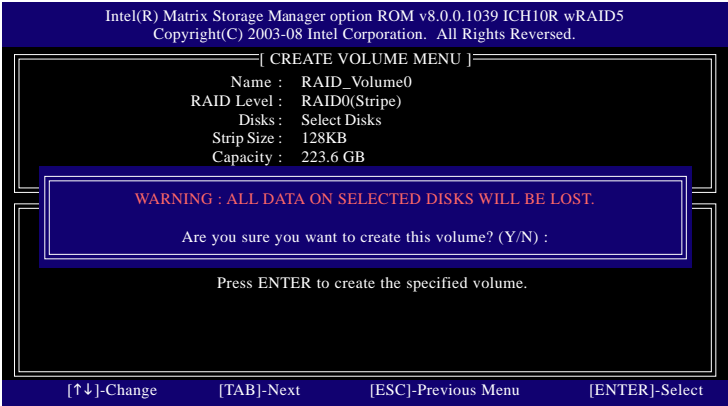

Figure 6

When completed, you can see detailed information about the RAID array in the **DISK/VOLUME INFORMATION** section, including the RAID level, stripe block size, array name, and array capacity, etc. (Figure 7)

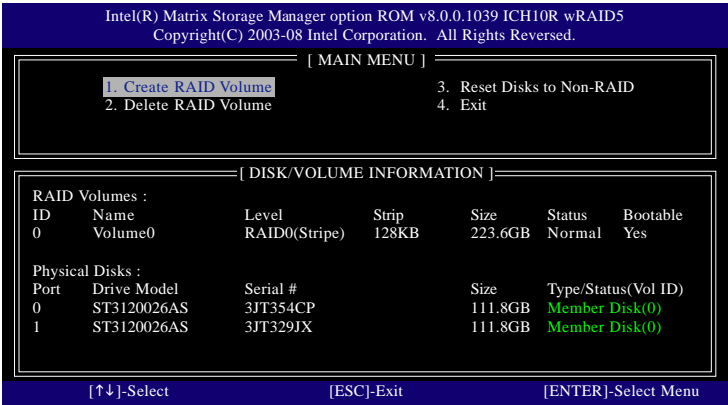

Figure 7

To exit the ICH10R RAID BIOS utility, press <Esc> or select **Exit** in **MAIN MENU**.

Now, you can proceed to create the SATA RAID/AHCI driver diskette and install the SATA RAID/AHCI driver and operating system.

## Delete RAID Volume

To delete a RAID array, select **Delete RAID Volume** in **MAIN MENU** and press <Enter>. In the **DELETE VOLUME MENU** section, use the up or down arrow key to select the array to be deleted and press <Delete>. When prompted to confirm your selection (Figure 8), press <Y> to confirm or <N> to abort.

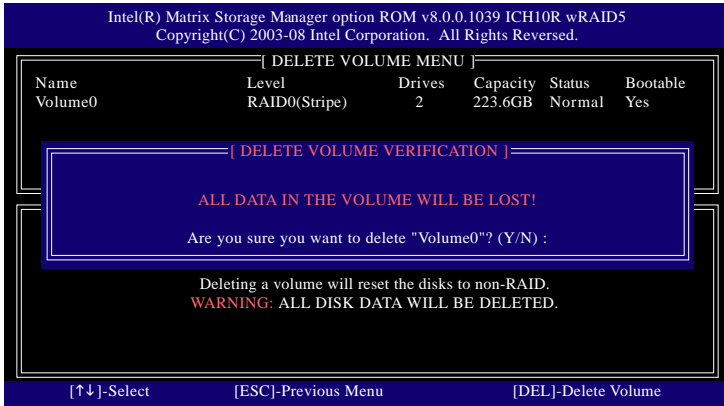

Figure 8

## 5-1-2 Configuring GIGABYTE SATA2 SATA Controller

### A. Installing SATA hard drive(s) in your computer

Attach one end of the SATA signal cable to the rear of the SATA hard drive and the other end to available SATA port on the motherboard. If there is more than one SATA controller on your motherboard, refer to "Chapter 1," Hardware Installation," to identify the SATA controller for the SATA port. (For example, on this motherboard, the GSATA2\_0 and GSATA2\_1 ports are supported by GIGABYTE SATA2.) Then connect the power connector from your power supply to the hard drive.

### B. Configuring SATA controller mode and device boot order in BIOS Setup

Make sure to configure the SATA controller mode correctly in system BIOS Setup and set the device boot order.

Step 1:

Turn on your computer and press <Delete> to enter BIOS Setup during the POST. In BIOS Setup, go to **Integrated Peripherals**, ensure that **Onboard SATA/IDE Device** is enabled. Then set **Onboard SATA/IDE Ctrl Mode** to **RAID/IDE** (Figure 1). If you do not want to create RAID, set this item to **IDE** or **AHCI**, depending on your need.

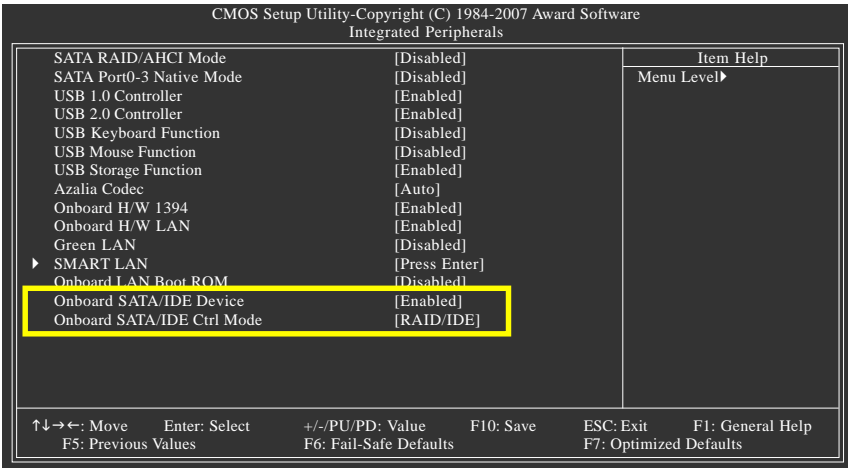

Figure 1

Step 2:

Save changes and exit BIOS Setup.



The BIOS Setup menus described in this section may differ from the exact settings for your motherboard. The actual BIOS Setup menu options you will see shall depend on the motherboard you have and the BIOS version.

### C. Configuring a RAID array in RAID BIOS

Enter the RAID BIOS setup utility to configure a RAID array. Skip this step and proceed to the installation of Windows operating system for a non-RAID configuration.

After the POST memory test begins and before the operating system boot begins, look for a message which says "Press <Ctrl-G> to enter RAID Setup Utility" (Figure 2). Press <Ctrl> + <G> to enter the GIGABYTE SATA2 RAID BIOS utility.



Figure 2

In the main screen of the GIGABYTE SATA2 RAID BIOS utility (Figure 3), use the up or down arrow key to highlight through choices in the **Main Menu** block. Highlight the item that you wish to execute and press <Enter>.

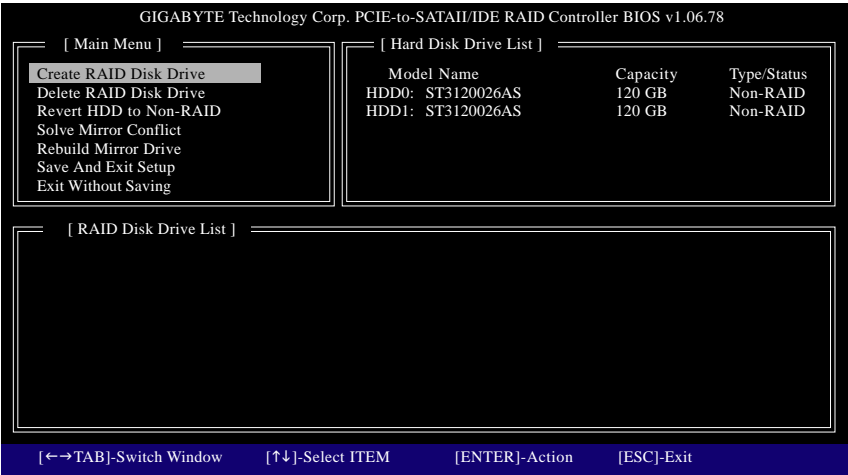

Figure 3

**Note:** In the main screen, you can select a hard drive in the **Hard Disk Drive List** block and press <Enter> to see detailed information about the selected hard drive.



### Create a RAID Array:

In the main screen, press <Enter> on the **Create RAID Disk Drive** item. Then the **Create New RAID** screen appears (Figure 4).

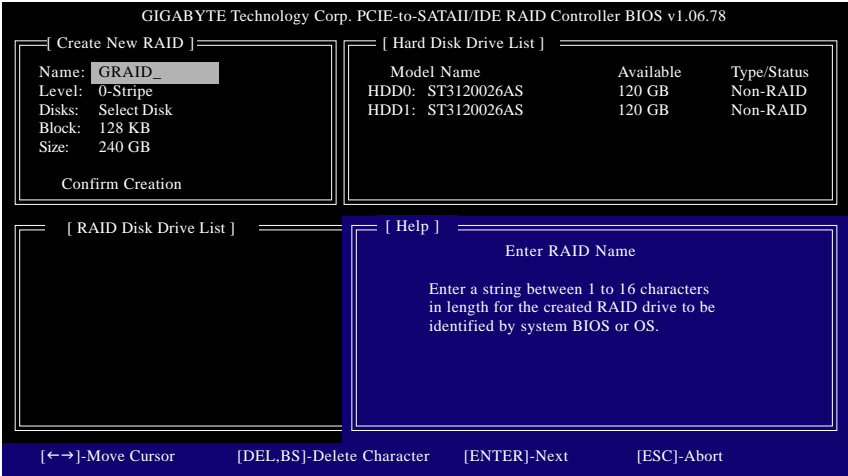

Figure 4

The **Create New RAID** block displays all the items that need to be set for creating an array (Figure 5).

### Steps:

1. **Enter Array Name:** Under the **Name** item, enter an array name with 1-16 letters (letters cannot be special characters) and press <Enter>.
2. **Select RAID Mode:** Under the **Level** item, use up or down arrow key to select RAID 0 (Stripe), RAID 1 (Mirror), or JBOD (Figure 5). Then press <Enter> to move onto the next step.

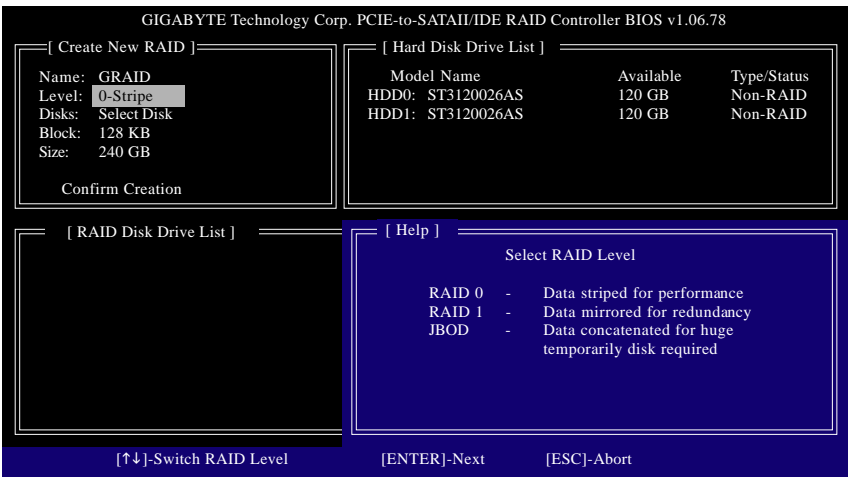

Figure 5

3. **Assign Array Disks:** After a RAID mode is selected, RAID BIOS automatically assigns the two hard drives installed as the RAID drives.
4. **Set Block Size (RAID 0 only):** Under the **Block** item, use the up or down arrow key to select the stripe block size (Figure 6), ranging from 4 KB to 128 KB. Press <Enter>.

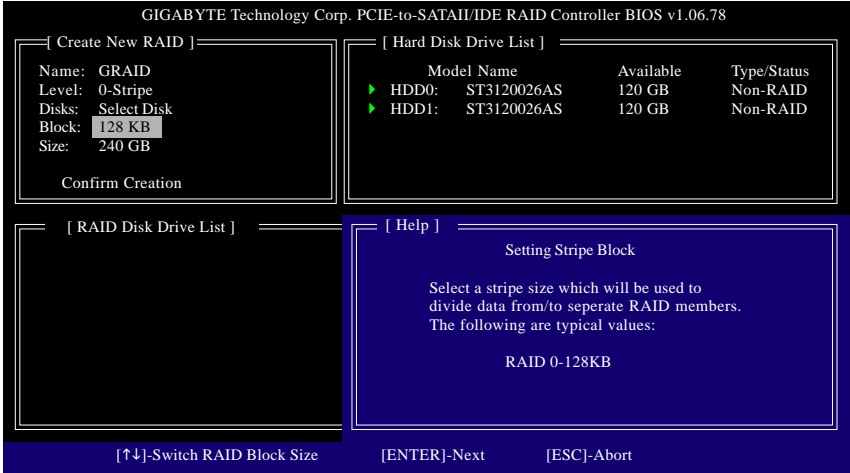

Figure 6

5. **Set Array Size:** Under the **Size** item, enter the size of the array and press <Enter>.
6. **Confirm Creation:** After all of the items above are configured, the selection bar automatically jumps to the **Confirm Creation** item. Press <Enter>. When prompted to confirm your selection (Figure 7), press <Y> to confirm or <N> to abort.

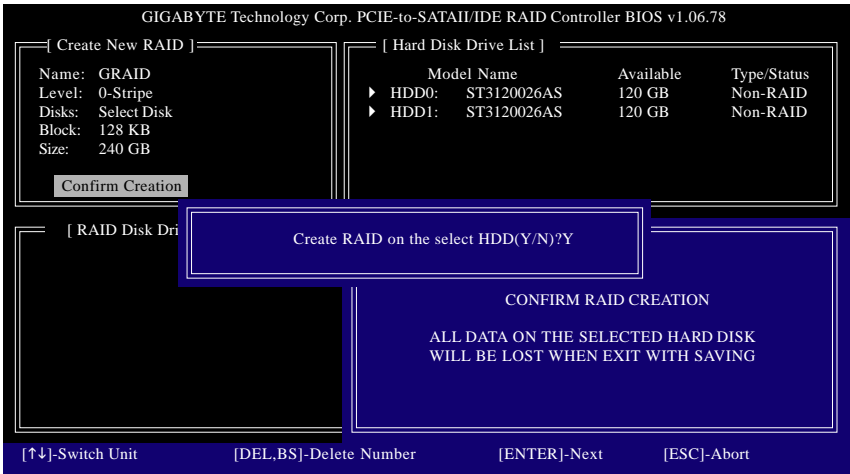

Figure 7

When finished, the new RAID array will be displayed in the **RAID Disk Drive List** block (Figure 8).

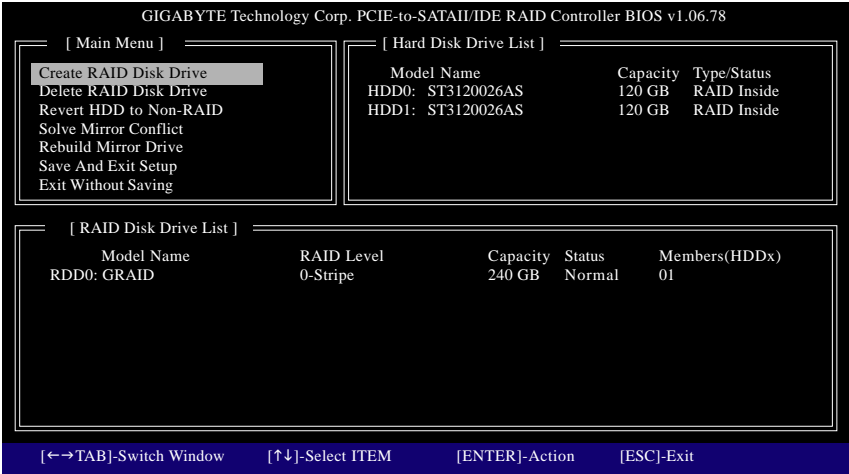

Figure 8

To check more detailed information about the array, use the <Tab> key while in the **Main Menu** block to move the selection bar to the **RAID Disk Drive List** block. Select the array and press <Enter>. A small window displaying the array information will appear in the center of the screen (Figure 9).

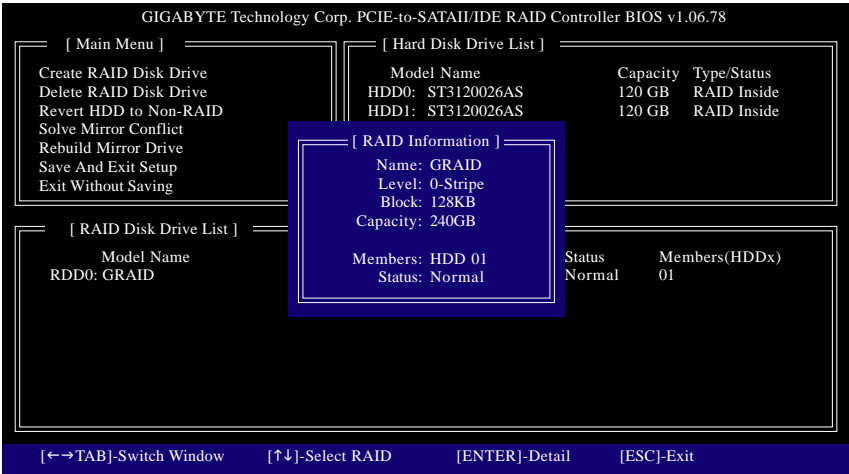

Figure 9

**7. Save and Exit Setup:** After configuring the RAID array, select the **Save And Exit Setup** item in the main screen to save your settings before exiting the RAID BIOS utility, then press <Y> (Figure 10).

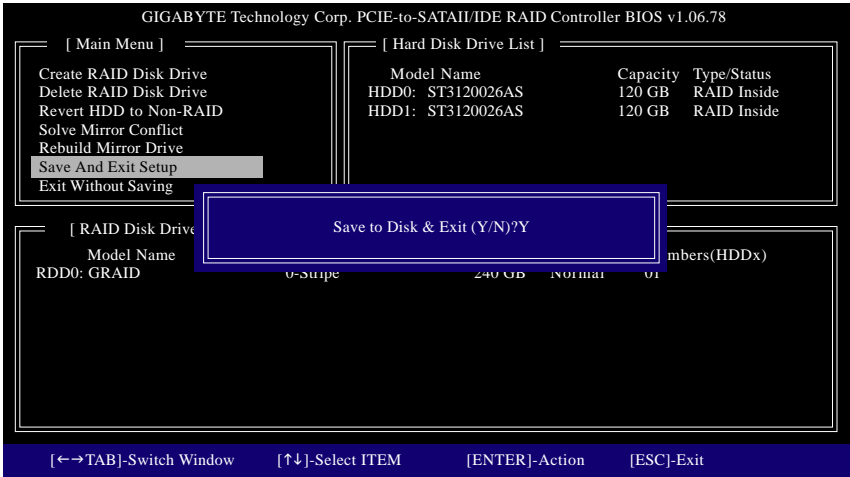

Figure 10

Now, you may proceed to create the SATA RAID/AHCI driver diskette and the installation of the SATA RAID/AHCI driver and operating system.

**Delete the RAID Array:**

To delete the array, select **Delete RAID Disk Drive** in the main menu and press <Enter>. The selection bar will move to the **RAID Disk Drive List** block. Press the space bar on the array to be deleted; a small triangle will appear to mark the selected array. Press <Delete>. When prompted to confirm your selection (Figure 11), press <Y> to confirm or <N> to cancel.

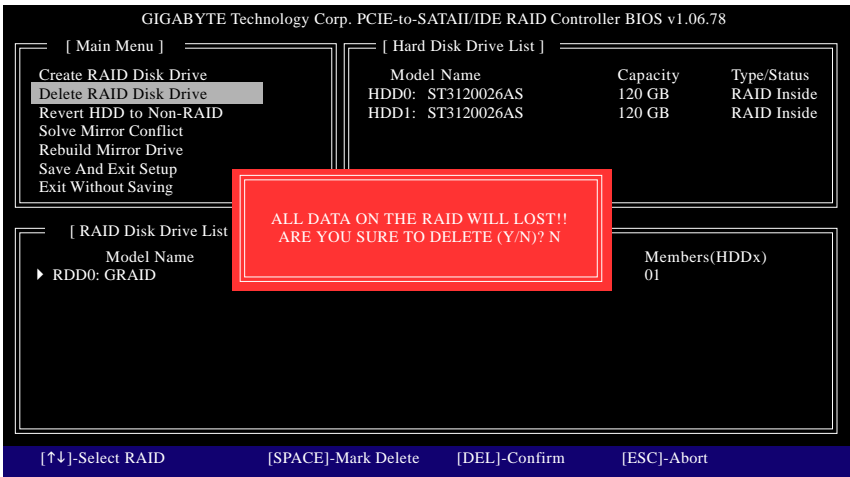

Figure 11

### 5-1-3 Making a SATA RAID/AHCI Driver Diskette (Required for AHCI and RAID Mode)

To successfully install operating system onto SATA hard drive(s) that is/are configured to RAID/AHCI mode, you need to install the SATA controller driver during the OS installation. Without the driver, the hard drive may not be recognized during the Windows setup process. First of all, copy the driver for the SATA controller from the motherboard driver disk to a floppy disk. See the instructions below about how to copy the driver in MS-DOS mode<sup>(Note)</sup>. Prepare a startup disk that has CD-ROM support and a blank formatted floppy disk.

Step 1: Insert the prepared startup disk and motherboard driver disk in your system. Boot from the startup disk. Once at the A:\> prompt, change to your optical drive (example: D:\>). At the D:\> prompt, type the following two commands. Press <Enter> after each command (Figure 1):

```
cd bootdrv
menu
```

Step 2: When the controller menu (Figure 2) appears, remove the startup disk and insert the blank formatted disk. Select the controller driver by pressing the corresponding letter from the menu and press <Enter>. For example, from the menu in Figure 2:

- For Intel ICH10R SATA controllers, select **1)Intel Matrix Storage driver for 32bit system** for Windows 32-bit operating system or **2)Intel Matrix Storage driver for 64bit system** for Windows 64-bit.
- For GIGABYTE SATA2 SATA controller, select **3)GIGABYTE GSATA driver for 32bit system** for Windows 32-bit operating system or **4)GIGABYTE GSATA driver for 64bit system** for Windows 64-bit.

Your system will then automatically zip and transfer this driver file to the floppy disk. Press any key to exit when finished.

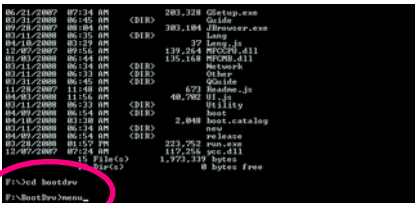

Figure 1

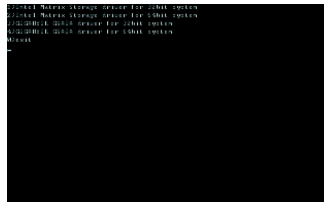

Figure 2

(Note ) For users without a startup disk:

Use an alternative system and insert the motherboard driver disk. From your optical drive folder, double click the **Menu.exe** file in the **BootDrv** folder (Figure 3). A command prompt window will open similar to that in Figure 2.

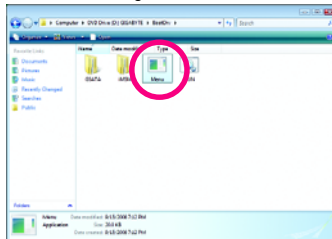

Figure 3

## 5-1-4 Installing the SATA RAID/AHCI Driver and Operating System

With the SATA RAID/AHCI driver diskette and correct BIOS settings, you are ready to install Windows Vista/XP onto your hard drive(s). The followings are examples of Windows XP and Vista installation.

### A. Installing Windows XP

Step 1:

Restart your system to boot from the Windows XP setup disk and press <F6> as soon as you see the message "Press F6 if you need to install a 3rd party SCSI or RAID driver" (Figure 1). A screen will then appear asking you to specify additional device.



Figure 1

Step 2:

For Intel ICH10R SATA controllers:

Insert the floppy disk containing the SATA RAID/AHCI driver and press <S>. Then a controller menu similar to Figure 2 below will appear. Select **Intel(R) ICH8R/ICH9R/ICH10R/DO SATA RAID Controller** and press <Enter>.

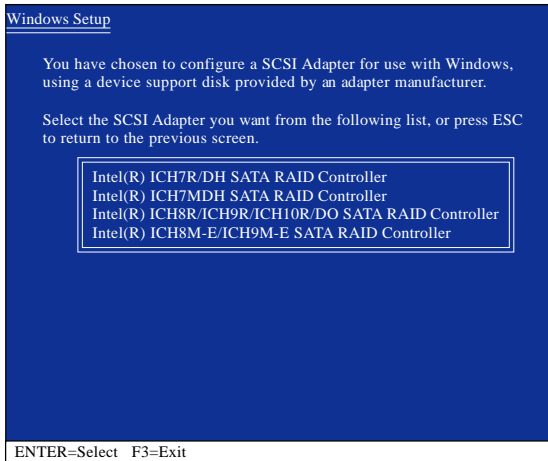

Figure 2

For GIGABYTE SATA2 SATA controller:

Insert the floppy disk containing the SATA RAID/AHCI driver and press <S>. Then a controller menu similar to Figure 3 below will appear. Select **(Windows XP/2003) RAID/AHCI Driver for GIGABYTE GBB36X Controller** and press <Enter>.

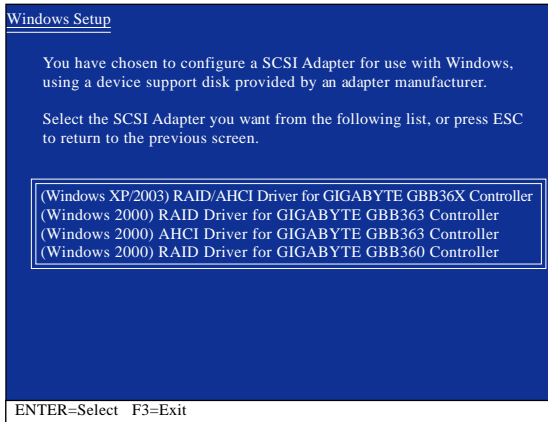

Figure 3

**Step 3:**

On the next screen, press <Enter> to continue the driver installation. After the driver installation, you can proceed with the Windows XP installation.

## B. Installing Windows Vista

(The procedure below assumes that only one RAID array exists in your system.)

### Intel ICH10R SATA controllers:

Step 1:

Restart your system to boot from the Windows Vista setup disk and perform standard OS installation steps. When a screen similar to that below appears, select **Load Driver** (Figure 4).

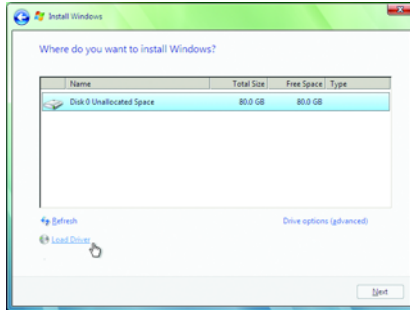

Figure 4

Step 2:

Insert the motherboard driver disk (Method A) or the floppy disk/USB flash drive that contains the SATA RAID/AHCI driver (Method B), then specify the location of the driver (Figure 5). Note: For users using a SATA optical drive, be sure to copy the driver files from the motherboard driver disk to a USB flash drive before installing Windows Vista (go to the **BootDrv** folder and save the whole **iMSM** folder to the USB flash drive). Then use Method B to load the driver.

Method A:

Insert the motherboard driver disk into your system and browse to the following directory:

**\BootDrv\iMSM\32Bit**

For Windows Vista 64-bit, browse to the **64Bit** folder.

Method B:

Insert the USB flash drive containing the driver files and browse to **\iMSM\32Bit** (for Windows Vista 32-bit) or **\iMSM\64Bit** (for Windows Vista 64-bit).

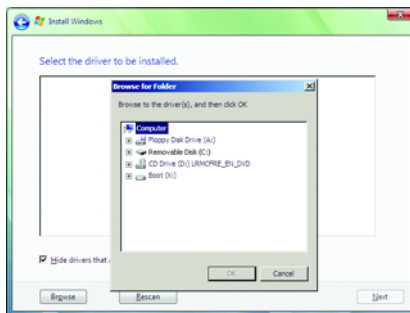

Figure 5



Step 3:

When a screen as shown in Figure 6 appears, select **Intel(R) ICH8R/ICH9R/ICH10R/DO SATA RAID Controller** and click **Next**.

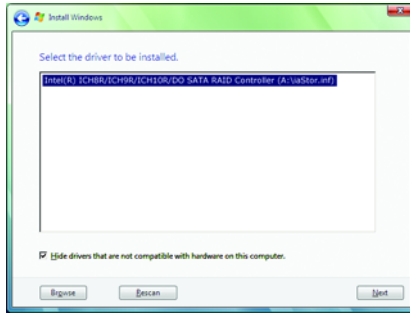

Figure 6

Step 4:

After the driver is loaded, select the RAID/AHCI drive(s) where you want to install the operating system and then click **Next** to continue the OS installation (Figure 7).

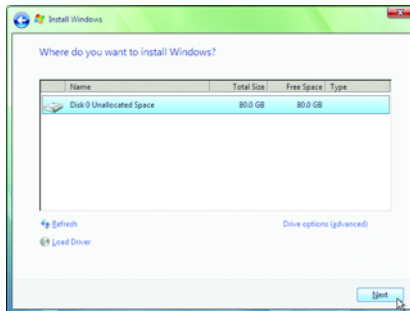

Figure 7

## GIGABYTE SATA2 SATA controller:

### Step 1:

Restart your system to boot from the Windows Vista setup disk and perform standard OS installation steps. When a screen similar to that below appears (RAID/AHCI hard drive(s) will not be detected at this stage), select **Load Driver** (Figure 8).

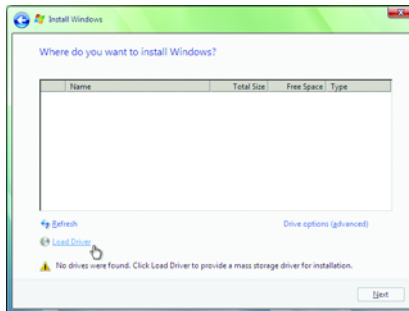

Figure 8

### Step 2:

Insert the motherboard driver disk (Method A) or the floppy disk/USB flash drive that contains the SATA RAID/AHCI driver (Method B), then specify the location of the driver (Figure 9). Note: For users using a SATA optical drive, be sure to copy the driver files from the motherboard driver disk to a USB flash drive before installing Windows Vista (go to the **BootDrv** folder and save the whole **GSATA** folder to the USB flash drive). Then use Method B to load the driver.

#### Method A:

Insert the motherboard driver disk into your system and browse to the following directory:

**\\BootDrv\\GSATA\\32Bit**

For Windows Vista 64-bit, browse to the **64Bit** folder.

#### Method B:

Insert the USB flash drive containing the driver files and browse to **\\GSATA\\32Bit** (for Windows Vista 32-bit) or **\\GSATA\\64Bit** (for Windows Vista 64-bit).

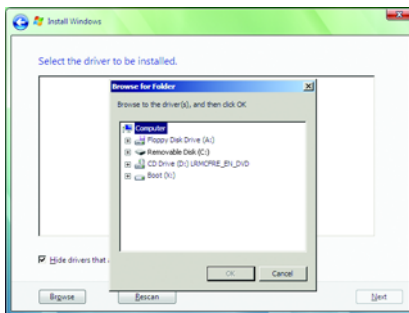

Figure 9

Step 3:

When a screen as shown in Figure 10 appears, select **GIGABYTE GBB36X Controller (A:\raid\_1.inf)** and press **Next**.

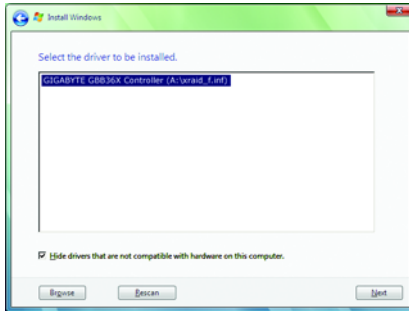

Figure 10

Step 4:

After the driver is loaded, select the RAID/AHCI drive(s) where you want to install the operating system and then press **Next** to continue the OS installation (Figure 11).

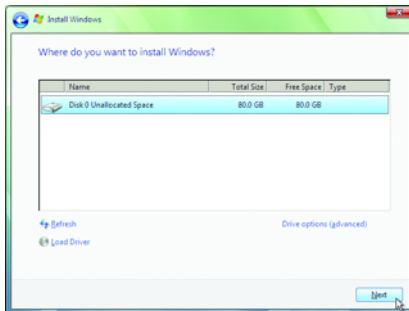

Figure 11

## Rebuilding an Array

Rebuilding is the process of restoring data to a hard drive from other drives in the array. Rebuilding applies only to fault-tolerant arrays such as RAID 1, RAID 5, or RAID 10 arrays. The procedures below assume a new drive is added to replace a failed drive to rebuild a RAID 1 array. (Note: The new drive must have equal or greater capacity than the old one.)

Intel® ICH10R SATA controller:

Turn off your computer and replace the failed hard drive with a new one. Restart your computer.

### Enabling Automatic Rebuild

Step 1:

When the message "Press <Ctrl-I> to enter Configuration Utility" appears, press <Ctrl> + <I> to enter the RAID Configuration Utility. The following screen appears after you enter the RAID Configuration Utility.

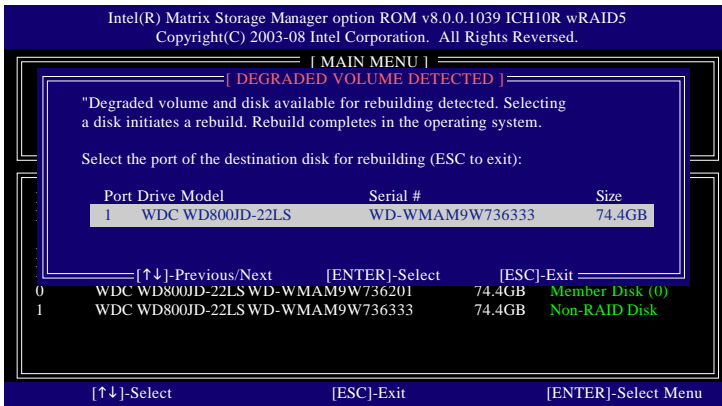

Step 2:

Select the new hard drive to add into the array to be rebuilt and press <Enter>. The following screen appears, indicating that an automatic rebuild will be performed automatically after you enter the operating system (look for the **Intel Storage Console** icon  in the notification area, which will show that a RAID volume is being rebuilt). If you do not enable automatic rebuild on this stage, you have to manually rebuild the array in the operating system (see the next page for more details).

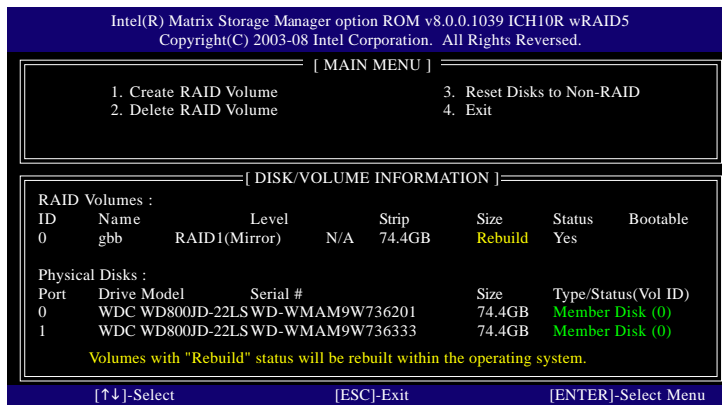

## Performing the Rebuild in the Operating System

While in the operating system, make sure the chipset driver has been installed from the motherboard driver disk. Then launch the Intel® Matrix Storage Console from **All Programs** in the **Start** menu.

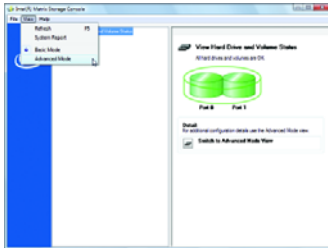

Step 1:

On the **View** menu of the Intel Matrix Storage Console, select **Advanced Mode** for a more detailed view of the storage device information.

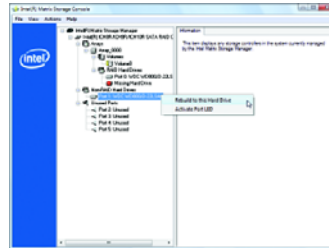

Step 2:

The new hard drive appears under **Non-RAID Hard Drive**. Right-click on the new hard drive and select **Rebuild to this Hard Drive**.



Step 3:

Click **Next** when the **Rebuild RAID Volume Wizard** appears. Follow the on-screen instructions to proceed.

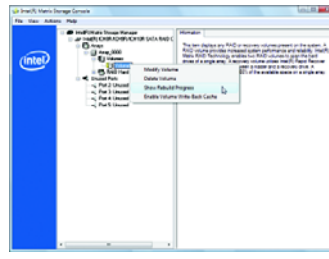

Step 4:

To check the rebuild status during the rebuild process, right-click on the rebuild volume and select **Show Rebuild Progress**.

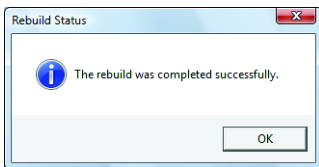

Step 5:

When the message "The rebuild was completed successfully," appears, click **OK** to complete.

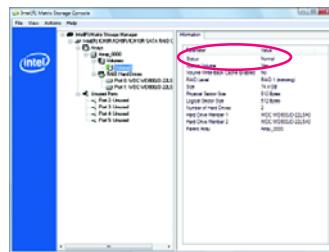

Step 6:

After the RAID 1 volume rebuilding, click the volume and its status in the information pane will display as **Normal**.

GIGAGYTE SATA2 SATA controller:

Turn off your computer and replace the failed hard drive with a new one. Use either the GIGABYTE SATA2 RAID BIOS utility or the GIGABYTE RAID CONFIGURER utility in the operating system to perform the rebuild.

### Rebuilding with the GIGABYTE SATA2 RAID BIOS utility

Step 1:

When the message "Press <Ctrl-G> to enter RAID Setup Utility" appears, press <Ctrl> + <G> to enter the utility. In the **Main Menu** block, select **Rebuild Mirror Drive** and press <Enter>. The selection bar will move to the degraded array. Press <Enter> again.

GIGABYTE Technology Corp. PCIE-to-SATAII/IDE RAID Controller BIOS v1.06.78

[ Main Menu ]		[ Hard Disk Drive List ]			
Create RAID Disk Drive		Model Name	Capacity	Type/Status	
Delete RAID Disk Drive		HDD0: ST3120026AS	120 GB	RAID Inside	
Revert HDD to Non-RAID		HDD1: ST3120026AS	120 GB	Non-RAID	
Solve Mirror Conflict					
Rebuild Mirror Drive					
Save And Exit Setup					
Exit Without Saving					

[ RAID Disk Drive List ]					
Model Name	RAID Level	Capacity	Status	Members(HDDx)	
RDD0: GRAID	1-Mirror	120 GB	Degraded	0?	

[←→TAB]-Switch Window    [↑↓]-Select ITEM    [ENTER]-Action    [ESC]-Exit

Step 2:

The selection bar will then move to the new hard drive in the **Hard Disk Drive List** block. Press <Enter> to start the RAID rebuilding process. The rebuilding progress is displayed at the bottom of the screen. When done, the status of the array will display as **Normal**.

GIGABYTE Technology Corp. PCIE-to-SATAII/IDE RAID Controller BIOS v1.06.78

[ Main Menu ]		[ Hard Disk Drive List ]			
Create RAID Disk Drive		Model Name	Capacity	Type/Status	
Delete RAID Disk Drive		HDD0: ST3120026AS	120 GB	RAID Inside	
Revert HDD to Non-RAID		HDD1: ST3120026AS	120 GB	Non-RAID	
Solve Mirror Conflict					
Rebuild Mirror Drive					
Save And Exit Setup					
Exit Without Saving					

[ RAID Disk Drive List ]					
Model Name	RAID Level	Capacity	Status	Members(HDDx)	
RDD0: GRAID	1-Mirror	120 GB	Degraded	0?	

Rebuilding...35%, please wait....

## Rebuilding in the operating system

Make sure the GIGABYTE SATA2 SATA controller driver has been installed from the motherboard driver disk. Launch the GIGABYTE RAID CONFIGURER from **All Programs** in the **Start** menu.



Step 1:

In the GIGABYTE RAID CONFIGURER screen, right-click on the array to be rebuilt in the **RAID LIST** block. Select **Rebuild Raid**. (Or click the **Rebuild** icon  in the tool bar.



Step 2:

When the Rebuilding RAID Wizard appears, click **Next**.



Step 3:

Select a drive to rebuild the array and click **Next**.



Step 4:

Click **Finish** to start the RAID rebuilding process.



Step 5:

The rebuilding progress is displayed at the bottom of the screen.



Step 6:

When finished, restart your system.

## 5-2 Configuring Audio Input and Output

### 5-2-1 Configuring 2/4/5.1/7.1-Channel Audio

The motherboard provides six audio jacks on the back panel which support 2/4/5.1/7.1-channel audio. The picture to the right shows the default audio jack assignments. The integrated HD (High Definition) audio provides jack retasking capability that allows the user to change the function for each jack through the audio driver. For example, in a 4-channel audio configuration, if a Rear speaker is plugged into the default Center/Subwoofer speaker out jack, you can retask the Center/Subwoofer speaker out jack to be Rear speaker out.



- To install a microphone, connect your microphone to the Mic in jack and manually configure the jack for microphone functionality.
- Audio signals will be present on both of the front and back panel audio connections simultaneously. If you want to mute the back panel audio (only supported when using an HD front panel audio module), refer to instructions on the next page.

#### High Definition Audio (HD Audio)

HD Audio includes multiple high quality digital-to-analog converters (DACs) that support 44.1KHz/ 48KHz/ 96KHz/192KHz sampling rate. HD Audio features multistreaming capabilities that allow multiple audio streams (in and out) to be simultaneously processed. For example, users can listen to MP3 music, have an Internet chat, make a telephone call over the Internet, and etc. all at the same time.

#### A. Configuring Speakers:

(The following instructions use Windows Vista as the example operating system.)

Step 1:

After installing the audio driver, the **HD Audio Manager** icon  will appear in the notification area. Double-click the icon to access the **HD Audio Manager**.

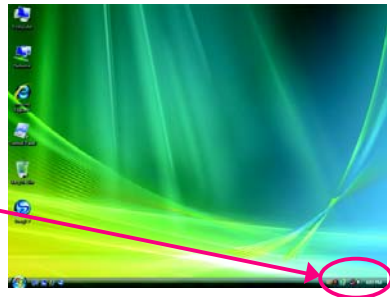
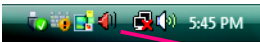

(Note) 2/4/5.1/7.1-Channel Audio Configurations:

Refer to the following for multi-channel speaker configurations.

- 2-channel audio: Headphone or Line out.
- 4-channel audio: Front speaker out and Rear speaker out.
- 5.1-channel audio: Front speaker out, Rear speaker out, and Center/Subwoofer speaker out.
- 7.1-channel audio: Front speaker out, Rear speaker out, Center/Subwoofer speaker out, and Side speaker out.



## Step 2:

Connect an audio device to an audio jack. The **The current connected device is** dialog box appears. Select the device according to the type of device you connect. Then click **OK**.

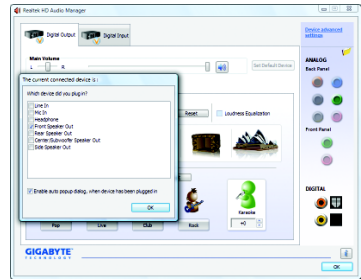

## Step 3:

On the **Speakers** screen, click the **Speaker Configuration** tab. In the **Speaker Configuration** list, select **Stereo**, **Quadraphonic**, **5.1 Speaker**, or **7.1 Speaker** according to the type of speaker configuration you wish to set up. Then the speaker setup is completed.

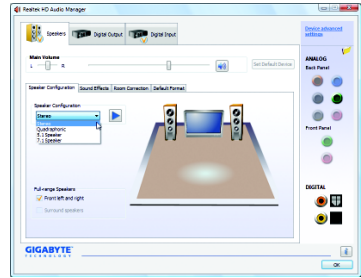

## B. Configuring Sound Effect:

You may configure an audio environment on the **Sound Effects** tab.

## C. Activating an AC'97 Front Panel Audio Module:

If your chassis provides an AC'97 front panel audio module, to activate the AC'97 functionality, click the tool icon on the **Speaker Configuration** tab. On the **Connector Settings** dialog box, select the **Disable front panel jack detection** check box. Click **OK** to complete.

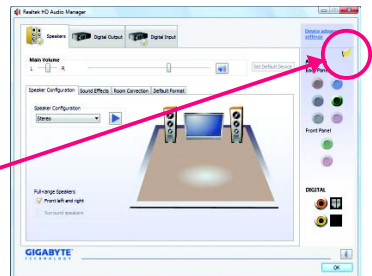
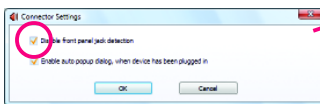

## D. Muting the Back Panel Audio (For HD Audio Only):

Click **Device advanced settings** on the top right corner on the **Speaker Configuration** tab to open the **Device advanced settings** dialog box. Select the **Mute the rear output device, when a front headphone plugged in** check box. Click **OK** to complete.

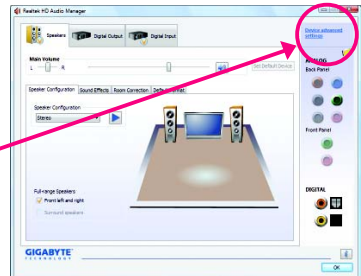
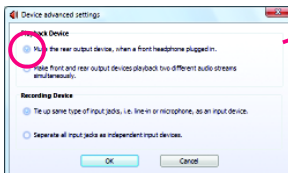

## 5-2-2 Configuring S/PDIF In/Out

### A. S/PDIF In:

The S/PDIF in cable (optional) allows you to input digital audio signals to the computer for audio processing.

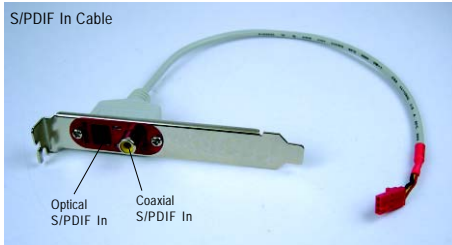

#### 1. Installing the S/PDIF In Cable:

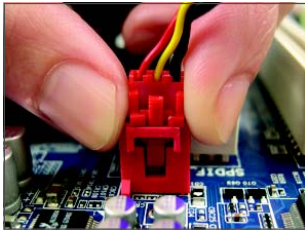

##### Step 1:

First, attach the connector at the end of the cable to the SPDIF\_I header on your motherboard.



##### Step 2:

Secure the metal bracket to the chassis back panel with a screw.

#### 2. Configuring S/PDIF In:

On the **Digital Input** screen, click the **Default Format** tab to select the default format. Click **OK** to complete.

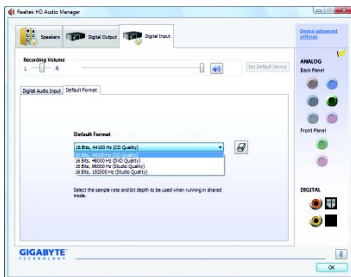

(Note) The actual locations of the SPDIF In and SPDIF Out connectors may differ by model.

## B. S/PDIF Out:

The S/PDIF out jacks can transmit audio signals to an external decoder for decoding to get the best audio quality.

### 1. Connecting a S/PDIF Out Cable



S/PDIF Coaxial Cable



S/PDIF Optical Cable

Connect a S/PDIF coaxial cable or a S/PDIF optical cable (either one) to an external decoder for transmitting the S/PDIF digital audio signals.

### 2. Configuring S/PDIF Out:

On the **Digital Output** screen, click the **Default Format** tab and then select the sample rate and bit depth. Click **OK** to complete.

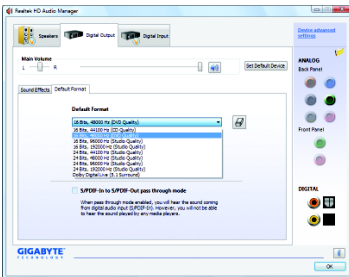

## 5-2-3 Enabling the Dolby Home Theater Function





Before Dolby Home Theater is enabled, you get only 2-channel playback output (from the front speakers) when playing 2-channel stereo sources. You must play 4-, 5.1-, or 7.1- channel content to get 4-, 5.1-, or 7.1- channel audio effects. With Dolby Home Theater enabled, 2-channel stereo content will be transformed into multi-channel audio, creating a virtual surround sound environment<sup>(Note)</sup>.

Install the **Dolby GUI Software** driver from the motherboard driver disk. Click the **Start** icon . Point to **All Programs, Dolby Control Center** to access the utility.

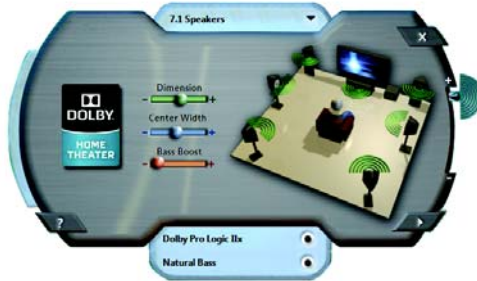
(The following illustration demonstrates a 7.1-speaker configuration as an example.)

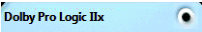

1.  : Click **Dolby Pro Logic IIx**. The system will expand 2-channel audio for a 7.1-channel surround sound playback.
2.  : Click **Natural Bass** to enable speaker bass effect.

(Note) When Dolby Digital Live is enabled, only digital audio output (S/PDIF) is working, and you will not hear any sound from analog speakers or headphone.

## 5-2-4 Configuring Microphone Recording

Step 1:

After installing the audio driver, the **HD Audio Manager** icon will appear in the notification area. Double-click the icon to access the **HD Audio Manager**.

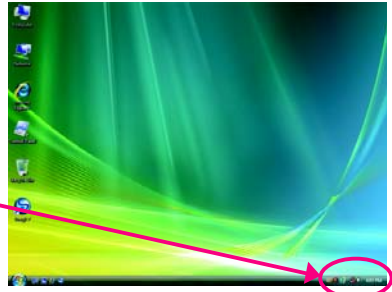

Step 2:

Connect your microphone to the Mic in jack (pink) on the back panel or the Mic in jack (pink) on the front panel. Then configure the jack for microphone functionality.

Note: The microphone functions on the front panel and back panel cannot be used at the same time.

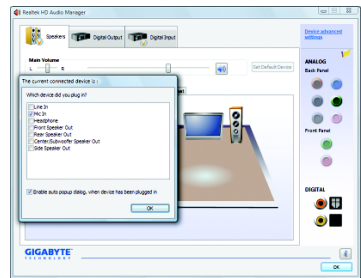

Step 3:

Go to the **Microphone** screen. Do not mute the recording volume, or you'll not be able to record the sound. To hear the sound being recorded during the recording process, do not mute the playback volume. It is recommended that you set the volumes at a middle level.

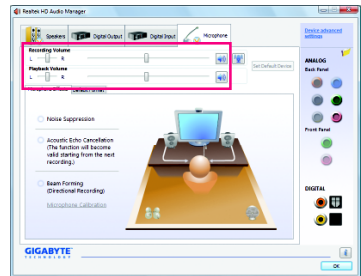

If you want to change the current sound input default device to microphone, right-click on **Microphone** and select **Set Default Device**.

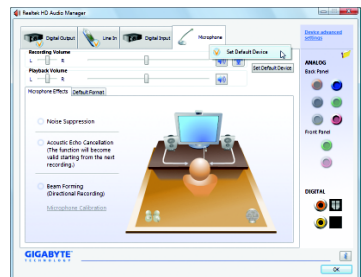

Step 4:

To raise the recording and playback volume for the microphone, click the **Microphone Boost** icon on the right of the **Recording Volume** slider and set the Microphone Boost level.

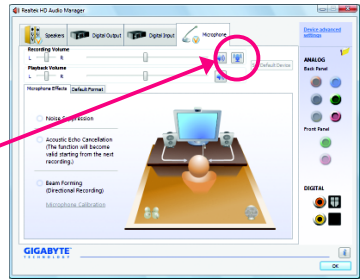

Step 5:

After completing the settings above, click **Start**, point to **All Programs**, point to **Accessories**, and then click **Sound Recorder** to begin the sound recording.



\* **Enabling Stereo Mix**

If the HD Audio Manager does not display the recording device you wish to use, refer to the steps below. The following steps explain how to enable Stereo Mix (which may be needed when you want to record sound from your computer).

Step 1:

Locate the **Volume** icon in the notification area and right-click on this icon. Select **Recording Devices**.



Step 2:

On the **Recording** tab, right-click on an empty space and select **Show Disabled Devices**.

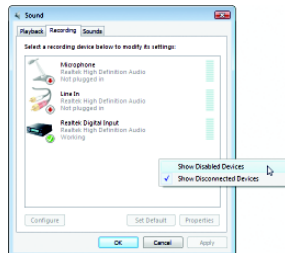

### Step 3:

When the **Stereo Mix** item appears, right-click on this item and select **Enable**. Then set it as the default device.

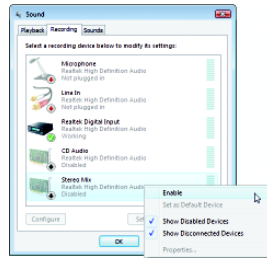

### Step 4:

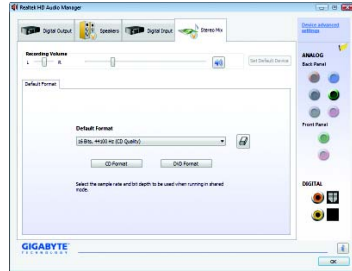

Now you can access the **HD Audio Manager** to configure **Stereo Mix** and use **Sound Recorder** to record the sound.

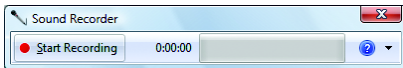

## 5-2-5 Using the Sound Recorder



### A. Recording Sound:

1. Make sure you have connected the sound input device (e.g. microphone) to the computer.
2. To record the audio, click the **Start Recording** button .
3. To stop recording audio, click the **Stop Recording** button .

Be sure to save the recorded audio file upon completion.

### B. Playing the Recorded Sound:

You can play your recording in a digital media player program that supports your audio file format.

## 5-3 Troubleshooting

### 5-3-1 Frequently Asked Questions

To read more FAQs for your motherboard, please go to the Support\Motherboard\FAQ page on GIGABYTE's website.

Q: In the BIOS Setup program, why are some BIOS options missing?

A: Some advanced options are hidden in the BIOS Setup program. Press <Delete> to enter BIOS Setup during the POST. In the Main Menu, press <Ctrl>+<F1> to show the advanced options.

Q: Why is the light of my keyboard/optical mouse still on after the computer shuts down?

A: Some motherboard provides a small amount of standby power after the computer shuts down and that's why the light is still on.

Q: How do I clear the CMOS values?

A: If your motherboard has a clearing CMOS jumper, refer to the instructions on the CLR\_CMOS jumper in Chapter 1 to short the jumper to clear the CMOS values. If your board doesn't have this jumper, refer to the instructions on the motherboard battery in Chapter 1. You can temporarily remove the battery from the battery holder to stop supplying power to the CMOS, which will clear the CMOS values after about one minute. Refer to the steps below:

Steps:

1. Turn off your computer and unplug the power cord.
2. Gently remove the battery from the battery holder and wait for one minute.  
(Or use a metal object like a screwdriver to touch the positive and negative terminals of the battery holder, making them short for 5 seconds.)
3. Replace the battery.
4. Plug in the power cord and restart your computer.
5. Press <Delete> to enter BIOS Setup. Select "Load Fail-Safe Defaults" (or "Load Optimized Defaults") to load BIOS default settings.
6. Saves changes and exit BIOS Setup (select "Save & Exit Setup") to restart your computer.

Q: Why do I still get a weak sound even though I have turned my speaker to the maximum volume?

A: Make sure your speaker is equipped with an internal amplifier. If not, try a speaker with power/amplifier.

Q: What do the beeps emitted during the POST mean?

A: The following Award BIOS beep code descriptions may help you identify possible computer problems. (For reference only.)

1 short: System boots successfully

2 short: CMOS setting error

1 long, 1 short: Memory or motherboard error

1 long, 2 short: Monitor or graphics card error

1 long, 3 short: Keyboard error

1 long, 9 short: BIOS ROM error

Continuous long beeps: Graphics card not inserted properly

Continuous short beeps: Power error



### 5-3-2 Troubleshooting Procedure

If you encounter any troubles during system startup, follow the troubleshooting procedure below to solve the problem.

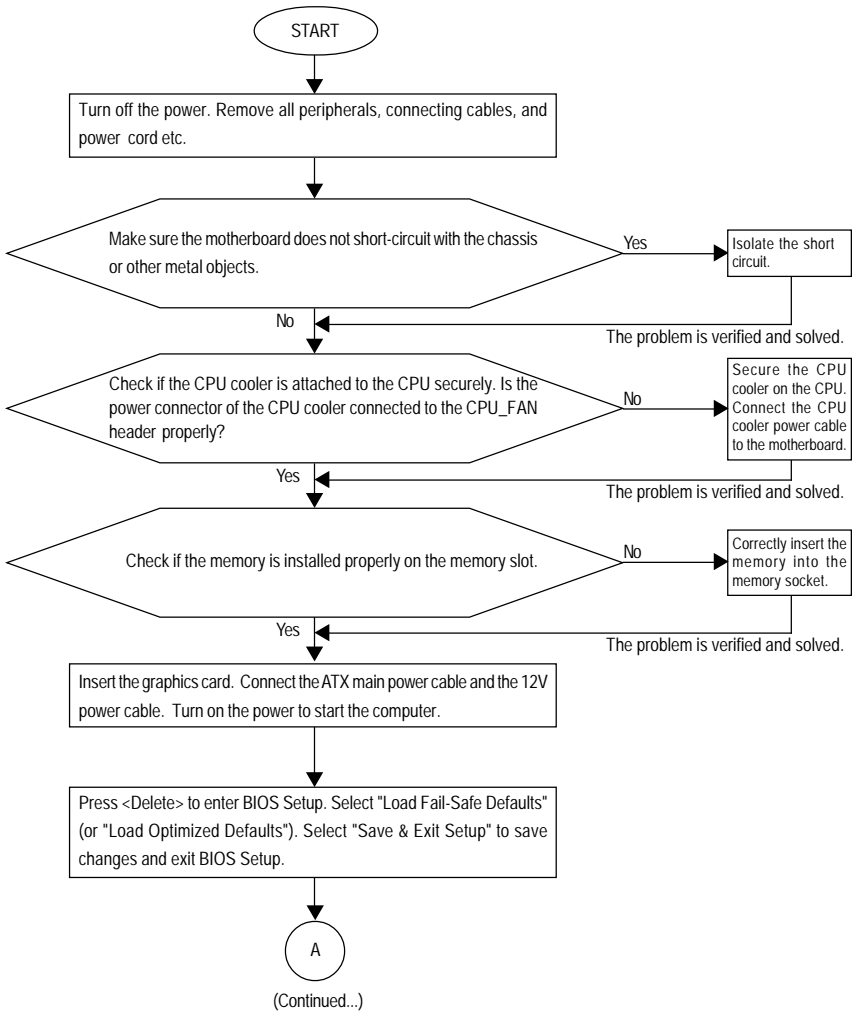

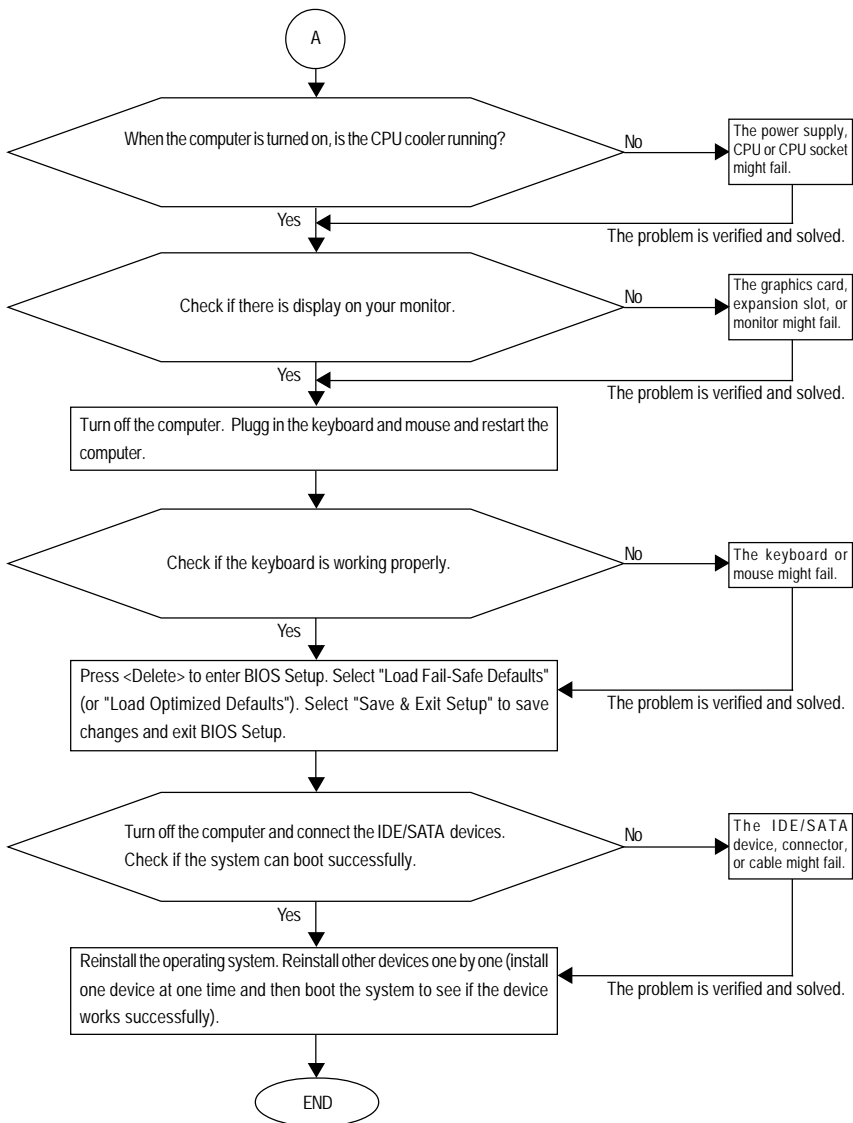

If the procedure above is unable to solve your problem, contact the place of purchase or local dealer for help. Or go to the Support\Technical Service Zone page to submit your question. Our customer service staff will reply you as soon as possible.

## 5-4 Regulatory Statements

### Regulatory Notices

This document must not be copied without our written permission, and the contents there of must not be imparted to a third party nor be used for any unauthorized purpose. Contravention will be prosecuted. We believe that the information contained herein was accurate in all respects at the time of printing. GIGABYTE cannot, however, assume any responsibility for errors or omissions in this text. Also note that the information in this document is subject to change without notice and should not be construed as a commitment by GIGABYTE.

### Our Commitment to Preserving the Environment

In addition to high-efficiency performance, all GIGABYTE motherboards fulfill European Union regulations for RoHS (Restriction of Certain Hazardous Substances in Electrical and Electronic Equipment) and WEEE (Waste Electrical and Electronic Equipment) environmental directives, as well as most major worldwide safety requirements. To prevent releases of harmful substances into the environment and to maximize the use of our natural resources, GIGABYTE provides the following information on how you can responsibly recycle or reuse most of the materials in your "end of life" product.

### Restriction of Hazardous Substances (RoHS) Directive Statement

GIGABYTE products have not intended to add and safe from hazardous substances (Cd, Pb, Hg, Cr+6, PBDE and PBB). The parts and components have been carefully selected to meet RoHS requirement. Moreover, we at GIGABYTE are continuing our efforts to develop products that do not use internationally banned toxic chemicals.

### Waste Electrical & Electronic Equipment (WEEE) Directive Statement

GIGABYTE will fulfill the national laws as interpreted from the 2002/96/EC WEEE (Waste Electrical and Electronic Equipment) directive. The WEEE Directive specifies the treatment, collection, recycling and disposal of electric and electronic devices and their components. Under the Directive, used equipment must be marked, collected separately, and disposed of properly.

### WEEE Symbol Statement



The symbol shown below is on the product or on its packaging, which indicates that this product must not be disposed of with other waste. Instead, the device should be taken to the waste collection centers for activation of the treatment, collection, recycling and disposal procedure. The separate collection and recycling of your waste equipment at the time of disposal will help to conserve natural resources and ensure that it is recycled in a manner that protects human health and the environment. For more information about where you can drop off your waste equipment for recycling, please contact your local government office, your household waste disposal service or where you purchased the product for details of environmentally safe recycling.

- When your electrical or electronic equipment is no longer useful to you, "take it back" to your local or regional waste collection administration for recycling.
- If you need further assistance in recycling, reusing in your "end of life" product, you may contact us at the Customer Care number listed in your product's user's manual and we will be glad to help you with your effort.

Finally, we suggest that you practice other environmentally friendly actions by understanding and using the energy-saving features of this product (where applicable), recycling the inner and outer packaging (including shipping containers) this product was delivered in, and by disposing of or recycling used batteries properly. With your help, we can reduce the amount of natural resources needed to produce electrical and electronic equipment, minimize the use of landfills for the disposal of "end of life" products, and generally improve our quality of life by ensuring that potentially hazardous substances are not released into the environment and are disposed of properly.

### China Restriction of Hazardous Substances Table

The following table is supplied in compliance with China's Restriction of Hazardous Substances (China RoHS) requirements:



关于符合中国《电子信息产品污染控制管理办法》的声明  
 Management Methods on Control of Pollution from Electronic Information Products  
 (China RoHS Declaration)

产品中有毒有害物质或元素的名称及含量  
 Hazardous Substances Table

部件名称 (Parts)	有毒有害物质或元素 (Hazardous Substances)					
	铅 (Pb)	汞 (Hg)	镉 (Cd)	六价铬 (Cr (VI))	多溴联苯 (PBB)	多溴二苯醚 (PBDE)
PCB板 PCB	○	○	○	○	○	○
结构件及风扇 Mechanical parts and Fan	×	○	○	○	○	○
芯片及其他主动零件 Chip and other Active components	×	○	○	○	○	○
连接器 Connectors	×	○	○	○	○	○
被动电子元件 Passive Components	×	○	○	○	○	○
线材 Cables	○	○	○	○	○	○
焊接金属 Soldering metal	○	○	○	○	○	○
助焊剂, 散热膏, 标签及其他耗材 Flux, Solder Paste, Label and other Consumable Materials	○	○	○	○	○	○
○:表示该有毒有害物质在该部件所有均质材料中的含量均在SJ/T11363-2006标准规定的限量要求以下。 Indicates that this hazardous substance contained in all homogenous materials of this part is below the limit requirement SJ/T 11363-2006						
×:表示该有毒有害物质至少在该部件的某一均质材料中的含量超出SJ/T11363-2006标准规定的限量要求。 Indicates that this hazardous substance contained in at least one of the homogenous materials of this part is above the limit requirement in SJ/T 11363-2006						
对销售之日的所发售产品, 本表显示我公司供应链的电子信息产品可能包含这些物质。注意: 在所售产品中可能会也可能不会含有所有列出的部件。 This table shows where these substances may be found in the supply chain of our electronic information products, as of the date of the sale of the enclosed products. Note that some of the component types listed above may or may not be a part of the enclosed product.						







## Contact Us

---

- **GIGA-BYTE TECHNOLOGY CO., LTD.**

Address: No.6, Bau Chiang Road, Hsin-Tien,  
Taipei 231, Taiwan

TEL: +886-2-8912-4000

FAX: +886-2-8912-4003

Tech. and Non-Tech. Support (Sales/Marketing) :

<http://ggts.gigabyte.com.tw>

WEB address (English): <http://www.gigabyte.com.tw>

WEB address (Chinese): <http://www.gigabyte.tw>

---

- **G.B.T. INC. - U.S.A.**

TEL: +1-626-854-9338

FAX: +1-626-854-9339

Tech. Support:

<http://rma.gigabyte-usa.com>

Web address: <http://www.gigabyte.us>

---

- **G.B.T. INC (USA) - Mexico**

Tel: +1-626-854-9338 x 215 (Soporte de habla hispano)

FAX: +1-626-854-9339

Correo: [soporte@gigabyte-usa.com](mailto:soporte@gigabyte-usa.com)

Tech. Support:

<http://rma.gigabyte-usa.com>

Web address: <http://latam.giga-byte.com/>

---

- **GIGA-BYTE SINGAPORE PTE. LTD. - Singapore**

WEB address : <http://www.gigabyte.sg>

---

- **Thailand**

WEB address : <http://th.giga-byte.com>

---

- **Vietnam**

WEB address : <http://www.gigabyte.vn>

---

---

- **NINGBO G.B.T. TECH. TRADING CO., LTD. - China**

WEB address : <http://www.gigabyte.cn>

- Shanghai**

TEL: +86-21-63410999

FAX: +86-21-63410100

- Beijing**

TEL: +86-10-62102838

FAX: +86-10-62102848

- Wuhan**

TEL: +86-27-87851312

FAX: +86-27-87851330

- GuangZhou**

TEL: +86-20-87540700

FAX: +86-20-87544306

- Chengdu**

TEL: +86-28-85236930

FAX: +86-28-85256822

- Xian**

TEL: +86-29-85531943

FAX: +86-29-85510930

- Shenyang**

TEL: +86-24-83992901

FAX: +86-24-83992909

---

- **GIGABYTE TECHNOLOGY (INDIA) LIMITED - India**

WEB address : <http://www.gigabyte.in>

---

- **Saudi Arabia**

WEB address : <http://www.gigabyte.com.sa>

---

- **GIGABYTE TECHNOLOGY PTY. LTD. - Australia**

WEB address : <http://www.gigabyte.com.au>

---

- 
- **G.B.T. TECHNOLOGY TRADING GMBH - Germany**

WEB address : <http://www.gigabyte.de>

- 
- **G.B.T. TECH. CO., LTD. - U.K.**

WEB address : <http://www.giga-byte.co.uk>

- 
- **GIGA-BYTE TECHNOLOGY B.V. - The Netherlands**

WEB address : <http://www.giga-byte.nl>

- 
- **GIGABYTE TECHNOLOGY FRANCE - France**

WEB address : <http://www.gigabyte.fr>

- 
- **Sweden**

WEB address : <http://www.giga-byte.se>

- 
- **Italy**

WEB address : <http://www.giga-byte.it>

- 
- **Spain**

WEB address : <http://www.giga-byte.es>

- 
- **Greece**

WEB address : <http://www.giga-byte.gr>

- 
- **Czech Republic**

WEB address : <http://www.gigabyte.cz>

- 
- **Hungary**

WEB address : <http://www.giga-byte.hu>

- 
- **Turkey**

WEB address : <http://www.gigabyte.com.tr>

- 
- **Russia**

WEB address : <http://www.gigabyte.ru>

- 
- **Poland**

WEB address : <http://www.gigabyte.pl>

- 
- **Ukraine**

WEB address : <http://www.gigabyte.ua>

- 
- **Romania**

WEB address : <http://www.gigabyte.com.ro>

- 
- **Serbia**

WEB address : <http://www.gigabyte.co.yu>

- 
- **Kazakhstan**

WEB address : <http://www.giga-byte.kz>

You may go to the GIGABYTE website, select your language in the language list on the top right corner of the website.

## ● GIGABYTE Global Service System



To submit a technical or non-technical (Sales/ Marketing) question, please link to :

<http://gts.gigabyte.com.tw>

Then select your language to enter the system.