

GA-8I865GME-775-RH (rev. 2.0)

Intel® Core™ 2 Extreme dual-core / Core™ 2 Duo /

Intel® Pentium® D / Pentium® 4 /

Intel® Celeron® D LGA775 Processor Motherboard

User's Manual

Rev. 2002

12ME-865GMETR-2002R



* The WEEE marking on the product indicates this product must not be disposed of with user's other household waste and must be handed over to a designated collection point for the recycling of waste electrical and electronic equipment!!

■ * The WEEE marking applies only in European Union's member states.

Declaration of Conformity

G.B.T. Technology Trading GmbH
Vb, Manufacturer/Importer

Auschlagler Weg 41, 1F 20537 Hamburg, Germany
declare that the product

Motherboard

GA-8I865GME-775-RH

is in conformity with conformity is declared)
(reference to the specific standards in accordance with 89/336 EEC-EMC Directive)

- | | | | |
|--|---|--|---|
| <input type="checkbox"/> EN 55011 | Limits and methods of measurement of radio disturbance characteristics of industrial, scientific and medical (ISM) high frequency equipment | <input checked="" type="checkbox"/> EN 61000-3-2 | Disturbances in supply systems caused |
| <input type="checkbox"/> EN 55013 | Limits and methods of measurement of radio disturbance characteristics of broadcast receivers and associated equipment | <input checked="" type="checkbox"/> EN 61000-3-3 | Disturbances in supply systems caused by electrical equipment "Voltage fluctuations" |
| <input type="checkbox"/> EN 55014-1 | Limits and methods of measurement of radio disturbance characteristics of household electrical appliances, portable tools and similar electrical appliances | <input checked="" type="checkbox"/> EN 55024 | Information Technology Equipment (ITE) radio disturbance characteristics: Limits and methods of measurement |
| <input type="checkbox"/> EN 55015 | Limits and methods of measurement of radio disturbance characteristics of fluorescent lamps and luminaires | <input type="checkbox"/> EN 55021-1 | Generic immunity standard Part 1: Residual, commercial and light industry |
| <input type="checkbox"/> EN 55020 | Immunity from radio interference of broadcast receivers and associated equipment | <input type="checkbox"/> EN 55021-2 | Residual, commercial and light industry Industrial environment |
| <input checked="" type="checkbox"/> EN 55022 | Limits and methods of measurement of radio disturbance characteristics of information technology equipment | <input type="checkbox"/> EN 55014-2 | Immunity requirements for household appliances tools and similar apparatus |
| <input type="checkbox"/> DIN VDE 0885 | Colored distribution systems. Equipment for receiving and/or distribution from sound and television signals | <input type="checkbox"/> EN 50911-2 | EMC requirements for uninterruptible power systems (UPS) |
| <input type="checkbox"/> part 10 | | | |
| <input type="checkbox"/> part 12 | | | |
| <input checked="" type="checkbox"/> CE marking | | | (EEC conformity marking) |
| <input type="checkbox"/> EN 60956 | Safety requirements for mains operated electronic and related apparatus for household and similar general use | <input type="checkbox"/> EN 60950 | Safety for information technology equipment including electrical business equipment |
| <input type="checkbox"/> EN 60335 | Safety of household and similar electrical appliances | <input type="checkbox"/> EN 50911-1 | General and Safety requirements for uninterruptible power systems (UPS) |

The manufacturer also declares the conformity of above mentioned product with the actual required safety standards in accordance with IVD 7/23 SEC



(EEC conformity marking)

Manufacturer/Importer

Signature: Jimmy Huang

(Stamp)

Date: Dec. 29, 2006

Name: Timmy Huang

DECLARATION OF CONFORMITY

Per FCC Part 2 Section 2.1077(a)



Responsible Party Name: G.B.T. INC. (U.S.A.)

Address: 17358 Railroad Street

City of Industry, CA 91748

Phone/Fax No: (818) 854-9338 / (818) 854-9339

hereby declares that the product

Product Name: **Motherboard**

Model Number: GA-8I865GME-775-RH

Conforms to the following specifications:

FCC Part 15, Subpart B, Section 15.107(a) and Section 15.109

(a), Class B Digital Device

Supplementary Information:

This device complies with part 15 of the FCC Rules. Operation is subject to the following two conditions: (1) This device may not cause harmful and (2) this device must accept any interference received, including that may cause undesired operation.

Representative Person's Name: ERIC LU

Signature: Eric Lu

Date: Dec. 29, 2006

Copyright

© 2006 GIGA-BYTE TECHNOLOGY CO., LTD. All rights reserved.

The trademarks mentioned in the manual are legally registered to their respective companies.

Notice

The written content provided with this product is the property of Gigabyte.

No part of this manual may be reproduced, copied, translated, or transmitted in any form or by any means without Gigabyte's prior written permission. Specifications and features are subject to change without prior notice.

Product Manual Classification

In order to assist in the use of this product, Gigabyte has categorized the user manual in the following:

- For detailed product information and specifications, please carefully read the "User's Manual."

- For detailed information related to Gigabyte's unique features, please go to the "Technology Guide" section on Gigabyte's website to read or download the information you need.

For more product details, please visit Gigabyte's website at www.gigabyte.com.tw

Table of Contents

Item Checklist	6
Optional Accessories	6
GA-81865GME-775-RH (rev. 2.0) Motherboard Layout	7
Block Diagram	8
Chapter 1 Hardware Installation	9
1-1 Considerations Prior to Installation	9
1-2 Feature Summary	10
1-3 Installation of the CPU and CPU Cooler	12
1-3-1 Installation of the CPU	12
1-3-2 Installation of the CPU Cooler	13
1-4 Installation of Memory	14
1-5 Installation of Expansion Cards	16
1-6 I/O Back Panel Introduction	17
1-7 Connectors Introduction	18
Chapter 2 BIOS Setup	27
The Main Menu (For example: BIOS Ver. : DM)	28
2-1 Standard CMOS Features	30
2-2 Advanced BIOS Features	32
2-3 Integrated Peripherals	34
2-4 Power Management Setup	37
2-5 PnP/PCI Configurations	39
2-6 PC Health Status	40
2-7 Frequency/Voltage Control	42
2-8 Load Fail-Safe Defaults	44
2-9 Load Optimized Defaults	44
2-10 Set Supervisor/User Password	45
2-11 Save & Exit Setup	46
2-12 Exit Without Saving	46

Chapter 3 Drivers Installation	47
3-1 Install Chipset Drivers	47
3-2 Software Applications	48
3-3 Driver CD Information	48
3-4 Hardware Information	49
3-5 Contact Us	49
Chapter 4 Appendix	51
4-1 Unique Software Utilities	51
4-1-1 EasyTune 5 Introduction	51
4-1-2 Xpress Recovery2 Introduction	52
4-1-3 Flash BIOS Method Introduction	54
4-1-4 2 / 4 / 6 Channel Audio Function Introduction	58
4-2 Troubleshooting	61

Item Checklist

- IDE Cable x 1 and FDD Cable x 1
- Serial ATA Cable x 1
- I/O Shield

* The items listed above are for reference only, and are subject to change without notice.

Optional Accessories

- ◆ 2 Ports USB 2.0 Cable (Part Number: 12CR1-1UB030-51/R)
- ◆ 4 Ports USB 2.0 Cable (Part Number: 12CR1-1UB030-21/R)

GA-8I865GME-775-RH (rev. 2.0) Motherboard Layout

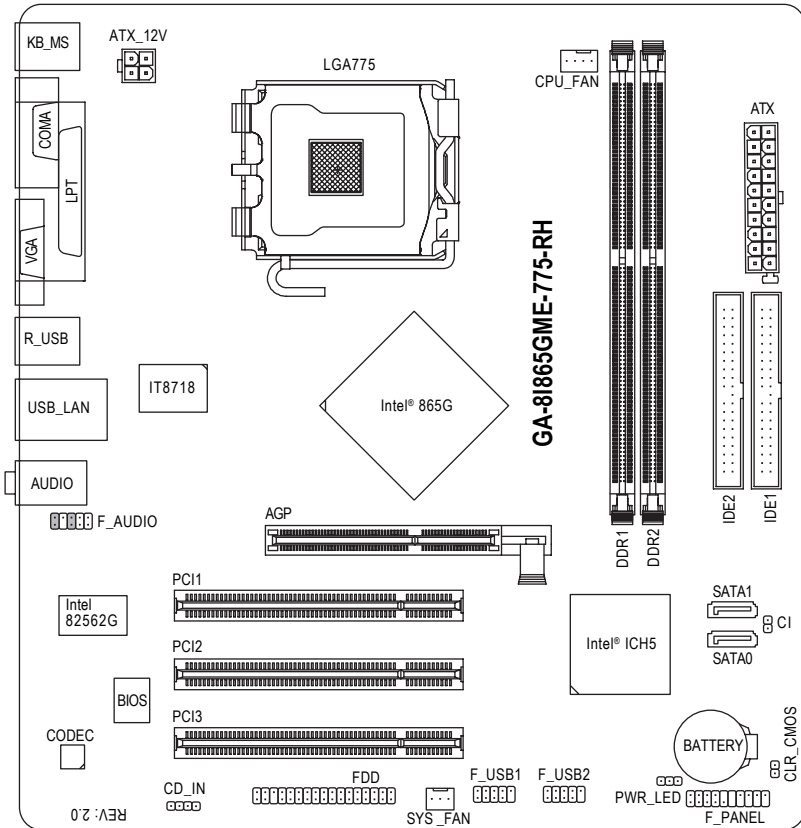

Block Diagram

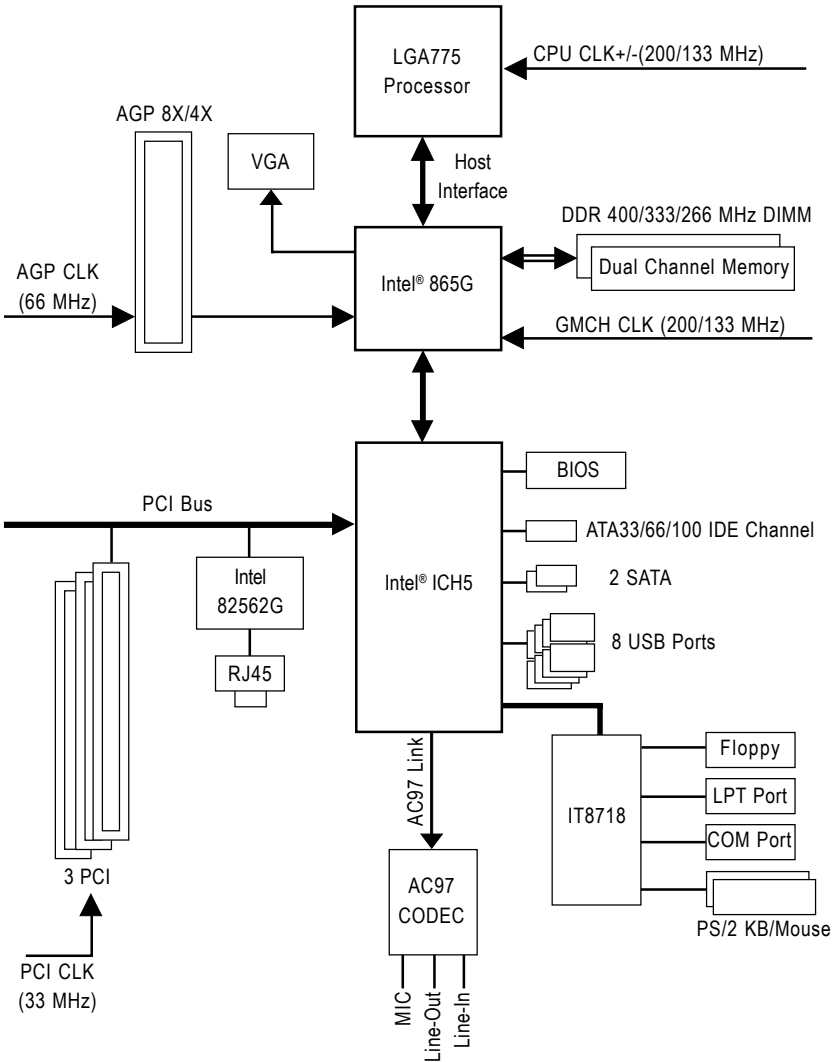

Chapter 1 Hardware Installation

1-1 Considerations Prior to Installation

Preparing Your Computer

The motherboard contains numerous delicate electronic circuits and components which can become damaged as a result of electrostatic discharge (ESD). Thus, prior to installation, please follow the instructions below:

1. Please turn off the computer and unplug its power cord.
2. When handling the motherboard, avoid touching any metal leads or connectors.
3. It is best to wear an electrostatic discharge (ESD) cuff when handling electronic components (CPU, RAM).
4. Prior to installing the electronic components, please have these items on top of an antistatic pad or within a electrostatic shielding container.
5. Please verify that the power supply is switched off before unplugging the power supply connector from the motherboard.

Installation Notices

1. Prior to installation, please do not remove the stickers on the motherboard. These stickers are required for warranty validation.
2. Prior to the installation of the motherboard or any hardware, please first carefully read the information in the provided manual.
3. Before using the product, please verify that all cables and power connectors are connected.
4. To prevent damage to the motherboard, please do not allow screws to come in contact with the motherboard circuit or its components.
5. Please make sure there are no leftover screws or metal components placed on the motherboard or within the computer casing.
6. Please do not place the computer system on an uneven surface.
7. Turning on the computer power during the installation process can lead to damage to system components as well as physical harm to the user.
8. If you are uncertain about any installation steps or have a problem related to the use of the product, please consult a certified computer technician.

Instances of Non-Warranty

1. Damage due to natural disaster, accident or human cause.
2. Damage as a result of violating the conditions recommended in the user manual.
3. Damage due to improper installation.
4. Damage due to use of uncertified components.
5. Damage due to use exceeding the permitted parameters.
6. Product determined to be an unofficial Gigabyte product.

1-2 Feature Summary

CPU	<ul style="list-style-type: none"> ◆ LGA775 for Intel® Core™ 2 Extreme dual-core / Core™ 2 Duo / Pentium® D / Pentium® 4 / Celeron® D ◆ L2 cache varies with CPU
Front Side Bus	<ul style="list-style-type: none"> ◆ Supports 800/533 MHz FSB
Chipset	<ul style="list-style-type: none"> ◆ Northbridge: Intel® 865G ◆ Southbridge: Intel® ICH5
LAN	<ul style="list-style-type: none"> ◆ Onboard Intel 82562G chip (10/100 Mbit)
Audio	<ul style="list-style-type: none"> ◆ Onboard Realtek ALC655 CODEC chip ◆ Supports 2 / 4 / 6 channel audio ◆ Supports CD In connection
Storage	<ul style="list-style-type: none"> ◆ Intel® ICH5 Southbridge <ul style="list-style-type: none"> - 1 FDD connector, allowing connection of 1 FDD device - 2 IDE connectors with ATA-100/66/33 support, allowing connection of 4 IDE devices - 2 SATA connectors, allowing connection of 2 SATA devices
O.S Support	<ul style="list-style-type: none"> ◆ Microsoft Windows 2000/XP
Memory	<ul style="list-style-type: none"> ◆ 2 DDR DIMM memory slots (supports up to 2 GB memory) ◆ Supports dual channel DDR400/333/266 DIMM ◆ Supports 2.5V DDR DIMMs
Expansion Slots	<ul style="list-style-type: none"> ◆ 1 AGP slot 4X/8X ◆ 3 PCI slots
Internal Connectors	<ul style="list-style-type: none"> ◆ 1 20-pin ATX power connector ◆ 1 4-pin ATX 12V power connector ◆ 1 floppy connector ◆ 2 IDE connectors ◆ 2 SATA connectors ◆ 1 CPU fan connector ◆ 1 system fan connector ◆ 1 front panel connector ◆ 1 front audio connector ◆ 1 CD In connector ◆ 2 USB 2.0/1.1 connectors for additional 4 ports by cables ◆ 1 Chassis Intrusion connector ◆ 1 power LED connector

Rear Panel I/O	<ul style="list-style-type: none"> ◆ 1 PS/2 keyboard port ◆ 1 PS/2 mouse port ◆ 1 parallel port ◆ 1 serial port ◆ 1 VGA port ◆ 4 USB 2.0/1.1 ports ◆ 1 RJ-45 port ◆ 3 audio jacks (Line In / Line Out / MIC In)
I/O Control	<ul style="list-style-type: none"> ◆ IT8718 chip
Hardware Monitor	<ul style="list-style-type: none"> ◆ System voltage detection ◆ CPU temperature detection ◆ CPU / System fan speed detection ◆ CPU warning temperature ◆ CPU / System fan failure warning ◆ CPU smart fan control
BIOS	<ul style="list-style-type: none"> ◆ 1 4 Mbit flash ROM ◆ Use of licensed AWARD BIOS
Additional Features	<ul style="list-style-type: none"> ◆ Supports @BIOS ◆ Supports Download Center ◆ Supports Q-Flash ◆ Supports EasyTune ^(Note) ◆ Supports Xpress Install ◆ Supports Xpress Recovery2 ◆ Supports Xpress BIOS Rescue
Bundle Software	<ul style="list-style-type: none"> ◆ Norton Internet Security (OEM version)
Form Factor	<ul style="list-style-type: none"> ◆ Micro ATX form factor; 24.4cm x 21.2cm

(Note) EasyTune functions may vary depending on different motherboards.

1-3 Installation of the CPU and CPU Cooler



CAUTION

Before installing the CPU, please comply with the following conditions:

1. Please make sure that the motherboard supports the CPU.
2. Please take note of the one indented corner of the CPU. If you install the CPU in the wrong direction, the CPU will not insert properly. If this occurs, please change the insert direction of the CPU.
3. Please add an even layer of heat sink paste between the CPU and CPU cooler.
4. Please make sure the CPU cooler is installed on the CPU prior to system use, otherwise overheating and permanent damage of the CPU may occur.
5. Please set the CPU host frequency in accordance with the processor specifications. It is not recommended that the system bus frequency be set beyond hardware specifications since it does not meet the required standards for the peripherals. If you wish to set the frequency beyond the proper specifications, please do so according to your hardware specifications including the CPU, graphics card, memory, hard drive, etc.



NOTE

HT functionality requirement content :

Enabling the functionality of Hyper-Threading Technology for your computer system requires all of the following platform components:

- CPU: An Intel® Pentium 4 Processor with HT Technology
- Chipset: An Intel® Chipset that supports HT Technology
- BIOS: A BIOS that supports HT Technology and has it enabled
- OS: An operation system that has optimizations for HT Technology

1-3-1 Installation of the CPU

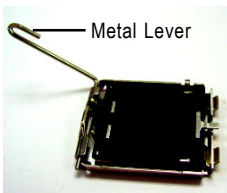

Fig. 1
Gently lift the metal lever located on the CPU socket to the upright position.

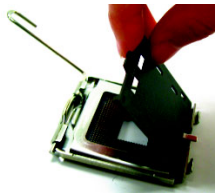

Fig. 2
Remove the plastic covering on the CPU socket.

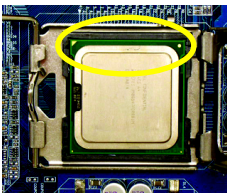

Fig. 3
Notice the small gold colored triangle located on the edge of the CPU socket. Align the indented corner of the CPU with the triangle



Fig. 4
Once the CPU is properly inserted, please replace the load plate and push the metal lever back into its original position.

and gently insert the CPU into position. (Grasping the CPU firmly between your thumb and forefinger, carefully place it into the socket in a straight and downwards motion. Avoid twisting or bending motions that might cause damage to the CPU during installation.)

1-3-2 Installation of the CPU Cooler



Fig. 1
Please apply an even layer of CPU cooler paste on the surface of the installed CPU.

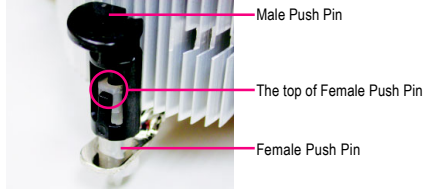

Fig. 2
(Turning the push pin along the direction of arrow is to remove the CPU cooler, on the contrary, is to install.) Please note the direction of arrow sign on the male push pin doesn't face inwards before installation. (This instruction is only for Intel boxed fan)

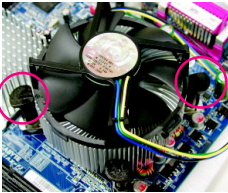

Fig. 3
Place the CPU cooler atop the CPU and make sure the push pins aim to the pin hole on the motherboard. Pressing down the push pins diagonally.

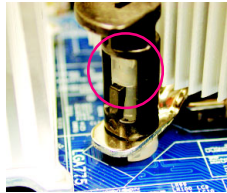

Fig. 4
Please make sure the Male and Female push pin are joined closely. (for detailed installation instructions, please refer to the CPU cooler installation section of the user manual)

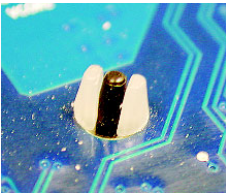

Fig. 5
Please check the back of motherboard after installing. If the push pin is inserted as the picture, the installation is complete.

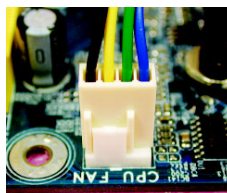

Fig. 6
Finally, please attach the power connector of the CPU cooler to the CPU fan header located on the motherboard.



The CPU cooler may adhere to the CPU as a result of hardening of the heat paste. To prevent such an occurrence, it is suggested that either thermal tape rather than heat paste be used for heat dissipation or using extreme care when removing the CPU cooler.

1-4 Installation of Memory



Before installing the memory modules, please comply with the following conditions:

1. Please make sure that the memory used is supported by the motherboard. It is recommended that memory of similar capacity, specifications and brand be used.
2. Before installing or removing memory modules, please make sure that the computer power is switched off to prevent hardware damage.
3. Memory modules have a foolproof insertion design. A memory module can be installed in only one direction. If you are unable to insert the module, please switch the direction.

The motherboard supports DDR memory modules, whereby BIOS will automatically detect memory capacity and specifications. Memory modules are designed so that they can be inserted only in one direction. The memory capacity used can differ with each slot.

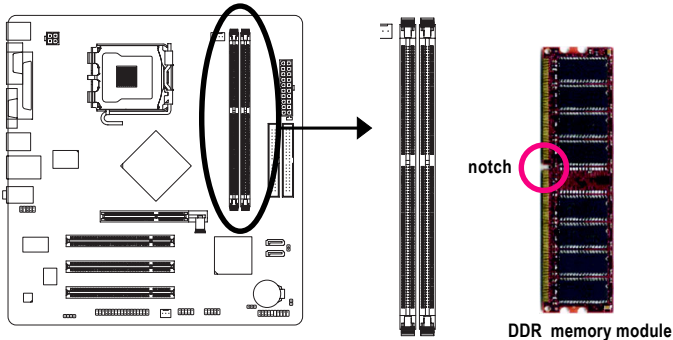

Fig.1

The DIMM socket has a notch, so the DIMM memory module can only fit in one direction. Insert the DIMM memory module vertically into the DIMM socket. Then push it down.



Fig. 1

Fig.2

Close the plastic clip at both edges of the DIMM sockets to lock the DIMM module.

Reverse the installation steps when you wish to remove the DIMM module.



Fig. 2

Dual Channel Memory Configuration

The GA-8I865GME-775-RH supports the Dual Channel Technology. After operating the Dual Channel Technology, the bandwidth of memory bus will double.

The GA-8I865GME-775-RH includes 2 DIMM sockets.

If you want to operate the Dual Channel Technology, please note the following explanations due to the limitation of Intel chipset specifications.

1. Dual Channel mode will not be enabled if only one DDR memory module is installed.
2. To enable Dual Channel mode with two memory modules (it is recommended to use memory modules of identical brand, size, chips, and speed), you must install them into DDR1 and DDR2 memory sockets.

1-5 Installation of Expansion Cards

You can install your expansion card by following the steps outlined below:

1. Read the related expansion card's instruction document before installing the expansion card into the computer.
2. Remove your computer's chassis cover, screws and slot bracket from the computer.
3. Press the expansion card firmly into expansion slot in motherboard.
4. Be sure the metal contacts on the card are indeed seated in the slot.
5. Replace the screw to secure the slot bracket of the expansion card.
6. Replace your computer's chassis cover.
7. Power on the computer, if necessary, setup BIOS utility of expansion card from BIOS.
8. Install related driver from the operating system.

Installing a AGP expansion card:

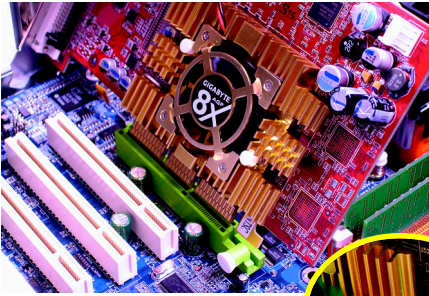

CAUTION

Please carefully pull out the small white-drawable bar at the end of the AGP slot when you try to install/uninstall the VGA card. Please align the VGA card to the onboard AGP slot and press firmly down on the slot. Make sure your VGA card is locked by the small white-drawable bar.

1-6 I/O Back Panel Introduction

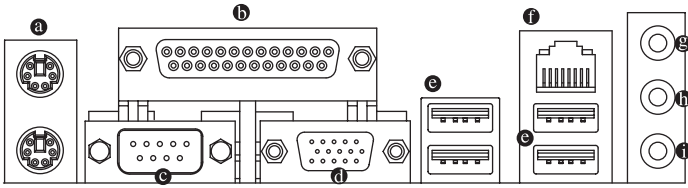

Ⓐ PS/2 Keyboard and PS/2 Mouse Connector

To install a PS/2 port keyboard and mouse, plug the mouse to the upper port (green) and the keyboard to the lower port (purple).

Ⓑ Parallel Port

The parallel port allows connection of a printer, scanner and other peripheral devices.

Ⓒ Serial Port

Connects to serial-based mouse or data processing devices.

Ⓓ VGA Port

Monitor can be connected to VGA port.

Ⓔ USB Port

Before you connect your device(s) into USB connector(s), please make sure your device(s) such as USB keyboard, mouse, scanner, zip, speaker...etc. have a standard USB interface. Also make sure your OS supports USB controller. If your OS does not support USB controller, please contact OS vendor for possible patch or driver upgrade. For more information please contact your OS or device(s) vendors.

Ⓕ LAN Port

The provided Internet connection is fast Ethernet , providing data transfer speeds of 10/100 Mbps.

Ⓖ Line In

Devices like CD-ROM, walkman etc. can be connected to Line In jack.

Ⓖ Line Out

Stereo speakers, earphone or front surround speakers can be connected to Line Out (Front Speaker Out) jack.

Ⓕ MIC In

Microphone must be connected to MIC In jack.



You can use audio software to configure 2-/4-/6- channel audio functioning.

1-7 Connectors Introduction

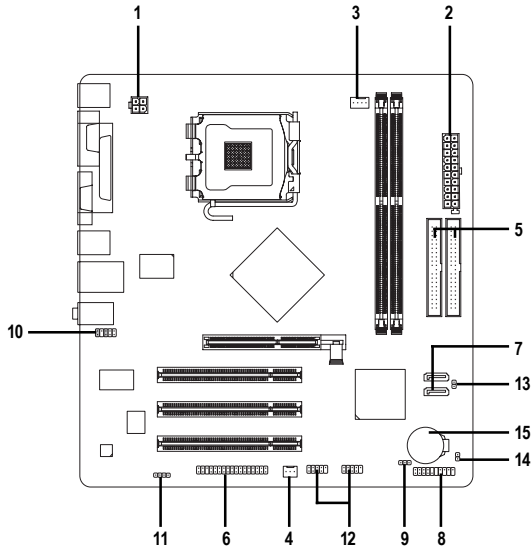

1) ATX_12V	9) PWR_LED
2) ATX (Power Connector)	10) F_AUDIO
3) CPU_FAN	11) CD_IN
4) SYS_FAN	12) F_USB1 / F_USB2
5) IDE1 / IDE2	13) CI
6) FDD	14) CLR_CMOS
7) SATA0 / SATA1	15) BATTERY
8) F_PANEL	

1/2) ATX_12V / ATX (Power Connector)

With the use of the power connector, the power supply can supply enough stable power to all the components on the motherboard. Before connecting the power connector, please make sure that all components and devices are properly installed. Align the power connector with its proper location on the motherboard and connect tightly.

The ATX_12V power connector mainly supplies power to the CPU. If the ATX_12V power connector is not connected, the system will not start.

Caution! Please use a power supply that is able to handle the system voltage requirements. It is recommended that a power supply that can withstand high power consumption be used (300W or greater). If a power supply is used that does not provide the required power, the result can lead to an unstable system or a system that is unable to start.

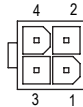
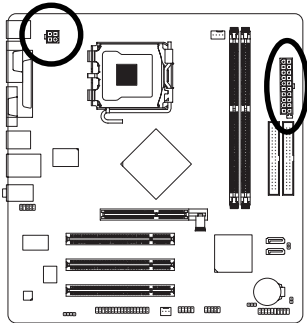

Pin No.	Definition
1	GND
2	GND
3	+12V
4	+12V

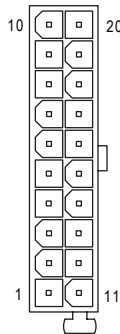

Pin No.	Definition
1	3.3V
2	3.3V
3	GND
4	+5V
5	GND
6	+5V
7	GND
8	Power Good
9	5V SB (stand by +5V)
10	+12V
11	3.3V
12	-12V
13	GND
14	PS_ON(soft on/off)
15	GND
16	GND
17	GND
18	-5V
19	+5V
20	+5V

3/4) CPU_FAN / SYS_FAN (Cooler Fan Power Connector)

The cooler fan power connector supplies a +12V power voltage via a 3-pin/4-pin(CPU_FAN) power connector and possesses a foolproof connection design.

Most coolers are designed with color-coded power connector wires. A red power connector wire indicates a positive connection and requires a +12V power voltage. The black connector wire is the ground wire (GND).

Remember to connect the CPU/system fan cable to the CPU_FAN/SYS_FAN connector to prevent CPU damage or system hanging caused by overheating.

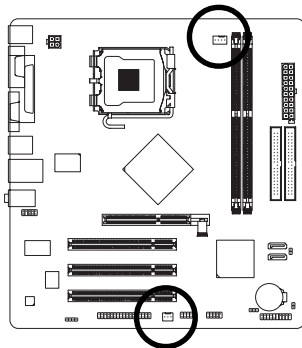

CPU_FAN



SYS_FAN

CPU_FAN :

Pin No.	Definition
1	GND
2	+12V / Speed Control
3	Sense
4	Speed Control

SYS_FAN :

Pin No.	Definition
1	GND
2	+12V
3	Sense

5) IDE1 / IDE2 (IDE Connector)

An IDE device connects to the computer via an IDE connector. One IDE connector can connect to one IDE cable, and the single IDE cable can then connect to two IDE devices (hard drive or optical drive). If you wish to connect two IDE devices, please set the jumper on one IDE device as Master and the other as Slave (for information on settings, please refer to the instructions located on the IDE device).

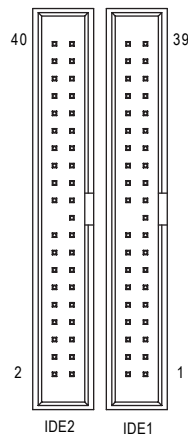
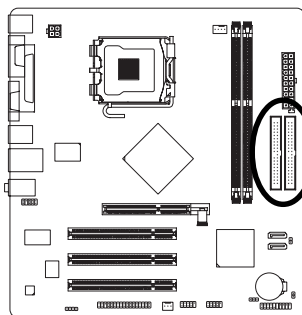

6) FDD (FDD Connector)

The FDD connector is used to connect the FDD cable while the other end of the cable connects to the FDD drive. The types of FDD drives supported are: 360 KB, 720 KB, 1.2 MB, 1.44 MB and 2.88 MB. Before attaching the FDD cable, please take note of the foolproof groove in the FDD connector.

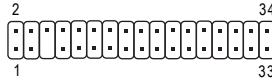
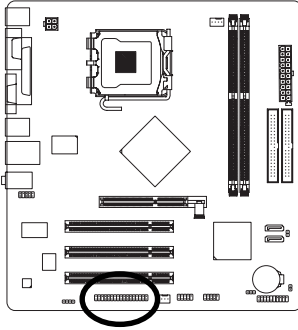

7) SATA0/SATA1 (Serial ATA Connector,)

Serial ATA can provide up to 150 MB/s transfer rate. Please refer to the BIOS setting for the Serial ATA and install the proper driver in order to work properly.

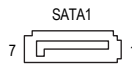
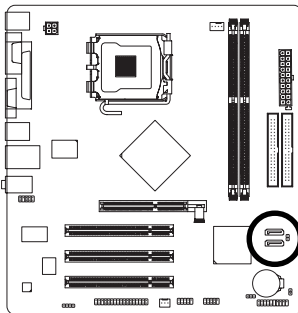

Pin No.	Definition
1	GND
2	TXP
3	TXN
4	GND
5	RXN
6	RXP
7	GND

8) F_PANEL (Front Panel Connector)

Please connect the power LED, PC speaker, reset switch and power switch etc. of your chassis front panel to the F_PANEL connector according to the pin assignment below.

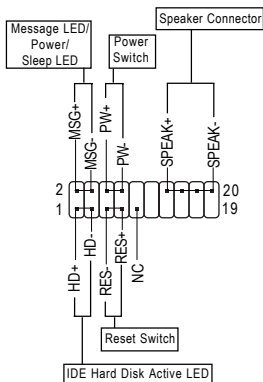
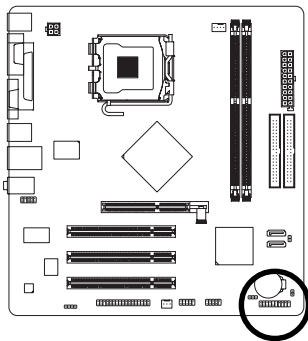

MSG (Message LED/Power/Sleep LED)	Pin 1: LED anode(+) Pin 2: LED cathode(-)
PW (Power Switch)	Open: Normal Close: Power On/Off
SPEAK (Speaker Connector)	Pin 1: Power Pin 2- Pin 3: NC Pin 4: Data(-)
HD (IDE Hard Disk Active LED)	Pin 1: LED anode(+) Pin 2: LED cathode(-)
RES (Reset Switch)	Open: Normal Close: Reset Hardware System
NC	NC

9) PWR_LED

The PWR_LED connector is connected with the system power indicator to indicate whether the system is on/off. It will blink when the system enters suspend mode(S1).

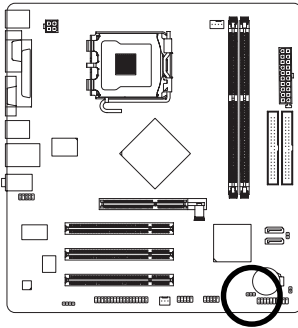

1 

Pin No.	Definition
1	MPD+
2	MPD-
3	MPD-

10) F_AUDIO (Front Audio Panel Connector)

If you want to use Front Audio connector, you must remove 5-6, 9-10 Jumper. In order to utilize the front audio header, your chassis must have front audio connector. Also please make sure the pin assignments on the cable are the same as the pin assignments on the MB header. To find out if the chassis you are buying support front audio connector, please contact your dealer. Please note, you can have the alternative of using front audio connector or of using rear audio connector to play sound.

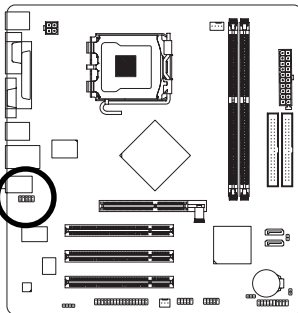

9  1
10  2

Pin No.	Definition
1	MIC
2	GND
3	MIC_BIAS
4	POWER
5	FrontAudio(R)
6	Rear Audio (R)/ Return R
7	NC
8	No Pin
9	FrontAudio (L)
10	Rear Audio (L)/ Return L

11) CD_IN (CD IN Connector)

Connect CD-ROM or DVD-ROM audio out to the connector.

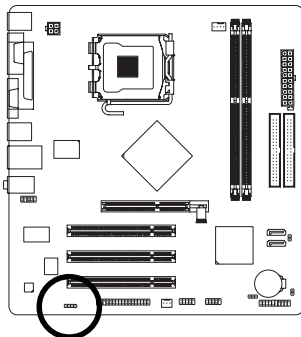

Pin No.	Definition
1	CD-L
2	GND
3	GND
4	CD-R

12) F_USB1 / F_USB2 (Front USB Connectors)

Be careful with the polarity of the front USB connector. Check the pin assignment carefully while you connect the front USB cable, incorrect connection between the cable and connector will make the device unable to work or even damage it. For optional front USB cable, please contact your local dealer.

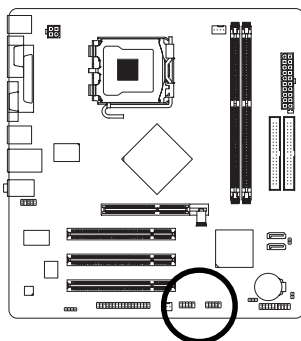

Pin No.	Definition
1	Power (5V)
2	Power (5V)
3	USB DX-
4	USB Dy-
5	USB DX+
6	USB Dy+
7	GND
8	GND
9	No Pin
10	NC

13) CI (Chassis Intrusion, Case Open)

This 2-pin connector allows your system to detect if the chassis cover is removed. You can check the "Case Opened" status in BIOS Setup.

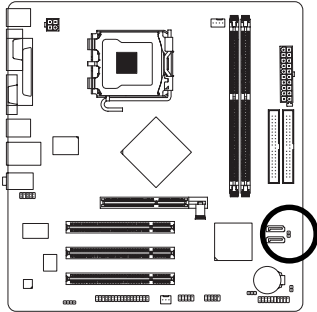



1



Pin No.	Definition
1	Signal
2	GND

14) CLR_CMOS (Clear CMOS)

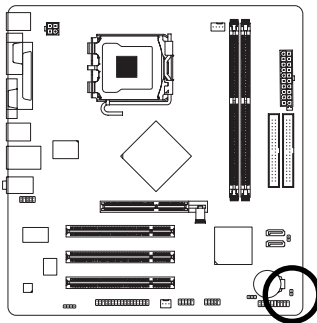
You may clear the CMOS data to its default values by this jumper. To clear CMOS, temporarily short pins 1-2. To prevent improper use of this header, we do not include a jumper on it.



 Open: Normal

 Short: Clear CMOS

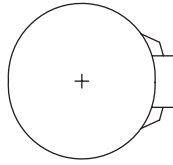
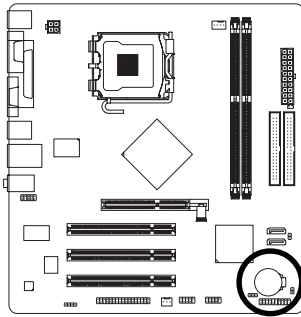
15) BATTERY



- ❖ Danger of explosion if battery is incorrectly replaced.
- ❖ Replace only with the same or equivalent type recommended by the manufacturer.
- ❖ Dispose of used batteries according to the manufacturer's instructions.

If you want to erase CMOS...

1. Turn off the computer and unplug the power cord.
2. Gently take out the battery and put it aside for about one minute.
(Or you can use a metal object to connect the positive and negative pins in the battery holder to make them short for five seconds.)
3. Re-install the battery.
4. Plug the power cord in and turn on the computer.

Chapter 2 BIOS Setup

BIOS (Basic Input and Output System) includes a CMOS SETUP utility which allows user to configure required settings or to activate certain system features.

The CMOS SETUP saves the configuration in the CMOS SRAM of the motherboard.

When the power is turned off, the battery on the motherboard supplies the necessary power to the CMOS SRAM.

When the power is turned on, pushing the button during the BIOS POST (Power-On Self Test) will take you to the CMOS SETUP screen. You can enter the BIOS setup screen by pressing "Ctrl + F1".

When setting up BIOS for the first time, it is recommended that you save the current BIOS to a disk in the event that BIOS needs to be reset to its original settings. If you wish to upgrade to a new BIOS, either GIGABYTE's Q-Flash or @BIOS utility can be used.

Q-Flash allows the user to quickly and easily update or backup BIOS without entering the operating system. @BIOS is a Windows-based utility that does not require users to boot to DOS before upgrading BIOS but directly download and update BIOS from the Internet.

CONTROL KEYS

<↑><↓><←><→>	Move to select item
<Enter>	Select Item
<Esc>	Main Menu - Quit and not save changes into CMOS Status Page Setup Menu and Option Page Setup Menu - Exit current page and return to Main Menu
<Page Up>	Increase the numeric value or make changes
<Page Down>	Decrease the numeric value or make changes
<F1>	General help, only for Status Page Setup Menu and Option Page Setup Menu
<F2>	Item Help
<F5>	Restore the previous CMOS value from CMOS, only for Option Page Setup Menu
<F6>	Load the fail-safe default CMOS value from BIOS default table
<F7>	Load the Optimized Defaults
<F8>	Q-Flash utility
<F9>	System Information
<F10>	Save all the CMOS changes, only for Main Menu

Main Menu

The on-line description of the highlighted setup function is displayed at the bottom of the screen.

Status Page Setup Menu / Option Page Setup Menu

Press <F1> to pop up a small help window that describes the appropriate keys to use and the possible selections for the highlighted item. To exit the Help Window press <Esc>.



Because BIOS flashing is potentially risky, please do it with caution and avoid inadequate operation that may result in system malfunction.

<F12> : Boot Menu

Select boot sequence for onboard (or add-on cards) device.

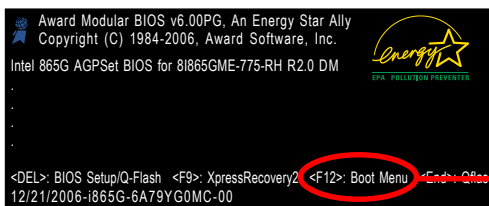

<F12> : Boot Menu

Use <↑> or <↓> to select a device, then press enter to accept . Press <ESC> to exit this menu.

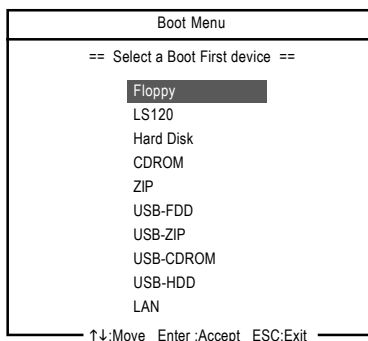

The Main Menu (For example: BIOS Ver. : DM)

Once you enter Award BIOS CMOS Setup Utility, the Main Menu (as figure below) will appear on the screen. Use arrow keys to select among the items and press <Enter> to accept or enter the sub-menu.

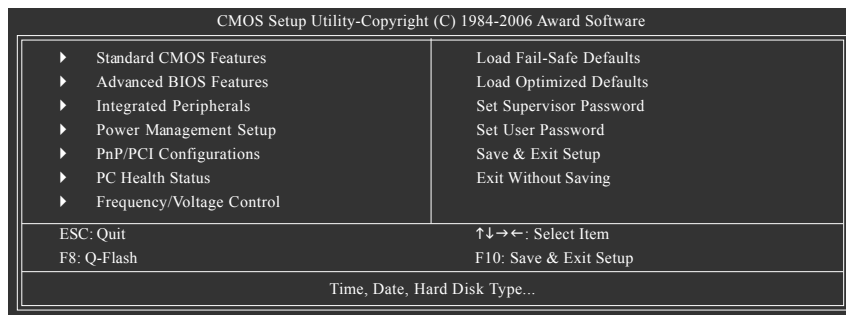

1. If you don't find the settings you want, press "Ctrl+F1" to access advanced options.
2. Select the **Load Optimized Defaults** item in the BIOS Setup when somehow the system is not stable as usual. This action makes the system reset to the default settings for stability.
3. The BIOS Setup menus described in this chapter are for reference only and may differ from the exact settings for your motherboard.

■ Standard CMOS Features

This setup page includes all the items in standard compatible BIOS.

■ Advanced BIOS Features

This setup page includes all the items of Award special enhanced features.

■ Integrated Peripherals

This setup page includes all onboard peripherals.

■ Power Management Setup

This setup page includes all the items of Green function features.

■ PnP/PCI Configuration

This setup page includes all the configurations of PCI & PnP ISA resources.

■ PC Health Status

This setup page is the System auto detect Temperature, voltage, fan, speed.

■ Frequency/Voltage Control

This setup page is control CPU clock and frequency ratio.

■ Load Fail-Safe Defaults

Fail-Safe Defaults indicates the value of the system parameters which the system would be in safe configuration.

■ Load Optimized Defaults

Optimized Defaults indicates the value of the system parameters which the system would be in best performance configuration.

■ Set Supervisor Password

Change, set, or disable password. It allows you to limit access to the system and Setup, or just to Setup.

■ Set User Password

Change, set, or disable password. It allows you to limit access to the system.

■ Save & Exit Setup

Save CMOS value settings to CMOS and exit setup.

■ Exit Without Saving

Abandon all CMOS value changes and exit setup.

2-1 Standard CMOS Features

CMOS Setup Utility-Copyright (C) 1984-2006 Award Software Standard CMOS Features		
Date (mm:dd:yy)	Fri, Dec 22 2006	Item Help
Time (hh:mm:ss)	22:31:24	Menu Level▶
▶ IDE Channel 0 Master	[None]	
▶ IDE Channel 0 Slave	[None]	
▶ IDE Channel 1 Master	[None]	
▶ IDE Channel 1 Slave	[None]	
▶ IDE Channel 2 Master	[None]	
▶ IDE Channel 3 Master	[None]	
Drive A	[1.44M, 3.5"]	
Floppy 3 Mode Support	[Disabled]	
Halt On	[All, But Keyboard]	
Base Memory	640K	
Extended Memory	239M	
↑↓→←: Move Enter: Select +/-/PU/PD: Value F10: Save ESC: Exit F1: General Help F5: Previous Values F6: Fail-Safe Default F7: Optimized Defaults		

☞ Date

The date format is <week>, <month>, <day>, <year>.

- ▶▶ Week The week, from Sun to Sat, determined by the BIOS and is display-only
- ▶▶ Month The month, Jan. Through Dec.
- ▶▶ Day The day, from 1 to 31 (or the maximum allowed in the month)
- ▶▶ Year The year, from 1999 through 2098

☞ Time

The times format in <hour> <minute> <second>. The time is calculated base on the 24-hour military-time clock. For example, 1 p.m. is 13:00:00.

☞ IDE Channel 0 Master/Slave ; IDE Channel 1 Master/Slave

- ▶▶ IDE HDD Auto-Detection Press "Enter" to select this option for automatic device detection.
- ▶▶ IDE Channel 0 Master/Slave ; IDE Channel 1 Master/Slave
IDE devices setup. You can use one of three methods:
 - Auto Allows BIOS to automatically detect IDE/SATA devices during POST(default)
 - None Select this if no IDE/SATA devices are used and the system will skip the automatic detection step and allow for faster system start up.
 - Manual User can manually input the correct settings.
- ▶▶ Access Mode Use this to set the access mode for the hard drive. The four options are:
CHS/LBA/Large/Auto(default:Auto)
- ▶▶ Capacity Capacity of correctly installed hard drive.

☞ IDE Channel 2/3 Master

- ▶▶ IDE HDD Auto-Detection Press "Enter" to select this option for automatic device detection.
- ▶▶ Extended IDE Drive You can use one of the two methods:
 - Auto Allows BIOS to automatically detect IDE/SATA devices during POST(default)
 - None Select this if no IDE/SATA devices are used and the system will skip the automatic detection step and allow for faster system start up.

- » Access Mode Use this to set the access mode for the hard drive. The two options are: Large/Auto(default:Auto)
- » Capacity Capacity of currently installed hard drive.
Hard drive information should be labeled on the outside drive casing. Enter the appropriate option based on this information.
- » Cylinder Number of cylinders
- » Head Number of heads
- » Precomp Write precomp
- » Landing Zone Landing zone
- » Sector Number of sectors

☞ Drive A

The category identifies the types of floppy disk drive A that has been installed in the computer.

- » None No floppy drive installed
- » 360K, 5.25" 5.25 inch PC-type standard drive; 360 KB capacity.
- » 1.2M, 5.25" 5.25 inch AT-type high-density drive; 1.2 MB capacity.
(3.5 inch when 3 Mode is Enabled).
- » 720K, 3.5" 3.5 inch double-sided drive; 720 KB capacity.
- » 1.44M, 3.5" 3.5 inch double-sided drive; 1.44 MB capacity.
- » 2.88M, 3.5" 3.5 inch double-sided drive; 2.88 MB capacity.

☞ Floppy 3 Mode Support (for Japan Area)

- » Disabled Normal Floppy Drive. (Default value)
- » Drive A Drive A is 3 mode Floppy Drive.

☞ Halt on

The category determines whether the computer will stop if an error is detected during power up.

- » No Errors The system boot will not stop for any error that may be detected and you will be prompted.
- » All Errors Whenever the BIOS detects a non-fatal error the system will be stopped.
- » All, But Keyboard The system boot will not stop for a keyboard error; it will stop for all other errors. (Default value)
- » All, But Diskette The system boot will not stop for a disk error; it will stop for all other errors.
- » All, But Disk/Key The system boot will not stop for a keyboard or disk error; it will stop for all other errors.

☞ Memory

The category is display-only which is determined by POST (Power On Self Test) of the BIOS.

» Base Memory

The POST of the BIOS will determine the amount of base (or conventional) memory installed in the system.

The value of the base memory is typically 512 K for systems with 512 K memory installed on the motherboard, or 640K for systems with 640 K or more memory installed on the motherboard.

» Extended Memory

The BIOS determines how much extended memory is present during the POST.

This is the amount of memory located above 1 MB in the CPU's memory address map.

2-2 Advanced BIOS Features

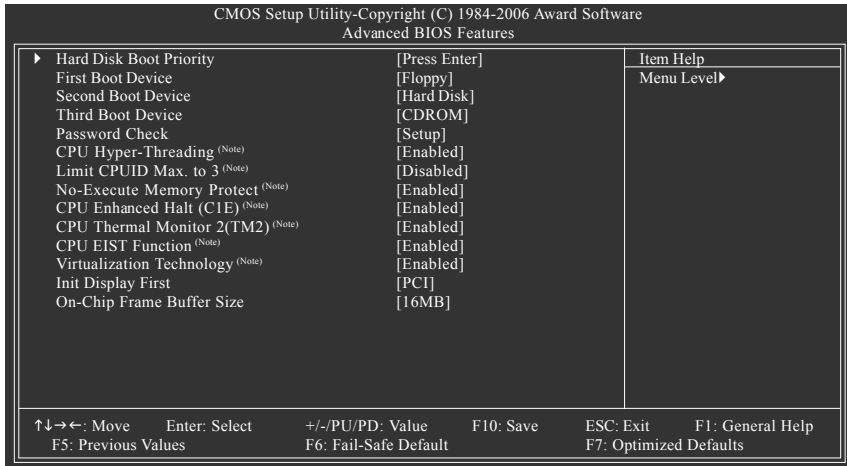

☞ Hard Disk Boot Priority

Select boot sequence for onboard(or add-on cards) SCSI, RAID, etc.

Use <↑> or <↓> to select a device, then press<+> to move it up, or <-> to move it down the list. Press <ESC> to exit this menu.

☞ First / Second / Third Boot Device

- ▶ Floppy Select your boot device priority by Floppy.
- ▶ LS120 Select your boot device priority by LS120.
- ▶ Hard Disk Select your boot device priority by Hard Disk.
- ▶ CDROM Select your boot device priority by CDROM.
- ▶ ZIP Select your boot device priority by ZIP.
- ▶ USB-FDD Select your boot device priority by USB-FDD.
- ▶ USB-ZIP Select your boot device priority by USB-ZIP.
- ▶ USB-CDROM Select your boot device priority by USB-CDROM.
- ▶ USB-HDD Select your boot device priority by USB-HDD.
- ▶ LAN Select your boot device priority by LAN.
- ▶ Disabled Disable this function.

☞ Password Check

- ▶ System The system can not boot and can not access to Setup page will be denied if the correct password is not entered at the prompt.
- ▶ Setup The system will boot, but access to Setup will be denied if the correct password is not entered at the prompt. (Default value)

(Note) This item will show up when you install a processor that supports this function.

- ☞ **CPU Hyper-Threading** ^(Note)
 - ▶▶ Enabled Enable CPU Hyper Threading Feature. Please note that this feature is only working for operating system with multi processors mode supported. (Default value)
 - ▶▶ Disabled Disable CPU Hyper Threading.
- ☞ **Limit CPUID Max. to 3** ^(Note)
 - ▶▶ Enabled Limit CPUID Maximum value to 3 when use older OS like NT4.
 - ▶▶ Disabled Disable CPUID Limit for windows XP. (Default value)
- ☞ **No-Execute Memory Protect** ^(Note)
 - ▶▶ Enabled Enable No-Execute Memory Protect function.(Default value)
 - ▶▶ Disabled Disable No-Execute Memory Protect function.
- ☞ **CPU Enhanced Halt (C1E)** ^(Note)
 - ▶▶ Enabled Enable CPU Enhanced Halt (C1E) function.(Default value)
 - ▶▶ Disabled Disable CPU Enhanced Halt (C1E) function.
- ☞ **CPU Thermal Monitor 2 (TM2)** ^(Note)
 - ▶▶ Enabled Enable CPU Thermal Monitor 2 (TM2) function.(Default value)
 - ▶▶ Disabled Disable CPU Thermal Monitor 2 (TM2) function.
- ☞ **CPU EIST Function** ^(Note)
 - ▶▶ Enabled Enable CPU EIST function.(Default value)
 - ▶▶ Disabled Disable CPU EIST function.
- ☞ **Virtualization Technology** ^(Note)
 - ▶▶ Enabled Enable Virtualization Technology function. (Default value)
 - ▶▶ Disabled Disable Virtualization Technology function.
- ☞ **Init Display First**

Select the first initiation of the monitor display from onboard/AGP or PCI VGA card.

 - ▶▶ PCI Set Init Display First to PCI VGA card. (Default value)
 - ▶▶ Onboard/AGP Set Init Display First to onboard/AGP VGA card.
- ☞ **On-Chip Frame Buffer Size**
 - ▶▶ 1MB Set on-chip frame buffer size to 1 MB.
 - ▶▶ 4MB Set on-chip frame buffer size to 4 MB.
 - ▶▶ 8MB Set on-chip frame buffer size to 8 MB.
 - ▶▶ 16MB Set on-chip frame buffer size to 16 MB. (Default value)
 - ▶▶ 32MB Set on-chip frame buffer size to 32 MB.

(Note) This item will show up when you install a processor that supports this function.

2-3 Integrated Peripherals

CMOS Setup Utility-Copyright (C) 1984-2006 Award Software Integrated Peripherals		
On-Chip Primary PCI IDE	[Enabled]	Item Help
On-Chip Secondary PCI IDE	[Enabled]	Menu Level▶
On-Chip SATA	[Auto]	
x SATA Port0 configure as	SATA Port0	
SATA Port1 configure as	SATA Port1	
USB Controller	[Enabled]	
USB 2.0 Controller	[Enabled]	
USB Keyboard Support	[Disabled]	
USB Mouse Support	[Disabled]	
Legacy USB storage detect	[Enabled]	
AC97 Audio	[Auto]	
Onboard H/W LAN	[Enabled]	
OnBoard LAN Boot ROM	[Disabled]	
Onboard Serial Port 1	[3F8/IRQ4]	
Onboard Parallel Port	[378/IRQ7]	
Parallel Port Mode	[SPP]	
x ECP Mode Use DMA	3	

↑↓→←: Move	Enter: Select	+/-/PU/PD: Value	F10: Save	ESC: Exit	F1: General Help
F5: Previous Values		F6: Fail-Safe Default		F7: Optimized Defaults	

☞ On-Chip Primary PCI IDE

- ▶▶ Enabled Enable onboard 1st channel IDE port. (Default value)
- ▶▶ Disabled Disable onboard 1st channel IDE port.

☞ On-Chip Secondary PCI IDE

- ▶▶ Enabled Enable onboard 2nd channel IDE port. (Default value)
- ▶▶ Disabled Disable onboard 2nd channel IDE port.

☞ On-Chip SATA

- ▶▶ Disabled Disable onboard Serial ATA function.
- ▶▶ Auto When there is no device to be plugged in IDE1 or IDE2, SATA controller will remap to IDE controller. (Default value)
- ▶▶ Manual Set SATA mode manually from "SATA Port0 configure as" item.

☞ SATA Port0 configure as

- ▶▶ IDE Pri. Master Set SATA controller to compatible mode. This mode will remap SATA Port 0 to IDE Primary Master.
- ▶▶ IDE Pri. Slave Set SATA controller to compatible mode. This mode will remap SATA Port 0 to IDE Primary Slave.
- ▶▶ IDE Sec. Master Set SATA controller to compatible mode. This mode will remap SATA Port 0 to IDE Secondary Master.
- ▶▶ IDE Sec. Slave Set SATA controller to compatible mode. This mode will remap SATA Port 0 to IDE Secondary Slave.
- ▶▶ SATA Port0 Set SATA controller to native mode(Serial ATA mode - SATA Port 0). This mode is only supported by Windows XP or later. (Default value)
- ▶▶ SATA Port1 Set SATA controller to native mode(Serial ATA mode - SATA Port 1). This mode is only supported by Windows XP or later.

☞ **SATA Port1 configure as**

‣ The setting depends on "SATA Port0 configure as" item setting. (Default: SATA Port1)

☞ **USB Controller**

- Enabled Enable USB controller. (Default value)
- Disabled Disable USB controller.

☞ **USB 2.0 Controller**

You can disable this function if you are not using onboard USB 2.0 feature.

- Enabled Enable USB 2.0 controller. (Default value)
- Disabled Disable USB 2.0 controller.

☞ **USB Keyboard Support**

- Enabled Enable USB keyboard support.
- Disabled Disable USB keyboard support. (Default value)

☞ **USB Mouse Support**

- Enabled Enable USB mouse support.
- Disabled Disable USB mouse support. (Default value)

☞ **Legacy USB storage detect**

- Enabled Enable USB storage detect function. (Default value)
- Disabled Disable this function.

☞ **AC97 Audio**

- Auto Enable onboard AC'97 audio function. (Default value)
- Disabled Disable this function.

☞ **Onboard H/W LAN**

- Enabled Enable onboard H/W LAN function. (Default value)
- Disabled Disable this function.

☞ **OnBoard LAN Boot ROM**

This function decide whether to invoke the boot ROM of the onboard LAN chip.

- Enabled Enable this function.
- Disabled Disable this function. (Default value)

☞ **Onboard Serial Port 1**

- Auto BIOS will automatically setup the Serial port 1 address.
- 3F8/IRQ4 Enable onboard Serial port 1 and address is 3F8. (Default value)
- 2F8/IRQ3 Enable onboard Serial port 1 and address is 2F8.
- 3E8/IRQ4 Enable onboard Serial port 1 and address is 3E8.
- 2E8/IRQ3 Enable onboard Serial port 1 and address is 2E8.
- Disabled Disable onboard Serial port 1.

☞ **Onboard Parallel Port**

- ▶▶ Disabled Disable onboard LPT port.
- ▶▶ 378/IRQ7 Enable onboard LPT port and address is 378/IRQ7. (Default value)
- ▶▶ 278/IRQ5 Enable onboard LPT port and address is 278/IRQ5.
- ▶▶ 3BC/IRQ7 Enable onboard LPT port and address is 3BC/IRQ7.

☞ **Parallel Port Mode**

- ▶▶ SPP Using Parallel port as Standard Parallel Port. (Default value)
- ▶▶ EPP Using Parallel port as Enhanced Parallel Port.
- ▶▶ ECP Using Parallel port as Extended Capabilities Port.
- ▶▶ ECP+EPP Using Parallel port as ECP and EPP mode.

☞ **ECP Mode Use DMA**

- ▶▶ 3 Set ECP Mode Use DMA to 3. (Default value)
- ▶▶ 1 Set ECP Mode Use DMA to 1.

2-4 Power Management Setup

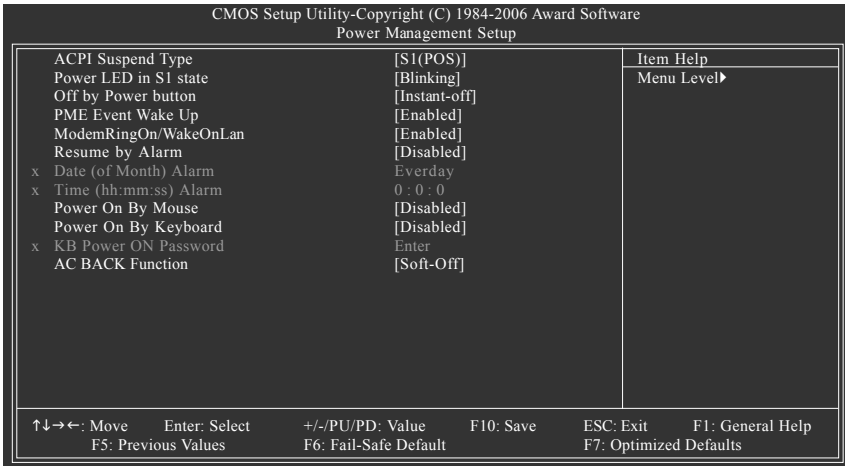

☞ ACPI Suspend Type

- ▶▶ S1(POS) Set ACPI suspend type to S1/POS(Power On Suspend). (Default value)
- ▶▶ S3(STR) Set ACPI suspend type to S3/STR(Suspend To RAM).

☞ Power LED in S1 state

- ▶▶ Blinking In standby mode(S1), poer LED will blink. (Default value)
- ▶▶ Dual/OFF In standby mode(S1):
 - a. If use single color LED, power LED will turn off.
 - b. If use dual color LED, power LED will turn to another color.

☞ Off by Power button

- ▶▶ Instant-off Press power button then Power off instantly. (Default value)
- ▶▶ Delay 4 Sec. Press power button 4 sec. to Power off. Enter suspend if button is pressed less than 4 seconds.

☞ PME Event Wake Up

This feature requires an ATX power supply that provides at least 1A on the 5VSB lead.

- ▶▶ Disabled Disable this function.
- ▶▶ Enabled Enable PME as wake up event. (Default value)

☞ ModemRingOn/WakeOnLan

An incoming call via modem can awake the system from any suspend state or an input signal comes from the other client server on the LAN can awake the system from any suspend state.

- ▶▶ Disabled Disable Modem Ring On / Wake On LAN function.
- ▶▶ Enabled Enable Modem Ring On / Wake On LAN function. (Default value)

☞ **Resume by Alarm**

You can set "Resume by Alarm" item to Enabled and key in Date/Time to power on system.

- ▶▶ Disabled Disable this function. (Default value)
- ▶▶ Enabled Enable alarm function to POWER ON system.

If Resume by Alarm is Enabled.

- ▶▶ Date (of Month) Alarm : Everyday, 1~31
- ▶▶ Time (hh: mm: ss) Alarm : (0~23) : (0~59) : (0~59)

☞ **Power On By Mouse**

- ▶▶ Disabled Disable this function. (Default value)
- ▶▶ Double Click Double click on PS/2 mouse left button to power on the system.

☞ **Power On By Keyboard**

- ▶▶ Disabled Disable this function. (Default value)
- ▶▶ Password Enter from 1 to 5 characters to set the keyboard power on password.
- ▶▶ Keyboard 98 If your keyboard have "POWER Key" button, you can press the key to power on the system.

☞ **KB Power ON Password**

When "Power On by Keyboard" set at Password, you can set the password here.

- ▶▶ Enter Input password(from 1 to 5 characters) and press Enter to set the password.

☞ **AC BACK Function**

- ▶▶ Soft-Off When AC-power back to the system, the system will be in "Off" state.
(Default value)
- ▶▶ Full-On When AC-power back to the system, the system always in "On" state.

2-5 PnP/PCI Configurations

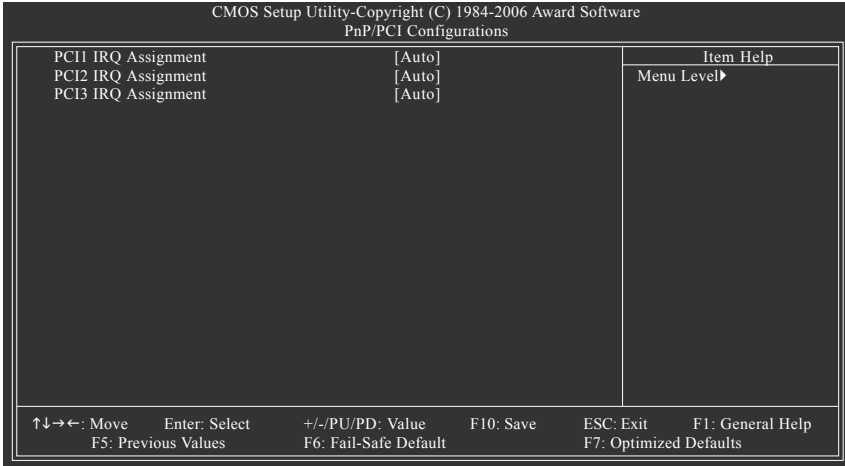

☞ PCI1 IRQ Assignment

- ▶▶ Auto Auto assign IRQ to PCI1. (Default value)
- ▶▶ 3,4,5,7,9,10,11,12,14,15 Set IRQ 3,4,5,7,9,10,11,12,14,15 to PCI1.

☞ PCI2 IRQ Assignment

- ▶▶ Auto Auto assign IRQ to PCI2. (Default value)
- ▶▶ 3,4,5,7,9,10,11,12,14,15 Set IRQ 3,4,5,7,9,10,11,12,14,15 to PCI2.

☞ PCI3 IRQ Assignment

- ▶▶ Auto Auto assign IRQ to PCI3. (Default value)
- ▶▶ 3,4,5,7,9,10,11,12,14,15 Set IRQ 3,4,5,7,9,10,11,12,14,15 to PCI3.

2-6 PC Health Status

CMOS Setup Utility-Copyright (C) 1984-2006 Award Software		PC Health Status	
Reset Case Open Status	[Disabled]	Item Help	
Case Opened	No	Menu Level▶	
Vcore	OK		
DDR25V	OK		
+3.3V	OK		
+12V	OK		
Current CPU Temperature	45°C		
Current CPU FAN Speed	3245 RPM		
Current SYSTEM FAN Speed	0 RPM		
CPU Warning Temperature	[Disabled]		
CPU FAN Fail Warning	[Disabled]		
SYSTEM FAN Fail Warning	[Disabled]		
CPU Smart FAN Control	[Enabled]		
CPU Smart FAN Mode	[Auto]		
↑↓←→: Move Enter: Select +/-/PU/PD: Value F10: Save ESC: Exit F1: General Help F5: Previous Values F6: Fail-Safe Defaults F7: Optimized Defaults			

☞ Reset Case Open Status

- ▶ Disabled Don't reset case open status. (Default value)
- ▶ Enabled Clear case open status at next boot.

☞ Case Opened

If the case is closed, "Case Opened" will show "No".

If the case have been opened, "Case Opened" will show "Yes".

If you want to reset "Case Opened" value, set "Reset Case Open Status" to "Enabled" and save CMOS, your computer will restart.

☞ Current Voltage(V) Vcore / DDR25V / +3.3V / +12V

- ▶ Detect system's voltage status automatically.

☞ Current CPU Temperature

- ▶ Detect CPU temperature automatically.

☞ Current CPU/SYSTEM FAN Speed (RPM)

- ▶ Detect CPU/SYSTEM Fan speed status automatically.

☞ CPU Warning Temperature

- ▶ 60°C / 140°F Monitor CPU temperature at 60°C / 140°F.
- ▶ 70°C / 158°F Monitor CPU temperature at 70°C / 158°F.
- ▶ 80°C / 176°F Monitor CPU temperature at 80°C / 176°F.
- ▶ 90°C / 194°F Monitor CPU temperature at 90°C / 194°F.
- ▶ Disabled Disable this function. (Default value)

☞ CPU/SYSTEM FAN Fail Warning

- ▶ Disabled Disable the fan fail warning function. (Default value)
- ▶ Enabled Enable the fan fail warning function.

☞ CPU Smart FAN Control

- ▶▶ Disabled Disable this function.
- ▶▶ Enabled When this function is enabled, CPU fan will run at different speed depending on CPU temperature. Users can adjust the fan speed with Easy Tune based on their requirements. (Default Value)

☞ CPU Smart FAN Mode

This option is available only when CPU Smart FAN Control is enabled.

- ▶▶ Auto BIOS autodetects the type of CPU fan you installed and sets the optimal CPU Smart FAN control mode for it. (Default Value)
- ▶▶ Voltage Set to Voltage when you use a CPU fan with a 3-pin fan power cable.
- ▶▶ PWM Set to PWM when you use a CPU fan with a 4-pin fan power cable.

Note: In fact, the Voltage option can be used for CPU fans with 3-pin or 4-pin power cables. However, some 4-pin CPU fan power cables are not designed following Intel 4-Wire fans PWM control specifications. With such CPU fans, selecting PWM will not effectively reduce the fan speed.

2-7 Frequency/Voltage Control

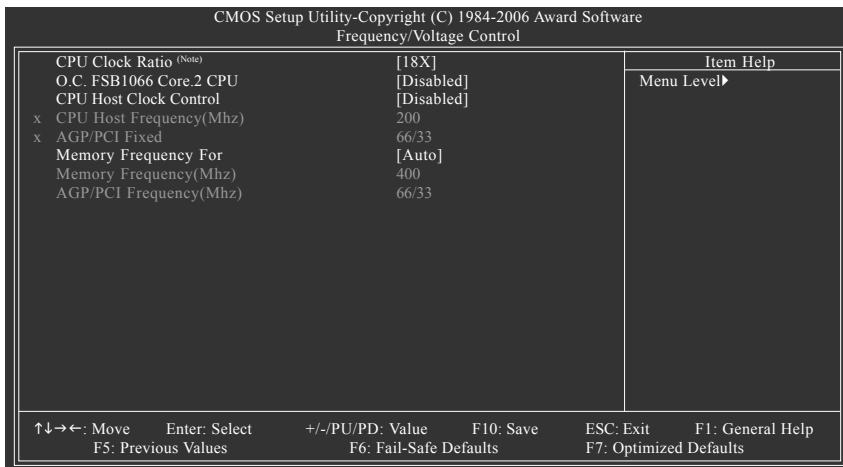

CAUTION

Incorrectly using these features may result in system instability or corruption.

Doing an overclock or overvoltage on CPU, chipsets and memory modules may result in damages or shortened life expectancy to these components. Please be aware that the menu items are for power users only.

☞ CPU Clock Ratio ^(Note)

This setup option will automatically assign by CPU detection.

The option will display "Locked" and read only if the CPU ratio is not changeable.

☞ O.C. FSB1066 Core.2 CPU

Enable use of Core™ 2 CPUs with 1066 MHz FSB through overclocking. To enable this feature, you must install DDR 400 memory module(s), a Core™ 2 CPU and a AGP graphics card.

▶▶ Disabled Disable the use of Core™ 2 CPU (1066 MHz FSB). (Default value)

▶▶ Enabled Enable the use of Core™ 2 CPU (1066 MHz FSB).

☞ CPU Host Clock Control

Please note that if your system is overclocked and cannot restart, please wait 20 secs. for automatic system restart or clear the CMOS setup data and perform a safe restart.

▶▶ Disabled Disable CPU Host Clock Control. (Default value)

▶▶ Enabled Enable CPU Host Clock Control.

☞ CPU Host Frequency (Mhz)

▶▶ 100 ~ 355 Set CPU Host Frequency from 100 MHz to 355 MHz.

If you use a 533 MHz FSB processor, set "CPU Host Frequency" to 133 MHz.

If you use an 800 MHz FSB processor, set "CPU Host Frequency" to 200 MHz.

Incorrect using it may cause your system broken. For power End-User use only!

(Note) This item will show up when you install a processor which supports this function.

☞ **AGP/PCI Fixed**

This item will be available when "CPU Host Clock Control" is set to Enabled.

▶▶ Disabled, 66/33 ~ 96/48 Adjust AGP/PCI clock asynchronous with CPU.

☞ **Memory Frequency For**

The adjustable range will vary based on the CPU FSB. Default value: Auto (set memory frequency by DRAM SPD data). Wrong frequency settings may cause system unable to boot. Clear CMOS to overcome wrong frequency issue.

☞ **Memory Frequency (Mhz)**

▶▶ The values depend on **CPU Host Frequency(Mhz)** and **Memory Frequency For** setting.

☞ **AGP/PCI Frequency(Mhz)**

▶▶ The values depend on **AGP/PCI Fixed** setting.

2-8 Load Fail-Safe Defaults

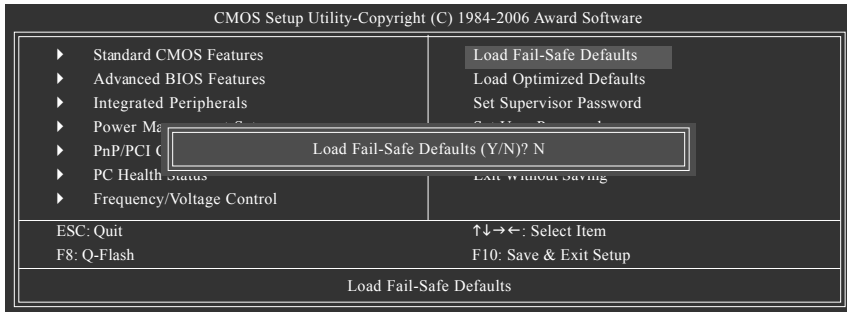

Fail-Safe defaults contain the most appropriate values of the system parameters that allow minimum system performance.

2-9 Load Optimized Defaults

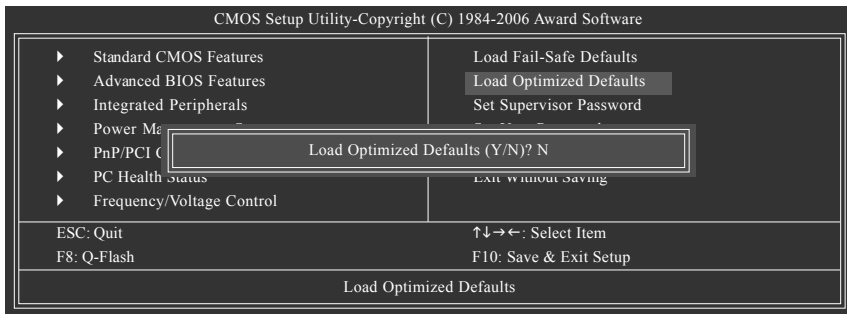

Selecting this field loads the factory defaults for BIOS and Chipset Features which the system automatically detects.

2-10 Set Supervisor/User Password

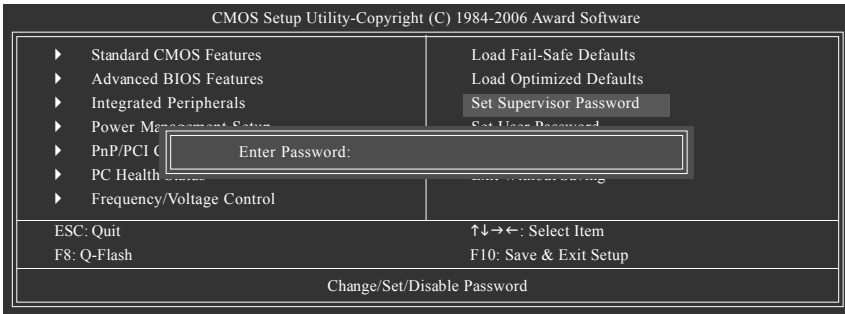

When you select this function, the following message will appear at the center of the screen to assist you in creating a password.

Type the password, up to eight characters, and press <Enter>. You will be asked to confirm the password. Type the password again and press <Enter>. You may also press <Esc> to abort the selection and not enter a password.

To disable password, just press <Enter> when you are prompted to enter password. A message "PASSWORD DISABLED" will appear to confirm the password being disabled. Once the password is disabled, the system will boot and you can enter Setup freely.

The BIOS Setup program allows you to specify two separate passwords:

SUPERVISOR PASSWORD and a USER PASSWORD. When disabled, anyone may access all BIOS Setup program function. When enabled, the Supervisor password is required for entering the BIOS Setup program and having full configuration fields, the User password is required to access only basic items.

If you select "System" at "Password Check" in Advance BIOS Features Menu, you will be prompted for the password every time the system is rebooted or any time you try to enter Setup Menu.

If you select "Setup" at "Password Check" in Advance BIOS Features Menu, you will be prompted only when you try to enter Setup.

2-11 Save & Exit Setup

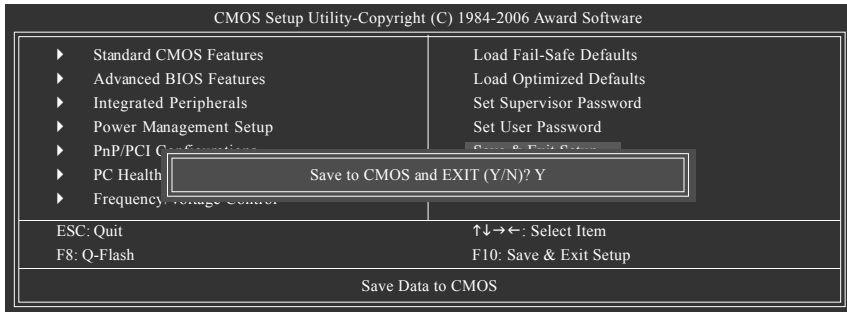

Type "Y" will quit the Setup Utility and save the user setup value to RTC CMOS.
Type "N" will return to Setup Utility.

2-12 Exit Without Saving

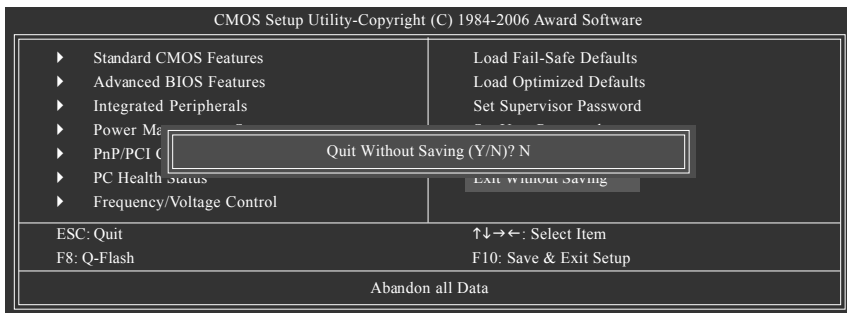

Type "Y" will quit the Setup Utility without saving to RTC CMOS.
Type "N" will return to Setup Utility.

Chapter 3 Drivers Installation



Pictures below are shown in Windows XP.

(1) Please make sure to install the latest service pack for Windows after OS installation and before installing motherboard drivers.

(2) Insert the driver CD that came with your motherboard into your CD-ROM drive, the driver CD will auto start and installation screen will appear. If not, please double click the CD-ROM device icon in **My computer** or execute the Setup.exe in the root directory of the driver CD.

3-1 Install Chipset Drivers

After insert the driver CD, "Xpress Install" will scan automatically the system and then list all the drivers that recommended to install. The "Xpress Install" uses the "Click and Go" technology to install the drivers automatically. Just select the drivers you want then click the "GO" button. The "Xpress Install" will execute the installation for you automatically.

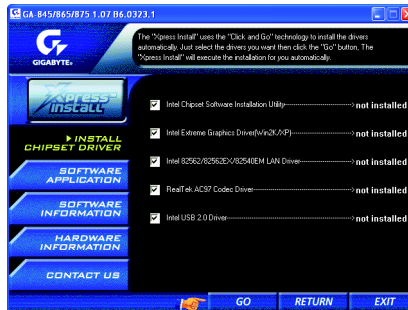

Some device drivers will restart your system automatically. After restarting your system the "Xpress Install" will continue to install other drivers.

System will reboot automatically after install the drivers, afterward you can install others application.



For USB2.0 driver support under Windows XP operating system, please use Windows Service Pack. After install Windows Service Pack, it will show a question mark "?" in "Universal Serial Bus controller" under "Device Manager". Please remove the question mark and restart the system (System will auto-detect the right USB2.0 driver).

3-4 Hardware Information

This page lists all device you have for this motherboard.

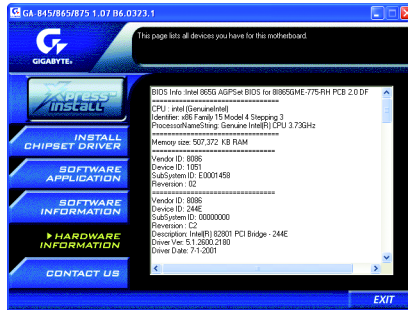

3-5 Contact Us

You can also see the last page of this manual for contacts information details.



Chapter 4 Appendix

4-1 Unique Software Utilities

(Not all model support these Unique Software Utilities, please check your MB features.)

4-1-1 EasyTune 5 Introduction

EasyTune 5 presents the most convenient Windows based system performance enhancement and manageability utility. Featuring several powerful yet easy to use tools such as 1) Overclocking for enhancing system performance, 2) C.I.A. and M.I.B. for special enhancement for CPU and Memory, 3) Smart-Fan control for managing fan speed control of both CPU cooling fan and North-Bridge Chipset cooling fan, 4) PC health for monitoring system status.^(Note)

User Interface Overview



	Button / Display	Description
1.	Overclocking	Enters the Overclocking setting page
2.	C.I.A./C.I.A.2 and M.I.B.	Enters the C.I.A./2 and M.I.B. setting page
3.	Smart-Fan	Enters the Smart-Fan setting page
4.	PC Health	Enters the PC Health setting page
5.	GO	Confirmation and Execution button
6.	"Easy Mode" & "Advance Mode"	Toggles between Easy and Advance Mode
7.	Display screen	Display panel of CPU frequency
8.	Function display LEDs	Shows the current functions status
9.	GIGABYTE Logo	Log on to GIGABYTE website
10.	Help button	Display EasyTune™ 5 Help file
11.	Exit or Minimize button	Quit or Minimize EasyTune™ 5 software

(Note) EasyTune 5 functions may vary depending on different motherboards.

4-1-2 Xpress Recovery2 Introduction



Xpress Recovery2 is designed to provide quick backup and restoration of hard disk data. Supporting Microsoft operating systems including Windows XP/2000/NT/98/Me and DOS, and file systems including FAT16, FAT32, and NTFS, Xpress Recovery2 is able to back up data on hard disks on PATA and SATA IDE controllers. After Xpress Recovery2 is executed from CD-ROM for the first time, it will stay permanent in your hard disk. If you wish to run Xpress Recovery2 later, you can simply press F9 during system bootup to enter Xpress Recovery2 without the CD-ROM.

System requirements:

1. Intel x86 platforms
2. At least 64M bytes of system memory
3. VESA-supported VGA cards

How to use the Xpress Recovery2

Initial access by booting from CD-ROM and subsequent access by pressing the F9 key:

Steps: After entering BIOS Setup, go to **Advanced BIOS Feature** and set to boot from CD-ROM. Save the settings and exit the BIOS Setup. Insert the provided driver CD into your CD-ROM drive. Upon system restart, the message which says "Boot from CD/DVD:" will appear in the bottom left corner of the screen. Press any key to enter Xpress Recovery2.

After the steps above are completed, subsequent access to Xpress Recovery2 can be made by simply pressing the <F9> key during system power-on.



Boot from CD/DVD:

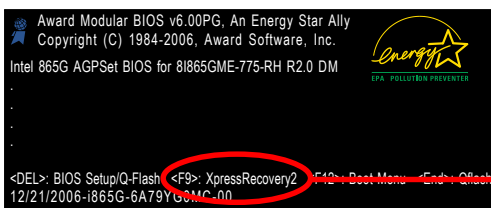

<F9>: Xpress Recovery2



1. If you have already entered Xpress Recovery2 by booting from the CD-ROM, you can enter Xpress Recovery2 by pressing the <F9> key in the future.
2. System storage capacity and the reading/writing speed of the hard disk will affect the data backup speed.
3. It is recommended that Xpress Recovery2 be immediately installed once you complete installations of OS and all required drivers as well as software.

The Main Screen of Xpress Recovery2



1. RESTORE:

Restore the backed-up data to your hard disk.
(This button will not appear if there is no backup file.)

2. BACKUP:

Back up data from hard disk.

3. REMOVE:

Remove previously-created backup files to release disk space.
(This button will not appear if there is no backup file.)

4. REBOOT:

Exit the main screen and restart the system.

Limitations:

1. Not compatible to Xpress Recovery.
2. For the use of Xpress Recovery2, a primary partition must be reserved.
3. Xpress Recovery2 will store the backup file at the end of the hard disk, so free space available on the hard disk for the backup file must be allocated in advance. (A minimum 4GB is recommended but the actual space is dependent on the size of the data to be backed up)
4. Capable of backing up hard disks installed with Windows operating systems including DOS and Windows XP/2000/NT/9x/Me.
5. USB hard disks are currently not supported.
6. Does not support RAID/AHCI (class code 0104/0106) hard disks.
7. Capable of backing up and restoring only the first physical hard disk.

Hard disks detection sequence is as follows:

- a. PATA IDE primary channel
- b. PATA IDE secondary channel
- c. SATA IDE channel 1
- d. SATA IDE channel 2
- e. SATA IDE channel 3
- f. SATA IDE channel 4

Precautions:

1. When using hard disks with more than 128G under Windows 2000, be sure to execute the EnableBigLba.exe program from the driver CD before data backup.
2. It is normal that data backup takes longer time than data restoration.
3. Xpress Recovery2 is compliant with the GPL regulations.
4. On a few motherboards based on Nvidia chipsets, BIOS update is required for Xpress Recovery2 to correctly identify RAID and SATA IDE mode. Please contact your motherboard manufacturer.

4-1-3 Flash BIOS Method Introduction



Method 1 : Q-Flash™

Q-Flash™ is a BIOS update tool that allows the user to update BIOS without entering operating systems like MS-DOS or Windows. Embedded in the BIOS, the Q-Flash™ tool frees you from the hassles of going through complicated BIOS flashing process.

Before Use:

Follow the steps below before using Q-Flash to update BIOS:

1. From GIGABYTE's website, download the latest compressed BIOS update file that matches your motherboard model
2. Extract the downloaded BIOS files and save the new BIOS file (e.g. GME775P2.FA) to your floppy disk or hard disk. Note: Q-Flash only supports FAT32/16/12 file system.
3. Restart the system. During BIOS POST, press the End key to enter Q-Flash. NOTE: Press the End key to enter Q-Flash if you wish to use hard drives in RAID/AHCI mode or hard drives attached to the independent IDE/SATA controller.

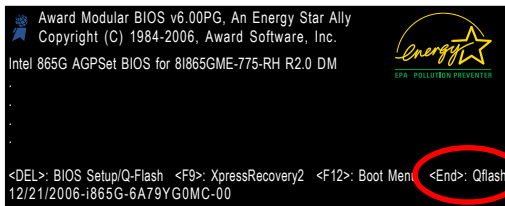

Because BIOS flashing is potentially risky, please do it with caution and avoid inadequate operation that may result in system malfunction.

Updating the BIOS

Step 1:

- a. In the Q-Flash menu, use the UP or DOWN ARROW key to select **Update BIOS from Drive** and press ENTER.



If you wish to back up the current BIOS file, use the **Save BIOS to Drive** function.

- b. Select the floppy drive or hard drive where the BIOS file is saved, such as "Floppy A" and press ENTER.

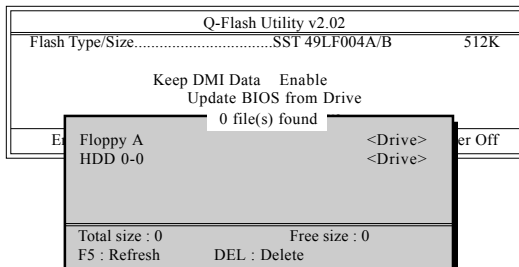

c. Select the BIOS file and press ENTER.



Make sure again the BIOS file matches your motherboard model.

Step 2: The process of system reading the BIOS file from the floppy disk is displayed on the screen. When the message "Are you sure to update BIOS?" appears, press ENTER. The BIOS update will begin and the current process will be displayed.



1. Do not turn off or restart the system when the system is reading/updating the BIOS.
2. Do not remove the floppy disk or hard drive/USB drive when the system is updating the BIOS.

Step 3: When the update process is complete, press any key to return to the Q-Flash main menu.

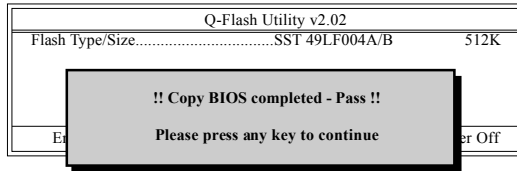

Step 4: Press ESC and then DELETE to exit Q-Flash and the system will restart. As the system reboots, you will see the new BIOS version during POST.

Step 5: As the system reboots, press DELETE to enter BIOS Setup. Select **Load Optimized Defaults** and press ENTER to load BIOS defaults. System will re-detect all peripherals devices after BIOS update, so we recommend that you reload BIOS defaults.

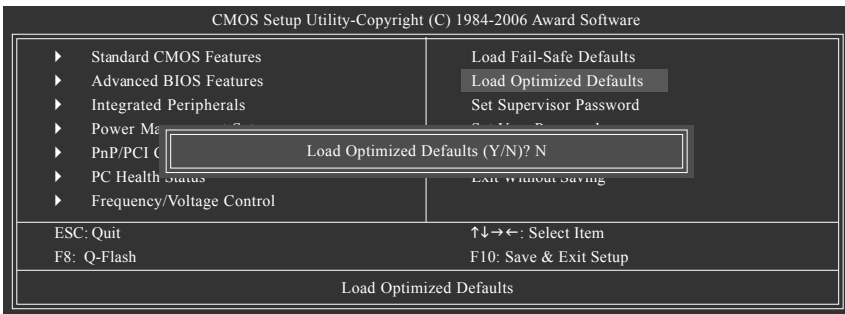

Press Y to load BIOS defaults

Step 6: Select **Save & Exit Setup** and then press **Y** to save settings to CMOS and exit BIOS Setup. When the system restarts, the whole update process is complete.



Method 2 : @BIOS™ Utility

If you do not have a DOS startup disk, we recommend that you use the new @BIOS utility. @BIOS allows users to update their BIOS under Windows. Just select the desired @BIOS server to download the latest version of BIOS.

Fig 1. Installing the @BIOS utility

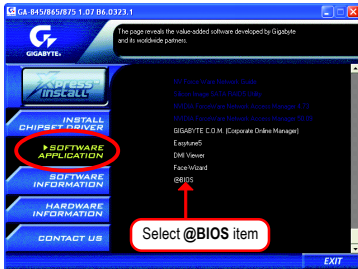

Fig 2. Installation Complete and Run @BIOS

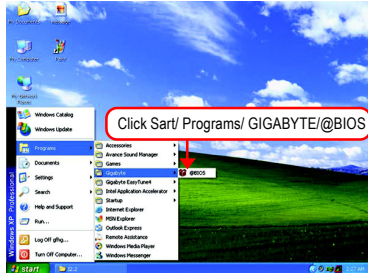

Fig 3. The @BIOS Utility

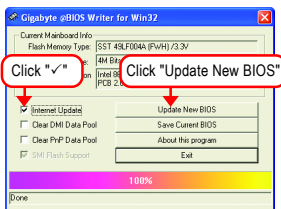
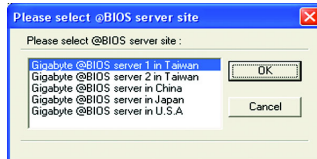

Fig 4. Select the desired @BIOS server



1. Methods and steps:

I. Update BIOS through Internet

- Click "Internet Update" icon
- Click "Update New BIOS" icon
- Select @BIOS™ sever
- Select the exact model name on your motherboard
- System will automatically download and update the BIOS.

II. Update BIOS NOT through Internet:

- Do not click "Internet Update" icon
- Click "Update New BIOS"
- Please select "All Files" in dialog box while opening the old file.
- Please search for BIOS unzip file, downloading from internet or any other methods (such as: GME775P2.FA).
- Complete update process following the instruction.

III. Save BIOS

In the very beginning, there is "Save Current BIOS" icon shown in dialog box. It means to save the current BIOS version.

IV. Check out supported motherboard and Flash ROM:

In the very beginning, there is "About this program" icon shown in dialog box. It can help you check out which kind of motherboard and which brand of Flash ROM are supported.

2. Note:

- I. In method I, if it shows two or more motherboard's model names to be selected, please make sure your motherboard's model name again. Selecting wrong model name will cause the system unbooted.
- II. In method II, be sure that motherboard's model name in BIOS unzip file are the same as your motherboard's. Otherwise, your system won't boot.
- III. In method I, if the BIOS file you need cannot be found in @BIOS™ server, please go onto Gigabyte's web site for downloading and updating it according to method II.
- IV. Please note that any interruption during updating will cause system unbooted.
- V. Do not use @BIOS and C.O.M. (Corporate Online Management) at the same time.

4-1-4 2 / 4 / 6 Channel Audio Function Introduction

2 Channel Audio Setup

We recommend that you use the speaker with amplifier to acquire the best sound effect if the stereo output is applied.

(Following pictures are in Windows XP)

STEP 1:

Connect the stereo speakers or earphone to "Line Out" jack.

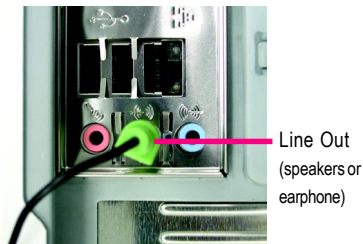

STEP 2:

After installing the audio driver, you'll find a Sound Effect icon on the lower right hand taskbar. Click the icon to select the function.



STEP 3:

On the AC97 Audio Configuration menu, click the **Speaker Configuration** tab and select the **2 channel mode for stereo speaker output** check box.

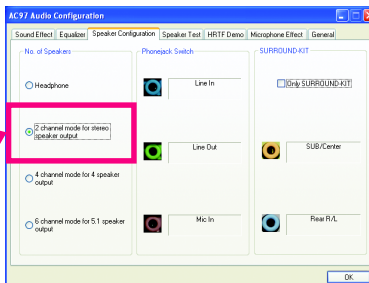
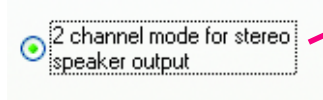

4 Channel Analog Audio Output Mode

STEP 1:

Connect the front channels to "Line Out" jack, the rear channels to "Line In" jack.

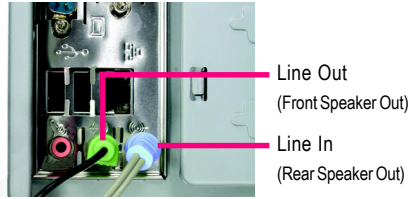

STEP 2:

After installing the audio driver, you'll find a Sound Effect icon on the lower right hand taskbar. Click the icon to select the function.

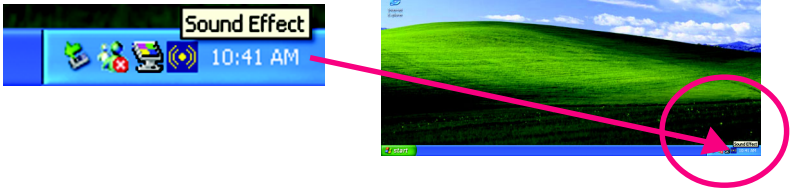

STEP 3:

On the AC97 Audio Configuration menu, click the **Speaker Configuration** tab and select the **4 channel mode for 4 speaker output** check box. Clear the **Only SURROUND-KIT** check box and press **OK**.

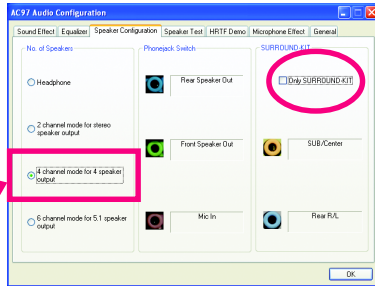
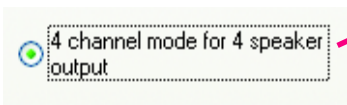

When the **Environment** setting is **None**, the sound would be performed as stereo mode (2-channel output). Please select the other settings (ex: **Living Room**) for 4-channel output.

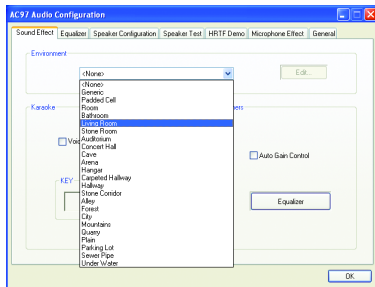

6 Channel Analog Audio Output Mode

STEP 1:

Connect the front channels to "Line Out" jack, the rear channels to "Line In" jack, and the Center/Subwoofer channels to "MIC In" jack.

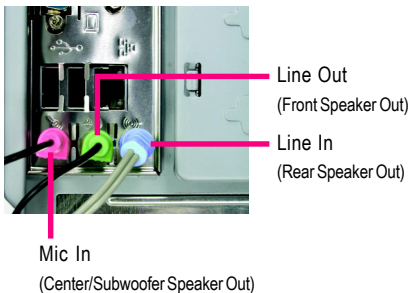

STEP 2:

After installing the audio driver, you'll find a Sound Effect icon on the lower right hand taskbar. Click the icon to select the function.

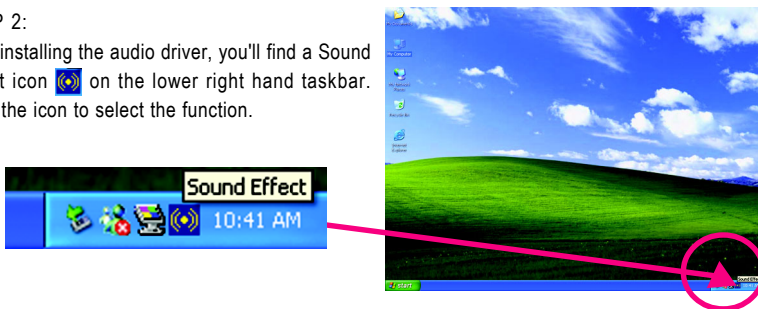

STEP 3:

On the AC97 Audio Configuration menu, click the **Speaker Configuration** tab and select the **6 channel mode for 5.1 speaker output** check box. Clear the **Only SURROUND-KIT** check box and press **OK**.

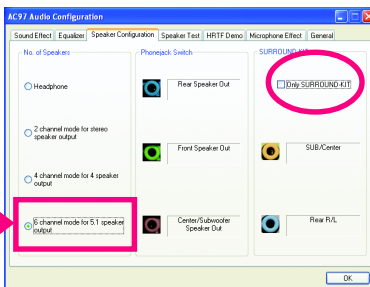
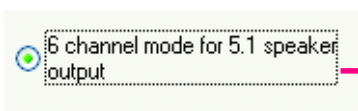

When the **Environment** setting is **None**, the sound would be performed as stereo mode (2-channel output). Please select the other settings (ex: **Living Room**) for 6-channels output.

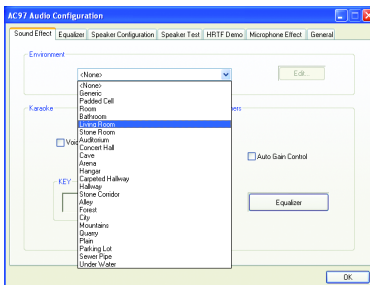

4-2 Troubleshooting

Below is a collection of general asked questions. To check general asked questions based on a specific motherboard model, please log on to <http://www.gigabyte.com.tw>

Question 1: I cannot see some options that were included in previous BIOS after updating BIOS. Why?

Answer: Some advanced options are hidden in new BIOS version. Please press Ctrl and F1 keys after entering BIOS menu and you will be able to see these options.

Questions 2: Why is the light of my keyboard/optical mouse still on after computer shuts down?

Answer: In some boards, a small amount of electricity is kept on standby after computer shuts down and that's why the light is still on.

Question 3: How do I clear CMOS?

Answer: If your board has a Clear CMOS jumper, please refer to the Clear CMOS steps in the manual. If your board doesn't have such jumper, you can take off the on-board battery to leak voltage to clear CMOS. Please refer to the steps below:

Steps:

1. Turn off power.
2. Disconnect the power cord from MB.
3. Take out the battery gently and put it aside for about 1 minute (Or you can use a metal object to connect the positive and negative pins in the battery holder to makethem short for 5 seconds).
4. Re-insert the battery to the battery holder.
5. Connect power cord to MB again and turn on power.
6. Press Del to enter BIOS and load Fail-Safe Defaults(or load Optimized Defaults).
7. Save changes and reboot the system.

Question 4: Why do I still get a weak sound after turning up the speaker to the maximum volume?

Answer: Please make sure the speaker you are using is equipped with an internal amplifier. If not, please change another speaker with power/amplifier and try again later.

Question 5: Sometimes I hear different continuous beeps from computer after system boots up. What do these beeps usually stand for?

Answer: The beep codes below may help you identify the possible computer problems. However, they are only for reference purposes. The situations might differ from case to case.

→ AWARD BIOS Beep Codes

- 1 short: System boots successfully
- 2 short: CMOS setting error
- 1 long 1 short: DRAM or M/B error
- 1 long 2 short: Monitor or display card error
- 1 long 3 short: Keyboard error
- 1 long 9 short: BIOS ROM error
- Continuous long beeps: DRAM error
- Continuous short beeps: Power error



Contact Us

- **Taiwan (Headquarters)**

GIGA-BYTE TECHNOLOGY CO., LTD.

Address: No.6, Bau Chiang Road, Hsin-Tien,

Taipei 231, Taiwan

TEL: +886-2-8912-4888

FAX: +886-2-8912-4003

Tech. and Non-Tech. Support (Sales/Marketing) :

<http://ggts.gigabyte.com.tw>

WEB address (English): <http://www.gigabyte.com.tw>

WEB address (Chinese): <http://www.gigabyte.tw>

- **U.S.A.**

G.B.T. INC.

TEL: +1-626-854-9338

FAX: +1-626-854-9339

Tech. Support:

<http://rma.gigabyte-usa.com>

Web address: <http://www.gigabyte.us>

- **Mexico**

G.B.T Inc (USA)

Tel: +1-626-854-9338 x 215 (Soporte de habla hispano)

FAX: +1-626-854-9339

Correo: soporte@gigabyte-usa.com

Tech. Support:

<http://rma.gigabyte-usa.com>

Web address: <http://www.gigabyte-latam.com>

- **Japan**

NIPPON GIGA-BYTE CORPORATION

WEB address : <http://www.gigabyte.co.jp>

- **Singapore**

GIGA-BYTE SINGAPORE PTE. LTD.

WEB address : <http://www.gigabyte.com.sg>

- **China**

NINGBO G.B.T. TECH. TRADING CO., LTD.

WEB address : <http://www.gigabyte.cn>

- **Shanghai**

TEL: +86-21-63410999

FAX: +86-21-63410100

- **Beijing**

TEL: +86-10-62102838

FAX: +86-10-62102848

- **Wuhan**

TEL: +86-27-87851061

FAX: +86-27-87851330

- **GuangZhou**

TEL: +86-20-87540700

FAX: +86-20-87544306 ext. 333

- **Chengdu**

TEL: +86-28-85236930

FAX: +86-28-85256822 ext. 814

- **Xian**

TEL: +86-29-85531943

FAX: +86-29-85539821

- **Shenyang**

TEL: +86-24-83992901

FAX: +86-24-83992909

- **India**

GIGABYTE TECHNOLOGY (INDIA) LIMITED

WEB address : <http://www.gigabyte.in>

- **Australia**

GIGABYTE TECHNOLOGY PTY. LTD.

WEB address : <http://www.gigabyte.com.au>

- **Germany**

G.B.T. TECHNOLOGY TRADING GMBH

WEB address : <http://www.gigabyte.de>

- **U.K.**

G.B.T. TECH. CO., LTD.

WEB address : <http://www.giga-byte.co.uk>

- **The Netherlands**

GIGA-BYTE TECHNOLOGY B.V.

WEB address : <http://www.giga-byte.nl>

- **France**

GIGABYTE TECHNOLOGY FRANCE

WEB address : <http://www.gigabyte.fr>

- **Italy**

WEB address : <http://www.giga-byte.it>

- **Spain**

GIGA-BYTE SPAIN

WEB address : <http://www.giga-byte.es>

- **Czech Republic**

Representative Office Of GIGA-BYTE Technology Co., Ltd.
in CZECH REPUBLIC

WEB address : <http://www.gigabyte.cz>

- **Turkey**

Representative Office Of GIGA-BYTE Technology Co., Ltd.
in TURKEY

WEB address : <http://www.gigabyte.com.tr>

- **Russia**

Moscow Representative Office Of GIGA-BYTE Technology Co., Ltd.

WEB address : <http://www.gigabyte.ru>

- **Latvia**

GIGA-BYTE Latvia

WEB address : <http://www.gigabyte.com.lv>

- **Poland**

Office of GIGA-BYTE TECHNOLOGY Co., Ltd. in POLAND

WEB address : <http://www.gigabyte.pl>

- **Ukraine**

WEB address : <http://www.gigabyte.kiev.ua>

- **Romania**

Representative Office Of GIGA-BYTE Technology Co., Ltd.
in Romania

WEB address : <http://www.gigabyte.com.ro>

- **Serbia & Montenegro**

Representative Office Of GIGA-BYTE Technology Co., Ltd.
in SERBIA & MONTENEGRO

WEB address : <http://www.gigabyte.co.yu>

- **GIGABYTE Global Service System**



To submit a technical or non-technical (Sales/Marketing) question, please link to :

<http://gts.gigabyte.com.tw>

Then select your language to enter the system.



关于符合中国《电子信息产品污染控制管理办法》的声明
 Management Methods on Control of Pollution from Electronic Information Products
 (China RoHS Declaration)

产品中有毒有害物质或元素的名称及含量
 Hazardous Substances Table

部件名称 (Parts)	有毒有害物质或元素 (Hazardous Substances)					
	铅 (Pb)	汞 (Hg)	镉 (Cd)	六价铬 (Cr (VI))	多溴联苯 (PBB)	多溴二苯醚 (PBDE)
PCB板 PCB	○	○	○	○	○	○
结构件及风扇 Mechanical parts and Fan	×	○	○	○	○	○
芯片及其他出动零件 Chip and other Active components	×	○	○	○	○	○
连接器 Connectors	×	○	○	○	○	○
被动电子元器们 Passive Components	×	○	○	○	○	○
线材 Cables	○	○	○	○	○	○
焊接金属 Soldering metal	○	○	○	○	○	○
助焊剂, 散热膏, 标签及其他耗材 Flux, Solder Paste, Label and other Consumable Materials	○	○	○	○	○	○
○: 表示该有毒有害物质在该部件所有均质材料中的含量均在SJ/T11363-2006标准规定的限量要求以下。 Indicates that this hazardous substance contained in all homogenous materials of this part is below the limit requirement SJ/T 11363-2006						
×: 表示该有毒有害物质至少在该部件的某一均质材料中的含量超出SJ/T11363-2006标准规定的限量要求。 Indicates that this hazardous substance contained in at least one of the homogenous materials of this part is above the limit requirement in SJ/T 11363-2006						
对销售之日的所发售产品, 本表显示我公司供应链的电子信息产品可能包含这些物质。注意: 在所售产品中可能会也可能不会含有所有列出的部件。 This table shows where these substances may be found in the supply chain of our electronic information products, as of the date of the sale of the enclosed products. Note that some of the component types listed above may or may not be a part of the enclosed product.						