



When you installing AGP card, please make sure the following notice is fully understood and practiced. If your AGP card has "AGP 4X notch"(show below), please make sure your AGP card is AGP 4X (1.5V).



Caution: AGP 2X card is not supported by Intel® 845(GE/PE) / 845(E/G) / 850(E). You might experience system unable to boot up normally. Please insert an AGP 4X card.



Example 1: Diamond Vipper V770 golden finger is compatible with 2X/4X mode AGP slot. It can be switched between AGP 2X(3.3V) or 4X(1.5V) mode by adjusting the jumper. The factory default for this card is 2X(3.3V). The GA-8GEM667 Series (or any AGP 4X only) motherboards might not function properly, if you install this card without switching the jumper to 4X(1.5) mode in it.

Example 2: Some ATi Rage 128 Pro graphics cards made by "Power Color", the graphics card manufacturer & some SiS 305 cards, their golden finger is compatible with 2X(3.3V)/4X(1.5V) mode AGP slot, but they support 2X(3.3V) only. The GA-8GEM667 Series (or any AGP 4X only) motherboards might not function properly, If you install this card in it.

Note : Although Gigabyte's AG32S(G) graphics card is based on ATi Rage 128 Pro chip, the design of AG32S(G) is compliance with AGP 4X(1.5V) specification. Therefore, AG32S (G)will work fine with Intel® 845(GE/PE) /845(E/G) / 850(E) based motherboards.



- ☛ The author assumes no responsibility for any errors or omissions that may appear in this document nor does the author make a commitment to update the information contained herein.
- ☛ Third-party brands and names are the property of their respective owners.
- ☛ Please do not remove any labels on motherboard, this may void the warranty of this motherboard.
- ☛ Due to rapid change in technology, some of the specifications might be out of date before publication of this booklet.



WARNING: *Never run the processor without the heatsink properly and firmly attached. PERMANENT DAMAGE WILL RESULT!*

Mise en garde : *Ne faites jamais tourner le processeur sans que le dissipateur de chaleur soit fixé correctement et fermement. UN DOMMAGE PERMANENT EN RÉSULTERA !*

Achtung: *Der Prozessor darf nur in Betrieb genommen werden, wenn der Wärmeleiter ordnungsgemäß und fest angebracht ist. DIES HAT EINEN PERMANENTEN SCHADEN ZUR FOLGE!*

Advertencia: *Nunca haga funcionar el procesador sin el dissipador de calor instalado correcta y firmemente. ¡SE PRODUCIRÁ UN DAÑO PERMANENTE!*

Aviso: *Nunca execute o processador sem o dissipador de calor estar adequado e firmemente conectado. O RESULTADO SERÁ UM DANO PERMANENTE!*

警告: 將散熱板牢固地安裝到處理器上之前，不要運行處理器。過熱將永遠損壞處理器!

警告: 將散熱器牢固地安裝到處理器上之前，不要運行處理器。過熱將永遠損壞處理器!

경고: 히트싱크를 제대로 또 단단히 부착시키지 않은 채 프로세서를 구동시키지 마십시오. 영구적 고장이 발생합니다!

警告: 永久的な損傷を防ぐため、ヒートシンクを正しくしっかりと取り付けるまでは、プロセッサを動作させないようにしてください。

Declaration of Conformity

We, Manufacturer/Importer
(full address)

G.B.T. Technology Trading GmbH
Ausschläger Weg 41, 1F, 20537 Hamburg, Germany

declare that the product
(description of the apparatus, system, installation to which it refers)

Mother Board

GA-8GEM667
is in conformity with

(reference to the specification under which conformity is declared)
in accordance with 89/336 EEC-EMC Directive

<input type="checkbox"/> EN 55011	Limits and methods of measurement of radio disturbance characteristics of industrial, scientific and medical (ISM) high frequency equipment	<input type="checkbox"/> EN 61000-3-2* <input checked="" type="checkbox"/> EN 60555-2	Disturbances in supply systems cause by household appliances and similar electrical equipment "Harmonics"
<input type="checkbox"/> EN 55013	Limits and methods of measurement of radio disturbance characteristics of broadcast receivers and associated equipment	<input type="checkbox"/> EN 61000-3-3* <input checked="" type="checkbox"/> EN 60555-3	Disturbances in supply systems cause by household appliances and similar electrical equipment "Voltage fluctuations"
<input type="checkbox"/> EN 55014	Limits and methods of measurement of radio disturbance characteristics of household electrical appliances, portable tools and similar electrical apparatus	<input checked="" type="checkbox"/> EN 50081-1 <input checked="" type="checkbox"/> EN 50082-1	Generic emission standard Part 1: Residual commercial and light industry Generic immunity standard Part 1: Residual commercial and light industry
<input type="checkbox"/> EN 55015	Limits and methods of measurement of radio disturbance characteristics of fluorescent lamps and luminaries	<input type="checkbox"/> EN 55081-2	Generic emission standard Part 2: Industrial environment
<input type="checkbox"/> EN 55020	Immunity from radio interference of broadcast receivers and associated equipment	<input type="checkbox"/> EN 55082-2	Generic emission standard Part 2: Industrial environment
<input checked="" type="checkbox"/> EN 55022	Limits and methods of measurement of radio disturbance characteristics of information technology equipment	<input type="checkbox"/> ENV 55104	Immunity requirements for household appliances tools and similar apparatus
<input type="checkbox"/> DIN VDE 0855 <input type="checkbox"/> part 10 <input type="checkbox"/> part 12	Cabled distribution systems: Equipment for receiving and/or distribution from sound and television signals	<input type="checkbox"/> EN50091-2	EMC requirements for uninterruptible power systems (UPS)

CE marking



(EC conformity marking)

The manufacturer also declares the conformity of above mentioned product
with the actual required safety standards in accordance with LVD 73/23 EEC

<input type="checkbox"/> EN 60065	Safety requirements for mains operated electronic and related apparatus for household and similar general use	<input type="checkbox"/> EN 60950	Safety for information technology equipment including electrical business equipment
<input type="checkbox"/> EN 60335	Safety of household and similar electrical appliances	<input type="checkbox"/> EN 50091-1	General and Safety requirements for uninterruptible power systems (UPS)

Manufacturer/Importer

(Stamp)

Date : November 15, 2002

Signature:

Name:

Timmy Huang

Timmy Huang

DECLARATION OF CONFORMITY

Per FCC Part 2 Section 2.1077(a)



Responsible Party Name: G.B.T. INC. (U.S.A.)

**Address: 17358 Railroad Street
City of Industry, CA 91748**

Phone/Fax No: (818) 854-9338/ (818) 854-9339

hereby declares that the product

Product Name: Motherboard

Model Number: GA-8GEM667

Conforms to the following specifications:

FCC Part 15, Subpart B, Section 15.107(a) and Section 15.109
(a), Class B Digital Device

Supplementary Information:

This device complies with part 15 of the FCC Rules. Operation is subject to the following two conditions: (1) This device may not cause harmful and (2) this device must accept any interference received, including that may cause undesired operation.

Representative Person's Name: ERIC LU

Signature: *Eric Lu*

Date: November 15, 2002

GA-8GEM667 Series
P4 Titan-DDR Motherboard

USER'S MANUAL

Pentium®4 Processor Motherboard

Rev. 1001

12ME-8GEM667-1001

Table of Content

Item Checklist	4
WARNING!	4
Chapter 1 Introduction	5
Features Summary	5
GA-8GEM667 Series Motherboard Layout	7
Chapter 2 Hardware Installation Process	9
Step 1: Install the Central Processing Unit (CPU)	10
Step1-1 : CPU Installation	10
Step1-2 : CPU Heat Sink Installation	11
Step 2: Install memory modules	12
Step 3: Install expansion cards	13
Step 4: Connect ribbon cables, cabinet wires, and power supply	14
Step 4-1: I/O Back Panel Introduction	14
Step 4-2 : Connectors Introduction	16
Chapter 3 BIOS Setup	23
The Main Menu (For example: BIOS Ver. : E2)	24
Standard CMOS Features	26
Advanced BIOS Features	29
Integrated Peripherals	31
Power Management Setup	35
PnP/PCI Configurations	37
PC Health Status	38
Frequency/Voltage Control	40

Top Performance	42
Load Fail-Safe Defaults	43
Load Optimized Defaults	44
Set Supervisor/User Password	45
Save & Exit Setup	46
Exit Without Saving	47
Block Diagram	49
Chapter 4 Technical Reference	49
Q-Flash Introduction	61
@ BIOS Introduction	65
Easy Tune™ 4 Introduction	66
2-/4-/6-Channel Audio Function Introduction	67
Chapter 5 Appendix	75

Item Checklist

- | | |
|---|---|
| <input checked="" type="checkbox"/> The GA-8GEM667 motherboard | <input type="checkbox"/> 2 Port USB Cable x 1 |
| <input checked="" type="checkbox"/> IDE cable x 1/ Floppy cable x 1 | <input type="checkbox"/> 4 Port USB Cable x 1 |
| <input checked="" type="checkbox"/> CD for motherboard driver & utility | <input type="checkbox"/> SPDIF-KIT x 1 (SPD-KIT) |
| <input checked="" type="checkbox"/> GA-8GEM667 series user's manual | <input type="checkbox"/> IEEE 1394 Cable x1 |
| <input checked="" type="checkbox"/> I/O Shield (*) | <input type="checkbox"/> Audio Combo Kit x 1 |
| <input type="checkbox"/> Quick PC Installation Guide | <input type="checkbox"/> Motherboard Settings Label |
| <input type="checkbox"/> RAID Manual | |



WARNING!

Computer motherboards and expansion cards contain very delicate Integrated Circuit (IC) chips. To protect them against damage from static electricity, you should follow some precautions whenever you work on your computer.

1. Unplug your computer when working on the inside.
2. Use a grounded wrist strap before handling computer components. If you do not have one, touch both of your hands to a safely grounded object or to a metal object, such as the power supply case.
3. Hold components by the edges and try not touch the IC chips, leads or connectors, or other components.
4. Place components on a grounded antistatic pad or on the bag that came with the components whenever the components are separated from the system.
5. Ensure that the ATX power supply is switched off before you plug in or remove the ATX power connector on the motherboard.

Installing the motherboard to the chassis...

If the motherboard has mounting holes, but they don't line up with the holes on the base and there are no slots to attach the spacers, do not become alarmed you can still attach the spacers to the mounting holes. Just cut the bottom portion of the spacers (the spacer may be a little hard to cut off, so be careful of your hands). In this way you can still attach the motherboard to the base without worrying about short circuits. Sometimes you may need to use the plastic springs to isolate the screw from the motherboard PCB surface, because the circuit wire may be near by the hole. Be careful, don't let the screw contact any printed circuit write or parts on the PCB that are near the fixing hole, otherwise it may damage the board or cause board malfunctioning.

" * " Only for GA-8GEM667.

Chapter 1 Introduction

Features Summary

Form Factor	<ul style="list-style-type: none"> • 24.4cm x 22cm Micro-ATX size form factor, 4 layers PCB.
Motherboard	<ul style="list-style-type: none"> • GA-8GEM667 Series Motherboard: GA-8GEM667 and GA-8GEM667-C
CPU	<ul style="list-style-type: none"> • Socket 478 for Intel® Micro FC-PGA2 Pentium® 4 processor • Support Intel® Pentium® 4 (Northwood, 0.13µm) processor • Support Intel® Pentium® 4 Processor with HT Technology • Intel Pentium®4 400/533MHz FSB • 2nd cache depends on CPU
Chipset	<ul style="list-style-type: none"> • Chipset Intel 845GE HOST/AGP/Controller • ICH4 I/O Controller Hub
Memory	<ul style="list-style-type: none"> • 2 184-pin DDR DIMM sockets • Supports DDR333/DDR266 DIMM • Supports up to 2GB DRAM (Max) • Supports only 2.5V DDR DIMM
I/O Control	<ul style="list-style-type: none"> • IT8712
Slots	<ul style="list-style-type: none"> • 1 AGP slot 4X (1.5V) device support • 3 PCI slot supports 33MHz & PCI 2.2 compliant
On-Board IDE	<ul style="list-style-type: none"> • 2 IDE bus master (UDMA33/ATA66/ATA100) IDE ports for up to 4 ATAPI devices • Supports PIO mode3,4 (UDMA 33/ATA66/ATA100) IDE & ATAPI CD-ROM
On-Board Peripherals	<ul style="list-style-type: none"> • 1 Floppy port supports 2 FDD with 360K, 720K, 1.2M, 1.44M and 2.88M bytes. • 1 Parallel port supports Normal/EPP/ECP mode • 2 Serial ports (COMA&COMB);1 VGA Port • 6 USB 2.0/1.1 ports (2 x Rear, 4 xFront by cable) • 1 Front Audio Connector • 1 IrDA connector for IR/CIR • 1 MODEN connector (*) • 1 Front Audio connector

● Due to (Intel 845PE/GE/GV) chipset architecture limitation, DDR 333 memory module is only supported when using FSB 533 Pentium 4 processor. A FSB 400 Pentium 4 processor will only support DDR 266 memory module to be continued.....

“ * ” Only for GA-8GEM667.

Hardware Monitor	<ul style="list-style-type: none"> • CPU/System Fan Revolution detect • CPU/System Fan Fail Warning • CPU Overheat Warning • System Voltage Detect
On-Board VGA	<ul style="list-style-type: none"> • Built in Intel 845GE Chipset
On-Board Sound	<ul style="list-style-type: none"> • Realtek ALC650 CODEC • Line Out / 2 front speaker • Line In / 2 rear speaker(by s/w switch) • Mic In / center& subwoofer(by s/w switch) • SPDIF out • 1 Buzzer • CD In / AUX In / Game port
On-Board LAN *	<ul style="list-style-type: none"> • Built in RTL8101L Chipset • 1 RJ 45 port
PS/2 Connector	<ul style="list-style-type: none"> • PS/2 Keyboard interface and PS/2 Mouse interface
BIOS	<ul style="list-style-type: none"> • Licensed AWARD BIOS, 2M bit Flash ROM • Supports Q-Flash
Additional Features	<ul style="list-style-type: none"> • PS/2 Keyboard power on by password • PS/2 Mouse power on • External Modem wake up • STR(Suspend-To-RAM) • Wake on LAN (WOL) • AC Recovery • Poly fuse for keyboard over-current protection • USB KB/Mouse wake up from S3 • Supports @BIOS • Supports EasyTune 4
Overclocking	<ul style="list-style-type: none"> • Over Clock (DDR/AGP/CPU) by BIOS



Please set the CPU host frequency in accordance with your processor's specifications. We don't recommend you to set the system bus frequency over the CPU's specification because these specific bus frequencies are not the standard specifications for CPU, chipset and most of the peripherals. Whether your system can run under these specific bus frequencies properly will depend on your hardware configurations, including CPU, Chipsets, SDRAM, Cards....etc.

“ * ” Only for GA-8GEM667.

HT functionality requirement content

"Enabling the functionality of Hyper-Threading Technology for your computer system requires all of the following platform components:

- CPU: An Intel® Pentium 4 Processor with HT Technology
- Chipset: An Intel® Chipset that supports HT Technology
- BIOS: A BIOS that supports HT Technology and has it enabled
- OS: An operation system that has optimizations for HT Technology

GA-8GEM667 Series Motherboard Layout

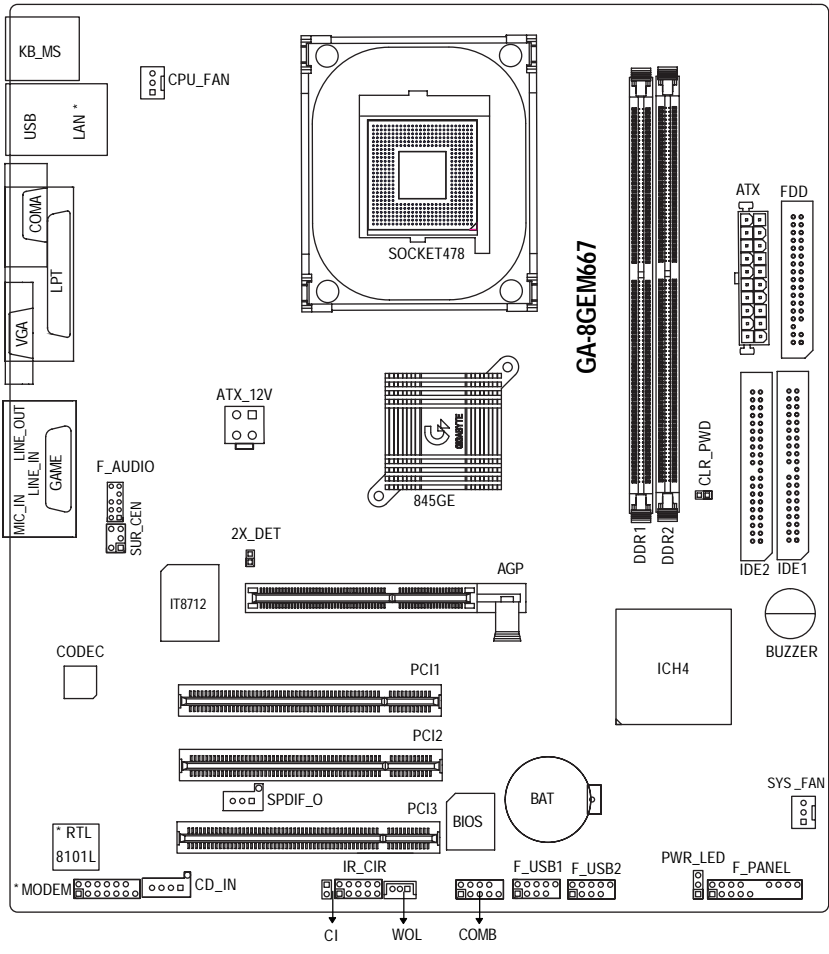

“ * ” Only for GA-8GEM667.

Chapter 2 Hardware Installation Process

To set up your computer, you must complete the following steps:

- Step 1- Install the Central Processing Unit (CPU)
- Step 2- Install memory modules
- Step 3- Install expansion cards
- Step 4- Connect ribbon cables, cabinet wires, and power supply
- Step 5- Setup BIOS software
- Step 6- Install supporting software tools

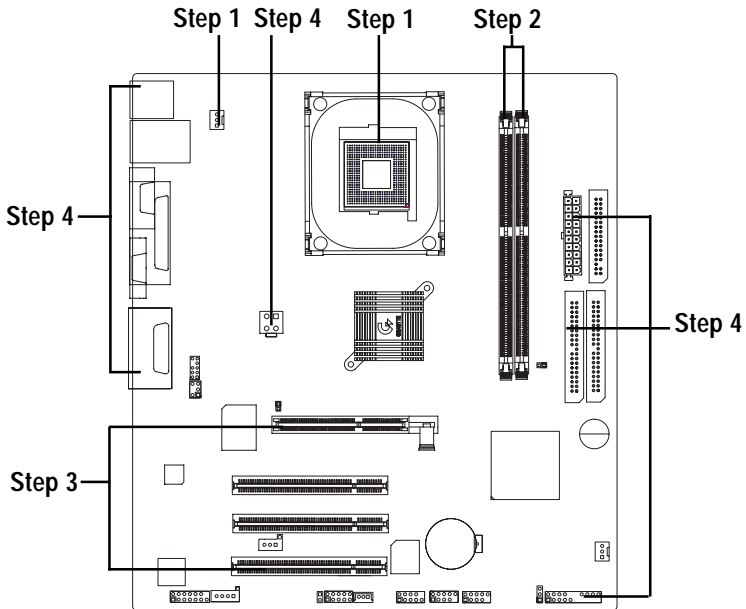

Step 1: Install the Central Processing Unit (CPU)

Step1-1 : CPU Installation

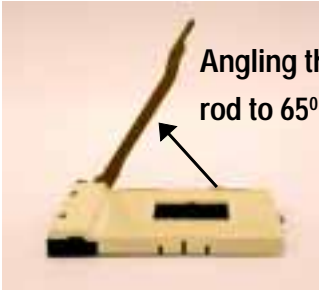

1. Angling the rod to 65-degree may feel a kind of tight, and then continue pull the rod to 90-degree when a noise "cough" made.

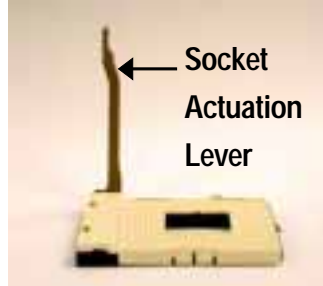

2. Pull the rod to the 90-degree directly.



3. CPU Top View

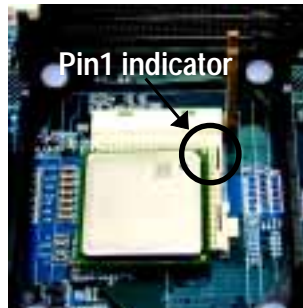

4. Locate Pin 1 in the socket and look for a (golden) cut edge on the CPU upper corner. Then insert the CPU into the socket.

- ⚠ Please make sure the CPU type is supported by the motherboard.
- ⚠ If you do not match the CPU socket Pin 1 and CPU cut edge well, it will cause improper installation. Please change the insert orientation.

Step1-2 : CPU Heat Sink Installation



1. Hook one end of the cooler bracket to the CPU socket first.



2. Hook the other end of the cooler bracket to the CPU socket.

- * Please use Intel approved cooling fan.
- * We recommend you to apply the thermal tape to provide better heat conduction between your CPU and heatsink.
(The CPU cooling fan might stick to the CPU due to the hardening of the thermal paste. During this condition if you try to remove the cooling fan, you might pull the processor out of the CPU socket along with the cooling fan, and might damage the processor. To avoid this from happening, we suggest you to either use thermal tape instead of thermal paste, or remove the cooling fan with extreme caution.)
- * Make sure the CPU fan power cable is plugged in to the CPU fan connector, this completes the installation.
- * Please refer to CPU heat sink user's manual for more detail installation procedure.

Step 2: Install memory modules

The motherboard has 2 dual inline memory module (DIMM) sockets. The BIOS will automatically detects memory type and size. To install the memory module, just push it vertically into the DIMM socket .The DIMM module can only fit in one direction due to the notch. Memory size can vary between sockets.

Total Memory Sizes With Unbuffered DDR DIMM

Devices used on DIMM	1 DIMM x 64 / x 72	2 DIMMs x 64 / x 72
64 Mbit (2Mx8x4 banks)	128 MBytes	256 MBytes
64 Mbit (1Mx16x4 banks)	32 MBytes	64 MBytes
128 Mbit(4Mx8x4 banks)	256 MBytes	512 MBytes
128 Mbit(2Mx16x4 banks)	64 MBytes	128 MBytes
256 Mbit(8Mx8x4 banks)	512 MBytes	1 GBytes
256 Mbit(4Mx16x4 banks)	128 MBytes	256 MBytes
512 Mbit(16Mx8x4 banks)	1 GBytes	2 GBytes
512 Mbit(8Mx16x4 banks)	256 MBytes	512 MBytes

DDR1	DDR2
S	S
D	S
D	D
D	X
S	D
S	X

D:Double Sided DIMM S:Single Sided DIMM
X:Not Use



DDR

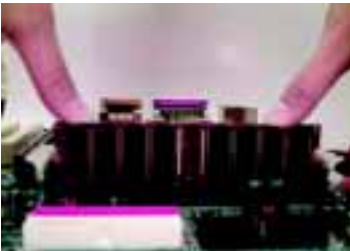

1. The DIMM socket has a notch, so the DIMM memory module can only fit in one direction.
 2. Insert the DIMM memory module vertically into the DIMM socket. Then push it down.
 3. Close the plastic clip at both edges of the DIMM sockets to lock the DIMM module.
- Reverse the installation steps when you wish to remove the DIMM module.



- ⚠ When STR/DIMM LED is ON, do not install/remove DIMM from socket.
- ⚠ Please note that the DIMM module can only fit in one direction due to the two notches. Wrong orientation will cause improper installation. Please change the insert orientation.

DDR Introduction

Established on the existing SDRAM industry infrastructure, DDR (Double Data Rate) memory is a high performance and cost-effective solution that allows easy adoption for memory vendors, OEMs and system integrators.

DDR memory is a sensible evolutionary solution for the PC industry that builds on the existing SDRAM infrastructure, yet makes awesome advances in solving the system performance bottleneck by doubling the memory bandwidth. DDR SDRAM will offer a superior solution and migration path from existing SDRAM designs due to its availability, pricing and overall market support. PC2100 DDR memory (DDR266) doubles the data rate through reading and writing at both the rising and falling edge of the clock, achieving data bandwidth 2X greater than PC133 when running with the same DRAM clock frequency. With peak bandwidth of 2.664GB per second, DDR memory enables system OEMs to build high performance and low latency DRAM subsystems that are suitable for servers, workstations, high-end PC's and value desktop SMA systems. With a core voltage of only 2.5 Volts compared to conventional SDRAM's 3.3 volts, DDR memory is a compelling solution for small form factor desktops and notebook applications.

Step 3: Install expansion cards

1. Read the related expansion card's instruction document before install the expansion card into the computer.
2. Remove your computer's chassis cover, necessary screws and slot bracket from the computer.
3. Press the expansion card firmly into expansion slot in motherboard.
4. Be sure the metal contacts on the card are indeed seated in the slot.
5. Replace the screw to secure the slot bracket of the expansion card.
6. Replace your computer's chassis cover.
7. Power on the computer, if necessary, setup BIOS utility of expansion card from BIOS.
8. Install related driver from the operating system.



AGP Card

Please carefully pull out the small white-drawable bar at the end of the AGP slot when you try to install/ Uninstall the AGP card. Please align the AGP card to the onboard AGP slot and press firmly down on the slot. Make sure your AGP card is locked by the small white- drawable bar.



When an AGP 2X (3.3V) card is installed the 2X_DET will light up, indicating a non-supported graphics card is inserted. Informing users that system might not boot up normally due to AGP 2X (3.3V) is not supported by the chipset.

Step 4: Connect ribbon cables, cabinet wires, and power supply

Step 4-1: I/O Back Panel Introduction

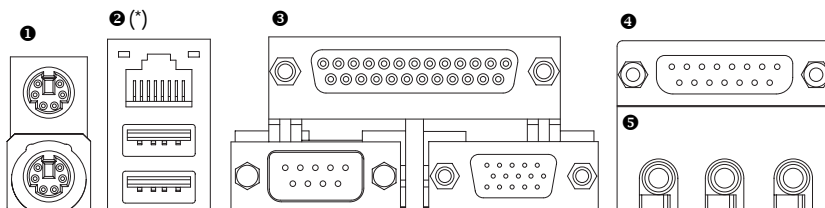

❶ PS/2 Keyboard and PS/2 Mouse Connector

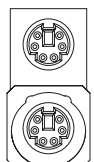

PS/2 Mouse Connector
(6 pin Female)

∅ This connector supports standard PS/2 keyboard and PS/2 mouse.

PS/2 Keyboard Connector
(6 pin Female)

❷ USB Connector

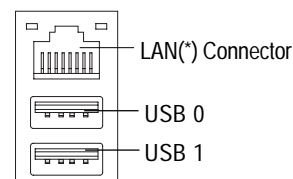

∅ Before you connect your device(s) into USB connector(s), please make sure your device(s) such as USB keyboard, mouse, scanner, zip, speaker...etc. Have a standard USB interface. Also make sure your OS supports USB controller. If your OS does not support USB controller, please contact OS vendor for possible patch or driver upgrade. For more information please contact your OS or device(s) vendors.

“ * ” Only for GA-8GEM667.

3 Parallel Port and VGA Port / COMA Port

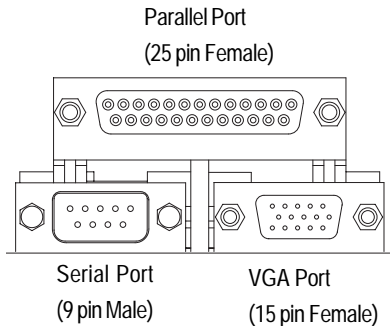

∅ This mainboard supports 1 standard COM port, 1 VGA port and 1 LPT port. Device like printer can be connected to LPT port ; mouse and modem etc can be connected to COM port.

4 Game /MIDI Ports

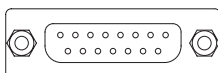

Joystick/ MIDI (15 pin Female)

∅ This connector supports joystick, MIDI keyboard and other relate audio devices.

5 Audio Connectors

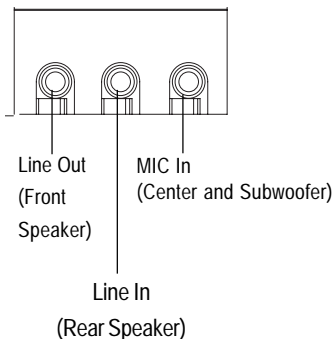

∅ After install onboard audio driver, you may connect speaker to Line Out jack, micro phone to MIC In jack.

Device like CD-ROM , walkman etc can be connected to Line-In jack.

Please note:

You are able to use 2-/4-/6- channel audio feature by S/W selection.

If you want to enable 6-channel function, you have 2 choose for hardware connection.

Method1:

Connect "Front Speaker" to "Line Out"

Connect "Rear Speaker" to "Line In"

Connect "Center and Subwooferr" to "MIC Out ".

Method2:

You can refer to page 18, and contact your nearest dealer for optional SUR_CEN cable.



If you want the detail information for 2-/4-/6-channel audio setup installation, please refer to page 67.

Step 4-2 : Connectors Introduction

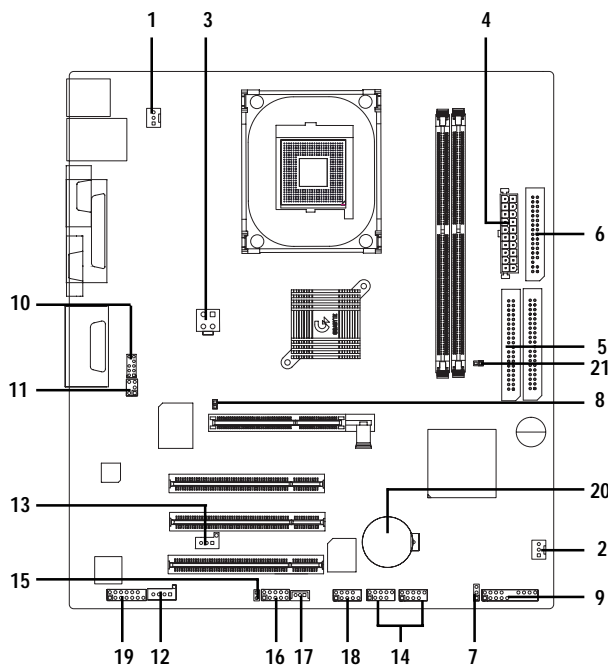

1) CPU_FAN	13) SPDIF_O
2) SYS_FAN	14) F_USB1/F_USB2
3) ATX_12V	15) CI
4) ATX	16) IR_CIR
5) IDE1/IDE2	17) WOL
6) FDD	18) COM B
7) PWR_LED	19) MODEM (*)
8) 2X_DET	20) BAT
9) F_PANEL	21) CLR_PWD
10) F_AUDIO	
11) SUR_CEN	
12) CD_IN	

“ * ” Only for GA-8GEM667.

1) CPU_FAN (CPU FAN Connector)

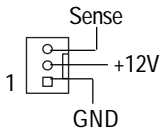

➤ Please note, a proper installation of the CPU cooler is essential to prevent the CPU from running under abnormal condition or damaged by overheating. The CPU fan connector supports Max. current up to 600 mA.

2) SYS_FAN (System FAN Connector)

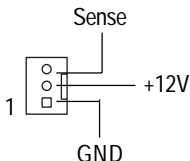

➤ This connector allows you to link with the cooling fan on the system case to lower the system temperature.

3) ATX_12V (+12V Power Connector)

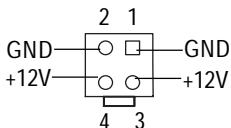

∅ This connector (ATX_12V) supplies the CPU operation voltage (Vcore).
If this "ATX_12V connector" is not connected, system cannot boot.

4) ATX (ATX Power)

∅ AC power cord should only be connected to your power supply unit after ATX power cable and other related devices are firmly connected to the mainboard.

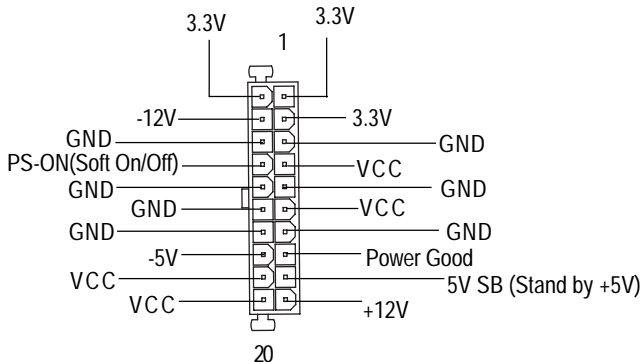

5) IDE1/ IDE2 [IDE1 / IDE2 Connector(Primary/Secondary)]

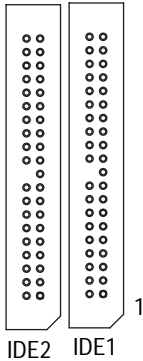

∅ Important Notice:

Please connect first harddisk to IDE1 and connect CDROM to IDE2.

The red stripe of the ribbon cable must be the same side with the Pin1.

6) FDD (Floppy Connector)

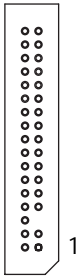

∅ Please connect the floppy drive ribbon cables to FDD. It supports 360K, 1.2M, 720K, 1.44M and 2.88M bytes floppy disk types.

The red stripe of the ribbon cable must be the same side with the Pin1.

7) PWR_LED



∅ PWR_LED is connect with the system power indicator to indicate whether the system is on/off. It will blink when the system enters suspend mode.

If you use dual color LED, power LED will turn to another color.

8) 2X_DET



∅ When an AGP 2X (3.3V) card is installed the 2X_DET will light up, indicating a non-supported graphics card is inserted. Informing users that system might not boot up normally due to AGP 2X (3.3V) is not supported by the chipset.

9) F_PANEL (2x10 pins connector)

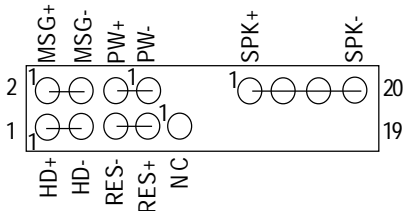

HD (IDE Hard Disk Active LED) (Blue)	Pin 1: LED anode(+) Pin 2: LED cathode(-)
SPK (Speaker Connector) (Amber)	Pin 1: VCC(+) Pin 2- Pin 3: NC Pin 4: Data(-)
RES (Reset Switch) (Green)	Open: Normal Operation Close: Reset Hardware System
PW (Soft Power Connector) (Red)	Open: Normal Operation Close: Power On/Off
MSG(Message LED/Power/ Sleep LED)(Yellow)	Pin 1: LED anode(+) Pin 2: LED cathode(-)
NC(Purple)	NC

∅ Please connect the power LED, PC speaker, reset switch and power switch etc of your chassis front panel to the F_PANEL connector according to the pin assignment above.

10) F_AUDIO (Front Audio Connector)

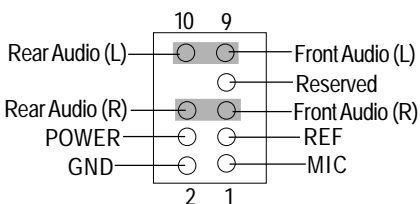

∅ If you want to use "Front Audio" connector, you must remove 5-6, 9-10 Jumper. In order to utilize the front audio header, your chassis must have front audio connector. Also please make sure the pin assignment on the cable is the same as the pin assignment on the MB header. To find out if the chassis you are buying support front audio connector, please contact your dealer.

11) SUR_CEN

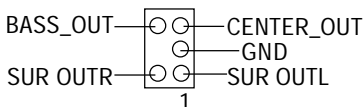

∅ Please contact your nearest dealer for optional SUR_CEN cable.

12) CD_IN (CD Audio Line In)

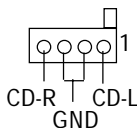

- ∅ Connect CD-ROM or DVD-ROM audio out to the connector.

13) SPDIF_O

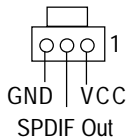

- ∅ The SPDIF output is capable of providing digital audio to external speakers or compressed AC3 data to an external Dolby Digital Decoder. Use this feature only when your stereo system has digital input function.

14) F_USB1/F_USB2 (F_USB1 ~ F_USB2 connector in yellow are for USB 2.0)

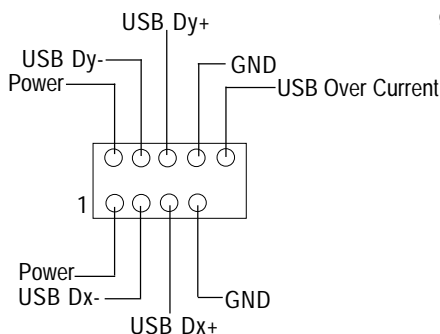

- ∅ Be careful with the polarity of the front USB connector. Check the pin assignment while you connect the front USB cable. Please contact your nearest dealer for optional front USB cable.

15) CI (CASE OPEN)

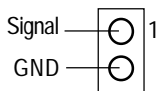

- ∅ This 2 pin connector allows your system to enable or disable the "Case Open" item in BIOS if the system case begin remove.

16) IR_CIR

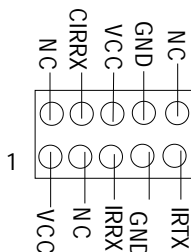

- ∅ Make sure the pin 1 on the IR device is aligning with pin one the connector. To enable the IR/CIR function on the board, you are required to purchase an option IR/CIR module. For detail information please contact your authorized Giga-Byte distributor. To use IR function only, please connect IR module to Pin1 to Pin5.

17) WOL (Wake On Lan)

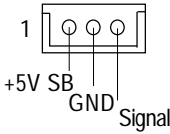

- ∅ This connector allows the remote servers to manage the system that installed this mainboard via your network adapter which also supports WOL.

18) COM B (White connector)

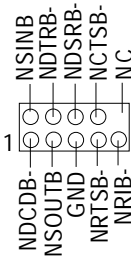

- ∅ Be careful with the polarity of the COMB connector. Check the pin assignment while you connect the COMB cable. Please contact your nearest dealer for optional COMB cable.

19) Modem (*)

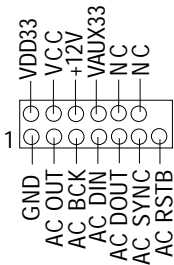

- ∅ Please contact your nearest dealer for optional Modem cable.

20) BAT (Battery)

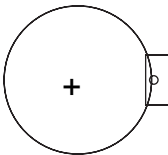

CAUTION

- ∇ Danger of explosion if battery is incorrectly replaced.
- ∇ Replace only with the same or equivalent type recommended by the manufacturer.
- ∇ Dispose of used batteries according to the manufacturer's instructions.

“ * ” Only for GA-8GEM667.

21) CLR_PWD

1  Close: Normal

1  Open: Clear Password

Ø When Jumper set to "open", the password that set will be cleared. On the contrary when Jumper set to "close", the current status remains.

M PS, the function offers a solution for users who forget the password.

Chapter 3 BIOS Setup

BIOS Setup is an overview of the BIOS Setup Program. The program that allows users to modify the basic system configuration. This type of information is stored in battery-backed CMOS RAM so that it retains the Setup information when the power is turned off.

ENTERING SETUP

Powering ON the computer and pressing immediately will allow you to enter Setup. If you require more advanced BIOS settings, please go to "Advanced BIOS" setting menu. To enter Advanced BIOS setting menu, press "Ctrl+F1" key on the BIOS screen.

CONTROL KEYS

<↑>	Move to previous item
<↓>	Move to next item
<←>	Move to the item in the left hand
<→>	Move to the item in the right hand
Enter	Select item
<Esc>	Main Menu - Quit and not save changes into CMOS Status Page Setup Menu and Option Page Setup Menu - Exit current page and return to Main Menu
<+/PgUp>	Increase the numeric value or make changes
<-/PgDn>	Decrease the numeric value or make changes
<F1>	General help, only for Status Page Setup Menu and Option Page Setup Menu
<F2>	Item Help
<F3>	Reserved
<F4>	Reserved
<F5>	Restore the previous CMOS value from CMOS, only for Option Page Setup Menu
<F6>	Load the file-safe default CMOS value from BIOS default table
<F7>	Load the Optimized Defaults
<F8>	Q-Flash function
<F9>	Reserved
<F10>	Save all the CMOS changes, only for Main Menu

GETTING HELP

Main Menu

The on-line description of the highlighted setup function is displayed at the bottom of the screen.

Status Page Setup Menu / Option Page Setup Menu

Press F1 to pop up a small help window that describes the appropriate keys to use and the possible selections for the highlighted item. To exit the Help Window press <Esc>.

The Main Menu (For example: BIOS Ver. : E2)

Once you enter Award BIOS CMOS Setup Utility, the Main Menu (Figure 1) will appear on the screen. The Main Menu allows you to select from eight setup functions and two exit choices. Use arrow keys to select among the items and press <Enter> to accept or enter the sub-menu.

CMOS Setup Utility-Copyright (C) 1984-2002 Award Software

▶Standard CMOS Features	Top Performance
▶Advanced BIOS Features	Load Fail-Safe Defaults
▶Integrated Peripherals	Load Optimized Defaults
▶Power Management Setup	Set Supervisor Password
▶PnP/PCI Configurations	Set User Password
▶PC Health Status	Save & Exit Setup
▶Frequency/Voltage Control	Exit Without Saving
ESC:Quit	↑↓→←:Select Item
F8: Q-Flash	F10:Save & Exit Setup
Time, Date, Hard Disk Type...	

Figure 1: Main Menu



If you can't find the setting you want, please press "Ctrl+F1" to search the advanced option widden.

- **Standard CMOS Features**

This setup page includes all the items in standard compatible BIOS.

- **Advanced BIOS Features**

This setup page includes all the items of Award special enhanced features.

- **Integrated Peripherals**
This setup page includes all onboard peripherals.
- **Power Management Setup**
This setup page includes all the items of Green function features.
- **PnP/PCI Configurations**
This setup page includes all the configurations of PCI & PnP ISA resources.
- **PC Health Status**
This setup page is the System auto detect Temperature, voltage, fan, speed.
- **Frequency/Voltage Control**
This setup page is control CPU's clock and frequency ratio.
- **Top Performance**
If you wish to maximize the performance of your system, set "Top Performance" as "Enabled".
- **Load Fail-Safe Defaults**
Fail-Safe Defaults indicates the value of the system parameters which the system would be in safe configuration.
- **Load Optimized Defaults**
Optimized Defaults indicates the value of the system parameters which the system would be in best performance configuration.
- **Set Supervisor password**
Change, set, or disable password. It allows you to limit access to the system and Setup, or just to Setup.
- **Set User password**
Change, set, or disable password. It allows you to limit access to the system.
- **Save & Exit Setup**
Save CMOS value settings to CMOS and exit setup.
- **Exit Without Saving**
Abandon all CMOS value changes and exit setup.

Standard CMOS Features

CMOS Setup Utility-Copyright (C) 1984-2002 Award Software

Standard CMOS Features

Date (mm:dd:yy)	Fri, May 3 2002	Item Help
Time (hh:mm:ss)	17:56:23	Menu Level ►
►IDE Primary Master	None	Change the day, month, year
►IDE Primary Slave	None	
►IDE Secondary Master	None	<Week>
►IDE Secondary Slave	None	Sun. to Sat.
Drive A	1.44M, 3.5 in.	<Month>
Drive B	None	Jan. to Dec.
Floppy 3 Mode Support	Disabled	
Halt On	All, But Keyboard	<Day>
		1 to 31 (or maximum allowed in the month)
Base Memory	640K	
Extended Memory	130048K	<Year>
Total Memory	131072K	1999 to 2098
↑↓→←: Move Enter:Select +/-/PU/PD:Value F10:Save ESC:Exit F1:General Help F5:Previous Values F6:Fail-Safe Defaults F7:Optimized Defaults		

Figure 2: Standard CMOS Features

☞ Date

The date format is <week>, <month>, <day>, <year>.

- Week The week, from Sun to Sat, determined by the BIOS and is display only
- Month The month, Jan. Through Dec.
- Day The day, from 1 to 31 (or the maximum allowed in the month)
- Year The year, from 1999 through 2098

☞ Time

The times format in <hour> <minute> <second>. The time is calculated base on the 24-hour military-time clock. For example, 1 p.m. is 13:00:00.

☞ IDE Primary Master, Slave / IDE Secondary Master, Slave

The category identifies the types of hard disk from drive C to F that has been installed in the computer. There are two types: auto type, and manual type. Manual type is user-definable; Auto type which will automatically detect HDD type.

Note that the specifications of your drive must match with the drive table. The hard disk will not work properly if you enter improper information for this category.

If you select User Type, related information will be asked to enter to the following items. Enter the information directly from the keyboard and press <Enter>. Such information should be provided in the documentation form your hard disk vendor or the system manufacturer.

- ▶▶ CYLS. Number of cylinders
- ▶▶ HEADS Number of heads
- ▶▶ PRECOMP Write precomp
- ▶▶ LANDZONE Landing zone
- ▶▶ SECTORS Number of sectors

If a hard disk has not been installed select NONE and press <Enter>.

☞ Drive A / Drive B

The category identifies the types of floppy disk drive A or drive B that has been installed in the computer.

- ▶▶ None No floppy drive installed
- ▶▶ 360K, 5.25 in. 5.25 inch PC-type standard drive; 360K byte capacity.
- ▶▶ 1.2M, 5.25 in. 5.25 inch AT-type high-density drive; 1.2M byte capacity
(3.5 inch when 3 Mode is Enabled).
- ▶▶ 720K, 3.5 in. 3.5 inch double-sided drive; 720K byte capacity
- ▶▶ 1.44M, 3.5 in. 3.5 inch double-sided drive; 1.44M byte capacity.
- ▶▶ 2.88M, 3.5 in. 3.5 inch double-sided drive; 2.88M byte capacity.

☞ Floppy 3 Mode Support (for Japan Area)

- ▶▶ Disabled Normal Floppy Drive. (Default value)
- ▶▶ Drive A Drive A is 3 mode Floppy Drive.
- ▶▶ Drive B Drive B is 3 mode Floppy Drive.
- ▶▶ Both Drive A & B are 3 mode Floppy Drives.

☞ Halt on

The category determines whether the computer will stop if an error is detected during power up.

- ▶▶ NO Errors The system boot will not stop for any error that may be detected and you will be prompted.
- ▶▶ All Errors Whenever the BIOS detects a non-fatal error the system will be stopped.
- ▶▶ All, But Keyboard The system boot will not stop for a keyboard error; it will stop for all other errors. (Default value)
- ▶▶ All, But Diskette The system boot will not stop for a disk error; it will stop for all other errors.
- ▶▶ All, But Disk/Key The system boot will not stop for a keyboard or disk error; it will stop for all other errors.

☞ Memory

The category is display-only which is determined by POST (Power On Self Test) of the BIOS.

Base Memory

The POST of the BIOS will determine the amount of base (or conventional) memory installed in the system.

The value of the base memory is typically 512 K for systems with 512 K memory installed on the motherboard, or 640 K for systems with 640 K or more memory installed on the motherboard.

Extended Memory

The BIOS determines how much extended memory is present during the POST.

This is the amount of memory located above 1 MB in the CPU's memory address map.

Advanced BIOS Features

CMOS Setup Utility-Copyright (C) 1984-2002 Award Software

Advanced BIOS Features

First Boot Device	[Floppy]	Item Help
Second Boot Device	[HDD-0]	Menu Level ►
Third Boot Device	[CDROM]	Select Boot Device
Boot Up Floppy Seek	[Disabled]	
Password Check	[Setup]	priority
# CPU Hyper-Threading	Enabled	[Floppy]
Init Display First	[Onboard/AGP]	Boot from floppy [LS120]
		Boot from LS120 [HDD-0]
		Boot from First HDD [HDD-1]
		Boot from second HDD
↑↓→←: Move Enter:Select +/-/PU/PD:Value F10:Save ESC:Exit F1:General Help F5:Previous Values F6:Fail-Safe Defaults F7:Optimized Defaults		

Figure 3: Advanced BIOS Features

“ # ” System will detect automatically and show up when you install the Intel® Pentium® 4 processor with HT Technology.

☞ First / Second / Third Boot Device

- ▶▶ Floppy Select your boot device priority by Floppy.
- ▶▶ LS120 Select your boot device priority by LS120.
- ▶▶ HDD-0-3 Select your boot device priority by HDD-0-3.
- ▶▶ SCSI Select your boot device priority by SCSI.
- ▶▶ CDROM Select your boot device priority by CDROM.
- ▶▶ ZIP Select your boot device priority by ZIP.
- ▶▶ USB-FDD Select your boot device priority by USB-FDD.
- ▶▶ USB-ZIP Select your boot device priority by USB-ZIP.
- ▶▶ USB-CDROM Select your boot device priority by USB-CDROM.
- ▶▶ USB-HDD Select your boot device priority by USB-HDD.
- ▶▶ LAN Select your boot device priority by LAN.
- ▶▶ Disabled Select your boot device priority by Disabled.

☞ **Boot Up Floppy Seek**

During POST, BIOS will determine the floppy disk drive installed is 40 or 80 tracks. 360 K type is 40 tracks 720 K, 1.2 M and 1.44 M are all 80 tracks.

- ▶▶ Enabled BIOS searches for floppy disk drive to determine it is 40 or 80 tracks. Note that BIOS can not tell from 720 K, 1.2 M or 1.44 M drive type as they are all 80tracks.
- ▶▶ Disabled BIOS will not search for the type of floppy disk drive by track number. Note that there will not be any warning message if the drive installed is 360 K. (Default value)

☞ **Password Check**

- ▶▶ System The system can not boot and can not access to Setup page will be denied if the correct password is not entered at the prompt.
- ▶▶ Setup The system will boot, but access to Setup will be denied if the correct password is not entered at the prompt. (Default value)

☞ **CPU Hyper-Threading**

- ▶▶ Enabled Enables CPU Hyper Threading Feature. Please note that this feature is only working for operating system with multi processors mode supported. (Default value)
- ▶▶ Disabled Disables CPU Hyper Threading.

☞ **Init Display First**

- ▶▶ AGP Set Init Display First to AGP. (Default value)
- ▶▶ PCI Set Init Display First to PCI.

Integrated Peripherals

CMOS Setup Utility-Copyright (C) 1984-2002 Award Software

Integrated Peripherals

On-Chip Primary PCI IDE	[Enabled]	Item Help
On-Chip Secondary PCI IDE	[Enabled]	Menu Level ►
IDE1 Conductor Cable	[Auto]	If a hard disk
IDE2 Conductor Cable	[Auto]	controller card is
USB Controller	[Enabled]	used, set at Disable
USB Keyboard Support	[Disabled]	
USB Mouse Support	[Disabled]	[Enabled]
AC97 Audio	[Auto]	Enable onboard IDE
Onboard H/W LAN (*)	[Enabled]	
Onboard LAN Boot ROM (*)	[Disabled]	
Onboard Serial Port 1	[3F8/IRQ4]	PORT
Onboard Serial Port 2	[2F8/IRQ3]	
UART Mode Select	[Normal]	
xUR2 Duplex Mode	Half	
Onboard Parallel Port	[378/IRQ7]	[Disabled]
Parallel Port Mode	[SPP]	Disable onboard IDE
x ECP Mode Use DMA	3	PORT
Game Port Address	[201]	
Midi Port Address	[330]	
Midi Port IRQ	[10]	
CIR Port Address	[Disabled]	
xCIR Port IRQ	11	
↑↓ → ← : Move Enter:Select +/-/PU/PD:Value F10:Save ESC:Exit F1:General Help F5:Previous Values F6:Fail-Safe Defaults F7:Optimized Defaults		

Figure 4: Integrated Peripherals

☞ On-Chip Primary PCI IDE

- ▶▶ Enabled Enable onboard 1st channel IDE port. (Default value)
- ▶▶ Disabled Disable onboard 1st channel IDE port.

☞ On-Chip Secondary PCI IDE

- ▶▶ Enabled Enable onboard 2nd channel IDE port. (Default value)
- ▶▶ Disabled Disable onboard 2nd channel IDE port.

“ * ” Only for GA-8GEM667.

☞ IDE1 Conductor Cable

- ▶▶ Auto Will be automatically detected by BIOS. (Default Value)
- ▶▶ ATA66/100 Set IDE1 Conductor Cable to ATA66/100 (Please make sure your IDE device and cable is compatible with ATA66/100).
- ▶▶ ATA33 Set IDE1 Conductor Cable to ATA33 (Please make sure your IDE device and cable is compatible with ATA33).

☞ IDE2 Conductor Cable

- ▶▶ Auto Will be automatically detected by BIOS. (Default Value)
- ▶▶ ATA66/100 Set IDE2 Conductor Cable to ATA66/100 (Please make sure your IDE device and cable is compatible with ATA66/100).
- ▶▶ ATA33 Set IDE2 Conductor Cable to ATA33 (Please make sure your IDE device and cable is compatible with ATA33).

☞ USB Controller

- ▶▶ Enabled Enable USB Controller. (Default value)
- ▶▶ Disabled Disable USB Controller.

☞ USB Keyboard Support

- ▶▶ Enabled Enable USB Keyboard Support.
- ▶▶ Disabled Disable USB Keyboard Support. (Default value)

☞ USB Mouse Support

- ▶▶ Enabled Enable USB Mouse Support.
- ▶▶ Disabled Disable USB Mouse Support. (Default value)

☞ AC'97 Audio

- ▶▶ Auto Enable onboard AC'97 audio function. (Default Value)
- ▶▶ Disabled Disable this function.

☞ Onboard H/W LAN (*)

- ▶▶ Enabled Enabled onboard H/W LAN Function.(Default value)
- ▶▶ Disabled Disabled onboard H/W LAN Function

“ * ” Only for GA-8GEM667.

☞ Onboard LAN Boot ROM (*)

- ▶▶ Enabled Enabled onboard LAN Boot ROM.
- ▶▶ Disabled Disabled onboard LAN Boot ROM.(Default value)

☞ Onboard Serial Port 1

- ▶▶ Auto BIOS will automatically setup the port 1 address.
- ▶▶ 3F8/IRQ4 Enable onboard Serial port 1 and address is 3F8. (Default value)
- ▶▶ 2F8/IRQ3 Enable onboard Serial port 1 and address is 2F8.
- ▶▶ 3E8/IRQ4 Enable onboard Serial port 1 and address is 3E8.
- ▶▶ 2E8/IRQ3 Enable onboard Serial port 1 and address is 2E8.
- ▶▶ Disabled Disable onboard Serial port 1.

☞ Onboard Serial Port 2

- ▶▶ Auto BIOS will automatically setup the port 2 address.
- ▶▶ 3F8/IRQ4 Enable onboard Serial port 2 and address is 3F8.
- ▶▶ 2F8/IRQ3 Enable onboard Serial port 2 and address is 2F8. (Default value)
- ▶▶ 3E8/IRQ4 Enable onboard Serial port 2 and address is 3E8.
- ▶▶ 2E8/IRQ3 Enable onboard Serial port 2 and address is 2E8.
- ▶▶ Disabled Disable onboard Serial port 2.

☞ UART Mode Select

(This item allows you to determine which Infra Red(IR) function of Onboard I/O chip)

- ▶▶ ASKIR Set onboard I/O chip UART to ASKIR Mode.
- ▶▶ IrDA Set onboard I/O chip UART to IrDA Mode.
- ▶▶ Normal Set onboard I/O chip UART to Normal Mode. (Default Value)

☞ UR2Duplex Mode

- ▶▶ Half IR Function Duplex Half. (Default Value)
- ▶▶ Full IR Function Duplex Full.

☞ Onboard Parallel port

- ▶▶ 378/IRQ7 Enable onboard LPT port and address is 378/IRQ7. (Default Value)
- ▶▶ 278/IRQ5 Enable onboard LPT port and address is 278/IRQ5.
- ▶▶ Disabled Disable onboard LPT port.
- ▶▶ 3BC/IRQ7 Enable onboard LPT port and address is 3BC/IRQ7.

☞ Parallel Port Mode

- ▶▶ SPP Using Parallel port as Standard Parallel Port. (Default Value)
- ▶▶ EPP Using Parallel port as Enhanced Parallel Port.
- ▶▶ ECP Using Parallel port as Extended Capabilities Port.
- ▶▶ ECP+EPP Using Parallel port as ECP & EPP mode.

☞ ECP Mode Use DMA

- ▶▶ 3 Set ECP Mode Use DMA to 3. (Default Value)
- ▶▶ 1 Set ECP Mode Use DMA to 1.

☞ Game Port Address

- ▶▶ 201 Set Game Port Address to 201. (Default Value)
- ▶▶ 209 Set Game Port Address to 209.
- ▶▶ Disabled Disable this function.

☞ Midi Port Address

- ▶▶ 300 Set Midi Port Address to 300.
- ▶▶ 330 Set Midi Port Address to 330.(Default Value)
- ▶▶ Disabled Disable this function.

☞ Midi Port IRQ

- ▶▶ 5 Set Midi Port IRQ to 5.
- ▶▶ 10 Set Midi Port IRQ to 10. (Default Value)

☞ CIR Port Address

- ▶▶ 310 Set CIR Port Address to 310.
- ▶▶ 320 Set CIR Port Address to 320.
- ▶▶ Disabled Disable this function.(Default Value)

☞ CIR Port IRQ

- ▶▶ 5 Set CIR Port IRQ to 5.
- ▶▶ 11 Set CIR Port IRQ to 11. (Default Value)

Power Management Setup

CMOS Setup Utility-Copyright (C) 1984-2002 Award Software

Power Management Setup

		Item Help
ACPI Suspend Type	[S1(POS)]	Menu Level ►
Soft-Off by PWR_BTTN	[Instant-Off]	[S1]
PME Event Wake Up	[Enabled]	Set suspend type to
ModemRingOn/WakeOnLan	[Enabled]	Power On Suspend under
Resume by Alarm	[Disabled]	ACPI OS
x Date (of Month) Alarm	Everyday	[S3]
x Time (hh:nn:ss)	0 0 0	Set suspend type to
Power On By Mouse	[Disabled]	Suspend to RAM under
Power On By Keyboard	[Disabled]	ACPI OS
x KB Power ON Password	Enter	
AC Back Function	[Soft-Off]	

↑↓→←: Move Enter:Select +/-/PU/PD:Value F10:Save ESC:Exit F1:General Help
 F5:Previous Values F6:Fail-Safe Defaults F7:Optimized Defaults

Figure 5: Power Management Setup

☞ ACPI Suspend Type

- ▶▶ S1(POS) Set ACPI suspend type to S1. (Default Value)
- ▶▶ S3(STR) Set ACPI suspend type to S3.

☞ Soft-off by PWR_BTTN

- ▶▶ Instant-off Press power button then Power off instantly. (Default value)
- ▶▶ Delay 4 Sec. Press power button 4 sec to Power off. Enter suspend if button is pressed less than 4 sec.

☞ PME Event Wake Up

- ▶▶ Disabled Disable this function.
- ▶▶ Enabled Enable PME Event Wake up. (Default Value)

☞ **Modem Ring On/ WakeOnLAN (When AC Back Function is set to [Soft-Off])**

M You can enable wake on LAN feature by the "ModemRingOn/WakeOnLAN" or "PME Event Wake up" when the M/B has "WOL" onboard connector. Only enabled the feature by "PME Event Wake up".

M An incoming call via modem awakes the system from its soft-off mode.

M When set at Enabled, an input signal comes from the other client/server on the LAN awaks the system from a soft off state if connected over LAN.

▶▶ Disabled Disabled Modem Ring On / Wake On LAN function.

▶▶ Enabled Enabled Modem Ring On / Wake On LAN function.

☞ **Resume by Alarm**

You can set "Resume by Alarm" item to enabled and key in Data/time to power on system.

▶▶ Disabled Disable this function. (Default Value)

▶▶ Enabled Enable alarm function to POWER ON system.

If RTC Alarm Lead To Power On is Enabled.

Date (of Month) Alarm : Everyday, 1-31

Time (hh: mm: ss) Alarm : (0-23) : (0-59) : (0-59)

☞ **Power On By Mouse**

▶▶ Disabled Disabled this function. (Default value)

▶▶ Mouse Click Double click on PS/2 mouse left button.

☞ **Power On By Keyboard**

▶▶ Password Enter from 1 to 5 characters to set the Keyboard Power On Password.

▶▶ Disabled Disabled this function. (Default value)

▶▶ Keyboard 98 If your keyboard have "POWER Key" button, you can press the key to power on your system.

☞ **KB Power ON Password**

▶▶ Enter Input password (from 1 to 5 characters) and press Enter to set the Keyboard Power On Password.

☞ **AC Back Function**

▶▶ Memory System power on depends on the status before AC lost.

▶▶ Soft-Off Always in Off state when AC back. (Default value)

▶▶ Full-On Always power on the system when AC back.

PnP/PCI Configurations

CMOS Setup Utility-Copyright (C) 1984-2002 Award Software

PnP/PCI Configurations

PCI 1 IRQ Assignment	[Auto]	Item Help
PCI 2 IRQ Assignment	[Auto]	Menu Level ►
PCI 3 IRQ Assignment	[Auto]	
↑↓→←: Move Enter:Select +/-/PU/PD:Value F10:Save ESC:Exit F1:General Help F5:Previous Values F6:Fail-Safe Defaults F7:Optimized Defaults		

Figure 6: PnP/PCI Configurations

☞ PCI 1 IRQ Assignment

- ▶▶ Auto Auto assign IRQ to PCI 1/PCI 5. (Default value)
- ▶▶ 3,4,5,7,9,10,11,12,14,15 Set IRQ 3,4,5,7,9,10,11,12,14,15 to PCI 1/PCI 5.

☞ PCI 2 IRQ Assignment

- ▶▶ Auto Auto assign IRQ to PCI 2. (Default value)
- ▶▶ 3,4,5,7,9,10,11,12,14,15 Set IRQ 3,4,5,7,9,10,11,12,14,15 to PCI 2.

☞ PCI 3 IRQ Assignment

- ▶▶ Auto Auto assign IRQ to PCI 3. (Default value)
- ▶▶ 3,4,5,7,9,10,11,12,14,15 Set IRQ 3,4,5,7,9,10,11,12,14,15 to PCI 3.

PC Health Status

CMOS Setup Utility-Copyright (C) 1984-2002 Award Software

PC Health Status

Reset Case Open Status	[Disabled]	Item Help
Case Opened	[No]	Menu Level ►
VCORE	1.71V	
+1.5V	1.488V	
+3.3V	3.29V	
+5V	4.99V	
+12V	11.73V	
Current CPU Temperature	40°C	
Current CPU FAN Speed	4821 RPM	
Current SYSTEM FAN Speed	0 RPM	
CPU Warning Temperature	[Disabled]	
CPU FAN Fail Warning	[Disabled]	
SYSTEM FAN Fail Warning	[Disabled]	
↑↓→←: Move Enter:Select +/-/PU/PD:Value F10:Save ESC:Exit F1:General Help F5:Previous Values F6:Fail-Safe Defaults F7:Optimized Defaults		

Figure 7: PC Health Status

☞ Reset Case Open Status

☞ Case Opened

If the case is closed, "Case Opened" will show "No".

If the case have been opened, "Case Opened" will show "Yes".

If you want to reset "Case Opened" value, set "Reset Case Open Status" to "Enabled" and save CMOS, your computer will restart.

☞ Current Voltage (V) VCORE / +1.5V / +3.3V / +5V / +12V

►► Detect system's voltage status automatically.

☞ Current CPU Temperature

►► Detect CPU Temp. automatically.

☞ **Current CPU/SYSTEM FAN Speed (RPM)**

- ▶▶ Detect CPU/SYSTEM Fan speed status automatically.

☞ **CPU Warning Temperature**

- ▶▶ 60°C / 140°F Monitor CPU Temp. at 60°C / 140°F.
- ▶▶ 70°C / 158°F Monitor CPU Temp. at 70°C / 158°F.
- ▶▶ 80°C / 176°F Monitor CPU Temp. at 80°C / 176°F.
- ▶▶ 90°C / 194°F Monitor CPU Temp. at 90°C / 194°F.
- ▶▶ Disabled Disable this function.(Default value)

☞ **CPU FAN Fail Warning**

- ▶▶ Disabled Fan Warning Function Disable. (Default value)
- ▶▶ Enabled Fan Warning Function Enable.

☞ **SYSTEM FAN Fail Warning**

- ▶▶ Disabled Fan Warning Function Disable. (Default value)
- ▶▶ Enabled Fan Warning Function Enable.

Frequency/Voltage Control

CMOS Setup Utility-Copyright (C) 1984-2002 Award Software

Frequency/Voltage Control

CPU Clock Ratio	15X	Item Help
CPU Host Clock Control	Disabled	Menu Level ►
※CPU Host Frequency (Mhz)	133	
※Fixed PCI/AGP Frequency	33/66	
Host/DRAM Clock ratio	Auto	
Memory Frequency (Mhz)	266	
PCI/AGP Frequency (Mhz)	33/66	
↑↓→←: Move Enter:Select +/-/PU/PD:Value F10:Save ESC:Exit F1:General Help F3: Language F5:Previous Values F6:Fail-Safe Defaults F7:Optimized Defaults		

Figure 8: Frequency/Voltage Control

※Those items will be available when "CPU Host Clock Control" is set to Enabled.

☞CPU Clock Ratio

This setup option will automatically assign by CPU detection.

For Willamette CPU:

8X-23X default: 14X

For C-Stepping P4:

8X,10X-24X default: 15X

For Northwood CPU:

12X-24X default: 16X

The option will display "Locked" and read only if the CPU ratio is not changeable.

☞CPU Host Clock Control

Note: If system hangs up before enter CMOS setup utility, wait for 20 sec for times out reboot . When time out occur, system will reset and run at CPU default Host clock at next boot.

- ▶▶ Disable Disable CPU Host Clock Control.(Default value)
- ▶▶ Enable Enable CPU Host Clock Control.

☞ CPU Host Frequency (MHz)

- ▶▶ 100MHz - 355MHz Set CPU Host Clock from 100MHz to 355MHz.

Incorrect using it may cause your system broken. For power End-User use only!

☞ Fixed PCI/AGP Frequency

- ▶▶ You can choose those mode to adjust PCI/AGP frequency. (Select PCI/AGP frequency asynchronous with CPU frequency).

☞ Host/DRAM Clock Ratio

for FSB(Front Side Bus) frequency=400MHz,

- ▶▶ 2.0 Memory Frequency = Host clock X 2.0.
- ▶▶ 2.66 Memory Frequency = Host clock X 2.66.
- ▶▶ Auto Set Memory frequency by DRAM SPD data. (Default value)

for FSB(Front Side Bus) frequency=533MHz,

- ▶▶ 2.0 Memory Frequency = Host clock X 2.0.
- ▶▶ 2.5 Memory Frequency = Host clock X 2.5.
- ▶▶ Auto Set Memory frequency by DRAM SPD data. (Default value)

☞ Memory Frequency(Mhz)

- ▶▶ The values depend on CPU Host Frequency(Mhz) .

☞ PCI/AGP Frequency(Mhz)

- ▶▶ The values depend on Fixed PCI/AGP Frequency.

Top Performance

CMOS Setup Utility-Copyright (C) 1984-2002 Award Software

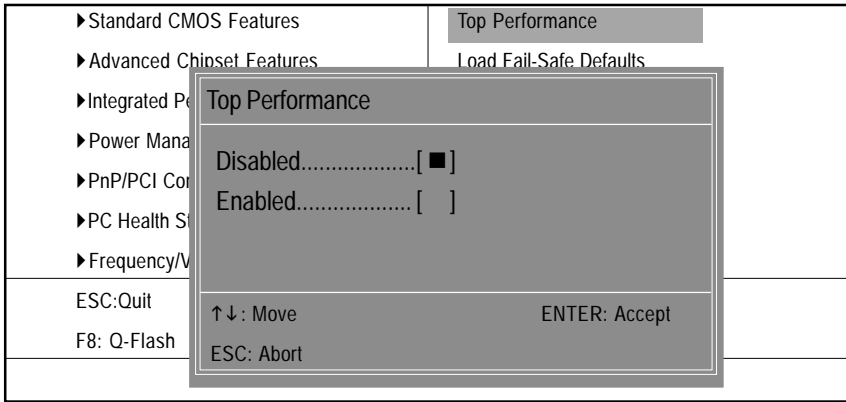

Figure 9: Top Performance

Top Performance

If you wish to maximize the performance of your system, set "Top Performance" as "Enabled".

- ▶▶ Disabled Disable this function. (Default Value)
- ▶▶ Enabled Enable Top Performance function.



You must check whether your RAM&CPU support over clock when you set "Top Performance" to " Enabled"

Load Fail-Safe Defaults

CMOS Setup Utility-Copyright (C) 1984-2002 Award Software

▶Standard CMOS Features	Top Performance
▶Advanced Chipset Features	Load Fail-Safe Defaults
▶Integrated Peripherals	Load Optimized Defaults
▶Power Man	Load Fail-Safe Defaults? (Y/N)?Y
▶PnP/PCI C	
▶PC Health Status	Save & Exit Setup
▶Frequency/Voltage Control	Exit Without Saving
ESC:Quit	↑↓→←:Select Item
F8: Q-Flash	F10:Save & Exit Setup
Load Fail-Safe Defaults	

Figure 10: Load Fail-Safe Defaults

Load Fail-Safe Defaults

Fail-Safe defaults contain the most appropriate values of the system parameters that allow minimum system performance.

Load Optimized Defaults

CMOS Setup Utility-Copyright (C) 1984-2002 Award Software

▶Standard CMOS Features	Top Performance
▶Advanced BIOS Features	Load Fail-Safe Defaults
▶Integrated Peripherals	Load Optimized Defaults
▶Power M	Load Optimized Defaults? (Y/N)?Y
▶PnP/PCI	Save & Exit Setup
▶PC Health Status	Exit Without Saving
▶Frequency/Voltage Control	
ESC:Quit	↑↓→←:Select Item
F8: Q-Flash	F10:Save & Exit Setup
Load Optimized Defaults	

Figure 11: Load Optimized Defaults

Load Optimized Defaults

Selecting this field loads the factory defaults for BIOS and Chipset Features which the system automatically detects.

Set Supervisor/User Password

CMOS Setup Utility-Copyright (C) 1984-2002 Award Software

▶Standard CMOS Features	Top Performance
▶Advanced BIOS Features	Load Fail-Safe Defaults
▶Integrated Peripherals	Load Optimized Defaults
▶Power Management	
▶PnP/PCI Configurations	
▶PC Health Status	Save & Exit Setup
▶Frequency/Voltage Control	Exit Without Saving
ESC:Quit	↑↓→←:Select Item
F8: Q-Flash	F10:Save & Exit Setup
Change/Set/Disable Password	

Figure 12: Password Setting

When you select this function, the following message will appear at the center of the screen to assist you in creating a password.

Type the password, up to eight characters, and press <Enter>. You will be asked to confirm the password. Type the password again and press <Enter>. You may also press <Esc> to abort the selection and not enter a password.

To disable password, just press <Enter> when you are prompted to enter password. A message "PASSWORD DISABLED" will appear to confirm the password being disabled. Once the password is disabled, the system will boot and you can enter Setup freely.

The BIOS Setup program allows you to specify two separate passwords:

SUPERVISOR PASSWORD and a USER PASSWORD. When disabled, anyone may access all BIOS Setup program function. When enabled, the Supervisor password is required for entering the BIOS Setup program and having full configuration fields, the User password is required to access only basic items.

If you select "System" at "Password Check" in Advance BIOS Features Menu, you will be prompted for the password every time the system is rebooted or any time you try to enter Setup Menu.

If you select "Setup" at "Password Check" in Advance BIOS Features Menu, you will be prompted only when you try to enter Setup.

Save & Exit Setup

CMOS Setup Utility-Copyright (C) 1984-2002 Award Software

▶Standard CMOS Features	Top Performance
▶Advanced BIOS Features	Load Fail-Safe Defaults
▶Integrated Peripherals	Load Optimized Defaults
▶Power Management Setup	Set Supervisor Password
▶PnP/PCI C	
▶PC Health	
▶Frequency/Voltage Control	Exit Without Saving
ESC:Quit	↑↓→←:Select Item
F8: Q-Flash	F10:Save & Exit Setup
Save Data to CMOS	

Figure 13: Save & Exit Setup

Type "Y" will quit the Setup Utility and save the user setup value to RTC CMOS.

Type "N" will return to Setup Utility.

Exit Without Saving

CMOS Setup Utility-Copyright (C) 1984-2002 Award Software

▶Standard CMOS Features	Top Performance
▶Advanced BIOS Features	Load Fail-Safe Defaults
▶Integrated Peripherals	Load Optimized Defaults
▶Power Management Setup	Set Supervisor Password
▶PnP/PCI Co	
▶PC Health S	
▶Frequency/Voltage Control	Exit Without Saving
ESC:Quit	↑↓→←:Select Item
F8: Q-Flash	F10:Save & Exit Setup
Abandon all Data	

Figure 14: Exit Without Saving

Type "Y" will quit the Setup Utility without saving to RTC CMOS.

Type "N" will return to Setup Utility.

Chapter 4 Technical Reference

Block Diagram

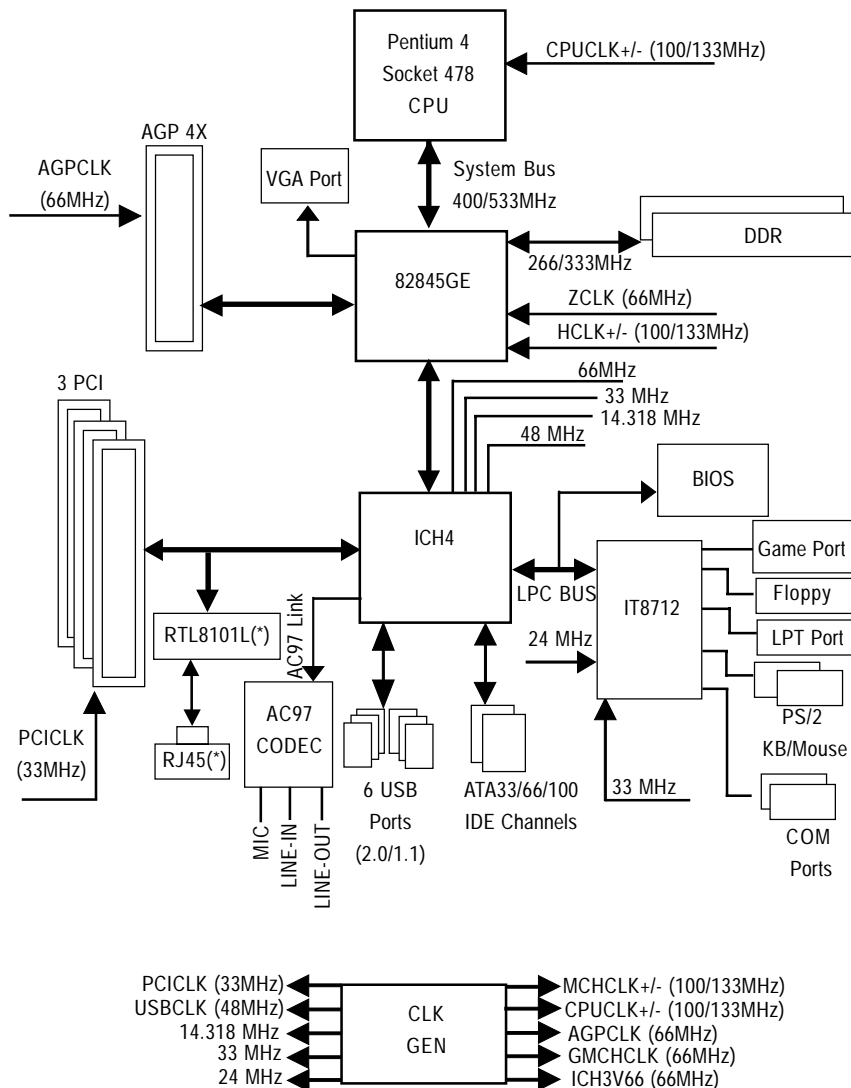

“ * ” Only for GA-8GEM667.

BIOS Flash Procedure



Method 1:

We use GA-7VTX motherboard and Flash841 BIOS flash utility as example.

Please flash the BIOS according to the following procedures if you are now under the DOS mode.

Flash BIOS Procedure:

STEP 1:

(1) Please make sure your system has installed the extraction utility such as winzip or pkunzip.

Firstly you have to install the extraction utility such as winzip or pkunzip for unzip the files.

Both of these utilities are available on many shareware download pages like <http://www.cnet.com>

STEP 2: Make a DOS boot diskette. (See example: Windows 98 O.S.)

Beware: Windows ME/2000 are not allowed to make a DOS boot diskette.

(1) With an available floppy disk in the floppy drive. Please leave the diskette "UN-write protected" type. Double click the "My Computer" icon from Desktop, then click "3.5 diskette (A)" and right click to select "Format (M)"

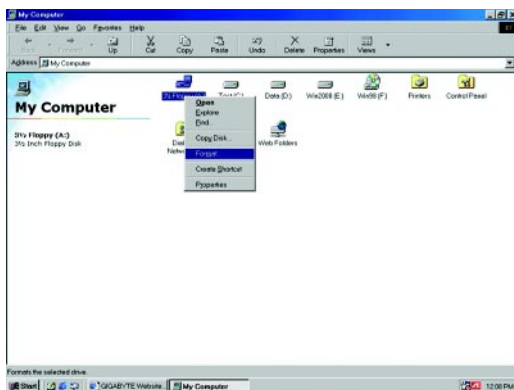

- (2) Select the "Quick (erase)" for Format Type, and pick both "Display summary when finished" and "Copy system files", after that press "Start". That will format the floppy and transfer the needed system files to it.

Beware: This procedure will erase all the prior data on that floppy, so please proceed accordingly.

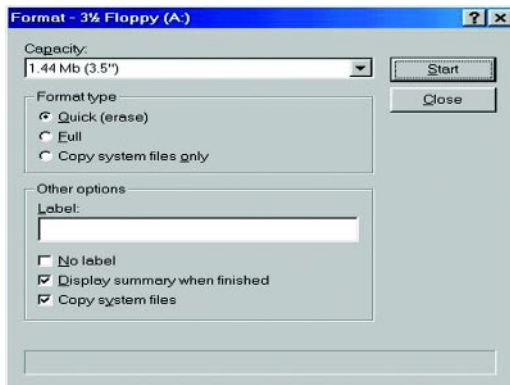

- (3) After the floppy has been formatted completely, please press "Close".

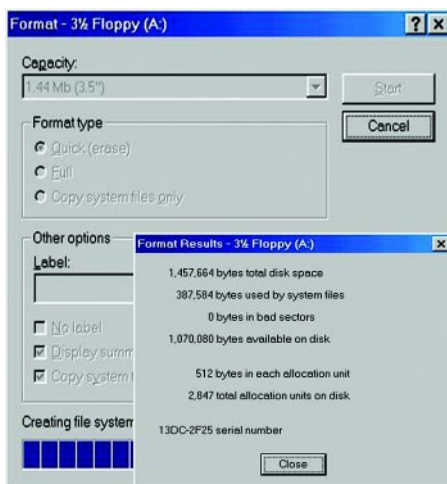

STEP 3: Download BIOS and BIOS utility program.

(1) Please go to Gigabyte website <http://www.gigabyte.com.tw/index.html>, and click "Support".



(2) From Support zone, click the "Motherboards BIOS & Drivers".

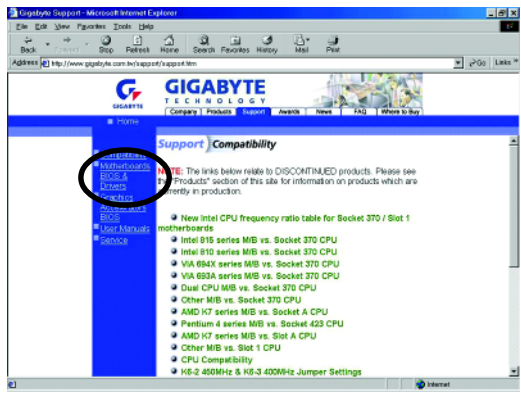

- (3) We use GA-7VTX motherboard as example. Please select GA-7VTX by Model or Chipset optional menu to obtain BIOS flash files.

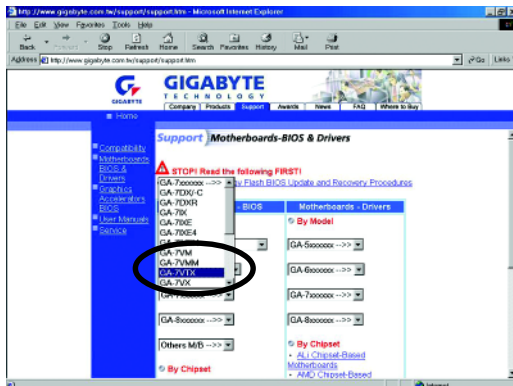

- (4) Select an appropriate BIOS version (For example: F4), and click to download the file. It will pop up a file download screen, then select the "Open this file from its current location" and press "OK".



- (5) At this time the screen shows the following picture, please click "Extract" button to unzip the files.

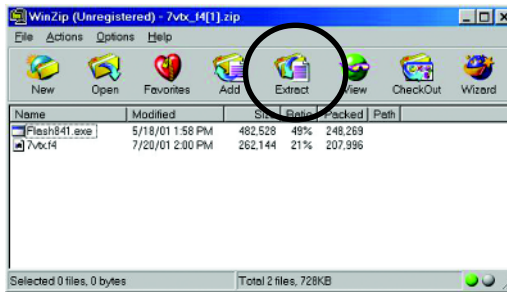

- (6) Please extract the download files into the clean bootable floppy disk A mentioned in STEP 2, and press "Extract".

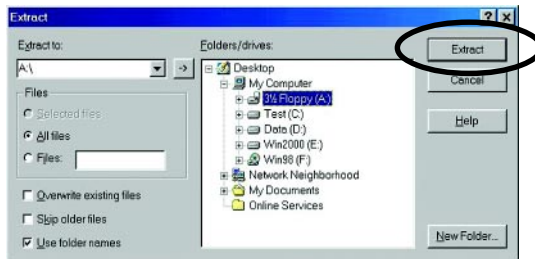

STEP 4: Make sure the system will boot from the floppy disk.

- (1) Insert the floppy disk (contains bootable program and unzip file) into the floppy drive A. Then, restart the system. The system will boot from the floppy disk. Please press key to enter BIOS setup main menu when system is boot up.



- (2) Once you enter the BIOS setup utility, the main menu will appear on the screen. Use the arrows to highlight the item "BIOS FEATURES SETUP".

AMIBIOS SIMPLE SETUP UTILITY - VERSION 1.24b (C) 1999 American Megatrends, Inc. All Rights Reserved	
STANDARD CMOS SETUP BIOS FEATURES SETUP CHIPSET FEATURES SETUP POWER MANAGEMENT SETUP PNP / PCI CONFIGURATION LOAD BIOS DEFAULTS LOAD SETUP DEFAULTS	INTEGRATED PERIPHERALS HARDWARE MONITOR & MISC SETUP SUPERVISOR PASSWORD USER PASSWORD IDE HDD AUTO DETECTION SAVE & EXIT SETUP EXIT WITHOUT SAVING
ESC: Quit h i f g : Select Item (Shift)F2 : Change Color F5: Old Values F6: Load BIOS Defaults F7: Load Setup Defaults F10: Save & Exit	
Time, Date , Hard Disk Type...	

- (3) Press "Enter" to enter "BIOS FEATURES SETUP" menu. Use the arrows to highlight the item "1st Boot Device", and then use the "Page Up" or "Page Down" keys to select "Floppy".

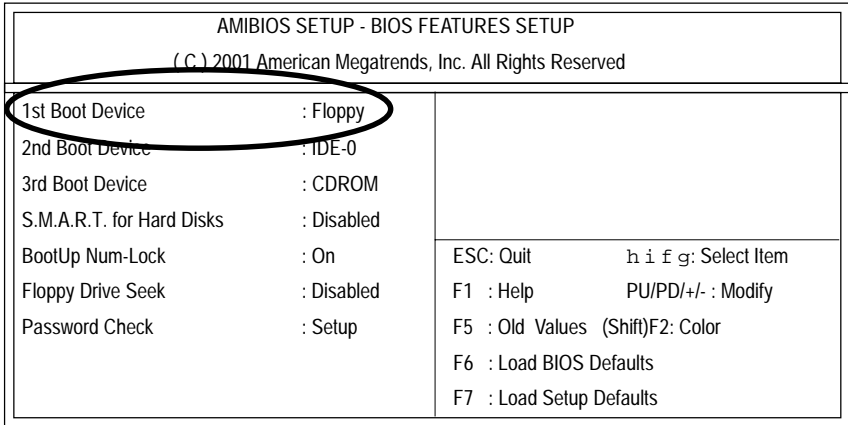

- (4) Press "ESC" to go back to previous screen. Use the arrows to highlight the item "SAVE & EXIT SETUP" then press "Enter". System will ask "SAVE to CMOS and EXIT (Y/N)?" Press "Y" and "Enter" keys to confirm. Now the system will reboot automatically, the new BIOS setting will be taken effect next boot-up.

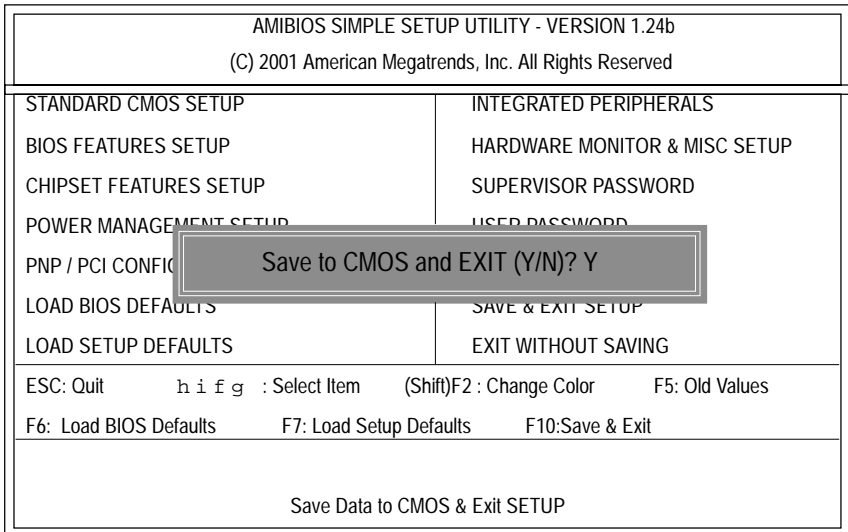

STEP 5: BIOS flashing.

- (1) After the system boot from floppy disk, type "A:\> dir/w" and press "Enter" to check the entire files in floppy A. Then type the "BIOS flash utility" and "BIOS file" after A:\>. In this case you have to type "A:\> Flash841 7VTX.F4" and then press "Enter".

```
Starting Windows 98...

Microsoft(R) Windows98
  © Copyright Microsoft Corp 1981-1999

A:\> dir/w
      Volume in drive A has no label
      Volume Serial Number is 16EB-353D
      Directory of A:\
COMMAND.COM  7VTX.F4  FLASH841.EXE
              3 file(s)  838,954 bytes
              0 dir(s)   324,608 bytes free

A:\> Flash841 7VTX.F4
```

- (2) Now screen appears the following Flash Utility main menu. Press "Enter", the highlighted item will locate on the model name of the right-upper screen. Right after that, press "Enter" to start BIOS Flash Utility.

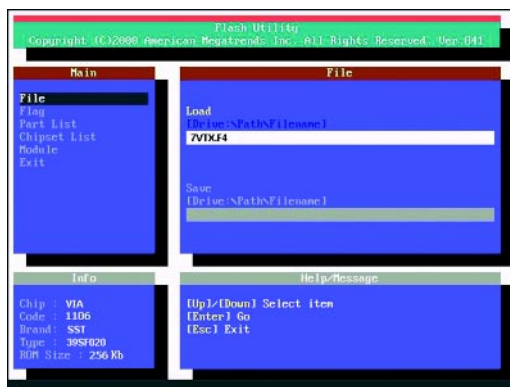

- (3) It will pop up a screen and asks "Are you sure to flash the BIOS?" Press [Enter] to continue the procedure, or press [ESC] to quit.

Beware: Please do not turn off the system while you are upgrading BIOS. It will render your BIOS corrupted and system totally inoperative.

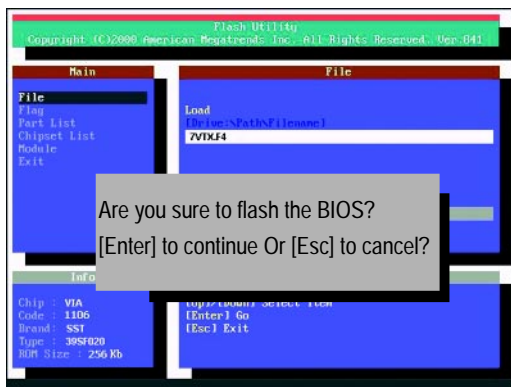

- (4) The BIOS flash completed. Please press [ESC] to exit Flash Utility.

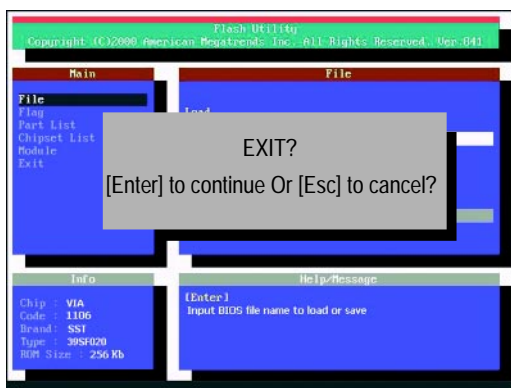

STEP 6: Load BIOS defaults.

Normally the system redetects all devices after BIOS has been upgraded. Therefore, we highly recommend reloading the BIOS defaults after BIOS has been upgraded. This important step resets everything after the flash.

- (1) Take out the floppy diskette from floppy drive, and then restart the system. The boot up screen will indicate your motherboard model and current BIOS version.



- (2) Don't forget to press key to enter BIOS setup again when system is boot up. Use the arrows to highlight the item "LOAD SETUP DEFAULTS" then press "Enter". System will ask "Load Setup Defaults (Y/N)?" Press "Y" and "Enter" keys to confirm.

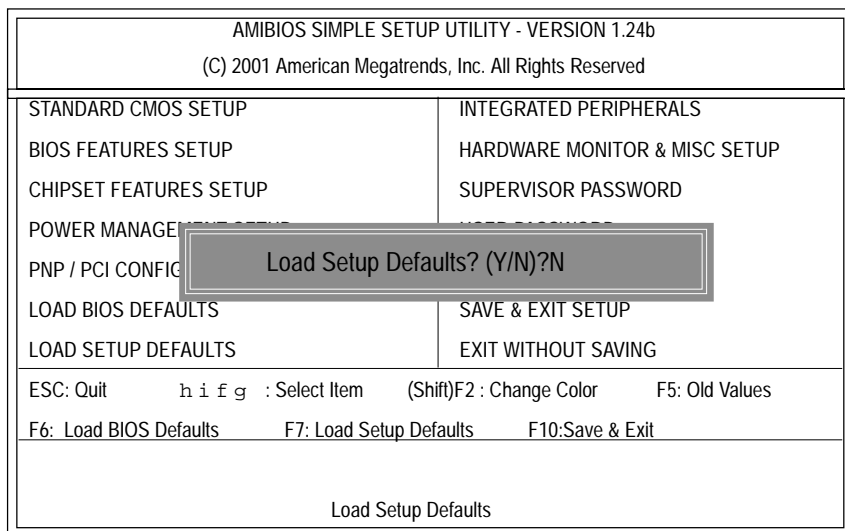

- (3) Use the arrows to highlight the item "SAVE & EXIT SETUP" and press "Enter". System will ask "SAVE to CMOS and EXIT (Y/N)?" Press "Y" and "Enter" keys to confirm. Now the system will reboot automatically, the new BIOS setting will be taken effect next boot-up.

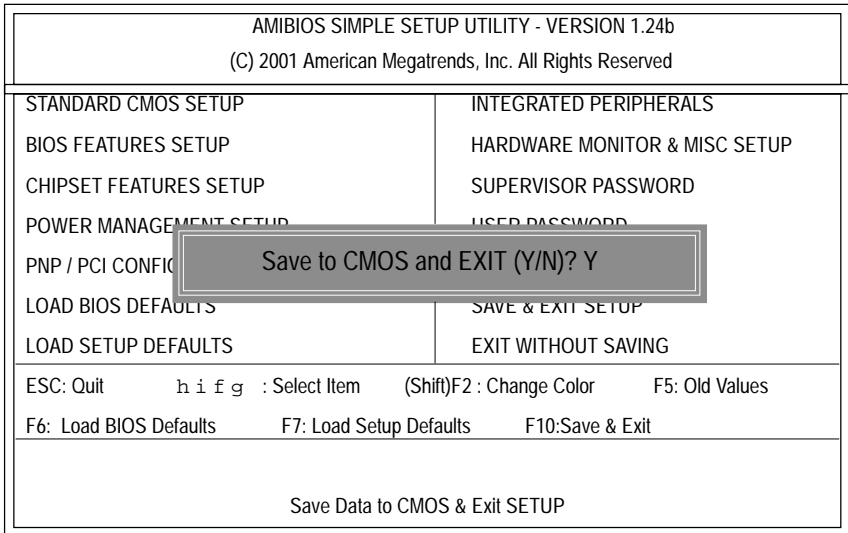

- (4) Congratulate you have accomplished the BIOS flash procedure.



Method 2:

Q-Flash Introduction

A. What is Q-Flash Utility?

Q-Flash utility is a pre-O.S. BIOS flash utility enables users to update its BIOS within BIOS mode, no more fooling around any OS.

B. How to use Q-Flash?

a. After power on the computer, pressing immediately during POST (Power On Self Test) it will allow you to enter AWARD BIOS CMOS SETUP, then press <F8> to enter Q-Flash utility.

CMOS Setup Utility-Copyright (C) 1984-2002 Award Software

}Standard CMOS Features	Top Performance
}Advanced BIOS Features	Load Fail-Safe Defaults
}Integrated Peripherals	Load Optimized Defaults
}Power	Enter Q-Flash Utility (Y/N)? Y
}PnP/PC	
}PC Health Status	Save & Exit Setup
}Frequency/Voltage Control	Exit Without Saving
ESC:Quit	h i g h:Select Item
F8: Q-Flash	F10:Save & Exit Setup
Time, Date, Hard Disk Type...	

b. Q-Flash Utility

Q-Flash Utility V3.05	
Flash Type/Size :	SST 39SF020 / 256K
Keep DMI Data :	Yes
Load BIOS from Floppy Save BIOS to Floppy	
Enter: Run	Space Bar:Change Value
ESC: Reset	↑/↓: Select Item

Load BIOS From Floppy

 In the A:drive, insert the "BIOS" diskette, then Press Enter to Run.

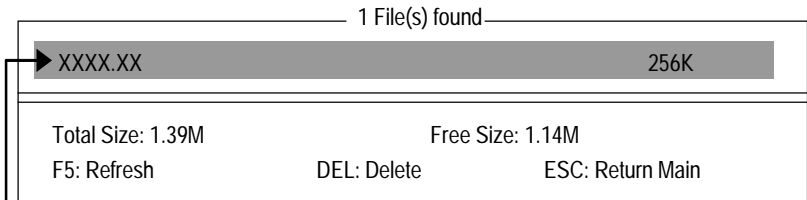

Where XXXX.XX is name of the BIOS file.

 Press Enter to Run.

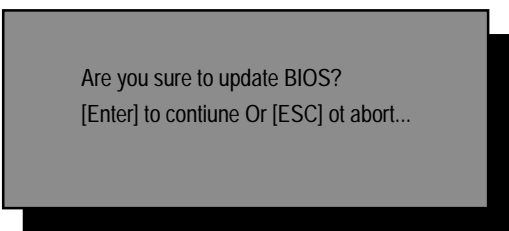

 Press Enter to Run.

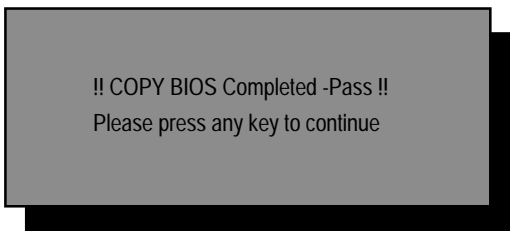

Congratulation! You have completed the flashed and now can restart system.

Method 3:

If you don't have DOS boot disk, we recommend that you used Gigabyte @BIOS™ program to flash BIOS.

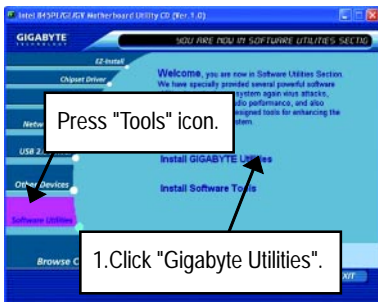

(1)

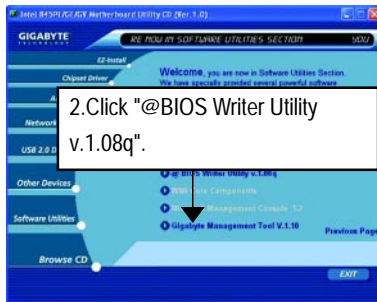

(2)

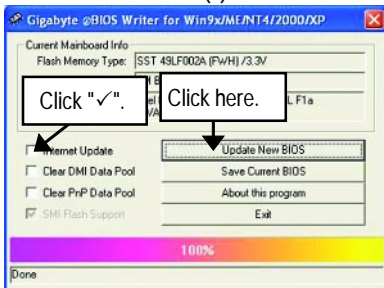

(3)



(4)

Methods and steps:

- I. Update BIOS through Internet
 - a. Click "Internet Update" icon
 - b. Click "Update New BIOS" icon
 - c. Select @BIOS™ sever
 - d. Select the exact model name on your motherboard
 - e. System will automatically download and update the BIOS.

II. Update BIOS NOT through Internet:

- a. Do not click "Internet Update" icon
- b. Click "Update New BIOS"
- c. Please select "All Files" in dialog box while opening the old file.
- d. Please search for BIOS unzip file, downloading from internet or any other methods (such as: 8GEM667.E2).
- e. Complete update process following the instruction.

III. Save BIOS

In the very beginning, there is "Save Current BIOS" icon shown in dialog box. It means to save the current BIOS version.

IV. Check out supported motherboard and Flash ROM:

In the very beginning, there is "About this program" icon shown in dialog box. It can help you check out which kind of motherboard and which brand of Flash ROM are supported.

Note:

- a. In method I, if it shows two or more motherboard's model names to be selected, please make sure your motherboard's model name again. Selecting wrong model name will cause the system unbooted.
- b. In method II, be sure that motherboard's model name in BIOS unzip file are the same as your motherboard's. Otherwise, your system won't boot.
- c. In method I, if the BIOS file you need cannot be found in @BIOS™ server, please go onto Gigabyte's web site for downloading and updating it according to method II.
- d. Please note that any interruption during updating will cause system unbooted

@ BIOS Introduction

Gigabyte announces @ BIOS Windows BIOS live update utility



Have you ever updated BIOS by yourself? Or like many other people, you just know what BIOS is, but always hesitate to update it? Because you think updating newest BIOS is unnecessary and actually you don't know how to update it.

Maybe not like others, you are very experienced in BIOS updating and spend quite a lot of time to do it. But of course you don't like to do it too much. First, download different BIOS from website and then switch the operating system to DOS mode. Secondly, use different flash utility to update BIOS. The above process is not a interesting job. Besides, always be carefully to store the BIOS source code correctly in your disks as if you update the wrong BIOS, it will be a nightmare.

Certainly, you wonder why motherboard vendors could not just do something right to save your time and effort and save you from the lousy BIOS updating work? Here it comes! Now Gigabyte announces @BIOS—the first Windows BIOS live update utility. This is a smart BIOS update software. It could help you to download the BIOS from internet and update it. Not like the other BIOS update software, it's a Windows utility. With the help of '@BIOS', BIOS updating is no more than a click.

Besides, no matter which mainboard you are using, if it's a Gigabyte's product*, @BIOS help you to maintain the BIOS. This utility could detect your correct mainboard model and help you to choose the BIOS accordingly. It then downloads the BIOS from the nearest Gigabyte ftp site automatically. There are several different choices; you could use "Internet Update" to download and update your BIOS directly. Or you may want to keep a backup for your current BIOS, just choose "Save Current BIOS" to save it first. You make a wise choice to use Gigabyte, and @BIOS update your BIOS smartly. You are now worry free from updating wrong BIOS, and capable to maintain and manage your BIOS easily. Again, Gigabyte's innovative product erects a milestone in mainboard industries.

For such a wonderful software, how much it costs? Impossible! It's free! Now, if you buy a Gigabyte's motherboard, you could find this amazing software in the attached driver CD. But please remember, connected to internet at first, then you could have a internet BIOS update from your Gigabyte @BIOS.

Easy Tune™ 4 Introduction

Gigabyte announces *EasyTune™ 4* Windows based Overclocking utility

EasyTune 4 carries on the heritage so as to pave the way for future generations.

Overclock" might be one of the most common issues in computer field. But have many users ever tried it? The answer is probably "no". Because "Overclock" is thought to be very difficult and includes a lot of technical know-how, sometimes "Overclock" is even considered as special skills found only in some enthusiasts. But as to the experts in "Overclock", what's the truth? They may spend quite a lot of time and money to study, try and use many different hardware or BIOS tools to do "Overclock". And even with these technologies, they still learn that it's quite a risk because the safety



and stability of an "Overclock" system is unknown. Now everything is different because of a Windows based overclocking utility "EasyTune 4" --announced by Gigabyte. This windows based utility has totally changed the gaming rule of "Overclock". This is the first windows based overclocking utility is suitable for both normal and power users. Users can choose either "Easy Mode" or "Advanced Mode" for overclocking at their convenience. For users who choose "Easy Mode", they just need to click "Auto Optimize" to have autoed and immediate CPU overclocking. This software will then overdrive CPU speed automatically with the result being shown in the control panel. If users prefer "Overclock" by them, there is also another choice. Click "Advanced Mode" to enjoy "sport drive" class Overclocking user interface. "Advanced Mode", allows users to change the system bus / AGP / Memory working frequency in small increments to get ultimate system performance. It operates in coordination with Gigabyte motherboards. Besides, it is different from other traditional overclocking methods, EasyTune 4 doesn't require users to change neither BIOS nor hardware switch/jumper setting; on the other hand, they can do "Overclock" at easy step . Therefore, this is a safer way for "Overclock" as nothing is changed on software or hardware. If user runs EasyTune 4 over system's limitation, the biggest lost is only to restart the computer again and the side effect is then well controlled. Moreover, if one well-performed system speed has been tested in EasyTune 4, user can "Save" this setting and "Load" it in next time. Obviously, Gigabyte EasyTune 4 has already turned the "Overclock" technology toward to a newer generation. This wonderful software is now free bundled in Gigabyte motherboard attached in driver CD. Users may make a test drive of "EasyTune 4" to find out more amazing features by themselves.

*Some Gigabyte products are not fully supported by EasyTune 4. Please find the products supported list in the web site.

*Any "Overclocking action" is at user's risk, Gigabyte Technology will not be responsible for any damage or instability to your processor, motherboard, or any other components.

2-/4-/6-Channel Audio Function

The installation of windows 98SE/2K/ME/XP is very simple. Please follow next step to install the function!

Stereo Speakers Connection and Settings:

We recommend that you use the speaker with amplifier to acquire the best sound effect if the stereo output is applied.

STEP 1:

Connect the stereo speakers or earphone to "Line Out".

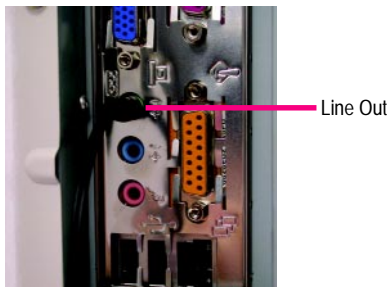

STEP 2 :

After installation of the audio driver, you 'll find an  icon on the taskbar's status area. Click the audio icon "Sound Effect" from the windows tray at the bottom of the screen.

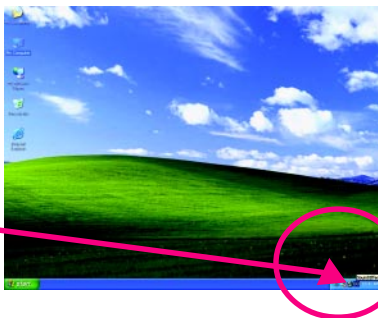
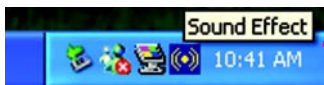

STEP 3:

Select "Speaker Configuration", and choose the "2 channels for stereo speakers output".

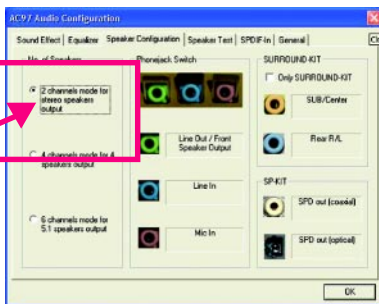

4 Channel Analog Audio Output Mode

STEP 1 :

Connect the front channels to "Line Out", the rear channels to "Line In".

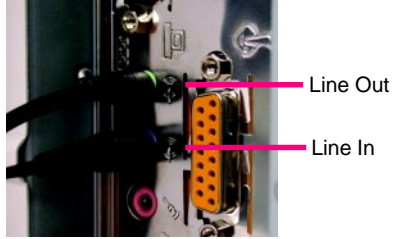

STEP 2 :

After installation of the audio driver, you'll find an  icon on the taskbar's status area. Click the audio icon "Sound Effect" from the windows tray at the bottom of the screen.

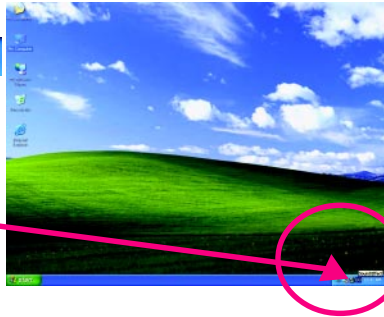
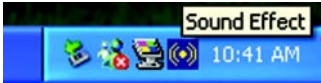

STEP 3 :

Select "Speaker Configuration", and choose the "4 channels for 4 speakers output". Disable "Only SURROUND-KIT", and press "OK".

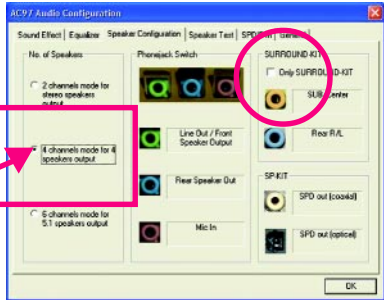
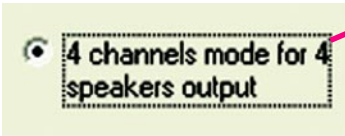

When the "Environment settings" is "None", the sound would be performed as stereo mode (2 channels output). Please select the other settings for 4 channels output.

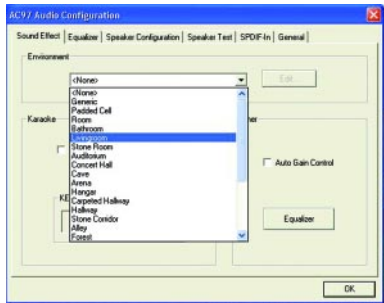

Basic 6 Channel Analog Audio Output Mode

Use the back audio panel to connect the audio output without any additional module.

STEP 1 :

Connect the front channels to "Line Out", the rear channels to "Line In", and the Center/Subwoofer channels to "MIC In".

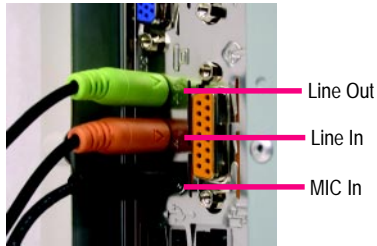

STEP 2 :

After installation of the audio driver, you'll find an  icon on the taskbar's status area. Click the audio icon "Sound Effect" from the windows tray at the bottom of the screen.

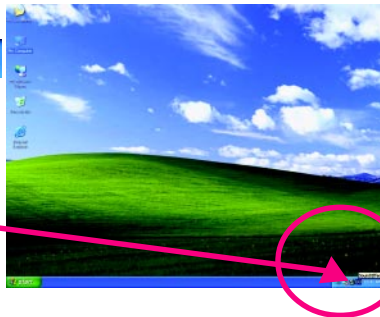
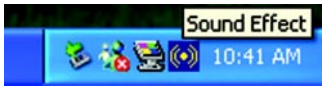

STEP 3 :

Select "Speaker Configuration", and choose the "6 channels for 5.1 speakers output".

Disable "Only SURROUND-KIT" and press "OK"

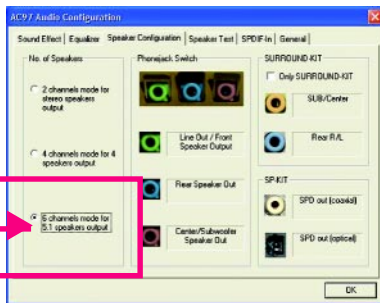

Advanced 6 Channel Analog Audio Output Mode (using Audio Combo Kit,Optional Device):

(Audio Combo Kit provides SPDIF output port : optical & coaxial and SURROUND-KIT : Rear R/L & Center/subwoofer)

SURROUND-KIT access analog output to rear channels and Center/Subwoofer channels. It is the best solution if you need 6 channel output, Line In and MIC at the same time. "SURROUND-KIT" is included in the GIGABYTE unique "Audio Combo Kit" as picture.



STEP 1 :

Insert the "Audio Combo Kit" in the back of the case , and fix it with the screw.



STEP 2 :

Connect the "SURROUND-KIT" to SUR_CEN on the M/B.

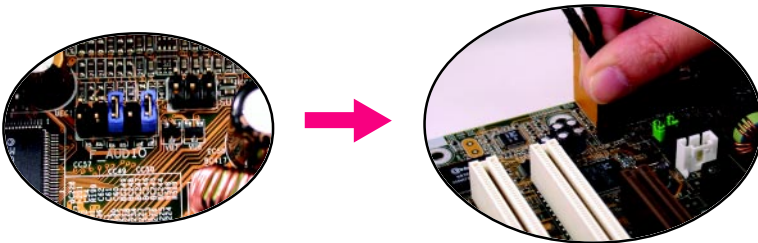

STEP 3 :

Connect the front channels to back audio panel's "Line Out", the rear channels to SURROUND-KIT's REAR R/L, and the Center/Subwoofer channels to SURROUND-KIT's SUB CENTER.

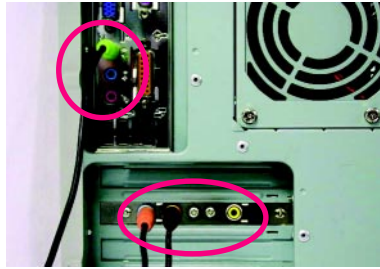

STEP 4 :

Click the audio icon "Sound Effect" from the windows tray at the bottom of the screen.

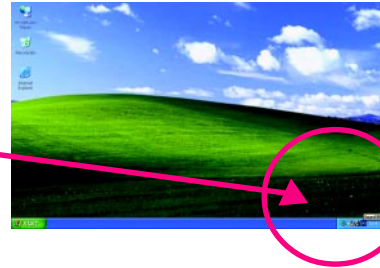
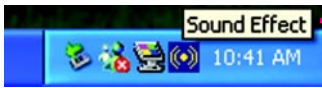

STEP 5 :

Select "Speaker Configuration", and choose the "6 channels for 5.1 speakers out put".

Enable "Only SURROUND-KIT" and press "OK".

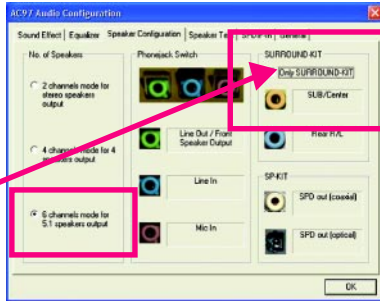
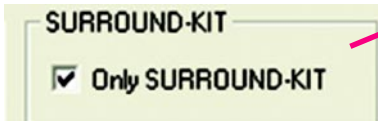

Basic & Advanced 6 Channel Analog Audio Output ModeNotes:

When the "Environment settings" is "None", the sound would be performed as stereo mode(2 channels output). Please select the other settings for 6 channels output.

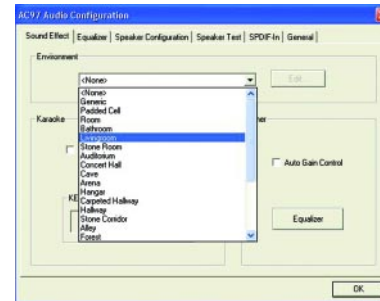

SPDIF Output Device (Optional Device)

A “SPDIF output” device is available on the motherboard. Cable with rear bracket is provided and could link to the “SPDIF output” connector (As picture.) For the further linkage to decoder, rear bracket provides coaxial cable and Fiber connecting port.

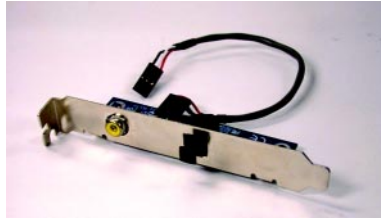

1. Connect the SPDIF output device to the rear bracket of PC, and fix it with screw.



2. Connect SPDIF wire to the motherboard.

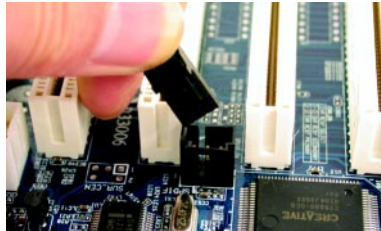

3. Connect co-axial or optical output to the SPDIF decoder.

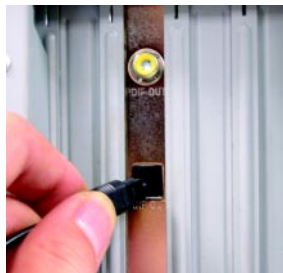

Chapter 5 Appendix

Picture below are shown in Windows XP (CD driver version 1.0)

Appendix A: Chipset Driver Installation

A. Intel Chipset Software Installation Utility:

Insert the driver CD-title that came with your motherboard into your CD-ROM driver, the driver CD-title will auto start and show the installation guide. If not, please double click the CD-ROM device icon in "My computer", and execute the setup.exe.



1. Click "Intel Chipset Software Installation Utility" item.

(1)

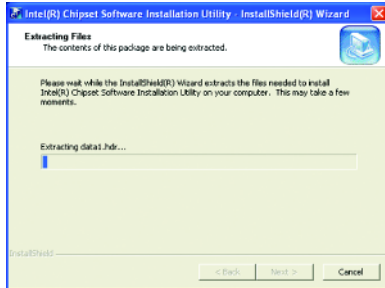

(2)

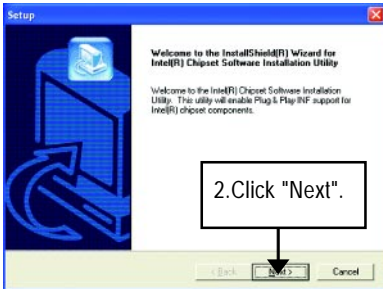

2. Click "Next".

(3)

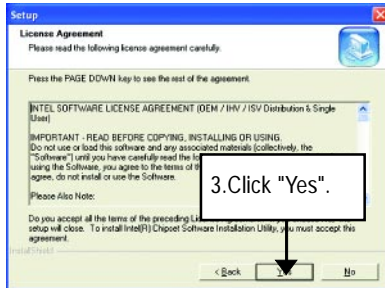

(4)

3. Click "Yes".

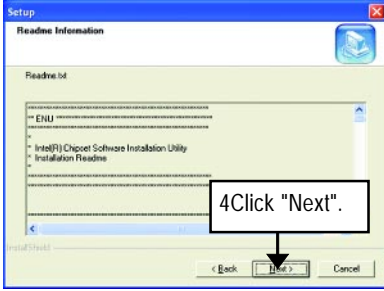

(5)

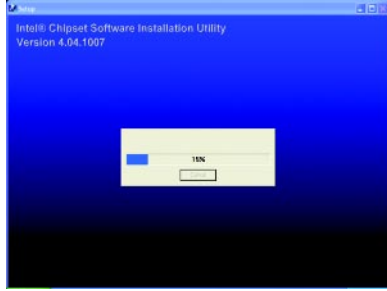

(6)

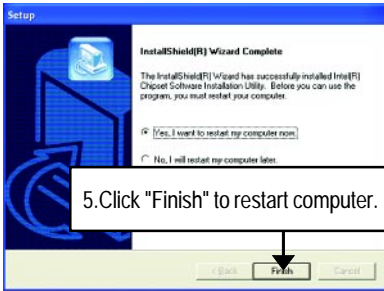

(7)

B. Intel Application Accelerator

Insert the driver CD-title that came with your motherboard into your CD-ROM driver, the driver CD-title will auto start and show the installation guide. If not, please double click the CD-ROM device icon in "My computer", and execute the setup.exe.

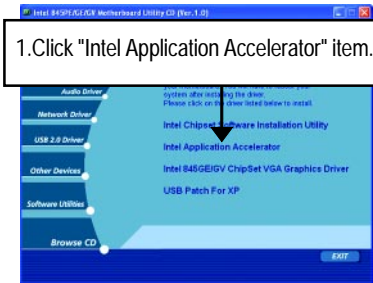

(1)

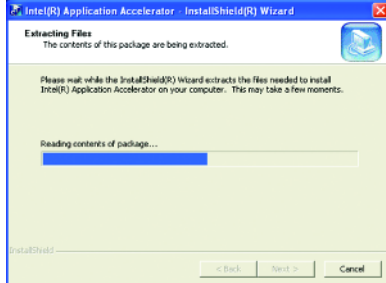

(2)

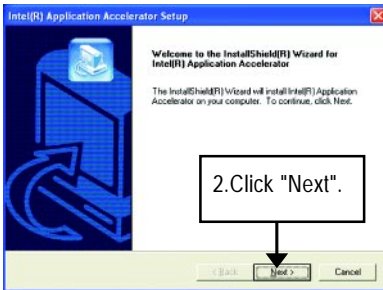

(3)

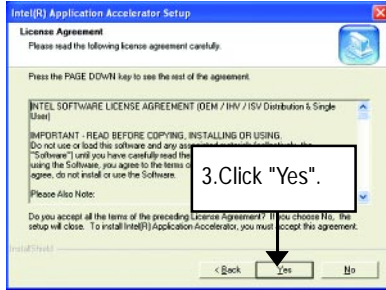

(4)

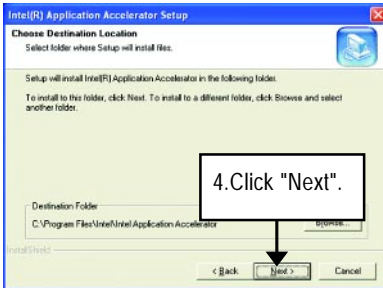

(5)

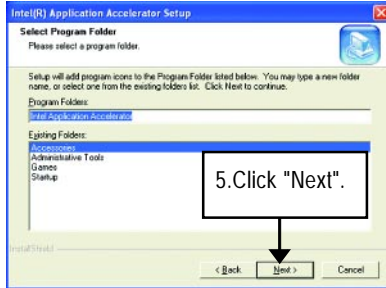

(6)

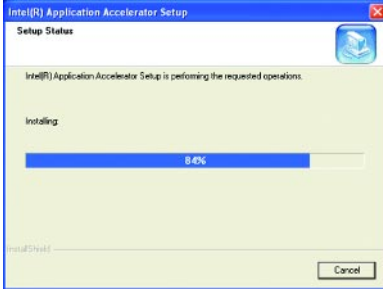

(7)

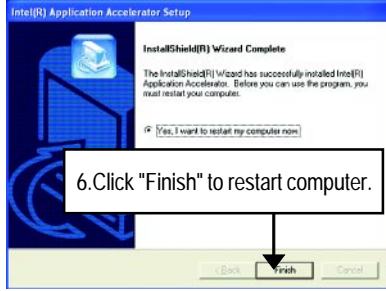

(8)

C. Intel 845GE/GV ChipSet VGA Graphics Driver



(1)

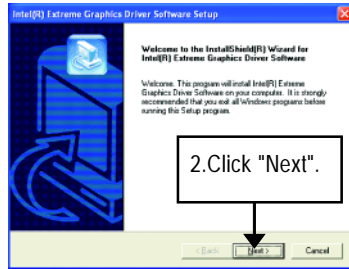

(2)

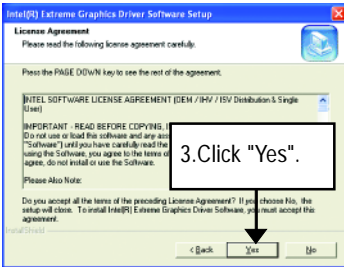

(3)

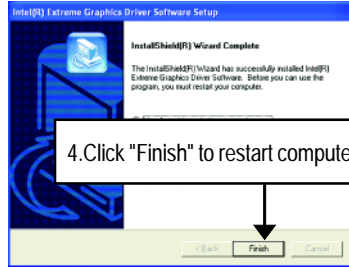

(4)

d. USB Patch Driver For XP

Enable S3 for USB Device Setup is preparing the InstallShield(R) Wizard which will guide you through the setup process.

Appendix B: RealTek AC'97 Audio Driver

Insert the driver CD-title that came with your motherboard into your CD-ROM driver, the driver CD-title will auto start and show the installation guide. If not, please double click the CD-ROM device icon in "My computer", and execute the setup.exe.



(1)

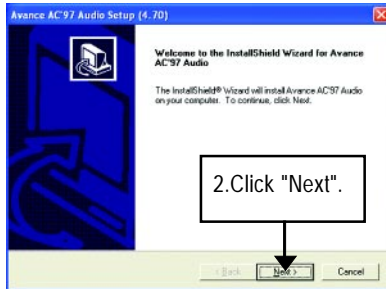

(2)

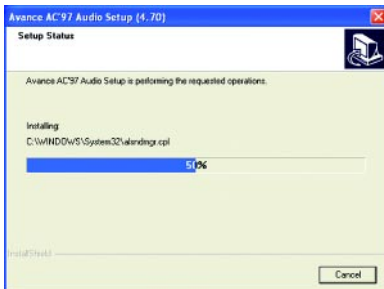

(3)

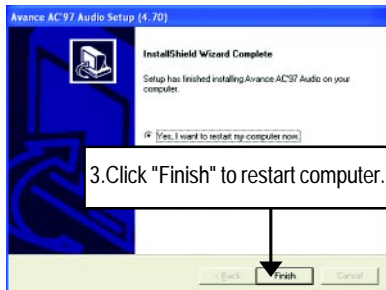

(4)

Appendix C: Intel Network Driver Installation (*)

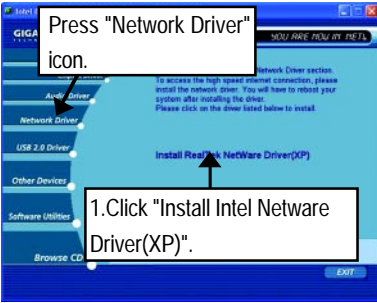

(1)



(2)



(3)



(4)



(5)

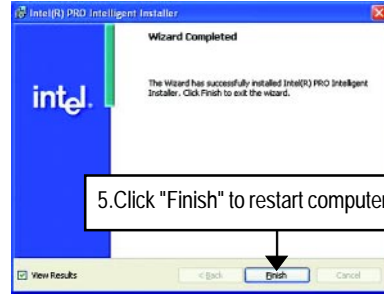

(6)

* * * Only for GA-8GEM667.

Appendix D: USB 2.0 Driver Installation

A. USB 2.0 Driver Patch For XP:

Insert the driver CD-title that came with your motherboard into your CD-ROM driver, the driver CD-title will auto start and show the installation guide. If not, please double click the CD-ROM device icon in "My computer", and execute the setup.exe.

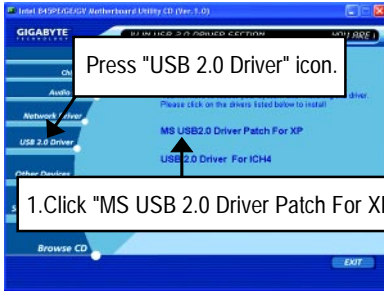

(1)



(2)

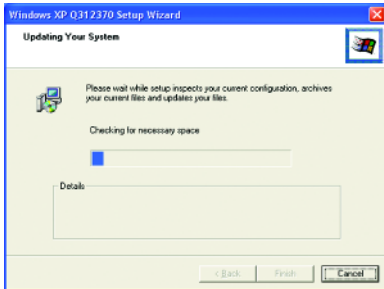

(3)

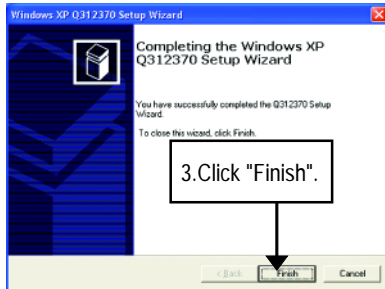

(4)

B. USB 2.0 Driver For ICH4:

Insert the driver CD-title that came with your motherboard into your CD-ROM driver, the driver CD-title will auto start and show the installation guide. If not, please double click the CD-ROM device icon in "My computer", and execute the setup.exe.

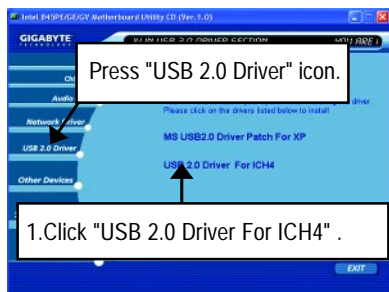

(1)



(2)

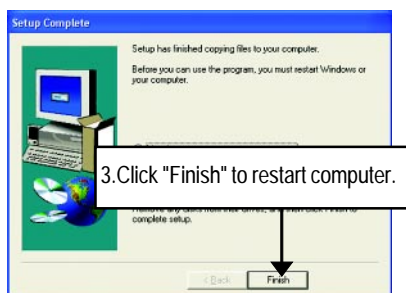

(3)



If there is any problem occurred during USB2.0 device installing, using or upgrading. Please visit Microsoft or GIGABYTE website for downloading the latest drivers.

Appendix E: EasyTune 4 Utilities Installation

Insert the driver CD-title that came with your motherboard into your CD-ROM driver, the driver CD-title will auto start and show the installation guide. If not, please double click the CD-ROM device icon in "My computer", and execute the setup.exe.

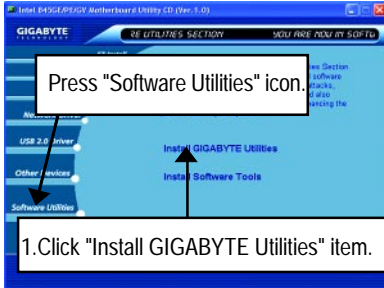

(1)



(2)

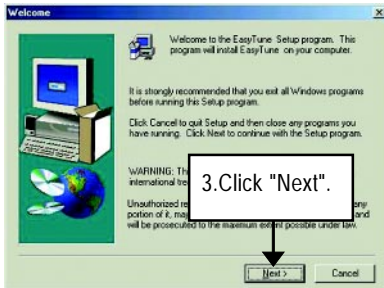

(3)



(4)

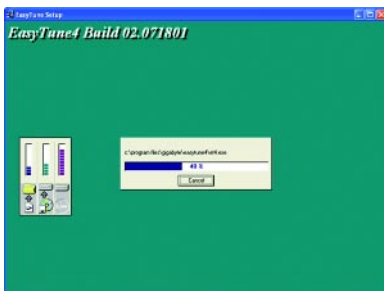

(5)

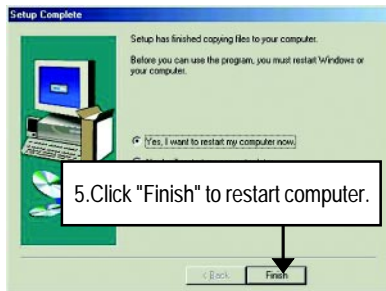

(6)

Appendix F: Acronyms

Acronyms	Meaning
ACPI	Advanced Configuration and Power Interface
APM	Advanced Power Management
AGP	Accelerated Graphics Port
AMR	Audio Modem Riser
ACR	Advanced Communications Riser
BIOS	Basic Input / Output System
CPU	Central Processing Unit
CMOS	Complementary Metal Oxide Semiconductor
CRIMM	Continuity RIMM
CNR	Communication and Networking Riser
DMA	Direct Memory Access
DMI	Desktop Management Interface
DIMM	Dual Inline Memory Module
DRM	Dual Retention Mechanism
DRAM	Dynamic Random Access Memory
DDR	Double Data Rate
ECP	Extended Capabilities Port
ESCD	Extended System Configuration Data
ECC	Error Checking and Correcting
EMC	Electromagnetic Compatibility
EPP	Enhanced Parallel Port
ESD	Electrostatic Discharge
FDD	Floppy Disk Device
FSB	Front Side Bus
HDD	Hard Disk Device
IDE	Integrated Dual Channel Enhanced
IRQ	Interrupt Request
I/O	Input / Output
IOAPIC	Input Output Advanced Programmable Input Controller
ISA	Industry Standard Architecture
LAN	Local Area Network

to be continued.....

Acronyms	Meaning
LBA	Logical Block Addressing
LED	Light Emitting Diode
MHz	Megahertz
MIDI	Musical Interface Digital Interface
MTH	Memory Translator Hub
MPT	Memory Protocol Translator
NIC	Network Interface Card
OS	Operating System
OEM	Original Equipment Manufacturer
PAC	PCI A.G.P. Controller
POST	Power-On Self Test
PCI	Peripheral Component Interconnect
RIMM	Rambus in-line Memory Module
SCI	Special Circumstance Instructions
SECC	Single Edge Contact Cartridge
SRAM	Static Random Access Memory
SMP	Symmetric Multi-Processing
SMI	System Management Interrupt
USB	Universal Serial Bus
VID	Voltage ID

Technical Support/RMA Sheet

Customer/Country:	Company:	Phone No.:
Contact Person:	E-mail Add. :	

Model name/Lot Number:	PCB revision:
BIOS version:	O.S./A.S.:

Hardware Configuration	Mfs.	Model name	Size:	Driver/Utility:
CPU				
Memory Brand				
Video Card				
Audio Card				
HDD				
CD-ROM / DVD-ROM				
Modem				
Network				
AMR / CNR				
Keyboard				
Mouse				
Power supply				
Other Device				

Problem Description:
