



When you installing AGP card, please make sure the following notice is fully understood and practiced. If your AGP card has "AGP 4X(1.5V) notch"(show below), please make sure your AGP card is AGP 4X(1.5V).



**Caution: AGP 2X(3.3V) card is not supported by VIA® KT333CF. You might experience system unable to boot up normally. Please insert an AGP 4X(1.5V) card**

Example 1: Diamond Vipper V770 golden finger is compatible with 2X/4X mode AGP slot. It can be switched between AGP 2X(3.3V) or 4X (1.5V) mode by adjusting the jumper. The factory default for this card is 2X(3.3V).

The GA-7VA-C (or any AGP 4X only) motherboards might not function properly, if you install this card without switching the jumper to 4X(1.5) mode in it.

Example 2: Some ATi Rage 128 Pro graphics cards made by "Power Color", the graphics card manufacturer & some SiS 305 cards, their golden finger is compatible with 2X(3.3V)/4X(1.5V) mode AGP slot, but they support 2X(3.3V) only. The GA-7VA-C (or any AGP 4X only) motherboards might not function properly, if you install this card in it.

Note : Although Gigabyte's AG32S(G) graphics card is based on ATi Rage 128 Pro chip, the design of AG32S(G) is compliance with AGP 4X(1.5V) specification. Therefore, AG32S (G) will work fine with VIA® KT333CF based motherboards.



- ⚠ The author assumes no responsibility for any errors or omissions that may appear in this document nor does the author make a commitment to update the information contained herein.
- ⚠ Third-party brands and names are the property of their respective owners.
- ⚠ Please do not remove any labels on motherboard, this may void the warranty of this motherboard.
- ⚠ Due to rapid change in technology, some of the specifications might be out of date before publication of this booklet.



**WARNING:** Never run the processor without the heatink properly and firmly attached. **PERMANENT DAMAGE WILL RESULT!**

**Mise en garde :** Ne faites jamais tourner le processeur sans que le dissipateur de chaleur soit fixé correctement et fermement. **UN DOMMAGE PERMANENT EN RÉSULTERA !**

**Achtung:** Der Prozessor darf nur in Betrieb genommen werden, wenn der Wärmeableiter ordnungsgemäß und fest angebracht ist. **DIES HAT EINEN PERMANENTEN SCHADEN ZUR FOLGE!**

**Advertencia:** Nunca haga funcionar el procesador sin el dissipador de calor instalado correctamente y firmemente. **SE PRODUCIRÁ UN DAÑO PERMANENTE!**

**Aviso:** Nunca execute o processador sem o dissipador de calor estar adequado e firmemente conectado. **O RESULTADO SERÁ UM DANO PERMANENTE!**

**警告:** 將處理器牢固地安裝到處理器上之前，不要運行處理器。否則將永遠損壞處理器！

**警告:** 將處理器牢固地安裝到處理器上之前，不要運行處理器。否則將永遠損壞處理器！

**경고:** 미드얼트를 제대로 조여지지 않을 때까지 프로세서를 사용하지 마십시오. 영구적 손상이 발생할 수 있습니다!

**警告:** 永久的な損傷を防ぐため、ヒートシンクを正しくしっかりと取り付けるまでは、プロセッサを動作させないようにしてください。

## Declaration of Conformity

We, Manufacturer/Importer  
(full address)

**G.B.T. Technology Trading GmbH**  
Ausschlag Weg 41, 1F, 20537 Hamburg, Germany

declare that the product  
( description of the apparatus, system, installation to which it refers)

### **Mother Board**

GA-7VA

is in conformity with

(reference to the specification under which conformity is declared)

in accordance with 89/336 EEC-EMC Directive

<input type="checkbox"/> EN 55011	Limits and methods of measurement of radio disturbance characteristics of industrial, scientific and medical (ISM) high frequency equipment	<input type="checkbox"/> EN 61000-3-2* <input checked="" type="checkbox"/> EN 60555-2	Disturbances in supply systems cause by household appliances and similar electrical equipment "Harmonics"
<input type="checkbox"/> EN 55013	Limits and methods of measurement of radio disturbance characteristics of broadcast receivers and associated equipment	<input type="checkbox"/> EN 61000-3-3* <input checked="" type="checkbox"/> EN 60555-3	Disturbances in supply systems cause by household appliances and similar electrical equipment "Voltage fluctuations"
<input type="checkbox"/> EN 55014	Limits and methods of measurement of radio disturbance characteristics of household electrical appliances, portable tools and similar electrical apparatus	<input checked="" type="checkbox"/> EN 50081-1 <input checked="" type="checkbox"/> EN 50082-1	Generic emission standard Part 1: Residual commercial and light industry  Generic immunity standard Part 1: Residual commercial and light industry
<input type="checkbox"/> EN 55015	Limits and methods of measurement of radio disturbance characteristics of fluorescent lamps and luminaries	<input type="checkbox"/> EN 55081-2	Generic emission standard Part 2: Industrial environment
<input type="checkbox"/> EN 55020	Immunity from radio interference of broadcast receivers and associated equipment	<input type="checkbox"/> EN 55082-2	Generic emission standard Part 2: Industrial environment
<input checked="" type="checkbox"/> EN 55022	Limits and methods of measurement of radio disturbance characteristics of information technology equipment	<input type="checkbox"/> ENV 55104	Immunity requirements for household appliances tools and similar apparatus
<input type="checkbox"/> DIN VDE 0 855 <input type="checkbox"/> part 10 <input type="checkbox"/> part 12	Cabled distribution systems; Equipment for receiving and/or <b>distribution</b> from sound and television signals	<input type="checkbox"/> EN 50091-2	EMC requirements for uninterruptible power systems (UPS)
<input checked="" type="checkbox"/> CE marking			(EC conformity marking)

The manufacturer also declares the conformity of above mentioned product  
with the actual required safety standards in accordance with LVD 73/23 EEC

<input type="checkbox"/> EN 60065	Safety requirements for mains operated electronic and related apparatus for household and similar general use	<input type="checkbox"/> EN 60950	Safety for information technology equipment including electrical business equipment
<input type="checkbox"/> EN 60335	Safety of household and similar electrical appliances	<input type="checkbox"/> EN 50091-1	General and Safety requirements for uninterruptible power systems (UPS)

Manufacturer/Importer

Date : November 4, 2002

Signature:

Name:

*Timmy Huang*

Timmy Huang

## DECLARATION OF CONFORMITY

Per FCC Part 2 Section 2.1077(a)



**Responsible PartName:** G.B.T. INC. (U.S.A.)

**Address:** 17358 Railroad Street  
City of Industry, CA 91748

**Phone/FaxNo:** (818) 854-9338/ (818) 854-9339

hereby declares that the product

**Product Name:** Motherboard

**Model Number:** GA-7VA

Conforms to the following specifications:

FCC Part 15, Subpart B, Section 15.107(a) and Section 15.109  
(a), Class B Digital Device

### **Supplementary Information:**

This device complies with part 15 of the FCC Rules. Operation is subject to the following two conditions: (1) This device may not cause harmful and (2) this device must accept any interference received, including that may cause undesired operation.

Representative Person's Name: ERIC LU

Signature: Eric Lu

Date: November 4, 2002

GA-7VA-C  
AMD Socket A Processor Motherboard

# USER'S MANUAL

AMD Athlon™/Athlon™ XP/Duron™ SocketA Processor Motherboard

Rev. 1001

12ME-7VAC-1001

## Table of Content

Item Checklist .....	4
WARNING! .....	4
Chapter 1 Introduction .....	5
Features Summary .....	5
GA-7VA-C Motherboard Layout .....	7
Chapter 2 Hardware Installation Process .....	8
Step 1: Install the Central Processing Unit (CPU) .....	9
Step1-1: CPU Speed Setup .....	9
Step1-2: CPU Installation .....	10
Step1-3: CPU Heat Sink Installation .....	11
Step 2: Install memory modules .....	12
Step 3: Install expansion cards .....	13
Step 4: Connect ribbon cables, cabinet wires, and power supply .....	14
Step4-1: I/O Back Panel Introduction .....	14
Step4-2: Connectors Introduction .....	16
Chapter 3 BIOS Setup .....	23
The Main Menu (For example: BIOS Ver. :F6) .....	24
Standard CMOS Features .....	26
Advanced BIOS Features .....	29
Integrated Peripherals .....	31

Power Management Setup .....	35
PnP/PCI Configurations .....	38
PC Health Status .....	39
Frequency/Voltage Control .....	41
Top Performance .....	43
Load Fail-Safe Defaults .....	44
Load Optimized Defaults .....	45
Set Supervisor/User Password .....	46
Save & Exit Setup .....	47
Exit Without Saving .....	48
Chapter 4 Technical Reference .....	51
Block Diagram .....	51
BIOS Flash Procedure .....	52
@ BIOS Introduction .....	67
Easy Tune™ 4 Introduction .....	68
2-/4-/6-Channel Audio Function Introduction .....	69
Chapter 5 Appendix .....	77

## Item Checklist

- |   |  |
|---|--|
| <input checked="" type="checkbox"/> The GA-7VA-C motherboard                        | <input checked="" type="checkbox"/> 2 Port USB Cable x 1 |
| <input checked="" type="checkbox"/> IDE cable x 2/ Floppy cable x 1                 | <input type="checkbox"/> 4 Port USB Cable x 1            |
| <input checked="" type="checkbox"/> Motherboard Settings Label                      | <input type="checkbox"/> Audio combo Kit x1              |
| <input checked="" type="checkbox"/> GA-7VA-C user's manual                          | <input type="checkbox"/> IEEE 1394 Cable x1              |
| <input type="checkbox"/> RAID Manual  | <input type="checkbox"/> SPDIF KIT x1 (SPD Kit)          |
| <input checked="" type="checkbox"/> CD for motherboard driver & utility (Driver CD) | <input type="checkbox"/> I/O Shield                      |
| <input checked="" type="checkbox"/> Quick PC Installation Guide                     |  |



### WARNING!

Computer motherboards and expansion cards contain very delicate Integrated Circuit (IC) chips. To protect them against damage from static electricity, you should follow some precautions whenever you work on your computer.

1. Unplug your computer when working on the inside.
2. Use a grounded wrist strap before handling computer components. If you do not have one, touch both of your hands to a safely grounded object or to a metal object, such as the power supply case.
3. Hold components by the edges and try not to touch the IC chips, leads or connectors, or other components.
4. Place components on a grounded antistatic pad or on the bag that came with the components whenever the components are separated from the system.
5. Ensure that the ATX power supply is switched off before you plug in or remove the ATX power connector on the motherboard.

### Installing the motherboard to the chassis...

If the motherboard has mounting holes, but they don't line up with the holes on the base and there are no slots to attach the spacers, do not become alarmed you can still attach the spacers to the mounting holes. Just cut the bottom portion of the spacers (the spacer may be a little hard to cut off, so be careful of your hands). In this way you can still attach the motherboard to the base without worrying about short circuits. Sometimes you may need to use the plastic springs to isolate the screw from the motherboard PCB surface, because the circuit wire may be near by the hole. Be careful, don't let the screw contact any printed circuit wire or parts on the PCB that are near the fixing hole, otherwise it may damage the board or cause board malfunctioning.



## Chapter 1 Introduction

### Features Summary

Form Factor	<ul style="list-style-type: none"> <li>• 29.3cm x 20.0cm ATX size form factor, 4 layers PCB.</li> </ul>
CPU	<ul style="list-style-type: none"> <li>• Socket A processor</li> <li>• AMD Athlon™/Athlon™ XP/ Duron™ (K7)</li> <li>• 128K L1 &amp; 256K/64K L2 cache on die</li> <li>• 200/266/333<sup>&lt;Note 1&gt;</sup> MHz FSB and DDR bus speeds</li> <li>• Supports 1.4GHz and faster</li> </ul>
Chipset	<ul style="list-style-type: none"> <li>• VIA KT333CF Memory/AGP/PCI Controller (PAC)</li> <li>• VIA VT8235 Integrated Peripheral Controller (PSIPC)</li> </ul>
Memory	<ul style="list-style-type: none"> <li>• 3 184-pin DDR sockets</li> <li>• Supports DDR DRAM PC1600/PC2100/PC2700/PC3200<sup>&lt;Note 2&gt;</sup></li> <li>• Supports up to 3.0GB DDR (Max)</li> <li>• Supports only 2.5V DDR DIMM</li> </ul>
I/O Control	<ul style="list-style-type: none"> <li>• I78705</li> </ul>
Slots	<ul style="list-style-type: none"> <li>• 1 AGP slot supports 4X/2X mode (1.5V) &amp; AGP 2.0 Compliant</li> <li>• 5 PCI slots supports 33MHz &amp; PCI 2.2 compliant</li> </ul>
On-Board IDE	<ul style="list-style-type: none"> <li>• 2 IDE controllers provides IDE HDD/CD-ROM (IDE1, IDE2) with PIO, Bus Master (Ultra DMA33/ATA66/ATA100/ATA133) operation modes.</li> </ul>
On-Board Peripherals	<ul style="list-style-type: none"> <li>• 1 Floppy port supports 2 FDD with 360K, 720K, 1.2M, 1.44M and 2.88M bytes.</li> <li>• 1 Parallel port supports Normal/EPP/ECP mode</li> <li>• 2 Serial port (COMA &amp; COMB)</li> <li>• 6 x USB 2.0/1.1 (4 by cable)</li> </ul>
Hardware Monitor	<ul style="list-style-type: none"> <li>• CPU/System Fan Revolution detect</li> <li>• CPU/System temperature detect</li> <li>• System Voltage Detect</li> <li>• Thermal shutdown function</li> </ul>

to be continued.....

<Note 1> FSB333 MHz only support DDR333 DIMM module.

<Note 2> PC3200 only support by Micro, Samsung, Apacer DDR module as we verified, more detail pls refer to P.85

On-Board Sound	<ul style="list-style-type: none"> <li>• Realtek ALC650 CODEC</li> <li>• Line Out / 2 front speaker</li> <li>• Line In / 2 rear speaker (by s/w switch)</li> <li>• Mic In / center &amp; subwoofer (by s/w switch)</li> <li>• SPDIF Out / SPDIF In</li> <li>• CD In / AUX In / Game port</li> </ul>
On-Board USB 2.0	<ul style="list-style-type: none"> <li>• Built in VIA VT8235 Chipset</li> </ul>
PS/2 Connector	<ul style="list-style-type: none"> <li>• PS/2 Keyboard interface and PS/2 Mouse interface</li> </ul>
BIOS	<ul style="list-style-type: none"> <li>• Licensed Award BIOS, 2M bit flash ROM</li> <li>• Supports Q-Flash</li> </ul>
Additional Features	<ul style="list-style-type: none"> <li>• PS/2 Keyboard power on by password, PS/2 Mouse power on</li> <li>• External Modem wake up</li> <li>• STR (Suspend-To-RAM)</li> <li>• Wake on LAN (WOL)</li> <li>• AC Recovery</li> <li>• Poly fuse for keyboard over-current protection</li> <li>• USB KB/Mouse wake up from S3</li> <li>• Supports @BIOS</li> <li>• Supports EasyTune 4</li> </ul>
Overclocking	<ul style="list-style-type: none"> <li>• Over Voltage (DDR/AGP/CPU) by BIOS</li> <li>• Over Clock (DDR/AGP/CPU/PC) by BIOS</li> </ul>



Please set the CPU host frequency in accordance with your processor's specifications. We don't recommend you to set the system bus frequency over the CPU's specification because these specific bus frequencies are not the standard specifications for CPU, chipset and most of the peripherals. Whether your system can run under these specific bus frequencies properly will depend on your hardware configurations, including CPU, Chipsets, SDRAM, Cards... etc.

## GA-7VA-C Motherboard Layout

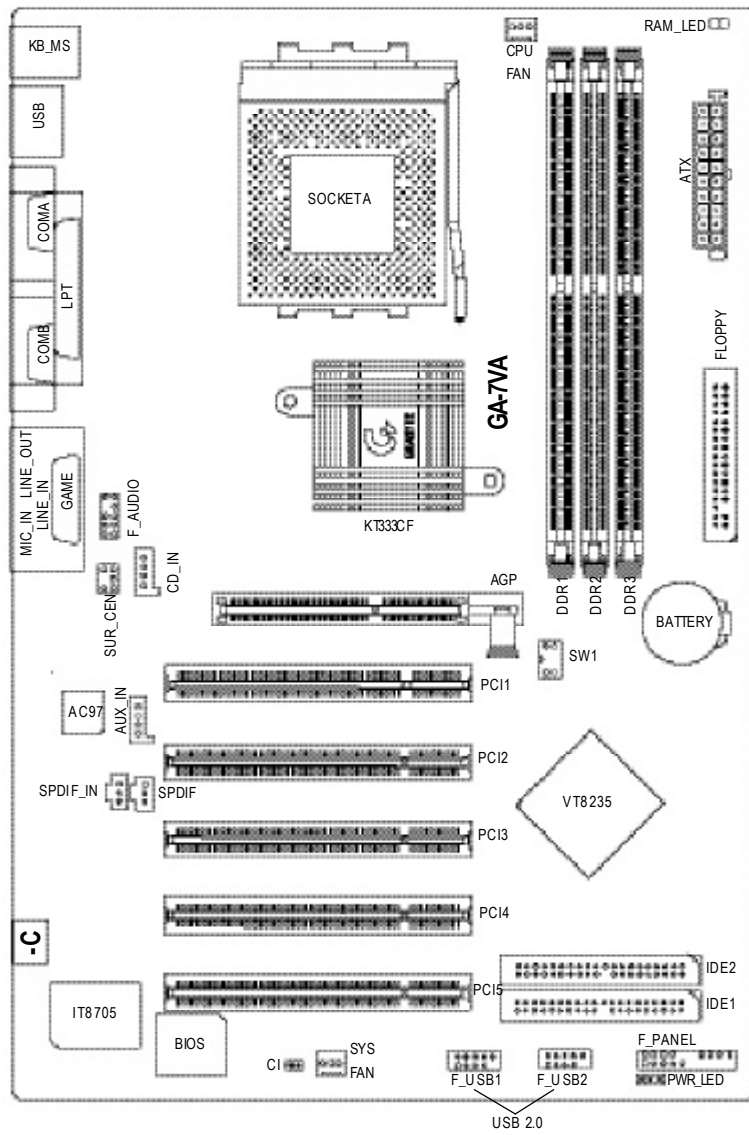

English

## Chapter 2 Hardware Installation Process

To set up your computer, you must complete the following steps:

- Step 1- Set Dip Switch (CK\_RATIO) and system Switch (SW1)
- Step 2- Install the Central Processing Unit (CPU)
- Step 3- Install memory modules
- Step 4- Install expansion cards
- Step 5- Connect ribbon cables, cabinet wires, and power supply
- Step 6- Setup BIOS software
- Step 7- Install supporting software tools

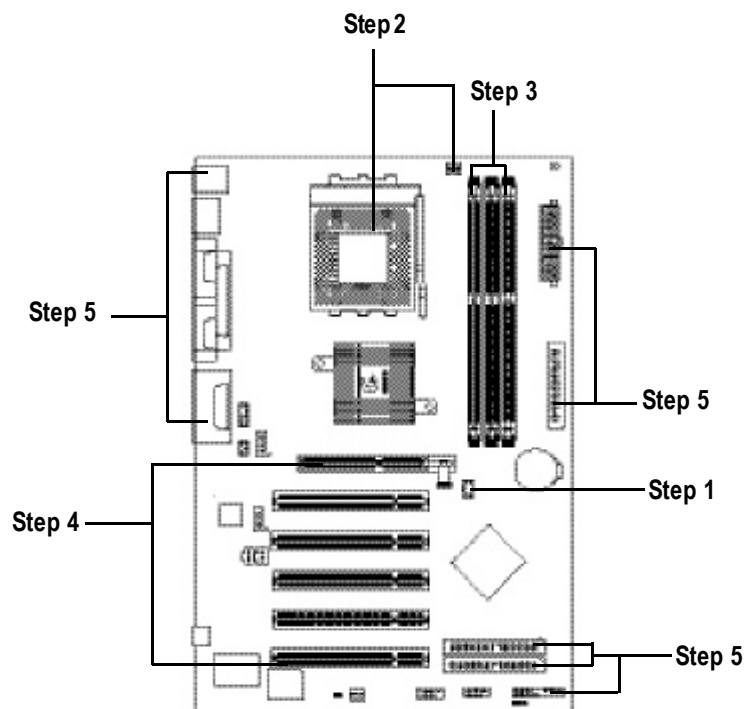

## Step 1: Install the Central Processing Unit (CPU)

### Step1-1: CPU Speed Setup

The system bus frequency can be switched at 100/133/166MHz by adjusting system switch (SW1).  
 (The internal frequency depend on CPU.)

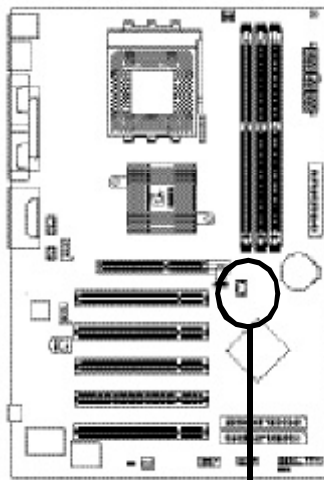

O: ON / X :OFF

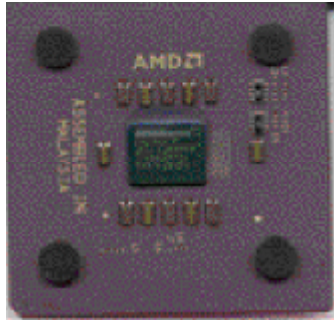

SW1	CPU CLOCK		
	100MHz	133MHz	166MHz
1	ON	OFF	OFF
2	OFF	OFF	ON

**Step1-2: CPU Installation**

CPU Top View

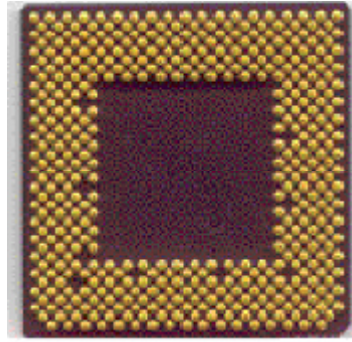

CPU Bottom View

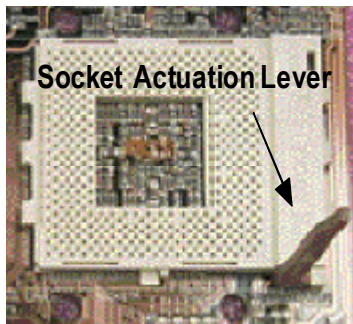

1. Pull up the CPU socket lever and up to 90-degree angle.

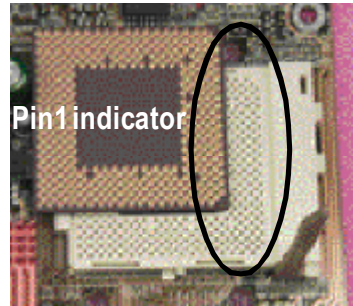

2. Locate Pin 1 in the socket and look for a (golden) cut edge on the CPU upper corner. Then insert the CPU into the socket.

- Please make sure the CPU type is supported by the motherboard.
- If you do not match the CPU socket Pin 1 and CPU cut edge well, it will cause improper installation. Please change the insert orientation.

### Step1-3:CPU Heat Sink Installation

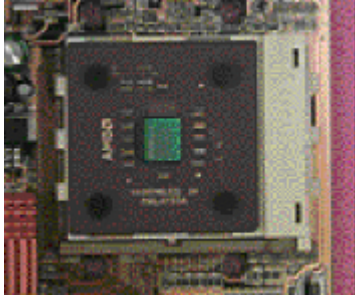

1. Press down the CPU socket lever and finish CPU installation.



2. Use qualified fan approved by AMD.

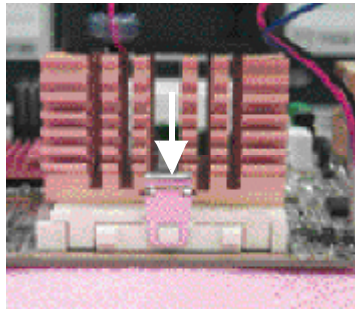

3. Fasten the heatsink supporting-base onto the CPU socket on the main-board.

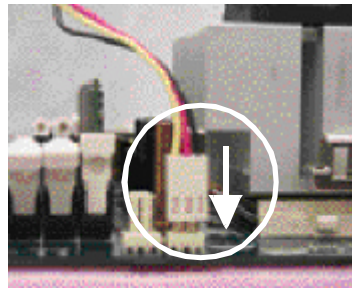

4. Make sure the CPU fan is plugged to the CPU fan connector, then install complete.

- Please use AMD approved cooling fan.
- We recommend you to apply the thermal paste to provide better heat conduction between your CPU and heatsink.
- Make sure the CPU fan power cable is plugged in to the CPU fan connector, this completes the installation.
- Please refer to CPU heat sink user's manual for more detail installation procedure.

## Step 2: Install memory modules

The motherboard has 3 dual inline memory module (DIMM) sockets. The BIOS will automatically detect memory type and size. To install the memory module, just push it vertically into the DIMM Slot.

The DIMM module can only fit in one direction due to the notch. Memory size can vary between sockets.

### Total Memory Sizes With Unbuffered DDR DIMM

Devices used on DIMM	1 DIMMx64/x72	2 DIMMsx64/x72	3 DIMMsx64/x72
64 Mbit (2Mx8x4 banks)	128 MBytes	256 MBytes	384 MBytes
64 Mbit (1Mx16x4 banks)	64 MBytes	128 MBytes	192 MBytes
128 Mbit (4Mx8x4 banks)	256 MBytes	512 MBytes	768 MBytes
128 Mbit (2Mx16x4 banks)	128 MBytes	256 MBytes	384 MBytes
256 Mbit (8Mx8x4 banks)	512 MBytes	1 GBytes	1.5 GBytes
256 Mbit (4Mx16x4 banks)	256 MBytes	512 MBytes	768 MBytes
512 Mbit (16Mx8x4 banks)	1 GBytes	2 GBytes	3 GBytes
512 Mbit (8Mx16x4 banks)	512 MBytes	1 GBytes	1.5 GBytes



DDR

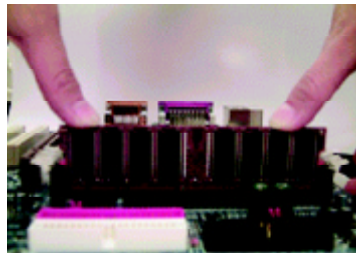

1. The DIMM slot has a notch, so the DIMM memory module can only fit in one direction.
  2. Insert the DIMM memory module vertically into the DIMM slot. Then push it down.
  3. Close the plastic clip at both edges of the DIMM slots to lock the DIMM module.
- ☛ Reverse the installation steps when you wish to remove the DIMM module.

- ☛ When DIMM LED is ON, do not install/remove DIMM from socket.
- ☛ Please note that the DIMM module can only fit in one direction due to the one notches. Wrong orientation will cause improper installation. Please change the insert orientation.



### DDR Introduction

Established on the existing SDRAM industry infrastructure, DDR (Double Data Rate) memory is a high performance and cost-effective solution that allows easy adoption for memory vendors, OEMs and system integrators.

DDR memory is a sensible evolutionary solution for the PC industry that builds on the existing SDRAM infrastructure, yet makes awesome advances in solving the system performance bottleneck by doubling the memory bandwidth. DDR SDRAM will offer a superior solution and migration path from existing SDRAM designs due to its availability, pricing and overall market support. PC2100 DDR memory (DDR266) doubles the data rate through reading and writing at both the rising and falling edge of the clock, achieving data bandwidth 2X greater than PC133 when running with the same DRAM clock frequency. With peak bandwidth of 2.664GB per second, DDR memory enables system OEMs to build high performance and low latency DRAM subsystems that are suitable for servers, workstations, high-end PC's and value desktop SMA systems. With a core voltage of only 2.5 Volts compared to conventional SDRAM's 3.3 volts, DDR memory is a compelling solution for small form factor desktops and notebook applications.

### Step 3: Install expansion cards

1. Read the related expansion card's instruction document before install the expansion card into the computer.
2. Remove your computer's chassis cover, necessary screws and slot bracket from the computer.
3. Press the expansion card firmly into expansion slot in motherboard.
4. Be sure the metal contacts on the card are indeed seated in the slot.
5. Replace the screw to secure the slot bracket of the expansion card.
6. Replace your computer's chassis cover.
7. Power on the computer, if necessary, setup BIOS utility of expansion card from BIOS.
8. Install related driver from the operating system.

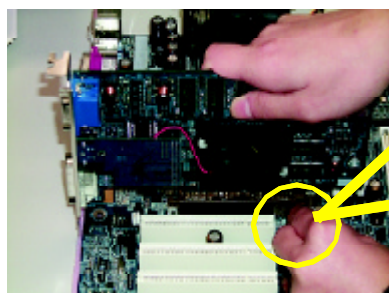

AGP Card

Please carefully pull out the small white-drawable bar at the end of the AGP slot when you try to install/ Uninstall the AGP card. Please align the AGP card to the onboard AGP slot and press firmly down on the slot. Make sure your AGP card is locked by the small white-drawable bar.

## Step 4: Connect ribbon cables, cabinet wires, and power supply

### Step4-1 : I/O Back Panel Introduction

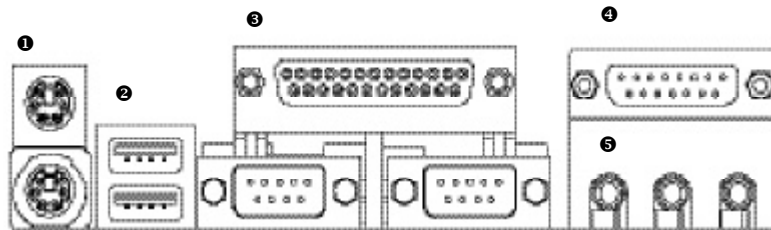

#### ❶ PS/2 Keyboard and PS/2 Mouse Connector

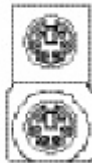

PS/2 Mouse Connector  
(6 pin Female)

PS/2 Keyboard Connector  
(6 pin Female)

➤ This connector supports standard PS/2 keyboard and PS/2 mouse.

#### ❷ USB Connector

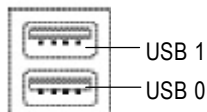

➤ Before you connect your device(s) into USB connector(s), please make sure your device(s) such as USB keyboard, mouse, scanner, zip, speaker..etc. Have a standard USB interface. Also make sure your OS supports USB controller. If your OS does not support USB controller, please contact OS vendor for possible patch or driver upgrade. For more information please contact your OS or device(s) vendors.

**③ Parallel Port ,VGA port and Serial Ports (COMA)**

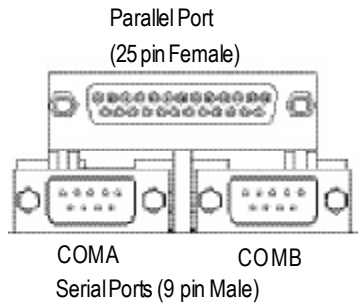

➤ This connector supports 2 standard COM ports and 1 Parallel port. Device like printer can be connected to Parallel port; mouse and modem etc can be connected to Serial ports.

**④ Game /MIDI Ports**

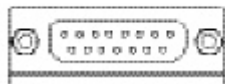

Joystick/ MIDI (15 pin Female)

➤ This connector supports joystick, MIDI keyboard and other relate audio devices.

**⑤ Audio Connectors**

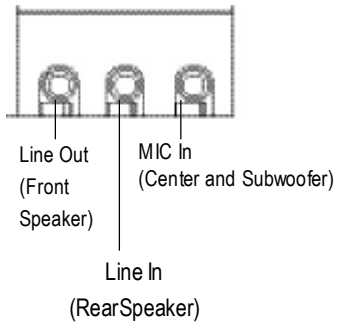

➤ After install onboard audio driver, you may connect speaker to Line Outjack, micro phone to MIC In jack. Device like CD-ROM , walkman etc can be connected to Line-In jack.

Please note:

You are able to use 2-/4-/6- channel audio feature by S/W selection.

If you want to enable 6-channel function, you have 2 choose for hardware connection.

**Method1:**

Connect "Front Speaker" to "Line Out"

Connect "Rear Speaker" to "Line In"

Connect "Center and Subwooferr" to "MIC Out".

**Method2:**

You can refer to page20, and contact your nearest dealer for optional SUR\_CEN cable.



*If you want the detail information for 2-/4-/6-channel audio setup installation, please refer to "2-/4-/6-Channel Audio Function Introduction"*

## Step4-2: Connectors Introduction

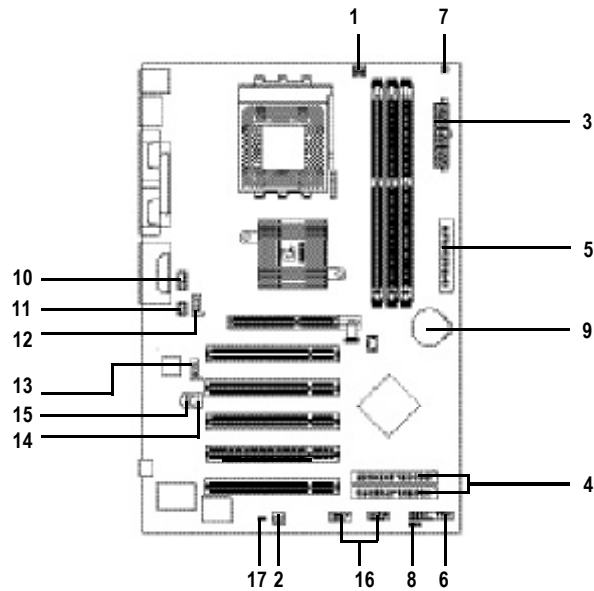

1) CPU_FAN	10) F_AUDIO
2) SYS_FAN	11) SUR_CEN
3) ATX_POWER	12) CD_IN
4) IDE1/IDE2	13) AUX_IN
5) FDD	14) SPDIF
6) RAM_LED	15) SPDIF-IN
7) PWR_LED	16) F_USB1/F_USB2
8) F_PANEL	17) CI
9) BATTERY	

**1)CPU\_FAN (CPU FAN Connector)**

➤ Please note, a proper installation of the CPU cooler is essential to prevent the CPU from running under abnormal condition or damaged by overheating. The CPU fan connector supports Max. current up to 600 mA.

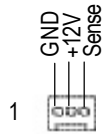

**2)SYS\_FAN (System FAN Connector)**

➤ This connector allows you to link with the cooling fan on the system case to lower the system temperature.

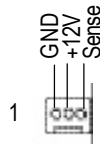

**3)ATX\_POWER (ATX Power)**

➤ AC power cord should only be connected to your power supply unit after ATX power cable and other related devices are firmly connected to the mainboard.

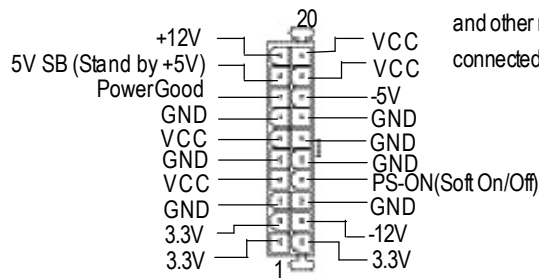

4) IDE1/ IDE2 (IDE1/IDE2 Connector)

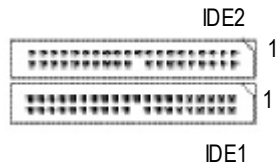

- Important Notice:  
Please connect first harddisk to IDE1 and connect CDROM to IDE2.  
The red stripe of the ribbon cable must be the same side with the Pin1.

5) FDD (Floppy Connector)

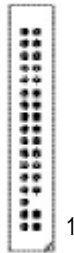

- Please connect the floppy drive ribbon cables to FDD. It supports 360K, 720K, 1.2M, 1.44M and 2.88Mbytes floppy disk types.  
The red stripe of the ribbon cable must be the same side with the Pin1.

6) RAM\_LED



- Do not remove memory modules while DIMM LED is on. It might cause short or other unexpected damages due to the 2.5V stand by voltage. Remove memory modules only when AC Power cord is disconnected.

7) PWR\_LED

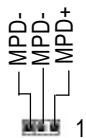

- PWR\_LED is connect with the system power indicator to indicate whether the system is on/off. It will blink when the system enters suspend mode.  
If you use dual color LED, power LED will turn to another color.

**8)F\_PANEL (2x10 pins connector)**

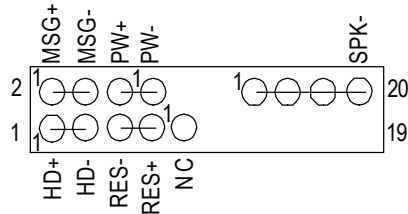

HD (IDE Hard Disk Active LED) (Blue)	Pin 1: LED anode(+) Pin 2: LED cathode(-)
SPK (Speaker Connector) (Amber)	Pin 1: VCC(+) Pin 2- Pin 3: NC Pin 4: Data(-)
RES (Reset Switch) (Green)	Open: Normal Operation Close: Reset Hardware System
PW (Soft Power Connector) (Red)	Open: Normal Operation Close: Power On/Off
MSG(Message LED/Power/ Sleep LED)(Yellow)	Pin 1: LED anode(+) Pin 2: LED cathode(-)
NC( Purple)	NC

➤ Please connect the power LED, PC speaker, reset switch and power switch etc of your chassis front panel to the F\_PANEL connector according to the pin assignment above.

**9) BATTERY (Battery)**

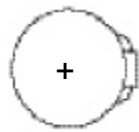

**CAUTION**

- ❖ Danger of explosion if battery is incorrectly replaced.
- ❖ Replace only with the same or equivalent type recommended by the manufacturer.
- ❖ Dispose of used batteries according to the manufacturer's instructions.

If you want to erase CMOS...

1. Turn OFF the computer and unplug the power cord.
2. Remove the battery, wait for 30 second.
3. Re-install the battery.
4. Plug the power cord and turn ON the computer.

**10) F\_AUDIO (F\_AUDIO Connector)**

- If you want to use Front Audio connector, you must remove 5-6, 9-10 Jumper.
- In order to utilize the front audio header, your chassis must have front audio connector. Also please make sure the pin assignment on the cable is the same as the pin assignment on the MB header. To find out if the chassis you are buying support front audio connector, please contact your dealer.

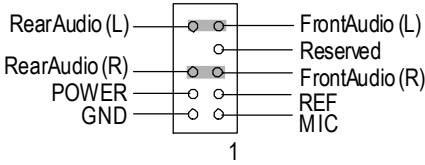

**11) SUR\_CEN**

- Please contact your nearest dealer for optional SUR\_CEN cable.

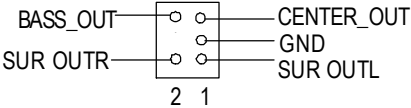

**12) CD\_IN (CD IN)**

- Connect CD-ROM or DVD-ROM audio out to the connector.

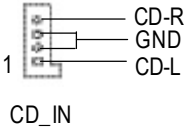

**13) AUX\_IN (AUX In Connector)**

- Connect other device (such as PC/TV Tuner audio out) to the connector.

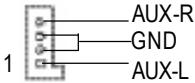

**14) SPDIF (SPDIF Out)**

- The SPDIF output is capable of providing digital audio to external speakers or compressed AC3 data to an external Dolby Digital Decoder. Use this feature only when your stereo system has digital input function.

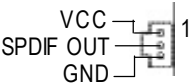



**15) SPDIF\_IN**

- Use this feature only when your device has digital output function.

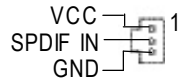

**16) F\_USB1 / F\_USB2  
(Front USB Connector, Yellow)**

- Be careful with the polarity of the front USB connector. Check the pin assignment while you connect the front USB cable. Please contact your nearest dealer for optional front USB cable.

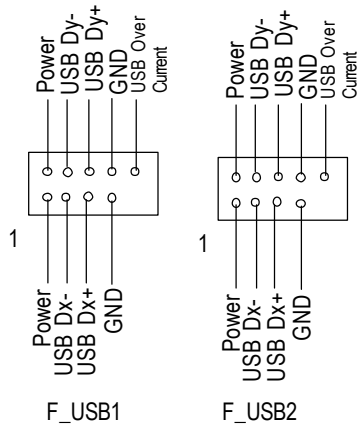

**17) CI (CASE OPEN)**

- This 2 pin connector allows your system to enable or disable the "case open" item in BIOS if the system case begin remove.

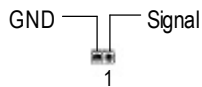



## BIOS Setup

BIOS Setup is an overview of the BIOS Setup Program. The program that allows users to modify the basic system configuration. This type of information is stored in battery-backed CMOS RAM so that it retains the Setup information when the power is turned off.

### ENTERING SETUP

After power on the computer, pressing <Del> immediately during POST (Power On Self Test) it will allow you to enter standard BIOS CMOS SETUP.

If you require more advanced BIOS settings, please go to "advanced BIOS" setting menu. To enter Advanced BIOS setting menu, press "Ctrl+F1" key on the BIOS screen.

### CONTROL KEYS

<↑>	Move to previous item
<↓>	Move to next item
<←>	Move to the item in the left hand
<→>	Move to the item in the right hand
<Esc>	Main Menu - Quit and not save changes into CMOS Status Page Setup Menu and Option Page Setup Menu - Exit current page and return to Main Menu
<+/PgUp>	Increase the numeric value or make changes
<-/PgDn>	Decrease the numeric value or make changes
<F1>	General help, only for Status Page Setup Menu and Option Page Setup Menu
<F2>	Item help
<F3>	Reserved
<F4>	Reserved
<F5>	Restore the previous CMOS value from CMOS, only for Option Page Setup Menu
<F6>	Load the default CMOS value from BIOS default table, only for Option Page Setup Menu
<F7>	Load the Setup Defaults
<F8>	Q-Flash
<F9>	Reserved
<F10>	Save all the CMOS changes, only for Main Menu

**GETTING HELP**

**Main Menu**

The on-line description of the highlighted setup function is displayed at the bottom of the screen.

**Status Page Setup Menu / Option Page Setup Menu**

Press F1 to pop up a small help window that describes the appropriate keys to use and the possible selections for the highlighted item. To exit the Help Window press <Esc>.

**The Main Menu (For example: BIOS Ver. : F6)**

Once you enter Award BIOS CMOS Setup Utility, the Main Menu (Figure 1) will appear on the screen. The Main Menu allows you to select from eight setup functions and two exit choices. Use arrow keys to select among the items and press <Enter> to accept or enter the sub-menu.

CMOS Setup Utility - Copyright (C) 1984-2002 Award Software

<ul style="list-style-type: none"> <li>▶ Standard CMOS Features</li> <li>▶ Advanced BIOS Features</li> <li>▶ Integrated Peripherals</li> <li>▶ Power Management Setup</li> <li>▶ PnP/PCI Configurations</li> <li>▶ PC Health Status</li> <li>▶ Frequency/Voltage Control</li> </ul>	<ul style="list-style-type: none"> <li>Top Performance</li> <li>Load Fail-Safe Defaults</li> <li>Load Optimized Defaults</li> <li>Set Supervisor Password</li> <li>Set User Password</li> <li>Save &amp; Exit Setup</li> <li>Exit Without Saving</li> </ul>
ESC:Quit	
↑ ↓ → ← : Select Item	
F8: Q-Flash	
F10: Save & Exit Setup	
Time, Date, Hard Disk Type...	

Figure 1: Main Menu



**If you can't find the setting you want, please press "Ctrl+F1" to search the advanced option widden.**

- **Standard CMOS Features**  
This setup page includes all the items in standard compatible BIOS.
- **Advanced BIOS Features**  
This setup page includes all the items of Award special enhanced features.
- **Integrated Peripherals**  
This setup page includes all onboard peripherals.

- **Power Management Setup**  
This setup page includes all the items of Green function features.
- **PnP/PCI Configurations**  
This setup page includes all the configurations of PCI & PnP ISA resources.
- **PC Health Status**  
This setup page is the System auto detect Temperature, voltage, fan, speed.
- **Frequency/Voltage Control**  
This setup page is control CPU's clock and frequency ratio.
- **Top Performance**  
Top Performance Defaults indicates the value of the system parameters which the system would be in best performance configuration.
- **Load Fail-Safe Defaults**  
Fail-Safe Defaults indicates the value of the system parameters which the system would be in safe configuration.
- **Load Optimized Defaults**  
Optimized Defaults indicates the value of the system parameters which the system would be in better performance configuration.
- **Set Supervisor password**  
Change, set, or disable password. It allows you to limit access to the system and Setup, or just to Setup.
- **Set User password**  
Change, set, or disable password. It allows you to limit access to the system.
- **Save & Exit Setup**  
Save CMOS value settings to CMOS and exit setup.
- **Exit Without Saving**  
Abandon all CMOS value changes and exit setup.

## Standard CMOS Features

CMOS Setup Utility - Copyright (C) 1984-2002 Award Software

Standard CMOS Features		Item Help
Date(mm:dd:yy)	Thu, Feb 21 2002	Menu Level ►
Time(hh:mm:ss)	22:31:24	Change the day, month, year
► IDE Primary Master	[Press Enter None]	<Week>
► IDE Primary Slave	[Press Enter None]	Sun. to Sat.
► IDE Secondary Master	[Press Enter None]	<Month>
► IDE Secondary Slave	[Press Enter None]	Jan. to Dec.
Drive A	[1.44M, 3.5"]	<Day>
Drive B	[None]	1 to 31 (or maximum allowed in the month.)
Floppy 3 Mode Support	[Disabled]	<year>
Halt On	[All, But Keyboard]	1999 to 2098
Base Memory	640K	
Extended Memory	130048K	
Total Memory	131072K	
↑↓→←: Move Enter: Select +/-/PU/PD: Value F10: Save ESC: Exit F1: General Help F5: Previous Values F6: Fail-Safe Defaults F7: Optimized Defaults		

Figure 2: Standard CMOS Features

### ☞ Date

The date format is <week>, <month>, <day>, <year>.

- Week The week, from Sun to Sat, determined by the BIOS and is display only
- Month The month, Jan. Through Dec.
- Day The day, from 1 to 31 (or the maximum allowed in the month)
- Year The year, from 1999 through 2098

### ☞ Time

The times format in <hour> <minute> <second>. The time is calculated base on the 24-hour military-time clock. For example, 1 p.m. is 13:00:00.

### ☞ IDE Primary Master, Slave / Secondary Master, Slave

The category identifies the types of hard disk from drive C to F that has been installed in the computer. There are two types: auto type, and manual type. Manual type is user-definable; Auto type which will automatically detect HDD type.

Note that the specifications of our drive must match with the drive table. The hard disk will not work properly if you enter improper information for this category.

If you select User Type, related information will be asked to enter to the following items. Enter the information directly from the keyboard and press <Enter>. Such information should be provided in the documentation from your hard disk vendor or the system manufacturer.

- ▶▶ Capacity: The hard disk size. The unit is Mega Bytes.
- ▶▶ Access Mode: The options are: Auto/ Large/ LBA/ Normal.
- ▶▶ Cylinder: The cylinder number of hard disk.
- ▶▶ Head: The read /Write head number of hard disk.
- ▶▶ Precomp: The cylinder number at which the disk driver changes the write current.
- ▶▶ Landing Zone: The cylinder number that the disk driver heads (read/write) are seated when the disk drive is parked.
- ▶▶ SECTORS: The sector number of each track define on the hard disk.

If a hard disk has not been installed select NONE and press <Enter>.

### ☞ Drive A / Drive B

The category identifies the types of floppy disk drive A or drive B that has been installed in the computer.

- ▶▶ None: No floppy drive installed
- ▶▶ 360K, 5.25": 5.25 inch PC-type standard drive; 360K byte capacity.
- ▶▶ 1.2M, 5.25": 5.25 inch AT-type high-density drive; 1.2M byte capacity (3.5 inch when 3 Mode is Enabled).
- ▶▶ 720K, 3.5": 3.5 inch double-sided drive; 720K byte capacity
- ▶▶ 1.44M, 3.5": 3.5 inch double-sided drive; 1.44M byte capacity.
- ▶▶ 2.88M, 3.5": 3.5 inch double-sided drive; 2.88M byte capacity.

### ☞ Floppy 3 Mode Support (for Japan Area)

- ▶▶ Disabled: Normal Floppy Drive. (Default value)
- ▶▶ Drive A: Enabled 3 mode function of Drive A.
- ▶▶ Drive B: Enabled 3 mode function of Drive B.
- ▶▶ Both: Drive A & Bare 3 mode Floppy Drives.

**Halt on**

The category determines whether the computer will stop if an error is detected during power up.

- ▶▶ NO Errors      The system boot will not stop for any error that may be detected and you will be prompted.
- ▶▶ All Errors      Whenever the BIOS detects a non-fatal error the system will be stopped.
- ▶▶ All, But Keyboard      The system boot will not stop for a keyboard error; it will stop for all other errors. (Default value)
- ▶▶ All, But Diskette      The system boot will not stop for a disk error; it will stop for all other errors.
- ▶▶ All, But Disk/Key      The system boot will not stop for a keyboard or disk error; it will stop for all other errors.

**Memory**

The category is display-only which is determined by POST (Power On Self Test) of the BIOS.

**Base Memory**

The POST of the BIOS will determine the amount of base (or conventional) memory installed in the system.

The value of the base memory is typically 512 K for systems with 512 K memory installed on the motherboard, or 640 K for systems with 640 K or more memory installed on the motherboard.

**Extended Memory**

The BIOS determines how much extended memory is present during the POST.

This is the amount of memory located above 1 MB in the CPU's memory address map.



## Advanced BIOS Features

CMOS Setup Utility - Copyright (C) 1984-2002 Award Software

### Advanced BIOS Features

First Boot Device	[Floppy]	Item Help
Second Boot Device	[HDD-0]	<b>Main</b>
Third Boot Device	[CDROM]	
Boot Up Floppy Seek	[Disabled]	
Password Check	[Setup]	
Init Display First	[AGP]	
↑↓→←: Move Enter: Select +/-/PU/PD: Value F10: Save ESC: Exit F1: General Help F5: Previous Values F6: Fail-Safe Defaults F7: Optimized Defaults		

Figure 3: Advanced BIOS Features

### ☞ **First / Second / Third Boot device**

🔍 This feature allows you to select the boot device priority.

- ▶▶ Floppy            Select your boot device priority by Floppy.
- ▶▶ LS120            Select your boot device priority by LS120.
- ▶▶ HDD-0~3        Select your boot device priority by HDD-0~3.
- ▶▶ SCSI             Select your boot device priority by SCSI.
- ▶▶ CDROM          Select your boot device priority by CDROM.
- ▶▶ LAN              Select your boot device priority by LAN.
- ▶▶ USB-CDROM    Select your boot device priority by USB-CDROM.
- ▶▶ USB-ZIP         Select your boot device priority by USB-ZIP.
- ▶▶ USB-FDD        Select your boot device priority by USB-FDD.
- ▶▶ USB-HDD        Select your boot device priority by USB-HDD.
- ▶▶ ZIP                Select your boot device priority by ZIP.
- ▶▶ Disabled        Disabled this function.

### ☞ **Boot Up Floppy Seek**

● During POST, BIOS will determine the floppy disk drive installed is 40 or 80 tracks. 360 K type is 40 tracks 720 K, 1.2 M and 1.44 M are all 80 tracks.

- ▶▶ Enabled BIOS searches for floppy disk drive to determine it is 40 or 80 tracks. Note that BIOS can not tell from 720 K, 1.2 M or 1.44 M drive type as they are all 80 tracks.
- ▶▶ Disabled BIOS will not search for the type of floppy disk drive by track number. Note that there will not be any warning message if the drive installed is 360 K.  
(Default value)

### ☞ **Password Check**

- ▶▶ System The system can not boot and can not access to Setup page will be denied if the correct password is not entered at the prompt.
- ▶▶ Setup The system will boot, but access to Setup will be denied if the correct password is not entered at the prompt. (Default value)

### ☞ **Init Display First**

● This feature allows you to select the first initiation of the monitor display from which card, when you install an AGP VGA card and a PCI VGA card on board.

- ▶▶ PCI Set Init Display First to PCI Slot.
- ▶▶ AGP Set Init Display First to AGP. (Default value)

## Integrated Peripherals

CMOS Setup Utility - Copyright (C) 1984-2002 Award Software

### Integrated Peripherals

OnChip IDE Channel0	[Enabled]	Item Help
OnChip IDE Channel1	[Enabled]	Menu Level▶
IDE1 Conductor Cable	[Auto]	
IDE2 Conductor Cable	[Auto]	
AC97 Audio	[Enabled]	
USB 1.1 Controller	[Enabled]	
USB 2.0 Controller	[Enabled]	
USB Keyboard Support	[Disabled]	
USB Mouse Support	[Disabled]	
Onboard Serial Port 1	[3F8/IRQ4]	
Onboard Serial Port 2	[2F8/IRQ3]	
Onboard Parallel Port	[378/IRQ7]	
Parallel Port Mode	[SPP]	
Game Port Address	[201]	
Midi Port Address	[330]	
Midi Port IRQ	[5]	
↑↓→←: Move Enter:Select +/-PU/PD:Value F10:Save ESC:Exit F1:General Help F5:Previous Values F6:Fail-Safe Defaults F7:Optimized Defaults		

Figure 4: Integrated Peripherals

#### ☞ **OnChip IDE Channel0**

●☞ When enabled, allows you to use the onboard primary PCI IDE. If a hard disk controller card is used, set at Disabled.

- ▶▶ Enabled Enable onboard 1st channel IDE port. (Default value)
- ▶▶ Disabled Disable onboard 1st channel IDE port.

#### ☞ **OnChip IDE Channel1**

●☞ When enabled, allows you to use the onboard secondary PCI IDE. If a hard disk controller card is used, set at Disabled.

- ▶▶ Enabled Enable onboard 2nd channel IDE port. (Default value)
- ▶▶ Disabled Disable onboard 2nd channel IDE port.

#### ☞ **IDE1 Conductor Cable**

- ▶▶ Auto Will be automatically detected by BIOS (Default Value)
- ▶▶ ATA66/100/133 Set IDE1 Conductor Cable to ATA66/100/133 (Please make sure your IDE device and cable is compatible with ATA66/100/133)
- ▶▶ ATA33 Set IDE1 Conductor Cable to ATA33 (Please make sure your IDE device and cable is compatible with ATA33)

#### ☞ **IDE2 Conductor Cable**

- ▶▶ Auto Will be automatically detected by BIOS (Default Value)
- ▶▶ ATA66/100/133 Set IDE2 Conductor Cable to ATA66/100/133 (Please make sure your IDE device and cable is compatible with ATA66/100/133)
- ▶▶ ATA33 Set IDE2 Conductor Cable to ATA33 (Please make sure your IDE device and cable is compatible with ATA33).

#### ☞ **AC97 Audio**

- ▶▶ Auto BIOS will automatically detect onboard AC97 Audio. (Default value)
- ▶▶ Disabled Disabled AC97 Audio.

#### ☞ **USB 1.1 Controller**

●☞ Disable this option if you are not using the onboard USB feature.

- ▶▶ Enabled Enabled USB Controller. (Default value)
- ▶▶ Disabled Disabled USB Controller.

### ☞ **USB 2.0 Controller**

● Disable this option if you are not using the onboard USB 2.0 feature.

- ▶▶ Enabled      Enabled USB 2.0 Controller. (Default value)
- ▶▶ Disabled      Disabled USB 2.0 Controller.

### ☞ **USB Keyboard Support**

● When a USB key board is installed, please set at Enabled.

- ▶▶ Enabled      Enabled USB Key board Support.
- ▶▶ Disabled      Disabled USB Key board Support. (Default value)

### ☞ **USB Mouse Support**

- ▶▶ Enabled      Enabled USB Mouse Support.
- ▶▶ Disabled      Disabled USB Mouse Support. (Default value)

### ☞ **Onboard Serial Port 1**

- ▶▶ Auto            BIOS will automatically setup the port 1 address.
- ▶▶ 3F8/IRQ4      Enable onboard Serial port 1 and address is 3F8, Using IRQ4. (Default value)
- ▶▶ 2F8/IRQ3      Enable onboard Serial port 1 and address is 2F8, Using IRQ3.
- ▶▶ 3E8/IRQ4      Enable onboard Serial port 1 and address is 3E8, Using IRQ4.
- ▶▶ 2E8/IRQ3      Enable onboard Serial port 1 and address is 2E8, Using IRQ3.
- ▶▶ Disabled      Disable onboard Serial port 1.

### ☞ **Onboard Serial Port 2**

- ▶▶ Auto            BIOS will automatically setup the port 2 address.
- ▶▶ 3F8/IRQ4      Enable onboard Serial port 2 and address is 3F8, Using IRQ4.
- ▶▶ 2F8/IRQ3      Enable onboard Serial port 2 and address is 2F8, Using IRQ3. (Default Value)
- ▶▶ 3E8/IRQ4      Enable onboard Serial port 2 and address is 3E8, Using IRQ4.
- ▶▶ 2E8/IRQ3      Enable onboard Serial port 2 and address is 2E8, Using IRQ3.
- ▶▶ Disabled      Disable onboard Serial port 2.

### ☞ **OnBoard Parallel port**

● This feature allows you to select from a given set of parameters if the parallel port uses the onboard I/O controller.

- ▶▶ 378/IRQ7      Enable onboard LPT port and address is 378, Using IRQ7. (Default Value)
- ▶▶ 278/IRQ5      Enable onboard LPT port and address is 278, Using IRQ5.

- ▶▶ 3BC/IRQ7 Enable onboard LPT port and address is 3BC, Using IRQ7.
- ▶▶ Disabled Disable onboard parallel port.

#### ☞ Parallel Port Mode

● This feature allows you to connect with an advanced print via the port mode it supports.

- ▶▶ SPP Using Parallel port as Standard Parallel Port using IRQ7. (Default Value)
- ▶▶ EPP Using Parallel port as Enhanced Parallel Port IRQ5.
- ▶▶ ECP Using Parallel port as Extended Capabilities Port using IRQ7.
- ▶▶ ECP+EPP Using Parallel port as ECP & EPP mode.

#### ☞ Game Port Address

- ▶▶ Disabled Disabled this function.
- ▶▶ 201 Set Game Port Address to 201. (Default Value)
- ▶▶ 209 Set Game Port Address to 209.

#### ☞ Midi Port Address

- ▶▶ Disabled Disabled this function.
- ▶▶ 300 Set Midi Port Address to 300.
- ▶▶ 330 Set Midi Port Address to 330. (Default Value)

#### ☞ Midi Port IRQ

- ▶▶ 5 Set 5 for Midi Port IRQ. (Default value)
- ▶▶ 10 Set 10 for Midi Port IRQ.

## Power Management Setup

CMOS Setup Utility - Copyright (C) 1984-2002 Award Software

### Power Management Setup

ACPI Suspend Type	[S1(POS)]	Item Help
× USB Device Wake-Up From S3	Disabled	Menu Level ▶
Power LED in S1 State	[Blinking]	
Soft-Off by PWRBTN	[Instant-off]	
AC Back Function	[Soft-Off]	
Keyboard Power On	[Disabled]	
Mouse Power On	[Disabled]	
PM Event Wake Up	[Enabled]	
Modem Ring On/Wake On LAN	[Enabled]	
Resume by Alarm	[Disabled]	
× Date (of Month) Alarm	Everyday	
× Time (hh:mm:ss) Alarm	0 : 0 : 0	
↑↓→←: Move Enter: Select +/- /PU/PD: Value F10: Save ESC: Exit F1: General Help F5: Previous Values F6: Fail-Safe Defaults F7: Optimized Defaults		

Figure 5: Power Management Setup

### ☞ ACPI Suspend Type

- ▶▶ S1(POS)      Setsuspend type to Power On Suspend under ACPI OS(Power On Suspend). (Default value)
- ▶▶ S3(STR)      Setsuspend type to Suspend To RAM under ACPI OS (Suspend To RAM).

### ☞ USB Device Wakeup From S3(When ACPI Suspend Type is set [S3(STR)])

USB device wakeup From S3 can be set when ACPI standby state set to S3/STR.

- ▶▶ Enabled      USB Device can wakeup system from S3.
- ▶▶ Disabled      USB Device can't wakeup system from S3. (Default value)

### ☞ Power LED in S1 State

- ▶▶ Blinking      In standby mode(S1), power LED will blink. (Default Value)
- ▶▶ Dual/Off      In standby mode(S1):
  - a. If use single color LED, power LED will turn off.
  - b. If use dual color LED, power LED will turn to another color.

### ☞ Soft-off by PWRBTN

- ▶▶ Instant-off      Press power button then Power off instantly. (Default value)
- ▶▶ Delay 4 Sec.      Press power button 4 sec to Power off. Enter suspend if button is pressed less than 4 sec.

### ☞ AC Back Function

- ▶▶ Memory      System power on depends on the status before AC lost.
- ▶▶ Soft-Off      Always in Off state when AC back. (Default value)
- ▶▶ Full-On      Always power on the system when AC back.

### ☞ Keyboard Power On

This feature allows you to set the method for powering-on the system.

The option "Password" allows you to set up to 8 alphanumeric characters to power-on the system.

The option "Any Key" allows you to touch the keyboard to power on the system.

The option "Keyboard 98" allows you to use the standard keyboard 98 to power on the system.

- ▶▶ Password      Enter from 1 to 8 characters to set the Keyboard Power On Password.
- ▶▶ Disabled      Disabled this function. (Default value)
- ▶▶ Keyboard 98      If your keyboard have "POWER Key" button, you can press the key to power on your system.



### ☞ Mouse Power On

- ▶ Disabled      Can't Power on system by Mouse Event (Default value)
- ▶ Enabled      Can Power on system by Mouse Event.

### ☞ PME Event Wake up

- When set at Enabled, any PCI-PM event awakes the system from a PCI-PM controlled state.
- This feature requires an ATX power supply that provides at least 1A on the +5VSB lead.
  - ▶ Disabled      Disabled PME Event Wake up function.
  - ▶ Enabled      Enabled PME Event Wake up function. (Default Value)

### ☞ Modem Ring On/ Wake On LAN (When AC Back Function is set to [Soft-Off])

- You can enable wake on LAN feature by the "Modem Ring On/Wake On LAN" or "PME Event Wake up" when the M/B has "WOL" onboard connector. Only enabled the feature by "PME Event Wake up".
- An incoming call via modem awakes the system from its soft-off mode.
- When set at Enabled, an input signal comes from the other client.
  - Server on the LAN awaks the system from a soft off state if connected over LAN.
  - ▶ Disabled      Disabled Modem Ring On / Wake On LAN function.
  - ▶ Enabled      Enabled Modem Ring On / Wake On LAN function. (Default Value)

### ☞ Resume by Alarm

You can set "Resume by Alarm" item to enabled and key in Date/time to power on system.

- ▶ Disabled      Disable this function. (Default Value)
- ▶ Enabled      Enable alarm function to POWER ON system.

If RTC Alarm Lead To Power On is Enabled.

Date (of Month) Alarm :      Everyday, 1-31  
 Time (hh:mm:ss) Alarm :      (0~23) : (0~59) : (0~59)

## PnP/PCI Configurations

CMOS Setup Utility - Copyright (C) 1984-2002 Award Software

### PnP/PCI Configurations

PCI1/PCI5 IRQ Assignment	[Auto]	Item Help
PCI2 IRQ Assignment	[Auto]	Menu Level▶
PCI3 IRQ Assignment	[Auto]	
PCI4 IRQ Assignment	[Auto]	
↑↓→←: Move Enter:Select+/-/PU/PD:Value F10:Save ESC:Exit F1:General Help F5:Previous Values F6:Fail-Safe Defaults F7:Optimized Defaults		

Figure 6: PnP/PCI Configurations

#### ☞ PCI1/PCI5 IRQ Assignment

- ▶▶ Auto ~~Auto assign IRQ to PCI1/PCI5.~~ (Default value)
- ▶▶ 3,4,5,7,9.,10,11,12,14,15 Set3,4,5,7,9,10,11,12,14,15 to PCI1/ PCI5.

#### ☞ PCI2 IRQ Assignment

- ▶▶ Auto Auto assign IRQ to PCI 2. (Default value)
- ▶▶ 3,4,5,7,9.,10,11,12,14,15 Set3,4,5,7,9,10,11,12,14,15 to PCI2.

#### ☞ PCI3 IRQ Assignment

- ▶▶ Auto Auto assign IRQ to PCI 3. (Default value)
- ▶▶ 3,4,5,7,9.,10,11,12,14,15 Set3,4,5,7,9,10,11,12,14,15 to PCI3.

#### ☞ PCI4 IRQ Assignment

- ▶▶ Auto Auto assign IRQ to PCI 4. (Default value)
- ▶▶ 3,4,5,7,9.,10,11,12,14,15 Set3,4,5,7,9,10,11,12,14,15 to PCI4.

## PC Health Status

CMOS Setup Utility - Copyright (C) 1984-2002 Award Software

### PC Health Status

Reset Case Open Status	[Disabled]	Item Help
Case Opened	No	Menu Level ▶
V <sub>CORE</sub>	1.810V	
DDR V <sub>tt</sub>	1.248V	
+3.3V	3.280V	
+5V	4.919V	
+12V	11.968V	
5V <sub>SB</sub>	5.053V	
Current System Temperature	27°C	
Current CPU FAN Speed	3183RPM	
Current SYSTEM FAN speed	0RPM	
CPU FAN Fail Warning	[Disabled]	
SYSTEM FAN Fail Warning	[Disabled]	
CPU Shutdown Temperature	[Disabled]	
Current CPU Temperature	34°C/93°F	
↑↓→←: Move Enter: Select +/-/PU/PD: Value F10: Save ESC: Exit F1: General Help F5: Previous Values F6: Fail-Safe Defaults F7: Optimized Defaults		

Figure7: PC Health Status

#### ☞ Reset Case Open Status

#### ☞ Case Opened

If the case is closed, "Case Opened" will show "No".

If the case have been opened, "Case Opened" will show "Yes".

If you want to reset "Case Opened" value, set "Reset Case Open Status" to "Enabled" and save CMOS, your computer will restart.

#### ☞ Current Voltage (V) V<sub>CORE</sub>/DDR V<sub>tt</sub>/ +3.3V/ +5V / +12V / 5V<sub>SB</sub>

Detect system's voltage status automatically.

**☞ Current CPU Temperature (°C)**

Detect CPU Temp. automatically.

**☞ Current CPU FAN / SYSTEM FAN Speed (RPM)**

Detect Fan speed status automatically.

**☞ CPU Shutdown Temperature**

- ▶▶ Enabled System shutdown when current CPU temperature over than 110°C
- ▶▶ Disabled Don't monitor current temperature. (Default value)

**☞ Fan Fail Warning ( CPU / SYSTEM)**

- ▶▶ Disabled Don't monitor current fan speed. (Default value)
- ▶▶ Enabled Alarm when stops.

## Frequency/Voltage Control

CMOS Setup Utility - Copyright (C) 1984-2002 Award Software

### Frequency/Voltage Control

Spread spectrum Modulated	[Enabled]	Item Help
CPU Host Clock Control	[Disabled]	Menu Level▶
※CPU Host Frequency (MHz)	100	
※PCI/AGP Frequency (MHz)	33/66	
DRAM Clock (MHz)	[Auto]	
CPU Voltage Control	[Auto]	
AGP Over Voltage Control	[Auto]	
DIMM Over Voltage Control	[Auto]	
↑↓→←: Move Enter: Select +/-/PU/PD: Value F10: Save ESC: Exit F1: General Help F5: Previous Values F6: Fail-Safe Defaults F7: Optimized Defaults		

Figure 8: Frequency/Voltage Control

※ Those items will be available when "CPU Host Clock Control" is set to Enabled.

#### ☞ Spread spectrum Modulated

- ▶▶ Auto            Set clock spread spectrum by auto.
- ▶▶ Disabled        Disable clock spread spectrum. (Default value)
- ▶▶ Enabled         Enable clock spread spectrum.

#### ☞ CPU Host Clock Control

Note: If system hangs up before enter CMOS setup utility, wait for 20 sec for times out reboot. When time out occur, system will reset and run at CPU default Host clock at next boot.

- ▶▶ Disable         Disable CPU Host Clock Control. (Default value)
- ▶▶ Enable          Enable CPU Host Clock Control.

#### ☞ CPU Host Frequency (MHz) (By switch SW1)

- ▶▶ 100             Set CPU Host Clock to 100MHz~132MHz.
- ▶▶ 133             Set CPU Host Clock to 133MHz~165MHz.
- ▶▶ 166             Set CPU Host Clock to 166MHz~200MHz.

#### ☞ PCI/AGP Frequency (MHz)

- ▶▶ The values depend on CPU Host Frequency (MHz).

#### ☞ DRAM Clock (MHz)

- ▶▶ Please set DRAM Clock according to your requirement.

If you use DDR200 DRAM module, please set "DRAM Clock (MHz)" to "100-DDR200".

If you use DDR266 DRAM module, please set "DRAM Clock (MHz)" to "133-DDR266".

If you use DDR333 DRAM module, please set "DRAM Clock (MHz)" to "166-DDR333".

If you use DDR400 DRAM module, please set "DRAM Clock (MHz)" to "200-DDR400".

Incorrect using it may cause our system broken. For power End-User use only!

- ▶▶ Auto                      Set Memory frequency by DRAM SPD data. (Default value)

#### ☞ CPU Over Voltage Control

Increase CPU voltage may get stable for Over\_Clock. But it may damage to CPU when enable this feature.

- ▶▶ Auto                      Supply voltage as CPU required. (Default value)
- ▶▶ +5% / +7.5% / +10%      Increase voltage range as user selected.

#### ☞ AGP Over Voltage Control

Increase AGP voltage may get stable for Over\_Clock. But it may damage to AGP Card when enable this feature.

- ▶▶ Auto                      Supply voltage as AGP Card required. (Default value)
- ▶▶ +0.1V~+.03V              Set AGP voltage from 1.6V~1.8V.

#### ☞ DIMM Over Voltage Control

Increase DRAM voltage may get stable for Over\_Clock. But it may damage to DRAM module when enable this feature.

- ▶▶ Auto                      Supply voltage as DRAM module required. (Default value)
- ▶▶ +0.1V~+.03V              Set DIMM voltage from 2.6V~2.8V.

## Top Performance

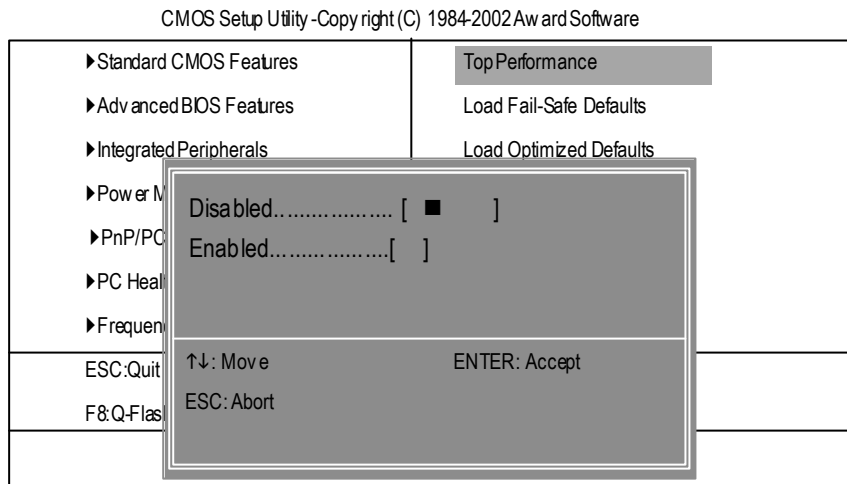

Figure 9: Top Performance

### Top Performance

If you wish to maximize the performance of your system, set "Top Performance" as "Enabled".

- ▶▶ Disabled    Disable this function. (Default Value)
- ▶▶ Enabled    Enable Top Performance function.



**You must check whether your RAM, CPU support over clock when you set "Top Performance" to "Enabled".**

## Load Fail-Safe Defaults

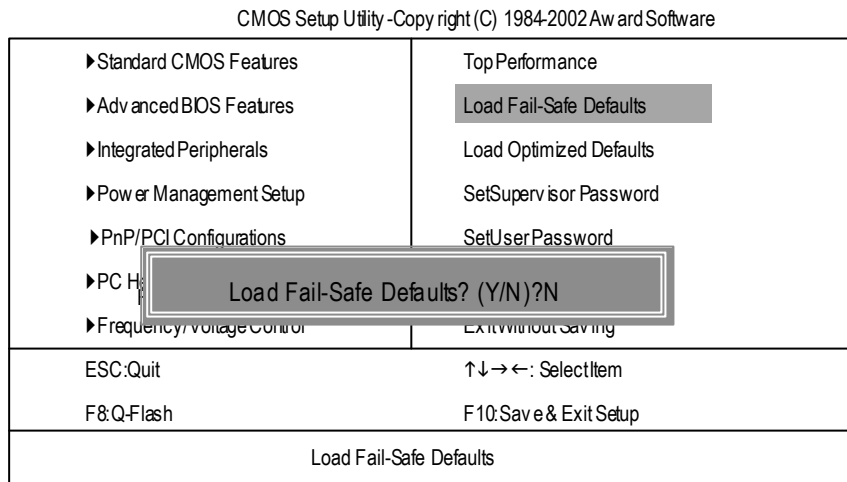

Figure 11: Load Fail-Safe Defaults

### ☞ Load Fail-Safe Defaults

Fail-Safe defaults contain the most appropriate values of the system parameters that allow minimum system performance.



## Load Optimized Defaults

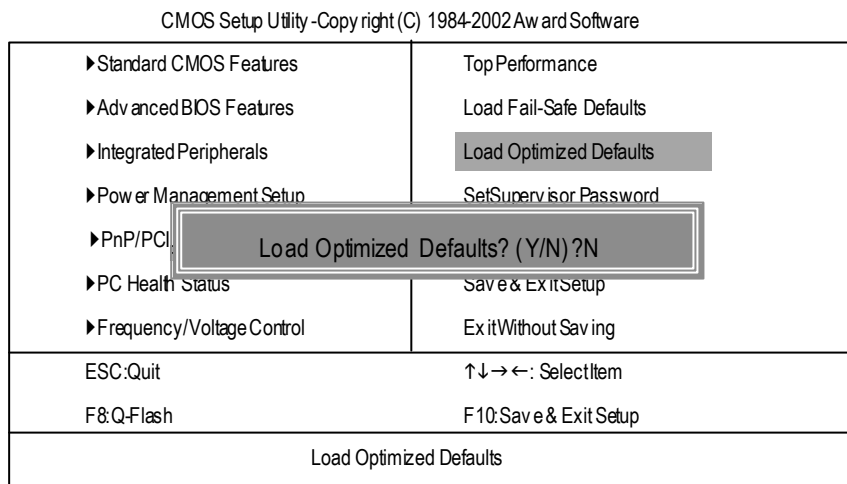

Figure 12: Load Optimized Defaults

### ☞ Load Optimized Defaults

Selecting this field loads the factory defaults for BIOS and Chipset Features which the system automatically detects.

## Set Supervisor/User Password

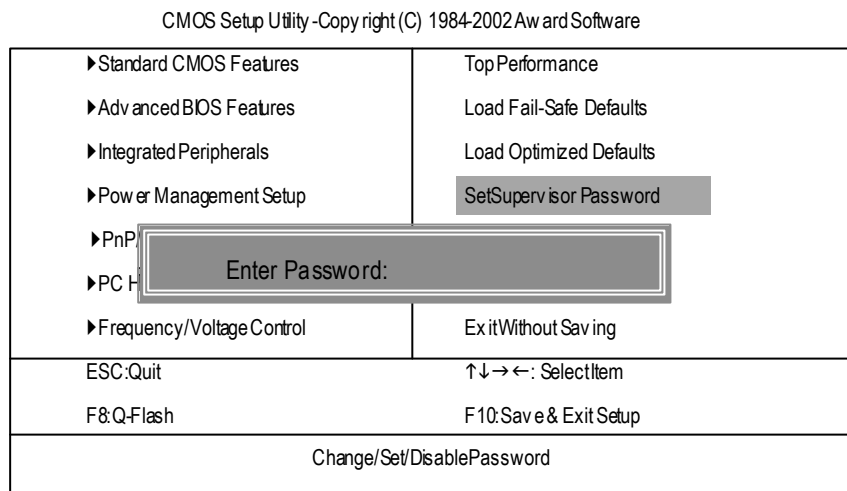

Figure 13: Password Setting

When you select this function, the following message will appear at the center of the screen to assist you in creating a password.

Type the password, up to eight characters, and press <Enter>. You will be asked to confirm the password. Type the password again and press <Enter>. You may also press <Esc> to abort the selection and not enter a password.

To disable password, just press <Enter> when you are prompted to enter password. A message "PASSWORD DISABLED" will appear to confirm the password being disabled. Once the password is disabled, the system will boot and you can enter Setup freely.

The BIOS Setup program allows you to specify two separate passwords: a SUPERVISOR PASSWORD and a USER PASSWORD. When disabled, anyone may access all BIOS Setup program function. When enabled, the Supervisor password is required for entering the BIOS Setup program and having full configuration fields, the User password is required to access only basic items.

If you select "System" at "Security Option" in Advance BIOS Features Menu, you will be prompted for the password every time the system is rebooted or any time you try to enter Setup Menu.

If you select "Setup" at "Security Option" in Advance BIOS Features Menu, you will be prompted only when you try to enter Setup.

## Save & Exit Setup

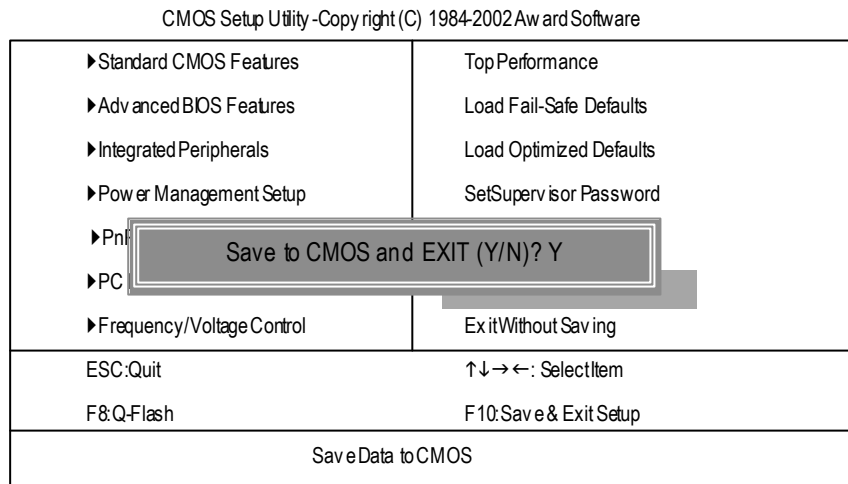

Figure 14: Save & Exit Setup

Type "Y" will quit the Setup Utility and save the user setup value to RTC CMOS.

Type "N" will return to Setup Utility.

## Exit Without Saving

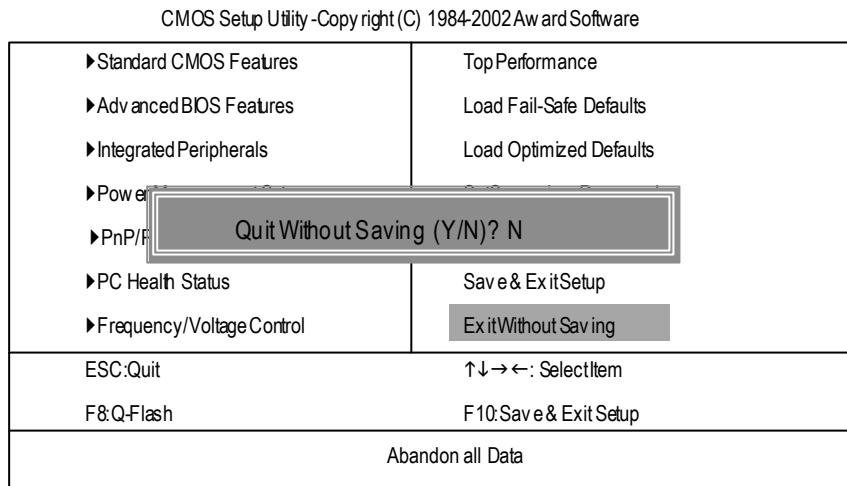

Figure 15: Exit Without Saving

Type "Y" will quit the Setup Utility without saving to RTC CMOS.

Type "N" will return to Setup Utility.

---

---

---

---

---

---

---

---

---

---

---

---

---

---

---

---

---

---

---

---

---

---

---

---

---

---

---

---

---



# Chapter 4 Technical Reference

English

## Block Diagram

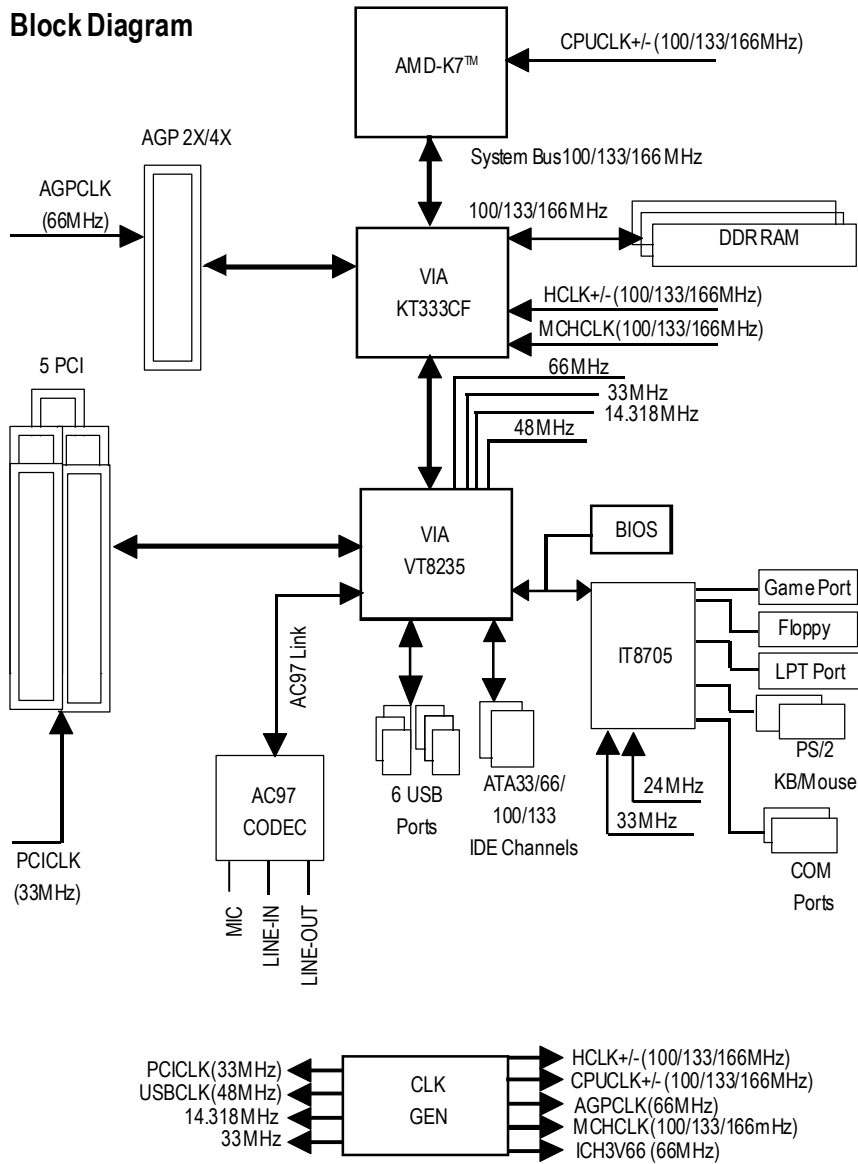

## BIOS Flash Procedure



Method 1:

We use GA-7VTX motherboard and Flash841 BIOS flash utility as example.

Please flash the BIOS according to the following procedures if you are now under the DOS mode.

Flash BIOS Procedure:

STEP 1:

(1) Please make sure your system has installed the extraction utility such as winzip or pkunzip.

Firstly you have to install the extraction utility such as winzip or pkunzip for unzip the files. Both of these utilities are available on many shareware download pages like <http://www.cnet.com>

STEP 2: Make a DOS boot diskette. (See example: Windows 98 O.S.)

Beware: Windows ME/2000 are not allowed to make a DOS boot diskette.

(1) With an available floppy disk in the floppy drive. Please leave the diskette "UN-write protected" type. Double click the "My Computer" icon from Desktop, then click "3.5 diskette (A)" and right click to select "Format (M)"

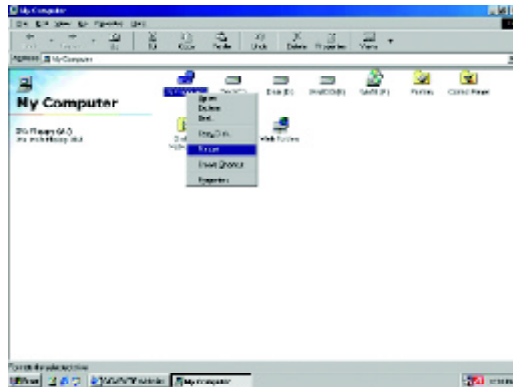



(2) Select the "Quick (erase)" for Format Type, and pick both "Display summary when finished" and "Copy system files", after that press "Start". That will format the floppy and transfer the needed system files to it

Beware: This procedure will erase all the prior data on that floppy, so please proceed accordingly.

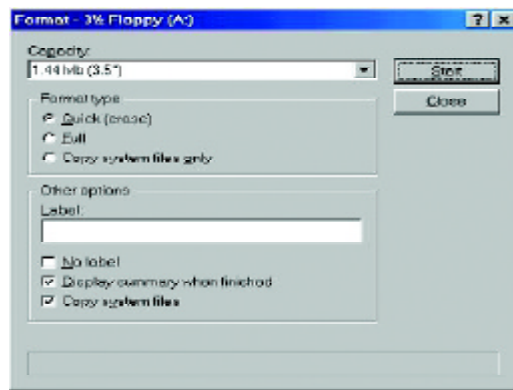

(3) After the floppy has been formatted completely, please press "Close".



STEP 3: Download BIOS and BIOS utility program.

(1) Please go to Gigabyte website <http://www.gigabyte.com.tw/index.html>, and click "Support".



(2) From Supportzone, click the "Motherboards BIOS & Drivers".

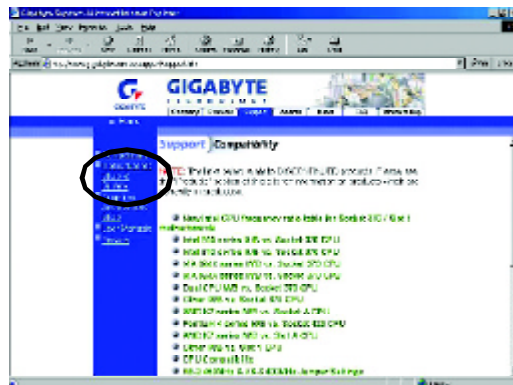

(3) We use GA-7VTX motherboard as example. Please select GA-7VTX by Model or Chipset optional menu to obtain BIOS flash files.

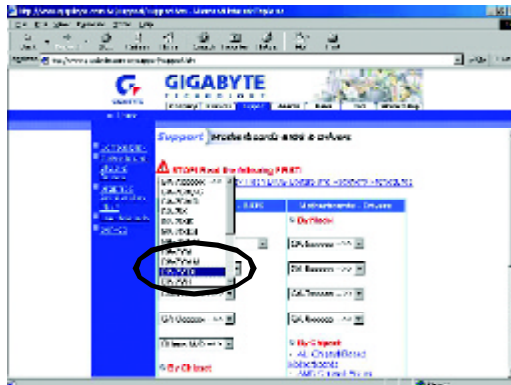

(4) Select an appropriate BIOS version (For example: F4), and click to download the file. It will pop up a file download screen, then select the "Open this file from its current location" and press "OK".

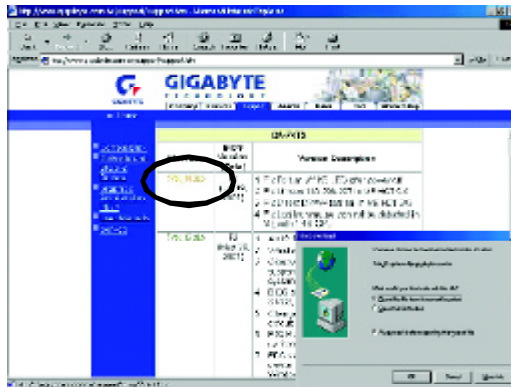

(5) At this time the screen shows the following picture, please click "Extract" button to unzip the files.

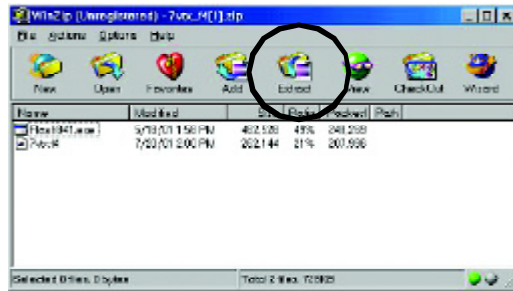

(6) Please extract the download files into the clean bootable floppy disk A mentioned in STEP 2, and press "Extract".

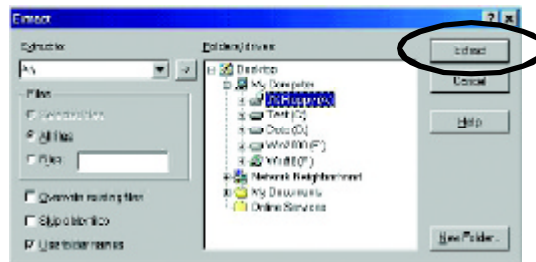

STEP 4: Make sure the system will boot from the floppy disk.

- (1) Insert the floppy disk (contains bootable program and unzip file) into the floppy drive A. Then, restart the system. The system will boot from the floppy disk. Please press <DEL> key to enter BIOS setup main menu when system is boot up.



- (2) Once you enter the BIOS setup utility, the main menu will appear on the screen. Use the arrows to highlight the item "BIOS FEATURES SETUP".

AMIBIOS SIMPLE SETUP UTILITY - VERSION 1.24b (C) 1999 American Megatrends, Inc. All Rights Reserved	
STANDARD CMOS SETUP <b>BIOS FEATURES SETUP</b> CHIPSET FEATURES SETUP POWER MANAGEMENT SETUP PNP / PCI CONFIGURATION LOAD BIOS DEFAULTS LOAD SETUP DEFAULTS	INTEGRATED PERIPHERALS HARDWARE MONITOR & MISC SETUP SUPERVISOR PASSWORD USER PASSWORD IDE HDD AUTO DETECTION SAVE & EXIT SETUP EXIT WITHOUT SAVING
ESC: Quit      ↑↓←→ : Select Item      (Shift)F2 : Change Color      F5: Old Values F6: Load BIOS Defaults      F7: Load Setup Defaults      F10: Save & Exit	
Time, Date , Hard Disk Type...	

(3) Press "Enter" to enter "BIOS FEATURES SETUP" menu. Use the arrows to highlight the item "1st Boot Device", and then use the "Page Up" or "Page Down" keys to select "Floppy".

AMIBIOS SETUP - BIOS FEATURES SETUP	
(C) 2001 American Megatrends, Inc. All Rights Reserved	
1st Boot Device : Floppy	
2nd Boot Device : IDE-0	
3rd Boot Device : CDROM	
S.M.A.R.T. for Hard Disks : Disabled	
BootUp Num-Lock : On	ESC: Quit      ↑↓←→: Select Item
Floppy Drive Seek : Disabled	F1 : Help      PU/PD/+/- : Modify
Password Check : Setup	F5 : Old Values (Shift)F2: Color
	F6 : Load BIOS Defaults
	F7 : Load Setup Defaults

(4) Press "ESC" to go back to previous screen. Use the arrows to highlight the item "SAVE & EXIT SETUP" then press "Enter". System will ask "SAVE to CMOS and EXIT (Y/N)?" Press "Y" and "Enter" keys to confirm. Now the system will reboot automatically, the new BIOS setting will be taken effect next boot-up.

AMIBIOS SIMPLE SETUP UTILITY - VERSION 1.24b	
(C) 2001 American Megatrends, Inc. All Rights Reserved	
STANDARD CMOS SETUP	INTEGRATED PERIPHERALS
BIOS FEATURES SETUP	HARDWARE MONITOR & MISC SETUP
CHIPSET FEATURES SETUP	SUPERVISOR PASSWORD
POWER MANAGEMENT SETUP	USER PASSWORD
PNP / PCI CONFIGURATION	SAVE & EXIT SETUP
LOAD BIOS DEFAULTS	EXIT WITHOUT SAVING
LOAD SETUP DEFAULTS	
ESC: Quit      ↑↓←→ : Select Item      (Shift)F2 : Change Color      F5: Old Values	
F6: Load BIOS Defaults      F7: Load Setup Defaults      F10: Save & Exit	
Save Data to CMOS & Exit SETUP	

STEP 5: BIOS flashing.

- (1) After the system boot from floppy disk, type "A:\> dir/w" and press "Enter" to check the entire files in floppy A. Then type the "BIOS flash utility" and "BIOS file" after A:\>. In this case you have to type "A:\> Flash841 7VTX.F4" and then press "Enter".

```
Starting Windows 98...

Microsoft(R) Windows98
© Copyright Microsoft Corp 1981-1999

A:\> dir/w
Volume in drive A has no label
Volume Serial Number is 16EB-353D
Directory of A:\
COMMAND.COM  7VTX.F4  FLASH841.EXE
              3 file(s)  838,954 bytes
              0 dir(s)   324,608 bytes free

A:\> Flash841 7VTX.F4
```

- (2) Now screen appears the following Flash Utility main menu. Press "Enter", the highlighted item will locate on the model name of the right-upper screen. Right after that, press "Enter" to start BIOS Flash Utility.

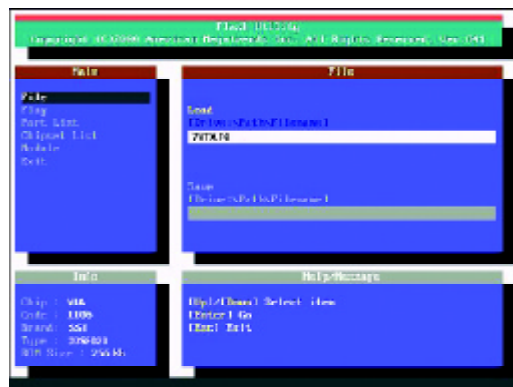

(3) It will pop up a screen and asks "Are you sure to flash the BIOS?" Press [Enter] to continue the procedure, or press [ESC] to quit.

Beware: Please do not turn off the system while you are upgrading BIOS. It will render your BIOS corrupted and system totally inoperative.

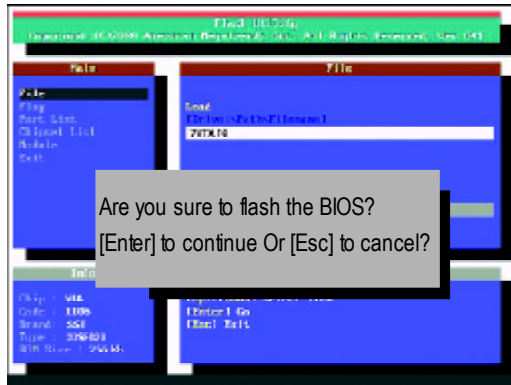

(4) The BIOS flash completed. Please press [ESC] to exit Flash Utility.

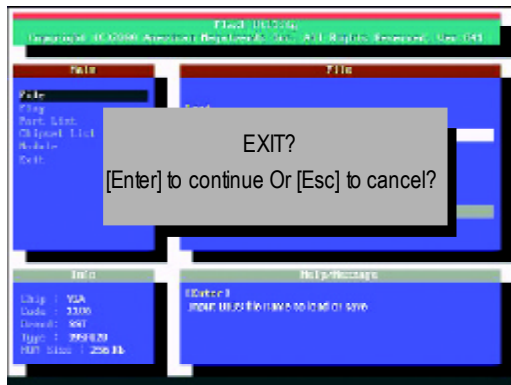



**STEP 6: Load BIOS defaults.**

Normally the system redetects all devices after BIOS has been upgraded. Therefore, we highly recommend reloading the BIOS defaults after BIOS has been upgraded. This important step resets everything after the flash.

- (1) Take out the floppy diskette from floppy drive, and then restart the system. The boot up screen will indicate your motherboard model and current BIOS version.

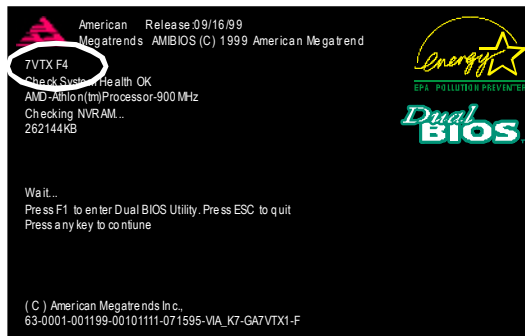

- (2) Don't forget to press <DEL> key to enter BIOS setup again when system is boot up. Use the arrows to highlight the item "LOAD SETUP DEFAULTS" then press "Enter". System will ask "Load Setup Defaults (Y/N)?" Press "Y" and "Enter" keys to confirm.

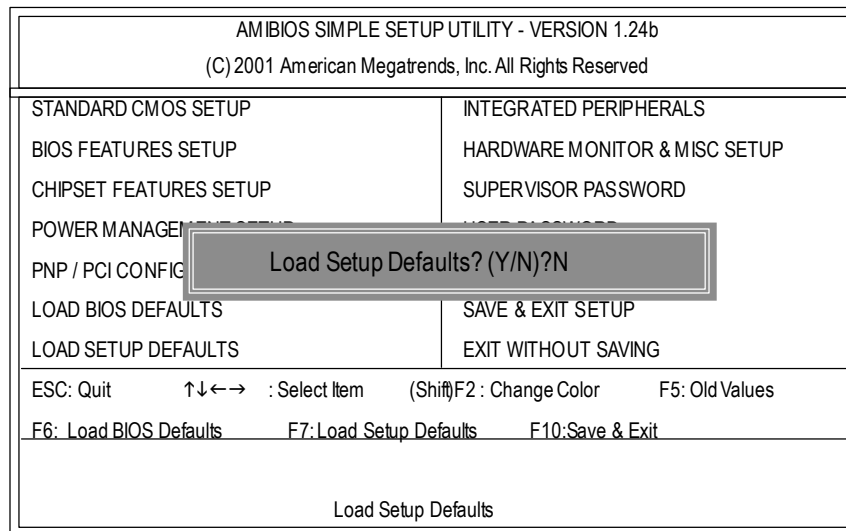

(3) Use the arrows to highlight the item "SAVE & EXIT SETUP" and press "Enter". System will ask "SAVE to CMOS and EXIT (Y/N)?" Press "Y" and "Enter" keys to confirm. Now the system will reboot automatically, the new BIOS setting will be taken effect next boot-up.

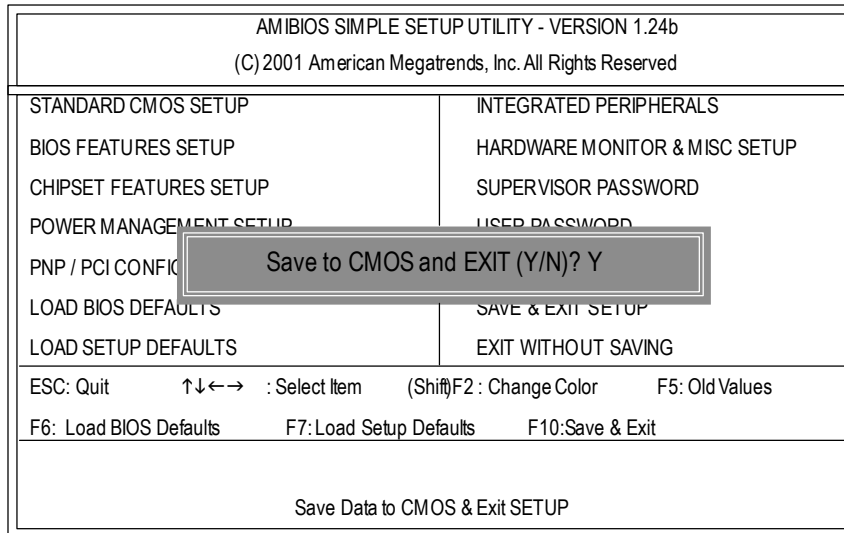

(4) Congratulate you have accomplished the BIOS flash procedure.

 Method 2:

**Q-Flash Introduction**

**A. What is Q-Flash Utility?**

Q-Flash utility is a pre-O.S. BIOS flash utility enables users to update its BIOS within BIOS mode, no more fooling around any OS.

**B. How to use Q-Flash?**

a. After power on the computer, pressing <Del> immediately during POST (Power On Self Test) it will allow you to enter AWARD BIOS CMOS SETUP, then press <F8> to enter Q-Flash utility.

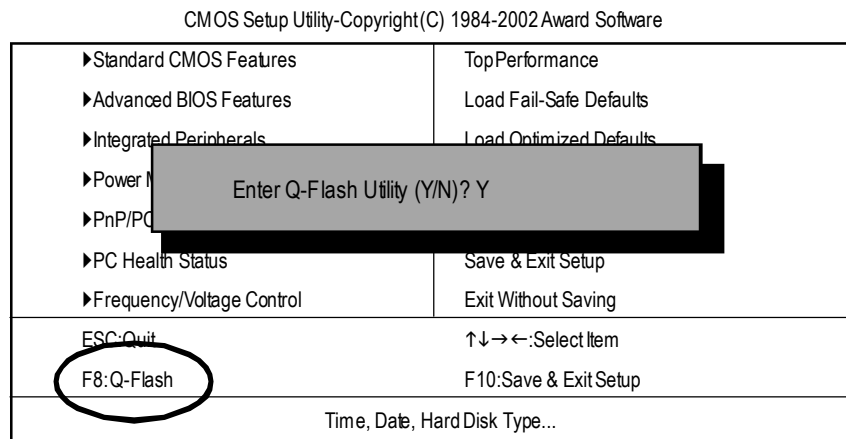

b. Q-Flash Utility

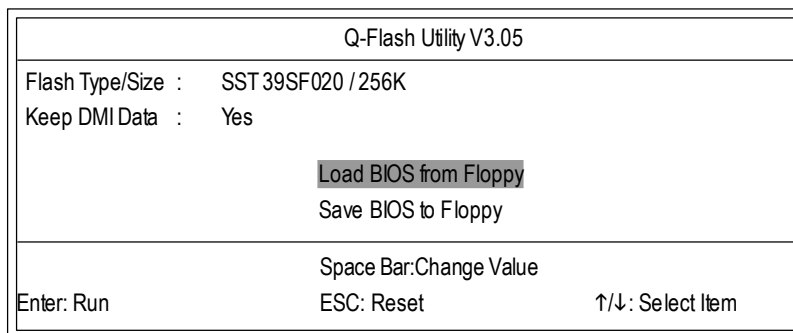

### Load BIOS From Floppy

 In the A: drive, insert the "BIOS" diskette, then Press Enter to Run.

1 File(s) found	
XXXX.XX	256K
Total Size: 1.39M                      Free Size: 1.14M	
F5: Refresh	DEL: Delete                      ESC: Return Main

Where XXXX.XX is name of the BIOS file.

 Press Enter to Run.

Are you sure to update BIOS?  
[Enter] to contiune Or [ESC] of abort..

 Press Enter to Run.

!! COPY BIOS Completed -Pass !!  
Please press any key to continue

Congratulation! You have completed the flashed and now can restart system.



Method 3:

If you don't have DOS boot disk, we recommend that you used Gigabyte @BIOS™ program to flash BIOS.



(1)

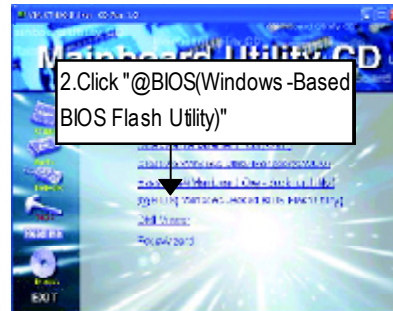

(2)

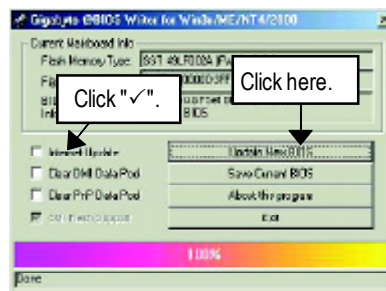

(3)

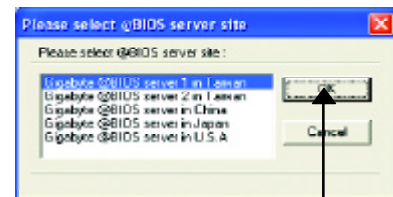

(4)

Methods and steps:

- I. Update BIOS through Internet
  - a. Click "Internet Update" icon
  - b. Click "Update New BIOS" icon
  - c. Select @BIOS™ sever
  - d. Select the exact modelname on your motherboard
  - e. System will automatically download and update the BIOS.

## II. Update BIOS NOT through Internet

- a. Do not click "Internet Update" icon
- b. Click "Update New BIOS"
- c. Please select "All Files" in dialog box while opening the old file.
- d. Please search for BIOS unzip file, downloading from internet or any other methods (such as: 7VA.F6).
- e. Complete update process following the instruction.

## III. Save BIOS

In the very beginning, there is "Save Current BIOS" icon shown in dialog box. It means to save the current BIOS version.

## IV. Check out supported motherboard and Flash ROM:

In the very beginning, there is "About this program" icon shown in dialog box. It can help you check out which kind of motherboard and which brand of Flash ROM are supported.

### Note:

- a. In method I, if it shows two or more motherboard's model names to be selected, please make sure your motherboard's model name again. Selecting wrong model name will cause the system unbooted.
- b. In method II, be sure that motherboard's model name in BIOS unzip file are the same as your motherboard's. Otherwise, your system won't boot.
- c. In method I, if the BIOS file you need cannot be found in @BIOS™ server, please go onto Gigabyte's web site for downloading and updating it according to method II.
- d. Please note that any interruption during updating will cause system unbooted.

## @ BIOS Introduction

### Gigabyte announces @ BIOS Windows BIOS live update utility



Have you ever updated BIOS by yourself? Or like many other people, you just know what BIOS is, but always hesitate to update it? Because you think updating newest BIOS is unnecessary and actually you don't know how to update it.

Maybe not like others, you are very experienced in BIOS updating and spend quite a lot of time to do it. But of course you don't like to do it too much. First, download different BIOS from website and then switch the operating system to DOS mode. Secondly, use different flash utility to update BIOS. The above process is not a interesting job. Besides, always be carefully to store the BIOS source code correctly in your disks as if you update the wrong BIOS, it will be a nightmare.

Certainly, you wonder why motherboard vendors could not just do something right to save your time and effort and save you from the lousy BIOS updating work? Here it comes! Now Gigabyte announces @BIOS—the first Windows BIOS live update utility. This is a smart BIOS update software. It could help you to download the BIOS from internet and update it. Not like the other BIOS update software, it's a Windows utility. With the help of '@BIOS', BIOS updating is no more than a click.

Besides, no matter which mainboard you are using, if it's a Gigabyte's product\*, @BIOS help you to maintain the BIOS. This utility could detect your correct mainboard model and help you to choose the BIOS accordingly. It then downloads the BIOS from the nearest Gigabyte ftp site automatically. There are several different choices; you could use "Internet Update" to download and update your BIOS directly. Or you may want to keep a backup for your current BIOS, just choose "Save Current BIOS" to save it first. You make a wise choice to use Gigabyte, and @BIOS update your BIOS smartly. You are now worry free from updating wrong BIOS, and capable to maintain and manage your BIOS easily. Again, Gigabyte's innovative product erects a milestone in mainboard industries.

For such a wonderful software, how much it costs? Impossible! It's free! Now, if you buy a Gigabyte's motherboard, you could find this amazing software in the attached driver CD. But please remember, connected to internet at first, then you could have a internet BIOS update from your Gigabyte @BIOS.

## Easy Tune™ 4 Introduction

### Gigabyte announces *EasyTune™ 4* Windows based Overclocking utility

EasyTune 4 carries on the heritage so as to pave the way for future generations.

Overclock" might be one of the most common issues in computer field. But have many users ever tried it? The answer is probably "no". Because "Overclock" is thought to be very difficult and includes a lot of technical know-how, sometimes "Overclock" is even considered as special skills found only in some enthusiasts. But as to the experts in "Overclock", what's the truth? They may spend quite a lot of time and money to study, try and use many different hardware or BIOS tools to do "Overclock". And even with these technologies, they still learn that it's quite a risk because the safety



and stability of an "Overclock" system is unknown. Now everything is different because of a Windows based overclocking utility "EasyTune 4" --announced by Gigabyte. This windows based utility has totally changed the gaming rule of "Overclock". This is the first windows based overclocking utility is suitable for both normal and power users. Users can choose either "Easy Mode" or "Advanced Mode" for overclocking at their convenience. For users who choose "Easy Mode", they just need to click "Auto Optimize" to have autoed and immediate CPU overclocking. This software will then overdrive CPU speed automatically with the result being shown in the control panel. If users prefer "Overclock" by them, there is also another choice. Click "Advanced Mode" to enjoy "sport drive" class Overclocking user interface. "Advanced Mode", allows users to change the system bus /AGP / Memory working frequency in small increments to get ultimate system performance. It operates in coordination with Gigabyte motherboards. Besides, it is different from other traditional overclocking methods, EasyTune 4 doesn't require users to change neither BIOS nor hardware switch/jumper setting; on the other hand, they can do "Overclock" at easy step. Therefore, this is a safer way for "Overclock" as nothing is changed on software or hardware. If user runs EasyTune 4 over system's limitation, the biggest lost is only to restart the computer again and the side effect is then well controlled. Moreover, if one well-performed system speed has been tested in EasyTune 4, user can "Save" this setting and "Load" it in next time. Obviously, Gigabyte EasyTune 4 has already turned the "Overclock" technology toward to a newer generation. This wonderful software is now free bundled in Gigabyte motherboard attached in driver CD. Users may make a test drive of "EasyTune 4" to find out more amazing features by themselves.

\*Some Gigabyte products are not fully supported by EasyTune 4. Please find the products supported list in the web site.

\*Any "Overclocking action" is at user's risk, Gigabyte Technology will not be responsible for any damage or instability to your processor, motherboard, or any other components.



## 2-/4-/6-Channel Audio Function Introduction

The installation of windows 98SE/2K/ME/XP is very simple. Please follow next step to install the function!

### Stereo Speakers Connection and Settings:

We recommend that you use the speaker with amplifier to acquire the best sound effect if the stereo output is applied.

STEP 1:

Connect the stereo speakers or earphone to "Line Out".

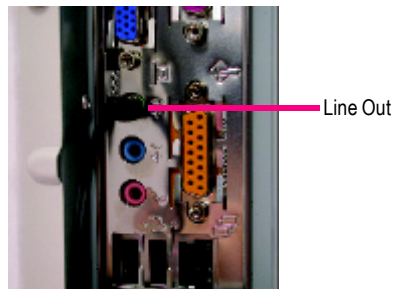

STEP 2 :

After installation of the audio driver, you'll find an  icon on the taskbar's status area. Click the audio icon "Sound Effect" from the windows tray at the bottom of the screen.

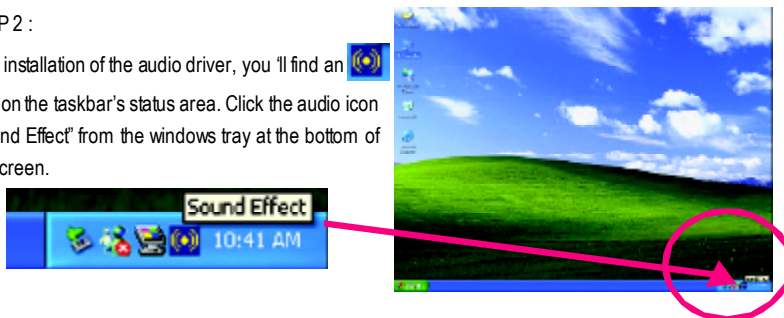

STEP 3:

Select "Speaker Configuration", and choose the "2 channels for stereo speakers output".

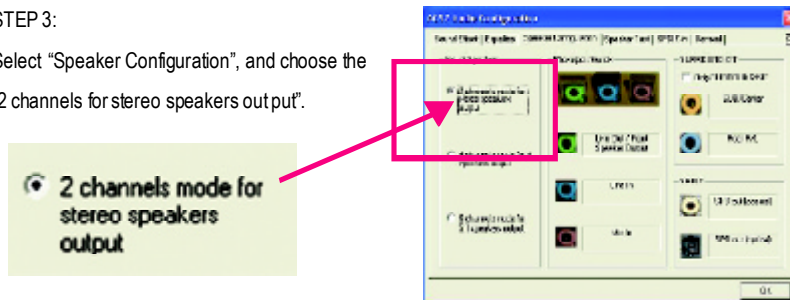

### 4 Channel Analog Audio Output Mode

**STEP 1 :**

Connect the front channels to "Line Out", the rear channels to "Line In".

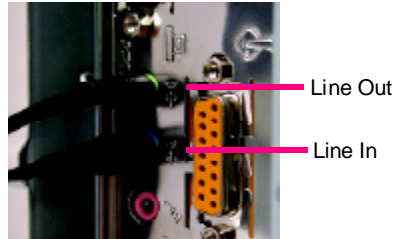

**STEP 2 :**

After installation of the audio driver, you'll find an  icon on the taskbar's status area. Click the audio icon "Sound Effect" from the windows tray at the bottom of the screen.



**STEP 3 :**

Select "Speaker Configuration", and choose the "4 channels for 4 speakers output". Disable "Only SURROUND-KIT", and press "OK".

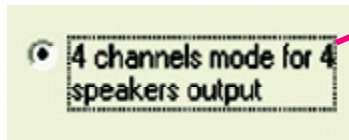

When the "Environment settings" is "None", the sound would be performed as stereo mode (2 channels output). Please select the other settings for 4 channels output.

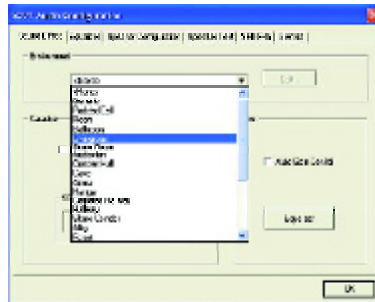

### Basic 6 Channel Analog Audio Output Mode

Use the back audio panel to connect the audio output without any additional module.

**STEP 1 :**

Connect the front channels to "Line Out", the rear channels to "Line In", and the Center/Subwoofer channels to "MIC In".

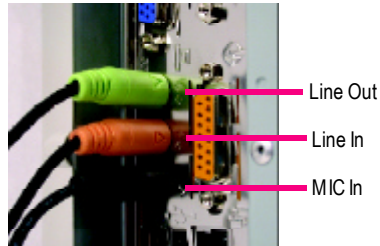

**STEP 2 :**

After installation of the audio driver, you'll find an  icon on the taskbar's status area. Click the audio icon "Sound Effect" from the windows tray at the bottom of the screen.

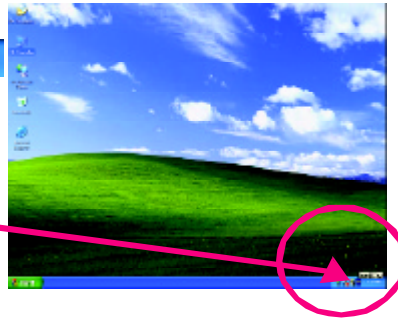

**STEP 3 :**

Select "Speaker Configuration", and choose the "6 channels for 5.1 speakers out put".

Disable "Only SURROUND-KIT" and press "OK"



Advanced 6 Channel Analog Audio Output Mode (using Audio Combo Kit, Optional Device):

(Audio Combo Kit provides SPDIF output port : optical & coaxial and SURROUND-KIT : Rear R/L & Center/subwoofer)

SURROUND-KIT access analog output to rear channels and Center/Subwoofer channels. It is the best solution if you need 6 channel output, Line In and MIC at the same time. "SURROUND-KIT" is included in the GIGABYTE unique "Audio Combo Kit" as picture.

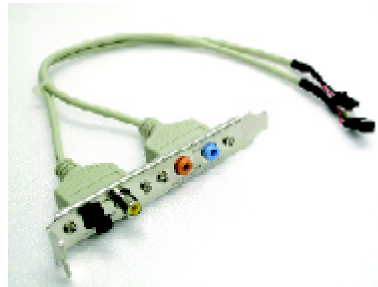

STEP 1 :

Insert the "Audio Combo Kit" in the back of the case , and fix it with the screw.



STEP 2 :

Connect the "SURROUND-KIT" to SUR\_CEN on the M/B.

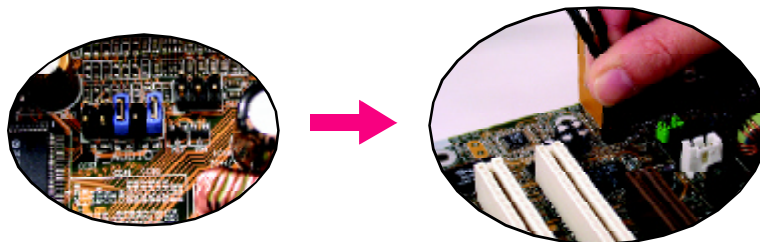

**STEP 3 :**

Connect the front channels to back audio panel's "Line Out", the rear channels to SURROUND-KIT's REAR R/L, and the Center/Subwoofer channels to SURROUND-KIT's SUB CENTER.

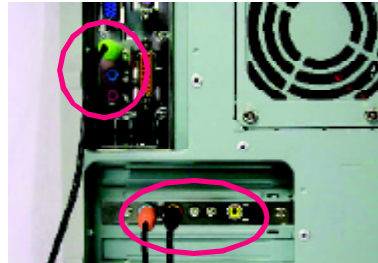

**STEP 4 :**

Click the audio icon "Sound Effect" from the windows tray at the bottom of the screen.

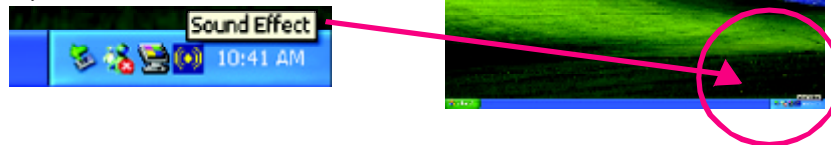

**STEP 5 :**

Select "Speaker Configuration", and choose the "6 channels for 5.1 speakers output". Enable "Only SURROUND-KIT" and press "OK".

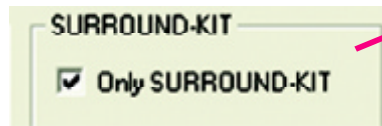

**Basic & Advanced 6 Channel Analog Audio Output ModeNotes:**

When the "Environment settings" is "None", the sound would be performed as stereo mode(2 channels output). Please select the other settings for 6 channels output.

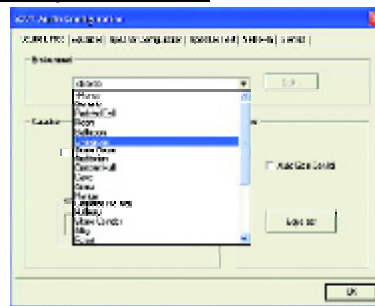

**SPDIF Output Device (Optional Device)**

A “SPDIF output” device is available on the motherboard. Cable with rear bracket is provided and could link to the “SPDIF output” connector (As picture.) For the further linkage to decoder, rear bracket provides coaxial cable and Fiber connecting port.

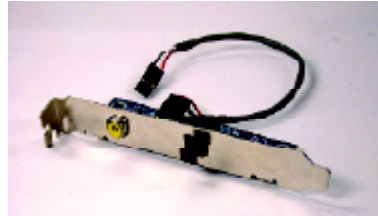

1. Connect the SPDIF output device to the rear bracket of PC, and fix it with screw.



2. Connect SPDIF wire to the motherboard.

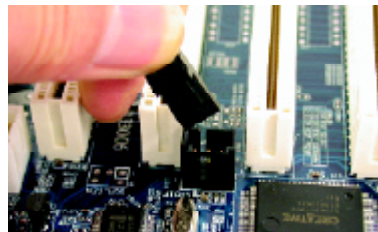

3. Connect co-axial or optical output to the SPDIF decoder.

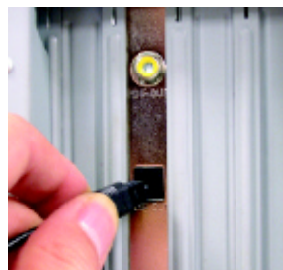







## Chapter 5 Appendix

Picture below are shown in Windows XP (CD driver version 1.2)

Insert the driver CD-title that came with your motherboard into your CD-ROM drive, the driver CD-title will auto start and show the installation guide. If not please double click the CD-ROM device icon in "My computer", and execute the setup.exe.

### A. Installing VIA Chipset Driver

Please install this driver as the first priority. this item installs the chipset driver utility that enables Plug-n-Plug INF support for Intel chipset component.

### B. Installing Sound Driver

Click this item to install sound driver.



## Appendix A: VIA 4 in 1 Service Pack Driver Installation

### A. VIA 4 in 1 Service Pack Driver Utility:



(1)

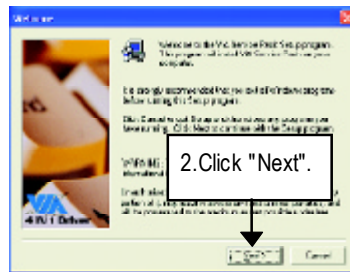

(2)

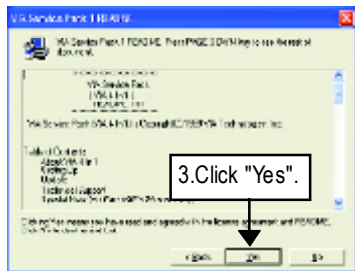

(3)

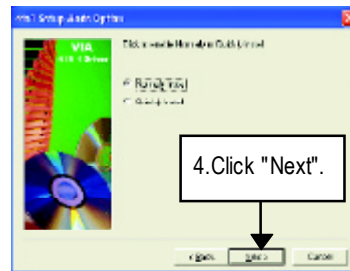

(4)



(5)



(6)

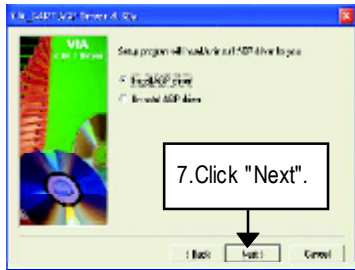

(7)

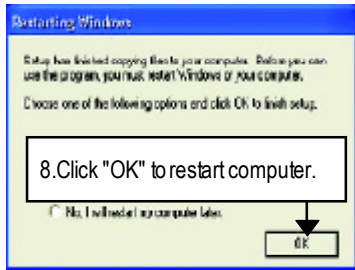

(8)

**B.USB Patch Driver:**

Enable S3 for USB Device Setup is preparing the InstallShield(R) Wizard which will guide you through the setup process.

**C. VIA USB2.0 Driver**



(1)

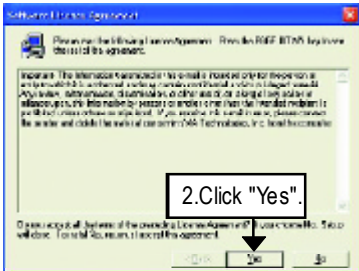

(2)



(3)



(4)

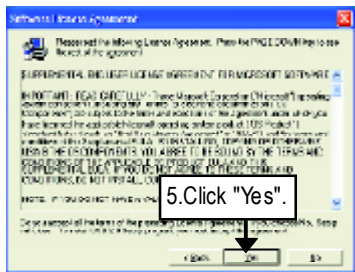

(5)

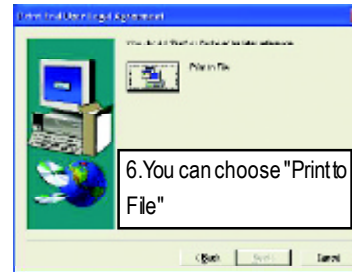

(6)



(7)

Print to File : Press this button, you can view file on the screen . We recommend you do it



If there is any problem occurred during USB2.0 device installing, using or upgrading. Please visit Microsoft or GIGABYTE website for downloading the latest drivers.

### Appendix B: RealTek AC'97 Audio Driver

Insert the driver CD-title that came with your motherboard into your CD-ROM drive, the driver CD-title will auto start and show the installation guide. If not, please double click the CD-ROM device icon in "Mycomputer", and execute the setup.exe.



(1)



(2)



(3)

### Appendix C: EasyTune4 Utilities Installation

Insert the driver CD-title that came with your motherboard into your CD-ROM drive, the driver CD-title will auto start and show the installation guide. If not please double click the CD-ROM device icon in "My computer", and execute the setup.exe.



(1)



(2)

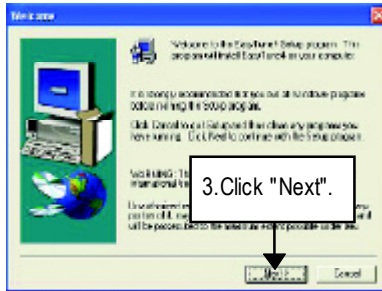

(3)

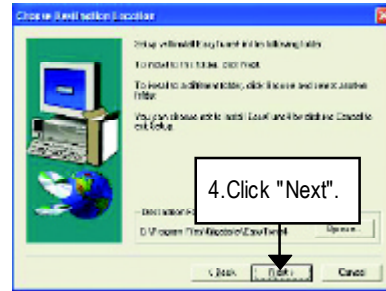

(4)

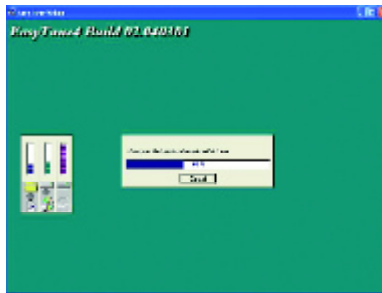

(5)

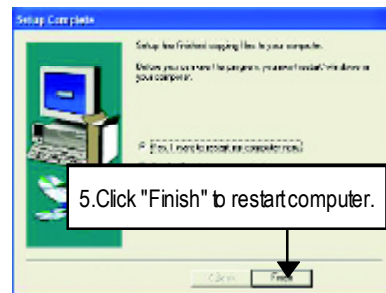

(6)

**Appendix D: Acronyms**

Acronyms	Meaning
ACPI	Advanced Configuration and Power Interface
APM	Advanced Power Management
AGP	Accelerated Graphics Port
AMR	Audio Modem Riser
ACR	Advanced Communications Riser
BIOS	Basic Input / Output System
CPU	Central Processing Unit
CMOS	Complementary Metal Oxide Semiconductor
CRIMM	Continuity RIMM
CNR	Communication and Networking Riser
DMA	Direct Memory Access
DMI	Desktop Management Interface
DIMM	Dual Inline Memory Module
DRM	Dual Retention Mechanism
DRAM	Dynamic Random Access Memory
DDR	Double Data Rate
ECP	Extended Capabilities Port
ESCD	Extended System Configuration Data
ECC	Error Checking and Correcting
EMC	Electromagnetic Compatibility
EPP	Enhanced Parallel Port
ESD	Electrostatic Discharge
FDD	Floppy Disk Device
FSB	Front Side Bus
HDD	Hard Disk Device
IDE	Integrated Dual Channel Enhanced
IRQ	Interrupt Request
I/O	Input / Output
IOAPIC	Input Output Advanced Programmable Input Controller
ISA	Industry Standard Architecture
LAN	Local Area Network

to be continued.....

Acronyms	Meaning
LBA	Logical Block Addressing
LED	Light Emitting Diode
MHz	Megahertz
MIDI	Musical Instrument Digital Interface
MTH	Memory Translator Hub
MPT	Memory Protocol Translator
NIC	Network Interface Card
OS	Operating System
OEM	Original Equipment Manufacturer
PAC	PCI A.G.P. Controller
POST	Power-On Self Test
PCI	Peripheral Component Interconnect
RIMM	Rambus in-line Memory Module
SCI	Special Circumstance Instructions
SECC	Single Edge Contact Cartridge
SRAM	Static Random Access Memory
SMP	Symmetric Multi-Processing
SMI	System Management Interrupt
USB	Universal Serial Bus
VID	Voltage ID

**Technical Support/RMA Sheet**

Customer/Country:	Company:	Phone No.:
Contact Person:	E-mail Add. :	

Modelname/Lot Number:	PCB revision:
BIOS version:	O.S./A.S.:

Hardware Configuration	Mfs.	Modelname	Size:	Driver/Utility:
CPU				
Memory Brand				
Video Card				
Audio Card				
HDD				
CD-ROM / DVD-ROM				
Modem				
Network				
AMR / CNR				
Keyboard				
Mouse				
Power supply				
Other Device				

Problem Description:

---



---



**DDR400 (PC3200) recommended memory modules list**

Vender	Brand	Type	Size	Component	Status
Kingmax	Kingmax	DDR	128MB	KDL684T4AA-50	OK
MICRON	MICRON	DDR	128MB	M8VDDT1664AG-403B2	OK
Hynix	Hynix	DDR	128MB	HY5DU28822BT-04	OK
SAMSUNG	SAMSUNG	DDR	128MB	K4H280838D-TCC4	OK
Kingmax	Kingmax	DDR	256MB	KDL684T4AA-50	OK
MICRON	MICRON	DDR	256MB	M16VDDT3264AG-403B2	OK
Hynix	Hynix	DDR	256MB	HY5DU28822BT-04	OK
ADATA	Winbond	DDR	256MB	W942508BH-52260D	OK
SAMSUNG	SAMSUNG	DDR	256MB	K4H560838D-TCC4 223	OK
APACER	Winbond	DDR	256MB	W942508BH-52260D	OK
Winbond	Winbond	DDR	256MB	W942508BH-52110A	OK
Winbond	Winbond	DDR	256MB	W942508BH-52150D	OK
ADATA	Winbond	DDR	256MB	W942508BH-52260D	OK
APACER	Winbond	DDR	256MB	W942508BH-52260D	OK

☛ Should you need to find new support list, pls refer to <http://www.gigabyte.com.tw> for the detail.

## Troubleshooting



If you encounter any trouble during boot up, please follow the troubleshooting procedures.

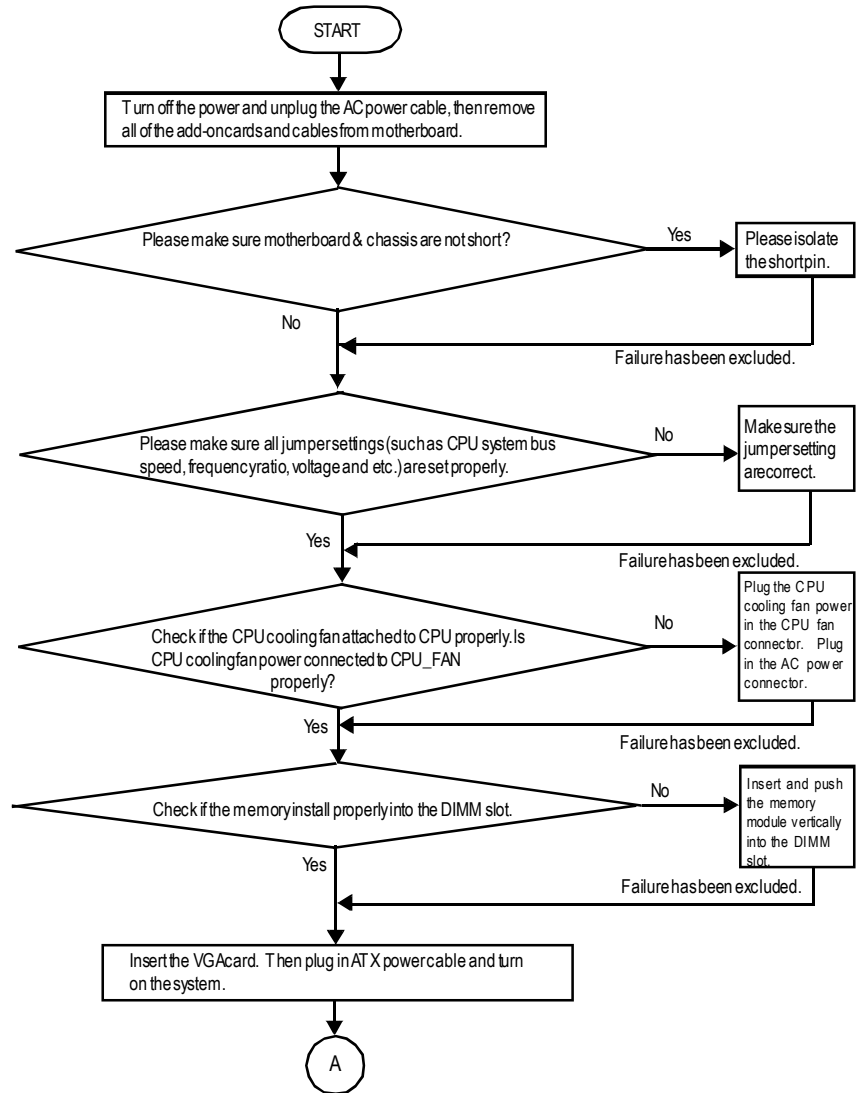

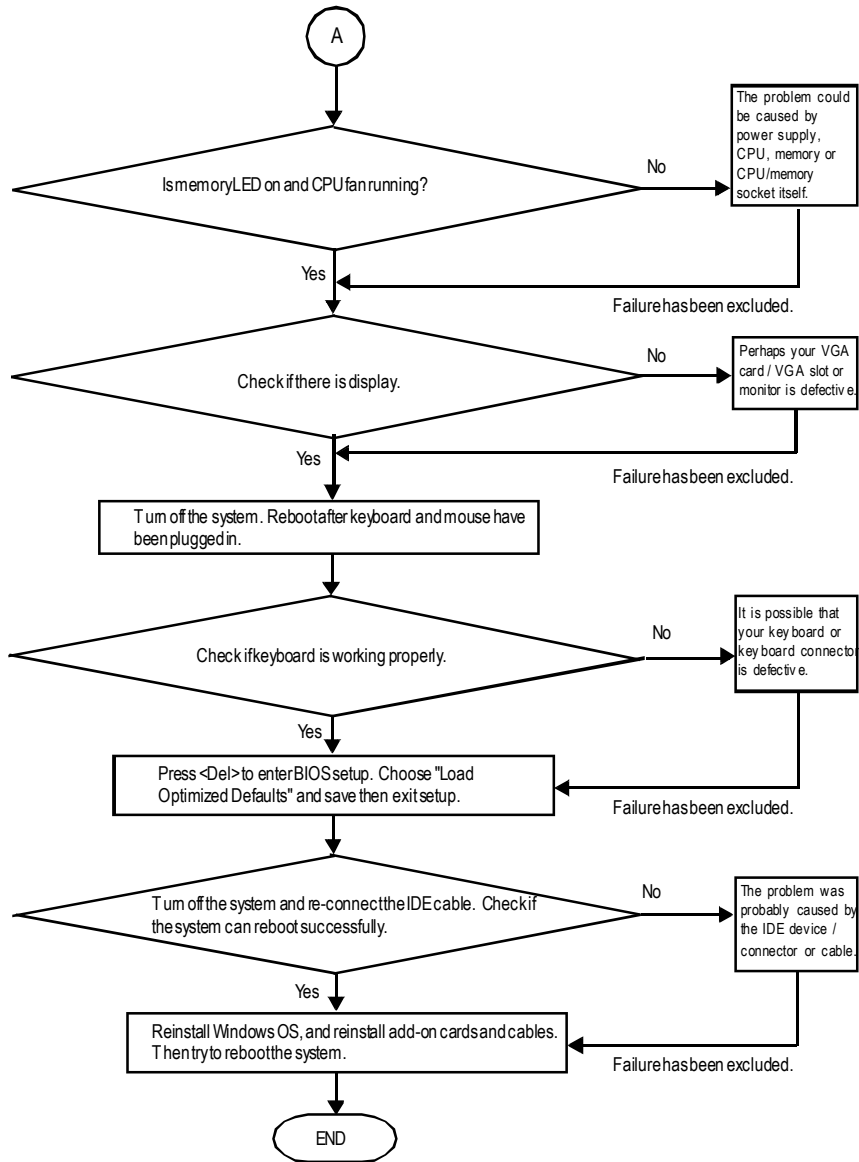

If the above procedure unable to solve your problem, please contact with your local retailer or national distributor for help. Or, you could submit your question to the service mail via Gigabyte website technicalsupportzone (<http://www.gigabyte.com.tw>). The appropriate response will be provided ASAP.









