

8S648FX-RZ / 8S648FX-RZ-C

Intel® Pentium® 4 Processor Motherboard

User's Manual

Rev. 1002

12ME-S648FXRZ-1002

Copyright

© 2003 GIGABYTE TECHNOLOGY CO., LTD

Copyright by **GIGA-BYTE TECHNOLOGY CO., LTD. ("GBT")**. No part of this manual may be reproduced or transmitted in any form without the expressed, written permission of **GBT**.

Trademarks

Third-party brands and names are the property of their respective owners.

Notice

Please do not remove any labels on motherboard, this may void the warranty of this motherboard.

Due to rapid change in technology, some of the specifications might be out of date before publication of this booklet.

The author assumes no responsibility for any errors or omissions that may appear in this document nor does the author make a commitment to update the information contained herein.

Declaration of Conformity

(Full address)

G.B. T. Technology Trading GmbH
Amphibler Weg 41, 1F 20377 Hemming, Germany

(Description of the appliance, system, installation to which it refers)

Mother Board
8S648FX-RZ

(Reference to the specification under which conformity is declared)
is in conformity with
in accordance with 89/320 EEC EMC Directive

<input type="checkbox"/> EN 60911	Limits and methods of measurement of radio disturbance characteristics of industrial, scientific and medical (ISM) high frequency equipment	<input checked="" type="checkbox"/> EN 61000-3-2	Disturbance in supply systems caused by harmonics in supply systems caused by industrial apparatus and similar equipment. "Voltage disturbance"
<input type="checkbox"/> EN 60913	Limits and methods of measurement of radio disturbance characteristics of broadcast receivers and associated equipment	<input checked="" type="checkbox"/> EN 60924	Information Technology equipment. Limits and methods of measurement
<input type="checkbox"/> EN 60914-1	Limits and methods of measurement of radio disturbance characteristics of broadcast receivers and associated apparatus	<input type="checkbox"/> EN 50061-1	Generic immunity standard Part 1: Residential, commercial and light industry
<input type="checkbox"/> EN 60915	Limits and methods of measurement of radio disturbance characteristics of broadcast transmitters and associated apparatus	<input type="checkbox"/> EN 50062-2	Generic immunity standard Part 2: Industrial environment
<input type="checkbox"/> EN 60920	Immunity from radio interference of broadcast receivers and associated equipment	<input type="checkbox"/> EN 50091-2	Immunity requirements for household appliances tools and similar apparatus power systems (UPS)
<input type="checkbox"/> EN 60922	Limits and methods of measurement of radio disturbance characteristics of information technology equipment		
<input type="checkbox"/> EN IEC 60865	Cable distribution systems: Equipment for receiving audio distribution from sound and television signals		
<input type="checkbox"/> EN 60914-2	Limits and methods of measurement of radio disturbance characteristics of broadcast transmitters and associated apparatus		
<input type="checkbox"/> EN 60915-2	Limits and methods of measurement of radio disturbance characteristics of broadcast receivers and associated apparatus		
<input type="checkbox"/> EN IEC 60865	Cable distribution systems: Equipment for receiving audio distribution from sound and television signals		
<input type="checkbox"/> EN 60922	Limits and methods of measurement of radio disturbance characteristics of information technology equipment		
<input type="checkbox"/> EN IEC 60865	Cable distribution systems: Equipment for receiving audio distribution from sound and television signals		
<input type="checkbox"/> EN 60914-1	Limits and methods of measurement of radio disturbance characteristics of broadcast receivers and associated apparatus		
<input type="checkbox"/> EN 60915-1	Limits and methods of measurement of radio disturbance characteristics of broadcast transmitters and associated apparatus		
<input type="checkbox"/> EN 60920	Immunity from radio interference of broadcast receivers and associated equipment		
<input type="checkbox"/> EN 60922	Limits and methods of measurement of radio disturbance characteristics of information technology equipment		
<input type="checkbox"/> EN IEC 60865	Cable distribution systems: Equipment for receiving audio distribution from sound and television signals		



(EC conformity marking)

The manufacturer also declares the conformity of above mentioned product with the actual required safety standards in accordance with LVD 7323 EEC

Safety requirements for mains operated electronic and related apparatus for household and similar general use
Safety of household and similar electrical appliances

EN 60950

Safety of information technology equipment including electrical business equipment

EN 60959

General and Safety requirements for uninterruptible power systems (UPS)

Manufacturer/Importer

Signature: Jimmy Huang

Name: Timmy Huang

Date: Mar. 20, 2004

(Stamp)

DECLARATION OF CONFORMITY

Per FCC Part 2 Section 2.1077(a)



Responsible Party Name: G.B.T. INC. (U.S.A.)

Address: 17358 Railroad Street

City of Industry, CA 91748

Phone/Fax No: (818) 854-9338/ (818) 854-9339

hereby declares that the product

Product Name: Motherboard

Model Number: 8S648FX-RZ

conforms to the following specifications:

FCC Part 15, Subpart B, Section 15.107(a) and Section 15.109

(a), Class B Digital Device

Supplementary Information:

This device complies with part 15 of the FCC Rules. Operation is subject to the following two conditions: (1) This device may not cause harmful and (2) this device must accept any interference received, including that may cause undesired operation.

Representative Person's Name: ERIC LU

Signature: Eric Lu

Date: Mar. 20, 2004

Preparing Your Computer

Computer motherboards and expansion cards contain very delicate Integrated Circuit (IC) chips. To protect them against damage from static electricity, you should follow some precautions whenever you work on your computer.

1. Unplug your computer when working on the inside.
2. Use a grounded wrist strap before handling computer components. If you do not have one, touch both of your hands to a safely grounded object or to a metal object, such as the power supply case.
3. Hold components by the edges and try not touch the IC chips, leads or connectors, or other components.
4. Place components on a grounded antistatic pad or on the bag that came with the components whenever the components are separated from the system.
5. Ensure that the ATX power supply is switched off before you plug in or remove the ATX power connector on the motherboard.



Installing the motherboard to the chassis

If the motherboard has mounting holes, but they don't line up with the holes on the base and there are no slots to attach the spacers, do not become alarmed you can still attach the spacers to the mounting holes. Just cut the bottom portion of the spacers (the spacer may be a little hard to cut off, so be careful of your hands). In this way you can still attach the motherboard to the base without worrying about short circuits. Sometimes you may need to use the plastic springs to isolate the screw from the motherboard PCB surface, because the circuit wire may be near by the hole. Be careful, don't let the screw contact any printed circuit write or parts on the PCB that are near the fixing hole, otherwise it may damage the board or cause board malfunctioning.

Table of Contents

Chapter 1 Introduction	5
Features Summary	5
8S648FX-RZ Series Motherboard Layout	6
Block Diagram	7
Hardware Installation Process	8
Step 1: Install the Central Processing Unit (CPU)	8
Step 1-1: CPU Installation	9
Step 1-2: CPU Cooling Fan Installation	9
Step 2: Install Memory Modules	10
Step 3: Install AGP Card	11
Step 4: Install I/O Peripherals Cables	11
Step 4-1: I/O Back Panel Introduction	11
Step 4-2: Connectors Introduction	12
Chapter 2 BIOS Setup	19
The Main Menu (For example: BIOS Ver. : F7d)	19
Standard CMOS Features	21
Advanced BIOS Features	23
Integrated Peripherals	24
Power Management Setup	26
PnP/PCI Configurations	28
PC Health Status	29
Frequency/Voltage Control	30
Top Performance	31
Load Fail-Safe Defaults	32
Load Optimized Defaults	32
Set Supervisor/User Password	33
Save & Exit Setup	34
Exit Without Saving	34
Chapter 3 Install Drivers	35

Chapter 1 Introduction

Features Summary

CPU	<ul style="list-style-type: none"> • Socket 478 for Intel® Pentium® 4 (Northwood, Prescott) with HT Technology • Intel® Pentium® 4 800/533/400MHz FSB • 2nd cache depends on CPU
Chipset	<ul style="list-style-type: none"> • North Bridge: SiS 648FX • South Bridge: SiS 963L
Memory	<ul style="list-style-type: none"> • 3 184-pin DDR DIMM sockets, supports up to 3GB DRAM (Max) • Supports DDR400/DDR333/DDR266 DIMM • Supports up to 2 unbuffered DIMM DDR400 • Supports up to 3 unbuffered DIMM DDR333 • Supports only 2.5V DDR SDRAM
Slots	<ul style="list-style-type: none"> • 1 AGP slot 8X/4X(1.5V) device support • 5 PCI slots support
On-Board IDE	<ul style="list-style-type: none"> • 2 IDE controller provide IDE HDD/CD-ROM(IDE1, IDE2) with PIO, Bus Master (Ultra DMA33/ATA66/ATA100/ATA133) operation modes • Can connect up to 4 IDE devices
On-Board Floppy	<ul style="list-style-type: none"> • 1 Floppy port supports 2 FDD with 360K, 720K,1.2M, 1.44M and 2.88M bytes
On-Board Peripherals	<ul style="list-style-type: none"> • 1 Parallel port supports Normal/EPP/ECP mode • 2 Serial port (COMA/COMB) • 6 USB 2.0/1.1 ports (2 x Rear, 4 x Front by cable) • 1 Front Audio connector • 1 PS/2 Keyboard • 1 PS/2 Mouse
On-Board LAN *	<ul style="list-style-type: none"> • Build in ICS 1883 Chipset (10/100 Mbit) * • 1 RJ45 port *
On-Board Sound	<ul style="list-style-type: none"> • CMedia 9761 CODEC • Support 2/4/6 channel • Line Out / Line In / Mic In • SPDIF Out /SPDIF In • CD In/ AUX_IN/ Game Port
BIOS	<ul style="list-style-type: none"> • Licensed AWARD BIOS • Supports Q-Flash™
I/O Control	<ul style="list-style-type: none"> • IT8705
Hardware Monitor	<ul style="list-style-type: none"> • CPU/System Fan Revolution detect • CPU/System Fan Fail Warning • CPU Temperature Detect • System Voltage Detect
Additional Features	<ul style="list-style-type: none"> • Supports @BIOS™ • Supports EasyTune 4™
Overclocking	<ul style="list-style-type: none"> • Over Voltage (DDR/AGP) by BIOS • Over Clock (DDR/AGP/CPU/PCI) by BIOS
Form Factor	<ul style="list-style-type: none"> • ATX size form factor, 29.5cm x 21cm

*** Only for 8S648FX-RZ.

8S648FX-RZ Series Motherboard Layout

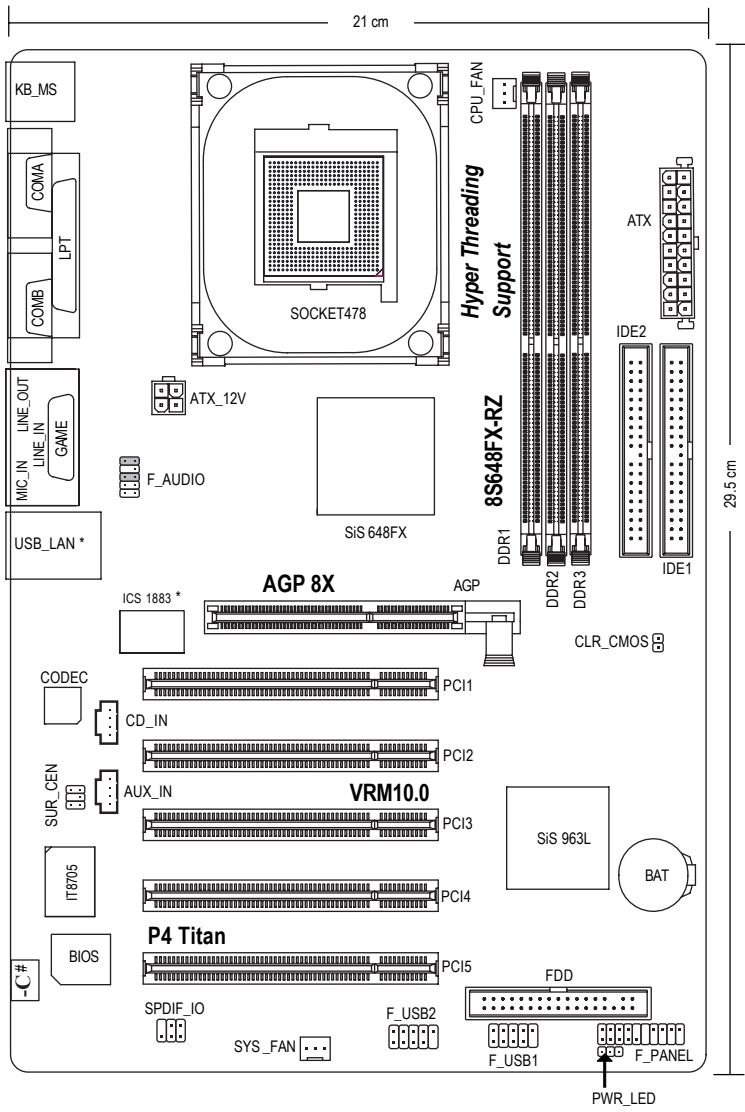

*** Only for 8S648FX-RZ.

Only for 8S648FX-RZ-C.

Block Diagram

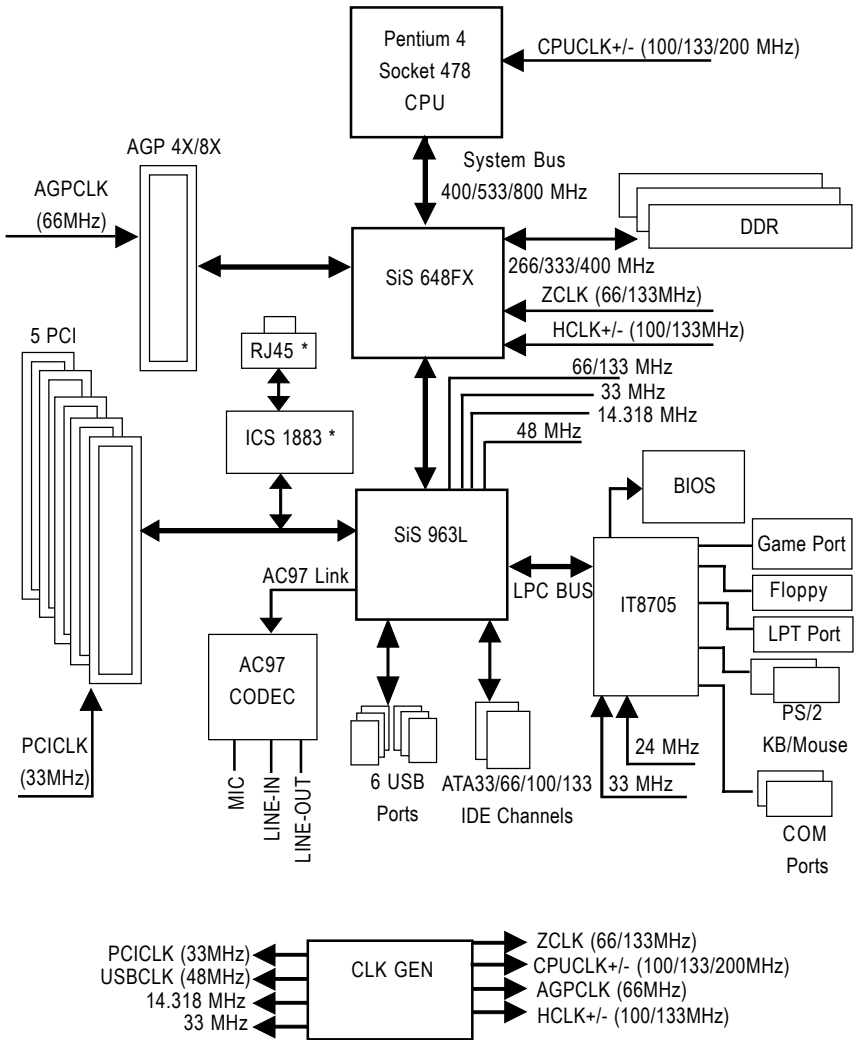

*** Only for 8S648FX-RZ.

Hardware Installation Process

To set up your computer, you must complete the following steps:

- Step 1- Install the Central Processing Unit (CPU)
- Step 2- Install memory modules
- Step 3- Install expansion cards
- Step 4- Install I/O Peripherals Cables

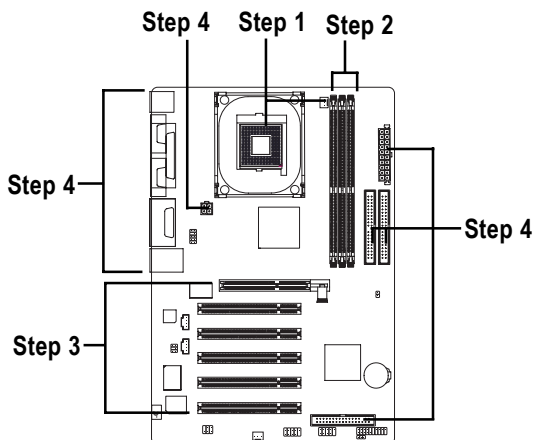

Step 1: Install the Central Processing Unit (CPU)



CAUTION

Before installing the processor, adhere to the following warning:

1. Please make sure the CPU type is supported by the motherboard.
2. The processor will overheat without the heatsink and/or fan, resulting in permanent irreparable damage.
3. If you do not match the CPU socket Pin 1 and CPU cut edge well, it will cause improper installation. Please change the insert orientation.
4. Apply thermal grease between the processor and cooling fan.
5. Never run the processor without the heatsink properly and firmly attached. Permanent damage will result.
6. Please set the CPU host frequency in accordance with your processor's specifications. We don't recommend you to set the system bus frequency over the CPU's specification because these specific bus frequencies are not the standard specifications for CPU, chipset and most of the peripherals. Whether your system can run under these specific bus frequencies properly will depend on your hardware configurations, including CPU, Memory, Cards...etc.



NOTE

HT functionality requirement content :

Enabling the functionality of Hyper-Threading Technology for your computer system requires all of the following platform components:

- CPU: An Intel® Pentium 4 Processor with HT Technology
- Chipset: An SiS® Chipset that supports HT Technology
- BIOS: A BIOS that supports HT Technology and has it enabled
- OS: An operation system that has optimizations for HT Technology

Step 1-1: CPU Installation

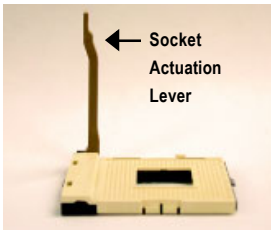

Figure 1.
Pull the rod to the 90-degree directly.

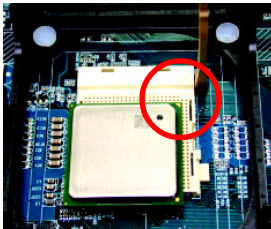

Figure 2.
Locate Pin 1 in the socket and look for a (golden) cut edge on the CPU upper corner. Insert the CPU into the socket. (Do not force the CPU into the socket.) Then move the socket lever to the locked position while holding pressure on the center of the CPU.

Step 1-2: CPU Cooling Fan Installation



Figure 1.
Apply the thermal tape(or grease) to provide better heat conduction between your CPU and cooling fan.



Figure 2.
Fasten the cooling fan supporting-base onto the CPU socket on the motherboard.

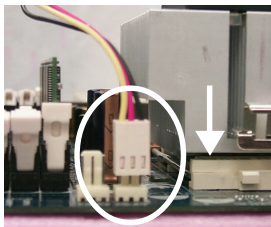

Figure 3.
Make sure the CPU fan is plugged to the CPU fan connector, than install complete.

Step 2: Install Memory Modules



Before installing the memory modules, adhere to the following warning:

1. Please note that the DIMM module can only fit in one direction due to the one notch. Wrong orientation will cause improper installation. Please change the insert orientation.

The motherboard has 3 dual inline memory module (DIMM) sockets. The BIOS will automatically detects memory type and size. To install the memory module, just push it vertically into the DIMM socket. The DIMM module can only fit in one direction due to the notch. Memory size can vary between sockets.

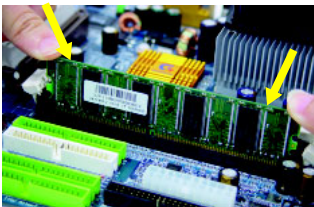
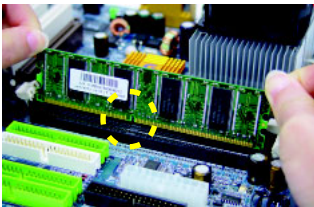
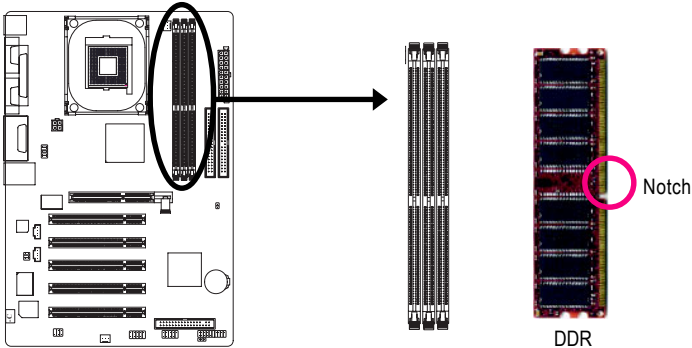

1. The DIMM socket has a notch, so the DIMM memory module can only fit in one direction.
2. Insert the DIMM memory module vertically into the DIMM socket. Then push it down.
3. Close the plastic clip at both edges of the DIMM sockets to lock the DIMM module. Reverse the installation steps when you wish to remove the DIMM module.

Step 3: Install AGP Card

1. Read the relateAGP card's instruction document before install the AGP card into the computer.
2. If your AGP card has "AGP 8X/4X(1.5V)" (show below), please make sure your AGP card is AGP 8X/4X(1.5V).



3. Please carefully pull out the small white- drawable bar at the end of the AGP slot when you try to install/ Uninstall the AGP card. Please align the AGP card to the onboard AGP slot and press firmly down on the slot .Make sure your AGP card is locked by the small white- drawable bar.

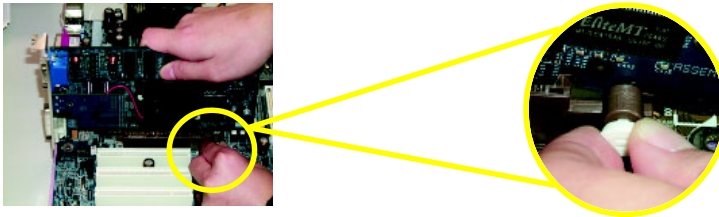

Step 4: Install I/O Peripherals Cables

Step 4-1: I/O Back Panel Introduction

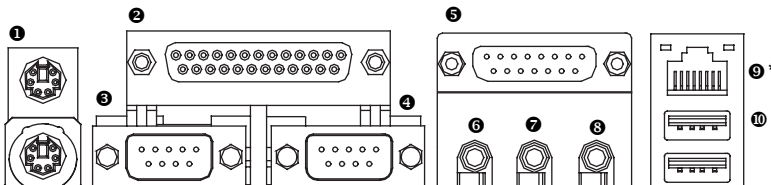

- ❶ **PS/2 Keyboard and PS/2 Mouse connector**
This connector supports standard PS/2 keyboard and PS/2 mouse.
- ❷ **Parallel port (LPT)**
Device like printer can be connected to Parallel port.
- ❸/❹ **Serial port (COMA/COMB)**
Mouse and modem etc. can be connected to Serial port.
- ❺ **Game/MIDI port**
This connector supports joystick, MIDI keyboard and other relate audio devices.
- ❻ **Line Out jack**
Connect the stereo speakers or earphone to this connector.
- ❼ **Line In jack**
Devices like CD-ROM, walkman etc. can be connect to Line In jack.

*** Only for 8S648FX-RZ.

8 MIC In jack

Microphone can be connect to MIC In jack.

After installation of the audio driver, you are able to use 2/4/6-channel audio feature by software selection. You can connect "Front speaker" to "Line Out" jack, Connect "Rear speaker" to "Line In" jack and connect "Center/Subwoofer" to "MIC In" jack.

9 LAN port *

LAN is fast Ethernet with 10/100Mbps speed.

10 USB port

Before you connect your device(s) into USB connector(s), please make sure your device(s) such as USB keyboard, mouse, scanner, zip, speaker...etc. Have a standard USB interface. Also make sure your OS supports USB controller. If your OS does not support USB controller, please contact OS vendor for possible patch or driver upgrade. For more information please contact your OS or device(s) vendors.

Step 4-2: Connectors Introduction

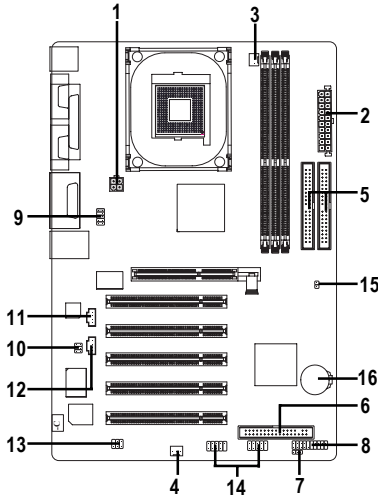

1) ATX_12V	9) F_AUDIO
2) ATX	10) SUR_CEN
3) CPU_FAN	11) CD_IN
4) SYS_FAN	12) AUX_IN
5) IDE1 / IDE2	13) SPDIF_IO
6) FDD	14) F_USB1 / F_USB2
7) PWR_LED	15) CLR_CMOS
8) F_PANEL	16) BAT

*** Only for 8S648FX-RZ.

1) ATX_12V (+12V Power Connector)

This connector (ATX_12V) supplies the CPU operation voltage (Vcore).
If this "ATX_12V connector" is not connected, system cannot boot.

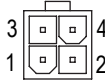
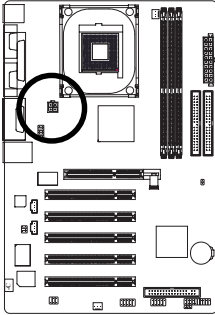

Pin No.	Definition
1	GND
2	GND
3	+12V
4	+12V

2) ATX (ATX Power)

AC power cord should only be connected to your power supply unit after ATX power cable and other related devices are firmly connected to the mainboard.

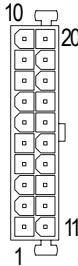
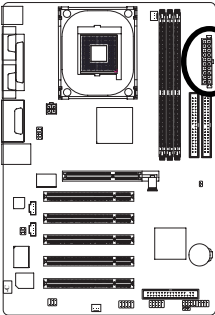

Pin No.	Definition	Pin No.	Definition
1	3.3V	11	3.3V
2	3.3V	12	-12V
3	GND	13	GND
4	VCC	14	PS_ON(soft on/off)
5	GND	15	GND
6	VCC	16	GND
7	GND	17	GND
8	Power Good	18	-5V
9	5V SB (stand by +5V)	19	VCC
10	+12V	20	VCC

3) CPU_FAN (CPU Fan Connector)

Please note, a proper installation of the CPU cooler is essential to prevent the CPU from running under abnormal condition or damaged by overheating. The CPU fan connector supports Max. current up to 600 mA.

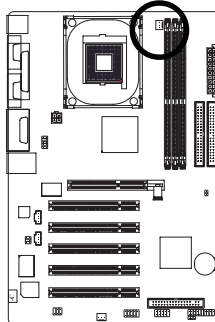

Pin No.	Definition
1	GND
2	+12V
3	Sense

4) SYS_FAN (System Fan Connector)

This connector allows you to link with the cooling fan on the system case to lower the system temperature.

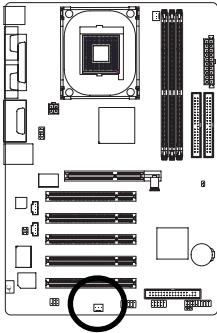

Pin No.	Definition
1	GND
2	+12V
3	Sense

5) IDE1 / IDE2 (IDE1 / IDE2 Connector)

Important Notice: Please connect first hard disk to IDE1 and connect CD-ROM to IDE2. The red stripe of the ribbon cable must be the same side with the Pin1.

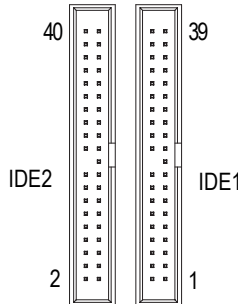
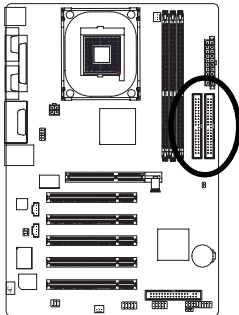

6) FDD (Floppy Connector)

Please connect the floppy drive ribbon cables to FDD. It supports 360K, 1.2M, 720K, 1.44M and 2.88M bytes floppy disk types.

The red stripe of the ribbon cable must be the same side with the Pin1.

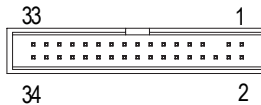
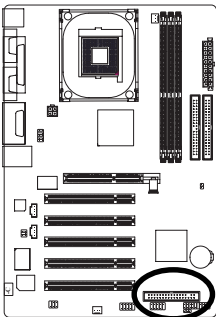

7) PWR_LED

PWR_LED is connect with the system power indicator to indicate whether the system is on/off. It will blink when the system enters suspend mode. If you use dual color LED, power LED will turn to another color.

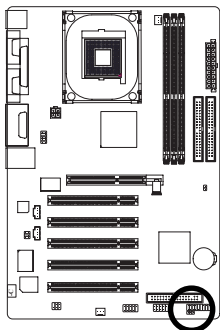

Pin No.	Definition
1	MPD+
2	MPD-
3	MPD-

8) F_PANEL (2 x 10 pins Connector)

Please connect the power LED, PC speaker, reset switch and power switch etc of your chassisfront panel to the F_PANEL connector according to the pin assignment below.

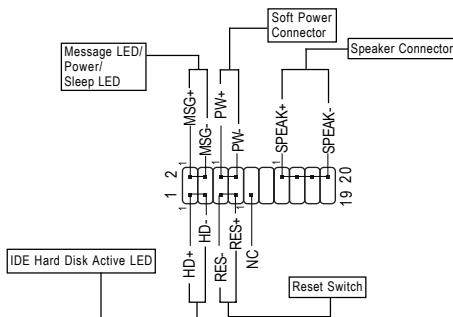
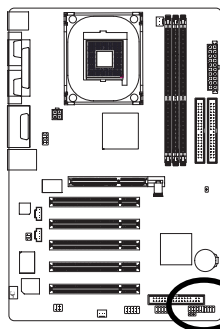

HD (IDE Hard Disk Active LED)	Pin 1: LED anode(+) Pin 2: LED cathode(-)
SPK (Speaker Connector)	Pin 1: VCC(+) Pin 2- Pin 3: NC Pin 4: Data(-)
RES (Reset Switch)	Open: Normal Operation Close: Reset Hardware System
PW (Soft Power Connector)	Open: Normal Operation Close: Power On/Off
MSG (Message LED/ Power/ Sleep LED)	Pin 1: LED anode(+) Pin 2: LED cathode(-)
NC	NC

9) F_AUDIO (Front Audio Connector)

If you want to use Front Audio connector, you must remove 5-6, 9-10 Jumper.

In order to utilize the front audio header, your chassis must have front audio connector. Also please make sure the pin assignment on the cable is the same as the pin assignment on the MB header. To find out if the chassis you are buying support front audio connector, please contact your dealer. Please note, you can have the alternative of using front audio connector or of using rear audio connector to play sound.

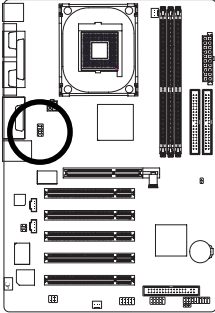

Pin No.	Definition
1	MIC
2	GND
3	REF
4	Power
5	Front Audio (R)
6	Rear Audio (R)
7	Reserved
8	No Pin
9	Front Audio (L)
10	Rear Audio (L)

10) SUR_CEN (Surround Center Connector)

Please contact your nearest dealer for optional SUR_CEN cable.

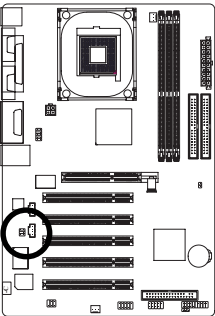

Pin No.	Definition
1	SUR OUTL
2	SUR OTR
3	GND
4	No Pin
5	CENTER_OUT
6	BASS_OUT

11) CD_IN (CD In Connector)

Connect CD-ROM or DVD-ROM audio out to the connector.

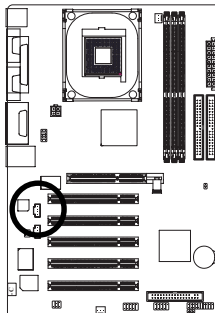

Pin No.	Definition
1	CD-L
2	GND
3	GND
4	CD-R

12) AUX_IN (AUX In Connector)

Connect other device (such as PCI TV Tuner audio out) to the connector.

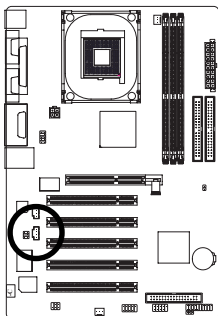

Pin No.	Definition
1	AUX-L
2	GND
3	GND
4	AUX-R

13) SPDIF_IO (SPDIF In/Out Connector)

The SPDIF output is capable of providing digital audio to external speakers or compressed AC3 data to an external Dolby Digital Decoder. Use this feature only when your stereo system has digital input function. Be careful with the polarity of the SPDIF_IO connector. Check the pin assignment carefully while you connect the SPDIF cable, incorrect connection between the cable and connector will make the device unable to work or even damage it. For optional SPDIF cable, please contact your local dealer.

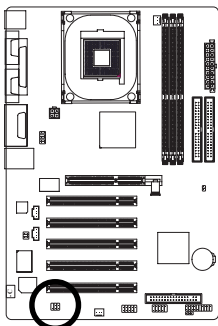

Pin No.	Definition
1	VCC
2	No Pin
3	SPDIF
4	SPDIF
5	GND
6	GND

14) F_USB1 / F_USB2 (Front USB Connector)

Be careful with the polarity of the front USB connector. Check the pin assignment carefully while you connect the front USB cable, incorrect connection between the cable and connector will make the device unable to work or even damage it. For optional front USB cable, please contact your local dealer.

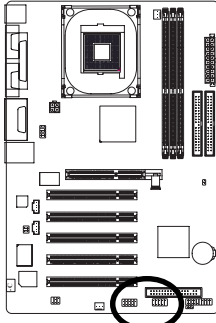

Pin No.	Definition
1	Power
2	Power
3	USB DX-
4	USB Dy-
5	USB DX+
6	USB Dy+
7	GND
8	GND
9	No Pin
10	NC

15) CLR_CMOS (Clear CMOS)

You may clear the CMOS data to its default values by this jumper. To clear CMOS, temporarily short 1-2 pin. Default doesn't include the "Shunter" to prevent from improper use this jumper.

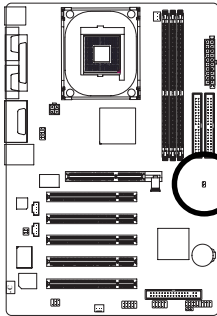

1  Open: Normal

1  Short: Clear CMOS

16) BAT (BATTERY)

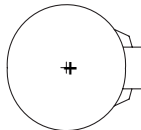
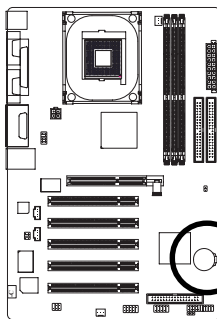

CAUTION

- ❖ Danger of explosion if battery is incorrectly replaced.
- ❖ Replace only with the same or equivalent type recommended by the manufacturer.
- ❖ Dispose of used batteries according to the manufacturer's instructions.

If you want to erase CMOS...

1. Turn OFF the computer and unplug the power cord.
2. Remove the battery, wait for 30 second.
3. Re-install the battery.
4. Plug the power cord and turn ON the computer.

Chapter 2 BIOS Setup

BIOS Setup is an overview of the BIOS Setup Program. The program that allows users to modify the basic system configuration. This type of information is stored in battery-backed CMOS RAM so that it retains the Setup information when the power is turned off.

ENTERING SETUP

Powering ON the computer and pressing immediately will allow you to enter Setup. If you require more advanced BIOS settings, please go to "Advanced BIOS" setting menu. To enter Advanced BIOS setting menu, press "Ctrl+F1" key on the BIOS screen.

CONTROL KEYS

<↑><↓><←><→>	Move to select item
<Enter>	Select Item
<Esc>	Main Menu - Quit and not save changes into CMOS Status Page Setup Menu and Option Page Setup Menu - Exit current page and return to Main Menu
<+ /PgUp>	Increase the numeric value or make changes
<- /PgDn>	Decrease the numeric value or make changes
<F1>	General help, only for Status Page Setup Menu and Option Page Setup Menu
<F2>	Item Help
<F5>	Restore the previous CMOS value from CMOS, only for Option Page Setup Menu
<F6>	Load the file-safe default CMOS value from BIOS default table
<F7>	Load the Optimized Defaults
<F8>	Q-Flash utility
<F9>	System Information
<F10>	Save all the CMOS changes, only for Main Menu

Main Menu

The on-line description of the highlighted setup function is displayed at the bottom of the screen.

Status Page Setup Menu / Option Page Setup Menu

Press F1 to pop up a small help window that describes the appropriate keys to use and the possible selections for the highlighted item. To exit the Help Window press <Esc>.

The Main Menu (For example: BIOS Ver. : F7d)

Once you enter Award BIOS CMOS Setup Utility, the Main Menu (as figure below) will appear on the screen. The Main Menu allows you to select from eight setup functions and two exit choices. Use arrow keys to select among the items and press <Enter> to accept or enter the sub-menu.

CMOS Setup Utility-Copyright (C) 1984-2004 Award Software

<ul style="list-style-type: none"> ▶ Standard CMOS Features ▶ Advanced BIOS Features ▶ Integrated Peripherals ▶ Power Management Setup ▶ PnP/PCI Configurations ▶ PC Health Status ▶ Frequency/Voltage Control 	<ul style="list-style-type: none"> Top Performance Load Fail-Safe Defaults Load Optimized Defaults Set Supervisor Password Set User Password Save & Exit Setup Exit Without Saving
ESC: Quit	↑↓←→: Select Item
F8: Q-Flash	F10: Save & Exit Setup
Time, Date, Hard Disk Type...	



If you can't find the setting you want, please press "Ctrl+F1" to search the advanced option hidden.

- **Standard CMOS Features**

This setup page includes all the items in standard compatible BIOS.

- **Advanced BIOS Features**

This setup page includes all the items of Award special enhanced features.

- **Integrated Peripherals**

This setup page includes all onboard peripherals.

- **Power Management Setup**

This setup page includes all the items of Green function features.

- **PnP/PCI Configuration**

This setup page includes all the configurations of PCI & PnP ISA resources.

- **PC Health Status**

This setup page is the System auto detect Temperature, voltage, fan, speed.

- **Frequency/Voltage Control**

This setup page is control CPU clock and frequency ratio.

- **Top Performance**

If you wish to maximize the performance of your system, set "Top Performance" as "Enabled".

- **Load Fail-Safe Defaults**

Fail-Safe Defaults indicates the value of the system parameters which the system would be in safe configuration.

- **Load Optimized Defaults**

Optimized Defaults indicates the value of the system parameters which the system would be in best performance configuration.

- **Set Supervisor Password**

Change, set, or disable password. It allows you to limit access to the system and Setup, or just to Setup.

- **Set User Password**

Change, set, or disable password. It allows you to limit access to the system.

- **Save & Exit Setup**

Save CMOS value settings to CMOS and exit setup.

- **Exit Without Saving**

Abandon all CMOS value changes and exit setup.

Standard CMOS Features

CMOS Setup Utility-Copyright (C) 1984-2004 Award Software
Standard CMOS Features

Date (mm:dd:yy)	Fri, Jan 9 2004	Item Help
Time (hh:mm:ss)	22:31:24	Menu Level▶
▶ IDE Primary Master	[None]	Change the day, month, year
▶ IDE Primary Slave	[None]	
▶ IDE Secondary Master	[None]	<Week>
▶ IDE Secondary Slave	[None]	Sun. to Sat.
Drive A	[1.44M, 3.5"]	<Month>
Drive B	[None]	Jan. to Dec.
Floppy 3 Mode Support	[Disabled]	
Holt On	[All, But Keyboard]	<Day>
		1 to 31 (or maximum allowed in the month)
Base Memory	640K	
Extended Memory	127M	<Year>
Total Memory	128M	1999 to 2098
↑↓→←: Move Enter: Select +/-/PU/PD: Value F10: Save ESC: Exit F1: General Help F5: Previous Values F6: Fail-Save Default F7: Optimized Defaults		

☞ Date

The date format is <week>, <month>, <day>, <year>.

- ▶▶ Week The week, from Sun to Sat, determined by the BIOS and is display only
- ▶▶ Month The month, Jan. Through Dec.
- ▶▶ Day The day, from 1 to 31 (or the maximum allowed in the month)
- ▶▶ Year The year, from 1999 through 2098

☞ Time

The times format in <hour> <minute> <second>. The time is calculated base on the 24-hour military-time clock. For example, 1 p.m. is 13:00:00.

☞ IDE Primary Master, Slave / IDE Secondary Master, Slave

The category identifies the types of hard disk from drive C to F that has been installed in the computer. There are two types: auto type, and manual type. Manual type is user-definable; Auto type which will automatically detect HDD type.

Note that the specifications of your drive must match with the drive table. The hard disk will not work properly if you enter improper information for this category.

If you select User Type, related information will be asked to enter to the following items. Enter the information directly from the keyboard and press <Enter>. Such information should be provided in the documentation form your hard disk vendor or the system manufacturer.

- ▶▶ Cylinder Number of cylinders
- ▶▶ Head Number of heads
- ▶▶ Precomp Write precomp
- ▶▶ Landing Zone Landing zone
- ▶▶ Sector Number of sectors

If a hard disk has not been installed, select NONE and press <Enter>.

☞ Drive A / Drive B

The category identifies the types of floppy disk drive A or drive B that has been installed in the computer.

- ▶▶ None No floppy drive installed
- ▶▶ 360K, 5.25" 5.25 inch PC-type standard drive; 360K byte capacity.
- ▶▶ 1.2M, 5.25" 5.25 inch AT-type high-density drive; 1.2M byte capacity (3.5 inch when 3 Mode is Enabled).
- ▶▶ 720K, 3.5" 3.5 inch double-sided drive; 720K byte capacity
- ▶▶ 1.44M, 3.5" 3.5 inch double-sided drive; 1.44M byte capacity.
- ▶▶ 2.88M, 3.5" 3.5 inch double-sided drive; 2.88M byte capacity.

☞ Floppy 3 Mode Support (for Japan Area)

- ▶▶ Disabled Normal Floppy Drive. (Default value)
- ▶▶ Drive A Drive A is 3 mode Floppy Drive.
- ▶▶ Drive B Drive B is 3 mode Floppy Drive.
- ▶▶ Both Drive A & B are 3 mode Floppy Drives.

☞ Halt on

The category determines whether the computer will stop if an error is detected during power up.

- ▶▶ No Errors The system boot will not stop for any error that may be detected and you will be prompted.
- ▶▶ All Errors Whenever the BIOS detects a non-fatal error the system will be stopped.
- ▶▶ All, But Keyboard The system boot will not stop for a keyboard error; it will stop for all other errors. (Default value)
- ▶▶ All, But Diskette The system boot will not stop for a disk error; it will stop for all other errors.
- ▶▶ All, But Disk/Key The system boot will not stop for a keyboard or disk error; it will stop for all other errors.

☞ Memory

The category is display-only which is determined by POST (Power On Self Test) of the BIOS.

▶▶ Base Memory

The POST of the BIOS will determine the amount of base (or conventional) memory installed in the system.

The value of the base memory is typically 512K for systems with 512K memory installed on the motherboard, or 640K for systems with 640K or more memory installed on the motherboard.

▶▶ Extended Memory

The BIOS determines how much extended memory is present during the POST.

This is the amount of memory located above 1 MB in the CPU's memory address map.

Advanced BIOS Features

CMOS Setup Utility-Copyright (C) 1984-2004 Award Software
Advanced BIOS Features

First Boot Device	[Floppy]	Item Help
Second Boot Device	[HDD-0]	Menu Level▶
Third Boot Device	[CDROM]	Select Boot Device
Boot Up Floppy Seek	[Disabled]	priority
Password Check	[Setup]	
CPU Hyper-Threading #	[Enabled]	[Floppy]
Init Display First	[ACP]	Boot from floppy
		[LS120]
		Boot from LS120
		[HDD-0]
		Boot from First HDD
		[HDD-1]
		Boot from Second HDD
↑↓→←: Move Enter: Select +/-/PU/PD: Value F10: Save ESC: Exit F1: General Help F5: Previous Values F6: Fail-Save Default F7: Optimized Defaults		



"#" System will detect automatically and show up when you install the Intel® Pentium® 4 processor with HT Technology.

First / Second / Third Boot Device

- ▶ Floppy Select your boot device priority by Floppy.
- ▶ LS120 Select your boot device priority by LS120.
- ▶ HDD-0~3 Select your boot device priority by HDD-0~3.
- ▶ SCSI Select your boot device priority by SCSI.
- ▶ CDROM Select your boot device priority by CDROM.
- ▶ ZIP Select your boot device priority by ZIP.
- ▶ USB-FDD Select your boot device priority by USB-FDD.
- ▶ USB-ZIP Select your boot device priority by USB-ZIP.
- ▶ USB-CDROM Select your boot device priority by USB-CDROM.
- ▶ USB-HDD Select your boot device priority by USB-HDD.
- ▶ LAN Select your boot device priority by LAN.
- ▶ Disabled Select your boot device priority by Disabled.

Boot Up Floppy Seek

During POST, BIOS will determine the floppy disk drive installed is 40 or 80 tracks. 360K type is 40 tracks 720K, 1.2M and 1.44M are all 80 tracks.

- ▶ Enabled BIOS searches for floppy disk drive to determine it is 40 or 80 tracks. Note that BIOS can not tell from 720K, 1.2M or 1.44M drive type as they are all 80 tracks.
- ▶ Disabled BIOS will not search for the type of floppy disk drive by track number. Note that there will not be any warning message if the drive installed is 360K. (Default value)

Password Check

- ▶ System The system can not boot and can not access to Setup page will be denied if the correct password is not entered at the prompt.
- ▶ Setup The system will boot, but access to Setup will be denied if the correct password is not entered at the prompt. (Default value)

☞ CPU Hyper-Threading

- ▶ Enabled Enables CPU Hyper Threading Feature. Please note that this feature is only working for operating system with multi processors mode supported. (Default value)
- ▶ Disabled Disables CPU Hyper Threading.

☞ Init Display First

Select the first initiation of monitor or display from AGP or PCI VGA card.

- ▶ AGP Set Init display first to AGP. (Default value)
- ▶ PCI Set Init display first to PCI.

Integrated Peripherals

CMOS Setup Utility-Copyright (C) 1984-2004 Award Software
Integrated Peripherals

Item	Value	Item Help
IDE1 Conductor Cable	[Auto]	Menu Level ▶
IDE2 Conductor Cable	[Auto]	
On-Chip Primary PCI IDE	[Enabled]	
On-Chip Secondary PCI IDE	[Enabled]	
AC97 Audio	[Enabled]	[Auto] Auto-detect IDE cable type
Onboard LAN device *	[Enabled]	
USB Controller	[Enabled]	
USB Legacy Support	[Disabled]	[ATA66/100/133]
Onboard Serial Port 1	[3F8/IRQ4]	Set Conductor cable to ATA66/100/133(80 -pins)
Onboard Serial Port 2	[2F8/IRQ3]	
Onboard Parallel Port	[378/IRQ7]	
Parallel Port Mode	[SPP]	
x ECP Mode Use DMA	3	[ATA33]
Game Port Address	[201]	Set Conductor cable to ATA33(40-pins)
Midi Port Address	[330]	
Midi Port IRQ	[10]	

↑↓→←: Move Enter: Select +/-/PU/PD: Value F10: Save ESC: Exit F1: General Help
 F5: Previous Values F6: Fail-Save Default F7: Optimized Defaults

☞ IDE1 Conductor Cable

- ▶ Auto Will be automatically detected by BIOS. (Default value)
- ▶ ATA66/100 Set IDE1 Conductor Cable to ATA66/100 (Please make sure your IDE device and cable is compatible with ATA66/100).
- ▶ ATA33 Set IDE1 Conductor Cable to ATA33 (Please make sure your IDE device and cable is compatible with ATA33).

☞ IDE2 Conductor Cable

- ▶ Auto Will be automatically detected by BIOS. (Default value)
- ▶ ATA66/100 Set IDE2 Conductor Cable to ATA66/100 (Please make sure your IDE device and cable is compatible with ATA66/100).
- ▶ ATA33 Set IDE2 Conductor Cable to ATA33 (Please make sure your IDE device and cable is compatible with ATA33).

☞ On-Chip Primary PCI IDE

- ▶ Enabled Enable onboard 1st channel IDE port. (Default value)
- ▶ Disabled Disable onboard 1st channel IDE port.

☞ On-Chip Secondary PCI IDE

- ▶ Enabled Enable onboard 2nd channel IDE port. (Default value)
- ▶ Disabled Disable onboard 2nd channel IDE port.

*** Only for 8S648FX-RZ.

☞ **AC97 Audio**

- ▶▶ Enabled Enable onboard AC'97 audio function. (Default value)
- ▶▶ Disabled Disable this function.

☞ **On Board LAN device ***

- ▶▶ Disabled Disable this function.
- ▶▶ Enabled Enable Onboard Lan Chip device. (Default value)

☞ **USB Controller**

- ▶▶ Enabled Enable USB Controller. (Default value)
- ▶▶ Disabled Disable USB Controller.

☞ **USB Legacy Support**

When USB keyboard or mouse is installed, please set at Enabled.

- ▶▶ Enabled Enable USB keyboard or mouse support.
- ▶▶ Disabled Disable USB keyboard or mouse support. (Default value)

☞ **Onboard Serial Port 1**

- ▶▶ Auto BIOS will automatically setup the port 1 address.
- ▶▶ 3F8/IRQ4 Enable onboard Serial port 1 and address is 3F8. (Default value)
- ▶▶ 2F8/IRQ3 Enable onboard Serial port 1 and address is 2F8.
- ▶▶ 3E8/IRQ4 Enable onboard Serial port 1 and address is 3E8.
- ▶▶ 2E8/IRQ3 Enable onboard Serial port 1 and address is 2E8.
- ▶▶ Disabled Disable onboard Serial port 1.

☞ **Onboard Serial Port 2**

- ▶▶ Auto BIOS will automatically setup the port 2 address.
- ▶▶ 3F8/IRQ4 Enable onboard Serial port 2 and address is 3F8.
- ▶▶ 2F8/IRQ3 Enable onboard Serial port 2 and address is 2F8. (Default value)
- ▶▶ 3E8/IRQ4 Enable onboard Serial port 2 and address is 3E8.
- ▶▶ 2E8/IRQ3 Enable onboard Serial port 2 and address is 2E8.
- ▶▶ Disabled Disable onboard Serial port 2.

☞ **Onboard Parallel port**

- ▶▶ 378/IRQ7 Enable onboard LPT port and address is 378/IRQ7. (Default value)
- ▶▶ 278/IRQ5 Enable onboard LPT port and address is 278/IRQ5.
- ▶▶ Disabled Disable onboard LPT port.
- ▶▶ 3BC/IRQ7 Enable onboard LPT port and address is 3BC/IRQ7.

☞ **Parallel Port Mode**

- ▶▶ SPP Using Parallel port as Standard Parallel Port. (Default value)
- ▶▶ EPP Using Parallel port as Enhanced Parallel Port.
- ▶▶ ECP Using Parallel port as Extended Capabilities Port.
- ▶▶ ECP+EPP Using Parallel port as ECP & EPP mode.

☞ **ECP Mode Use DMA**

- ▶▶ 3 Set ECP Mode Use DMA to 3. (Default value)
- ▶▶ 1 Set ECP Mode Use DMA to 1.

*** Only for 8S648FX-RZ.

Game Port Address

- ▶▶ 201 Set Game Port Address to 201. (Default value)
- ▶▶ 209 Set Game Port Address to 209.
- ▶▶ Disabled Disable this function.

Midi Port Address

- ▶▶ 300 Set Midi Port Address to 300.
- ▶▶ 330 Set Midi Port Address to 330. (Default value)
- ▶▶ Disabled Disable this function.

Midi Port IRQ

- ▶▶ 5 Set Midi Port IRQ to 5.
- ▶▶ 10 Set Midi Port IRQ to 10. (Default value)

Power Management Setup

CMOS Setup Utility-Copyright (C) 1984-2004 Award Software
Power Management Setup

		Item Help
ACPI Suspend Type	[S1 (POS)]	
Soft-Off by PWR_BTN	[Off]	Menu Level▶
System After AC Back	[Off]	[S1]
IRQ [3-7, 9-15], NMI	[Enabled]	Set suspend type to
ModemRingOn	[Enabled]	Power On Suspend under
PME Event Wake Up	[Enabled]	ACPI OS
Power On by Keyboard	[Disabled]	
Power On by Mouse	[Disabled]	[S3]
Resume by Alarm	[Disabled]	Set suspend type to
x Month Alarm	NA	Suspend to RAM under
x Day (of Month)	0	ACPI OS
x Time (hh:mm:ss)	0 0 0	

↑↓←→: Move Enter: Select +/-/PU/PD: Value F10: Save ESC: Exit F1: General Help
 F5: Previous Values F6: Fail-Save Default F7: Optimized Defaults

ACPI Suspend Type

- ▶▶ S1(POS) Set ACPI suspend type to S1. (Default value)
- ▶▶ S3(STR) Set ACPI suspend type to S3.

Soft-off by PWR-BTTN

- ▶▶ Off The user press the power button once, he can turn off the system. (Default value)
- ▶▶ Suspend The user press the power button once, then he can enter suspend mode.

System after AC Back

- ▶▶ LastState When AC-power back to the system, the system will return to the Last state before AC-power off.
- ▶▶ Off When AC-power back to the system, the system will be in "Off" state. (Default value)
- ▶▶ On When AC-power back to the system, the system will be in "On" state.

☞ **IRQ [3-7, 9-15], NMI**

- ▶▶ Disabled Disable this function.
- ▶▶ Enabled Enable this function. (Default value)

☞ **ModemRingOn**

- ▶▶ Disabled Disable Modem Ring on function.
- ▶▶ Enabled Enable Modem Ring on function. (Default value)

☞ **PME Event Wake Up**

- ▶▶ Disabled Disable this function.
- ▶▶ Enabled Enable PME as wake up event. (Default value)

☞ **Power On by Keyboard**

- ▶▶ Password Enter from 1 to 8 characters to set the keyboard power on password.
- ▶▶ Disabled Disabled this function. (Default value)
- ▶▶ Any Key Set Keyboard power on by any key.

☞ **Power On by Mouse**

- ▶▶ Enabled Enable Power On by Mouse function.
- ▶▶ Disabled Disable this function. (Default value)

☞ **Resume by Alarm**

You can set "Resume by Alarm" item to enabled and key in Data/time to power on system.

- ▶▶ Disabled Disable this function. (Default Value)
- ▶▶ Enabled Enable alarm function to POWER ON system.

If RTC Alarm Lead To Power On is Enabled.

Month Alarm : NA, 1~12

Day (of Month) : 0~31

Time (hh: mm: ss) : (0~23) : (0~59) : (0~59)

PnP/PCI Configurations

CMOS Setup Utility-Copyright (C) 1984-2004 Award Software
PnP/PCI Configurations

PCI 4 IRQ Assignment	[Auto]	Item Help
PCI 1/5 IRQ Assignment	[Auto]	Menu Level ▶
PCI 2 IRQ Assignment	[Auto]	
PCI 3 IRQ Assignment	[Auto]	
↑↓→←: Move Enter: Select +/-/PU/PD: Value F10: Save ESC: Exit F1: General Help F5: Previous Values F6: Fail-Save Default F7: Optimized Defaults		

PCI 4 IRQ Assignment

- ▶▶ Auto Auto assign IRQ to PCI 4. (Default value)
- ▶▶ 3,4,5,7,9,10,11,12,14,15 Set IRQ 3,4,5,7,9,10,11,12,14,15 to PCI 4.

PCI 1/PCI 5 IRQ Assignment

- ▶▶ Auto Auto assign IRQ to PCI 1/PCI 5. (Default value)
- ▶▶ 3,4,5,7,9,10,11,12,14,15 Set IRQ 3,4,5,7,9,10,11,12,14,15 to PCI 1/PCI 5.

PCI 2 IRQ Assignment

- ▶▶ Auto Auto assign IRQ to PCI 2. (Default value)
- ▶▶ 3,4,5,7,9,10,11,12,14,15 Set IRQ 3,4,5,7,9,10,11,12,14,15 to PCI 2.

PCI 3 IRQ Assignment

- ▶▶ Auto Auto assign IRQ to PCI 3. (Default value)
- ▶▶ 3,4,5,7,9,10,11,12,14,15 Set IRQ 3,4,5,7,9,10,11,12,14,15 to PCI 3.

PC Health Status

CMOS Setup Utility-Copyright (C) 1984-2004 Award Software
PC Health Status

		Item Help
Vcore	1.54V	
DDR25V	2.544V	Menu Level▶
+3.3V	3.360V	
+12V	11.92V	
Current CPU Temperature	41°C	
Current CPU FAN Speed	4440 RPM	
Current SYSTEM FAN Speed	0 RPM	

↑↓→←: Move	Enter: Select	+/-/PU/PD: Value	F10: Save	ESC: Exit	F1: General Help
F5: Previous Values	F6: Fail-Save Default	F7: Optimized Defaults			

- ☞ **Current Voltage (V) Vcore / DDR25V / +3.3V / +12V**
 - ▶▶ Detect system's voltage status automatically.
- ☞ **Current CPU Temperature**
 - ▶▶ Detect CPU temperature automatically.
- ☞ **Current CPU/SYSTEM FAN Speed (RPM)**
 - ▶▶ Detect CPU/SYSTEM Fan speed status automatically.

Frequency/Voltage Control

CMOS Setup Utility-Copyright (C) 1984-2004 Award Software
Frequency/Voltage Control

		Item Help
CPU Clock Ratio	[10X]	
Linear Frequency Control	[Disabled]	Menu Level ▶
x CPU Clock (MHz)	100	
x DRAM Clock (MHz)	AUTO	
AGP/PCI Clock Control	[AUTO]	
x AGP Clock (MHz)	66	
x PCI Clock (MHz)	33	
AGP Voltage Control	[Normal]	
DRAM Voltage Control	[Normal]	

↑↓←→: Move Enter: Select +/-/PU/PD: Value F10: Save ESC: Exit F1: General Help
F5: Previous Values F6: Fail-Save Default F7: Optimized Defaults

☞ CPU Clock Ratio

This setup option will automatically assign by CPU detection.

For Willamette CPU:

8X~23X default: 14X

For C-Stepping P4:

8X,10X~24X default: 15X

For Northwood CPU:

12X~24X default: 16X

The option will display "Locked" and read only if the CPU ratio is not changeable.

☞ Linear Frequency Control

▶▶ Disabled Disable this function. (Default value)

▶▶ Enabled Enable this function.

☞ CPU Clock (MHz)

▶▶ 100MHz ~ 355MHz Set CPU Host Clock from 100MHz to 355MHz.

If you use FSB400 Pentium 4 processor, please set "CPU Clock" to 100MHz. If you use FSB533

Pentium 4 processor, please set "CPU Clock" to 133MHz. If you use FSB800 Pentium 4 processor, please set "CPU Clock" to 200MHz.

Incorrect using it may cause your system broken. For power End-User use only!

☞ DRAM Clock (MHz)

▶▶ Please set DRAM Clock according to your requirement.

If you use DDR266 DRAM module, please set "DRAM Clock(MHz)" to Auto or 266. If you use DDR333 DRAM module, please set "DRAM Clock(MHz)" to Auto or 333.

Incorrect using it may cause your system broken. For power End-User use only!

☞ AGP/PCI Clock Control

▶▶ AUTO Set AGP/PCI Clock Control to AUTO. (Default value)

▶▶ Manual Set AGP/PCI Clock Control to Manual.

- ☞ **AGP Clock (MHz)**
 - ▶▶ Please set AGP Clock according to your requirement.
Incorrect using it may cause your system broken. For power End-User use only!
- ☞ **PCI Clock (MHz)**
 - ▶▶ Please set PCI Clock according to your requirement.
Incorrect using it may cause your system broken. For power End-User use only!
- ☞ **AGP Voltage Control**
 - ▶▶ Normal Set AGP Voltage Control to Normal. (Default value)
 - ▶▶ +0.1V Set AGP Voltage Control to +0.1V.
- ☞ **DRAM Voltage Control**
 - ▶▶ Normal Set DRAM Voltage Control to Normal. (Default value)
 - ▶▶ +0.1V Set DRAM Voltage Control to +0.1V.

Top Performance

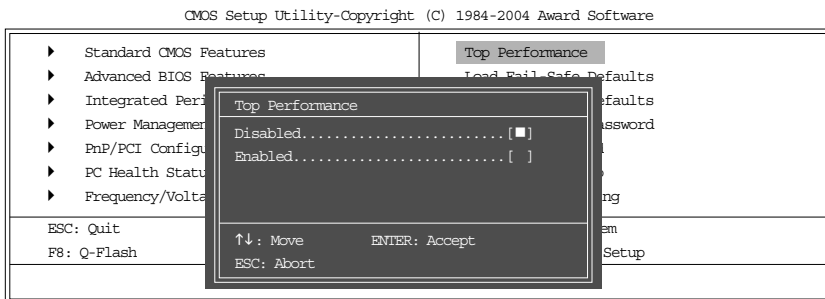

If you wish to maximize the performance of your system, set "Top Performance" as "Enabled".

- ▶▶ Disabled Disable this function. (Default Value)
- ▶▶ Enabled Enable Top Performance function.

●* "Top Performance" will increase H/W working speed. Different system configuration (both H/W component and OS) will effect the result. For example, the same H/W configuration might not run properly with Windows XP, but works smoothly with Windows NT. Therefore, if your system is not perform enough, the reliability or stability problem will appear sometimes, and we will recommend you disabling the option to avoid the problem as mentioned above.

Load Fail-Safe Defaults

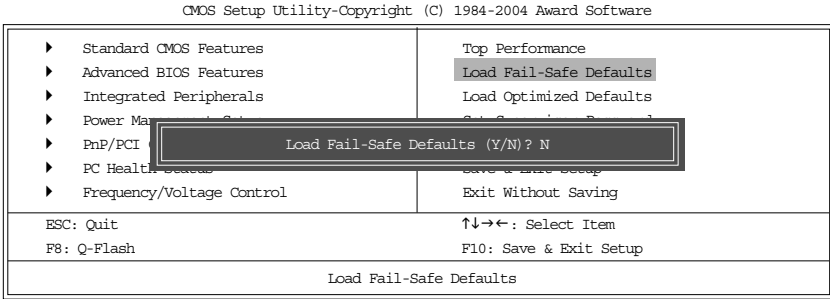

Fail-Safe defaults contain the most appropriate values of the system parameters that allow minimum system performance.

Load Optimized Defaults

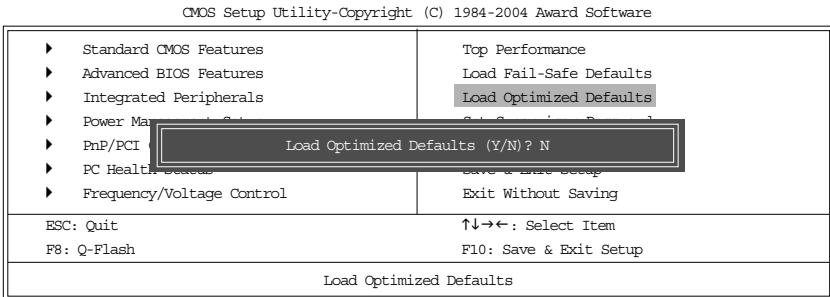

Selecting this field loads the factory defaults for BIOS and Chipset Features which the system automatically detects.

Set Supervisor/User Password

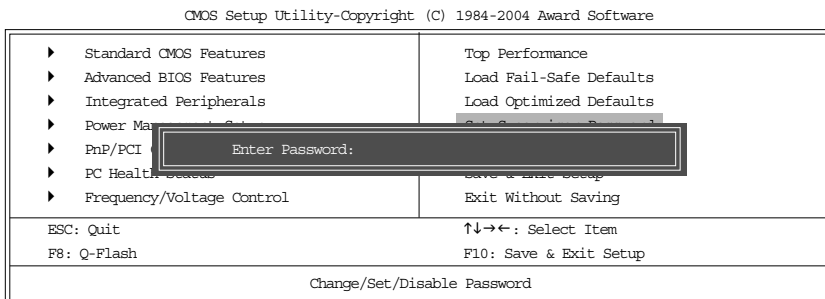

When you select this function, the following message will appear at the center of the screen to assist you in creating a password.

Type the password, up to eight characters, and press <Enter>. You will be asked to confirm the password. Type the password again and press <Enter>. You may also press <Esc> to abort the selection and not enter a password.

To disable password, just press <Enter> when you are prompted to enter password. A message "PASSWORD DISABLED" will appear to confirm the password being disabled. Once the password is disabled, the system will boot and you can enter Setup freely.

The BIOS Setup program allows you to specify two separate passwords:

SUPERVISOR PASSWORD and a USER PASSWORD. When disabled, anyone may access all BIOS Setup program function. When enabled, the Supervisor password is required for entering the BIOS Setup program and having full configuration fields, the User password is required to access only basic items.

If you select "System" at "Password Check" in Advance BIOS Features Menu, you will be prompted for the password every time the system is rebooted or any time you try to enter Setup Menu.

If you select "Setup" at "Password Check" in Advance BIOS Features Menu, you will be prompted only when you try to enter Setup.

Save & Exit Setup

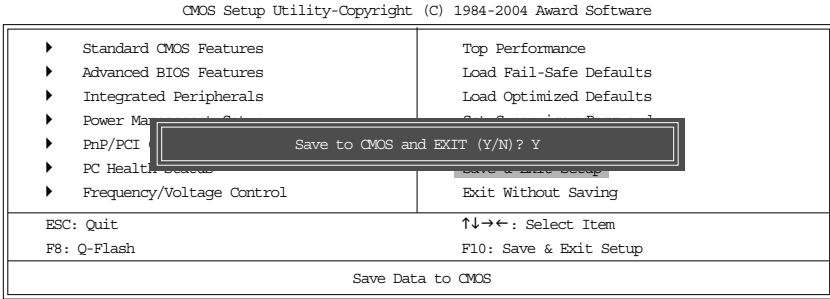

Type "Y" will quit the Setup Utility and save the user setup value to RTC CMOS.
Type "N" will return to Setup Utility.

Exit Without Saving

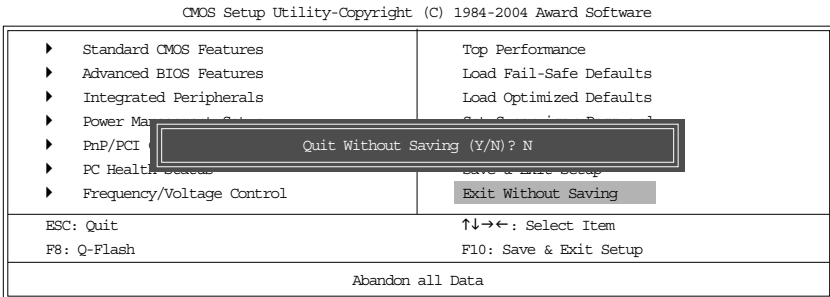

Type "Y" will quit the Setup Utility without saving to RTC CMOS.
Type "N" will return to Setup Utility.

Chapter 3 Install Drivers

Install Drivers



NOTE

Pictures below are shown in Windows XP

Insert the driver CD-title that came with your motherboard into your CD-ROM drive, the driver CD-title will auto start and show the installation guide. If not, please double click the CD-ROM device icon in "My computer", and execute the setup.exe.

INSTALL CHIPSET DRIVER

This page shows the drivers that need to be installed for the system. Click each item to install the driver manually or switch to the  to install the drivers automatically.

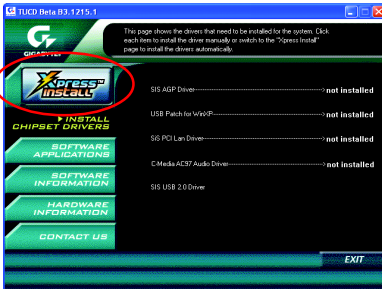

The "Xpress Install" uses the "Click and Go" technology to install the drivers automatically. Just select the drivers you want then click the "GO" button. The  will execute the installation for you by itself.

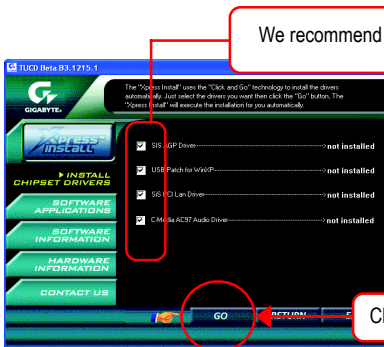

We recommend that you install all components in the list.

Message: Some device drivers will restart your system automatically. After restarting your system the "Xpress Install" will continue to install other drivers.

Click "GO".

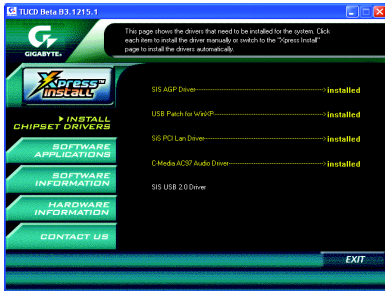

Driver install finished!! you have to reboot system!!

Item Description

- SIS AGP Driver
Install SIS AGP Driver.
- USB Patch for WinXP
This patch driver can help you to resolve the USB device wake up S3 hang up issue in XP.
- SiS PCI Lan Driver *
For SiS series Lan driver.
- C-Media AC97 Audio Driver
Install C-Media AC97 audio driver.
- SIS USB 2.0 Driver
It is recommended that you use the Microsoft Windows update for the most updated driver for XP/2K.

*** Only for 8S648FX-RZ.

CONTACT US

Contact us via the information in this page all over the world.

• Taiwan

Gigabyte Technology Co., Ltd.
 Address: No.6, Bau Chiang Road, Hsin-Tien, Taipei Hsien, Taiwan, R.O.C.
 Tel: 886 (2) 8912-4888
 Fax: 886 (2) 8912-4003
 Tech. Support:
<http://tw.giga-byte.com/TechSupport/ServiceCenter.htm>
 Non-Tech. Support (Sales/Marketing issues):
<http://ggts.gigabyte.com.tw/nontech.asp>
 Website: <http://www.gigabyte.com.tw>

• USA

G.B.T. INC.
 Address: 17358 Railroad St, City of Industry, CA 91748.
 Tel: 1 (626) 854-9338
 Fax: 1 (626) 854-9339
 Tech. Support:
<http://www.giga-byte.com/TechSupport/ServiceCenter.htm>
 Non-Tech. Support (Sales/Marketing issues):
<http://ggts.gigabyte.com.tw/nontech.asp>
 Website: <http://www.giga-byte.com>

• Germany

G.B.T. Technology Trading GmbH
 Tel: 49-40-2533040
 49-01803-428468 (Tech.)
 Fax: 49-40-25492343 (Sales)
 49-01803-428329 (Tech.)
 Tech. Support:
<http://de.giga-byte.com/TechSupport/ServiceCenter.htm>
 Non-Tech. Support (Sales/Marketing issues):
<http://ggts.gigabyte.com.tw/nontech.asp>
 Website: <http://www.gigabyte.de>

• Japan

Nippon Giga-Byte Corporation
 Website: <http://www.gigabyte.co.jp>

• U.K

G.B.T. TECH. CO. LTD.
 Tel: 44-1908-362700
 Fax: 44-1908-362709
 Tech. Support:
<http://uk.giga-byte.com/TechSupport/ServiceCenter.htm>
 Non-Tech. Support (Sales/Marketing issues):
<http://ggts.gigabyte.com.tw/nontech.asp>
 Website: <http://uk.giga-byte.com>

• The Netherlands

Giga-Byte Technology B.V.
 Address: Verdunplein 8 5627 SZ, Eindhoven, The Netherlands
 Tel: +31 40 290 2088
 NL Tech.Support : 0900-GIGABYTE (0900-44422983, € 0.2/M)
 BE Tech.Support : 0900-84034 (€ 0.4/M)
 Fax: +31 40 290 2089
 Tech. Support:
<http://nz.giga-byte.com/TechSupport/ServiceCenter.htm>
 Non-Tech. Support (Sales/Marketing issues):
<http://ggts.gigabyte.com.tw/nontech.asp>
 Website: <http://www.giga-byte.nl>

• China

NINGBO G.B.T. Tech. Trading CO., Ltd.
 Tech. Support:
<http://cn.giga-byte.com/TechSupport/ServiceCenter.htm>
 Non-Tech. Support (Sales/Marketing issues):
<http://ggts.gigabyte.com.tw/nontech.asp>
 Website: <http://www.gigabyte.com.cn>
Beijing
 Tel: 86-10-82856054, 86-10-82856064, 86-10-82856094
 Fax: 86-10-82856575
Chengdu
 Tel: 86-28-85236930
 Fax: 86-28-85256822
GuangZhou
 Tel: 86-20-87586273
 Fax: 86-20-87544306
Shanghai
 Tel: 86-21-64737410
 Fax: 86-21-64453227
Shenyang
 Tel: 86-24-23960918, 86-24-23960893
Wuhan
 Tel: 86-27-87854385, 86-27-87854802
 Fax: 86-27-87854031
Xian
 Tel: 86-29-5531943
 Fax: 86-29-5539821
