



When you installing AGP card, please make sure the following notice is fully understood and practiced. If your AGP card has "AGP 4X/8X (1.5V) notch"(show below), please make sure your AGP card is AGP 4X/8X (1.5V).



Caution: AGP 2X card is not supported by Intel® 845(GE/PE) / 845(E/G) / 850(E) / E7205 / 865(G/PE/P) / 875P. You might experience system unable to boot up normally. Please insert an AGP 4X/8X card.



Example 1: Diamond Vipper V770 golden finger is compatible with 2X/4X mode AGP slot. It can be switched between AGP 2X(3.3V) or 4X(1.5V) mode by adjusting the jumper. The factory default for this card is 2X(3.3V). The GA-8IPE775 Series (or any AGP 4X/8X only) motherboards might not function properly, if you install this card without switching the jumper to 4X(1.5V) mode in it.

Example 2: Some ATI Rage 128 Pro graphics cards made by "Power Color", the graphics card manufacturer & some SIS 305 cards, their golden finger is compatible with 2X(3.3V)/4X(1.5V) mode AGP slot, but they support 2X (3.3V) only. The GA-8IPE775 Series (or any AGP 4X/8X only) motherboards might not function properly, If you install this card in it.

Note : Although Gigabyte's AG32S(G) graphics card is based on ATI Rage 128 Pro chip, the design of AG32S(G) is compliance with AGP 4X(1.5V) specification. Therefore, AG32S(G) will work fine with Intel® 845(GE/PE) / 845(E/G) / 850(E) / E7205 / 865(G/PE/P) / 875P based motherboards.



Before you install PCI cards, please remove the Dual BIOS label from PCI slots if there is one.



- ☛ The author assumes no responsibility for any errors or omissions that may appear in this document nor does the author make a commitment to update the information contained herein.
- ☛ Third-party brands and names are the property of their respective owners.
- ☛ Please do not remove any labels on motherboard, this may void the warranty of this motherboard.
- ☛ Due to rapid change in technology, some of the specifications might be out of date before publication of this booklet.



WARNING: *Never run the processor without the heatsink properly and firmly attached. PERMANENT DAMAGE WILL RESULT!*

Mise en garde : *Ne faites jamais tourner le processeur sans que le dissipateur de chaleur soit fixé correctement et fermement. UN DOMMAGE PERMANENT EN RÉSULTERA !*

Achtung: *Der Prozessor darf nur in Betrieb genommen werden, wenn der Wärmeleiter ordnungsgemäß und fest angebracht ist. DIES HAT EINEN PERMANENTEN SCHADEN ZUR FOLGE!*

Advertencia: *Nunca haga funcionar el procesador sin el dissipador de calor instalado correcta y firmemente. ¡SE PRODUCIRÁ UN DAÑO PERMANENTE!*

Aviso: *Nunca execute o processador sem o dissipador de calor estar adequado e firmemente conectado. O RESULTADO SERÁ UM DANO PERMANENTE!*

警告: 將散熱板牢固地安裝到處理器上之前，不要運行處理器。過熱將永遠損壞處理器！

警告: 將散熱器牢固地安裝到處理器上之前，不要運行處理器。過熱將永遠損壞處理器！

경고: 히트싱크를 제대로 또 단단히 부착시키지 않은 채 프로세서를 구동시키지 마십시오. 영구적 고장이 발생합니다!

警告: 永久的な損傷を防ぐため、ヒートシンクを正しくしっかりと取り付けるまでは、プロセッサを動作させないようにしてください。

Declaration of Conformity

We, Manufacturer/Importer
(full address)

G.B.T. Technology Trading GmbH
Ausschlag Weg 41, 1F 20537 Hamburg, Germany

declare that the product
(description of the apparatus, system, installation to which it refers)

Mother Board

GA-8IPE775 Pro/GA-8IPE775-G/GA-8IPE775

is in conformity with
(reference to the specification under which conformity is declared)
in accordance with 89/336 EEC-EMC Directive

- | | | | |
|---|--|--|---|
| <input type="checkbox"/> EN 55011 | Limits and methods of measurement of radio disturbance characteristics of industrial, scientific and medical (ISM) high frequency equipment | <input checked="" type="checkbox"/> EN 61000-3-2 | Disturbances in supply systems caused |
| <input type="checkbox"/> EN 55013 | Limits and methods of measurement of radio disturbance characteristics of broadcast receivers and associated equipment | <input checked="" type="checkbox"/> EN 61000-3-3 | Disturbances in supply systems caused by household appliances and similar electrical equipment "Voltage fluctuations" |
| <input type="checkbox"/> EN 55014-1 | Limits and methods of measurement of radio disturbance characteristics of household electrical appliances, portable tools and similar electrical apparatus | <input type="checkbox"/> EN 55024 | Information Technology equipment-Immunity characteristics-Limits and methods of measurement |
| <input type="checkbox"/> EN 55015 | Limits and methods of measurement of radio disturbance characteristics of fluorescent lamps and luminaires | <input type="checkbox"/> EN 50082-1 | Generic immunity standard Part 1: Residual, commercial and light industry |
| <input type="checkbox"/> EN 55020 | Immunity from radio interference of broadcast receivers and associated equipment | <input type="checkbox"/> EN 50082-2 | Generic immunity standard Part 2: Industrial environment |
| <input checked="" type="checkbox"/> EN 55022 | Limits and methods of measurement of radio disturbance characteristics of information technology equipment | <input type="checkbox"/> EN 55014-2 | Immunity requirements for household appliances tools and similar apparatus |
| <input type="checkbox"/> DIN VDE 0855
<input type="checkbox"/> part 10
<input type="checkbox"/> part 12 | Cabled distribution systems; Equipment for receiving and/or distribution from sound and television signals | <input type="checkbox"/> EN 50091- 2 | EMC requirements for uninterruptible power systems (UPS) |
| <input checked="" type="checkbox"/> CE marking | | | |



(EC conformity marking)

The manufacturer also declares the conformity of above mentioned product with the actual required safety standards in accordance with LVD 73/23 EEC

- | | | | |
|-----------------------------------|---|-------------------------------------|---|
| <input type="checkbox"/> EN 60065 | Safety requirements for mains operated electronic and related apparatus for household and similar general use | <input type="checkbox"/> EN 60950 | Safety for information technology equipment including electrical business equipment |
| <input type="checkbox"/> EN 60335 | Safety of household and similar electrical appliances | <input type="checkbox"/> EN 50091-1 | General and Safety requirements for uninterruptible power systems (UPS) |

Manufacturer/Importer

Signature : Timmy Huang

(Stamp)

Date : May 14, 2004

Name : Timmy Huang

DECLARATION OF CONFORMITY

Per FCC Part 2 Section 2.1077(a)



Responsible Party Name: G.B.T. INC. (U.S.A.)

**Address: 17358 Railroad Street
City of Industry, CA 91748**

Phone/Fax No: (818) 854-9338/ (818) 854-9339

hereby declares that the product

Product Name: Motherboard

**Model Number: GA-8IPE775 Pro/GA-8IPE775-G
/GA-8IPE775**

Conforms to the following specifications:

FCC Part 15, Subpart B, Section 15.107(a) and Section 15.109
(a), Class B Digital Device

Supplementary Information:

This device complies with part 15 of the FCC Rules. Operation is subject to the following two conditions: (1) This device may not cause harmful and (2) this device must accept any interference received, including that may cause undesired operation.

Representative Person's Name: ERIC LU

Signature: Eric Lu

Date: May 14, 2004

GA-8IPE775 Series

Intel® Pentium® 4 Socket 775 Processor Motherboard

USER'S MANUAL

Pentium® 4 Processor Motherboard

Rev. 1004

12ME-8IPE775-1004

Table of Content

Warning	4
Chapter 1 Introduction	5
Features Summary	5
GA-8IPE775 Series Motherboard Layout	7
Block Diagram	8
Chapter 2 Hardware Installation Process	11
Step 1: Install the Central Processing Unit (CPU)	12
Step 1-1: Installation of the CPU	12
Step 1-2: Installation of the Heatsink	13
Step 2: Installation of Memory	13
Step 3: Install expansion cards	16
Step 4: Install I/O Peripherals Cables	17
Step 4-1: I/O Back Panel Introduction	17
Step 4-2: Connectors Introduction	19
Chapter 3 BIOS Setup	31
The Main Menu (For example: BIOS Ver. : 8IPE775 Pro.D4)	32
Standard CMOS Features	34
Advanced BIOS Features	37
Integrated Peripherals	39
Power Management Setup	43

PnP/PCI Configurations	45
PC Health Status	46
Frequency/Voltage Control	48
Load Fail-Safe Defaults	50
Load Optimized Defaults	50
Set Supervisor/User Password	51
Save & Exit Setup	52
Exit Without Saving	52
Chapter 4 Technical Reference	53
Flash BIOS Method Introduction	53
2- / 4- / 6- / 8- Channel Audio Function Introduction	67
Jack-Sensing and UAJ Introduction	73
Xpress Recovery2 Introduction	75
Chapter 5 Appendix	79

Warning



Computer motherboards and expansion cards contain very delicate Integrated Circuit (IC) chips. To protect them against damage from static electricity, you should follow some precautions whenever you work on your computer.

1. Unplug your computer when working on the inside.
2. Use a grounded wrist strap before handling computer components. If you do not have one, touch both of your hands to a safely grounded object or to a metal object, such as the power supply case.
3. Hold components by the edges and try not touch the IC chips, leads or connectors, or other components.
4. Place components on a grounded antistatic pad or on the bag that came with the components whenever the components are separated from the system.
5. Ensure that the ATX power supply is switched off before you plug in or remove the ATX power connector on the motherboard.

Installing the motherboard to the chassis...

If the motherboard has mounting holes, but they don't line up with the holes on the base and there are no slots to attach the spacers, do not become alarmed you can still attach the spacers to the mounting holes. Just cut the bottom portion of the spacers (the spacer may be a little hard to cut off, so be careful of your hands). In this way you can still attach the motherboard to the base without worrying about short circuits. Sometimes you may need to use the plastic springs to isolate the screw from the motherboard PCB surface, because the circuit wire may be near by the hole. Be careful, don't let the screw contact any printed circuit write or parts on the PCB that are near the fixing hole, otherwise it may damage the board or cause board malfunctioning.

Chapter 1 Introduction

Features Summary

CPU	<ul style="list-style-type: none"> • Supports the latest Intel® Pentium® 4 Socket 775 CPU • Supports 533/800MHz FSB • L2 cache varies with CPU
Motherboard	<ul style="list-style-type: none"> • GA-8IPE775 Series Motherboard: GA-8IPE775 Pro/GA-8IPE775-G/GA-8IPE775
Chipset	<ul style="list-style-type: none"> • North Bridge: Intel® 865PE • South Bridge: Intel® ICH5
Memory	<ul style="list-style-type: none"> • 4 184-pin DDR DIMM sockets • Supports Dual channel DDR400/DDR333/DDR266 DIMM • Supports 128MB/256MB/512MB/1GB unbuffered DRAM • Supports up to 4GB DRAM (Max) ^(Note 1)
Slots	<ul style="list-style-type: none"> • 1 AGP slot supports 8X/4X(1.5V) mode • 5 PCI slots
On-Board IDE	<ul style="list-style-type: none"> • 2 IDE bus master (UDMA33/ATA66/ATA100) IDE ports for up to 4 ATAPI devices • Can connect up to 4 IDE devices
On-Board Floppy	<ul style="list-style-type: none"> • 1 Floppy port supports 2 FDD with 360K, 720K, 1.2M, 1.44M and 2.88M bytes
On-Board Peripherals	<ul style="list-style-type: none"> • 1 Parallel port supports Normal/EPP/ECP mode • 2 Serial ports (COMA & COMB) • 8 USB 2.0/1.1 ports (4 x Rear, 4 x Front by cable) • 1 IrDA connector for IR/CIR • 3 IEEE1394 (by cable) ① • 1 FrontAudio connector • 1 PS/2 keyboard port • 1 PS/2 mouse port

to be continued.....



Due to chipset (Intel 865PE) architecture limitation, a FSB 800 Pentium 4 processor will support DDR400/DDR333/DDR266 memory module. A FSB 533 Pentium 4 processor will support DDR333 and DDR266 memory module.

(Note 1) Due to standard PC architecture, a certain amount of memory is reserved for system usage and therefore the actual memory size is less than the stated amount. For example, 4 GB of memory size will instead be shown as 3.xxGB memory during system startup.

① Only for GA-8IPE775 Pro.

On-Board LAN ①②	<ul style="list-style-type: none"> • Build in Marvell 8001 Chipset (10/100/1000 Mbit) • 1 RJ45 port
On-Board IEEE1394 ①	<ul style="list-style-type: none"> • Ti TSB43AB23
On-Board Sound	<ul style="list-style-type: none"> • ALC850 CODEC (UAJ) • Supports Jack Sensing function • Supports 2 / 4 / 6 / 8 channel audio • Supports Line In / Line Out / MIC connection • Surround Back Speaker (use of Surround-Kit to select) • SPDIF In / Out • CD In / Game connector
Serial ATA	<ul style="list-style-type: none"> • 2 Serial ATA connectors (SATA0/SATA1) • Controlled by ICH5
Hardware Monitor	<ul style="list-style-type: none"> • CPU/PowerⓄ/System Fan Revolution detect • CPU/PowerⓄ/System Fan Fail Warning • CPU Overheat Warning • System Voltage Detect
I/O Control	<ul style="list-style-type: none"> • IT8712
PS/2 Connector	<ul style="list-style-type: none"> • PS/2 Keyboard interface and PS/2 Mouse interface
BIOS	<ul style="list-style-type: none"> • Licensed AWARD BIOS • Supports Dual BIOSⓄ/Q-Flash
Additional Features	<ul style="list-style-type: none"> • Supports EasyTune • Supports @BIOS • Supports CPU Smart Fan Control function ①②
Overclocking	<ul style="list-style-type: none"> • Over Voltage (DDR/AGP/CPU) by BIOS • Over Clock (DDR/AGP/CPU/PCI) by BIOS
Form Factor	<ul style="list-style-type: none"> • ATX size form factor; 30.5cm x 24.4cm

① Only for GA-8IPE775 Pro.

② Only for GA-8IPE775-G.

GA-8IPE775 Series Motherboard Layout

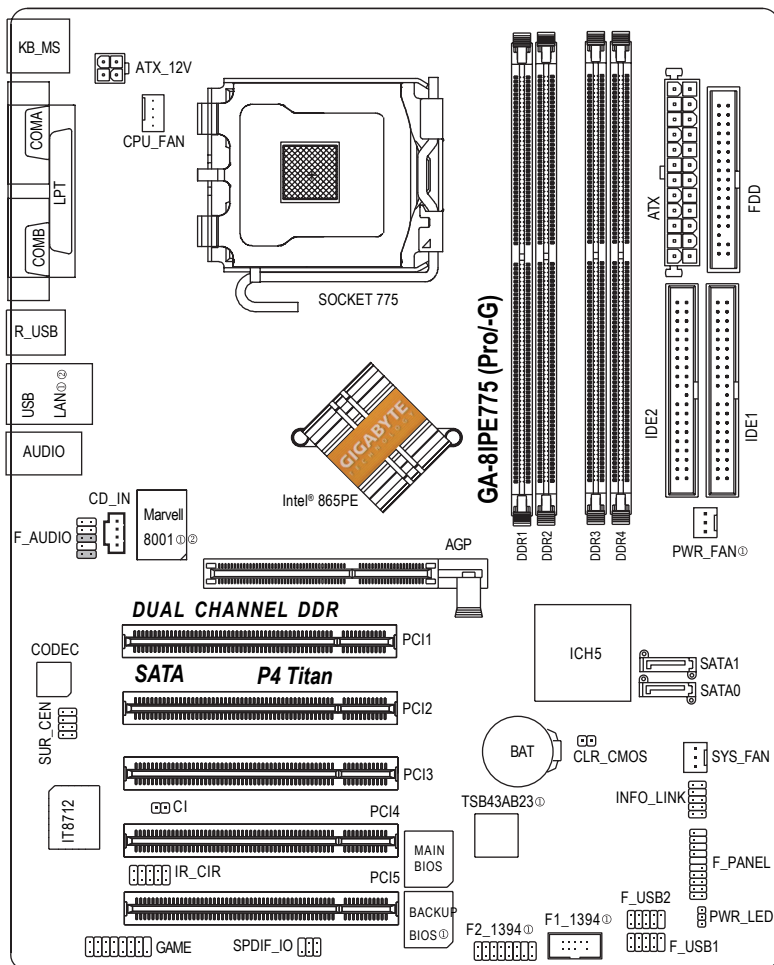

① Only for GA-8IPE775 Pro.

② Only for GA-8IPE775-G.

Block Diagram

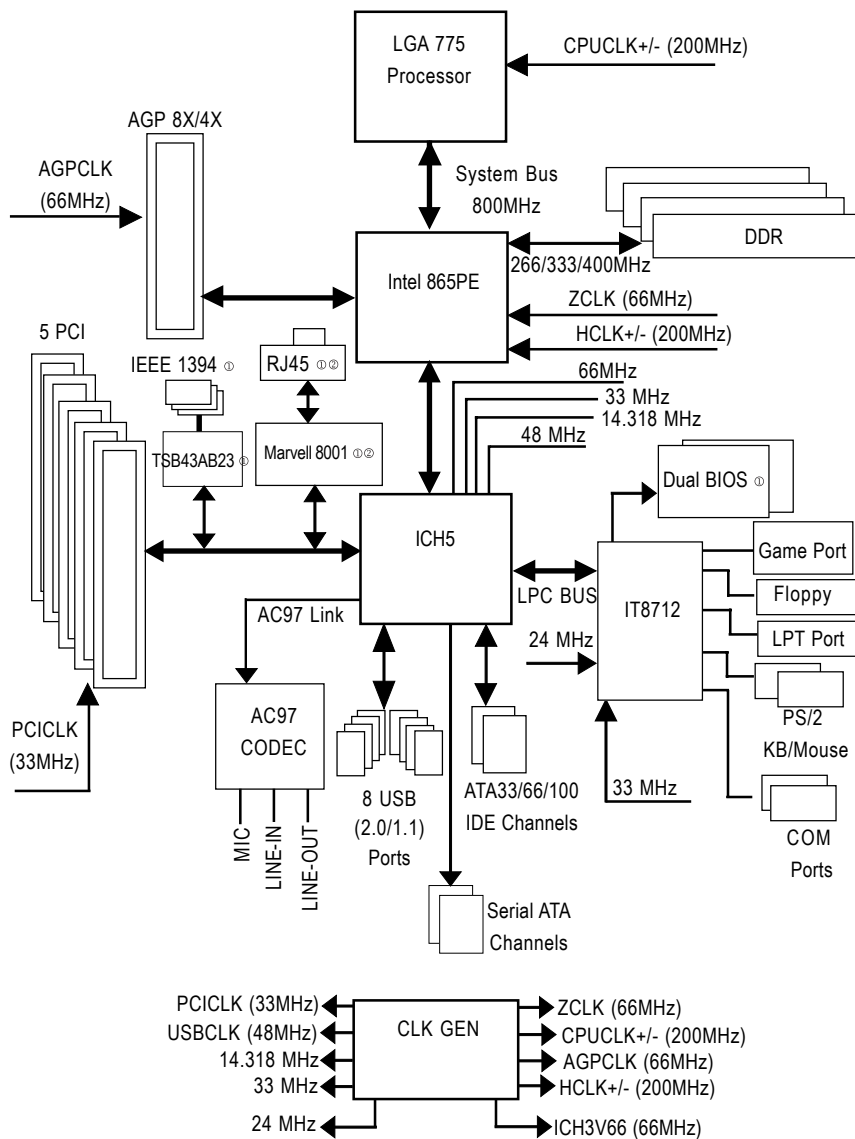

Chapter 2 Hardware Installation Process

To set up your computer, you must complete the following steps:

- Step 1- Install the Central Processing Unit (CPU)
- Step 2- Install memory modules
- Step 3- Install expansion cards
- Step 4- Install I/O Peripherals Cables

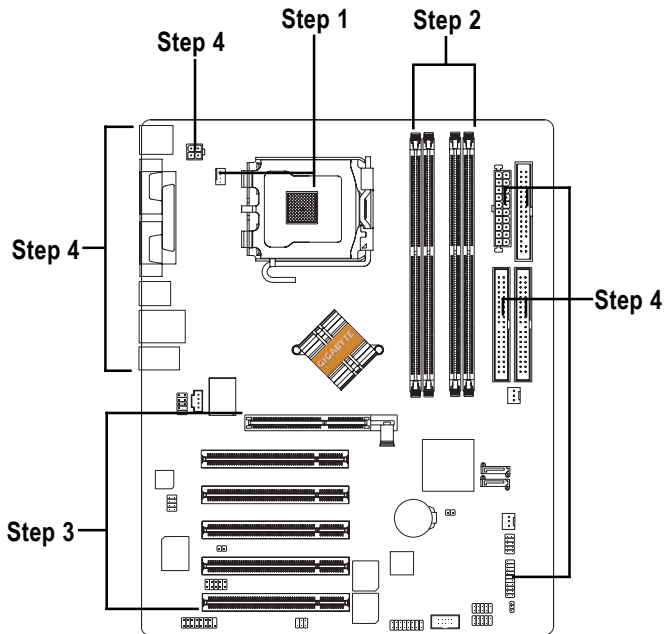

Congratulations! You have accomplished the hardware installation!

Turn on the power supply or connect the power cable to the power outlet. Continue with the BIOS/software installation.

Step 1: Install the Central Processing Unit (CPU)



Before installing the CPU, please comply with the following conditions:

1. Please make sure that the motherboard supports the CPU.
2. Please take note of the one indented corner of the CPU. If you install the CPU in the wrong direction, the CPU will not insert properly. If this occurs, please change the insert direction of the CPU.
3. Please add an even layer of heat sink paste between the CPU and heatsink.
4. Please make sure the heatsink is installed on the CPU prior to system use, otherwise overheating and permanent damage of the CPU may occur.
5. Please set the CPU host frequency in accordance with the processor specifications. It is not recommended that the system bus frequency be set beyond hardware specifications since it does not meet the required standards for the peripherals. If you wish to set the frequency beyond the proper specifications, please do so according to your hardware specifications including the CPU, graphics card, memory, hard drive, etc.



HT functionality requirement content :

Enabling the functionality of Hyper-Threading Technology for your computer system requires all of the following platform components:

- CPU: An Intel® Pentium 4 Processor with HT Technology
- Chipset: An Intel® Chipset that supports HT Technology
- BIOS: A BIOS that supports HT Technology and has it enabled
- OS: An operation system that has optimizations for HT Technology

Step 1-1: Installation of the CPU

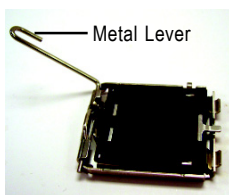

Fig. 1
Gently lift the metal lever located on the CPU socket to the upright position.

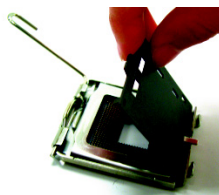

Fig. 2
Remove the plastic covering on the CPU socket.

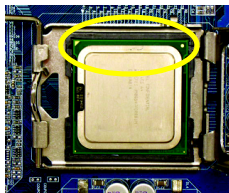

Fig. 3
Notice the small gold colored triangle located on the edge of the CPU socket. Align the indented corner of the CPU with the triangle and gently insert the CPU into position.



Fig. 4
Once the CPU is properly inserted, please replace the plastic covering and push the metal lever back into its original position.

Step 1-2: Installation of the Heatsink

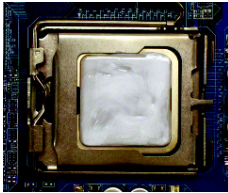

Fig. 1
Please apply an even layer of heatsink paste on the surface of the installed CPU.

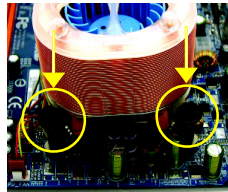

Fig. 2
Place the heatsink atop the CPU and then secure each of the four heatsink clips by pressing downwards.

(for detailed installation instructions, please refer to the heat sink installation section of the user manual)

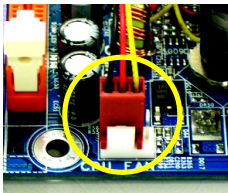

Fig. 3
Please attach the power connector of the heatsink to the CPU fan header located on the motherboard. Installation is complete.



NOTE

The heatsink may adhere to the CPU as a result of hardening of the heatsink paste. If the heatsink is removed when this occurs, the CPU may become pulled from its socket with the metal lever still in its locked position and result in damage to the processor pins. To prevent such an occurrence, it is suggested that either thermal tape rather than heat sink paste be used for heat dissipation or using extreme care when removing the heatsink.

Step 2: Installation of Memory



CAUTION

Before installing the memory modules, please comply with the following conditions:

1. Please make sure that the memory used is supported by the motherboard. It is recommended that memory of similar capacity, specifications and brand be used.
2. Before installing or removing memory modules, please make sure that the computer power is switched off to prevent hardware damage.
3. Memory modules have a foolproof insertion design. A memory module can be installed in only one direction. If you are unable to insert the module, please switch the direction.

The motherboard supports DDR memory modules, whereby BIOS will automatically detect memory capacity and specifications. Memory modules are designed so that they can be inserted only in one direction. The memory capacity used can differ with each slot.

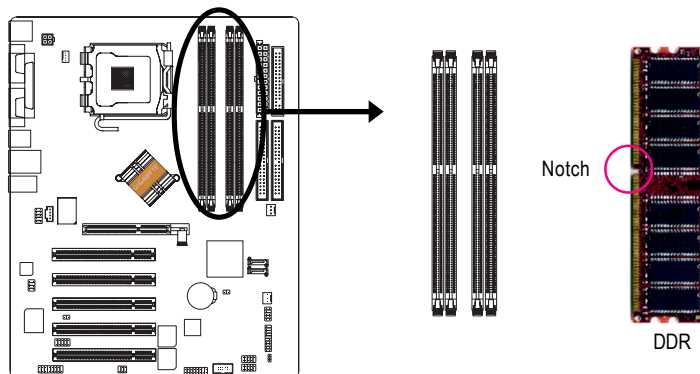

1. The DIMM socket has a notch, so the DIMM memory module can only fit in one direction.



2. Insert the DIMM memory module vertically into the DIMM socket. Then push it down.



3. Close the plastic clip at both edges of the DIMM sockets to lock the DIMM module.
Reverse the installation steps when you wish to remove the DIMM module.

DDR Introduction

Established on the existing SDRAM infrastructure, DDR (Double Data Rate) memory is a high performance and cost-effective solution that allows easy adoption for memory vendors, OEMs, and system integrators.

DDR memory is a great evolutionary solution for the PC industry that builds on the existing SDRAM architecture, yet make the awesome advances in solving the system performance bottleneck by doubling the memory bandwidth. Nowadays, with the highest bandwidth of 3.2GB/s of DDR400 memory and complete line of DDR400/333/266/200 memory solutions, DDR memory is the best choice for building high performance and low latency DRAM subsystem that are suitable for servers, workstations, and full range of desktop PCs.

GA-8IPE775 Series supports the Dual Channel Technology. After operating the Dual Channel Technology, the bandwidth of Memory Bus will add double up to 6.4GB/s.

GA-8IPE775 Series includes 4 DIMM sockets, and each Channel has two DIMM sockets as following:

- ▶▶ Channel A : DIMM 1, DIMM 2
- ▶▶ Channel B : DIMM 3, DIMM 4

If you want to operate the Dual Channel Technology, please note the following explanations due to the limitation of Intel® chipset specifications.

1. Only one DDR memory module is installed: The Dual Channel Technology can't operate when only one DDR memory module is installed.
2. Two DDR memory modules are installed (the same memory size and type): The Dual Channel Technology will operate when two memory modules are inserted individually into Channel A and B. If you install two memory modules in the same channel, the Dual Channel Technology will not operate.
3. Three DDR memory modules are installed: Please note that The Dual Channel Technology will not operate when three DDR memory modules are installed; part of them will not be detected.
4. Four DDR memory modules are installed: If you install four memory modules at the same time, the Dual Channel Technology will operate only when those modules have the same memory size and type.

We'll strongly recommend our user to slot two DDR memory modules into the DIMMs with the same color in order for Dual Channel Technology to work.

The following tables include all memory-installed combination types:

(Please note that those types not in the tables will not boot up.)

● Figure 1: Dual Channel Technology (DS: Double Side, SS: Single Side)

	DIMM 1	DIMM 2	DIMM 3	DIMM 4
2 memory modules	DS/SS	X	DS/SS	X
	X	DS/SS	X	DS/SS
4 memory modules	DS/SS	DS/SS	DS/SS	DS/SS

● Figure 2: Don't operate Dual Channel Technology (DS: Double Side, SS: Single Side)

	DIMM 1	DIMM 2	DIMM 3	DIMM 4
1 memory module	DS/SS	X	X	X
	X	DS/SS	X	X
	X	X	DS/SS	X
	X	X	X	DS/SS
2 memory modules	DS/SS	DS/SS	X	X
	X	X	DS/SS	DS/SS
3 memory modules	DS/SS	DS/SS	DS/SS	X
	DS/SS	DS/SS	X	DS/SS
	DS/SS	X	DS/SS	DS/SS
	X	DS/SS	DS/SS	DS/SS

Step 3: Install expansion cards

1. Read the related expansion card's instruction document before install the expansion card into the computer.
2. Remove your computer's chassis cover, screws and slot bracket from the computer.
3. Press the expansion card firmly into expansion slot in motherboard.
4. Be sure the metal contacts on the card are indeed seated in the slot.
5. Replace the screw to secure the slot bracket of the expansion card.
6. Replace your computer's chassis cover.
7. Power on the computer, if necessary, setup BIOS utility of expansion card from BIOS.
8. Install related driver from the operating system.

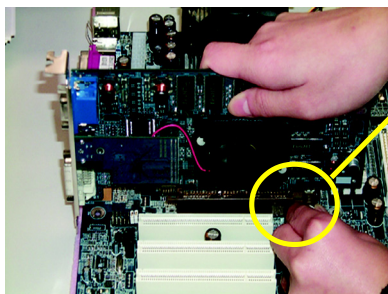

AGP Card

Please carefully pull out the small white- drawable bar at the end of the AGP slot when you try to install/ Uninstall the AGP card. Please align the AGP card to the onboard AGP slot and press firmly down on the slot .Make sure your AGP card is locked by the small white- drawable bar.

Step 4: Install I/O Peripherals Cables

Step 4-1: I/O Back Panel Introduction

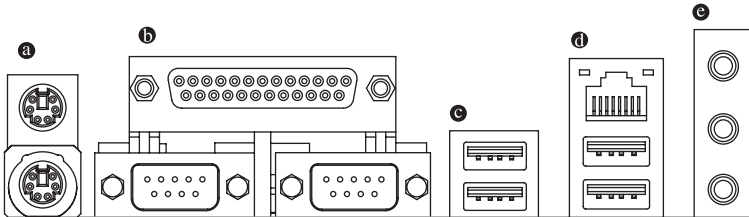

a PS/2 Keyboard and PS/2 Mouse Connector

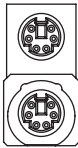

PS/2 Mouse Connector
(6 pin Female)

PS/2 Keyboard Connector
(6 pin Female)

- This connector supports standard PS/2 keyboard and PS/2 mouse.

b Parallel Port, Serial Port and VGA Port (LPT/COMA/COMB)

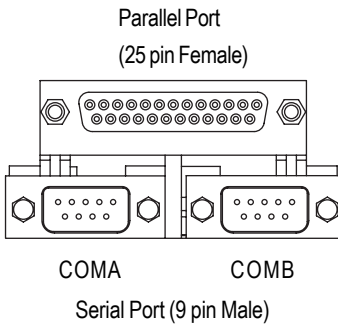

Parallel Port
(25 pin Female)

COMA

COMB

Serial Port (9 pin Male)

- This connector supports 2 standard COM ports and 1 Parallel port. Device like printer can be connected to Parallel port; mouse and modem etc can be connected to Serial ports.

④/① USB / LAN Connector

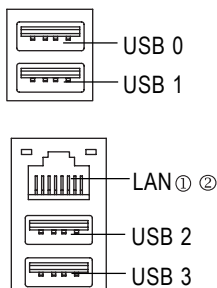

- LAN is fast Ethernet with 10/100/1000 Mbps speed.
- Before you connect your device(s) into USB connector(s), please make sure your device(s) such as USB keyboard, mouse, scanner, zip, speaker, etc. Have a standard USB interface. Also make sure your OS supports USB controller.
If your OS does not support USB controller, please contact OS vendor for possible patch or driver upgrade. For more information please contact your OS or device(s) vendors.

④ Audio Connectors

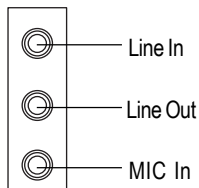

- After install onboard audio driver, you may connect speaker to Line Out jack, microphone to MIC In jack. Devices like CD-ROM, walkman etc. can be connected to Line-In jack.

Please note:

You are able to use 2-/4-/6-/8-channel audio feature by S/W selection.

If you want to enable 8-channel function you can refer to page 24, and contact your nearest dealer for optional SUR_CEN cable.



If you want the detail information for 2-/4-/6-/8-channel audio setup installation, please refer to page 67.

① Only for GA-8IPE775 Pro.

② Only for GA-8IPE775-G.

Step 4-2: Connectors Introduction

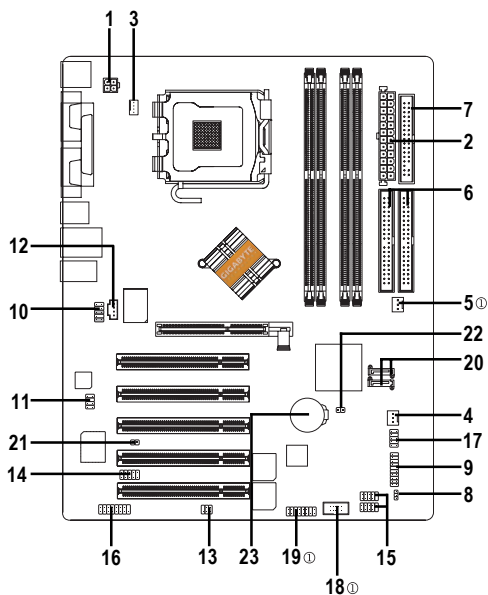

1) ATX_12V	13) SPDIF_IO
2) ATX	14) IR_CIR
3) CPU_FAN	15) F_USB1/F_USB2
4) SYS_FAN	16) GAME
5) PWR_FAN ①	17) INFO_LINK
6) IDE1/IDE2	18) F1_1394 ①
7) FDD	19) F2_1394 ①
8) PWR_LED	20) SATA0/SATA1
9) F_PANEL	21) CI
10) F_AUDIO	22) CLR_CMOS
11) SUR_CEN	23) BAT
12) CD_IN	

① Only for GA-8IPE775 Pro.

1/2) ATX_12V/ATX (Power Connector)

With the use of the power connector, the power supply can supply enough stable power to all the components on the motherboard. Before connecting the power connector, please make sure that all components and devices are properly installed. Align the power connector with its proper location on the motherboard and connect tightly.

The ATX_12V power connector mainly supplies power to the CPU. If the ATX_12V power connector is not connected, the system will not start.

Caution!

Please use a power supply that is able to handle the system voltage requirements. It is recommended that a power supply that can withstand high power consumption be used (300W or greater). If a power supply is used that does not provide the required power, the result can lead to an unstable system or a system that is unable to start.

Please remove the sticker on the motherboard before plugging in while the ATX power supplier is 24 pins; Otherwise, please do not remove it.

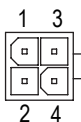
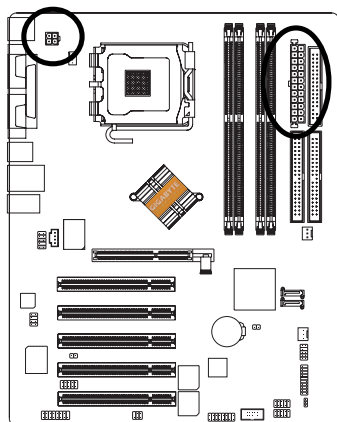

Pin No.	Definition
1	GND
2	GND
3	+12V
4	+12V

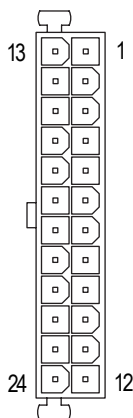

Pin No.	Definition
1	3.3V
2	3.3V
3	GND
4	VCC
5	GND
6	VCC
7	GND
8	Power Good
9	5V SB(stand by +5V)
10	+12V
11	+12V
12	3.3V (Only for 24pins ATX)
13	3.3V
14	-12V
15	GND
16	PS_ON(soft On/Off)
17	GND
18	GND
19	GND
20	-5V
21	VCC
22	VCC
23	VCC
24	GND

3/4/5) CPU_FAN / SYS_FAN / PWR_FAN ① (Cooler Fan Power Connector)

The cooler fan power connector supplies a +12V power voltage via a 3-pin power connector and possesses a foolproof connection design.

Most coolers are designed with color-coded power connector wires. A red power connector wire indicates a positive connection and requires a +12V power voltage. The black connector wire is the ground wire (GND).

Please remember to connect the power to the cooler to prevent system overheating and failure.

Caution!

Please remember to connect the power to the CPU fan to prevent CPU overheating and failure.

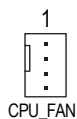
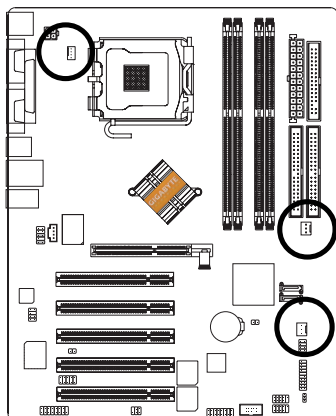

Pin No.	Definition
1	GND
2	+12V
3	Sense
4	Control (Only for CPU_FAN)

6) IDE1 / IDE2 (IDE1 / IDE2 Connector)

Important Notice:

Please connect first hard disk to IDE1 and connect CD-ROM to IDE2.

The red stripe of the ribbon cable must be the same side with the Pin1.

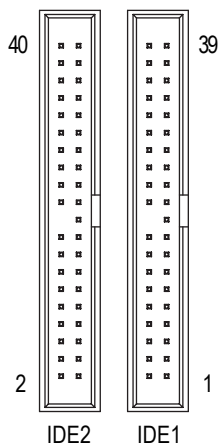
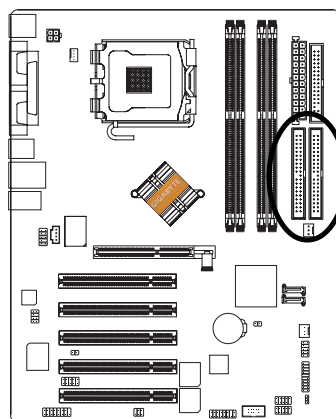

① Only for GA-8IPE775 Pro.

7) FDD (Floppy Connector)

Please connect the floppy drive ribbon cables to FDD. It supports 360K, 1.2M, 720K, 1.44M and 2.88M bytes floppy disk types.

The red stripe of the ribbon cable must be the same side with the Pin1.

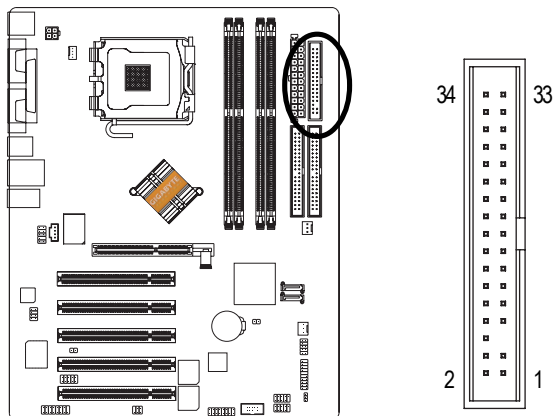

8) PWR_LED

PWR_LED is connect with the system power indicator to indicate whether the system is on/off. It will blink when the system enters suspend mode. If you use dual color LED, power LED will turn to another color.

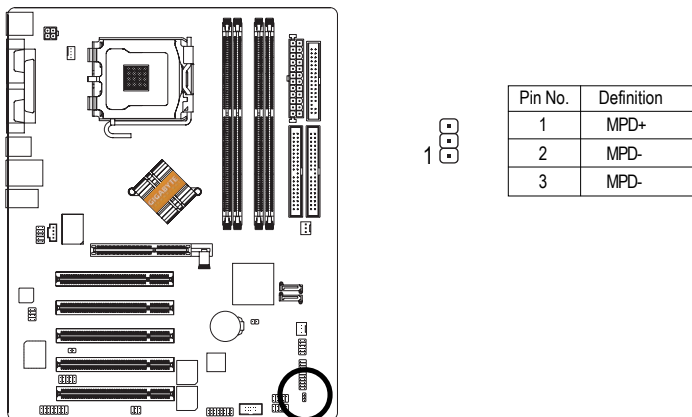

9) F_PANEL (2 x 10 pins Connector)

Please connect the power LED, PC speaker, reset switch and power switch etc. of your chassis front panel to the F_PANEL connector according to the pin assignment below.

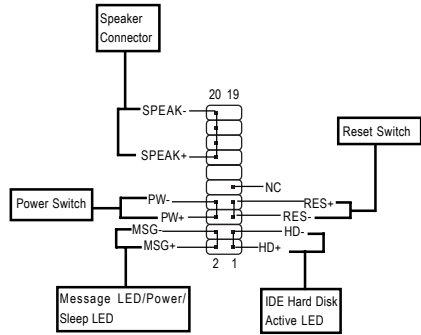
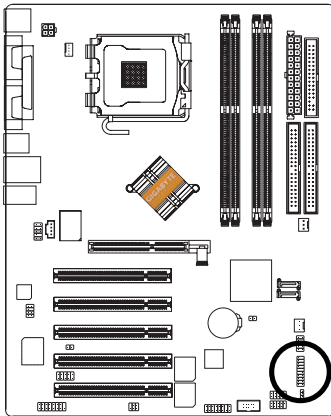

HD (IDE Hard Disk Active LED) (Blue)	Pin 1: LED anode(+) Pin 2: LED cathode(-)
SPEAK (Speaker Connector) (Amber)	Pin 1: VCC(+) Pin 2- Pin 3: NC Pin 4: Data(-)
RES (Reset Switch) (Green)	Open: Normal Operation Close: Reset Hardware System
PW (Power Switch) (Red)	Open: Normal Operation Close: Power On/Off
MSG(Message LED/ Power/ Sleep LED) (Yellow)	Pin 1: LED anode(+) Pin 2: LED cathode(-)
NC (Purple)	N C

10) F_AUDIO (Front Audio Connector)

If you want to use Front Audio connector, you must remove 5-6, 9-10 Jumper.

In order to utilize the front audio header, your chassis must have front audio connector. Also please make sure the pin assignment on the cable is the same as the pin assignment on the MB header. To find out if the chassis you are buying support front audio connector, please contact your dealer. Please note, you can have the alternative of using front audio connector or of using rear audio connector to play sound.

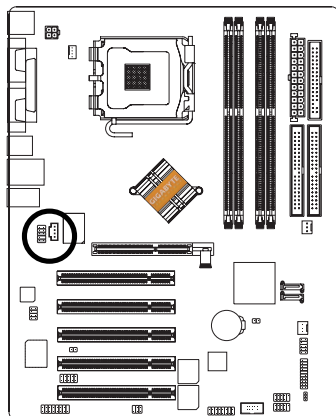

Pin No.	Definition
1	MIC
2	GND
3	MIC_BIAS
4	Power
5	Front Audio (R)
6	Rear Audio (R)
7	Reserved
8	No Pin
9	Front Audio (L)
10	Rear Audio (L)

11) SUR_CEN (Surround Center Connector)

Please contact your nearest dealer for optional SUR_CEN cable.

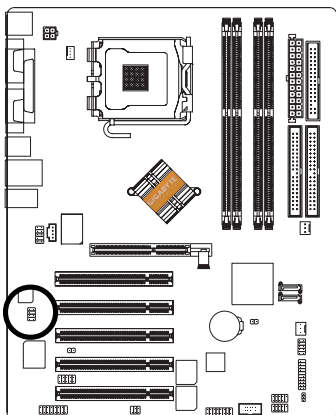

Pin No.	Definition
1	SUR OUTL
2	SUR OTR
3	GND
4	No Pin
5	CENTER_OUT
6	BASS_OUT
7	AUX_L
8	AUX_R

12) CD_IN (CD In Connector)

Connect CD-ROM or DVD-ROM audio out to the connector.

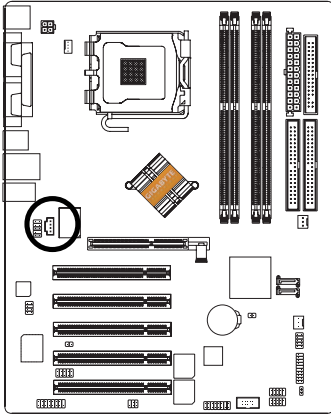

Pin No.	Definition
1	CDL
2	GND
3	GND
4	CD-R

13) SPDIF_IO (SPDIF In/Out Connector)

The SPDIF output is capable of providing digital audio to external speakers or compressed AC3 data to an external Dolby Digital Decoder. Use this feature only when your stereo system has digital input function. Be careful with the polarity of the SPDIF_IO connector. Check the pin assignment carefully while you connect the SPDIF cable, incorrect connection between the cable and connector will make the device unable to work or even damage it. For optional SPDIF cable, please contact your local dealer.

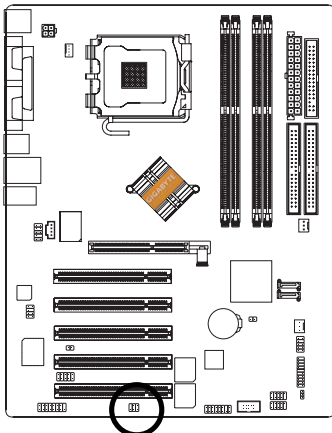

Pin No.	Definition
1	VCC
2	No Pin
3	SPDIF
4	SPDIFI
5	GND
6	GND

14) IR_CIR

Make sure the pin 1 on the IR device is along with pin one the connector. To enable the IR/CIR function on the board, you are required to purchase an option IR/CIR module. To use IR function only, please connect IR module to Pin1 to Pin5. Be careful with the polarity of the IR/CIR connector. Check the pin assignment carefully while you connect the IR/CIR cable, incorrect connection between the cable and connector will make the device unable to work or even damage it. For optional IR/CIR cable, please contact your local dealer.

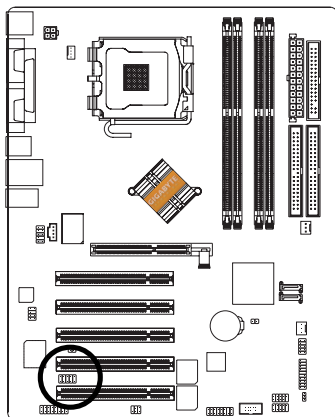

Pin No.	Definition
1	VCC
2	NC
3	IRRXX
4	GND
5	IRTX
6	NC
7	CIRRXX
8	+5VSB
9	CIRTX
10	NC

15) F_USB1 / F_USB2 (Front USB Connector)

Be careful with the polarity of the front USB connector. Check the pin assignment carefully while you connect the front USB cable, incorrect connection between the cable and connector will make the device unable to work or even damage it. For optional front USB cable, please contact your local dealer.

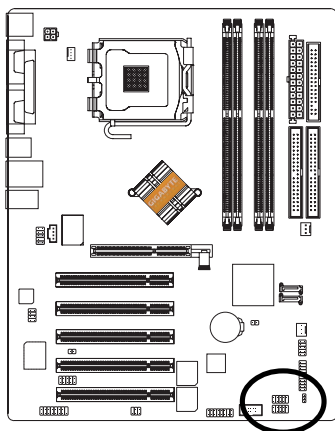

Pin No.	Definition
1	Power
2	Power
3	USB Dx-
4	USB Dy-
5	USB Dx+
6	USB Dy+
7	GND
8	GND
9	No Pin
10	NC

16) GAME (GAME Connector)

This connector supports joystick, MIDI keyboard and other relate audio devices.

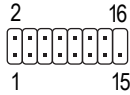
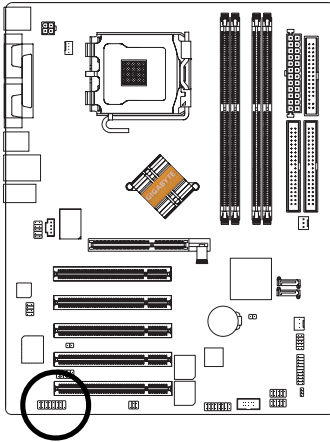

Pin No.	Definition
1	VCC
2	GRX1_R
3	GND
4	GPSA2
5	VCC
6	GPX2_R
7	GPY2_R
8	MSL_R
9	GPSA1
10	GND
11	GPY1_R
12	VCC
13	GPSB1
14	MSO_R
15	GPSB2
16	No Pin

17) INFO_LINK

This connector allows you to connect some external devices to provide you extra function. Check the pin assignment while you connect the external device cable. Please contact your nearest dealer for optional external device cable.

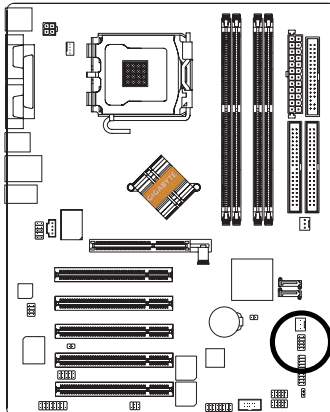

Pin No.	Definition
1	SMBCLK
2	VCC
3	SMBDATA
4	GPIO
5	GND
6	GND
7	No Pin
8	NC
9	+12V
10	+12V

18) F1_1394 (IEEE 1394 Connector) ①

Please Note: Serial interface standard set by Institute of Electrical and Electronics Engineers, which has features like high speed, high bandwidth and hot plug.

Be careful with the polarity of the IEEE1394 connector. Check the pin assignment carefully while you connect the IEEE1394 cable, incorrect connection between the cable and connector will make the device unable to work or even damage it. For optional IEEE1394 cable, please contact your local dealer.

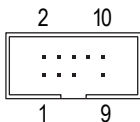
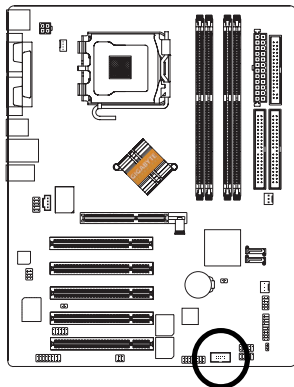

Pin No.	Definition
1	TPA2+
2	TPA2-
3	GND
4	GND
5	TPB2+
6	TPB2-
7	No Pin
8	Power
9	Power
10	GND

19) F2_1394 (IEEE 1394 Connector) ①

Please Note: Serial interface standard set by Institute of Electrical and Electronics Engineers, which has features like high speed, high bandwidth and hot plug.

Be careful with the polarity of the IEEE1394 connector. Check the pin assignment carefully while you connect the IEEE1394 cable, incorrect connection between the cable and connector will make the device unable to work or even damage it. For optional IEEE1394 cable, please contact your local dealer.

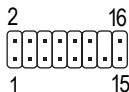
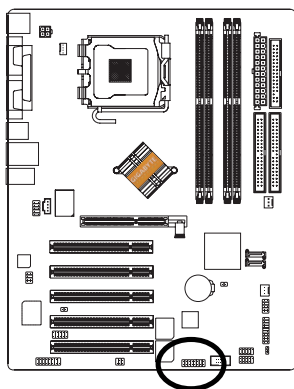

Pin No.	Definition
1	Power
2	Power
3	TPA0+
4	TPA0-
5	GND
6	GND
7	TPB0+
8	TPB0-
9	Power
10	Power
11	TPA1+
12	TPA1-
13	GND
14	No Pin
15	TPB1+
16	TPB1-

① Only for GA-8IPE775 Pro.

20) SATA0/SATA1 (Serial ATA Connector)

You can connect the Serial ATA device to this connector.

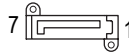
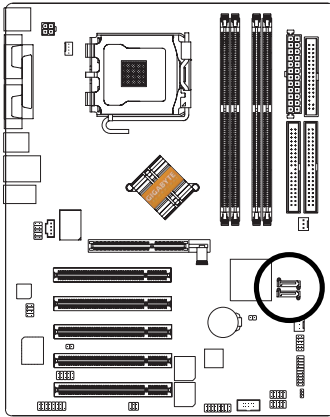

Pin No.	Definition
1	GND
2	TXP
3	TXN
4	GND
5	RXN
6	RXP
7	GND

21) CI (Chassis Intrusion, Case Open)

This 2-pin connector allows your system to enable or disable the "Case Open" item in BIOS, if the system case begin remove.

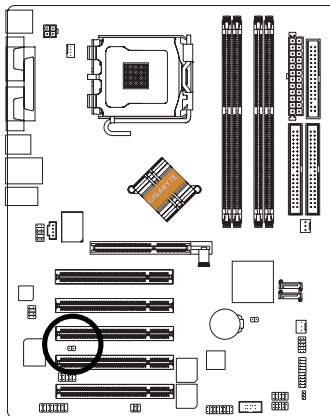

Pin No.	Definition
1	Signal
2	GND

22) CLR_CMOS (Clear CMOS)

You may clear the CMOS data to its default values by this jumper. To clear CMOS, temporarily short 1-2 pin. Default doesn't include the "Shunter" to prevent from improper use this jumper.

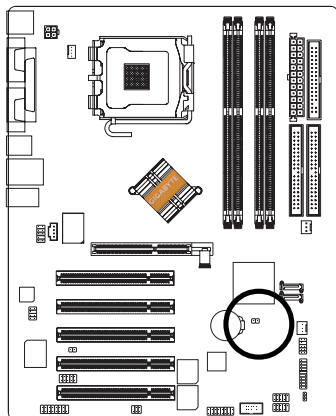

1  Open: Normal

1  Short: Clear CMOS

23) BAT (BATTERY)

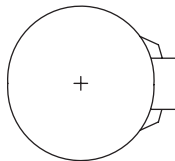
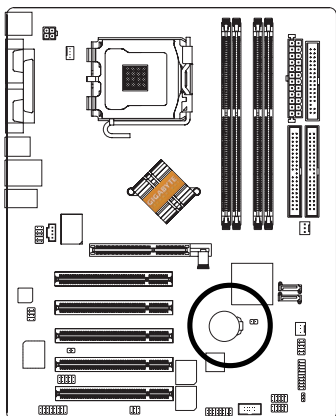

CAUTION

- ❖ Danger of explosion if battery is incorrectly replaced.
- ❖ Replace only with the same or equivalent type recommended by the manufacturer.
- ❖ Dispose of used batteries according to the manufacturer's instructions.

If you want to erase CMOS...

1. Turn OFF the computer and unplug the power cord.
2. Remove the battery, wait for 30 second.
3. Re-install the battery.
4. Plug the power cord and turn ON the computer.

Chapter 3 BIOS Setup

BIOS (Basic Input and Output System) includes a CMOS SETUP utility which allows user to configure required settings or to activate certain system features.

The CMOS SETUP saves the configuration in the CMOS SRAM of the motherboard.

When the power is turned off, the battery on the motherboard supplies the necessary power to the CMOS SRAM.

When the power is turned on, pushing the button during the BIOS POST (Power-On Self Test) will take you to the CMOS SETUP screen. You can enter the BIOS setup screen by pressing "Ctrl + F1".

When setting up BIOS for the first time, it is recommended that you save the current BIOS to a disk in the event that BIOS needs to be reset to its original settings. If you wish to upgrade to a new BIOS, either Gigabyte's Q-Flash or @BIOS utility can be used.

Q-Flash allows the user to quickly and easily update or backup BIOS without entering the operating system.

@BIOS is a Windows-based utility that does not require users to boot to DOS before upgrading BIOS but directly download and update BIOS from the Internet.

CONTROL KEYS

<↑>	Move to previous item
<↓>	Move to next item
<←>	Move to the item in the left hand
<→>	Move to the item in the right hand
Enter	Select item
<Esc>	Main Menu - Quit and not save changes into CMOS Status Page Setup Menu and Option Page Setup Menu - Exit current page and return to Main Menu
<+/PgUp>	Increase the numeric value or make changes
<-/PgDn>	Decrease the numeric value or make changes
<F1>	General help, only for Status Page Setup Menu and Option Page Setup Menu
<F2>	Item Help
<F3>	Reserved
<F4>	Reserved
<F5>	Restore the previous CMOS value from CMOS, only for Option Page Setup Menu
<F6>	Load the file-safe default CMOS value from BIOS default table
<F7>	Load the Optimized Defaults
<F8>	Dual BIOS [Ⓢ] /Q-Flash function
<F9>	System Information
<F10>	Save all the CMOS changes, only for Main Menu

① Only for GA-8IPE775 Pro.

GETTING HELP

Main Menu

The on-line description of the highlighted setup function is displayed at the bottom of the screen.

Status Page Setup Menu / Option Page Setup Menu

Press F1 to pop up a small help window that describes the appropriate keys to use and the possible selections for the highlighted item. To exit the Help Window press <Esc>.

The Main Menu (For example: BIOS Ver. : 8IPE775 Pro.D4)

Once you enter Award BIOS CMOS Setup Utility, the Main Menu will appear on the screen. The Main Menu allows you to select from eight setup functions and two exit choices. Use arrow keys to select among the items and press <Enter> to accept or enter the sub-menu.

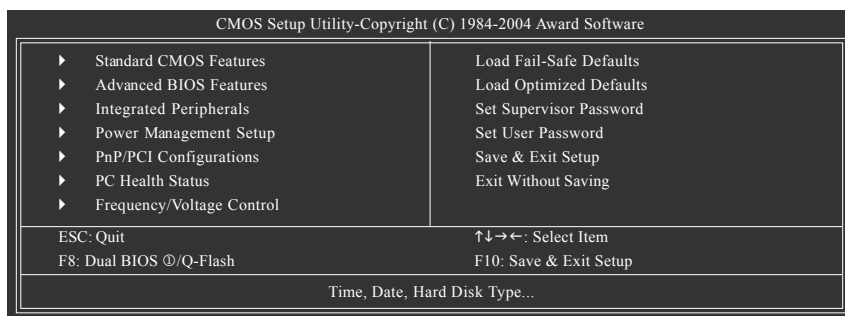

If you can't find the setting you want, please press "Ctrl+F1" to search the advanced option widden.

- **Standard CMOS Features**

This setup page includes all the items in standard compatible BIOS.

- **Advanced BIOS Features**

This setup page includes all the items of Award special enhanced features.

- **Integrated Peripherals**

This setup page includes all onboard peripherals.

① Only for GA-8IPE775 Pro.

- **Power Management Setup**

This setup page includes all the items of Green function features.

- **PnP/PCI Configurations**

This setup page includes all the configurations of PCI & PnP ISA resources.

- **PC Health Status**

This setup page is the System auto detect Temperature, voltage, fan, speed.

- **Frequency/Voltage Control**

This setup page is control CPU's clock and frequency ratio.

- **Load Fail-Safe Defaults**

Fail-Safe Defaults indicates the value of the system parameters which the system would be in safe configuration.

- **Load Optimized Defaults**

Optimized Defaults indicates the value of the system parameters which the system would be in best performance configuration.

- **Set Supervisor password**

Change, set, or disable password. It allows you to limit access to the system and Setup, or just to Setup.

- **Set User password**

Change, set, or disable password. It allows you to limit access to the system.

- **Save & Exit Setup**

Save CMOS value settings to CMOS and exit setup.

- **Exit Without Saving**

Abandon all CMOS value changes and exit setup.

Standard CMOS Features

CMOS Setup Utility-Copyright (C) 1984-2004 Award Software Standard CMOS Features		
		Item Help
Date (mm.dd.yy)	Mon, May 10 2004	
Time (hh:mm:ss)	22:31:24	Menu Level▶
▶ IDE Channel 0 Master	[None]	Change the day, month, year
▶ IDE Channel 0 Slave	[None]	
▶ IDE Channel 1 Master	[None]	<Week>
▶ IDE Channel 1 Slave	[None]	Sun. to Sat.
Drive A	[1.44M, 3.5"]	<Month>
Drive B	[None]	Jan. to Dec.
Floppy 3 Mode Suport	[Disabled]	
Holt On	[All, But Keyboard]	<Day>
Base Memory	640K	1 to 31 (or maximum allowed in the month)
Extended Memory	127M	
Total Memory	128M	<Year>
		1999 to 2098
↑↓→←: Move Enter: Select +/-/PU/PD: Value F10: Save ESC: Exit F1: General Help F5: Previous Values F6: Fail-Save Default F7: Optimized Defaults		

☞ Date

The date format is <week>, <month>, <day>, <year>.

- ▶▶ Week The week, from Sun to Sat, determined by the BIOS and is display only
- ▶▶ Month The month, Jan. Through Dec.
- ▶▶ Day The day, from 1 to 31 (or the maximum allowed in the month)
- ▶▶ Year The year, from 1999 through 2098

☞ Time

The times format in <hour> <minute> <second>. The time is calculated base on the 24-hour military-time clock. For example, 1 p.m. is 13:00:00.

☞ IDE Channel 0 Master, Slave / IDE Channel 1 Master, Slave

- ▶▶ IDE HDD Auto-Detection Press "Enter" to select this option for automatic device detection.
- ▶▶ IDE Channel 0 Master(Slave) / IDE Channel 1 Master(Slave) IDE Device Setup. You can use one of three methods:
 - Auto Allows BIOS to automatically detect IDE devices during POST(default)
 - None Select this if no IDE devices are used and the system will skip the automatic detection step and allow for faster system start up.
 - Manual User can manually input the correct settings
- ▶▶ Access Mode Use this to set the access mode for the hard drive. The four options are: CHS/LBA/Large/Auto(default:Auto)

Hard drive information should be labeled on the outside drive casing. Enter the appropriate option based on this information.

- ▶▶ Cylinder Number of cylinders
- ▶▶ Head Number of heads
- ▶▶ Precomp Write precomp
- ▶▶ Landing Zone Landing zone
- ▶▶ Sector Number of sectors

If a hard disk has not been installed, select NONE and press <Enter>.

☞ Drive A / Drive B

The category identifies the types of floppy disk drive A or drive B that has been installed in the computer.

- ▶▶ None No floppy drive installed
- ▶▶ 360K, 5.25" 5.25 inch PC-type standard drive; 360K byte capacity.
- ▶▶ 1.2M, 5.25" 5.25 inch AT-type high-density drive; 1.2M byte capacity (3.5 inch when 3 Mode is Enabled).
- ▶▶ 720K, 3.5" 3.5 inch double-sided drive; 720K byte capacity
- ▶▶ 1.44M, 3.5" 3.5 inch double-sided drive; 1.44M byte capacity.
- ▶▶ 2.88M, 3.5" 3.5 inch double-sided drive; 2.88M byte capacity.

☞ Floppy 3 Mode Support (for Japan Area)

- ▶ Disabled Normal Floppy Drive. (Default value)
- ▶ Drive A Drive A is 3 mode Floppy Drive.
- ▶ Drive B Drive B is 3 mode Floppy Drive.
- ▶ Both Drive A & B are 3 mode Floppy Drives.

☞ Halt on

The category determines whether the computer will stop if an error is detected during power up.

- ▶ NO Errors The system boot will not stop for any error that may be detected and you will be prompted.
- ▶ All Errors Whenever the BIOS detects a non-fatal error the system boot will be stopped.
- ▶ All, But Keyboard The system boot will not stop for all errors except a keyboard error. (Default value)
- ▶ All, But Diskette The system boot will not stop for all errors except a disk error.
- ▶ All, But Disk/Key The system boot will not stop for all errors except keyboard and disk errors.

☞ Memory

The category is display-only which is determined by POST (Power On Self Test) of the BIOS.

Base Memory

The POST of the BIOS will determine the amount of base (or conventional) memory installed in the system.

The value of the base memory is typically 512 K for systems with 512K memory installed on the motherboard, or 640 K for systems with 640 K or more memory installed on the motherboard.

Extended Memory

The BIOS determines how much extended memory is present during the POST.

This is the amount of memory located above 1MB in the CPU's memory address map.

Advanced BIOS Features

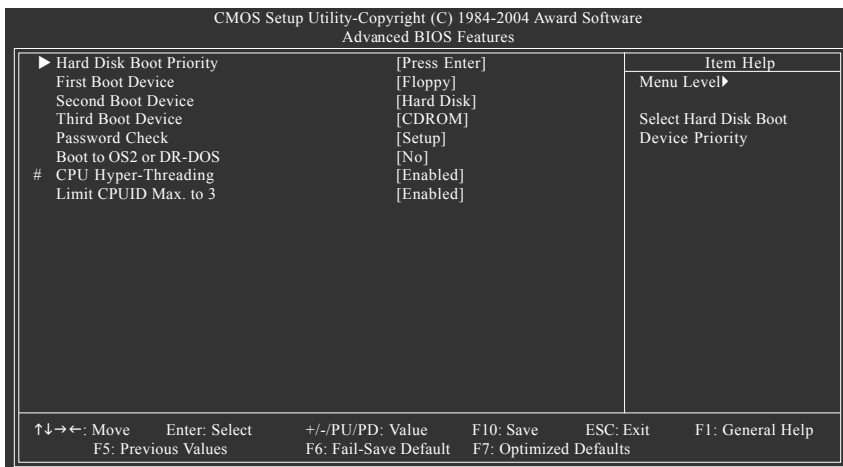

"#" System will detect automatically and show up when you install the Intel® Pentium® 4 processor with HT Technology.

▶ Hard Disk Boot Priority

Select boot sequence for onboard(or add-on cards) SCSI, RAID, etc.

Use <↑> or <↓> to select a device, then press<+> to move it up, or <-> to move it down the list.

Press <ESC> to exit this menu.

▶ First / Second / Third Boot Device

● This feature allows you to select the boot device priority.

- ▶ Floppy Select your boot device priority by Floppy.
- ▶ LS120 Select your boot device priority by LS120.
- ▶ Hard Disk Select your boot device priority by Hard Disk.
- ▶ CDROM Select your boot device priority by CDROM.
- ▶ ZIP Select your boot device priority by ZIP.
- ▶ USB-FDD Select your boot device priority by USB-FDD.
- ▶ USB-ZIP Select your boot device priority by USB-ZIP.
- ▶ USB-CDROM Select your boot device priority by USB-CDROM.
- ▶ USB-HDD Select your boot device priority by USB-HDD.
- ▶ LAN Select your boot device priority by LAN.
- ▶ Disabled Select your boot device priority by Disabled.

☞ Password Check

- ▶▶ Setup The system will boot but will not access to Setup page if the correct password is not entered at the prompt. (Default value)
- ▶▶ System The system will not boot and will not access to Setup page if the correct password is not entered at the prompt.

☞ Boot to OS2 or DR-DOS

- ▶▶ Yes If you are running OS/2 or DR-DOS with greater than 64MB of RAM on the system.
- ▶▶ No Disable this function. (Default value)

☞ CPU Hyper-Threading

- ▶▶ Enabled Enables CPU Hyper Threading Feature. Please note that this feature is only working for operating system with multi processors mode supported. (Default value)
- ▶▶ Disabled Disables CPU Hyper Threading.

☞ Limit CPUID Max. to 3

- ▶▶ Enabled Limit CPUID Maximum value to 3 when use older OS like NT4. (Default value)
- ▶▶ Disabled Disables CPUID Limit for windows XP.

Integrated Peripherals

CMOS Setup Utility-Copyright (C) 1984-2004 Award Software
Integrated Peripherals

		Item Help
	On-Chip Primary PCI IDE	[Enabled]
	On-Chip Secondary PCI IDE	[Enabled]
	On-Chip SATA	[Auto]
x	SATA Port0 Configure as	SATA Port0
	SATA Port1 Configure as	SATA Port1
	USB Controller	[Enabled]
	USB 2.0 Controller	[Enabled]
	USB Keyboard Support	[Disabled]
	USB Mouse Support	[Disabled]
	AC97 Audio	[Auto]
	Onboard H/W 1394 ①	[Enabled]
	Onboard H/W LAN ②	[Enabled]
	Onboard LAN Boot ROM ①②	[Disabled]
	Onboard Serial Port 1	[3F8/IRQ4]
	Onboard Serial Port 2	[2F8/IRQ3]
	UART Mode Select	[Normal]
x	UR2 Duplex Mode	Half
	Onboard Parallel Port	[378/IRQ7]
	Parallel Port Mode	[SPP]
		If a hard disk controller card is used, set at Disabled
		[Enabled] Enable on-chip IDE Port
		[Disabled] Disable on-chip IDE Port

↑↓→←: Move Enter: Select +/-/PU/PD: Value F10: Save ESC: Exit F1: General Help
 F5: Previous Values F6: Fail-Save Default F7: Optimized Defaults

CMOS Setup Utility-Copyright (C) 1984-2004 Award Software
Integrated Peripherals

		Item Help
x	ECP Mode Use DMA	3
	Game Port Address	[201]
	Midi Port Address	[Disabled]
	Midi Port IRQ	10
	CIR Port Address	[Disabled]
x	CIR Port IRQ	11

↑↓→←: Move Enter: Select +/-/PU/PD: Value F10: Save ESC: Exit F1: General Help
 F5: Previous Values F6: Fail-Save Default F7: Optimized Defaults

① Only for GA-8IPE775 Pro.

② Only for GA-8IPE775-G.

☞ On-Chip Primary PCI IDE

- ▶▶ Enabled Enable onboard 1st channel IDE port. (Default value)
- ▶▶ Disabled Disable onboard 1st channel IDE port.

☞ On-Chip Secondary PCI IDE

- ▶▶ Enabled Enable onboard 2nd channel IDE port. (Default value)
- ▶▶ Disabled Disable onboard 2nd channel IDE port.

☞ On-chip SATA

- ▶▶ Disabled Disable SATA controller.
- ▶▶ Auto When there is no device to be plugged in IDE1 or IDE2, SATA controller will remap to IDE controller. (Default value)
- ▶▶ Manual Set SATA Mode manually.

☞ SATA Port0 Configure as

- ▶▶ IDE Pri. Master Remap SATA Port 0 to IDE Pri. Master.
- ▶▶ IDE Pri. Slave Remap SATA Port 0 to IDE Pri. Slave.
- ▶▶ IDE Sec. Master Remap SATA Port 0 to IDE Sec. Master.
- ▶▶ IDE Sec. Slave Remap SATA Port 0 to IDE Sec. Slave.
- ▶▶ SATA Port0 SATA controller set to SATA port0. As this mode, it support by WinXP or later OS only. (Default value)
- ▶▶ SATA Port1 SATA controller set to SATA port1. As this mode, it support by WinXP or later OS only.

☞ SATA Port1 Configure as

- ▶▶ The values depend on SATA Port0.

☞ USB Controller

- ▶▶ Enabled Enable USB Controller. (Default value)
- ▶▶ Disabled Disable USB Controller.

☞ USB 2.0 Controller

- Disable this function if you are not using onboard USB 2.0 feature.
- ▶▶ Enabled Enable USB 2.0 Controller. (Default value)
 - ▶▶ Disabled Disable USB 2.0 Controller.

☞ USB Keyboard Support

- ▶▶ Enabled Enable USB Keyboard Support.
- ▶▶ Disabled Disable USB Keyboard Support. (Default value)

☞ USB Mouse Support

- ▶ Enabled Enable USB Mouse Support.
- ▶ Disabled Disable USB Mouse Support. (Default value)

☞ AC97 Audio

- ▶ Auto Auto detect AC'97 audio function. (Default value)
- ▶ Disabled Disable AC'97 audio function.

☞ Onboard H/W 1394 ①

- ▶ Enabled Enable onboard IEEE 1394 function.(Default value)
- ▶ Disabled Disable this function.

☞ Onboard H/W LAN ① ②

- ▶ Enabled Enable Onboard H/W LAN function. (Default value)
- ▶ Disabled Disable this function.

☞ Onboard LAN Boot ROM ① ②

This function decide whether to invoke the boot ROM of the onboard LAN chip.

- ▶ Disabled Disable this function. (Default Value)
- ▶ Enabled Enable this function.

☞ Onboard Serial Port 1

- ▶ Auto BIOS will automatically setup the port 1 address.
- ▶ 3F8/IRQ4 Enable onboard Serial port 1 and address is 3F8. (Default value)
- ▶ 2F8/IRQ3 Enable onboard Serial port 1 and address is 2F8.
- ▶ 3E8/IRQ4 Enable onboard Serial port 1 and address is 3E8.
- ▶ 2E8/IRQ3 Enable onboard Serial port 1 and address is 2E8.
- ▶ Disabled Disable onboard Serial port 1.

☞ Onboard Serial Port 2

- ▶ Auto BIOS will automatically setup the port 2 address.
- ▶ 3F8/IRQ4 Enable onboard Serial port 2 and address is 3F8.
- ▶ 2F8/IRQ3 Enable onboard Serial port 2 and address is 2F8. (Default value)
- ▶ 3E8/IRQ4 Enable onboard Serial port 2 and address is 3E8.
- ▶ 2E8/IRQ3 Enable onboard Serial port 2 and address is 2E8.
- ▶ Disabled Disable onboard Serial port 2.

① Only for GA-8IPE775 Pro.

② Only for GA-8IPE775-G.

☞ **UART Mode Select**

This item allows you to determine which Infra Red(IR) function of Onboard I/O chip.

- ▶ ASKIR Set onboard I/O chip UART to ASKIR Mode.
- ▶ IrDA Set onboard I/O chip UART to IrDA Mode.
- ▶ Normal Set onboard I/O chip UART to Normal Mode. (Default Value)

☞ **UR2 Duplex Mode**

This feature allows you to select IR mode.

This function will be available when "UART Mode Select" is not set at Normal.

- ▶ Half IR Function Duplex Half. (Default value)
- ▶ Full IR Function Duplex Full.

☞ **Onboard Parallel port**

This feature allows you to select from a given set of parameters if the parallel port uses the onboard I/O controller.

- ▶ Disabled Disable onboard LPT port.
- ▶ 378/IRQ7 Enable onboard LPT port and address is 378/IRQ7. (Default value)
- ▶ 278/IRQ5 Enable onboard LPT port and address is 278/IRQ5.
- ▶ 3BC/IRQ7 Enable onboard LPT port and address is 3BC/IRQ7.

☞ **Parallel Port Mode**

This feature allows you to connect with an advanced printer via the port mode it supports.

- ▶ SPP Using Parallel port as Standard Parallel Port. (Default value)
- ▶ EPP Using Parallel port as Enhanced Parallel Port.
- ▶ ECP Using Parallel port as Extended Capabilities Port.
- ▶ ECP+EPP Using Parallel port as ECP & EPP mode.

☞ **ECP Mode Use DMA**

This feature allows you to select Direct Memory Access(DMA) channel if the ECP mode is selected.

This function will be available when "Parallel Port Mode" is set at ECP or ECP+EPP.

- ▶ 3 Set ECP Mode Use DMA to 3. (Default value)
- ▶ 1 Set ECP Mode Use DMA to 1.

☞ **Game Port Address**

- ▶ 201 Set Game Port Address to 201. (Default value)
- ▶ 209 Set Game Port Address to 209.
- ▶ Disabled Disable this function.

☞ **Midi Port Address**

- ▶ 300 Set Midi Port Address to 300.
- ▶ 330 Set Midi Port Address to 330.
- ▶ Disabled Disable this function. (Default value)

⊟ Midi Port IRQ

- ▶▶ 5 Set Midi Port IRQ to 5.
- ▶▶ 10 Set Midi Port IRQ to 10. (Default value)

⊟ CIR Port Address

- ▶▶ 310 Set CIR Port Address to 310.
- ▶▶ 320 Set CIR Port Address to 320.
- ▶▶ Disabled Disable this function. (Default value)

⊟ CIR Port IRQ

- ▶▶ 5 Set CIR Port IRQ to 5.
- ▶▶ 11 Set CIR Port IRQ to 11. (Default value)

Power Management Setup

CMOS Setup Utility-Copyright (C) 1984-2004 Award Software		
Power Management Setup		
		Item Help
ACPI Suspend Type	[S1(POS)]	Menu Level▶
Power LED in S1 state	[Blinking]	
Off by Power button	[Instant-off]	
PME Event Wake Up	[Enabled]	[S1]
ModemRingOn/WakeOnLan	[Enabled]	Set suspend type to
Resume by Alarm	[Disabled]	Power On Suspend under
x Date (of Month) Alarm	Everyday	ACPI OS
x Time (hh:mm:ss) Alarm	0 : 0 : 0	
Power On By Mouse	[Disabled]	[S3]
Power On By Keyboard	[Disabled]	Set suspend type to
x KB Power ON Password	Enter	Suspend to RAM under
AC Back Function	[Soft-Off]	ACPI OS

↑↓→←: Move Enter: Select +/-/PU/PD: Value F10: Save ESC: Exit F1: General Help
 F5: Previous Values F6: Fail-Save Default F7: Optimized Defaults

⊟ ACPI Suspend Type

- ▶▶ S1(POS) Set ACPI suspend type to S1/POS(Power On Suspend). (Default value)
- ▶▶ S3(STR) Set ACPI suspend type to S3/STR(Suspend To RAM).

⊟ Power LED in S1 state

- ▶▶ Blinking In standby mode(S1), power LED will blink. (Default value)
- ▶▶ Dual/OFF In standby mode(S1):
 - a. If use single color LED, power LED will turn off.
 - b. If use dual color LED, power LED will turn to another color.

☞ Off by Power button

- ▶▶ Instant-off Press power button then Power off instantly. (Default value)
- ▶▶ Delay 4 Sec. Press power button 4 sec. to Power off. Enter suspend if button is pressed less than 4 sec.

☞ PME Event Wake Up

- ▶▶ Disabled Disable this function.
- ▶▶ Enabled Enable PME Event Wake up. (Default value)

☞ ModemRingOn/WakeOnLAN

An incoming call via modem can awake the system from any suspend state or an input signal comes from the other client server on the LAN can awake the system from any suspend state.

- ▶▶ Disabled Disable Modem Ring on/wake on Lan function.
- ▶▶ Enabled Enable Modem Ring on/wake on Lan. (Default value)

☞ Resume by Alarm

You can set "Resume by Alarm" item to enabled and key in Data/time to power on system.

- ▶▶ Disabled Disable this function. (Default value)
- ▶▶ Enabled Enable alarm function to POWER ON system.
If RTC Alarm Lead To Power On is Enabled.
Date (of Month) Alarm : Everyday, 1~31
Time (hh: mm: ss) Alarm : (0~23) : (0~59) : (0~59)

☞ Power On By Mouse

- ▶▶ Disabled Disable this function. (Default value)
- ▶▶ Mouse Click Double click on PS/2 mouse left button to power on the system.

☞ Power On By Keyboard

This feature allows you to set the method for powering-on the system.

The option "Password" allows you to set up to 5 alphanumeric characters to power-on the system.

The option "Keyboard 98" allows you to use the standard keyboard 98 to power on the system.

- ▶▶ Password Enter from 1 to 5 characters to set the Keyboard Power On Password.
- ▶▶ Disabled Disabled this function. (Default value)
- ▶▶ Keyboard 98 If your keyboard have "POWER Key" button, you can press the key to power on the system.

☞ KB Power ON Password

When "Power On by Keyboard" set at Password, you can set the password here.

- ▶▶ Enter Input password (from 1 to 5 characters) and press Enter to set the Keyboard Power On password.

☞ AC BACK Function

- ▶▶ Soft-Off When AC-power back to the system, the system will be in "Off" state.
(Default value)
- ▶▶ Full-On When AC-power back to the system, the system always in "On" state.
- ▶▶ Memory When AC-power back to the system, the system will return to the Last state
before AC-power off.

PnP/PCI Configurations

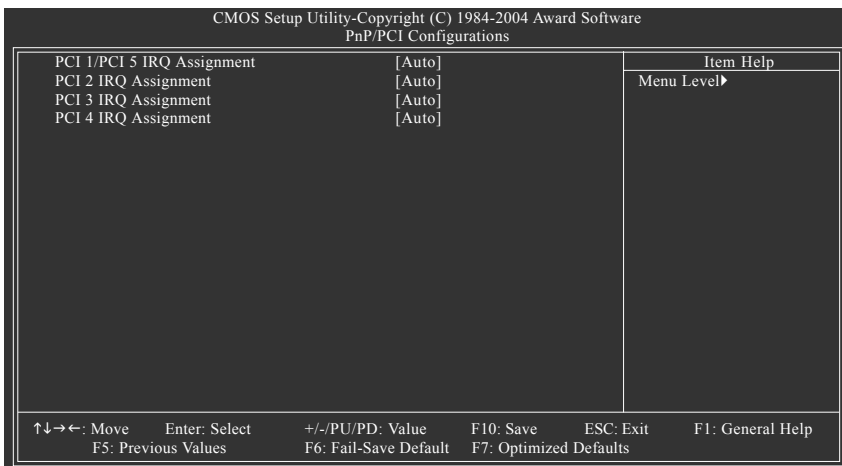

☞ PCI 1/PCI 5 IRQ Assignment

- ▶▶ Auto Auto assign IRQ to PCI 1/PCI 5. (Default value)
- ▶▶ 3,4,5,7,9,10,11,12,14,15 Set IRQ 3,4,5,7,9,10,11,12,14,15 to PCI 1/PCI 5.

☞ PCI 2 IRQ Assignment

- ▶▶ Auto Auto assign IRQ to PCI 2. (Default value)
- ▶▶ 3,4,5,7,9,10,11,12,14,15 Set IRQ 3,4,5,7,9,10,11,12,14,15 to PCI 2.

☞ PCI 3 IRQ Assignment

- ▶▶ Auto Auto assign IRQ to PCI 3. (Default value)
- ▶▶ 3,4,5,7,9,10,11,12,14,15 Set IRQ 3,4,5,7,9,10,11,12,14,15 to PCI 3.

☞ PCI 4 IRQ Assignment

- ▶▶ Auto Auto assign IRQ to PCI 4. (Default value)
- ▶▶ 3,4,5,7,9,10,11,12,14,15 Set IRQ 3,4,5,7,9,10,11,12,14,15 to PCI 4.

PC Health Status

CMOS Setup Utility-Copyright (C) 1984-2004 Award Software		
PC Health Status		
		Item Help
Reset Case Open Status	[Disabled]	Menu Level▶
Case Opened	Yes	
Vcore	OK	
DDR25V	OK	[Disabled]
+3.3V	OK	Don't monitor
+12V	OK	current fan speed
Current CPU Temperature	50°C	
Current CPU FAN Speed	4687 RPM	
Current POWER FAN Speed ①	0 RPM	[Enabled]
Current SYSTEM FAN Speed	0 RPM	Clear case open status
CPU Warning Temperature	[Disabled]	and set to be Disabled
CPU FAN Fail Warning	[Disabled]	at next boot
POWER FAN Fail Warning ①	[Disabled]	
SYSTEM FAN Fail Warning	[Disabled]	
CPU Smart FAN Control ①②	[Enabled]	

↑↓→←: Move	Enter: Select	+/-/PU/PD: Value	F10: Save	ESC: Exit	F1: General Help
F5: Previous Values		F6: Fail-Save Default	F7: Optimized Defaults		

Reset Case Open Status

- ▶ Disabled Don't reset case open status. (Default value)
- ▶ Enabled Clear case open status at next boot.

Case Opened

If the case is closed, "Case Opened" will show "No".

If the case have been opened, "Case Opened" will show "Yes".

If you want to reset "Case Opened" value, set "Reset Case Open Status" to "Enabled" and save CMOS, your computer will restart.

Current Voltage (V) Vcore / DDR25V / +3.3V / +12V

- ▶ Detect system's voltage status automatically.

Current CPU Temperature

- ▶ Detect CPU Temp. automatically.

Current CPU/POWER ① /SYSTEM FAN Speed (RPM)

- ▶ Detect CPU/POWER/SYSTEM Fan speed status automatically.

① Only for GA-8IPE775 Pro.

② Only for GA-8IPE775-G.

☞ CPU Warning Temperature

- ▶▶ 60°C / 140°F Monitor CPU Temp. at 60°C / 140°F.
- ▶▶ 70°C / 158°F Monitor CPU Temp. at 70°C / 158°F.
- ▶▶ 80°C / 176°F Monitor CPU Temp. at 80°C / 176°F.
- ▶▶ 90°C / 194°F Monitor CPU Temp. at 90°C / 194°F.
- ▶▶ Disabled Disable this function. (Default value)

☞ CPU FAN Fail Warning

- ▶▶ Disabled Fan Warning Function Disable. (Default value)
- ▶▶ Enabled Fan Warning Function Enable.

☞ POWER FAN Fail Warning ①

- ▶▶ Disabled Fan Warning Function Disable. (Default value)
- ▶▶ Enabled Fan Warning Function Enable.

☞ SYSTEM FAN Fail Warning

- ▶▶ Disabled Fan Warning Function Disable. (Default value)
- ▶▶ Enabled Fan Warning Function Enable.

☞ CPU Smart FAN Control ① ②

- ▶▶ Disabled Disable this function.
- ▶▶ Enabled Enable CPU Smart Fan control function.(Default value)
 - a. When the CPU temperature is higher than 70 degrees Celsius, CPU fan will run at full speed.
 - b. When the CPU temperature is between 50 and 70 degrees Celsius, CPU fan will run at high speed.
 - c. When the CPU temperature is between 40 and 50 degrees Celsius, CPU fan will run at medium speed.
 - d. When the CPU temperature is lower than 40 degrees Celsius, CPU fan will run at low speed.

① Only for GA-8IPE775 Pro.

② Only for GA-8IPE775-G.

Frequency/Voltage Control

CMOS Setup Utility-Copyright (C) 1984-2004 Award Software
Frequency/Voltage Control

CPU Clock Ratio	[15X]	Item Help
CPU Host Clock Control	[Disabled]	Menu Level▶
x CPU Host Frequency (Mhz)	100	
x AGP/PCI/SRC Fixed	66/33/100	
Memory Frequency For	[Auto]	
Memory Frequency (Mhz)	266	
AGP/PCI/SRC Frequency (Mhz)	66/33/100	
DIMM OverVoltage Control	[Normal]	
AGP OverVoltage Control	[Normal]	
CPU Voltage Control	[Normal]	
Normal CPU Vcore	1.3875V	

↑↓→←: Move Enter: Select +/-/PU/PD: Value F10: Save ESC: Exit F1: General Help
F5: Previous Values F6: Fail-Save Default F7: Optimized Defaults



CAUTION

Incorrect using these features may cause your system broken. For power End-User use only!

☞ CPU Clock Ratio

This option will not be shown or not be available if you are using a CPU with the locked ratio.

This setup option will automatically assign by CPU detection.

The option will display "Locked" and read only if the CPU ratio is not changeable.

☞ CPU Host Clock Control

Please note that if your system is overclocked and cannot restart, please wait 20secs. for automatic system restart or clear the CMOS setup data and perform a safe restart.

▶ Disabled Disable CPU Host Clock Control. (Default value)

▶ Enabled Enable CPU Host Clock Control.

☞ CPU Host Frequency (Mhz)

This item will be available when "CPU Host Clock Control" is set to Enabled.

▶ 100MHz ~ 355MHz Set CPU Host Clock from 100MHz to 355MHz.

If you use FSB400 Pentium 4 processor, please set "CPU Clock" to 100MHz. If you use FSB533 Pentium 4 processor, please set "CPU Clock" to 133MHz. If you use FSB800 Pentium 4 processor, please set "CPU Clock" to 200MHz.

Incorrect using it may cause your system broken. For power End-User use only!

☞ **AGP/PCI/SRC Fixed**

This item will be available when "CPU Host Clock Control" is set to Enabled.

Serial ATA device is very sensitive to SRC clock. SRC over clock may make Serial ATA device function can't work properly.

- ▶▶ Adjust AGP/PCI/SRC clock asychroous with CPU.

☞ **Memory Frequency For**

for FSB(Front Side Bus) frequency=400MHz,

- ▶▶ 2.66 Memory Frequency = Host clock X 2.66.
- ▶▶ Auto Set Memory frequency by DRAM SPD data. (Default value)

for FSB(Front Side Bus) frequency=533MHz,

- ▶▶ 2.0 Memory Frequency = Host clock X 2.0.
- ▶▶ 2.5 Memory Frequency = Host clock X 2.5.
- ▶▶ Auto Set Memory frequency by DRAM SPD data. (Default value)

for FSB(Front Side Bus) frequency=800MHz,

- ▶▶ 2.0 Memory Frequency = Host clock X 2.0.
- ▶▶ 1.6 Memory Frequency = Host clock X 1.6.
- ▶▶ 1.33 Memory Frequency = Host clock X 1.33.
- ▶▶ Auto Set Memory frequency by DRAM SPD data. (Default value)

☞ **Memory Frequency (Mhz)**

- ▶▶ The values depend on CPU Host Frequency(Mhz).

☞ **AGP/PCI/SRC Frequency (Mhz)**

- ▶▶ The values depend on Fixed AGP/PCI/SRC Fixed.

☞ **DIMM OverVoltage Control**

- ▶▶ Normal Set DIMM OverVoltage Control to Normal. (Default value)
- ▶▶ +0.1V Set DIMM OverVoltage Control to +0.1V.
- ▶▶ +0.2V Set DIMM OverVoltage Control to +0.2V.
- ▶▶ +0.3V Set DIMM OverVoltage Control to +0.3V.

Increase DRAM voltage may get stable for Over_Clock. But it may damage to DRAM module when enable this feature.

☞ **AGP OverVoltage Control**

- ▶▶ Normal Set AGP OverVoltage Control to Normal. (Default value)
- ▶▶ +0.1V Set AGP OverVoltage Control to +0.1V.
- ▶▶ +0.2V Set AGP OverVoltage Control to +0.2V.
- ▶▶ +0.3V Set AGP OverVoltage Control to +0.3V.

Increase AGP voltage may get stable for Over_Clock. But it may damage to AGP Card when enable this feature.

☞ CPU OverVoltage Control

‣ Supports adjustable CPU Vcore from 0.8375V to 1.7600V. (Default value: Normal)

☞ Normal CPU Vcore

‣ Display your CPU Vcore Voltage.

Load Fail-Safe Defaults

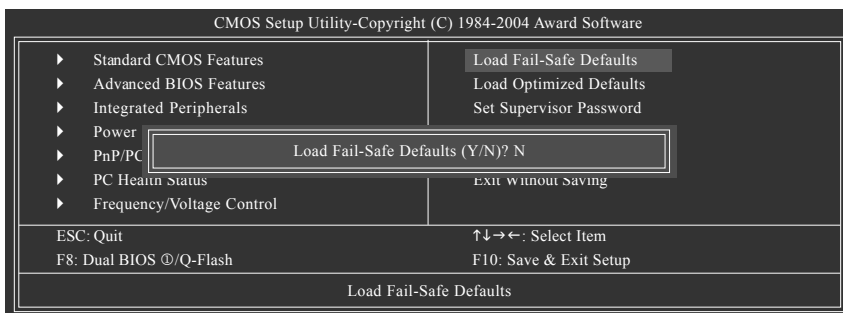

Fail-Safe defaults contain the most appropriate values of the system parameters that allow minimum system performance.

Load Optimized Defaults

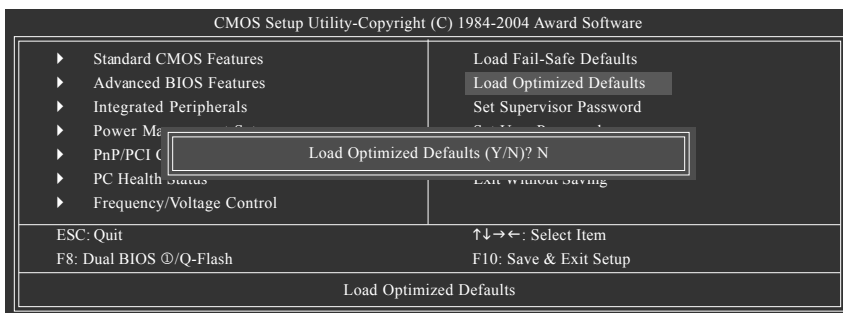

Selecting this field loads the factory defaults for BIOS and Chipset Features which the system automatically detects.

① Only for GA-8IPE775 Pro.

Set Supervisor/User Password

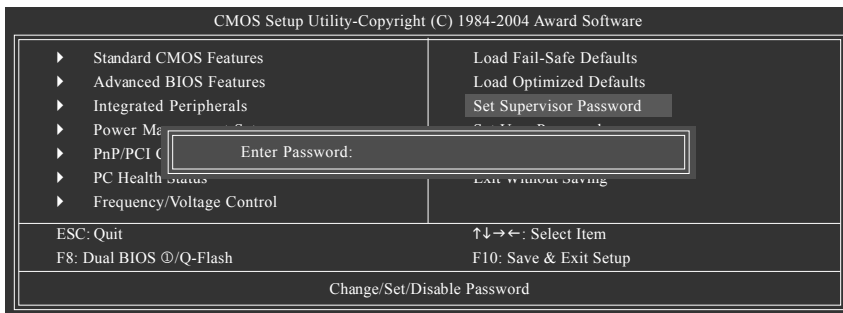

When you select this function, the following message will appear at the center of the screen to assist you in creating a password.

Type the password, up to eight characters, and press <Enter>. You will be asked to confirm the password. Type the password again and press <Enter>. You may also press <Esc> to abort the selection and not enter a password.

To disable password, just press <Enter> when you are prompted to enter password. A message "PASSWORD DISABLED" will appear to confirm the password being disabled. Once the password is disabled, the system will boot and you can enter Setup freely.

The BIOS Setup program allows you to specify two separate passwords:

SUPERVISOR PASSWORD and a USER PASSWORD. When disabled, anyone may access all BIOS Setup program function. When enabled, the Supervisor password is required for entering the BIOS Setup program and having full configuration fields, the User password is required to access only basic items.

If you select "System" at "Password Check" in Advance BIOS Features Menu, you will be prompted for the password every time the system is rebooted or any time you try to enter Setup Menu.

If you select "Setup" at "Password Check" in Advance BIOS Features Menu, you will be prompted only when you try to enter Setup.

① Only for GA-8IPE775 Pro.

Save & Exit Setup

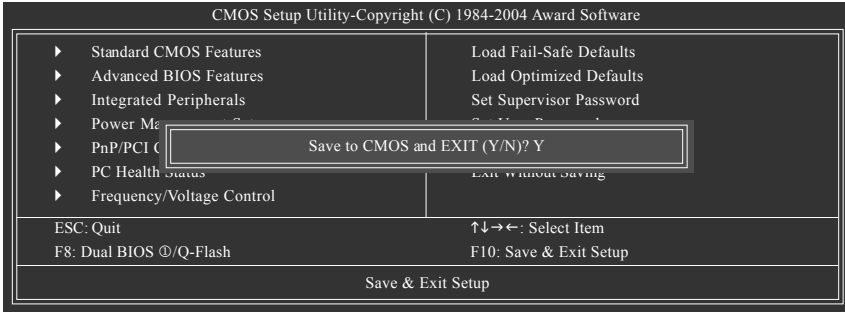

Type "Y" will quit the Setup Utility and save the user setup value to RTC CMOS.

Type "N" will return to Setup Utility.

Exit Without Saving

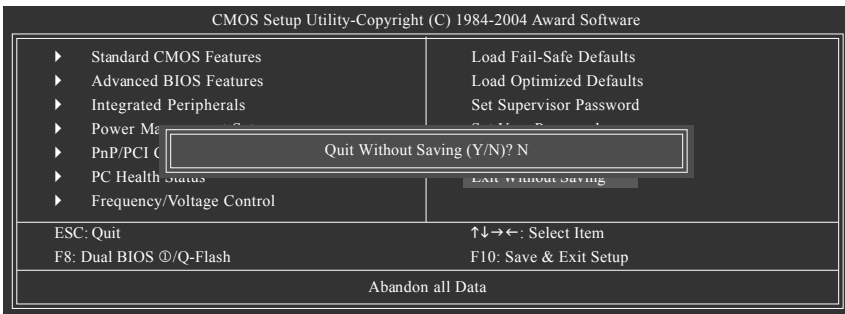

Type "Y" will quit the Setup Utility without saving to RTC CMOS.

Type "N" will return to Setup Utility.

① Only for GA-8IPE775 Pro.

Chapter 4 Technical Reference

Flash BIOS Method Introduction

Method 1: Dual BIOS ① /Q-Flash

A. What is Dual BIOS Technology?

Dual BIOS means that there are two system BIOS (ROM) on the motherboard, one is the Main BIOS and the other is Backup BIOS. Under the normal circumstances, the system works on the Main BIOS. If the Main BIOS is corrupted or damaged, the Backup BIOS can take over while the system is powered on. This means that your PC will still be able to run stably as if nothing has happened in your BIOS.

B. How to use Dual BIOS and Q-Flash Utility?

a. After power on the computer, pressing immediately during POST (Power On Self Test) it will allow you to enter Award BIOS CMOS SETUP, then press <F8> to enter Flash utility.

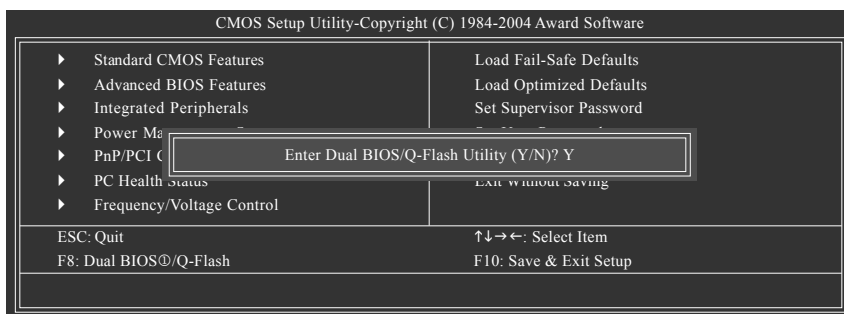

① Only for GA-8IPE775 Pro.

b. Award Dual BIOS Flash ROM Programming Utility

Dual BIOS Utility V1.30			
Boot From.....	Main Bios		
Main ROM Type/Size.....	SST 49LF003A	512K	
Backup ROM Type/Size.....	SST 49LF003A	512K	
Wide Range Protection	Disable		
Boot From	Main Bios		
Auto Recovery	Enable		
Halt On Error	Disable		
Keep DMI Data	Enable		
Copy Main ROM Data to Backup			
Load Default Settings			
Save Settings to CMOS			
Q-Flash Utility			
Update Main BIOS from Floppy			
Update Backup BIOS from Floppy			
Save Main BIOS to Floppy			
Save Backup BIOS to Floppy			
PgDn/PgUp: Modify	↑ ↓ : Move	ESC: Reset	F10: Power Off

c. Dual BIOS Item explanation:

Wide Range Protection: Disable(Default), Enable

Status 1:

If any failure (ex. Update ESCD failure, checksum error or reset...) occurs in the Main BIOS, just before the Operating System is loaded and after the power is on, and that the Wide Range Protection is set to "Enable", the PC will boot from Backup BIOS automatically.

Status 2:

If the ROM BIOS on peripherals cards(ex. SCSI Cards, LAN Cards,...) emits signals to request restart of the system after the user make any alteration on it, the boot up BIOS will not be changed to the Backup BIOS.

Boot From : Main BIOS(Default), Backup BIOS

Status 1:

The user can set to boot from main BIOS or Backup BIOS.

Status 2:

If one of the main BIOS or the Backup BIOS fails, this item "Boot From : Main BIOS(Default)" will become gray and will not be changed by user.

Auto Recovery : Enable(Default), Disable

When one of the Main BIOS or Backup BIOS occurs checksum failure, the working BIOS will automatically recover the BIOS of checksum failure.

(In the Power Management Setup of the BIOS Setting, if ACPI Suspend Type is set to Suspend to RAM, the Auto Recovery will be set to Enable automatically.)

(If you want to enter the BIOS setting, please press "Del" key when the boot screen appears.)

Halt On Error : Disable(Default), Enable

If the BIOS occurs a checksum error or the Main BIOS occurs a WIDE RANGE PROTECTION error and Halt On Error set to Enable, the PC will show messages on the boot screen, and the system will pause and wait for the user's instruction.

If Auto Recovery :**Disable**, it will show *<or the other key to continue.>*

If Auto Recovery :**Enable**, it will show *<or the other key to Auto Recover.>*

Keep DMI Data : Enable(Default), Disable

Enable: The DMI data won't be replaced by flashing new BIOS.(recommend)

Disable: The DMI data will be replaced by flashing new BIOS.

Copy Main ROM Data to Backup

(If you boot from Backup ROM, this item will change to Copy Backup ROM Data to Main)

Auto recovery message:

BIOS Recovery: Main to Backup

The means that the Main BIOS works normally and could automatically recover the Backup BIOS.

BIOS Recovery: Backup to Main

The means that the Backup BIOS works normally and could automatically recover the Main BIOS.

(This auto recovery utility is set by system automatically and can't be changed by user.)

Load Default Settings

Load dual BIOS default value.

Save Settings to CMOS

Save revised setting.



Q-Flash™ is a BIOS flash utility embedded in Flash ROM. With this utility, users only have to stay in the BIOS menu when they want to update BIOS. Q-Flash™ allows users to flash BIOS without any utility in DOS or Windows. Using

Q-Flash™ indicating no more fooling around with any complicated instructions and operating system since it is in the BIOS menu.



CAUTION

Please note that because updating BIOS has potential risk, please do it with caution!! We are sorry that Gigabyte Technology Co., Ltd is not responsible for damages of system because of incorrect manipulation of updating BIOS to avoid any claims from end-users.

Before You Begin:

Before you start updating BIOS with the Q-Flash™ utility, please follow the steps below first.

1. Download the latest BIOS for your motherboard from Gigabyte's website.
2. Extract the BIOS file downloaded and save the BIOS file (the one with model name.Fxx. For example, 8KNXPU.Fba) to a floppy disk.
3. Reboot your PC and press **Del** to enter BIOS menu.

The BIOS upgrading guides below are separated into two parts.

If your motherboard has dual-BIOS, please refer to **Part One**.

If your motherboard has single-BIOS, please refer to **Part Two**.

Part One:

Updating BIOS with Q-Flash™ Utility on Dual BIOS Motherboards.

Some of Gigabyte motherboards are equipped with dual BIOS. In the BIOS menu of the motherboards supporting Q-Flash and Dual BIOS, the Q-Flash utility and Dual BIOS utility are combined in the same screen. This section only deals with how to use Q-Flash utility.

In the following sections, we take GA-8KNXP Ultra as the example to guide you how to flash BIOS from an older version to the latest version. For example, from Fa3 to Fba.

The BIOS file is Fa3 before updating

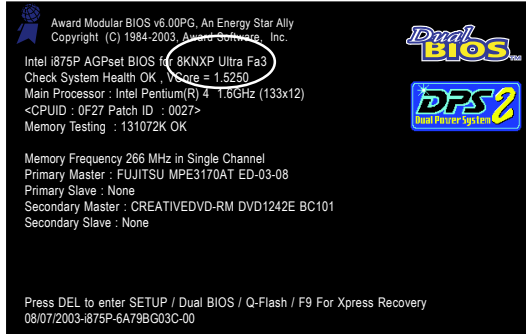

Entering the Q-Flash™ utility:

Step1: To use Q-Flash utility, you must press **Del** in the boot screen to enter BIOS menu.

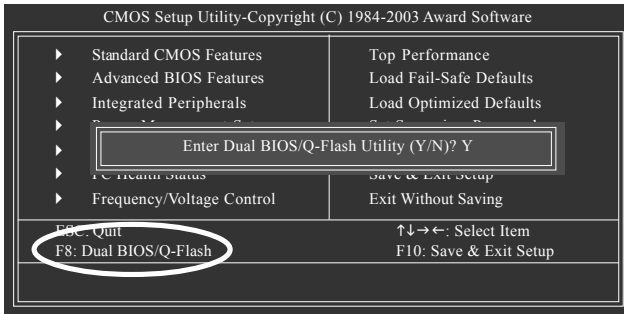

Step 2: Press **F8** button on your keyboard and then **Y** button to enter the Dual BIOS/Q-Flash utility.

Exploring the Q-Flash™ / Dual BIOS utility screen

The Q-Flash / Dual BIOS utility screen consists of the following key components.

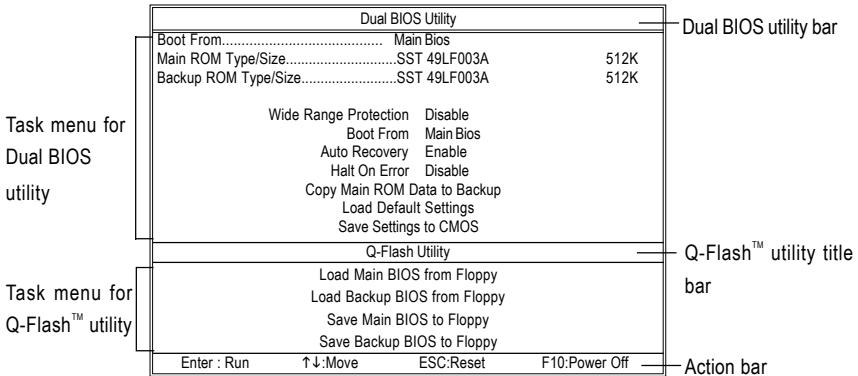

Task menu for Dual BIOS utility:

Contains the names of eight tasks and two items showing information about the BIOS ROM type. Blocking a task and pressing **Enter** key on your keyboard to enable execution of the task.

Task menu for Q-Flash utility:

Contains the names of four tasks. Blocking a task and pressing **Enter** key on your keyboard to enable execution of the task.

Action bar:

Contains the names of four actions needed to operate the Q-Flash/Dual BIOS utility. Pressing the buttons mentioned on your keyboards to perform these actions.

Using the Q-Flash™ utility:

This section tells you how to update BIOS using the Q-Flash utility. As described in the "Before you begin" section above, you must prepare a floppy disk having the BIOS file for your motherboard and insert it to your computer. If you have already put the floppy disk into your system and have entered the Q-Flash utility, please follow the steps below to flash BIOS.

Steps:

1. Press arrow buttons on your keyboard to move the light bar to "Load Main BIOS from Floppy" item in the Q-Flash menu and press **Enter** button.

Later, you will see a box pop up showing the BIOS files you previously downloaded to the floppy disk.



If you want to save the current BIOS for backup purpose, you can begin Step 1 with "Save Main BIOS to Floppy" item.

4. Press any keys to return to the Q-Flash menu when the BIOS updating procedure is completed.

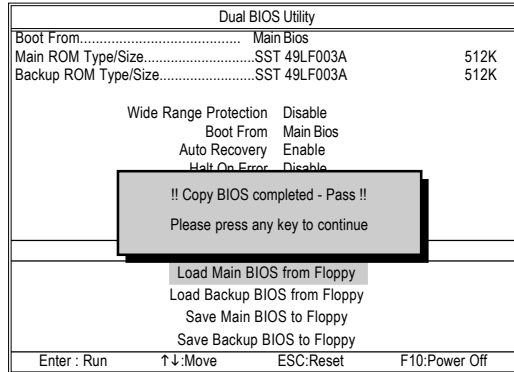

You can repeat Step 1 to 4 to flash the backup BIOS, too.

5. Press **Esc** and then **Y** button to exit the Q-Flash utility. The computer will restart automatically after you exit Q-Flash.

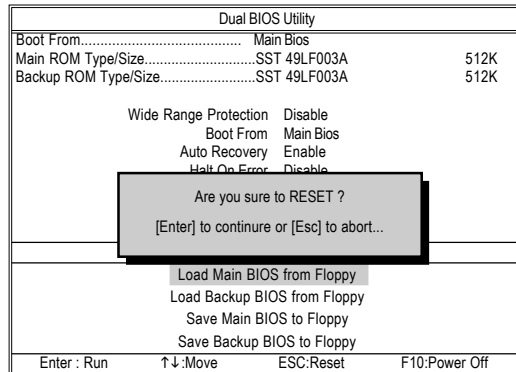

After system reboots, you may find the BIOS version on your boot screen becomes the one you flashed.

The BIOS file becomes Fab after updating

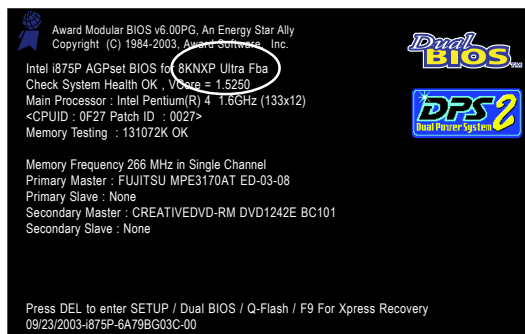

6. Press **Del** to enter BIOS menu after system reboots. When you are in BIOS menu, move to **Load Fail-Safe Defaults** item and press **Enter** to load BIOS Fail-Safe Defaults. Normally the system redetects all devices after BIOS has been upgraded. Therefore, we highly recommend reloading the BIOS defaults after BIOS has been upgraded.

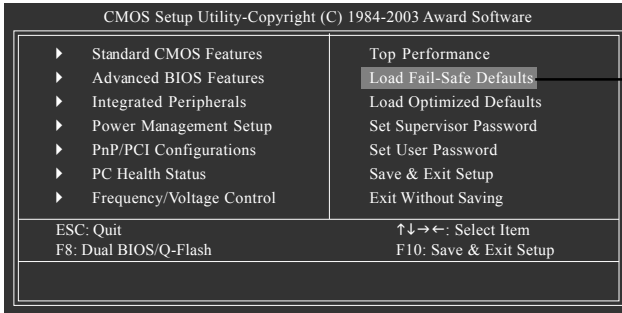

Press **Enter** on your keyboard

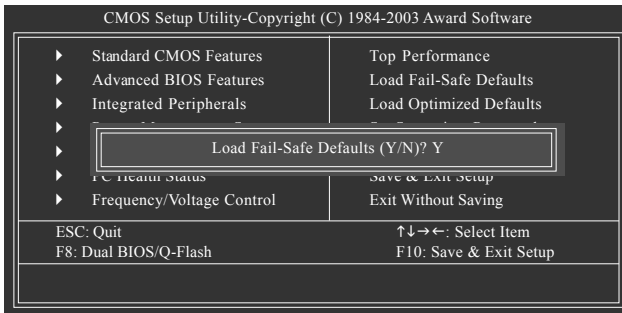

Press **Y** on your keyboard to load defaults.

7. Select **Save & Exit Setup** item to save the settings to CMOS and exit the BIOS menu. System will reboot after you exit the BIOS menu. The procedure is completed.

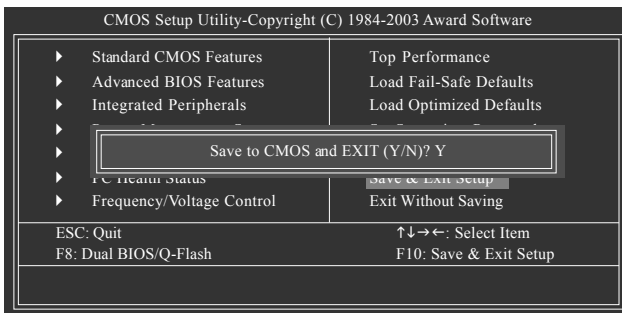

Press **Y** on your keyboard to save and exit.

Part Two:

Updating BIOS with Q-Flash™ Utility on Single-BIOS Motherboards.

This part guides users of single-BIOS motherboards how to update BIOS using the Q-Flash™ utility.

Entering the Q-Flash™ utility:

Step1: To use the Q-Flash utility, you must press **Del** in the boot screen to enter BIOS menu.

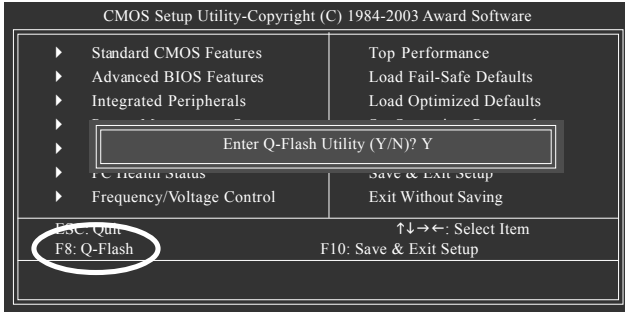

Step 2: Press **F8** button on your keyboard and then **Y** button to enter the Q-Flash utility.

Exploring the Q-Flash™ utility screen

The Q-FlashBIOS utility screen consists of the following key components.

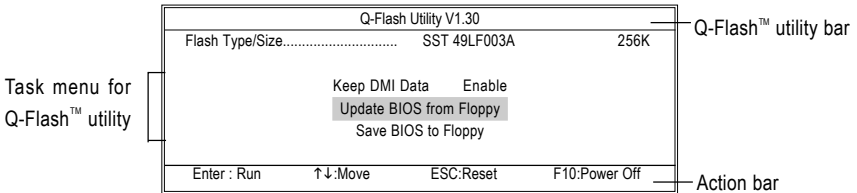

Task menu for Q-Flash utility:

Contains the names of three tasks. Blocking a task and pressing **Enter** key on your keyboard to enable execution of the task.

Action bar:

Contains the names of four actions needed to operate the Q-Flash utility. Pressing the buttons mentioned on your keyboards to perform these actions.

Using the Q-Flash™ utility:

This section tells you how to update BIOS using the Q-Flash utility. As described in the "Before you begin" section above, you must prepare a floppy disk having the BIOS file for your motherboard and insert it to your computer. If you have already put the floppy disk into your system and have entered the Q-Flash utility, please follow the steps below to flash BIOS.

Steps:

1. Press arrow buttons on your keyboard to move the light bar to "Update BIOS from Floppy" item in the Q-Flash menu and press Enter button.

Later, you will see a box pop up showing the BIOS files you previously downloaded to the floppy disk.

 If you want to save the current BIOS for backup purpose, you can begin Step 1 with "Save BIOS to Floppy" item.

2. Move to the BIOS file you want to flash and press **Enter**.

In this example, we only download one BIOS file to the floppy disk so only one BIOS file, 8GE800.F4, is listed.



Please confirm again you have the correct BIOS file for your motherboard.

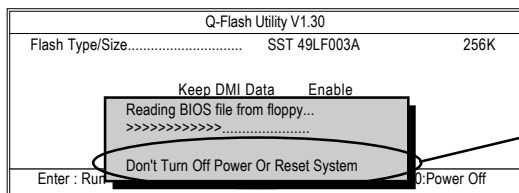
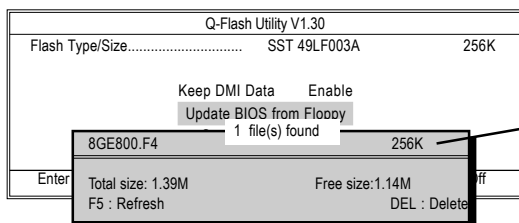

After BIOS file is read, you'll see a confirmation dialog box asking you "Are you sure to update BIOS?"



Please do not take out the floppy disk when it begins flashing BIOS.

Method 2: @ BIOS Utility

If you don't have DOS boot disk, we recommend that you used Gigabyte @BIOS™ program to flash BIOS.

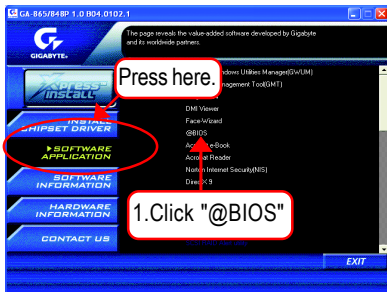

(1)

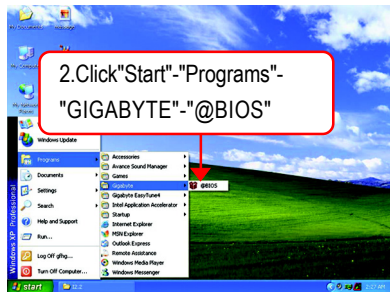

(2)

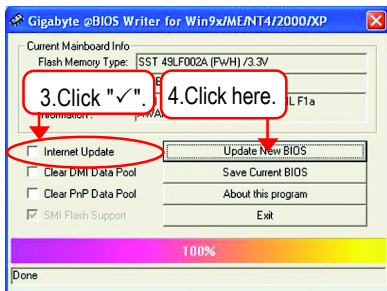

(3)

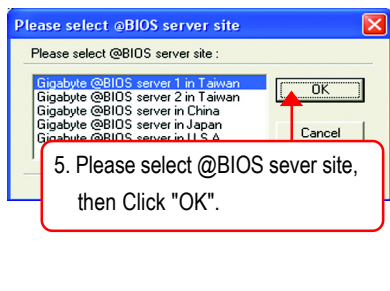

(4)

Methods and steps:

- I. Update BIOS through Internet
 - a. Click "Internet Update" icon
 - b. Click "Update New BIOS" icon
 - c. Select @BIOS™ sever
 - d. Select the exact model name on your motherboard
 - e. System will automatically download and update the BIOS.

II. Update BIOS NOT through Internet:

- a. Do not click "Internet Update" icon
- b. Click "Update New BIOS"
- c. Please select "All Files" in dialog box while opening the old file.
- d. Please search for BIOS unzip file, downloading from internet or any other methods (such as: 8IPE775 Pro.D4).
- e. Complete update process following the instruction.

III. Save BIOS

In the very beginning, there is "Save Current BIOS" icon shown in dialog box. It means to save the current BIOS version.

IV. Check out supported motherboard and Flash ROM:

In the very beginning, there is "About this program" icon shown in dialog box. It can help you check out which kind of motherboard and which brand of Flash ROM are supported.

Note:

- a. In method I, if it shows two or more motherboard's model names to be selected, please make sure your motherboard's model name again. Selecting wrong model name will cause the system unbooted.
- b. In method II, be sure that motherboard's model name in BIOS unzip file are the same as your motherboard's. Otherwise, your system won't boot.
- c. In method I, if the BIOS file you need cannot be found in @BIOS™ server, please go onto Gigabyte's web site for downloading and updating it according to method II.
- d. Please note that any interruption during updating will cause system unbooted



2- / 4- / 6- / 8- Channel Audio Function Introduction

The installation of windows 98SE/2K/ME/XP is very simple. Please follow next step to install the function!

Stereo Speakers Connection and Settings:

We recommend that you use the speaker with amplifier to acquire the best sound effect if the stereo output is applied.

STEP 1:

Connect the stereo speakers or earphone to "Line Out".



Line Out

STEP 2 :

Following installation of the audio driver, you find a Sound Effect icon on the lower right hand taskbar. Click the icon to select the function.

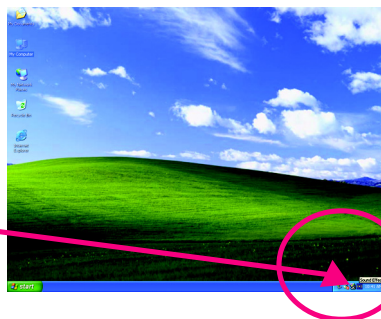

STEP 3:

Click "Speaker Configuration" then click on the left selection bar and select "2CH Speaker" to complete 2 channel audio configuration.

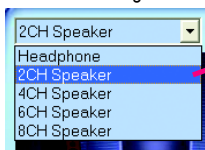

4 Channel Analog Audio Output Mode

STEP 1 :

Connect the front channels to "Line Out",
the rear channels to "Line In".

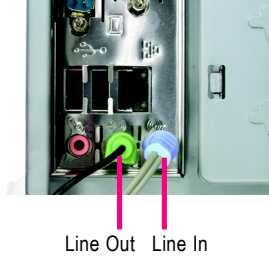

Line Out Line In

STEP 2 :

Following installation of the audio driver, you find a
icon a Sound Effect  icon on the lower right hand
taskbar. Click the icon to select the function.



STEP 3 :

Click "Speaker Configuration" and select the "UAJ
Function". Then click on the left selection bar and
select "4CH Speaker" to complete 4 channel audio
configuration.

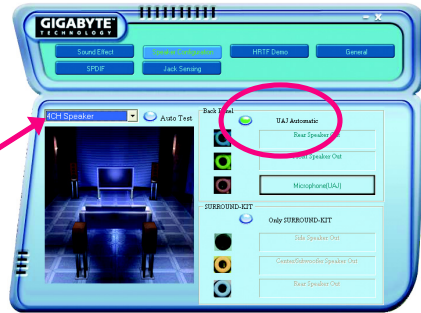
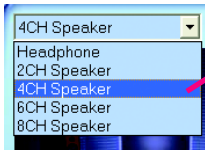

Basic 6 Channel Analog Audio Output Mode

Use the back audio panel to connect the audio output without any additional module.

STEP 1 :

Connect the front channels to "Line Out", the rear channels to "Line In", and the Center/Subwoofer channels to "MIC In".

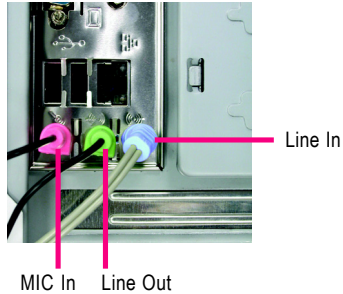

STEP 2 :

Following installation of the audio driver, you find a icon a Sound Effect  icon on the lower right hand taskbar. Click the icon to select the function.

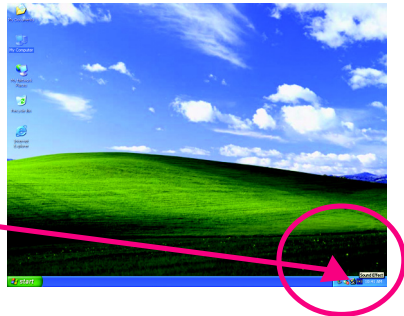

STEP 3 :

Click "Speaker Configuration" and select the "UAJ Function". Then click on the left selection bar and select "6CH Speaker" to complete 6 channel audio configuration.

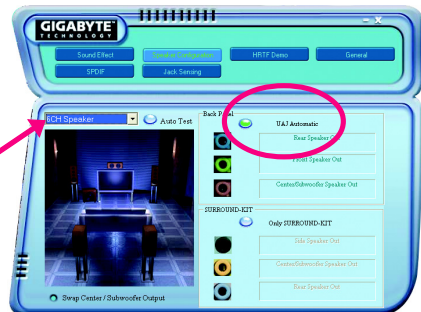

8 Channel Audio Setup (using Audio Combo Kit, Optional Device):

(Audio Combo Kit offers SPDIF output, an optical and coaxial cable and a Surround-Kit. The Surround-Kit offers R/L surround, center/subwoofer output and rear surround)

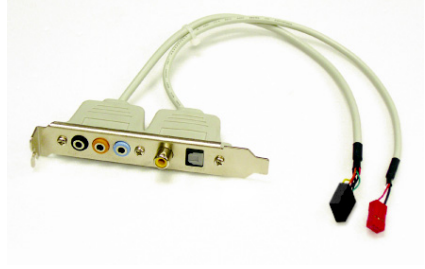

STEP 1 :

Secure the Audio Combo Kit at the panel on the back of the case.

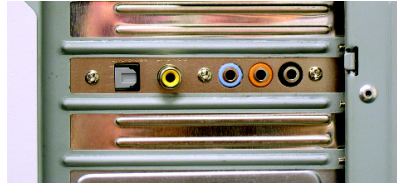

STEP 2 :

Connect the Surround-Kit to the SUR_CEN connector located on the motherboard.

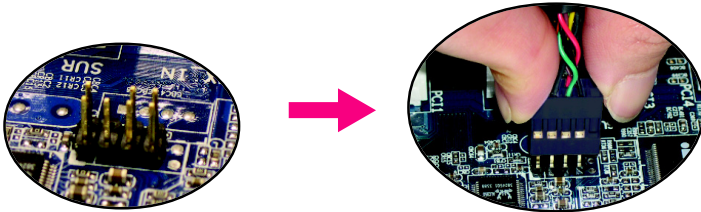

STEP 3 :

There are two methods of 8 channel audio configuration:

Method 1:

Connect the front channels to the "LINE OUT" port located on the audio panel and the rear channels to the Surround-Kit "REAR R/L" port. Connect the center/subwoofer channels to the Surround-Kit "SUB CENTER" and the R/L channels to the Surround-Kit "SUR BACK" port.

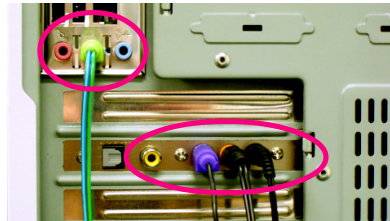

Method 2:

Connect the front channels to the "LINE OUT" port located on the audio panel and the rear channels to the "LINE IN" port. Connect the center/subwoofer channels to the "MIC IN" port located on the audio panel and the R/L channels to the Surround-Kit "SUR BACK" port. (This method requires UAJ function)

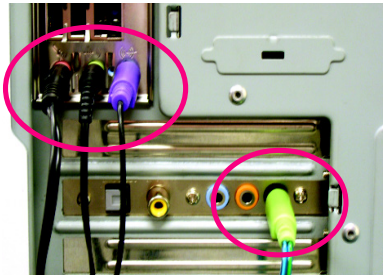

STEP 4 :

Following installation of the audio driver, you find a icon a Sound Effect  icon on the lower right hand taskbar. Click the icon to select the function.



STEP 5 :

Click "Speaker Configuration" and select both the "UAJ Function" and "Only Surround-Kit". Then click on the left selection bar and select "8CH Speaker" to complete 8 channel audio configuration.

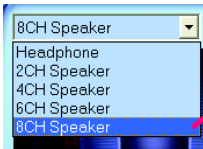

Sound Effect Configuration:

At the sound effect menu, users can adjust sound option settings as desired.



SPDIF Output Device (Optional Device)

A "SPDIF output" device is available on the motherboard. Cable with rear bracket is provided and could link to the "SPDIF output" connector (As picture.) For the further linkage to decoder, rear bracket provides coaxial cable and Fiber connecting port.

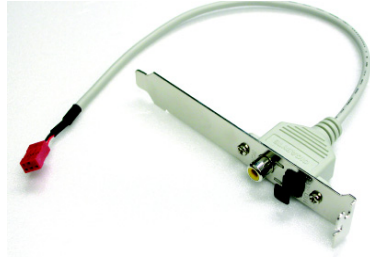

1. Connect the SPDIF output device to the rear bracket of PC, and fix it with screw.

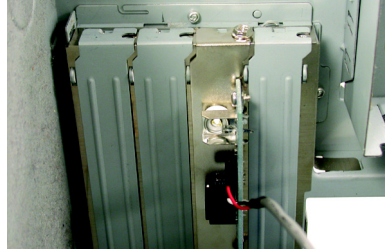

2. Connect SPDIF device to the motherboard.

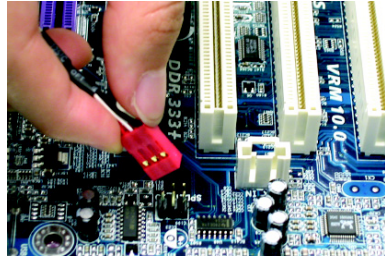

3. Connect SPDIF to the SPDIF decoder.

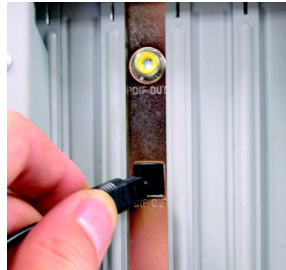

Jack-Sensing and UAJ Introduction

Jack-Sensing provides audio connectors error-detection function.



Install Microsoft DirectX8.1 or later version before to enable Jack-Sensing support for Windows 98/98SE/2000/ME.

Jack-Sensing includes 2 parts: AUTO and MANUAL. Following is an example for 2 channels (Windows XP):

Introduction of audio connectors

You may connect CDROM, Walkman or others audio input devices to Line In jack, speakers, ear-phone or others output devices to Line Out jack, and microphone to MIC In jack.

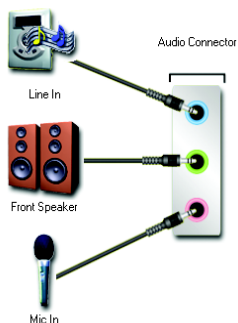

Auto-detecting:

Please connect the devices to the right jacks as above. A window will appear as right picture if you setup the devices properly.

Please note that 3D audio function will only appear when 3D audio inputs.

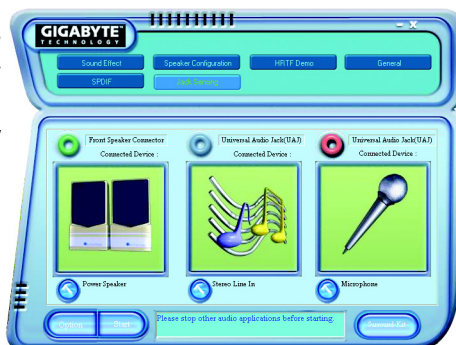

If you set wrong with the connectors, the warning message will come out as right picture.

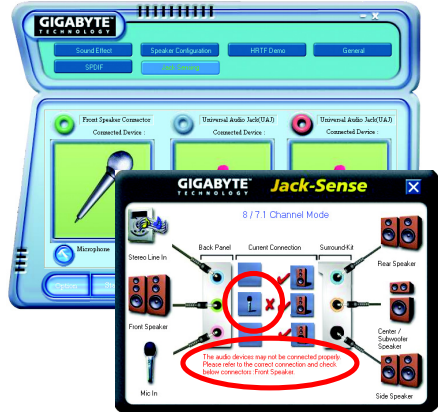

Manual setting:

If the device picture shows different from what you set, please press "Manual Selection" to set.

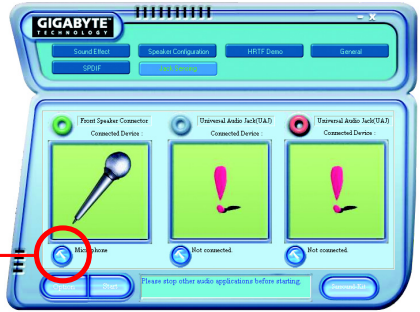
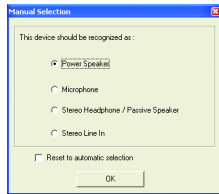

UAJ Introduction

UAJ (Universal Audio Jack) has a very smart feature: It will switch signal automatically when user plugs his audio device to the wrong jack (Line-in/ Line-out). That means users do not need to worry the audio device should be plug in Line-in or Line-out jack, the device will work perfectly after UAJ is activated.

Enable UAJ function:

You can click "UAJ Automatic" button to enable UAJ function.

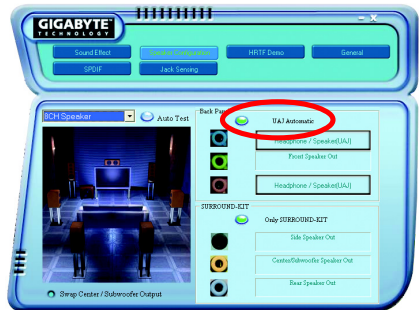

Xpress Recovery2 Introduction



Xpress Recovery2 is designed to provide quick backup and restoration of hard disk data. Supporting Microsoft operating systems including Windows XP/2000/NT/98/Me and DOS, and file systems including FAT16, FAT32, and NTFS, Xpress Recovery2 is able to back up data on hard disks on PATA and SATA IDE controllers. After Xpress Recovery2 is executed from CD-ROM for the first time, it will stay permanent in your hard disk. If you wish to run Xpress Recovery2 later, you can simply press F9 during system bootup to enter Xpress Recovery2 without the CD-ROM.

System requirements:

1. Intel x86 platforms
2. At least 64M bytes of system memory
3. VESA-supported VGA cards

How to use the Xpress Recovery2

Initial access by booting from CD-ROM and subsequent access by pressing the F9 key:

Steps: After entering BIOS Setup, go to **Advanced BIOS Feature** and set to boot from CD-ROM. Save the settings and exit the BIOS Setup. Insert the provided driver CD into your CD-ROM drive. Upon system restart, the message which says "Boot from CD/DVD:" will appear in the bottom left corner of the screen. Press any key to enter Xpress Recovery2.

After the steps above are completed, subsequent access to Xpress Recovery2 can be made by simply pressing the <F9> key during system power-on.



Boot from CD/DVD:

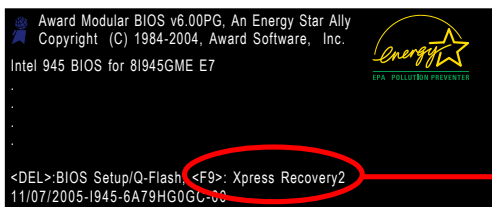

<F9> Xpress Recovery2



1. If you have already entered Xpress Recovery2 by booting from the CD-ROM, you can enter Xpress Recovery2 by pressing the <F9> key in the future.
2. System storage capacity and the reading/writing speed of the hard disk will affect the data backup speed.
3. It is recommended that Xpress Recovery2 be immediately installed once you complete installations of OS and all required drivers as well as software.

The Main Screen of Xpress Recovery2



1. RESTORE:

Restore the backed-up data to your hard disk.
(This button will not appear if there is no backup file.)

2. BACKUP:

Back up data from hard disk.

3. REMOVE:

Remove previously-created backup files to release disk space.
(This button will not appear if there is no backup file.)

4. REBOOT:

Exit the main screen and restart the system.

Limitations:

1. Not compatible to Xpress Recovery.
2. For the use of Xpress Recovery2, a primary partition must be reserved.
3. Xpress Recovery2 will store the backup file at the end of the hard disk, so free space available on the hard disk for the backup file must be allocated in advance. (A minimum 4GB is recommended but the actual space is dependent on the size of the data to be backed up)
4. Capable of backing up hard disks installed with Windows operating systems including DOS and Windows XP/2000/NT/9x/Me.
5. USB hard disks are currently not supported.
6. Does not support RAID/AHCI (class code 0104/0106) hard disks.
7. Capable of backing up and restoring only the first physical hard disk.

Hard disks detection sequence is as follows:

- a. PATA IDE primary channel
- b. PATA IDE secondary channel
- c. SATA IDE channel 1
- d. SATA IDE channel 2
- e. SATA IDE channel 3
- f. SATA IDE channel 4

Precautions:

1. When using hard disks with more than 128G under Windows 2000, be sure to execute the EnableBigLba.exe program from the driver CD before data backup.
2. It is normal that data backup takes longer time than data restoration.
3. Xpress Recovery2 is compliant with the GPL regulations.
4. On a few motherboards based on Nvidia chipsets, BIOS update is required for Xpress Recovery2 to correctly identify RAID and SATA IDE mode. Please contact your motherboard manufacturer.
5. Xpress Recovery2 supports only PATA hard disks and not SATA hard disks on the following motherboards (As this is a BIOS-related issue, it can be solved by BIOS update)

GA-K8U	GA-K8NXP-9	GA-8N-SLI Royal
GA-K8U-9	GA-K8N Ultra-9	GA-8N-SLI Pro
GA-K8NXP-SLI	GA-K8NF-9 (PCB Ver. 1.0)	GA-8N-SLI
GA-K8N Ultra-SLI	GA-K8NE (PCB Ver. 1.0)	
GA-K8N Pro-SLI	GA-K8NMF-9	

Chapter 5 Appendix

Install Drivers



NOTE

Pictures below are shown in Windows XP

Insert the driver CD-title that came with your motherboard into your CD-ROM drive, the driver CD-title will auto start and show the installation guide. If not, please double click the CD-ROM device icon in "My computer", and execute the setup.exe.

INSTALL CHIPSET DRIVER

This page shows the drivers that need to be installed for the system. Click each item to install the driver manually or switch to the  to install the drivers automatically.

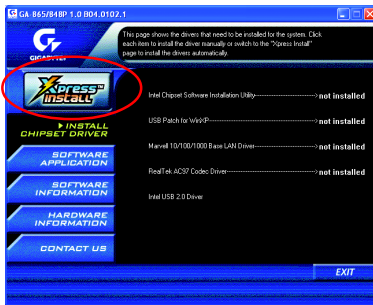

Message: Some device drivers will restart your system automatically. After restarting your system the "Xpress Install" will continue to install other drivers.

The "Xpress Install" uses the "Click and Go" technology to install the drivers automatically. Just select the drivers you want then click the "GO" button. The  will execute the installation for you by itself.

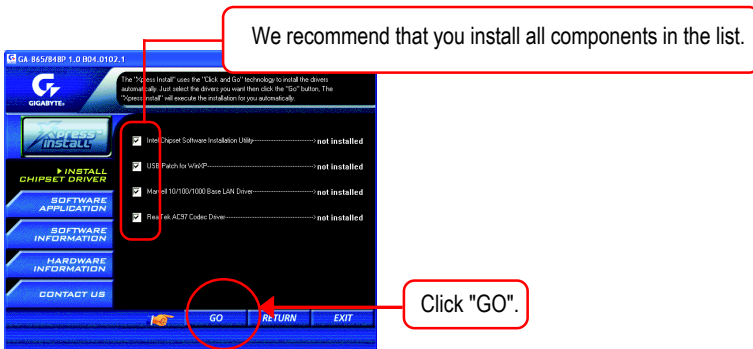

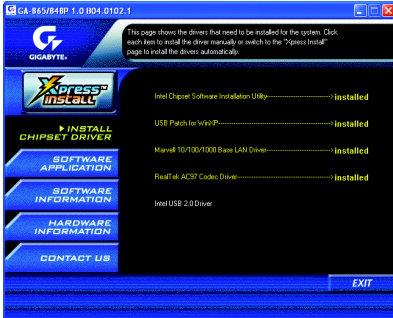

Driver install finished!! you have to reboot system!!

Item Description

- Intel Chipset Software Installation Utility
Tell the operating system how the chipset components will be configured.
- USB Patch for WinXP
This patch driver can help you to resolve the USB device wake up S3 hang up issue in XP.
- Marvell 10/100/1000 Base LAN Driver ① ②
For Marvell 10/100/1000 LAN chip use.
- RealTek AC97 Codec Driver
For Intel(R) ICH/ICH2/ICH4/ICH5 AC97 audio.
- Intel USB 2.0 Driver
It is recommended that you use the Microsoft Windows update for the most updated driver.



For USB2.0 driver support under Windows XP operating system, please use Windows Service Pack. After install Windows Service Pack, it will show a question mark "?" in "Universal Serial Bus controller" under "Device Manager". Please remove the question mark and restart the system (System will auto-detect the right USB2.0 driver).

① Only for GA-8IPE775 Pro.

② Only for GA-8IPE775-G.

SOFTWARE APPLICATION

This page reveals the value-added software developed by Gigabyte and its worldwide partners.

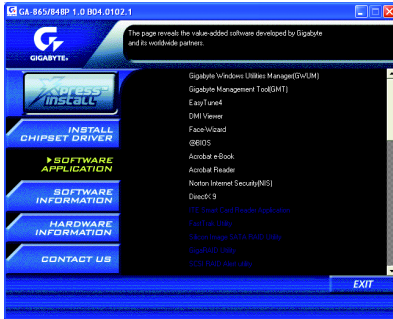

- Gigabyte Windows Utilities Manager(GWUM)
This utility can integrate the Gigabyte's applications in the system tray.
- Gigabyte Management Tool(GMT)
A useful tool which can manage the computer via the network.
- EasyTune4
Powerful utility that integrates the overclocking and hardware monitoring functions.
- DMI Viewer
Windows based utility which is used to browse the DMI/SMBIOS information of the system.
- Face-Wizard
New utility for adding BIOS logo.
- @BIOS
Gigabyte windows flash BIOS utility.
- Acrobat e-Book
Useful utility from Adobe.
- Acrobat Reader
Popular utility from Adobe for reading .PDF file format documents.
- Norton Internet Security(NIS)
Integrated utility which includes anti-virus, ad control, etc
- DirectX 9
Install Microsoft DirectX 9 to enable 3D hardware acceleration that support for operating system to achieve better 3D performance.
- Marvell VCT Utility ① ②
Utility for Marvell chips. [VCT(Virtual Cable Tester) Technology for Gigabit Networks]

① Only for GA-8IPE775 Pro.

② Only for GA-8IPE775-G.

SOFTWARE INFORMATION

This page list the contents of softwares and drivers in this CD title.

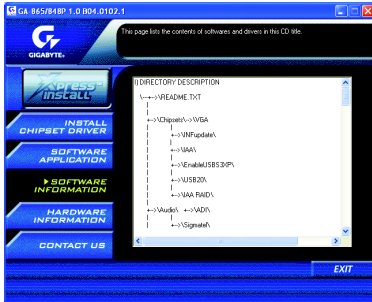

HARDWARE INFORMATION

This page lists all device you have for this motherboard.

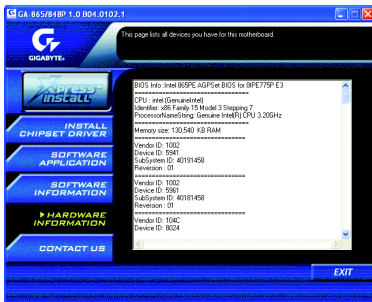

CONTACT US

Please see the last page for details.



FAQ

Below is a collection of general asked questions. To check general asked questions based on a specific motherboard model, please log on to <http://tw.giga-byte.com/faq/faq.htm>

Question 1: I cannot see some options that were included in previous BIOS after updating BIOS. Why?

Answer: Some advanced options are hidden in new BIOS version. Please press Ctrl and F1 keys after entering BIOS menu and you will be able to see these options.

Questions 2: Why is the light of my keyboard/optical mouse still on after computer shuts down?

Answer: In some boards, a small amount of electricity is kept on standby after computer shuts down and that's why the light is still on.

Question 3: How do I clear CMOS?

Answer: If your board has a Clear CMOS jumper, please refer to the Clear CMOS steps in the manual. If your board doesn't have such jumper, you can take off the on-board battery to leak voltage to clear CMOS. Please refer to the steps below:

Steps:

1. Turn off power.
2. Disconnect the power cord from MB.
3. Take out the battery gently and put it aside for about 10 minutes (Or you can use a metal object to connect the positive and negative pins in the battery holder to makethem short for one minute).
4. Re-insert the battery to the battery holder.
5. Connect power cord to MB again and turn on power.
6. Press Del to enter BIOS and load Fail-Safe Defaults.
7. Save changes and reboot the system.

Question 4: Why does system seem unstable after updating BIOS?

Answer: Please remember to load Fail-Safe Defaults (Or Load BIOS Defaults) after flashing BIOS. However, if the system instability still remains, please clear CMOS to solve the problem.

Question 5: Why do I still get a weak sound after turning up the speaker to the maximum volume?

Answer: Please make sure the speaker you are using is equipped with an internal amplifier. If not, please change another speaker with power/amplifier and try again later.

Question 6: How do I disable onboard VGA card in order to add an external VGA card?

Answer: Gigabyte motherboards will auto-detect the external VGA card after it is plugged in, so you don't need to change any setting manually to disable the onboard VGA.

Question 7: Why cannot I use the IDE 2?

Answer: Please refer to the user manual and check whether you have connected any cable that is not provided with the motherboard package to the USB Over Current pin in the Front USB Panel. If the cable is your own cable, please remove it from this pin and do not connect any of your own cables to it.

Question 8: Sometimes I hear different continuous beeps from computer after system boots up. What do these beeps usually stand for?

Answer: The beep codes below may help you identify the possible computer problems. However, they are only for reference purposes. The situations might differ from case to case.

→ AMI BIOS Beep Codes

*Computer gives 1 short beep when system boots successfully.

*Except for beep code 8, these codes are always fatal.

- 1 beep Refresh failure
- 2 beeps Parity error
- 3 beeps Base 64K memory failure
- 4 beeps Timer not operational
- 5 beeps Processor error
- 6 beeps 8042 - gate A20 failure
- 7 beeps Processor exception interrupt error
- 8 beeps Display memory read/write failure
- 9 beeps ROM checksum error
- 10 beeps CMOS shutdown register read/write error
- 11 beeps Cache memory bad

→ AWARD BIOS Beep Codes

- 1 short: System boots successfully
- 2 short: CMOS setting error
- 1 long 1 short: DRAM or M/B error
- 1 long 2 short: Monitor or display card error
- 1 long 3 short: Keyboard error
- 1 long 9 short: BIOS ROM error
- Continuous long beeps: DRAM error
- Continuous short beeps: Power error

Troubleshooting



If you encounter any trouble during boot up, please follow the troubleshooting procedures .

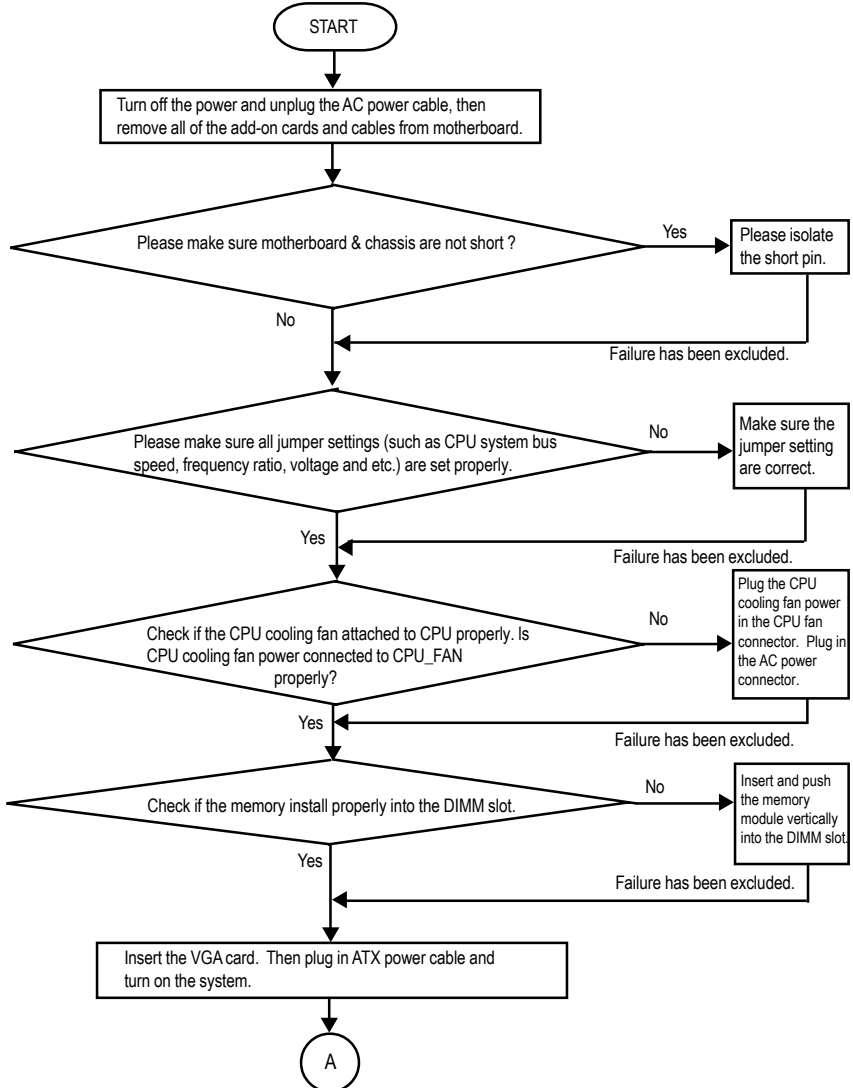

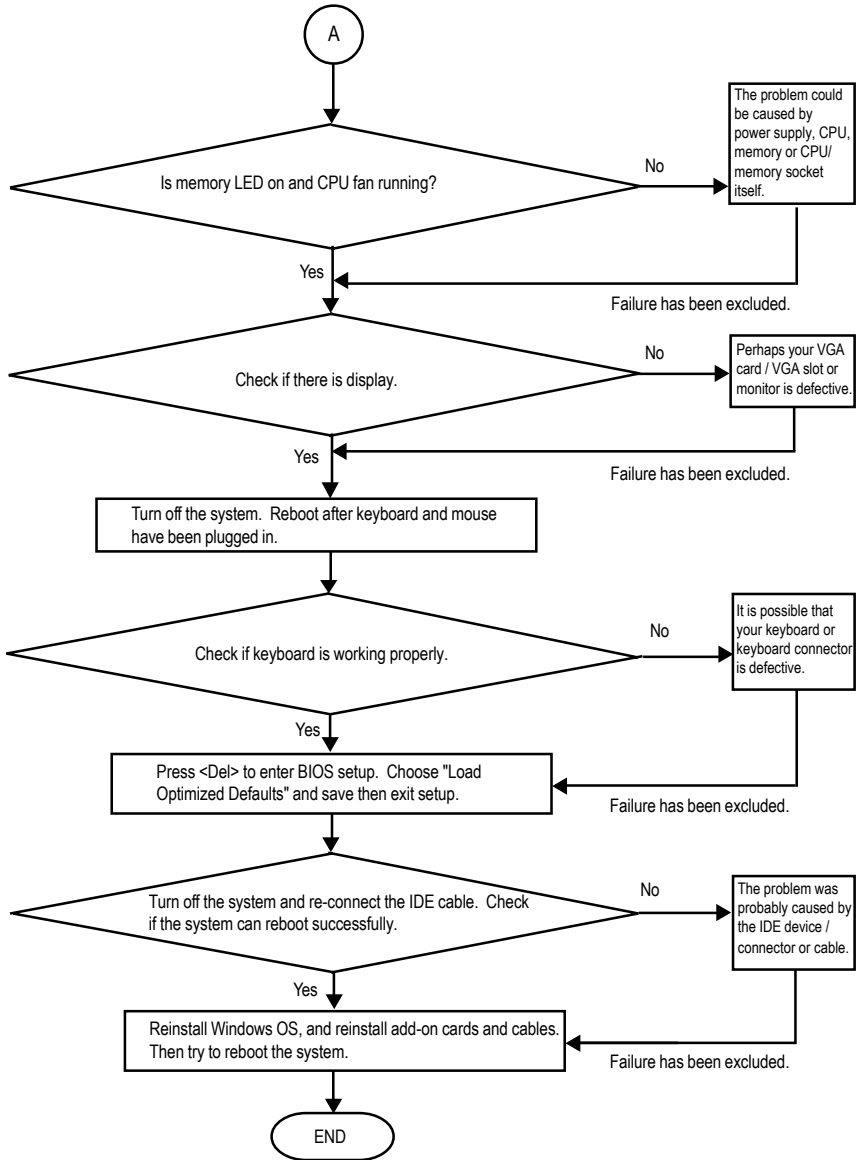

If the above procedure unable to solve your problem, please contact with your local retailer or national distributor for help. Or, you could submit your question to the service mail via Gigabyte website technical support zone (<http://www.gigabyte.com.tw>). The appropriate response will be provided ASAP.

Technical Support/RMA Sheet



Customer/Country:	Company:	Phone No.:
Contact Person:	E-mail Add. :	

Model name/Lot Number:	PCB revision:
BIOS version:	O.S./A.S.:

Hardware Configuration	Mfs.	Model name	Size:	Driver/Utility:
CPU				
Memory				
Brand				
Video Card				
Audio Card				
HDD				
CD-ROM / DVD-ROM				
Modem				
Network				
AMR / CNR				
Keyboard				
Mouse				
Power supply				
Other Device				

Problem Description:



Acronyms

Acronyms	Meaning
ACPI	Advanced Configuration and Power Interface
APM	Advanced Power Management
AGP	Accelerated Graphics Port
AMR	Audio Modem Riser
ACR	Advanced Communications Riser
BIOS	Basic Input / Output System
CPU	Central Processing Unit
CMOS	Complementary Metal Oxide Semiconductor
CRIMM	Continuity RIMM
CNR	Communication and Networking Riser
DMA	Direct Memory Access
DMI	Desktop Management Interface
DIMM	Dual Inline Memory Module
DRM	Dual Retention Mechanism
DRAM	Dynamic Random Access Memory
DDR	Double Data Rate
ECP	Extended Capabilities Port
ESCD	Extended System Configuration Data
ECC	Error Checking and Correcting
EMC	Electromagnetic Compatibility
EPP	Enhanced Parallel Port
ESD	Electrostatic Discharge
FDD	Floppy Disk Device
FSB	Front Side Bus
HDD	Hard Disk Device
IDE	Integrated Dual Channel Enhanced
IRQ	Interrupt Request

to be continued.....

Acronyms	Meaning
IOAPIC	Input Output Advanced Programmable Input Controller
ISA	Industry Standard Architecture
LAN	Local Area Network
I/O	Input / Output
LBA	Logical Block Addressing
LED	Light Emitting Diode
MHz	Megahertz
MIDI	Musical Instrument Digital Interface
MTH	Memory Translator Hub
MPT	Memory Protocol Translator
NIC	Network Interface Card
OS	Operating System
OEM	Original Equipment Manufacturer
PAC	PCI A.G.P. Controller
POST	Power-On Self Test
PCI	Peripheral Component Interconnect
RIMM	Rambus in-line Memory Module
SCI	Special Circumstance Instructions
SECC	Single Edge Contact Cartridge
SRAM	Static Random Access Memory



Contact Us

- **Taiwan (Headquarters)**

GIGA-BYTE TECHNOLOGY CO., LTD.

Address: No.6, Bau Chiang Road, Hsin-Tien, Taipei 231, Taiwan

TEL: +886-2-8912-4888

FAX: +886-2-8912-4003

Tech. Support :

<http://tw.giga-byte.com/TechSupport/ServiceCenter.htm>

Non-Tech. Support(Sales/Marketing) :

<http://ggts.gigabyte.com.tw/nontech.asp>

WEB address (English): <http://www.gigabyte.com.tw>

WEB address (Chinese): <http://chinese.giga-byte.com>

- **U.S.A.**

G.B.T. INC.

TEL: +1-626-854-9338

FAX: +1-626-854-9339

Tech. Support :

<http://tw.giga-byte.com/TechSupport/ServiceCenter.htm>

Non-Tech. Support(Sales/Marketing) :

<http://ggts.gigabyte.com.tw/nontech.asp>

WEB address : <http://www.giga-byte.com>

- **Germany**

G.B.T. TECHNOLOGY TRADING GMBH

Tech. Support :

<http://tw.giga-byte.com/TechSupport/ServiceCenter.htm>

Non-Tech. Support(Sales/Marketing) :

<http://ggts.gigabyte.com.tw/nontech.asp>

WEB address : <http://www.gigabyte.de>

- **Japan**

NIPPON GIGA-BYTE CORPORATION

WEB address : <http://www.gigabyte.co.jp>

- **Singapore**

GIGA-BYTE SINGAPORE PTE. LTD.

Tech. Support :

<http://tw.giga-byte.com/TechSupport/ServiceCenter.htm>

Non-Tech. Support(Sales/Marketing) :

<http://ggts.gigabyte.com.tw/nontech.asp>

WEB address: <http://www.gigabyte.com.sg>

- **U.K.**

G.B.T. TECH. CO., LTD.

Tech. Support :

<http://tw.giga-byte.com/TechSupport/ServiceCenter.htm>

Non-Tech. Support(Sales/Marketing) :

<http://ggts.gigabyte.com.tw/nontech.asp>

WEB address : <http://uk.giga-byte.com>

- **The Netherlands**

GIGA-BYTE TECHNOLOGY B.V.

Tech. Support :

<http://tw.giga-byte.com/TechSupport/ServiceCenter.htm>

Non-Tech. Support(Sales/Marketing) :

<http://ggts.gigabyte.com.tw/nontech.asp>

WEB address : <http://www.giga-byte.nl>

- **China**

NINGBO G.B.T. TECH. TRADING CO., LTD.

Tech. Support :

<http://tw.giga-byte.com/TechSupport/ServiceCenter.htm>

Non-Tech. Support(Sales/Marketing) :

<http://ggts.gigabyte.com.tw/nontech.asp>

WEB address : <http://www.gigabyte.com.cn>

Shanghai

TEL: +86-021-63410999

FAX: +86-021-63410100

Beijing

TEL: +86-10-62102838

FAX: +86-10-62102848

Wuhan

TEL: +86-27-87851061

FAX: +86-27-87851330

GuangZhou

TEL: +86-20-87586074

FAX: +86-20-85517843

Chengdu

TEL: +86-28-85236930

FAX: +86-28-85256822

Xian

TEL: +86-29-85531943

FAX: +86-29-85539821

Shenyang

TEL: +86-24-23960918

FAX: +86-24-23960918-809

- **Australia**

GIGABYTE TECHNOLOGY PTY. LTD.

Tech. Support :

<http://tw.giga-byte.com/TechSupport/ServiceCenter.htm>

Non-Tech. Support(Sales/Marketing) :

<http://ggts.gigabyte.com.tw/nontech.asp>

WEB address : <http://www.giga-byte.com.au>

- **France**

GIGABYTE TECHNOLOGY FRANCE S.A.R.L.

Tech. Support :

<http://tw.giga-byte.com/TechSupport/ServiceCenter.htm>

Non-Tech. Support(Sales/Marketing) :

<http://ggts.gigabyte.com.tw/nontech.asp>

WEB address : <http://www.gigabyte.fr>

- **Russia**

Moscow Representative Office Of GIGA-BYTE Technology Co., Ltd.

Tech. Support :

<http://tw.giga-byte.com/TechSupport/ServiceCenter.htm>

Non-Tech. Support(Sales/Marketing) :

<http://ggts.gigabyte.com.tw/nontech.asp>

WEB address : <http://www.gigabyte.ru>

- **Poland**

Office of GIGA-BYTE TECHNOLOGY Co., Ltd. in POLAND

Tech. Support :

<http://tw.giga-byte.com/TechSupport/ServiceCenter.htm>

Non-Tech. Support(Sales/Marketing) :

<http://ggts.gigabyte.com.tw/nontech.asp>

WEB address : <http://www.gigabyte.pl>

- **Serbia & Montenegro**

Representative Office Of GIGA-BYTE Technology Co., Ltd. in SERBIA & MONTENEGRO

Tech. Support :

<http://tw.giga-byte.com/TechSupport/ServiceCenter.htm>

Non-Tech. Support(Sales/Marketing) :

<http://ggts.gigabyte.com.tw/nontech.asp>

WEB address: <http://www.gigabyte.co.yu>

- **Czech Republic**

Representative Office Of GIGA-BYTE Technology Co., Ltd. in CZECH REPUBLIC

Tech. Support :

<http://tw.giga-byte.com/TechSupport/ServiceCenter.htm>

Non-Tech. Support(Sales/Marketing) :

<http://ggts.gigabyte.com.tw/nontech.asp>

WEB address: <http://www.gigabyte.cz>

- **Romania**

Representative Office Of GIGA-BYTE Technology Co., Ltd. in Romania

Tech. Support :

<http://tw.giga-byte.com/TechSupport/ServiceCenter.htm>

Non-Tech. Support(Sales/Marketing) :

<http://ggts.gigabyte.com.tw/nontech.asp>

WEB address: <http://www.gigabyte.com.ro>
