

GA-8I865GM-775 / GA-8I865GMF-775

Intel® Pentium® 4 LGA775 Processor Motherboard

User's Manual

Rev. 1001

12ME-8I865GMT-1001

Declaration of Conformity

(full address)

G.B.T. Technology Trading GmbH
Ausschleisslager Weg 4 42333 Solingen, Germany

(description of the apparatus, system, installation to which it refers)

GA-81865GM-775 /GA-81865GM-F775

Motherboard

(reference to the specification under which conformity is declared)
is in conformity with
in accordance with 90/269 EEC-EMC Directive

EN 55011 Limits and methods of measurement of radio disturbance characteristics of industrial, scientific and medical (ISM) high frequency equipment

EN 61000-3-2
 EN 61000-3-3

Disturbances in supply systems caused by household appliances and similar electrical equipment "Voltage fluctuations"

EN 55013 Limits and methods of measurement of radio disturbance characteristics of equipment

EN 55024

Information Technology equipment/Immunity measurement

EN 55014-1 Limits and methods of measurement of radio disturbance characteristics of household electrical appliances, portable tools and similar electrical apparatus

EN 50082-1
 EN 50082-2

Generic immunity standard Part 1: Residential, commercial and light industry
Industrial environment

EN 55015 Limits and methods of measurement of radio disturbance characteristics of fluorescent lamps and luminaires

EN 55014-2

Immunity requirements for household appliances tools and similar apparatus

EN 55020 Immunity from radio interference of equipment

EN 50091-2

EMC requirements for uninterruptible power systems (UPS)

EN 55022

Limits and methods of measurement of radio disturbance characteristics of information technology equipment

DIN VDE 0885 Cabinet distribution systems; Equipment for use in buildings
 Part 10
 Part 12
sound and television signals

CE marking



(EC conformity marking)

The manufacturer also declares the conformity of above mentioned product with the safety requirements in accordance with LVD 702/95 EEC

EN 60065

Safety requirements for mains operated household and similar general use electrical appliances

EN 60950

Safety for information technology equipment including electrical business equipment

EN 60335

Safety of household and similar electrical appliances

EN 50091-1

General and Safety requirements for uninterruptible power systems (UPS)

Manufacturer/Importer

Signature: Jimmy Huang

(Stamp)

Date: Sep. 5, 2004

Name: Timmy Huang

DECLARATION OF CONFORMITY

Per FCC Part 2 Section 2.1077(a)



Responsible Party Name: G.B.T. INC. (U.S.A.)

Address: 17358 Railroad Street

City of Industry, CA 91748

Phone/Fax No: (818) 854-9338 / (818) 854-9339

hereby declares that the product

Product Name: **Motherboard**

Model Number: GA-81865GM-775 / GA-81865GMF-775

Conforms to the following specifications:

FCC Part 15, Subpart B, Section 15.107(a) and Section 15.109

(a) Class B Digital Device

Supplementary Information:

This device complies with part 15 of the FCC Rules. Operation is subject to the following two conditions: (1) This device may not cause harmful and (2) this device must accept any interference received, including that may cause undesired operation.

Representative Person's Name: ERIC LU

Signature: Eric Lu

Date: Sep. 5, 2004

Copyright

© 2004 GIGA-BYTE TECHNOLOGY CO., LTD. All rights reserved.

The trademarks mentioned in the manual are legally registered to their respective companies.

Notice

The written content provided with this product is the property of Gigabyte.

No part of this manual may be reproduced, copied, translated, or transmitted in any form or by any means without Gigabyte's prior written permission. Specifications and features are subject to change without prior notice.

Product Manual Classification

In order to assist in the use of this product, Gigabyte has categorized the user manual in the following:

- For detailed product information and specifications, please carefully read the "Product User Manual".

- For detailed information related to Gigabyte's unique features, please go to Gigabyte's website under "Technology Guide" where information can be downloaded in .pdf format.

For more product details, please click onto Gigabyte's website at www.gigabyte.com.tw

Table of Contents

GA-81865GM-775/GA-81865GMF-775 Motherboard Layout	6
Block Diagram	7
Chapter 1 Hardware Installation	9
1-1 Considerations Prior to Installation	9
1-2 Feature Summary	10
1-3 Installation of the CPU and Heatsink	11
1-3-1 Installation of the CPU	11
1-3-2 Installation of the Heatsink	12
1-4 Installation of Memory	13
1-5 Installation of Expansion Cards	15
1-6 I/O Back Panel Introduction	16
1-7 Connectors Introduction	17
Chapter 2 BIOS Setup	27
The Main Menu (For example: BIOS Ver. : E4)	28
2-1 Standard CMOS Features	30
2-2 Advanced BIOS Features	32
2-3 Integrated Peripherals	34
2-4 Power Management Setup	37
2-5 PnP/PCI Configurations	38
2-6 PC Health Status	39
2-7 Frequency/Voltage Control	40
2-8 Load Fail-Safe Defaults	41
2-9 Load Optimized Defaults	41
2-10 Set Supervisor/User Password	42
2-11 Save & Exit Setup	43
2-12 Exit Without Saving	43

Chapter 3 Drivers Installation	45
3-1 Install Chipset Drivers	45
3-2 Software Application	46
3-3 Software Information	46
3-4 Hardware Information	47
3-5 Contact Us	47
 Chapter 4 Appendix	 49
4-1 Unique Software Utilities	49
4-1-1 Xpress Recovery Introduction	49
4-1-2 Flash BIOS Method Introduction	52
4-1-3 2- / 4- / 5.1- Channel Audio Function Introduction	61
4-2 Troubleshooting	65

GA-8I865GM-775/GA-8I865GMF-775 Motherboard Layout

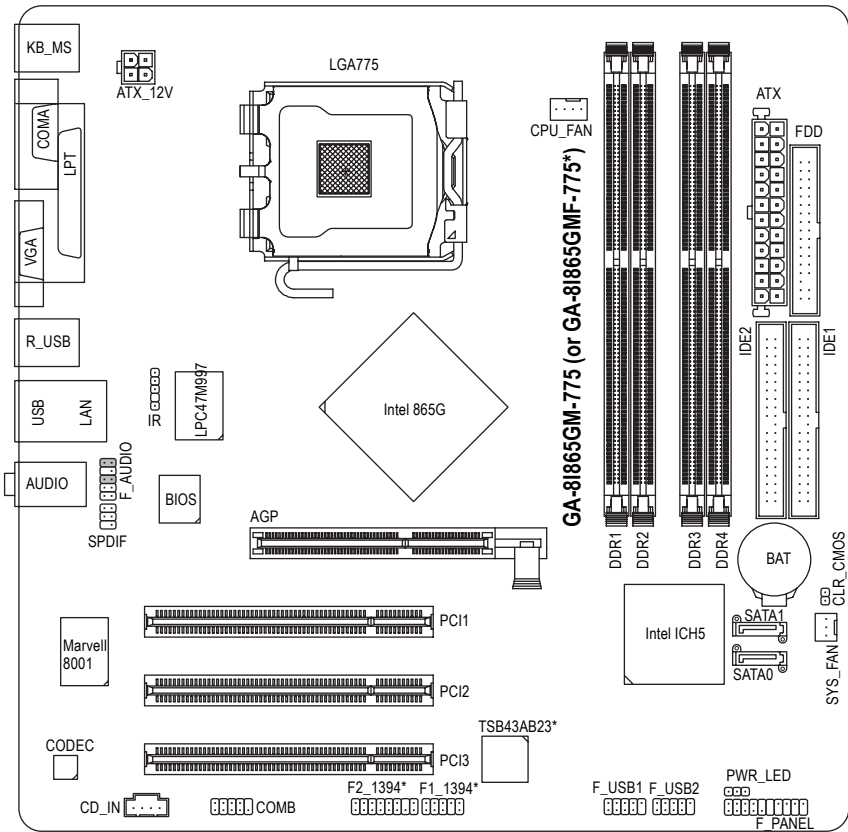

* Only for GA-8I865GMF-775.

Block Diagram

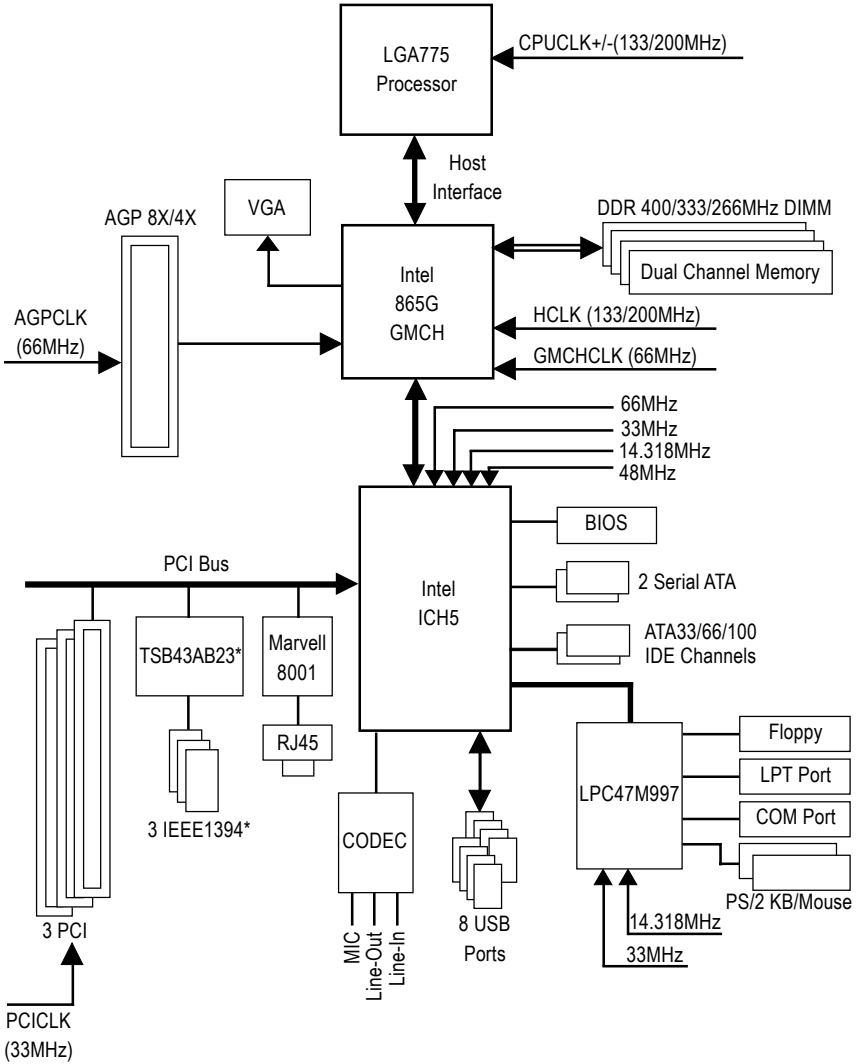

* Only for GA-8I865GMF-775.

Chapter 1 Hardware Installation

1-1 Considerations Prior to Installation

Preparing Your Computer

The motherboard contains numerous delicate electronic circuits and components which can become damaged as a result of electrostatic discharge (ESD). Thus, prior to installation, please follow the instructions below:

1. Please turn off the computer and unplug its power cord.
2. When handling the motherboard, avoid touching any metal leads or connectors.
3. It is best to wear an electrostatic discharge (ESD) cuff when handling electronic components (CPU, RAM).
4. Prior to installing the electronic components, please have these items on top of an antistatic pad or within a electrostatic shielding container.
5. Please verify that you the power supply is switched off before unplugging the power supply connector from the motherboard.

Installation Notices

1. Prior to installation, please do not remove the stickers on the motherboard. These stickers are required for warranty validation.
2. Prior to the installation of the motherboard or any hardware, please first carefully read the information in the provided manual.
3. Before using the product, please verify that all cables and power connectors are connected.
4. To prevent damage to the motherboard, please do not allow screws to come in contact with the motherboard circuit or its components.
5. Please make sure there are no leftover screws or metal components placed on the motherboard or within the computer casing.
6. Please do not place the computer system on an uneven surface.
7. Turning on the computer power during the installation process can lead to damage to system components as well as physical harm to the user.
8. If you are uncertain about any installation steps or have a problem related to the use of the product, please consult a certified computer technician.

Instances of Non-Warranty

1. Damage due to natural disaster, accident or human cause.
2. Damage as a result of violating the conditions recommended in the user manual.
3. Damage due to improper installation.
4. Damage due to use of uncertified components.
5. Damage due to use exceeding the permitted parameters.
6. Product determined to be an unofficial Gigabyte product.

1-2 Feature Summary

Motherboard	<ul style="list-style-type: none"> ♦ GA-8I865GM-775 or GA-8I865GMF-775
CPU	<ul style="list-style-type: none"> ♦ Supports the latest Intel® Pentium® 4 LGA775 CPU ♦ Supports 800/533MHz FSB ♦ L2 cache varies with CPU
Chipset	<ul style="list-style-type: none"> ♦ Northbridge: Intel® 865G Chipset ♦ Southbridge: Intel® ICH5
Memory	<ul style="list-style-type: none"> ♦ 4 DDR DIMM memory slots (supports up to 4GB memory) ^(Note) ♦ Supports dual channel DDR 400/333/266 unbrffered DIMM ♦ Supports 2.5V DDR DIMM
Slots	<ul style="list-style-type: none"> ♦ 1 AGP slot supports 8X/4X(1.5V) mode ♦ 3 PCI slots
IDE Connections	<ul style="list-style-type: none"> ♦ 2 IDE connection (UDMA 33/ATA 66/ATA 100), allows connection of 4 IDE devices
FDD Connections	<ul style="list-style-type: none"> ♦ 1 FDD connection, allows connection of 2 FDD devices
Onboard SATA	<ul style="list-style-type: none"> ♦ 2 Serial ATA ports from ICH5 controller (SATA0, SATA1)
Peripherals	<ul style="list-style-type: none"> ♦ 1 parallel port supporting Normal/EPP/ECP mode ♦ 2 serial ports (COMA, onboard COMB) ♦ 8 USB 2.0/1.1 ports (rear x 4, front x 4 via cable) ♦ 3 IEEE1394 ports* (requires cable) ♦ 1 front audio connector ♦ 1 IR connector ♦ 1 PS/2 keyboard port ♦ 1 PS/2 mouse port
Onboard LAN	<ul style="list-style-type: none"> ♦ Onboard Marvell 8001 chip (10/100/1000 Mbit) ♦ 1 RJ 45 port
Onboard Audio	<ul style="list-style-type: none"> ♦ ADI AD1888 CODEC ♦ Supports 2 / 4 / 6 channel audio ♦ Supports Line In (Rear Speaker Out) ; Line Out (Front Speaker Out) ; MIC (Center/Subwoofer Speaker Out) ♦ SPDIF Out connection ♦ CD In connection
I/O Control	<ul style="list-style-type: none"> ♦ SMSC LPC47M997
Hardware Monitor	<ul style="list-style-type: none"> ♦ System voltage detection ♦ CPU / System temperature detection ♦ CPU / System fan speed detection
BIOS	<ul style="list-style-type: none"> ♦ Use of licensed AWARD BIOS ♦ Supports Q-Flash
Additional Features	<ul style="list-style-type: none"> ♦ Supports @BIOS
Form Factor	<ul style="list-style-type: none"> ♦ Micro ATX form factor; 24.4cm x 24.4cm

(Note) Due to standard PC architecture, a certain amount of memory is reserved for system usage and therefore the actual memory size is less than the stated amount.
For example, 4 GB of memory size will instead be shown as 3.xxGB memory during system startup.

* Only for GA-8I865GMF-775.

1-3 Installation of the CPU and Heatsink



Before installing the CPU, please comply with the following conditions:

1. Please make sure that the motherboard supports the CPU.
2. Please take note of the one indented corner of the CPU. If you install the CPU in the wrong direction, the CPU will not insert properly. If this occurs, please change the insert direction of the CPU.
3. Please add an even layer of heat sink paste between the CPU and heatsink.
4. Please make sure the heatsink is installed on the CPU prior to system use, otherwise overheating and permanent damage of the CPU may occur.
5. Please set the CPU host frequency in accordance with the processor specifications. It is not recommended that the system bus frequency be set beyond hardware specifications since it does not meet the required standards for the peripherals. If you wish to set the frequency beyond the proper specifications, please do so according to your hardware specifications including the CPU, graphics card, memory, hard drive, etc.



HT functionality requirement content :

Enabling the functionality of Hyper-Threading Technology for your computer system requires all of the following platform components:

- CPU: An Intel® Pentium 4 Processor with HT Technology
- Chipset: An Intel® Chipset that supports HT Technology
- BIOS: A BIOS that supports HT Technology and has it enabled
- OS: An operation system that has optimizations for HT Technology

1-3-1 Installation of the CPU

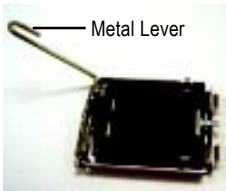

Fig. 1
Gently lift the metal lever located on the CPU socket to the upright position.



Fig. 2
Remove the plastic covering on the CPU socket.

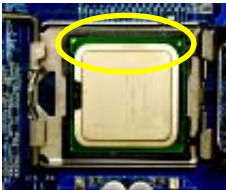

Fig. 3
Notice the small gold colored triangle located on the edge of the CPU socket. Align the indented corner of the



Fig. 4
Once the CPU is properly inserted, please replace the plastic covering and push the metal lever back into its original position.

CPU with the triangle and gently insert the CPU into position. (Grasping the CPU firmly between your thumb and forefinger, carefully place it into the socket in a straight and downwards motion. Avoid twisting or bending motions that might cause damage to the CPU during installation.)

1-3-2 Installation of the Heatsink



Fig. 1
Please apply an even layer of heatsink paste on the surface of the installed CPU.

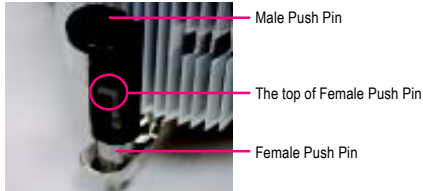

Fig. 2
(Turning the push pin along the direction of arrow is to remove the heatsink, on the contrary, is to install.) Please note the direction of arrow sign on the male push pin doesn't face inwards before installation. (This instruction is only for Intel boxed fan)

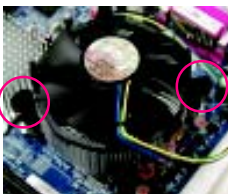

Fig. 3
Place the heatsink atop the CPU and make sure the push pins aim to the pin hole on the motherboard. Pressing down the push pins diagonally.

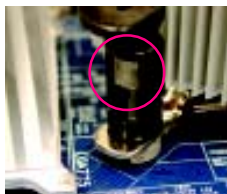

Fig. 4
Please make sure the Male and Female push pin are joined closely. (for detailed installation instructions, please refer to the heatsink installation section of the user manual)

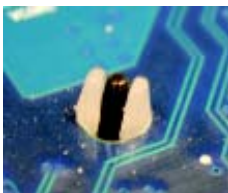

Fig. 5
Please check the back of motherboard after installing. If the push pin is inserted as the picture, the installation is complete.



Fig. 6
Finally, please attach the power connector of the heatsink to the CPU fan header located on the motherboard.



NOTE

The heatsink may adhere to the CPU as a result of hardening of the heatsink paste. To prevent such an occurrence, it is suggested that either thermal tape rather than heat sink paste be used for heat dissipation or using extreme care when removing the heatsink.

1-4 Installation of Memory



Before installing the memory modules, please comply with the following conditions:

1. Please make sure that the memory used is supported by the motherboard. It is recommended that memory of similar capacity, specifications and brand be used.
2. Before installing or removing memory modules, please make sure that the computer power is switched off to prevent hardware damage.
3. Memory modules have a foolproof insertion design. A memory module can be installed in only one direction. If you are unable to insert the module, please switch the direction.

The motherboard supports DDR II memory modules, whereby BIOS will automatically detect memory capacity and specifications. Memory modules are designed so that they can be inserted only in one direction. The memory capacity used can differ with each slot.

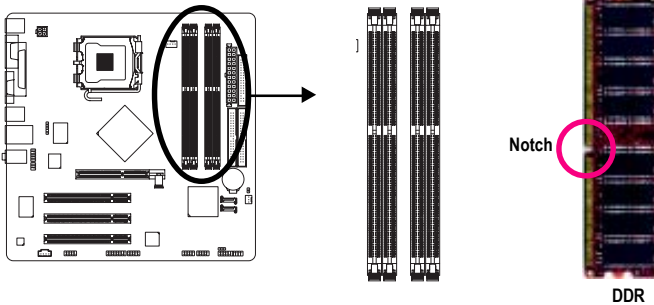

Fig.1

The DIMM socket has a notch, so the DIMM memory module can only fit in one direction. Insert the DIMM memory module vertically into the DIMM socket. Then push it down.



Fig.2

Close the plastic clip at both edges of the DIMM sockets to lock the DIMM module.

Reverse the installation steps when you wish to remove the DIMM module.

Dual Channel DDR

GA-8I865GM-775 / GA-8I865GMF-775 supports the Dual Channel Technology. After operating the Dual Channel Technology, the bandwidth of Memory Bus will add double up to 6.4GB/s(DDR400).

GA-8I865GM-775 / GA-8I865GMF-775 includes 4 DIMM sockets, and each Channel has two DIMM sockets as following:

- ▶▶ Channel A : DDR 1, DDR 2
- ▶▶ Channel B : DDR 3, DDR 4

If you want to operate the Dual Channel Technology, please note the following explanations due to the limitation of Intel chipset specifications.

1. Dual channel memory cannot be used if one or three DDR memory modules are installed.
2. If two DDR memory modules are installed (same storage capacity), one must be added to the Channel A slot and the other in the Channel B slot in order to use dual channel memory. Dual channel memory cannot function if both DDR memory modules are installed on the same channel.
3. If four DDR memory modules are installed, please use memory of the same storage capacity in order to use dual channel memory and for BIOS to detect all the DDR memory modules.

We'll strongly recommend our user to slot two DDR memory modules into the DIMMs with the same color in order for Dual Channel Technology to work.

The following table is for Dual Channel Technology combination: (DS: Double Side, SS: Single Side)

	DDR 1	DDR 2	DDR 3	DDR 4
2 memory modules	DS/SS	X	DS/SS	X
	X	DS/SS	X	DS/SS
4 memory modules	DS/SS	DS/SS	DS/SS	DS/SS

1-5 Installation of Expansion Cards

You can install your expansion card by following the steps outlined below:

1. Read the related expansion card's instruction document before install the expansion card into the computer.
2. Remove your computer's chassis cover, screws and slot bracket from the computer.
3. Press the expansion card firmly into expansion slot in motherboard.
4. Be sure the metal contacts on the card are indeed seated in the slot.
5. Replace the screw to secure the slot bracket of the expansion card.
6. Replace your computer's chassis cover.
7. Power on the computer, if necessary, setup BIOS utility of expansion card from BIOS.
8. Install related driver from the operating system.

Installing a AGP VGA card:

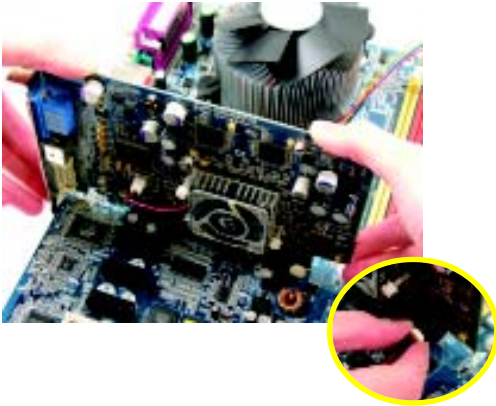

Please carefully pull out the small white-drawable bar at the end of the AGP slot when you try to install/uninstall the VGA card. Please align the VGA card to the onboard AGP slot and press firmly down on the slot. Make sure your VGA card is locked by the small white-drawable bar.

1-6 I/O Back Panel Introduction

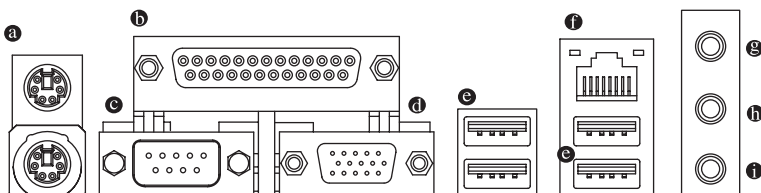

Ⓐ PS/2 Keyboard and PS/2 Mouse Connector

To install a PS/2 port keyboard and mouse, plug the mouse to the upper port (green) and the keyboard to the lower port (purple).

Ⓑ Parallel Port

The parallel port allows connection of a printer, scanner and other peripheral devices.

Ⓒ COM A (Serial Port)

Connects to serial-based mouse or data processing devices.

Ⓓ VGA Port

Monitor can be connected to VGA port.

Ⓔ USB port

Before you connect your device(s) into USB connector(s), please make sure your device(s) such as USB keyboard, mouse, scanner, zip, speaker...etc. have a standard USB interface. Also make sure your OS supports USB controller. If your OS does not support USB controller, please contact OS vendor for possible patch or driver upgrade. For more information please contact your OS or device(s) vendors.

Ⓕ LAN Port

The provided Internet connection is Gigabit Ethernet, providing data transfer speeds of 10/100/1000Mbps.

Ⓖ Line In

Devices like CD-ROM, walkman etc. can be connected to Line In jack.

Ⓗ Line Out

Connect the stereo speakers or earphone to this connector.

Ⓖ MIC In

Microphone can be connected to MIC In jack.



NOTE

You can use audio software to configure 2-/4-/6-channel audio functioning.

1-7 Connectors Introduction

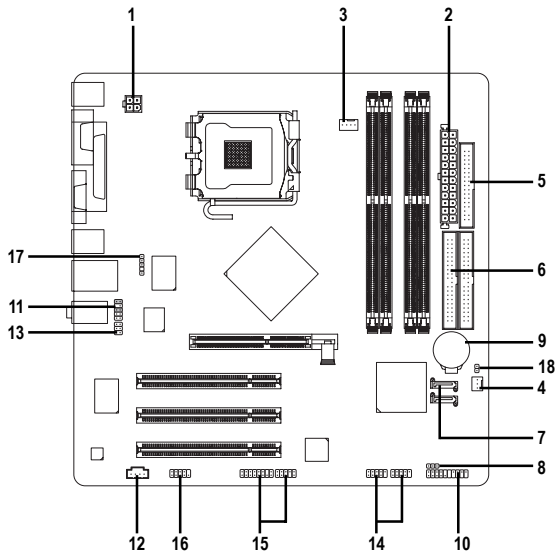

1) ATX_12V	10) F_PANEL
2) ATX (Power Connector)	11) F_AUDIO
3) CPU_FAN	12) CD_IN
4) SYS_FAN	13) SPDIF
5) FDD	14) F_USB1 / F_USB2
6) IDE1 / IDE2	15) F1_1394* / F2_1394*
7) SATA0 / SATA1	16) COMB
8) PWR_LED	17) IR
9) BAT	18) CLR_CMOS

* Only for GA-8I865GMF-775.

1/2) ATX_12V/ATX (Power Connector)

With the use of the power connector, the power supply can supply enough stable power to all the components on the motherboard. Before connecting the power connector, please make sure that all components and devices are properly installed. Align the power connector with its proper location on the motherboard and connect tightly.

The ATX_12V power connector mainly supplies power to the CPU. If the ATX_12V power connector is not connected, the system will not start.

Caution!

Please use a power supply that is able to handle the system voltage requirements. It is recommended that a power supply that can withstand high power consumption be used (300W or greater). If a power supply is used that does not provide the required power, the result can lead to an unstable system or a system that is unable to start.

Please remove the sticker on the motherboard before plugging in while the ATX power supplier is 24 pins; Otherwise, please do not remove it.

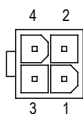
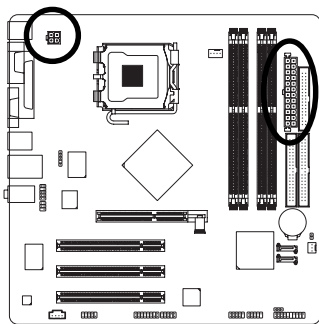

Pin No.	Definition
1	GND
2	GND
3	+12V
4	+12V

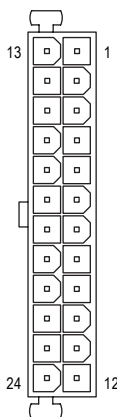

Pin No.	Definition
1	3.3V
2	3.3V
3	GND
4	VCC
5	GND
6	VCC
7	GND
8	Power Good
9	5V SB(stand by +5V)
10	+12V
11	+12V
12	3.3V(Only for 24pins ATX)
13	3.3V
14	-12V
15	GND
16	PS_ON(soft On/Off)
17	GND
18	GND
19	GND
20	-5V
21	VCC
22	VCC
23	VCC
24	GND

3/4) CPU_FAN / SYS_FAN (Cooler Fan Power Connector)

The cooler fan power connector supplies a +12V power voltage via a 3-pin/4-pin(only for CPU_FAN) power connector and possesses a foolproof connection design.

Most coolers are designed with color-coded power connector wires. A red power connector wire indicates a positive connection and requires a +12V power voltage. The black connector wire is the ground wire (GND).

Please remember to connect the power to the cooler to prevent system overheating and failure.

Caution!

Please remember to connect the power to the CPU fan to prevent CPU overheating and failure.

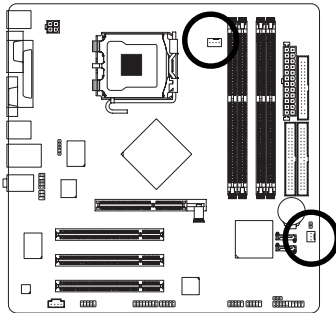

1
CPU_FAN



1
SYS_FAN

Pin No.	Definition
1	GND
2	+12V
3	Sense
4	Speed Control (Only for CPU_FAN)

5) FDD (FDD Connector)

The FDD connector is used to connect the FDD cable while the other end of the cable connects to the FDD drive. The types of FDD drives supported are: 360KB, 720KB, 1.2MB, 1.44MB and 2.88MB.

Please connect the red power connector wire to the pin1 position.

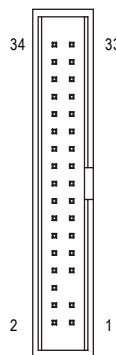
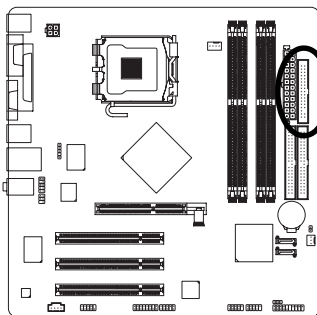

6) IDE1 / IDE2 (IDE Connector)

An IDE device connects to the computer via an IDE connector. One IDE connector can connect to one IDE cable, and the single IDE cable can then connect to two IDE devices (hard drive or optical drive). If you wish to connect two IDE devices, please set the jumper on one IDE device as Master and the other as Slave (for information on settings, please refer to the instructions located on the IDE device).

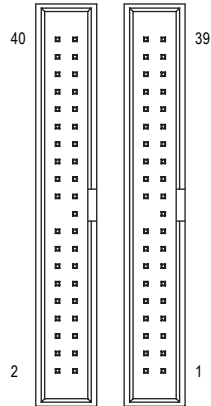
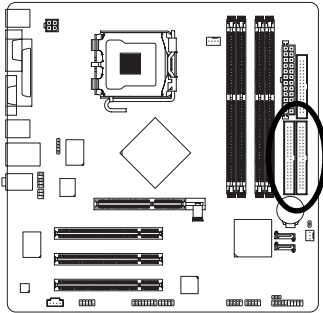

7) SATA0 / SATA1 (Serial ATA Connector)

Serial ATA can provide 150MB/s transfer rate. Please refer to the BIOS setting for the Serial ATA and install the proper driver in order to work properly.

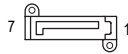
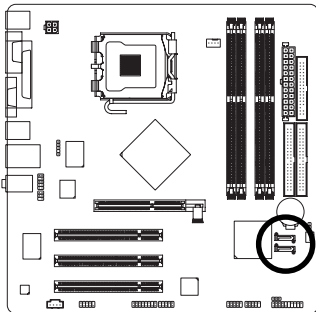

Pin No.	Definition
1	GND
2	TXP
3	TXN
4	GND
5	RXN
6	RXP
7	GND

8) PWR_LED

PWR_LED is connect with the system power indicator to indicate whether the system is on/off. It will blink when the system enters suspend mode.

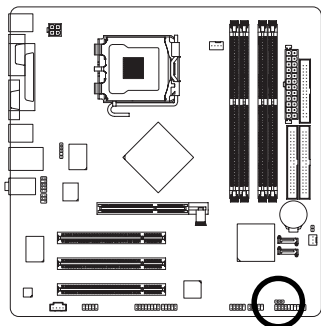

1 

Pin No.	Definition
1	MPD+
2	MPD-
3	MPD-

9) BAT(Battery)

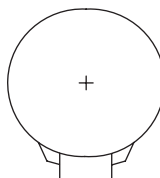
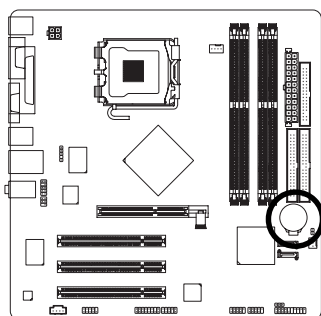

- ❖ Danger of explosion if battery is incorrectly replaced.
- ❖ Replace only with the same or equivalent type recommended by the manufacturer.
- ❖ Dispose of used batteries according to the manufacturer's instructions.

If you want to erase CMOS...

1. Turn OFF the computer and unplug the power cord.
2. Remove the battery, wait for 30 second.
3. Re-install the battery.
4. Plug the power cord and turn ON the computer.

10) F_PANEL (Front Panel Jumper)

Please connect the power LED, PC peaker, reset switch and power switch etc. of your chassis front panel to the F_PANEL connector according to the pin assignment below.

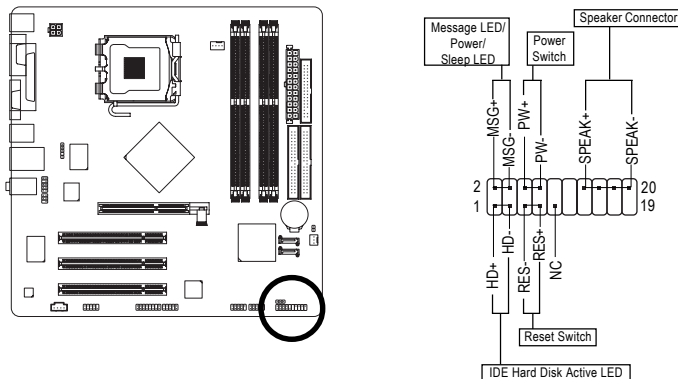

HD (IDE Hard Disk Active LED)	Pin 1: LED anode(+) Pin 2: LED cathode(-)
SPEAK (Speaker Connector)	Pin 1: VCC(+) Pin 2- Pin 3: NC Pin 4: Data(-)
RES (Reset Switch)	Open: Normal Operation Close: Reset Hardware System
PW (Power Switch)	Open: Normal Operation Close: Power On/Off
MSG (Message LED/Power/Sleep LED)	Pin 1: LED anode(+) Pin 2: LED cathode(-)
NC	NC

11) F_AUDIO (Front Audio Panel Connector)

If you want to use Front Audio connector, you must remove 5-6, 9-10 Jumper.

In order to utilize the front audio header, your chassis must have front audio connector. Also please make sure the pin assignment on the cable is the same as the pin assignment on the MB header. To find out if the chassis you are buying support front audio connector, please contact your dealer. Please note, you can have the alternative of using front audio connector or of using rear audio connector to play sound.

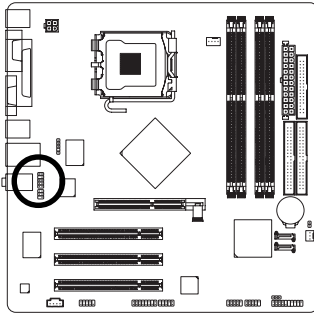

Pin No.	Definition
1	MIC
2	GND
3	MIC_BIAS
4	Power
5	Front Audio (R)
6	Rear Audio (R)
7	Reserved
8	No Pin
9	Front Audio (L)
10	Rear Audio (L)

12) CD_IN (CD In Connector)

Connect CD-ROM or DVD-ROM audio out to the connector.

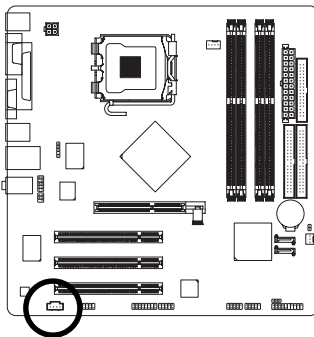

Pin No.	Definition
1	CD-L
2	GND
3	GND
4	CD-R

13) SPDIF (SPDIF Out Connector)

The SPDIF output is capable of providing digital audio to external speakers or compressed AC3 data to an external Dolby Digital Decoder. Use this feature only when your stereo system has digital input function. Be careful with the polarity of the SPDIF connector. Check the pin assignment carefully while you connect the SPDIF cable, incorrect connection between the cable and connector will make the device unable to work or even damage it. For optional SPDIF cable, please contact your local dealer.

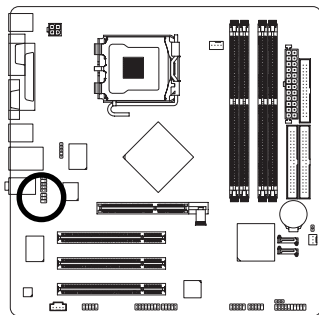

Pin No.	Definition
1	VCC
2	No Pin
3	SPDIF
4	NC
5	GND
6	GND

14) F_USB1 / F_USB2 (Front USB Connector)

Be careful with the polarity of the front USB connector. Check the pin assignment carefully while you connect the front USB cable, incorrect connection between the cable and connector will make the device unable to work or even damage it. For optional front USB cable, please contact your local dealer.

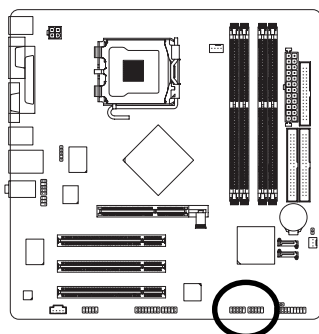

Pin No.	Definition
1	Power
2	Power
3	USB Dx-
4	USB Dy-
5	USB Dx+
6	USB Dy+
7	GND
8	GND
9	No Pin
10	NC

15) F1_1394 / F2_1394 (IEEE1394 Connector)*

Serial interface standard set by Institute of Electrical and Electronics Engineers, which has features like high speed, high bandwidth and hot plug. Be careful with the polarity of the IEEE1394 connector. Check the pin assignment carefully while you connect the IEEE1394 cable, incorrect connection between the cable and connector will make the device unable to work or even damage it. For optional IEEE1394 cable, please contact your local dealer.

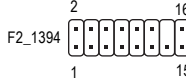
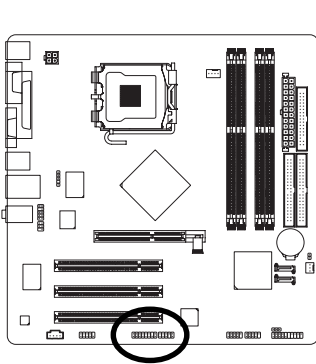

Pin No.	Definition
1	Power
2	Power
3	TPA1+
4	TPA1-
5	GND
6	GND
7	TPB1+
8	TPB1-
9	Power
10	Power
11	TPA2+
12	TPA2-
13	GND
14	No Pin
15	TPB2+
16	TPB2-

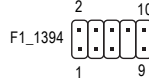

Pin No.	Definition
1	TPA0+
2	TPA0-
3	GND
4	GND
5	TPB0+
6	TPB0-
7	No Pin
8	Power
9	Power
10	GND

16) COMB (COM B Connector)

Be careful with the polarity of the COMB connector. Check the pin assignment carefully while you connect the COMB cable, incorrect connection between the cable and connector will make the device unable to work or even damage it. For optional COMB cable, please contact your local dealer.

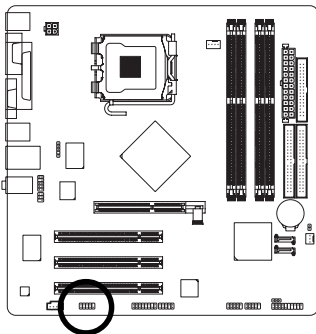

Pin No.	Definition
1	NDCDB-
2	NSINB
3	NSOUTB
4	NDTRB-
5	GND
6	NDSRB-
7	NRTSB-
8	NCTSB-
9	NRIB-
10	No Pin

* Only for GA-8I865GMF-775.

17) IR

Be careful with the polarity of the IR connector while you connect the IR. Please contact your nearest dealer for optional IR device.

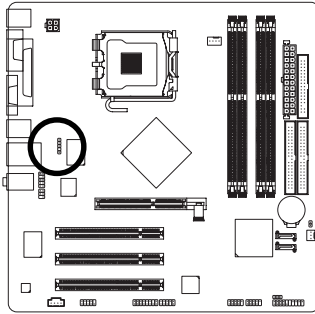

Pin No.	Definition
1	VCC
2	No Pin
3	IR RX
4	GND
5	IR TX

18) CLR_CMOS (Clear CMOS)

You may clear the CMOS data to its default values by this jumper. To clear CMOS, temporarily short 1-2 pin. Default doesn't include the "Shunter" to prevent from improper use this jumper.

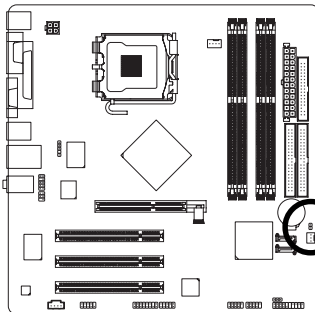

Open: Normal



Short: Clear CMOS

Chapter 2 BIOS Setup

BIOS (Basic Input and Output System) includes a CMOS SETUP utility which allows user to configure required settings or to activate certain system features.

The CMOS SETUP saves the configuration in the CMOS SRAM of the motherboard.

When the power is turned off, the battery on the motherboard supplies the necessary power to the CMOS SRAM.

When the power is turned on, pushing the button during the BIOS POST (Power-On Self Test) will take you to the CMOS SETUP screen. You can enter the BIOS setup screen by pressing "Ctrl + F1".

When setting up BIOS for the first time, it is recommended that you save the current BIOS to a disk in the event that BIOS needs to be reset to its original settings. If you wish to upgrade to a new BIOS, either Gigabyte's Q-Flash or @BIOS utility can be used.

Q-Flash allows the user to quickly and easily update or backup BIOS without entering the operating system. @BIOS is a Windows-based utility that does not require users to boot to DOS before upgrading BIOS but directly download and update BIOS from the Internet.

CONTROL KEYS

<↑><↓><←><→>	Move to select item
<Enter>	Select Item
<Esc>	Main Menu - Quit and not save changes into CMOS Status Page Setup Menu and Option Page Setup Menu - Exit current page and return to Main Menu
<Page Up>	Increase the numeric value or make changes
<Page Down>	Decrease the numeric value or make changes
<F1>	General help, only for Status Page Setup Menu and Option Page Setup Menu
<F2>	Item Help
<F5>	Restore the previous CMOS value from CMOS, only for Option Page Setup Menu
<F6>	Load the file-safe default CMOS value from BIOS default table
<F7>	Load the Optimized Defaults
<F8>	Q-Flash utility
<F9>	System Information
<F10>	Save all the CMOS changes, only for Main Menu

Main Menu

The on-line description of the highlighted setup function is displayed at the bottom of the screen.

Status Page Setup Menu / Option Page Setup Menu

Press F1 to pop up a small help window that describes the appropriate keys to use and the possible selections for the highlighted item. To exit the Help Window press <Esc>.

The Main Menu (For example: BIOS Ver. : E4)

Once you enter Award BIOS CMOS Setup Utility, the Main Menu (as figure below) will appear on the screen. Use arrow keys to select among the items and press <Enter> to accept or enter the sub-menu.

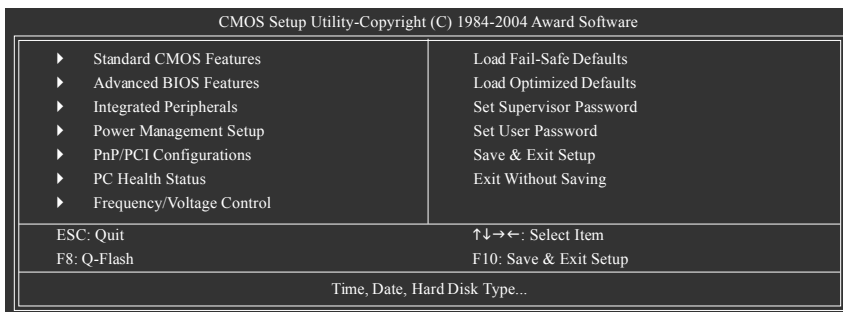

If you can't find the setting you want, please press "Ctrl+F1" to search the advanced option hidden.

■ Standard CMOS Features

This setup page includes all the items in standard compatible BIOS.

■ Advanced BIOS Features

This setup page includes all the items of Award special enhanced features.

■ Integrated Peripherals

This setup page includes all onboard peripherals.

■ Power Management Setup

This setup page includes all the items of Green function features.

■ PnP/PCI Configuration

This setup page includes all the configurations of PCI & PnP ISA resources.

■ PC Health Status

This setup page is the System auto detect Temperature, voltage, fan, speed.

■ Frequency/Voltage Control

This setup page is control CPU clock and frequency ratio.

■ Load Fail-Safe Defaults

Fail-Safe Defaults indicates the value of the system parameters which the system would be in safe configuration.

■ Load Optimized Defaults

Optimized Defaults indicates the value of the system parameters which the system would be in best performance configuration.

■ Set Supervisor Password

Change, set, or disable password. It allows you to limit access to the system and Setup, or just to Setup.

■ Set User Password

Change, set, or disable password. It allows you to limit access to the system.

■ Save & Exit Setup

Save CMOS value settings to CMOS and exit setup.

■ Exit Without Saving

Abandon all CMOS value changes and exit setup.

2-1 Standard CMOS Features

CMOS Setup Utility-Copyright (C) 1984-2004 Award Software Standard CMOS Features		
Date (mm:dd:yy)	Thu, Aug 5 2004	Item Help
Time (hh:mm:ss)	22:31:24	Menu Level▶
▶ IDE Channel 0 Master	[None]	Change the day, month, year
▶ IDE Channel 0 Slave	[None]	<Week>
▶ IDE Channel 1 Master	[None]	Sun. to Sat.
▶ IDE Channel 1 Slave	[None]	<Month>
Drive A	[1.44M, 3.5"]	Jan. to Dec.
Drive B	[None]	<Day>
Floppy 3 Mode Suport	[Disabled]	1 to 31 (or maximum allowed in the month)
Halt On	[All, But Keyboard]	<Year>
Base Memory	640K	1999 to 2098
Extended Memory	239M	
Total Memory	240M	
↑↓←→: Move Enter: Select +/-/PU/PD: Value F10: Save ESC: Exit F1: General Help F5: Previous Values F6: Fail-Save Defaults F7: Optimized Defaults		

☞ Date

The date format is <week>, <month>, <day>, <year>.

- ▶▶ Week The week, from Sun to Sat, determined by the BIOS and is display only
- ▶▶ Month The month, Jan. Through Dec.
- ▶▶ Day The day, from 1 to 31 (or the maximum allowed in the month)
- ▶▶ Year The year, from 1999 through 2098

☞ Time

The times format in <hour> <minute> <second>. The time is calculated base on the 24-hour military-time clock. For example, 1 p.m. is 13:00:00.

☞ IDE Channel 0 Master, Slave / IDE Channel 1 Master, Slave

- ▶▶ IDE HDD Auto-Detection Press "Enter" to select this option for automatic device detection.
- ▶▶ IDE Channel 0/1 Master/Slave IDE Device Setup. You can use one of three methods:
 - Auto Allows BIOS to automatically detect IDE devices during POST. (Default value)
 - None Select this if no IDE devices are used and the system will skip the automatic detection step and allow for faster system start up.
 - Manual User can manually input the correct settings.
- ▶▶ Access Mode Use this to set the access mode for the hard drive. The four options are: CHS/LBA/Large/Auto(default:Auto)

Hard drive information should be labeled on the outside drive casing. Enter the appropriate option based on this information.

- ▶▶ Cylinder Number of cylinders
- ▶▶ Head Number of heads
- ▶▶ Precomp Write precomp
- ▶▶ Landing Zone Landing zone
- ▶▶ Sector Number of sectors

If a hard disk has not been installed, select NONE and press <Enter>.

☞ Drive A / Drive B

The category identifies the types of floppy disk drive A or drive B that has been installed in the computer.

- ▶▶ None No floppy drive installed
- ▶▶ 360K, 5.25" 5.25 inch PC-type standard drive; 360K byte capacity.
- ▶▶ 1.2M, 5.25" 5.25 inch AT-type high-density drive; 1.2M byte capacity (3.5 inch when 3 Mode is Enabled).
- ▶▶ 720K, 3.5" 3.5 inch double-sided drive; 720K byte capacity
- ▶▶ 1.44M, 3.5" 3.5 inch double-sided drive; 1.44M byte capacity.
- ▶▶ 2.88M, 3.5" 3.5 inch double-sided drive; 2.88M byte capacity.

☞ Floppy 3 Mode Support (for Japan Area)

- ▶▶ Disabled Normal Floppy Drive. (Default value)
- ▶▶ Drive A Drive A is 3 mode Floppy Drive.
- ▶▶ Drive B Drive B is 3 mode Floppy Drive.
- ▶▶ Both Drive A & B are 3 mode Floppy Drives.

☞ Halt on

The category determines whether the computer will stop if an error is detected during power up.

- ▶▶ No Errors The system boot will not stop for any error that may be detected and you will be prompted.
- ▶▶ All Errors Whenever the BIOS detects a non-fatal error the system will be stopped.
- ▶▶ All, But Keyboard The system boot will not stop for a keyboard error; it will stop for all other errors. (Default value)
- ▶▶ All, But Diskette The system boot will not stop for a disk error; it will stop for all other errors.
- ▶▶ All, But Disk/Key The system boot will not stop for a keyboard or disk error; it will stop for all other errors.

☞ Memory

The category is display-only which is determined by POST (Power On Self Test) of the BIOS.

▶▶ Base Memory

The POST of the BIOS will determine the amount of base (or conventional) memory installed in the system.

The value of the base memory is typically 512K for systems with 512K memory installed on the motherboard, or 640K for systems with 640K or more memory installed on the motherboard.

▶▶ Extended Memory

The BIOS determines how much extended memory is present during the POST.

This is the amount of memory located above 1 MB in the CPU's memory address map.

▶▶ Total Memory

This item displays the memory size that used.

2-2 Advanced BIOS Features

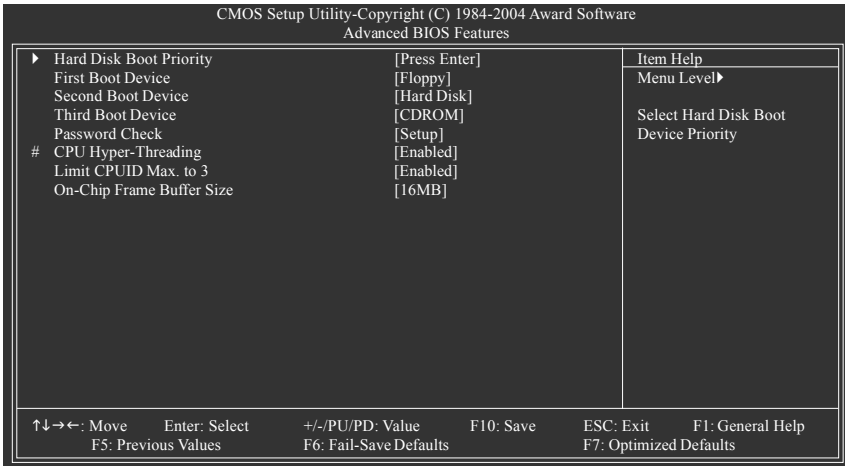

" # " System will detect automatically and show up when you install the Intel® Pentium® 4 processor with HT Technology.

☞ Hard Disk Boot Priority

Select boot sequence for onboard(or add-on cards) SCSI, RAID, etc.

Use <↑> or <↓> to select a device, then press<+> to move it up, or <-> to move it down the list. Press <ESC> to exit this menu.

☞ First / Second / Third Boot Device

- ▶ Floppy Select your boot device priority by Floppy.
- ▶ LS120 Select your boot device priority by LS120.
- ▶ Hard Disk Select your boot device priority by Hard Disk.
- ▶ CDROM Select your boot device priority by CDROM.
- ▶ ZIP Select your boot device priority by ZIP.
- ▶ USB-FDD Select your boot device priority by USB-FDD.
- ▶ USB-ZIP Select your boot device priority by USB-ZIP.
- ▶ USB-CDROM Select your boot device priority by USB-CDROM.
- ▶ USB-HDD Select your boot device priority by USB-HDD.
- ▶ LAN Select your boot device priority by LAN.
- ▶ Disabled Select your boot device priority by Disabled.

☞ Password Check

- ▶ Setup The system will boot but will not access to Setup page if the correct password is not entered at the prompt. (Default value)
- ▶ System The system will not boot and will not access to Setup page if the correct password is not entered at the prompt.

 **CPU Hyper-Threading**

- ▶▶ Enabled Enables CPU Hyper Threading Feature. Please note that this feature is only working for operating system with multi processors mode supported. (Default value)
- ▶▶ Disabled Disables CPU Hyper Threading.

 **Limit CPUID Max. to 3**

- ▶▶ Enabled Limit CPUID Maximum value to 3 when use older OS like NT4. (Default value)
- ▶▶ Disabled Disables CPUID Limit for windows XP.

 **On-Chip Frame Buffer Size**

- ▶▶ 1MB Set on-chip frame buffer size to 1MB.
- ▶▶ 4MB Set on-chip frame buffer size to 4MB.
- ▶▶ 8MB Set on-chip frame buffer size to 8MB.
- ▶▶ 16MB Set on-chip frame buffer size to 16MB. (Default value)
- ▶▶ 32MB Set on-chip frame buffer size to 32MB.

2-3 Integrated Peripherals

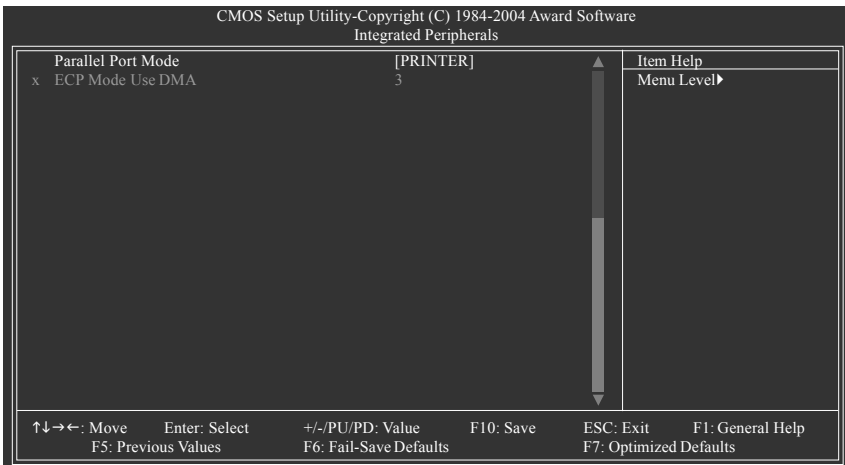
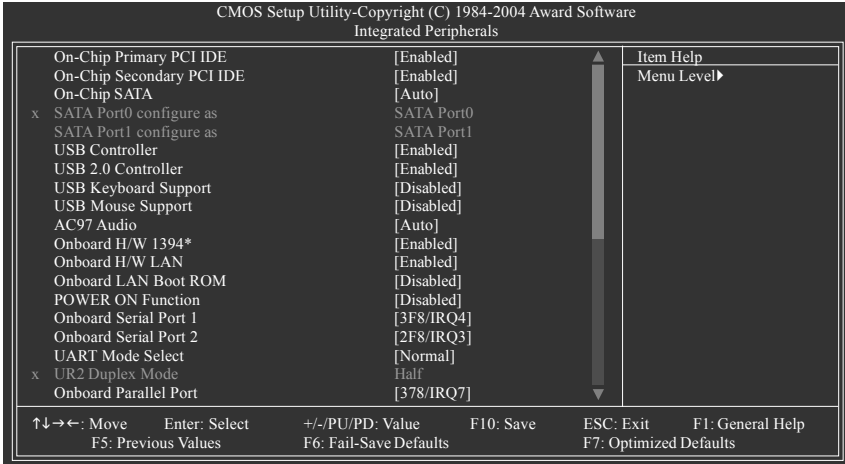

☞ On-Chip Primary PCI IDE

- ▶▶ Enabled Enable onboard 1st channel IDE port. (Default value)
- ▶▶ Disabled Disable onboard 1st channel IDE port.

☞ On-Chip Secondary PCI IDE

- ▶▶ Enabled Enable onboard 2nd channel IDE port. (Default value)
- ▶▶ Disabled Disable onboard 2nd channel IDE port.

☞ On-Chip SATA

- ▶▶ Disabled Disable onboard Serial ATA function.
- ▶▶ Auto When there is no device to be plugged in IDE1 or IDE2, SATA controller will remap to IDE controller. (Default value)
- ▶▶ Manual Set SATA mode manually from "SATA Port0 configure as" item.

* Only for GA-8I865GMF-775.

☞ **SATA Port0 configure as**

- ▶▶ IDE Pri. Master Set SATA controller to compatible mode. This mode will remap SATA Port 0 to IDE Primary Master.
- ▶▶ IDE Pri. Slave Set SATA controller to compatible mode. This mode will remap SATA Port 0 to IDE Primary Slave.
- ▶▶ IDE Sec. Master Set SATA controller to compatible mode. This mode will remap SATA Port 0 to IDE Secondary Master.
- ▶▶ IDE Sec. Slave Set SATA controller to compatible mode. This mode will remap SATA Port 0 to IDE Secondary Slave.
- ▶▶ SATA Port0 Set SATA controller to native mode(Serial ATA mode - SATA Port 0). This mode is only supported by Windows XP or later. (Default value)
- ▶▶ SATA Port1 Set SATA controller to native mode(Serial ATA mode - SATA Port 1). This mode is only supported by Windows XP or later.

☞ **SATA Port1 configure as**

- ▶▶ The setting depends on "SATA Port0 configure as" item setting. (Default: SATA Port1)

☞ **USB Controller**

- ▶▶ Enabled Enable USB controller. (Default value)
- ▶▶ Disabled Disable USB controller.

☞ **USB 2.0 Controller**

You can disable this function if you are not using onboard USB 2.0 feature.

- ▶▶ Enabled Enable USB 2.0 controller. (Default value)
- ▶▶ Disabled Disable USB 2.0 controller.

☞ **USB Keyboard Support**

- ▶▶ Enabled Enable USB keyboard support.
- ▶▶ Disabled Disable USB keyboard support. (Default value)

☞ **USB Mouse Support**

- ▶▶ Enabled Enable USB mouse support.
- ▶▶ Disabled Disable USB mouse support. (Default value)

☞ **AC97 Audio**

- ▶▶ Auto Auto detect AC97 audio function. (Default value)
- ▶▶ Disabled Disable AC97 audio function.

☞ **Onboard H/W 1394***

- ▶▶ Enabled Enable onboard IEEE1394 function. (Default value)
- ▶▶ Disabled Disable this function.

☞ **Onboard H/W LAN**

- ▶▶ Enabled Enable onboard H/W LAN function. (Default value)
- ▶▶ Disabled Disable this function.

☞ **Onboard LAN Boot ROM**

This function decide whether to invoke the boot ROM of the onboard LAN chip.

- ▶▶ Enabled Enable this function.
- ▶▶ Disabled Disable this function. (Default value)

* Only for GA-8I865GMF-775.

☞ **POWER ON Function**

- ▶▶ Disabled Disable this function. (Default value)
- ▶▶ Any KEY Press any key to power on the system.
- ▶▶ Mouse Double click on mouse left button to power on the system.
- ▶▶ Mouse/Any KEY Press any key or double click on mouse left button to power on the system.

☞ **Onboard Serial Port 1**

- ▶▶ Auto BIOS will automatically setup the port 1 address.
- ▶▶ 3F8/IRQ4 Enable onboard Serial port 1 and address is 3F8. (Default value)
- ▶▶ 2F8/IRQ3 Enable onboard Serial port 1 and address is 2F8.
- ▶▶ 3E8/IRQ4 Enable onboard Serial port 1 and address is 3E8.
- ▶▶ 2E8/IRQ3 Enable onboard Serial port 1 and address is 2E8.
- ▶▶ Disabled Disable onboard Serial port 1.

☞ **Onboard Serial Port 2**

- ▶▶ Auto BIOS will automatically setup the port 1 address.
- ▶▶ 3F8/IRQ4 Enable onboard Serial port 2 and address is 3F8.
- ▶▶ 2F8/IRQ3 Enable onboard Serial port 2 and address is 2F8. (Default value)
- ▶▶ 3E8/IRQ4 Enable onboard Serial port 2 and address is 3E8.
- ▶▶ 2E8/IRQ3 Enable onboard Serial port 2 and address is 2E8.
- ▶▶ Disabled Disable onboard Serial port 2.

☞ **UART Mode Select**

This item allows you to determine which Infra Red(IR) function of Onboard I/O chip.

- ▶▶ Normal Set onboard I/O chip UART to normal mode. (Default value)
- ▶▶ IrDA Set onboard I/O chip UART to IrDA mode.
- ▶▶ ASKIR Set onboard I/O chip UART to ASKIR mode.

☞ **UR2 Duplex Mode**

This feature allows you to select IR mode.

This function will available when "UART Mode Select" doesn't set at Normal.

- ▶▶ Half IR Function Duplex Half. (Default value)
- ▶▶ Full IR Function Duplex Full.

☞ **Onboard Parallel port**

- ▶▶ Disabled Disable onboard LPT port.
- ▶▶ 378/IRQ7 Enable onboard LPT port and address is 378/IRQ7. (Default value)
- ▶▶ 278/IRQ5 Enable onboard LPT port and address is 278/IRQ5.
- ▶▶ 3BC/IRQ7 Enable onboard LPT port and address is 3BC/IRQ7.

☞ **Parallel Port Mode**

- ▶▶ SPP Using Parallel port as Standard Parallel Port.
- ▶▶ EPP1.9+SPP Using Parallel port as Enhanced Parallel Port 1.9 and SPP mode.
- ▶▶ ECP Using Parallel port as Extended Capabilities Port.
- ▶▶ EPP1.9+ECP Using Parallel port as Enhanced Parallel Port 1.9 and ECP mode.
- ▶▶ PRINTER Using Parallel port as printer port. (Default value)
- ▶▶ EPP1.7+SPP Using Parallel port as Enhanced Parallel Port 1.7 and SPP mode.
- ▶▶ EPP1.7+ECP Using Parallel port as Enhanced Parallel Port 1.7 and ECP mode.

☞ **ECP Mode Use DMA**

- ▶▶ 3 Set ECP Mode Use DMA to 3. (Default value)
- ▶▶ 1 Set ECP Mode Use DMA to 1.

2-4 Power Management Setup

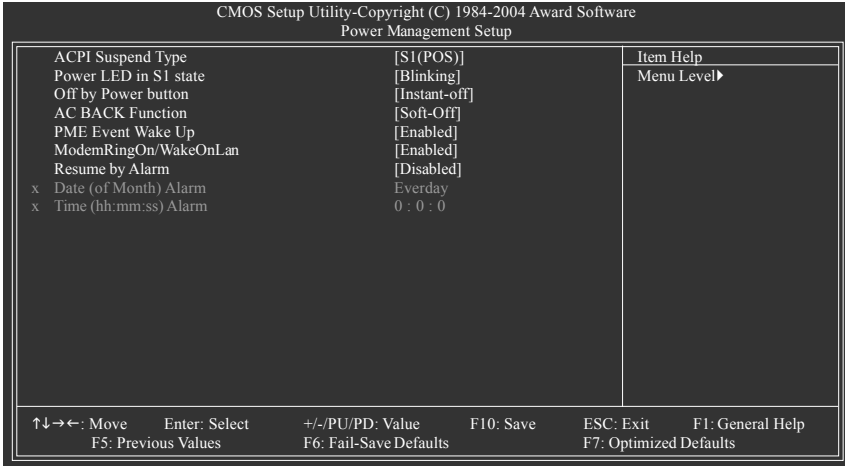

ACPI Suspend Type

- ▶▶ S1(POS) Set ACPI suspend type to S1/POS(Power On Suspend). (Default value)
- ▶▶ S3(STR) Set ACPI suspend type to S3/STR(Suspend To RAM).

Power LED in S1 state

- ▶▶ Blinking In standby mode(S1), poer LED will blink. (Default value)
- ▶▶ Dual/OFF In standby mode(S1):
 - a. If use single color LED, power LED will turn off.
 - b. If use dual color LED, power LED will turn to another color.

Off by Power button

- ▶▶ Instant-off Press power button then Power off instantly. (Default value)
- ▶▶ Delay 4 Sec. Press power button 4 sec. to Power off. Enter suspend if button is pressed less than 4 seconds.

AC Back Function

- ▶▶ Soft-Off When AC-power back to the system, the system will be in "Off" state. (Default value)
- ▶▶ Full-On When AC-power back to the system, the system always in "On" state.
- ▶▶ Memory When AC-power back to the system, the system will return to the Last state before AC-power off.

PME Event Wake Up

This feature requires an ATX power supply that provides at least 1A on the 5VSB lead.

- ▶▶ Disabled Disable this function.
- ▶▶ Enabled Enable PME as wake up event. (Default value)

ModemRingOn/WakeOnLan

An incoming call via modem can awake the system from any suspend state or an input signal comes from the other client server on the LAN can awake the system from any suspend state.

- ▶▶ Disabled Disable Modem Ring On / Wake On LAN function.
- ▶▶ Enabled Enable Modem Ring On / Wake On LAN function. (Default value)

☞ Resume by Alarm

You can set "Resume by Alarm" item to enabled and key in Date/Time to power on system.

- ▶▶ Disabled Disable this function. (Default value)
- ▶▶ Enabled Enable alarm function to POWER ON system.

If RTC Alarm Lead To Power On is Enabled.

- ▶▶ Date (of Month) Alarm : Everyday, 1~31
- ▶▶ Time (hh: mm: ss) Alarm : (0~23) : (0~59) : (0~59)

2-5 PnP/PCI Configurations

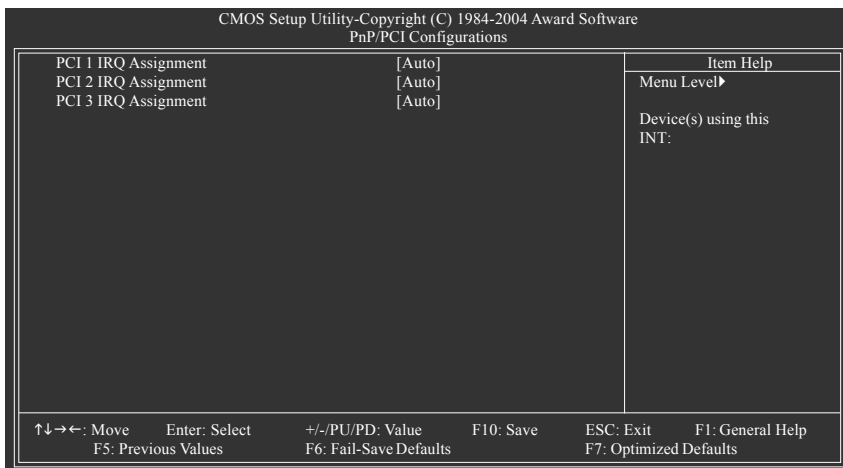

☞ PCI 1 IRQ Assignment

- ▶▶ Auto Auto assign IRQ to PCI 1. (Default value)
- ▶▶ 3,4,5,7,9,10,11,12,14,15 Set IRQ 3,4,5,7,9,10,11,12,14,15 to PCI 1/5.

☞ PCI 2 IRQ Assignment

- ▶▶ Auto Auto assign IRQ to PCI 2. (Default value)
- ▶▶ 3,4,5,7,9,10,11,12,14,15 Set IRQ 3,4,5,7,9,10,11,12,14,15 to PCI 2.

☞ PCI 3 IRQ Assignment

- ▶▶ Auto Auto assign IRQ to PCI 3. (Default value)
- ▶▶ 3,4,5,7,9,10,11,12,14,15 Set IRQ 3,4,5,7,9,10,11,12,14,15 to PCI 3.

2-6 PC Health Status

CMOS Setup Utility-Copyright (C) 1984-2004 Award Software		Item Help
PC Health Status		Menu Level▶
Current CPU Temperature	50°C	
Current System Temperature	32°C	
Vcore	1.35V	
+3.3V	3.28V	
+5V	5.17V	
+12V	11.84V	
DDR25V	2.39V	
Current CPU FAN Speed	3308 RPM	
Current SYSTEM FAN Speed	0 RPM	

↑↓→←: Move	Enter: Select	+/-/PU/PD: Value	F10: Save	ESC: Exit	F1: General Help
F5: Previous Values	F6: Fail-Save Defaults	F7: Optimized Defaults			

- ☞ **Current CPU/System Temperature**
 - ▶▶ Detect CPU/System temperature automatically.
- ☞ **Current Voltage(V) Vcore / +3.3V / +5V / +12V / DDR25V**
 - ▶▶ Detect system's voltage status automatically.
- ☞ **Current CPU/SYSTEM FAN Speed (RPM)**
 - ▶▶ Detect CPU/SYSTEM Fan speed status automatically.

2-7 Frequency/Voltage Control

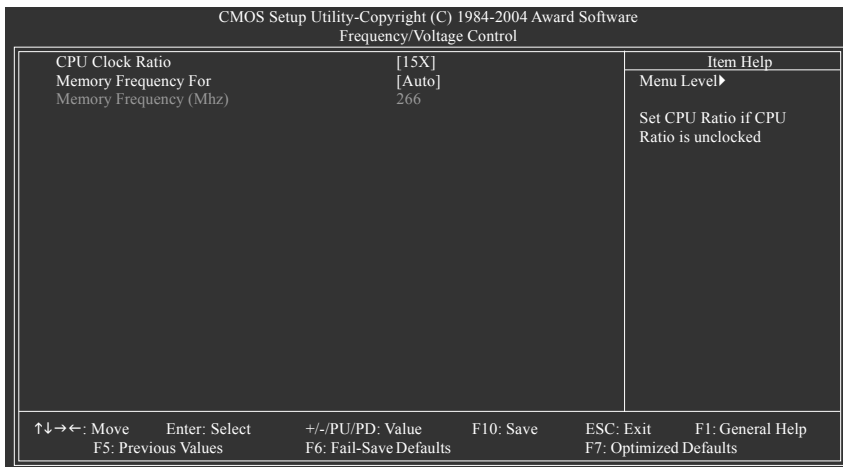

Incorrect using these features may cause your system broken. For power end-user use only.

☞ CPU Clock Ratio

This setup option will automatically assign by CPU detection.

The option will display "Locked" and read only if the CPU ratio is not changeable.

☞ Memory Frequency For

Wrong frequency may make system can't boot, clear CMOS to overcome wrong frequency issue.

for FSB(Front Side Bus) frequency=533MHz,

- ▶▶ 2.0 Memory Frequency = Host clock x 2.
- ▶▶ 2.5 Memory Frequency = Host clock x 2.5.
- ▶▶ Auto Set Memory frequency by DRAM SPD data. (Default value)

for FSB(Front Side Bus) frequency=800MHz,

- ▶▶ 1.33 Memory Frequency = Host clock x 1.33.
- ▶▶ 1.66 Memory Frequency = Host clock x 1.66.
- ▶▶ 2.0 Memory Frequency = Host clock x 2.
- ▶▶ Auto Set Memory frequency by DRAM SPD data. (Default value)

☞ Memory Frequency (Mhz)

The values depend on "Memory Frequency For" item.

2-8 Load Fail-Safe Defaults

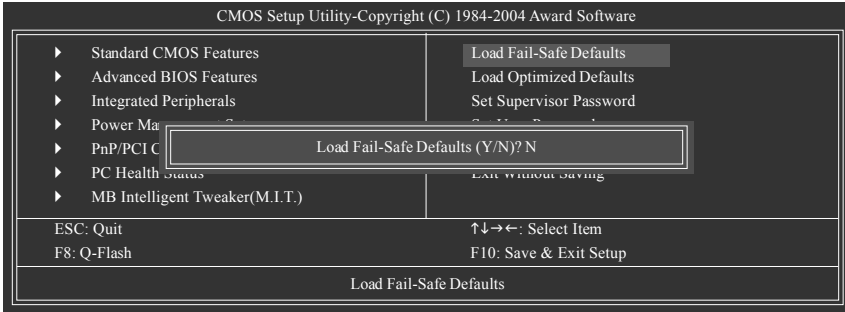

Fail-Safe defaults contain the most appropriate values of the system parameters that allow minimum system performance.

2-9 Load Optimized Defaults

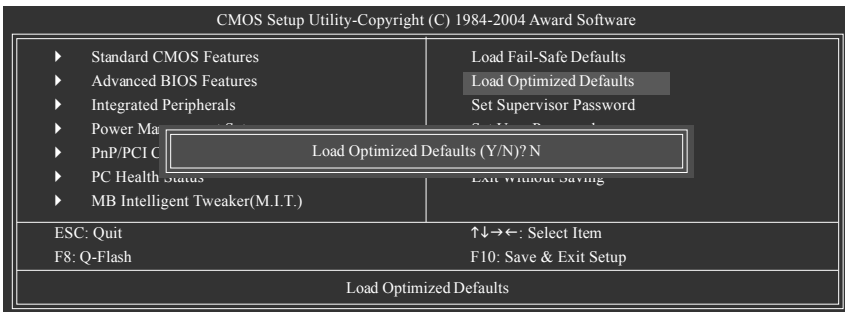

Selecting this field loads the factory defaults for BIOS and Chipset Features which the system automatically detects.

2-10 Set Supervisor/User Password

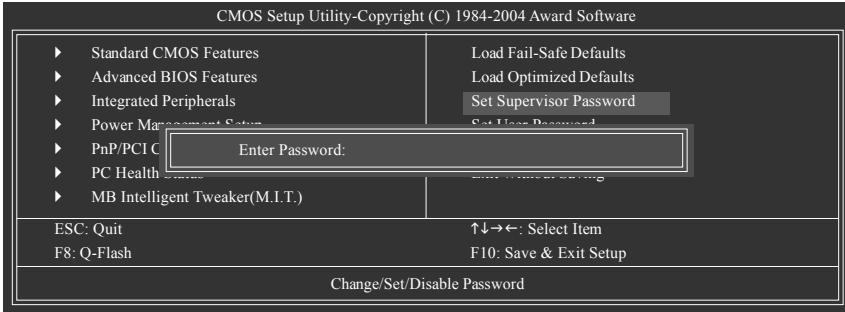

Selecting this field loads the factory defaults for BIOS and Chipset Features which the system automatically detects.

When you select this function, the following message will appear at the center of the screen to assist you in creating a password.

Type the password, up to eight characters, and press <Enter>. You will be asked to confirm the password. Type the password again and press <Enter>. You may also press <Esc> to abort the selection and not enter a password.

To disable password, just press <Enter> when you are prompted to enter password. A message "PASSWORD DISABLED" will appear to confirm the password being disabled. Once the password is disabled, the system will boot and you can enter Setup freely.

The BIOS Setup program allows you to specify two separate passwords:

SUPERVISOR PASSWORD and a USER PASSWORD. When disabled, anyone may access all BIOS Setup program function. When enabled, the Supervisor password is required for entering the BIOS Setup program and having full configuration fields, the User password is required to access only basic items.

If you select "System" at "Password Check" in Advance BIOS Features Menu, you will be prompted for the password every time the system is rebooted or any time you try to enter Setup Menu.

If you select "Setup" at "Password Check" in Advance BIOS Features Menu, you will be prompted only when you try to enter Setup.

2-11 Save & Exit Setup

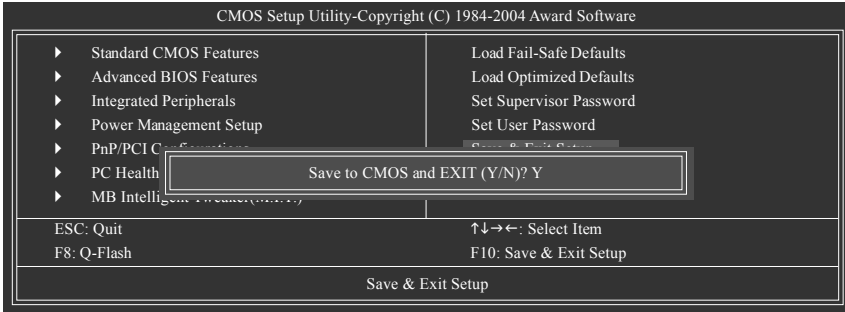

Type "Y" will quit the Setup Utility and save the user setup value to RTC CMOS.
Type "N" will return to Setup Utility.

2-12 Exit Without Saving

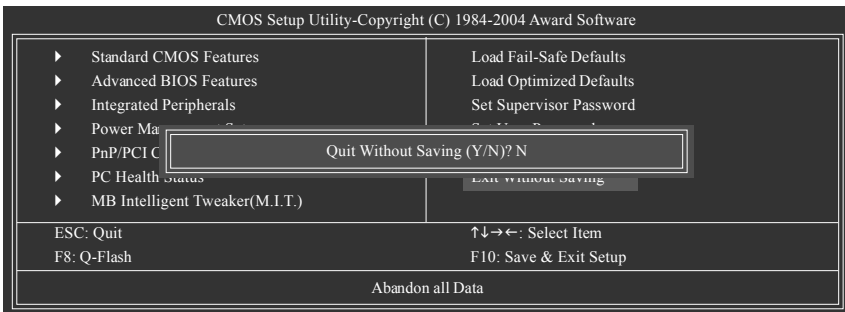

Type "Y" will quit the Setup Utility without saving to RTC CMOS.
Type "N" will return to Setup Utility.

Chapter 3 Drivers Installation



Pictures below are shown in Windows XP.

Insert the driver CD-title that came with your motherboard into your CD-ROM drive, the driver CD-title will auto start and show the installation guide. If not, please double click the CD-ROM device icon in "My computer", and execute the Run.exe.

3-1 Install Chipset Drivers

After insert the driver CD, "Xpress Install" will scan automatically the system and then list all the drivers that recommended to install. The "Xpress Install" uses the "Click and Go" technology to install the drivers automatically. Just select the drivers you want then click the "GO" button. The will execute the installation for you automatically.

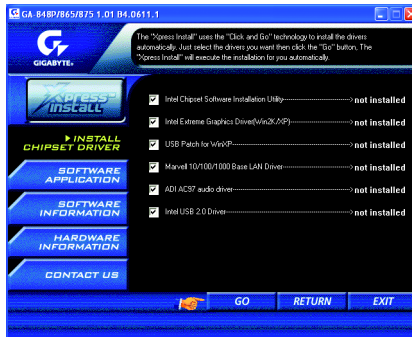

Some device drivers will restart your system automatically. After restarting your system the "Xpress Install" will continue to install other drivers.

System will reboot automatically after install the drivers, afterward you can install others application.



For USB2.0 driver support under Windows XP operating system, please use Windows Service Pack. After install Windows Service Pack, it will show a question mark "?" in "Universal Serial Bus controller" under "Device Manager". Please remove the question mark and restart the system (System will auto-detect the right USB2.0 driver).

3-2 Software Application

This page displays all the tools that Gigabyte developed and some free software, you can choose anyone you want and press "install" to install them.

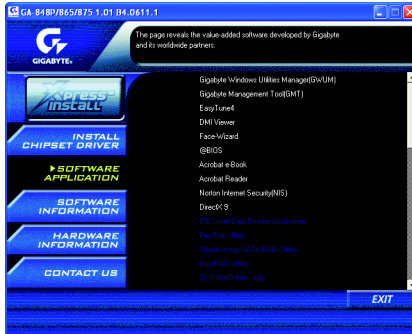

3-3 Software Information

This page lists the contents of software and drivers in this CD-title.

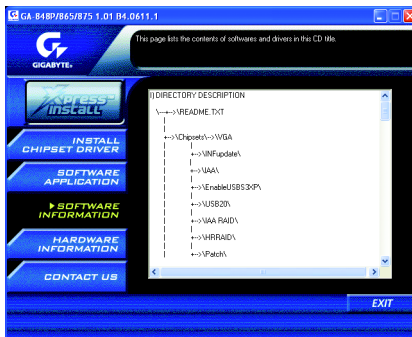

3-4 Hardware Information

This page lists all device you have for this motherboard.

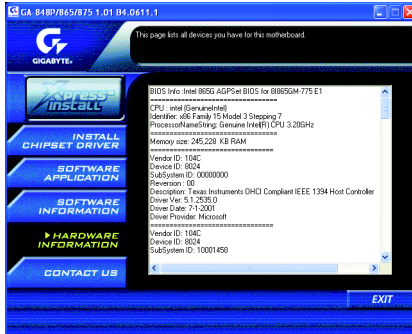

3-5 Contact Us

Please see the last page for details.



Chapter 4 Appendix

4-1 Unique Software Utilities

4-1-1 Xpress Recovery Introduction



What is Xpress Recovery ?

Xpress Recovery is a utility used to back up and restore an OS partition. If the hard drive is not working properly, the user can restore the drive to its original state.



1. Supports FAT16, FAT32, and NTFS formats
2. Must be connected to the IDE1 Master
3. Allows installation of only one OS
4. Must be used with an IDE hard disk supporting HPA
5. The first partition must be set as the boot partition. When the boot partition is backed up, please do not alter its size.
6. Xpress Recovery is recommended when using Ghost to return boot manager to NTFS format.

How to use the Xpress Recovery

1. Boot from CD-ROM (BMP Mode)

Enter the BIOS menu, select "Advanced BIOS Feature" and set to boot from CD-ROM. Insert the provided driver CD into your CD drive, then save and exit the BIOS menu. Once the computer has restarted, the phrase "Boot from CD:" will appear at the bottom left-hand corner of the screen. When "Boot from CD:" appears, press any key to enter Xpress Recovery.

Once you have completed this step, subsequent access to Xpress Recovery can also function by pressing the F9 key during computer power on.



Boot from CD:

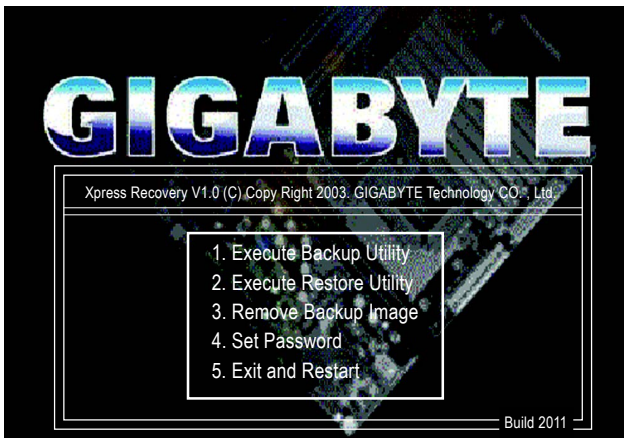

2. Press F9 during powering on the computer. (Text Mode)
Press F9 during powering on the computer .

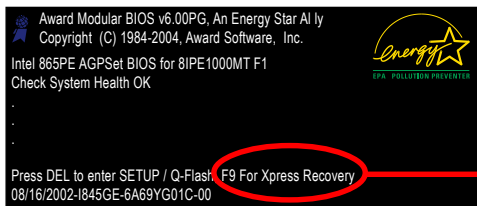

F9 For Xpress Recovery

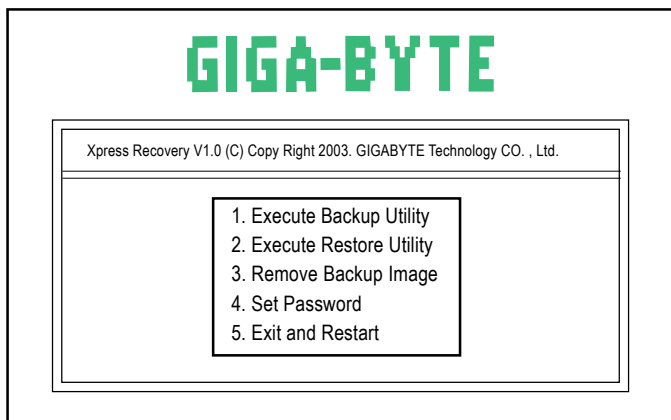

1. If you have already entered Xpress Recovery by booting from the CD-ROM, you can enter Xpress Recovery in the future by pressing the F9 key.
2. System storage capacity as well as drive reading/writing speed will affect backup speed.
3. It is recommended that Xpress Recovery be immediately installed after OS and all required driver and software installations are complete.

1. Execute Backup Utility:

Press B to Backup your System or Esc to Exit

The backup utility will automatically scan your system and back up data as a backup image in your hard drive.



Not all systems support access to Xpress Recovery by pressing the F9 key during computer power on. If this is the case, please use the boot from CD-ROM method to enter Xpress Recovery.

2. Execute Restore Utility:

This program will recover your system to factory default.

Press R to restore your system back to factory default or press Esc to exit

Restores backup image to original state.

3. Remove Backup Image:

Remove backup image. Are you sure? (Y/N)

Remove the backup image.

4. Set Password:

Please input a 4-16 character long password (a-z or 0-9) or press Esc to exit

You can set a password to enter Xpress Recovery to protect your hard disk data. Once this is done, password input will be required to enter Xpress Recovery during the next as well as subsequent system restarts. If you wish to remove the need for password entry, please select "Set Password" and under "New Password/Confirm Password", make sure there is no entry and then press "Enter" to remove password requirement.

5. Exit and Restart:

Exit and restart your computer.

4-1-2 Flash BIOS Method Introduction



Method 1 : Q-Flash™ Utility

Q-Flash™ is a BIOS flash utility embedded in Flash ROM. With this utility, users only have to stay in the BIOS menu when they want to update BIOS. Q-Flash™ allows users to flash BIOS without any utility in DOS or

Windows. Using Q-Flash™ indicating no more fooling around with any complicated instructions and operating system since it is in the BIOS menu.



Please note that because updating BIOS has potential risk, please do it with caution!! We are sorry that Gigabyte Technology Co., Ltd is not responsible for damages of system because of incorrect manipulation of updating BIOS to avoid any claims from end-users.

Before You Begin:

Before you start updating BIOS with the Q-Flash™ utility, please follow the steps below first.

1. Download the latest BIOS for your motherboard from Gigabyte's website.
2. Extract the BIOS file downloaded and save the BIOS file (the one with model name.Fxx. For example, 8KNXPJ.Fba) to a floppy disk.
3. Reboot your PC and press **Del** to enter BIOS menu.

The BIOS upgrading guides below are separated into two parts.

If your motherboard has dual-BIOS, please refer to **Part One**.

If your motherboard has single-BIOS, please refer to **Part Two**.

Part One:

Updating BIOS with Q-Flash™ Utility on Dual BIOS Motherboards.

Some of Gigabyte motherboards are equipped with dual BIOS. In the BIOS menu of the motherboards supporting Q-Flash and Dual BIOS, the Q-Flash utility and Dual BIOS utility are combined in the same screen. This section only deals with how to use Q-Flash utility.

In the following sections, we take GA-8KNXP Ultra as the example to guide you how to flash BIOS from an older version to the latest version. For example, from Fa3 to Fba.

The BIOS file is Fa3
before updating

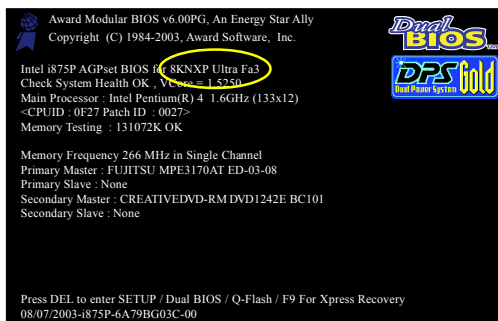

Entering the Q-Flash™ utility:

Step1: To use Q-Flash utility, you must press **Del** in the boot screen to enter BIOS menu.

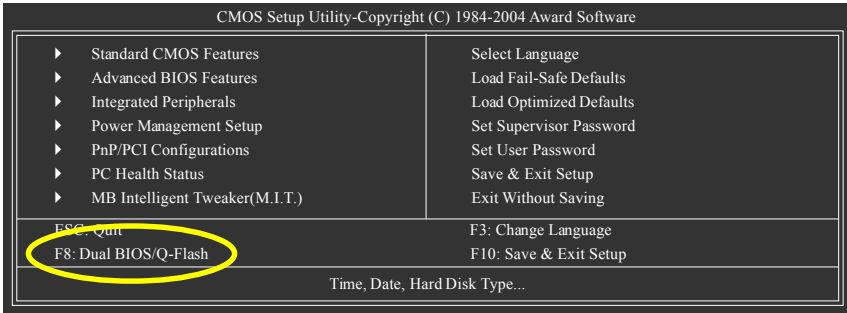

Step 2: Press **F8** button on your keyboard and then **Y** button to enter the Dual BIOS/Q-Flash utility.

Exploring the Q-Flash™ / Dual BIOS utility screen

The Q-Flash / Dual BIOS utility screen consists of the following key components.

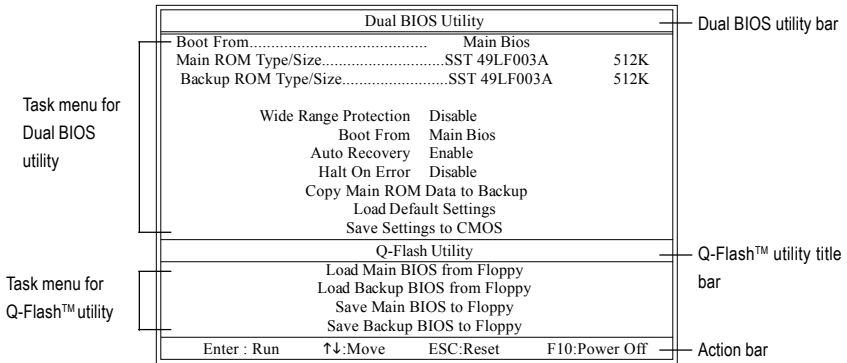

Task menu for Dual BIOS utility:

Contains the names of eight tasks and two item showing information about the BIOS ROM type. Blocking a task and pressing Enter key on your keyboard to enable execution of the task.

Task menu for Q-Flash utility:

Contains the names of four tasks. Blocking a task and pressing Enter key on your keyboard to enable execution of the task.

Action bar:

Contains the names of four actions needed to operate the Q-Flash/Dual BIOS utility. Pressing the buttons mentioned on your keyboards to perform these actions.

- Press Y button on your keyboard after you are sure to update BIOS.
Then it will begin to update BIOS. The progress of updating BIOS will be displayed.



Please do not take out the floppy disk when it begins flashing BIOS.

- Press any keys to return to the Q-Flash menu when the BIOS updating procedure is completed.

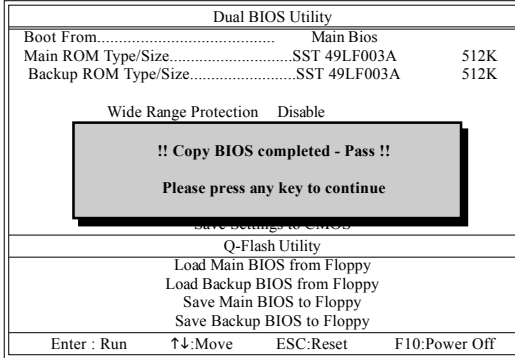

You can repeat Step 1 to 4 to flash the backup BIOS, too.

- Press Esc and then Y button to exit the Q-Flash utility. The computer will restart automatically after you exit Q-Flash.

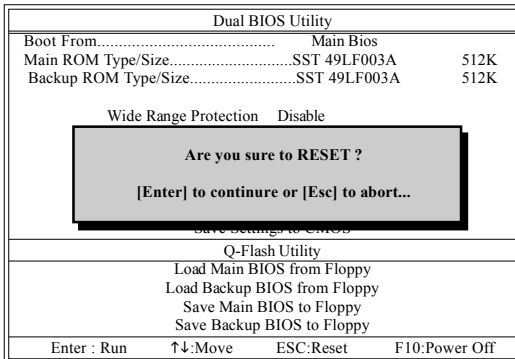

After system reboots, you may find the BIOS version on your boot screen becomes the one you flashed.

The BIOS file becomes Fba after updating.

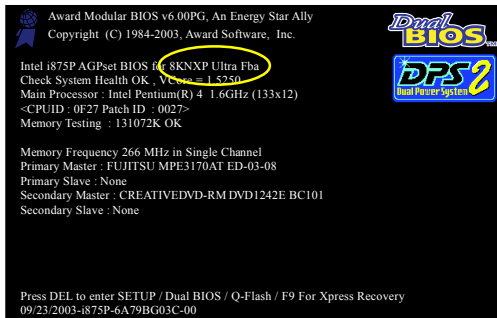

6. Press **Del** to enter BIOS menu after system reboots. When you are in BIOS menu, move to **Load Fail-Safe Defaults** item and press **Enter** to load BIOS Fail-Safe Defaults. Normally the system redetects all devices after BIOS has been upgraded. Therefore, we highly recommend reloading the BIOS defaults after BIOS has been upgraded.

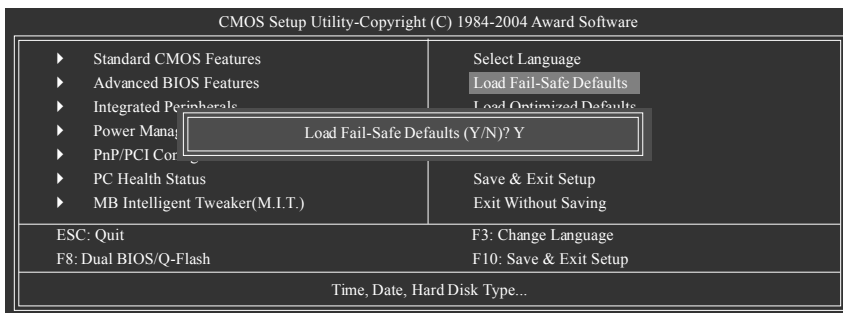

Press **Y** on your keyboard to load defaults.

7. Select **Save & Exit Setup** item to save the settings to CMOS and exit the BIOS menu. System will reboot after you exit the BIOS menu. The procedure is completed.

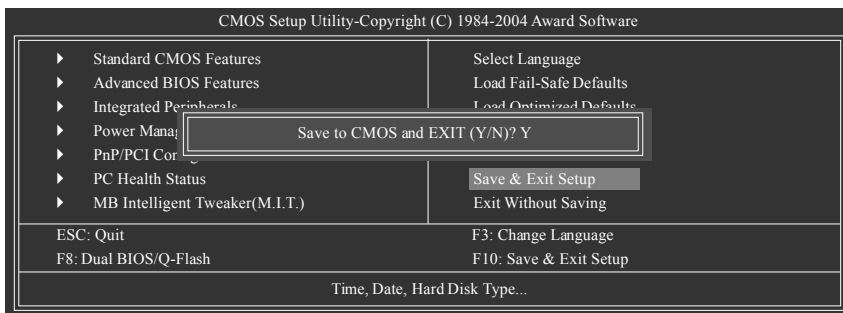

Press **Y** on your keyboard to save and exit.

Part Two:

Updating BIOS with Q-Flash™ Utility on Single-BIOS Motherboards.

This part guides users of single-BIOS motherboards how to update BIOS using the Q-Flash™ utility.

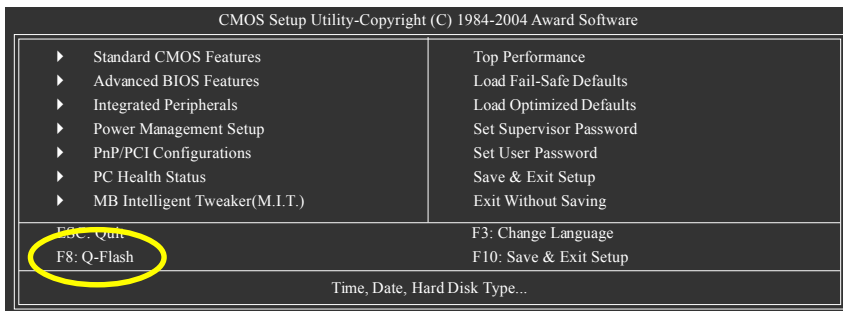

- Press Y button on your keyboard after you are sure to update BIOS.
Then it will begin to update BIOS. The progress of updating BIOS will be shown at the same time.

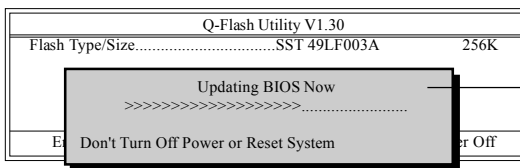

Do not turn off power or reset your system at this stage!!

- Press any keys to return to the Q-Flash menu when the BIOS updating procedure is completed.

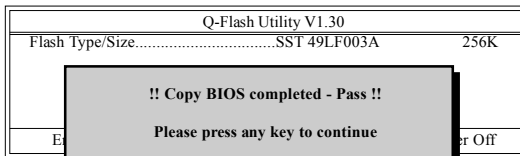

- Press Esc and then Y button to exit the Q-Flash utility. The computer will restart automatically after you exit Q-Flash.

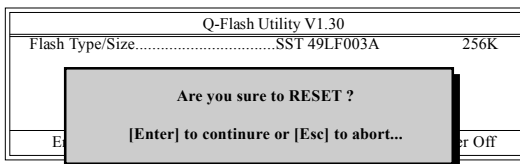

After system reboots, you may find the BIOS version on your boot screen becomes the one you flashed.

The BIOS file becomes F4 after updating

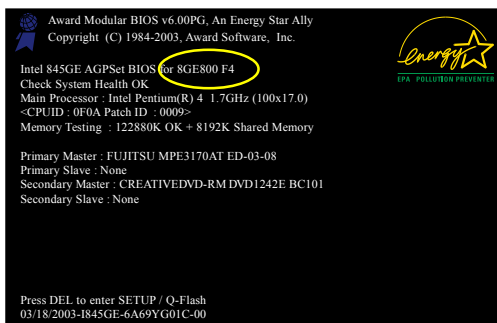

- Press Del to enter BIOS menu after system reboots and "Load BIOS Fail-Safe Defaults". See how to Load BIOS Fail-Safe Defaults, please kindly refer to Step 6 to 7 in **Part One**.

Congratulation!! You have updated BIOS successfully!!

Method 2 : @BIOS™ Utility

If you do not have a DOS startup disk, we recommend that you use the new @BIOS utility. @BIOS allows users to update their BIOS under Windows. Just select the desired @BIOS server to download the latest version of BIOS.

Fig 1. Installing the @BIOS utility

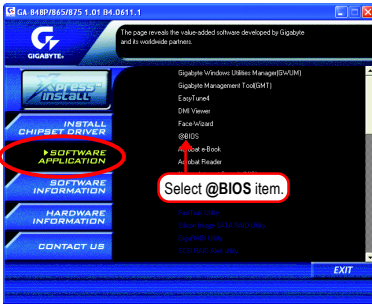

Fig 2. Installation complete and run @BIOS

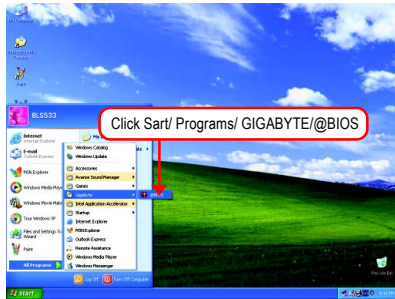

Fig 3. The @BIOS utility

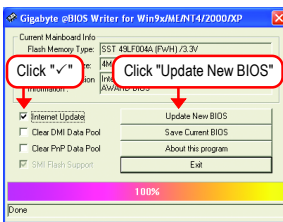

Fig 4. Select the desired @BIOS server



1. Methods and steps:

I. Update BIOS through Internet

- Click "Internet Update" icon
- Click "Update New BIOS" icon
- Select @BIOS™ sever
- Select the exact model name on your motherboard
- System will automatically download and update the BIOS.

II. Update BIOS NOT through Internet:

- Do not click "Internet Update" icon
- Click "Update New BIOS"
- Please select "All Files" in dialog box while opening the old file.
- Please search for BIOS unzip file, downloading from internet or any other methods (such as: 865GM775.E4).
- Complete update process following the instruction.

III. Save BIOS

In the very beginning, there is "Save Current BIOS" icon shown in dialog box. It means to save the current BIOS version.

IV. Check out supported motherboard and Flash ROM:

In the very beginning, there is "About this program" icon shown in dialog box. It can help you check out which kind of motherboard and which brand of Flash ROM are supported.

2. Note:

- I. In method I, if it shows two or more motherboard's model names to be selected, please make sure your motherboard's model name again. Selecting wrong model name will cause the system unbooted.
- II. In method II, be sure that motherboard's model name in BIOS unzip file are the same as your motherboard's. Otherwise, your system won't boot.
- III. In method I, if the BIOS file you need cannot be found in @BIOS™ server, please go onto Gigabyte's web site for downloading and updating it according to method II.
- IV. Please note that any interruption during updating will cause system unbooted

4-1-3 2-/4-/5.1- Channel Audio Function Introduction

You are able to use 2-/4-/6-channels audio feature by audio software selection.

The installation of audio software for Windows 98/ 2000/ ME/ XP is very simple. Please follow the steps to install the function. (Following pictures are in Windows XP)

Stereo Speakers Connection and Settings:

We recommend that you use the speaker with amplifier to acquire the best sound effect if the stereo output is applied.

STEP 1:

Connect the stereo speakers or earphone to "Line Out".

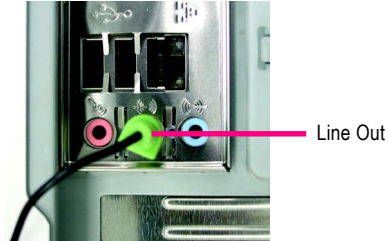

STEP 2:

After you install the audio driver, you will find the "SoundMAX Control Panel" icon in the status area on the lower right of the screen. Right-click the icon to select "SoundMAX Control Panel" or "Preferences".

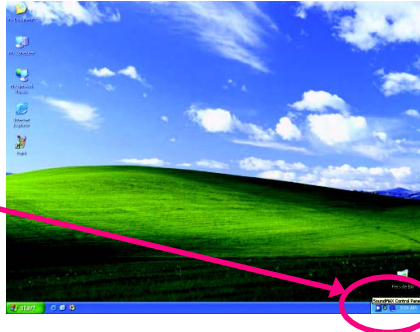

STEP 3:

On the "Preferences" menu, click the "Listening Environment" tab. In the "Speaker Setup" box, click "Stereo Headphones" or "Stereo Speakers" and then click "Apply". You will find a headphone or stereo speakers icon on the SoundMAX menu. This completes the headphone or stereo speakers setup.

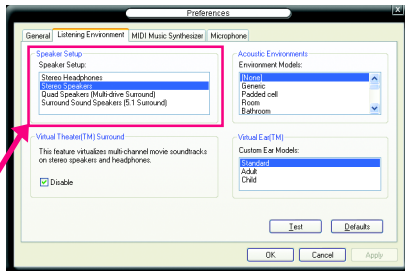

4 Channel Audio Setup

STEP 1 :

Connect the Front Speakers to "Line Out", the Rear Speakers to "Line In".

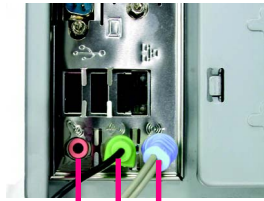

Line In (Rear Speaker Out)
Line Out (Front Speaker Out)
Mic In

STEP 2 :

After you install the audio driver, you will find the "SoundMAX Control Panel" icon  in the status area on the lower right of the screen. Right-click the icon to select "SoundMAX Control Panel" or "Preferences".

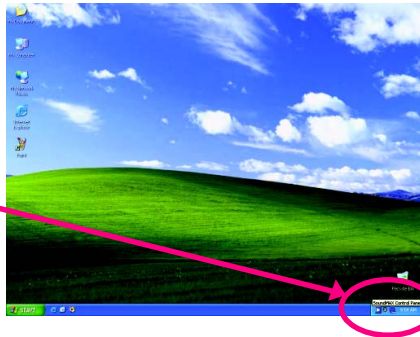

STEP 3:

On the "Preferences" menu, click the "Listening Environment" tab. In the "Speaker Setup" box, click "Multi-drive" and then click "Apply". You will find a multi-driver icon on the SoundMAX menu. This completes the 4-channel audio configuration.

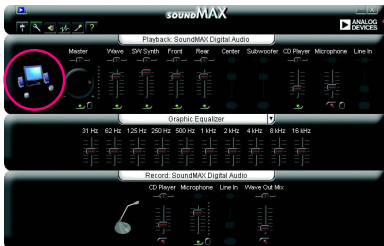
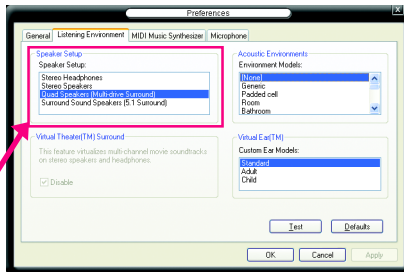

5.1 Channel Audio Setup

STEP 1 :

Connect the Front Speakers to "Line Out", the Surround Speakers to "Line In", and the Center/Subwoofer Speakers to "MIC In".



Line In (Surround Speaker Out)
 Line Out (Front Speaker Out)
 Mic In (Center/Subwoofer Speaker Out)

STEP 2 :

After you install the audio driver, you will find the "SoundMAX Control Panel" icon  in the status area on the lower right of the screen. Right-click the icon to select "SoundMAX Control Panel" or "Preferences".

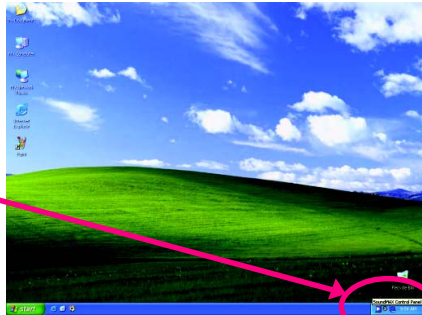

STEP 3:

On the "Preferences" menu, click the "Listening Environment" tab. In the "Speaker Setup" box, click "Surround Sound Speakers (5.1 Surround)" and then click "Apply". You will find a surround sound speakers icon on the SoundMAX menu. This completes the 5.1 channel audio configuration.

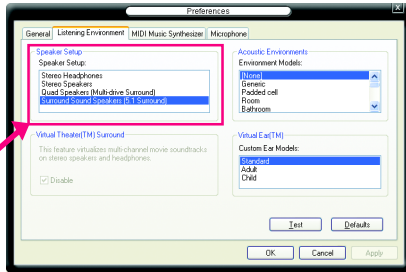

Sound Effect Configuration:

At the "Acoustic Environments" menu, users can adjust sound option settings as desired.

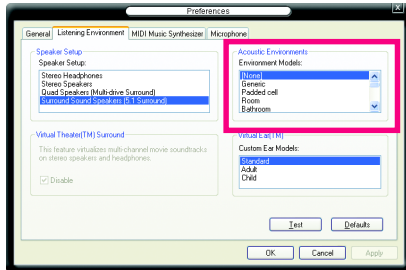

SPDIF Output Device (Optional Device)

A "S/PDIF output" device is available on the motherboard. Cable with rear bracket is provided and could link to the "S/PDIF output" connector (As picture.) For the further linkage to decoder, rear bracket provides coaxial cable and Fiber connecting port.

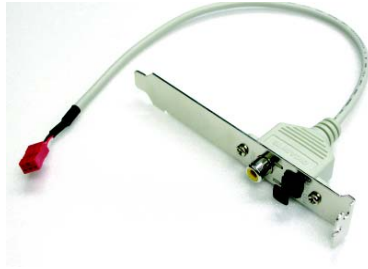

1. Connect the SPDIF output device to the rear bracket of PC, and fix it with screw.

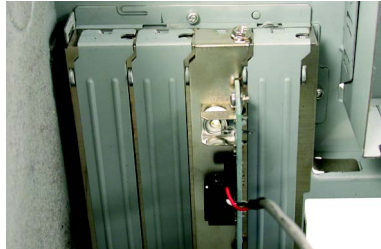

2. Connect SPDIF wire to the motherboard.

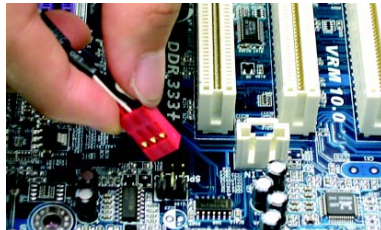

3. Connect co-axial or optical output to the AC3 decoder.



4-2 Troubleshooting

Below is a collection of general asked questions. To check general asked questions based on a specific motherboard model, please log on to <http://tw.giga-byte.com/faq/faq.htm>

Question 1: I cannot see some options that were included in previous BIOS after updating BIOS. Why?

Answer: Some advanced options are hidden in new BIOS version. Please press Ctrl and F1 keys after entering BIOS menu and you will be able to see these options.

Questions 2: Why is the light of my keyboard/optical mouse still on after computer shuts down?

Answer: In some boards, a small amount of electricity is kept on standby after computer shuts down and that's why the light is still on.

Question 3: Why cannot I use all functions in EasyTune 4?

Answer: The availability of the listed functions in EasyTune 4 depends on the MB chipset. If the chipset doesn't support certain functions in EasyTune 4, these functions will be locked automatically and you will not be able to use them.

Question 4: Why do I fail to install RAID and ATA drivers under Win 2000 and XP on boards that support RAID function after I connect the boot HDD to IDE3 or IDE4 ?

Answer: First of all, you need to save some files in the CD-ROM to a floppy disk before installing drivers. You also need to go through some rather different steps in the installation process. Therefore, we suggest that you refer to the installation steps in the RAID manual at our website.

(Please download it at http://tw.giga-byte.com/support/user_pdf/raid_manual.pdf)

Question 5: How do I clear CMOS?

Answer: If your board has a Clear CMOS jumper, please refer to the Clear CMOS steps in the manual. If your board doesn't have such jumper, you can take off the on-board battery to leak voltage to clear CMOS. Please refer to the steps below:

Steps:

1. Turn off power.
2. Disconnect the power cord from MB.
3. Take out the battery gently and put it aside for about 10 minutes (Or you can use a metal object to connect the positive and negative pins in the battery holder to makethem short for one minute).
4. Re-insert the battery to the battery holder.
5. Connect power cord to MB again and turn on power.
6. Press Del to enter BIOS and load Fail-Safe Defaults.
7. Save changes and reboot the system.

Question 6: Why does system seem unstable after updating BIOS?

Answer: Please remember to load Fail-Safe Defaults (Or Load BIOS Defaults) after flashing BIOS. However, if the system instability still remains, please clear CMOS to solve the problem.

Question 7: Why do I still get a weak sound after turning up the speaker to the maximum volume?

Answer: Please make sure the speaker you are using is equipped with an internal amplifier. If not, please change another speaker with power/amplifier and try again later.

Question 8: How do I disable onboard VGA card in order to add an external VGA card?

Answer: Gigabyte motherboards will auto-detect the external VGA card after it is plugged in, so you don't need to change any setting manually to disable the onboard VGA.

Question 9: Why cannot I use the IDE 2?

Answer: Please refer to the user manual and check whether you have connected any cable that is not provided with the motherboard package to the USB Over Current pin in the Front USB Panel. If the cable is your own cable, please remove it from this pin and do not connect any of your own cables to it.

Question 10: Sometimes I hear different continuous beeps from computer after system boots up. What do these beeps usually stand for?

Answer: The beep codes below may help you identify the possible computer problems. However, they are only for reference purposes. The situations might differ from case to case.

→ AMI BIOS Beep Codes

*Computer gives 1 short beep when system boots successfully.

*Except for beep code 8, these codes are always fatal.

- 1 beep Refresh failure
- 2 beeps Parity error
- 3 beeps Base 64K memory failure
- 4 beeps Timer not operational
- 5 beeps Processor error
- 6 beeps 8042 - gate A20 failure
- 7 beeps Processor exception interrupt error
- 8 beeps Display memory read/write failure
- 9 beeps ROM checksum error
- 10 beeps CMOS shutdown register read/write error
- 11 beeps Cache memory bad

→ AWARD BIOS Beep Codes

- 1 short: System boots successfully
- 2 short: CMOS setting error
- 1 long 1 short: DRAM or M/B error
- 1 long 2 short: Monitor or display card error
- 1 long 3 short: Keyboard error
- 1 long 9 short: BIOS ROM error
- Continuous long beeps: DRAM error
- Continuous short beeps: Power error

Question 11: For the M/B which have RAID function, how to set in the BIOS in order to bootup from IDE3, 4 by either RAID or ATA mode?

Answer: Please set in the BIOS as follow:

1. Advanced BIOS features-->(SATA)/RAID/SCSI boot order: "SATA"
2. Advanced BIOS features--> First boot device: "SCSI"
3. Integrated Peripherals--> Onboard H/W ATA/RAID: "enable"

Then it depends on the RAID mode that you need to set "RAID" to RAID mode or "ATA" to normal ATA mode in the item named RAID controller function.

Question 12: How to set in the BIOS to bootup from the IDE/ SCSI/ RAID card ?

Answer: Please set in the BIOS as follow:

1. Advanced BIOS features-->(SATA)/RAID/SCSI boot order: "SCSI"
2. Advanced BIOS features--> First boot device: "SCSI"

Then it depends on the mode(RAID or ATA) that you need to set in RAID/ SCSI BIOS.



Contact Us

● Taiwan (Headquarters)

GIGA-BYTE TECHNOLOGY CO., LTD.

Address: No.6, Bau Chiang Road, Hsin-Tien, Taipei Hsien, Taiwan.

TEL: +886 (2) 8912-4888

FAX: +886 (2) 8912-4003

Tech. Support :

<http://tw.giga-byte.com/TechSupport/ServiceCenter.htm>

Non-Tech. Support(Sales/Marketing) :

<http://ggts.gigabyte.com.tw/nontech.asp>

WEB address (English): <http://www.gigabyte.com.tw>

WEB address (Chinese): <http://chinese.giga-byte.com>

● U.S.A.

G.B.T. INC.

Address: 17358 Railroad St, City of Industry, CA 91748.

TEL: +1 (626) 854-9338

FAX: +1 (626) 854-9339

Tech. Support :

<http://www.giga-byte.com/TechSupport/ServiceCenter.htm>

Non-Tech. Support(Sales/Marketing) :

<http://ggts.gigabyte.com.tw/nontech.asp>

WEB address : <http://www.giga-byte.com>

● Germany

G.B.T. TECHNOLOGY TRADING GMBH

Address: Friedrich-Ebert-Damm 112 22047 Hamburg

TEL: +49-40-2533040 (Sales)

+49-1803-428468 (Tech.)

TEL: +49-40-25492343 (Sales)

+49-1803-428329 (Tech.)

Tech. Support :

<http://de.giga-byte.com/TechSupport/ServiceCenter.htm>

Non-Tech. Support(Sales/Marketing) :

<http://ggts.gigabyte.com.tw/nontech.asp>

WEB address : <http://www.gigabyte.de>

● Japan

NIPPON GIGA-BYTE CORPORATION

WEB address : <http://www.gigabyte.co.jp>

● Singapore

GIGA-BYTE SINGAPORE PTE. LTD.

Tech. Support :

<http://tw.giga-byte.com/TechSupport/ServiceCenter.htm>

Non-Tech. Support(Sales/Marketing) :

<http://ggts.gigabyte.com.tw/nontech.asp>

● U.K.

G.B.T. TECH. CO., LTD.

Address: GUnit 13 Avant Business Centre 3 Third Avenue, Denbigh West Bleckley Milton Keynes, MK1 1DR, UK, England

TEL: +44-1908-362700

FAX: +44-1908-362709

Tech. Support :

<http://uk.giga-byte.com/TechSupport/ServiceCenter.htm>

Non-Tech. Support(Sales/Marketing) :

<http://ggts.gigabyte.com.tw/nontech.asp>

WEB address : <http://uk.giga-byte.com>

● The Netherlands

GIGA-BYTE TECHNOLOGY B.V.

TEL: +31 40 290 2088

NL Tech.Support: 0900-GIGABYTE (0900-44422983)

BE Tech.Support: 0900-84034

FAX: +31 40 290 2089

Tech. Support :

<http://nz.giga-byte.com/TechSupport/ServiceCenter.htm>

Non-Tech. Support(Sales/Marketing) :

<http://ggts.gigabyte.com.tw/nontech.asp>

WEB address : <http://www.giga-byte.nl>

- **China**

NINGBO G.B.T. TECH. TRADING CO., LTD.

Tech. Support :

<http://cn.giga-byte.com/TechSupport/ServiceCenter.htm>

Non-Tech. Support(Sales/Marketing) :

<http://ggts.gigabyte.com.tw/nontech.asp>

WEB address : <http://www.gigabyte.com.cn>

Shanghai

TEL: +86-021-63410999

FAX: +86-021-63410100

Beijing

TEL: +86-010-82886651

FAX: +86-010-82888013

Wuhan

TEL: +86-027-87851061

FAX: +86-027-87851330

GuangZhou

TEL: +86-020-87586074

FAX: +86-020-85517843

Chengdu

TEL: +86-028-85236930

FAX: +86-028-85256822

Xian

TEL: +86-029-85531943

FAX: +86-029-85539821

Shenyang

TEL: +86-024-23960918

FAX: +86-024-23960918-809

- **Australia**

GIGABYTE TECHNOLOGY PTY. LTD.

Address: 3/6 Garden Road, Clayton, VIC 3168 Australia

TEL: +61 3 85616288

FAX: +61 3 85616222

Tech. Support :

<http://www.giga-byte.com.au/TechSupport/ServiceCenter.htm>

Non-Tech. Support(Sales/Marketing) :

<http://ggts.gigabyte.com.tw/nontech.asp>

WEB address : <http://www.giga-byte.com.au>

- **France**

GIGABYTE TECHNOLOGY FRANCES S.A.R.L.

Tech. Support :

<http://tw.giga-byte.com/TechSupport/ServiceCenter.htm>

Non-Tech. Support(Sales/Marketing) :

<http://ggts.gigabyte.com.tw/nontech.asp>

WEB address : <http://www.gigabyte.fr>

- **Russia**

Moscow Representative Office Of Giga-Byte Technology Co., Ltd.

Tech. Support :

<http://tw.giga-byte.com/TechSupport/ServiceCenter.htm>

Non-Tech. Support(Sales/Marketing) :

<http://ggts.gigabyte.com.tw/nontech.asp>

WEB address : <http://www.gigabyte.ru>

- **Poland**

Representative Office Of Giga-Byte Technology Co., Ltd.

POLAND

Tech. Support :

<http://tw.giga-byte.com/TechSupport/ServiceCenter.htm>

Non-Tech. Support(Sales/Marketing) :

<http://ggts.gigabyte.com.tw/nontech.asp>

WEB address : <http://www.gigabyte.pl>
