

GA-8AENXP-D

Intel® Pentium® 4 LGA775 Processor Motherboard

User's Manual

Rev. 1004

12ME-8AENXP-D-1004

Declaration of Conformity

Von: Hersteller/Importeur
(in all accents)

G.B.T. Technology Trading GmbH
Aussenlagerstr. 12, 70372 Stuttgart, Germany

(description of the apparatus, system, installation to which it refers)

Motherboard

GA-8AENXP-D

(reference to the specification under which conformity is declared)
is in conformity with
in accordance with 90/269 EEC-EMC Directive

- | | | | |
|--|---|--|---|
| <input type="checkbox"/> EN 55011 | Limits and methods of measurement of radio disturbance characteristics of industrial, scientific and medical (ISM) High frequency equipment | <input checked="" type="checkbox"/> EN 61000-3-2 | Disturbances in supply systems caused by harmonics in supply systems caused by household appliances and similar electrical equipment "Voltage fluctuations" |
| <input type="checkbox"/> EN 55013 | Limits and methods of measurement of radio disturbance characteristics of equipment | <input checked="" type="checkbox"/> EN 55024 | Information Technology equipment/Immunity equipment/Immunity measurement |
| <input checked="" type="checkbox"/> EN 55014-1 | Limits and methods of measurement of radio disturbance characteristics of portable tools and similar electrical apparatus | <input type="checkbox"/> EN 60082-1 | Generic immunity standard Part 1: Residential, commercial and light industry |
| <input type="checkbox"/> EN 55015 | Limits and methods of measurement of radio disturbance characteristics of telecontrol systems and terminals | <input type="checkbox"/> EN 55082-2 | Generic immunity standard Part 2: Industrial environment |
| <input type="checkbox"/> EN 55020 | Immunity from radio interference of broadcast receivers and associated equipment | <input type="checkbox"/> EN 55014-2 | Immunity requirements for household appliances tools and similar apparatus |
| <input checked="" type="checkbox"/> EN 55022 | Limits and methods of measurement of radio disturbance characteristics of information technology equipment | <input type="checkbox"/> EN 55011-2 | EMC requirements for unshieldable power systems (UPS) |
| <input type="checkbox"/> DIN VDE 0855 | Cable distribution systems, Equipment for data processing systems, from Part 12 | | |
| <input type="checkbox"/> Part 12 | Sound and television signals | | |

CE marking



(EC conformity marking)

The manufacturer also declares the conformity of above mentioned product with the safety requirements in accordance with LVD 7023 EEC

- | | | | |
|-----------------------------------|---|-------------------------------------|---|
| <input type="checkbox"/> EN 60065 | Safety requirements for mains operated electrical apparatus for household and similar general use | <input type="checkbox"/> EN 60950 | Safety for information technology equipment including electrical business equipment |
| <input type="checkbox"/> EN 60335 | Safety of household and similar electrical appliances | <input type="checkbox"/> EN 60911-1 | General and Safety requirements for unshieldable power systems (UPS) |

Manufacturer/Importer

Signature: Jimmy Huang

(Stamp)

Date Nov. 10, 2004

Name: Timmy Huang

DECLARATION OF CONFORMITY

Per FCC Part 2, Section 2.1077(a)



Responsible Party Name: **G.B.T. INC. (U.S.A.)**

Address: **17358 Railroad Street**

City of Industry, CA 91748

Phone/Fax No: (818) 854-9338 / (818) 854-9339

hereby declares that the product

Product Name: Motherboard

Model Number: GA-8AENXP-D

conforms to the following specifications:

FCC Part 15, Subpart B, Section 15.107(a) and Section 15.109

(a), Class B Digital Device

Supplementary Information:

This device complies with part 15 of the FCC Rules. Operation is subject to the following two conditions: (1) This device may not cause harmful and (2) this device must accept any interference received, including that may cause undesired operation.

Representative Person's Name: ERIC LU

Signature: Eric Lu

Date: Nov. 10, 2004

Copyright

© 2005 GIGA-BYTE TECHNOLOGY CO., LTD. All rights reserved.

The trademarks mentioned in the manual are legally registered to their respective companies.

Notice

The written content provided with this product is the property of Gigabyte.

No part of this manual may be reproduced, copied, translated, or transmitted in any form or by any means without Gigabyte's prior written permission. Specifications and features are subject to change without prior notice.

Product Manual Classification

In order to assist in the use of this product, Gigabyte has categorized the user manual in the following:

- For quick installation, please refer to the "Hardware Installation Guide" included with the product.

- For detailed product information and specifications, please carefully read the "Product User Manual".

- For detailed information related to Gigabyte's unique features, please go to the "Technology Guide" section on Gigabyte's website to read or download the information you need.

For more product details, please click onto Gigabyte's website at www.gigabyte.com.tw

Table of Contents

GA-8AENXP-D Motherboard Layout	6
Block Diagram	7
Chapter 1 Hardware Installation	9
1-1 Considerations Prior to Installation	9
1-2 Feature Summary	10
1-3 Installation of the CPU and Heatsink	12
1-3-1 Installation of the CPU	12
1-3-2 Installation of the Heatsink	13
1-4 Installing/Removing Cool-Plus (Northbridge Cooling Fan)	14
1-5 Installation of Memory	14
1-6 Installation of Expansion Cards	16
1-7 I/O Back Panel Introduction	17
1-8 Connectors Introduction	18
Chapter 2 BIOS Setup	29
The Main Menu (For example: BIOS Ver. : F3d)	30
2-1 Standard CMOS Features	32
2-2 Advanced BIOS Features	34
2-3 Integrated Peripherals	36
2-4 Power Management Setup	40
2-5 PnP/PCI Configurations	41
2-6 PC Health Status	42
2-7 MB Intelligent Tweaker(M.I.T.)	44
2-8 Select Language	46
2-9 Load Fail-Safe Defaults	46
2-10 Load Optimized Defaults	47
2-11 Set Supervisor/User Password	47
2-12 Save & Exit Setup	48
2-13 Exit Without Saving	48

Chapter 3 Drivers Installation	51
3-1 Install Chipset Drivers	51
3-2 Software Applications	52
3-3 Driver CD Information	52
3-4 Hardware Information	53
3-5 Contact Us	53
Chapter 4 Appendix	55
4-1 Unique Software Utilities	55
4-1-1 EasyTune 5 Introduction	56
4-1-2 Xpress Recovery Introduction	57
4-1-3 Flash BIOS Method Introduction	60
4-1-4 Serial ATA BIOS Setting Utility Introduction	71
4-1-5 2- / 4- / 6- / 8- Channel Audio Function Introduction	78
4-2 Troubleshooting	83

GA-8AENXP-D Motherboard Layout

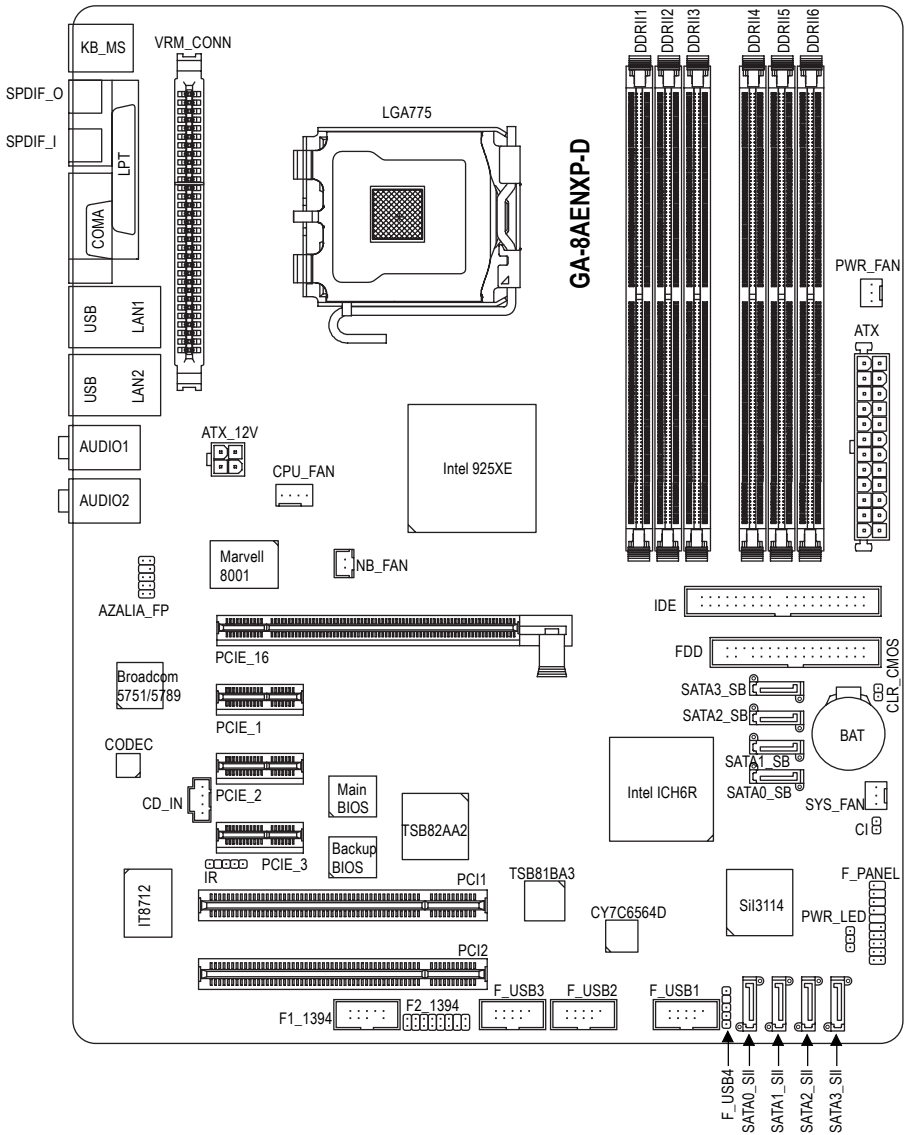

Chapter 1 Hardware Installation

1-1 Considerations Prior to Installation

Preparing Your Computer

The motherboard contains numerous delicate electronic circuits and components which can become damaged as a result of electrostatic discharge (ESD). Thus, prior to installation, please follow the instructions below:

1. Please turn off the computer and unplug its power cord.
2. When handling the motherboard, avoid touching any metal leads or connectors.
3. It is best to wear an electrostatic discharge (ESD) cuff when handling electronic components (CPU, RAM).
4. Prior to installing the electronic components, please have these items on top of an antistatic pad or within a electrostatic shielding container.
5. Please verify that the power supply is switched off before unplugging the power supply connector from the motherboard.

Installation Notices

1. Prior to installation, please do not remove the stickers on the motherboard. These stickers are required for warranty validation.
2. Prior to the installation of the motherboard or any hardware, please first carefully read the information in the provided manual.
3. Before using the product, please verify that all cables and power connectors are connected.
4. To prevent damage to the motherboard, please do not allow screws to come in contact with the motherboard circuit or its components.
5. Please make sure there are no leftover screws or metal components placed on the motherboard or within the computer casing.
6. Please do not place the computer system on an uneven surface.
7. Turning on the computer power during the installation process can lead to damage to system components as well as physical harm to the user.
8. If you are uncertain about any installation steps or have a problem related to the use of the product, please consult a certified computer technician.

Instances of Non-Warranty

1. Damage due to natural disaster, accident or human cause.
2. Damage as a result of violating the conditions recommended in the user manual.
3. Damage due to improper installation.
4. Damage due to use of uncertified components.
5. Damage due to use exceeding the permitted parameters.
6. Product determined to be an unofficial Gigabyte product.

1-2 Feature Summary

CPU	<ul style="list-style-type: none"> ◆ Supports the latest Intel® Pentium® 4 LGA775 CPU ◆ Supports 1066/800/533MHz FSB ◆ L2 cache varies with CPU
Chipset	<ul style="list-style-type: none"> ◆ Northbridge: Intel® 925XE Express Chipset ◆ Southbridge: Intel® ICH6R
Memory	<ul style="list-style-type: none"> ◆ 6 DDR II DIMM memory slots (supports up to 4GB memory) ^(Note 1) ◆ Supports dual channel DDR II 711/600^(Note 2)/533/400 unbrffered DIMM ◆ Supports 1.8V DDR II DIMM
Slots	<ul style="list-style-type: none"> ◆ 1 PCI Express x 16 slot ◆ 3 PCI Express x 1 slots ◆ 2 PCI slots
IDE Connections	<ul style="list-style-type: none"> ◆ 1 IDE connection (UDMA 33/ATA 66/ATA 100), allows connection of 2 IDE devices
FDD Connections	<ul style="list-style-type: none"> ◆ 1 FDD connection, allows connection of 2 FDD devices
Onboard SATA	<ul style="list-style-type: none"> ◆ 8 Serial ATA ports : 4 ports from ICH6R controller (SATA0_SB, SATA1_SB, SATA2_SB, SATA3_SB); 4 ports from Sii3114 controller (SATA0_SII, SATA1_SII, SATA2_SII, SATA3_SII)
Peripherals	<ul style="list-style-type: none"> ◆ 1 parallel port supporting Normal/EPP/ECP mode ◆ 1 serial port (COMA) ◆ 11 USB 2.0/1.1 ports (rear x 4, front x 7 via cable) ◆ 3 IEEE1394b ports (requires cable) ◆ 1 front audio connector ◆ 1 IR connector ◆ 1 PS/2 keyboard port ◆ 1 PS/2 mouse port
Onboard LAN	<ul style="list-style-type: none"> ◆ Onboard Marvell 8001 chip (10/100/1000 Mbit) (LAN1) ◆ Onboard Broadcom 5751/5789 chip (10/100/1000 Mbit) (LAN2) ◆ 2 RJ 45 ports
Onboard Audio	<ul style="list-style-type: none"> ◆ ALC880 CODEC ◆ Supports Jack Sensing function ◆ Supports 2 / 4 / 6 / 8 channel audio ◆ Supports Line In ; Line Out (Front Speaker Out) ; MIC ; Surround Speaker Out (Rear Speaker Out) ; Center/Subwoofer Speaker Out ; Side Speaker Out connection ◆ SPDIF In/Out connection ◆ CD In connection

(Note 1) Due to standard PC architecture, a certain amount of memory is reserved for system usage and therefore the actual memory size is less than the stated amount.

For example, 4 GB of memory size will instead be shown as 3.xxGB memory during system startup.

(Note 2) To use a DDRII 711 memory module on the motherboard, you must install a 1066MHz FSB processor and overclock in BIOS.

To use a DDRII 600 memory module on the motherboard, you must install an 800MHz FSB processor and overclock in BIOS.

I/O Control	<ul style="list-style-type: none"> ◆ IT8712
Hardware Monitor	<ul style="list-style-type: none"> ◆ System voltage detection ◆ CPU temperature detection ◆ CPU / System / Power fan speed detection ◆ CPU warning temperature ◆ CPU / System / Power fan failure warning ◆ CPU smart fan control
Onboard SATA RAID	<ul style="list-style-type: none"> ◆ Onboard ICH6R chipset (SATA0_SB, SATA1_SB, SATA2_SB, SATA3_SB) <ul style="list-style-type: none"> - supports data striping (RAID 0) or mirroring (RAID 1) function - supports data transfer rate of up to 150 MB - supports hot plugging function - supports a maximum of 4 SATA connections - supported on the Win 2000/XP operating systems ◆ Onboard Silicon Image SiI3114 chipset (SATA0_SII, SATA1_SII, SATA2_SII, SATA3_SII) <ul style="list-style-type: none"> - supports data striping (RAID 0), mirroring (RAID 1) or striping + mirroring (RAID 0+1) - supports data transfer rate of up to 150 MB - supports hot plugging function - supports a maximum of 4 SATA connections - supported on the Win 2000/XP/NT/98/Me operating systems
BIOS	<ul style="list-style-type: none"> ◆ Use of licensed AWARD BIOS ◆ Supports Dual BIOS/Q-Flash/Multilanguage BIOS
Additional Features	<ul style="list-style-type: none"> ◆ Supports U-Plus DPS ◆ Supports @BIOS ◆ Supports EasyTune 5
Overclocking	<ul style="list-style-type: none"> ◆ Over Voltage via BIOS (CPU/ DDR II/ PCI-E) ◆ Over Clock via BIOS (CPU/ DDR II/ PCI-E)
Form Factor	<ul style="list-style-type: none"> ◆ ATX form factor; 30.5cm x 24.4cm

1-3 Installation of the CPU and Heatsink



Before installing the CPU, please comply with the following conditions:

1. Please make sure that the motherboard supports the CPU.
2. Please take note of the one indented corner of the CPU. If you install the CPU in the wrong direction, the CPU will not insert properly. If this occurs, please change the insert direction of the CPU.
3. Please add an even layer of heat sink paste between the CPU and heatsink.
4. Please make sure the heatsink is installed on the CPU prior to system use, otherwise overheating and permanent damage of the CPU may occur.
5. Please set the CPU host frequency in accordance with the processor specifications. It is not recommended that the system bus frequency be set beyond hardware specifications since it does not meet the required standards for the peripherals. If you wish to set the frequency beyond the proper specifications, please do so according to your hardware specifications including the CPU, graphics card, memory, hard drive, etc.



HT functionality requirement content :

Enabling the functionality of Hyper-Threading Technology for your computer system requires all of the following platform components:

- CPU: An Intel® Pentium 4 Processor with HT Technology
- Chipset: An Intel® Chipset that supports HT Technology
- BIOS: A BIOS that supports HT Technology and has it enabled
- OS: An operation system that has optimizations for HT Technology

1-3-1 Installation of the CPU

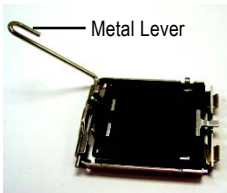

Fig. 1
Gently lift the metal lever located on the CPU socket to the upright position.

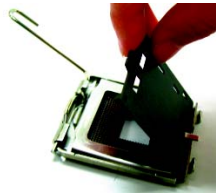

Fig. 2
Remove the plastic covering on the CPU socket.

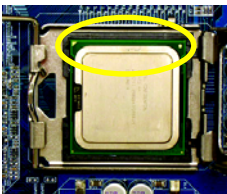

Fig. 3
Notice the small gold colored triangle located on the edge of the CPU socket. Align the indented corner of the



Fig. 4
Once the CPU is properly inserted, please replace the load plate and push the metal lever back into its original position.

CPU with the triangle and gently insert the CPU into position. (Grasping the CPU firmly between your thumb and forefinger, carefully place it into the socket in a straight and downwards motion. Avoid twisting or bending motions that might cause damage to the CPU during installation.)

1-3-2 Installation of the Heatsink



Fig. 1
Please apply an even layer of heatsink paste on the surface of the installed CPU.

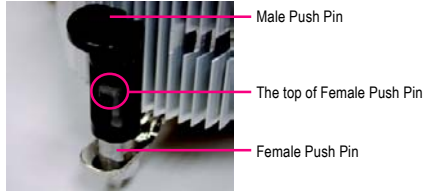

Fig. 2
(Turning the push pin along the direction of arrow is to remove the heatsink, on the contrary, is to install.) Please note the direction of arrow sign on the male push pin doesn't face inwards before installation. (This instruction is only for Intel boxed fan)

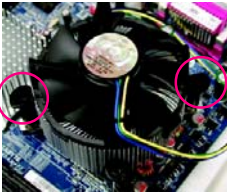

Fig. 3
Place the heatsink atop the CPU and make sure the push pins aim to the pin hole on the motherboard. Pressing down the push pins diagonally.

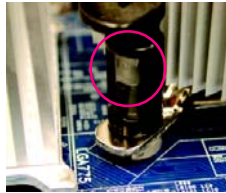

Fig. 4
Please make sure the Male and Female push pin are joined closely. (for detailed installation instructions, please refer to the heatsink installation section of the user manual)

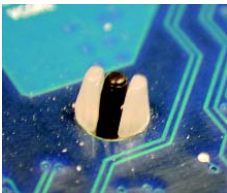

Fig. 5
Please check the back of motherboard after installing. If the push pin is inserted as the picture, the installation is complete.



Fig. 6
Finally, please attach the power connector of the heatsink to the CPU fan header located on the motherboard.



NOTE

The heatsink may adhere to the CPU as a result of hardening of the heatsink paste. To prevent such an occurrence, it is suggested that either thermal tape rather than heat sink paste be used for heat dissipation or using extreme care when removing the heatsink.

1-4 Installing/Removing Cool-Plus (Northbridge Cooling Fan)

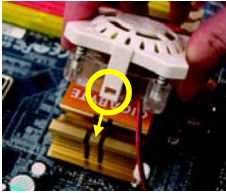

Fig.1
To attach Cool-Plus to a heatsink, align the extensions on both sides with the grooves in the heatsink as shown. Firmly press down until it snaps into position.

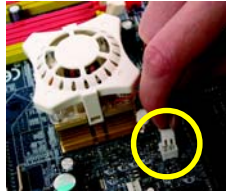

Fig.2
Once the fan is properly affixed onto the heatsink, plug the power cable into the NB_FAN connector.

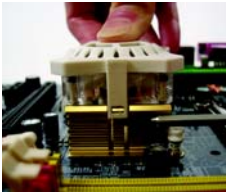

Fig.3
Before proceeding, first check to make sure that the fan's power cable is disconnected. Then, while applying pressure to the top of the fan, carefully use a screwdriver to dislodge the extension on one side.



Exerting too much pressure on the fan during removal might cause the side extensions to break-off.

1-5 Installation of Memory



Before installing the memory modules, please comply with the following conditions:

1. Please make sure that the memory used is supported by the motherboard. It is recommended that memory of similar capacity, specifications and brand be used.
2. Before installing or removing memory modules, please make sure that the computer power is switched off to prevent hardware damage.
3. Memory modules have a foolproof insertion design. A memory module can be installed in only one direction. If you are unable to insert the module, please switch the direction.

The motherboard supports DDR II memory modules, whereby BIOS will automatically detect memory capacity and specifications. Memory modules are designed so that they can be inserted only in one direction. The memory capacity used can differ with each slot.

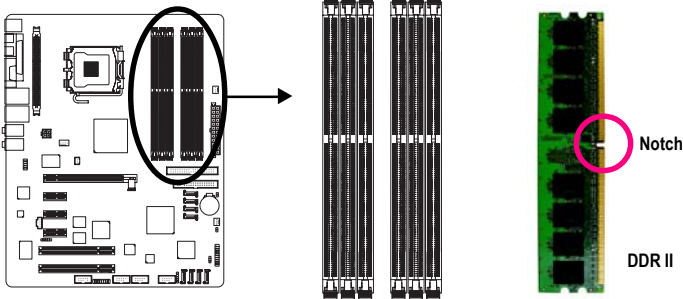

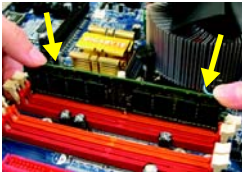

Fig.1

The DIMM socket has a notch, so the DIMM memory module can only fit in one direction. Insert the DIMM memory module vertically into the DIMM socket. Then push it down.

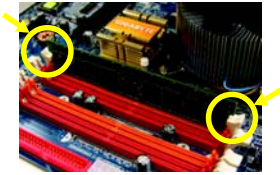

Fig.2

Close the plastic clip at both edges of the DIMM sockets to lock the DIMM module.

Reverse the installation steps when you wish to remove the DIMM module.



Dual Channel DDR II

GA-8AENXP-D supports the Dual Channel Technology. After operating the Dual Channel Technology, the bandwidth of Memory Bus will double.

GA-8AENXP-D includes 6 DIMM sockets, and each Channel has three DIMM sockets as following:

- ▶▶ Channel A : DDR II 1, DDR II 2, DDR II 3
- ▶▶ Channel B : DDR II 4, DDR II 5, DDR II 6

If you want to operate the Dual Channel Technology, please note the following explanations due to the limitation of Intel chipset specifications.

1. Dual channel memory cannot be used if one, three or five DDR II memory modules are installed.
2. If two DDR II memory modules are installed (same storage capacity), one must be added to the Channel A slot and the other in the Channel B slot in order to use dual channel memory. Dual channel memory cannot function if both DDR II memory modules are installed on the same channel.
3. If four DDR II memory modules are installed (same storage capacity), one pair must be added to the Channel A slot and the other pair in the Channel B in order to use dual channel memory.
4. If six DDR II memory modules are installed, please use memory of the same storage capacity in order to use dual channel memory and for BIOS to detect all the DDR II memory modules. Please follow the order below :
 DDR II 1: single/double-sided memory
 DDR II 2: single-sided memory
 DDR II 3: single-sided memory
 DDR II 4: single/double-sided memory (If DDR II 1 is double-sided memory, then DDR II 4 must also be double-sided memory)
 DDR II 5: single-sided memory
 DDR II 6: single-sided memory

We'll strongly recommend our user to slot two DDR memory modules into the DIMMs with the same color in order for Dual Channel Technology to work.

The following table is for Dual Channel Technology combination: (DS: Double Side, SS: Single Side)

	DDR II 1	DDR II 2	DDR II 3	DDR II 4	DDR II 5	DDR II 6
2 memory module	DS/SS	X	X	DS/SS	X	X
	X	DS/SS	X	X	DS/SS	X
	X	X	DS/SS	X	X	DS/SS
4 memory module	DS/SS	DS/SS	X	DS/SS	DS/SS	X
6 memory module	DS/SS	SS	SS	DS/SS	SS	SS

1-6 Installation of Expansion Cards

You can install your expansion card by following the steps outlined below:

1. Read the related expansion card's instruction document before install the expansion card into the computer.
2. Remove your computer's chassis cover, screws and slot bracket from the computer.
3. Press the expansion card firmly into expansion slot in motherboard.
4. Be sure the metal contacts on the card are indeed seated in the slot.
5. Replace the screw to secure the slot bracket of the expansion card.
6. Replace your computer's chassis cover.
7. Power on the computer, if necessary, setup BIOS utility of expansion card from BIOS.
8. Install related driver from the operating system.

Installing a PCI Express x 16 expansion card:

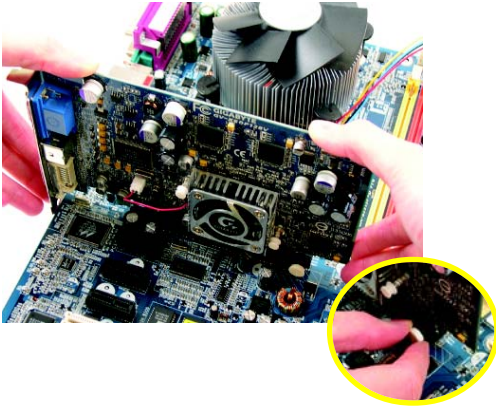

Please carefully pull out the small white-drawable bar at the end of the PCI Express x 16 slot when you try to install/uninstall the VGA card. Please align the VGA card to the onboard PCI Express x 16 slot and press firmly down on the slot. Make sure your VGA card is locked by the small white-drawable bar.

1-7 I/O Back Panel Introduction

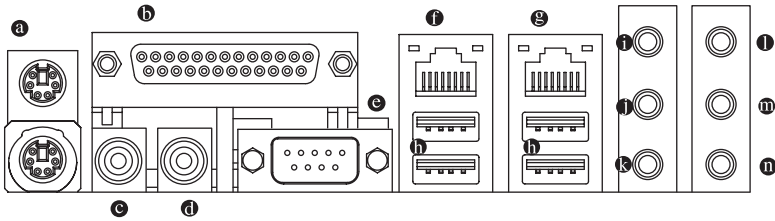

❶ PS/2 Keyboard and PS/2 Mouse Connector

To install a PS/2 port keyboard and mouse, plug the mouse to the upper port (green) and the keyboard to the lower port (purple).

❷ Parallel Port

The parallel port allows connection of a printer, scanner and other peripheral devices.

❸ SPDIF_O (SPDIF Out)

The SPDIF output is capable of providing digital audio to external speakers or compressed AC3 data to an external Dolby Digital Decoder.

❹ SPDIF_I (SPDIF In)

Use SPDIF In feature only when your device has digital output function.

❺ COM A (Serial Port)

Connects to serial-based mouse or data processing devices.

❻ LAN Port 1

The provided Internet connection is Gigabit Ethernet, providing data transfer speeds of 10/100/1000Mbps.

❼ LAN Port 2

The provided Internet connection is Gigabit Ethernet(PCI Express Gigabit), providing data transfer speeds of 10/100/1000Mbps.

❽ USB port

Before you connect your device(s) into USB connector(s), please make sure your device(s) such as USB keyboard, mouse, scanner, zip, speaker...etc. have a standard USB interface. Also make sure your OS supports USB controller. If your OS does not support USB controller, please contact OS vendor for possible patch or driver upgrade. For more information please contact your OS or device(s) vendors.

❾ Line In

Devices like CD-ROM, walkman etc. can be connected to Line In jack.

❿ Line Out (Front Speaker Out)

Connect the stereo speakers, earphone or front surround speakers to this connector.

⓫ MIC In

Microphone can be connected to MIC In jack.

⓬ Rear Speaker Out

Connect the rear surround speakers to this connector.

⑩ **Center/Subwoofer Speaker Out**

Connect the Center/Subwoofer speakers to this connector.

⑪ **Side Speaker Out**

Connect the side surround speakers to this connector.



NOTE You can use audio software to configure 2-/4-/6-/8-channel audio functioning.

1-8 Connectors Introduction

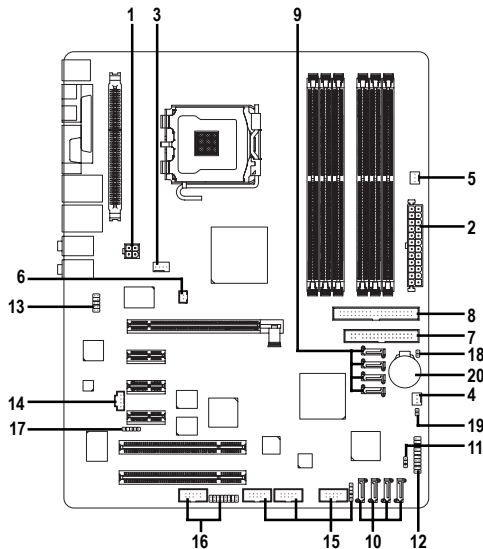

1) ATX_12V	11) PWR_LED
2) ATX (Power Connector)	12) F_PANEL
3) CPU_FAN	13) AZALIA_FP
4) SYS_FAN	14) CD_IN
5) PWR_FAN	15) F_USB1 / F_USB2 / F_USB3 / F_USB4
6) NB_FAN	16) F1_1394 / F2_1394
7) FDD	17) IR
8) IDE	18) CLR_CMOS
9) SATA0_SB/SATA1_SB/SATA2_SB/SATA3_SB	19) CI
10) SATA0_SII/SATA1_SII/SATA2_SII/SATA3_SII	20) BAT

1/2) ATX_12V/ATX (Power Connector)

With the use of the power connector, the power supply can supply enough stable power to all the components on the motherboard. Before connecting the power connector, please make sure that all components and devices are properly installed. Align the power connector with its proper location on the motherboard and connect tightly.

The ATX_12V power connector mainly supplies power to the CPU. If the ATX_12V power connector is not connected, the system will not start.

Caution!

Please use a power supply that is able to handle the system voltage requirements. It is recommended that a power supply that can withstand high power consumption be used (300W or greater). If a power supply is used that does not provide the required power, the result can lead to an unstable system or a system that is unable to start.

If you use a 24-pin ATX power supply, please remove the small cover on the power connector on the motherboard before plugging in the power cord ; Otherwise, please do not remove it.

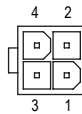
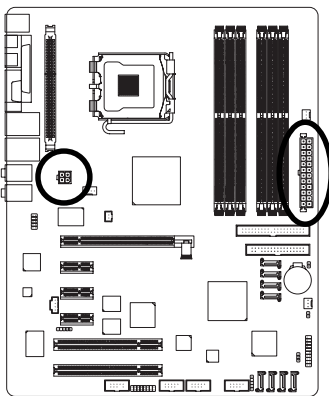

Pin No.	Definition
1	GND
2	GND
3	+12V
4	+12V

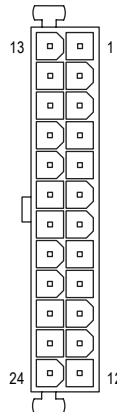

Pin No.	Definition
1	3.3V
2	3.3V
3	GND
4	VCC
5	GND
6	VCC
7	GND
8	Power Good
9	5V SB(stand by +5V)
10	+12V
11	+12V
12	3.3V(Only for 24pins ATX)
13	3.3V
14	-12V
15	GND
16	PS_ON(soft On/Off)
17	GND
18	GND
19	GND
20	-5V
21	VCC
22	VCC
23	VCC
24	GND

3/4/5) CPU_FAN / SYS_FAN / PWR_FAN (Cooler Fan Power Connector)

The cooler fan power connector supplies a +12V power voltage via a 3-pin/4-pin(only for CPU_FAN) power connector and possesses a full-proof connection design.

Most coolers are designed with color-coded power connector wires. A red power connector wire indicates a positive connection and requires a +12V power voltage. The black connector wire is the ground wire (GND).

Please remember to connect the power to the cooler to prevent system overheating and failure.
Caution!

Please remember to connect the power to the CPU fan to prevent CPU overheating and failure.

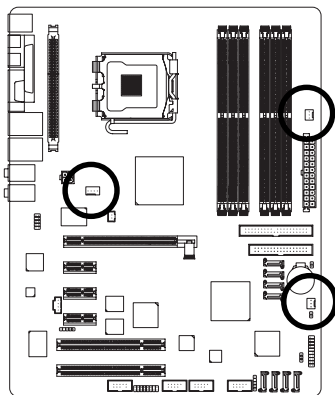

CPU_FAN



SYS_FAN / PWR_FAN

Pin No.	Definition
1	GND
2	+12V
3	Sense
4	Speed Control (Only for CPU_FAN)

6) NB_FAN (Chip Fan Connector)

If you installed wrong direction, the chip fan will not work. Sometimes will damage the chip fan.
(Usually black cable is GND)

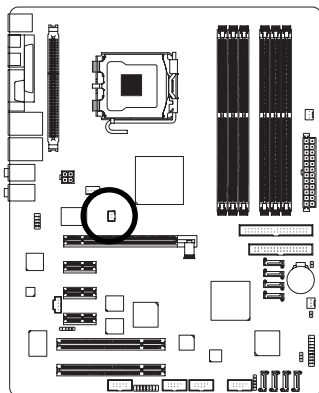

Pin No.	Definition
1	+12V
2	GND

7) FDD (FDD Connector)

The FDD connector is used to connect the FDD cable while the other end of the cable connects to the FDD drive. The types of FDD drives supported are: 360KB, 720KB, 1.2MB, 1.44MB and 2.88MB. Please connect the red power connector wire to the pin1 position.

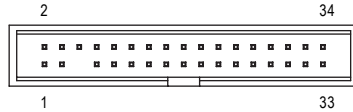
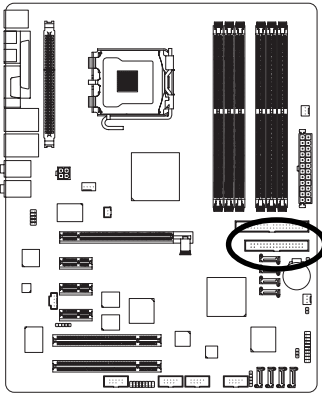

8) IDE (IDE Connector)

An IDE device connects to the computer via an IDE connector. One IDE connector can connect to one IDE cable, and the single IDE cable can then connect to two IDE devices (hard drive or optical drive). If you wish to connect two IDE devices, please set the jumper on one IDE device as Master and the other as Slave (for information on settings, please refer to the instructions located on the IDE device).

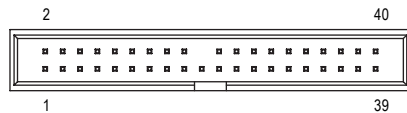
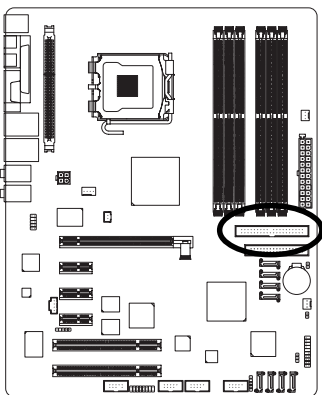

- 9) SATA0_SB/SATA1_SB/SATA2_SB/SATA3_SB (Serial ATA Connector, Controlled by ICH6R)
 10) SATA0_SII/SATA1_SII/SATA2_SII/SATA3_SII (Serial ATA Connector, Controlled by SiI3114)

Serial ATA can provide 150MB/s transfer rate. Please refer to the BIOS setting for the Serial ATA and install the proper driver in order to work properly.

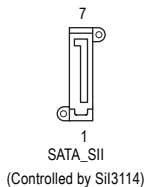
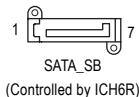
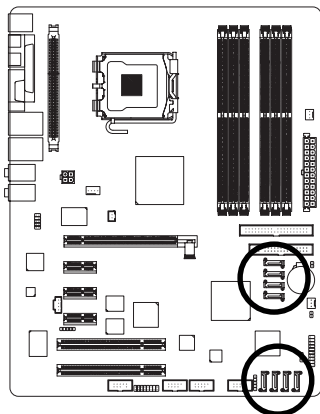

Pin No.	Definition
1	GND
2	TXP
3	TXN
4	GND
5	RXN
6	RXP
7	GND

11) PWR_LED

PWR_LED is connect with the system power indicator to indicate whether the system is on/off. It will blink when the system enters suspend mode.

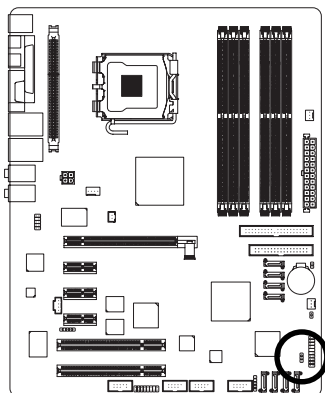

Pin No.	Definition
1	MPD+
2	MPD-
3	MPD-

12) F_PANEL (Front Panel Jumper)

Please connect the power LED, PC speaker, reset switch and power switch etc of your chassis front panel to the F_PANEL connector according to the pin assignment below.

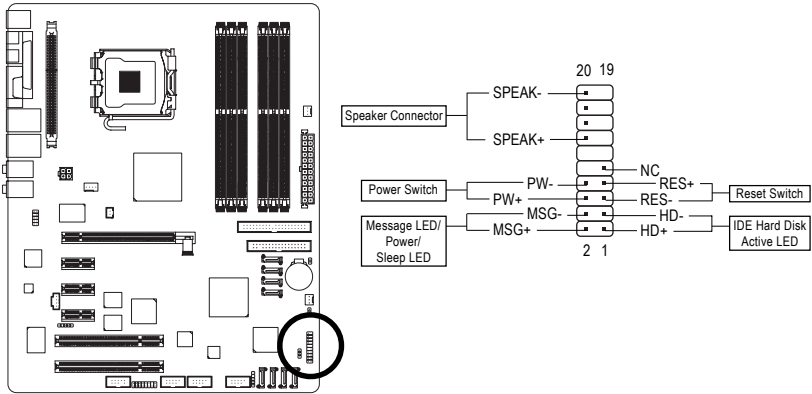

HD (IDE Hard Disk Active LED) (Blue)	Pin 1: LED anode(+) Pin 2: LED cathode(-)
SPEAK (Speaker Connector) (Amber)	Pin 1: VCC(+) Pin 2- Pin 3: NC Pin 4: Data(-)
RES (Reset Switch) (Green)	Open: Normal Operation Close: Reset Hardware System
PW (Power Switch) (Red)	Open: Normal Operation Close: Power On/Off
MSG (Message LED/Power/Sleep LED) (Yellow)	Pin 1: LED anode(+) Pin 2: LED cathode(-)
NC (Purple)	NC

13) AZALIA_FP (Front Audio Panel Connector)

This connector is supported to connect HD(High Definition) Audio and AC'97 Audio. Check the pin assignment carefully while you connect the audio panel cable, incorrect connection between the cable and connector will make the device unable to work or even damage it. For optional audio panel cable, please contact your local dealer.

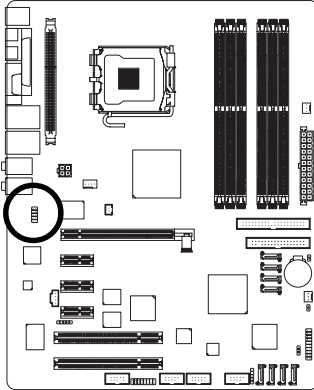

HD Audio:

Pin No.	Definition
1	MIC2_L
2	GND
3	MIC2_R
4	-ACZ_DET
5	Line2_R
6	FSENSE1
7	FAUDIO_JD
8	No Pin
9	LINE2_L
10	FSENSE2

AC'97 Audio:

Pin No.	Definition
1	MIC
2	GND
3	MIC Power
4	NC
5	Line Out (R)
6	NC
7	NC
8	No Pin
9	Line Out (L)
10	NC



HD Audio is the default setting for this connector. To enable AC'97 Audio, from BIOS settings, set **Front Panel Type** under **Integrated Peripherals** to **AC97**.

14) CD_IN (CD In Connector)

Connect CD-ROM or DVD-ROM audio out to the connector.

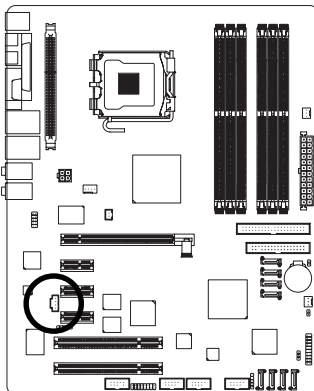

1

Pin No.	Definition
1	CD-L
2	GND
3	GND
4	CD-R

15) F_USB1 / F_USB2 / F_USB3 / F_USB4 (Front USB Connector)

Be careful with the polarity of the front USB connector. Check the pin assignment carefully while you connect the front USB cable, incorrect connection between the cable and connector will make the device unable to work or even damage it. For optional front USB cable, please contact your local dealer.

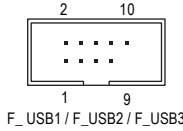
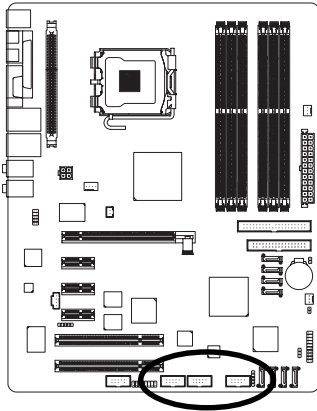

Pin No.	Definition
1	Power
2	Power
3	USB DX-
4	USB Dy-
5	USB DX+
6	USB Dy+
7	GND
8	GND
9	No Pin
10	NC

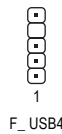

Pin No.	Definition
1	Power
2	USB DX-
3	USB DX+
4	No Pin
5	GND

16) F1_1394 / F2_1394 (IEEE 1394 Connector)

Serial interface standard set by Institute of Electrical and Electronics Engineers, which has features like high speed, high bandwidth and hot plug. Be careful with the polarity of the IEEE1394 connector. Check the pin assignment carefully while you connect the IEEE1394 cable, incorrect connection between the cable and connector will make the device unable to work or even damage it. For optional IEEE1394 cable, please contact your local dealer.

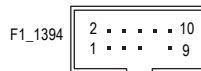
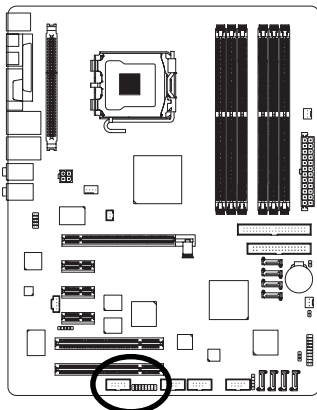

Pin No.	Definition
1	TPA0+
2	TPA0-
3	GND
4	GND
5	TPB0+
6	TPB0-
7	No Pin
8	Power
9	Power
10	GND

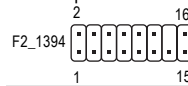

Pin No.	Definition
1	Power
2	Power
3	TPA1+
4	TPA1-
5	GND
6	GND
7	TPB1+
8	TPB1-
9	Power
10	Power
11	TPA2+
12	TPA2-
13	GND
14	No Pin
15	TPB2+
16	TPB2-

17) IR

Be careful with the polarity of the IR connector while you connect the IR. Please contact your nearest dealer for optional IR device.

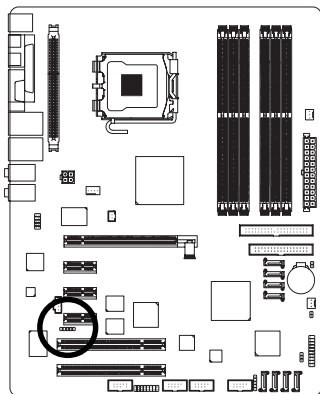

Pin No.	Definition
1	VCC
2	No Pin
3	IR RX
4	GND
5	IR TX

18) CLR_CMOS (Clear CMOS)

You may clear the CMOS data to its default values by this jumper. To clear CMOS, temporarily short 1-2 pin. Default doesn't include the "Shunter" to prevent from improper use this jumper.

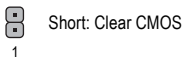
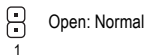
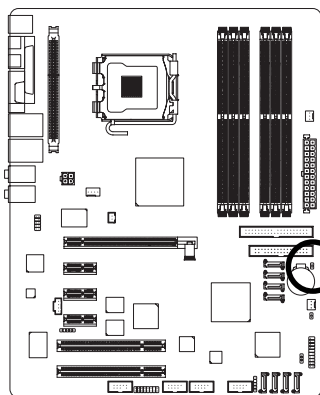

19) CI (Chassis Intrusion, Case Open)

This 2-pin connector allows your system to enable or disable the "case open" item in BIOS if the system case has been remove.

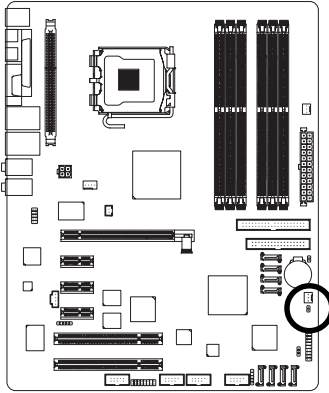

1

Pin No.	Definition
1	Signal
2	GND

20) BAT(Battery)

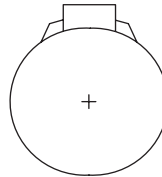
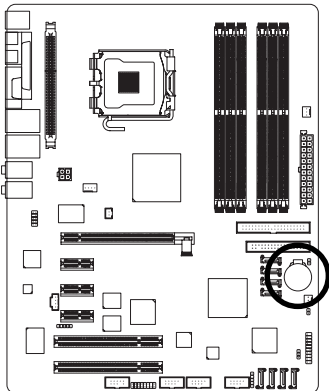

- ❖ Danger of explosion if battery is incorrectly replaced.
- ❖ Replace only with the same or equivalent type recommended by the manufacturer.
- ❖ Dispose of used batteries according to the manufacturer's instructions.

If you want to erase CMOS...

1. Turn OFF the computer and unplug the power cord.
2. Remove the battery, wait for 30 second.
3. Re-install the battery.
4. Plug the power cord and turn ON the computer.

Chapter 2 BIOS Setup

BIOS (Basic Input and Output System) includes a CMOS SETUP utility which allows user to configure required settings or to activate certain system features.

The CMOS SETUP saves the configuration in the CMOS SRAM of the motherboard.

When the power is turned off, the battery on the motherboard supplies the necessary power to the CMOS SRAM.

When the power is turned on, pushing the button during the BIOS POST (Power-On Self Test) will take you to the CMOS SETUP screen. You can enter the BIOS setup screen by pressing "Ctrl + F1".

When setting up BIOS for the first time, it is recommended that you save the current BIOS to a disk in the event that BIOS needs to be reset to its original settings. If you wish to upgrade to a new BIOS, either GIGABYTE's Q-Flash or @BIOS utility can be used.

Q-Flash allows the user to quickly and easily update or backup BIOS without entering the operating system. @BIOS is a Windows-based utility that does not require users to boot to DOS before upgrading BIOS but directly download and update BIOS from the Internet.

CONTROL KEYS

<↑> <↓> <←> <→>	Move to select item
<Enter>	Select Item
<Esc>	Main Menu - Quit and not save changes into CMOS Status Page Setup Menu and Option Page Setup Menu - Exit current page and return to Main Menu
<Page Up>	Increase the numeric value or make changes
<Page Down>	Decrease the numeric value or make changes
<F1>	General help, only for Status Page Setup Menu and Option Page Setup Menu
<F2>	Item Help
<F5>	Restore the previous CMOS value from CMOS, only for Option Page Setup Menu
<F6>	Load the file-safe default CMOS value from BIOS default table
<F7>	Load the Optimized Defaults
<F8>	Dual BIOS/Q-Flash utility
<F9>	System Information
<F10>	Save all the CMOS changes, only for Main Menu

Main Menu

The on-line description of the highlighted setup function is displayed at the bottom of the screen.

Status Page Setup Menu / Option Page Setup Menu

Press F1 to pop up a small help window that describes the appropriate keys to use and the possible selections for the highlighted item. To exit the Help Window press <Esc>.

The Main Menu (For example: BIOS Ver. : F3d)

Once you enter Award BIOS CMOS Setup Utility, the Main Menu (as figure below) will appear on the screen. Use arrow keys to select among the items and press <Enter> to accept or enter the sub-menu.

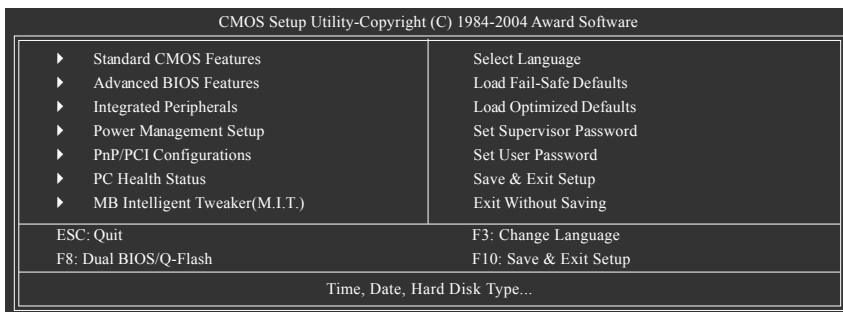

If you can't find the setting you want, please press "Ctrl+F1" to search the advanced option hidden. Please Load Optimized Defaults in the BIOS when somehow the system works not stable as usual. This action makes the system reset to the default for stability.

■ Standard CMOS Features

This setup page includes all the items in standard compatible BIOS.

■ Advanced BIOS Features

This setup page includes all the items of Award special enhanced features.

■ Integrated Peripherals

This setup page includes all onboard peripherals.

■ Power Management Setup

This setup page includes all the items of Green function features.

■ PnP/PCI Configuration

This setup page includes all the configurations of PCI & PnP ISA resources.

■ PC Health Status

This setup page is the System auto detect Temperature, voltage, fan, speed.

■ MB Intelligent Tweaker(M.I.T.)

This setup page is control CPU clock and frequency ratio.

■ Select Language

This setup page is select multi language.

■ Load Fail-Safe Defaults

Fail-Safe Defaults indicates the value of the system parameters which the system would be in safe configuration.

■ Load Optimized Defaults

Optimized Defaults indicates the value of the system parameters which the system would be in best performance configuration.

■ Set Supervisor Password

Change, set, or disable password. It allows you to limit access to the system and Setup, or just to Setup.

■ Set User Password

Change, set, or disable password. It allows you to limit access to the system.

■ Save & Exit Setup

Save CMOS value settings to CMOS and exit setup.

■ Exit Without Saving

Abandon all CMOS value changes and exit setup.

2-1 Standard CMOS Features

CMOS Setup Utility-Copyright (C) 1984-2004 Award Software Standard CMOS Features		
Date (mm:dd:yy)	Wed, Oct 27 2004	Item Help
Time (hh:mm:ss)	22:31:24	Menu Level▶
▶ IDE Channel 0 Master	[None]	Change the day, month, year
▶ IDE Channel 0 Slave	[None]	<Week> Sun. to Sat.
Drive A	[1.44M, 3.5"]	<Month> Jan. to Dec.
Drive B	[None]	<Day> 1 to 31 (or maximum allowed in the month)
Floppy 3 Mode Support	[Disabled]	<Year> 1999 to 2098
Halt On	[All, But Keyboard]	
Base Memory	640K	
Extended Memory	511M	
Total Memory	512M	
↑↓←→: Move Enter: Select +/-/PU/PD: Value F10: Save ESC: Exit F1: General Help F3: Language F5: Previous Values F6: Fail-Safe Defaults F7: Optimized Defaults		

☞ Date

The date format is <week>, <month>, <day>, <year>.

- ▶▶ Week The week, from Sun to Sat, determined by the BIOS and is display only
- ▶▶ Month The month, Jan. Through Dec.
- ▶▶ Day The day, from 1 to 31 (or the maximum allowed in the month)
- ▶▶ Year The year, from 1999 through 2098

☞ Time

The times format in <hour> <minute> <second>. The time is calculated base on the 24-hour military-time clock. For example, 1 p.m. is 13:00:00.

☞ IDE Channel 0 Master, Slave

- ▶▶ IDE HDD Auto-Detection Press "Enter" to select this option for automatic device detection.
- ▶▶ IDE Device Setup. You can use one of three methods:
 - Auto Allows BIOS to automatically detect IDE devices during POST(default)
 - None Select this if no IDE devices are used and the system will skip the automatic detection step and allow for faster system start up.
 - Manual User can manually input the correct settings.
- ▶▶ Access Mode Use this to set the access mode for the hard drive. The four options are:
CHS/LBA/Large/Auto(default:Auto)

Hard drive information should be labeled on the outside drive casing. Enter the appropriate option based on this information.

- ▶▶ Cylinder Number of cylinders
- ▶▶ Head Number of heads
- ▶▶ Precomp Write precomp
- ▶▶ Landing Zone Landing zone
- ▶▶ Sector Number of sectors

If a hard disk has not been installed, select NONE and press <Enter>.

☞ Drive A / Drive B

The category identifies the types of floppy disk drive A or drive B that has been installed in the computer.

- ▶▶ None No floppy drive installed.
- ▶▶ 360K, 5.25" 5.25 inch PC-type standard drive; 360K byte capacity.
- ▶▶ 1.2M, 5.25" 5.25 inch AT-type high-density drive; 1.2M byte capacity.
(3.5 inch when 3 Mode is Enabled).
- ▶▶ 720K, 3.5" 3.5 inch double-sided drive; 720K byte capacity.
- ▶▶ 1.44M, 3.5" 3.5 inch double-sided drive; 1.44M byte capacity.
- ▶▶ 2.88M, 3.5" 3.5 inch double-sided drive; 2.88M byte capacity.

☞ Floppy 3 Mode Support (for Japan Area)

- ▶▶ Disabled Normal Floppy Drive. (Default value)
- ▶▶ Drive A Drive A is 3 mode Floppy Drive.
- ▶▶ Drive B Drive B is 3 mode Floppy Drive.
- ▶▶ Both Drive A & B are 3 mode Floppy Drives.

☞ Halt on

The category determines whether the computer will stop if an error is detected during power up.

- ▶▶ No Errors The system boot will not stop for any error that may be detected and you will be prompted.
- ▶▶ All Errors Whenever the BIOS detects a non-fatal error the system will be stopped.
- ▶▶ All, But Keyboard The system boot will not stop for a keyboard error; it will stop for all other errors. (Default value)
- ▶▶ All, But Diskette The system boot will not stop for a disk error; it will stop for all other errors.
- ▶▶ All, But Disk/Key The system boot will not stop for a keyboard or disk error; it will stop for all other errors.

☞ Memory

The category is display-only which is determined by POST (Power On Self Test) of the BIOS.

▶▶ Base Memory

The POST of the BIOS will determine the amount of base (or conventional) memory installed in the system.

The value of the base memory is typically 512K for systems with 512K memory installed on the motherboard, or 640K for systems with 640K or more memory installed on the motherboard.

▶▶ Extended Memory

The BIOS determines how much extended memory is present during the POST.

This is the amount of memory located above 1 MB in the CPU's memory address map.

▶▶ Total Memory

This item displays the memory size that used.

2-2 Advanced BIOS Features

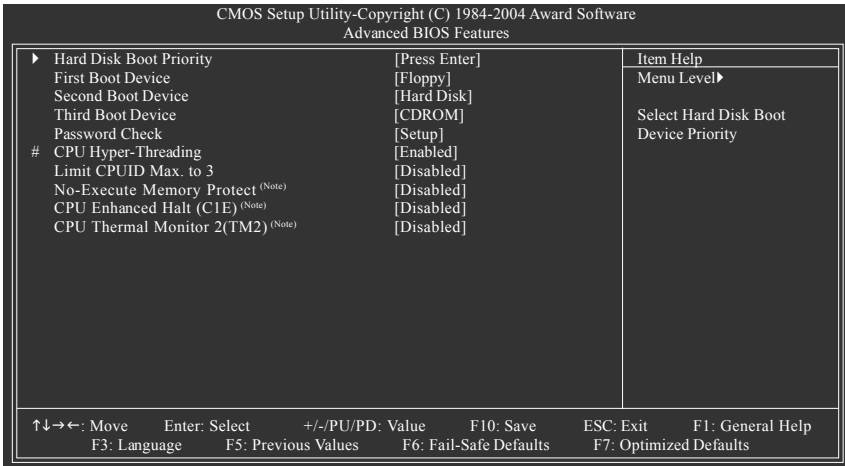

" # " System will detect automatically and show up when you install the Intel® Pentium® 4 processor with HT Technology.

☞ Hard Disk Boot Priority

Select boot sequence for onboard(or add-on cards) SCSI, RAID, etc.

Use <↑> or <↓> to select a device, then press<+> to move it up, or <-> to move it down the list. Press <ESC> to exit this menu.

☞ First / Second / Third Boot Device

- ▶ Floppy Select your boot device priority by Floppy.
- ▶ LS120 Select your boot device priority by LS120.
- ▶ Hard Disk Select your boot device priority by Hard Disk.
- ▶ CDROM Select your boot device priority by CDROM.
- ▶ ZIP Select your boot device priority by ZIP.
- ▶ USB-FDD Select your boot device priority by USB-FDD.
- ▶ USB-ZIP Select your boot device priority by USB-ZIP.
- ▶ USB-CDROM Select your boot device priority by USB-CDROM.
- ▶ USB-HDD Select your boot device priority by USB-HDD.
- ▶ LAN Select your boot device priority by LAN.
- ▶ Disabled Disable this function.

(Note) This item will show up when you install a processor which supports this function.

- ☞ **Password Check**
 - ▶▶ Setup The system will boot but will not access to Setup page if the correct password is not entered at the prompt. (Default value)
 - ▶▶ System The system will not boot and will not access to Setup page if the correct password is not entered at the prompt.
- ☞ **CPU Hyper-Threading**
 - ▶▶ Enabled Enables CPU Hyper Threading Feature. Please note that this feature is only working for operating system with multi processors mode supported. (Default value)
 - ▶▶ Disabled Disables CPU Hyper Threading.
- ☞ **Limit CPUID Max. to 3**
 - ▶▶ Enabled Limit CPUID Maximum value to 3 when use older OS like NT4.
 - ▶▶ Disabled Disable CPUID Limit for windows XP. (Default value)
- ☞ **No-Execute Memory Protect^(Note)**
 - ▶▶ Enabled Enable No-Execute Memory Protect function.
 - ▶▶ Disabled Disable No-Execute Memory Protect function. (Default value)
- ☞ **CPU Enhanced Halt (C1E)^(Note)**
 - ▶▶ Enabled Enable CPU Enhanced Halt (C1E) function.
 - ▶▶ Disabled Disable CPU Enhanced Halt (C1E) function. (Default value)
- ☞ **CPU Thermal Monitor 2 (TM2)^(Note)**
 - ▶▶ Enabled Enable CPU Thermal Monitor 2 (TM2) function.
 - ▶▶ Disabled Disable CPU Thermal Monitor 2 (TM2) function. (Default value)

(Note) This item will show up when you install a processor which supports this function.

2-3 Integrated Peripherals

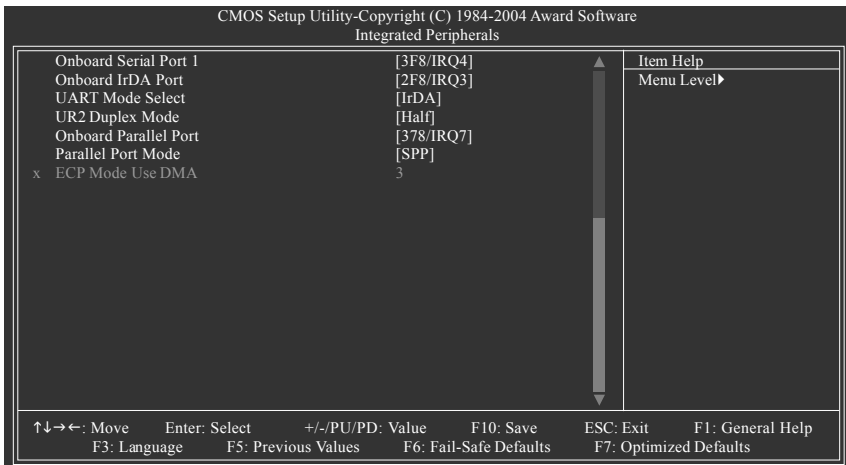
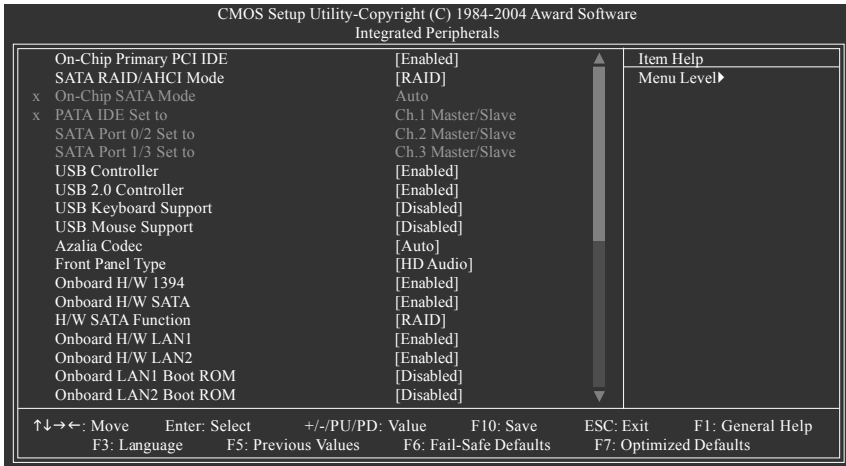

☞ On-Chip Primary PCI IDE

- ▶▶ Enabled Enable onboard 1st channel IDE port. (Default value)
- ▶▶ Disabled Disable onboard 1st channel IDE port.

☞ SATA RAID / AHCI Mode

- ▶▶ RAID Select onboard Serial ATA function as RAID. (Default value)
- ▶▶ AHCI Support hotplug function under OS. WinXP, 2000 only.
- ▶▶ Disabled Select onboard Serial ATA function as ATA.

☞ On-Chip SATA Mode

- ▶▶ Disabled Disable this function.
- ▶▶ Auto BIOS will detect automatically. (Default value)
- ▶▶ Combined Set On-Chip SATA mode to Combined, you can use up to 4 HDDs on the motherboard; 2 for SATA and the other for PATA IDE.

- ▶▶ Enhanced Set On-Chip SATA mode to Enhanced, the motherboard allows up to 6 HDDs to use.
- ▶▶ Non-Combined Set On-Chip SATA mode to Non-Combined, SATA will be simulated to PATA mode.

☞ **PATA IDE Set to**

- ▶▶ Ch.1 Master/Slave Set PATA IDE to Ch. 1 Master/Slave. (Default value)
- ▶▶ Ch.0 Master/Slave Set PATA IDE to Ch. 0 Master/Slave.

☞ **SATA Port 0/2 Set to**

▶▶ This value will auto make by the setting "On-Chip SATA Mode" and "PATA IDE Set to".
If PATA IDE were set to Ch. 1 Master/Slave, this function will auto set to Ch. 0 Master/Slave.

☞ **SATA Port 1/3 Set to**

▶▶ This value will auto make by the setting "On-Chip SATA Mode" and "PATA IDE Set to".
If PATA IDE were set to Ch. 0 Master/Slave, this function will auto set to Ch. 1 Master/Slave.

☞ **USB Controller**

- ▶▶ Enabled Enable USB controller. (Default value)
- ▶▶ Disabled Disable USB controller.

☞ **USB 2.0 Controller**

Disable this function if you are not using onboard USB 2.0 feature.

- ▶▶ Enabled Enable USB 2.0 controller. (Default value)
- ▶▶ Disabled Disable USB 2.0 controller.

☞ **USB Keyboard Support**

- ▶▶ Enabled Enable USB keyboard support.
- ▶▶ Disabled Disable USB keyboard support. (Default value)

☞ **USB Mouse Support**

- ▶▶ Enabled Enable USB mouse support.
- ▶▶ Disabled Disable USB mouse support. (Default value)

☞ **Azalia Codec**

- ▶▶ Auto Auto detect Azalia audio function. (Default value)
- ▶▶ Disabled Disable Azalia audio function.

☞ **Front Panel Type**

If you connect HD Audio Panel to the AZALIA_FP connector, set this item to **HD Audio**. If you connect AC97 Audio Panel to the AZALIA_FP connector, set this item to **AC97**.

- ▶▶ AC97 Set front audio panel type to AC97.
- ▶▶ HD Audio Set front audio panel type to HD Audio. (Default value)

☞ **Onboard H/W 1394**

- ▶▶ Enabled Enable onboard IEEE 1394 function. (Default value)
- ▶▶ Disabled Disable this function.

☞ **Onboard H/W SATA**

- ▶▶ Enabled Enable onboard H/W SATA function. (Default value)
- ▶▶ Disabled Disable this function.

☞ **H/W SATA Function**

- ▶▶ RAID Set onboard H/W SATA function as RAID. (Default value)
- ▶▶ BASE Set onboard H/W SATA function as base.

☞ Onboard H/W LAN1 (LAN1 port)

- ▶▶ Enabled Enable onboard H/W LAN function. (Default value)
- ▶▶ Disabled Disable this function.

☞ Onboard H/W LAN2 (LAN2 port)

- ▶▶ Enabled Enable onboard H/W LAN function. (Default value)
- ▶▶ Disabled Disable this function.

☞ Onboard LAN1 Boot ROM (LAN1 port)

This function decide whether to invoke the boot ROM of the onboard LAN chip.

- ▶▶ Enabled Enable this function.
- ▶▶ Disabled Disable this function. (Default value)

☞ Onboard LAN2 Boot ROM (LAN2 port)

This function decide whether to invoke the boot ROM of the onboard LAN chip.

- ▶▶ Enabled Enable this function.
- ▶▶ Disabled Disable this function. (Default value)

☞ Onboard Serial Port 1

- ▶▶ Auto BIOS will automatically setup the port 1 address.
- ▶▶ 3F8/IRQ4 Enable onboard Serial port 1 and address is 3F8. (Default value)
- ▶▶ 2F8/IRQ3 Enable onboard Serial port 1 and address is 2F8.
- ▶▶ 3E8/IRQ4 Enable onboard Serial port 1 and address is 3E8.
- ▶▶ 2E8/IRQ3 Enable onboard Serial port 1 and address is 2E8.
- ▶▶ Disabled Disable onboard Serial port 1.

☞ Onboard IrDA Port

- ▶▶ Auto BIOS will automatically setup the IrDA port address.
- ▶▶ 3F8/IRQ4 Enable onboard IrDA port and address is 3F8/IRQ4.
- ▶▶ 2F8/IRQ3 Enable onboard IrDA port and address is 2F8/IRQ3. (Default value)
- ▶▶ 3E8/IRQ4 Enable onboard IrDA port and address is 3E8/IRQ4.
- ▶▶ 2E8/IRQ3 Enable onboard IrDA port and address is 2E8/IRQ3.
- ▶▶ Disabled Disable onboard IrDA port .

☞ UART Mode Select

This item allows you to determine which Infra Red(IR) function of Onboard I/O chip.

- ▶▶ ASKIR Set onboard I/O chip UART to ASKIR Mode.
- ▶▶ IrDA Set onboard I/O chip UART to IrDA Mode. (Default value)

☞ UR2 Duplex Mode

This feature allows you to select IR mode.

- ▶▶ Half IR Function Duplex Half. (Default value)
- ▶▶ Full IR Function Duplex Full.

☞ Onboard Parallel port

- ▶▶ Disabled Disable onboard LPT port.
- ▶▶ 378/IRQ7 Enable onboard LPT port and address is 378/IRQ7. (Default value)
- ▶▶ 278/IRQ5 Enable onboard LPT port and address is 278/IRQ5.
- ▶▶ 3BC/IRQ7 Enable onboard LPT port and address is 3BC/IRQ7.

Parallel Port Mode

- ▶▶ SPP Using Parallel port as Standard Parallel Port. (Default value)
- ▶▶ EPP Using Parallel port as Enhanced Parallel Port.
- ▶▶ ECP Using Parallel port as Extended Capabilities Port.
- ▶▶ ECP+EPP Using Parallel port as ECP & EPP mode.

ECP Mode Use DMA

- ▶▶ 3 Set ECP Mode Use DMA to 3. (Default value)
- ▶▶ 1 Set ECP Mode Use DMA to 1.

2-4 Power Management Setup

CMOS Setup Utility-Copyright (C) 1984-2004 Award Software
Power Management Setup

ACPI Suspend Type	[S1(POS)]	Item Help
Soft-Off by PWR-BTTN	[Instant-Off]	Menu Level▶
PME Event Wake Up	[Enabled]	
Power On by Ring	[Enabled]	
Resume by Alarm	[Disabled]	
x Date (of Month) Alarm	Everyday	
x Time (hh:mm:ss) Alarm	0 : 0 : 0	
Power On By Mouse	[Disabled]	
Power On By Keyboard	[Disabled]	
x KB Power ON Password	Enter	
AC BACK Function	[Soft-Off]	

↑↓←→: Move Enter: Select +/-/PU/PD: Value F10: Save ESC: Exit F1: General Help
F3: Language F5: Previous Values F6: Fail-Safe Defaults F7: Optimized Defaults

ACPI Suspend Type

- ▶▶ S1(POS) Set ACPI suspend type to S1/POS(Power On Suspend). (Default value)
- ▶▶ S3(STR) Set ACPI suspend type to S3/STR(Suspend To RAM).

Soft-Off by PWR-BTTN

- ▶▶ Instant-Off Press power button then Power off instantly. (Default value)
- ▶▶ Delay 4 Sec. Press power button 4 seconds to Power off. Enter suspend if button is pressed less than 4 seconds.

PME Event Wake Up

- ▶▶ Disabled Disable this function.
- ▶▶ Enabled Enable PME Event Wake up. (Default value)

Power On by Ring

- ▶▶ Disabled Disable Power on by Ring function.
- ▶▶ Enabled Enable Power on by Ring function. (Default value)

Resume by Alarm

You can set "Resume by Alarm" item to enabled and key in Date/Time to power on system.

- ▶▶ Disabled Disable this function. (Default value)
- ▶▶ Enabled Enable alarm function to POWER ON system.

If RTC Alarm Lead To Power On is Enabled.

- ▶▶ Date (of Month) Alarm : Everyday, 1~31
- ▶▶ Time (hh: mm: ss) Alarm : (0~23) : (0~59) : (0~59)

Power On By Mouse

- ▶▶ Disabled Disabled this function. (Default value)
- ▶▶ Double Click Double click on PS/2 mouse left button to power on the system.

☞ Power On By Keyboard

- ▶ Password Enter from 1 to 5 characters to set the Keyboard Power On Password.
- ▶ Disabled Disabled this function. (Default value)
- ▶ Keyboard 98 If your keyboard have "POWER Key" button, you can press the key to power on the system.

☞ KB Power ON Password

When "Power On by Keyboard" set at Password, you can set the password here.

- ▶ Enter Input password (from 1 to 5 characters) and press Enter to set the Keyboard Power On password.

☞ AC BACK Function

- ▶ Soft-Off When AC-power back to the system, the system will be in "Off" state. (Default value)
- ▶ Full-On When AC-power back to the system, the system always in "On" state.
- ▶ Memory When AC-power back to the system, the system will return to the Last state before AC-power off.

2-5 PnP/PCI Configurations

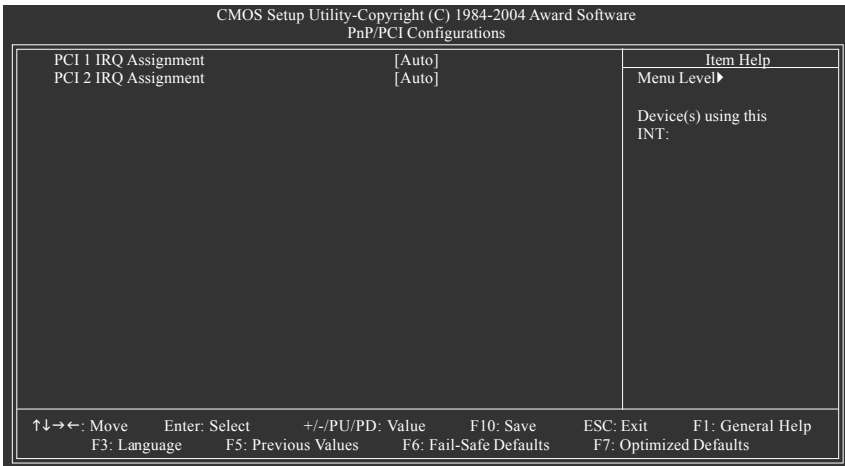

☞ PCI 1 IRQ Assignment

- ▶ Auto Auto assign IRQ to PCI 1. (Default value)
- ▶ 3,4,5,7,9,10,11,12,14,15 Set IRQ 3,4,5,7,9,10,11,12,14,15 to PCI 1.

☞ PCI 2 IRQ Assignment

- ▶ Auto Auto assign IRQ to PCI 2. (Default value)
- ▶ 3,4,5,7,9,10,11,12,14,15 Set IRQ 3,4,5,7,9,10,11,12,14,15 to PCI 2.

2-6 PC Health Status

CMOS Setup Utility-Copyright (C) 1984-2004 Award Software		Item Help
PC Health Status		Menu Level▶
Reset Case Open Status	[Disabled]	
Case Opened	No	
Vcore	OK	
DDR18V	OK	
+3.3V	OK	
+12V	OK	
Current CPU Temperature	33°C	
Current CPU FAN Speed	4687 RPM	
Current POWER FAN Speed	0 RPM	
Current SYSTEM FAN Speed	0 RPM	
CPU Warning Temperature	[Disabled]	
CPU FAN Fail Warning	[Disabled]	
POWER FAN Fail Warning	[Disabled]	
SYSTEM FAN Fail Warning	[Disabled]	
CPU Smart FAN Control	[Enabled]	
CPU Smart FAN Mode	[Auto]	

↑↓→←: Move Enter: Select +/-/PU/PD: Value F10: Save ESC: Exit F1: General Help
 F3: Language F5: Previous Values F6: Fail-Safe Defaults F7: Optimized Defaults

Reset Case Open Status

- ▶ Disabled Don't reset case open status. (Default value)
- ▶ Enabled Clear case open status at next boot.

Case Opened

If the case is closed, "Case Opened" will show "No". If the case has been opened, "Case Opened" will show "Yes". If you want to reset "Case Opened" value, set "Reset Case Open Status" to **Enabled** then save BIOS setup and restart your system.

Current Voltage(V) Vcore / DDR18V / +3.3V / +12V

- ▶ Detect system's voltage status automatically.

Current CPU Temperature

- ▶ Detect CPU temperature automatically.

Current CPU/POWER/SYSTEM FAN Speed (RPM)

- ▶ Detect CPU/POWER/SYSTEM fan speed status automatically.

CPU Warning Temperature

- ▶ 60°C / 140°F Monitor CPU temperature at 60°C / 140°F.
- ▶ 70°C / 158°F Monitor CPU temperature at 70°C / 158°F.
- ▶ 80°C / 176°F Monitor CPU temperature at 80°C / 176°F.
- ▶ 90°C / 194°F Monitor CPU temperature at 90°C / 194°F.
- ▶ Disabled Disable this function. (Default value)

CPU/POWER/SYSTEM FAN Fail Warning

- ▶ Disabled Fan warning function disable. (Default value)
- ▶ Enabled Fan warning function enable.

☞ CPU Smart FAN Control

- ▶▶ Disabled Disable this function.
- ▶▶ Enabled Enable the **CPU Smart FAN Control** function. (Default value)
 - a. When the CPU temperature is higher than 65 degrees Celsius, CPU fan will operate at full speed.
 - b. When the CPU temperature is between 20 and 65 degrees Celsius, the CPU fan speed will change depending on the actual CPU temperature.
 - c. When the CPU temperature is lower than 20 degrees Celsius, CPU fan will stop spinning.

☞ CPU Smart FAN Mode

This option is available only when CPU Smart FAN Control is enabled.

- ▶▶ Auto BIOS autodetects the type of CPU fan you installed and sets the optimal CPU Smart FAN control mode for it. (Default value)
- ▶▶ Voltage Set to Voltage when you use a CPU fan with a 3-pin fan power cable.
- ▶▶ PWM Set to PWM when you use a CPU fan with a 4-pin fan power cable.



In fact, the **Voltage** option can be used for CPU fans with 3-pin or 4-pin power cables. However, some 4-pin CPU fan power cables are not designed following Intel 4-wire fans PWM control specifications. With such CPU fans, selecting PWM will not effectively reduce the fan speed.

2-7 MB Intelligent Tweaker(M.I.T.)

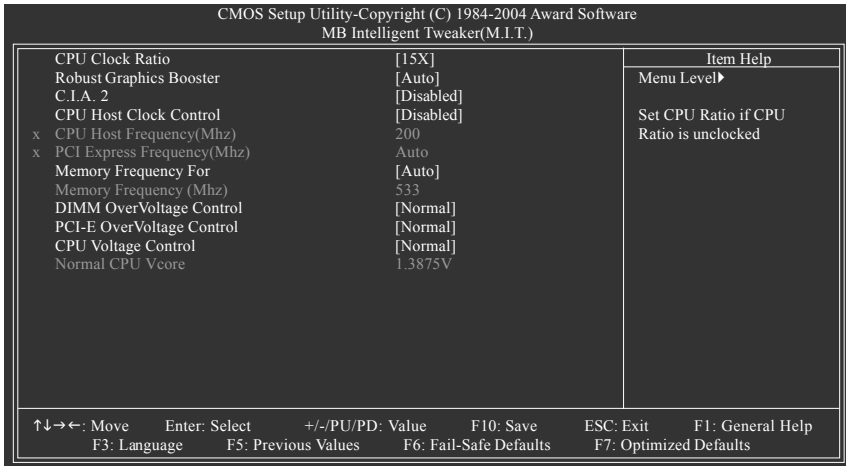

Incorrect using these features may cause your system broken. For power end-user use only.

☞ CPU Clock Ratio

This setup option will automatically assign by CPU detection.

The option will display "Locked" and read only if the CPU ratio is not changeable.

☞ Robust Graphics Booster

Select the options can enhance the VGA graphics card bandwidth to get higher performance.

- ▶▶ Auto Set Robust Graphics Booster to Auto. (Default value)
- ▶▶ Fast Set Robust Graphics Booster to Fast.
- ▶▶ Turbo Set Robust Graphics Booster to Turbo.

☞ C.I.A.2

C.I.A.2 (CPU Intelligent Accelerator 2) is designed to detect CPU loading during software program executing, and automatically adjust CPU computing power to maximize system performance.

- ▶▶ Disabled Disable this function. (Default value)
- ▶▶ Cruise Set C.I.A.2 to Cruise. Automatically increase CPU frequency(3%,7%) by CPU loading.
- ▶▶ Sports Set C.I.A.2 to Sports. Automatically increase CPU frequency(5%,9%) by CPU loading.
- ▶▶ Racing Set C.I.A.2 to Racing. Automatically increase CPU frequency(7%,11%) by CPU loading.
- ▶▶ Turbo Set C.I.A.2 to Turbo. Automatically increase CPU frequency(13,17%) by CPU loading.
- ▶▶ Full Thrust Set C.I.A.2 to Full Thrust. Automatically increase CPU frequency(15%,19%) by CPU loading.

Warning: Stability is highly dependent on system components.

☞ CPU Host Clock Control

- ▶▶ Disabled Disable CPU Host Clock Control. (Default value)
- ▶▶ Enabled Enable CPU Host Clock Control.

☞ CPU Host Frequency(Mhz)

▶▶ 100Mhz ~ 600Mhz Set CPU Host Clock from 100Mhz to 600Mhz.

If you use a 533Mhz FSB processor, please set **CPU Host Frequency** to **133Mhz**.

If you use an 800Mhz FSB processor, please set **CPU Host Frequency** to **200Mhz**.

If you use a 1066Mhz FSB processor, please set **CPU Host Frequency** to **266Mhz**.

☞ PCI Express Frequency(Mhz)

▶▶ Auto Set PCI Express frequency automatically. (Default value)

▶▶ 100Mhz ~ 130Mhz Set PCI Express frequency from 100Mhz to 130Mhz.

☞ Memory Frequency For

Wrong frequency may make system can't boot, clear CMOS to overcome wrong frequency issue.

for FSB(Front Side Bus) frequency=533Mhz,

▶▶ 3 Memory Frequency = Host clock x 3.

▶▶ 4 Memory Frequency = Host clock x 4.

▶▶ Auto Set Memory frequency by DRAM SPD data. (Default value)

for FSB(Front Side Bus) frequency=800Mhz,

▶▶ 2.00 Memory Frequency = Host clock x 2.

▶▶ 2.66 Memory Frequency = Host clock x 2.66.

▶▶ 3.00^(Note) Memory Frequency = Host clock x 3.

▶▶ Auto Set Memory frequency by DRAM SPD data. (Default value)

for FSB(Front Side Bus) frequency=1066Mhz,

▶▶ 1.5 Memory Frequency = Host clock x 1.5.

▶▶ 2 Memory Frequency = Host clock x 2.

▶▶ 2.66^(Note) Memory Frequency = Host clock x 2.66.

▶▶ 3 Memory Frequency = Host clock x 3.

▶▶ Auto Set Memory frequency by DRAM SPD data. (Default value)

☞ Memory Frequency (Mhz)

▶▶ The values depend on **CPU Host Frequency(Mhz)** and **Memory Frequency For** setting.

☞ DIMM OverVoltage Control

▶▶ Normal Set DIMM OverVoltage Control to Normal. (Default value)

▶▶ +0.1V Set DIMM OverVoltage Control to +0.1V.

▶▶ +0.2V Set DIMM OverVoltage Control to +0.2V.

▶▶ +0.3V Set DIMM OverVoltage Control to +0.3V.

☞ PCI-E OverVoltage Control

▶▶ Normal Set PCI-E OverVoltage Control to Normal. (Default value)

▶▶ +0.1V Set PCI-E OverVoltage Control to +0.1V.

▶▶ +0.2V Set PCI-E OverVoltage Control to +0.2V.

▶▶ +0.3V Set PCI-E OverVoltage Control to +0.3V.

☞ CPU Voltage Control

▶▶ Supports adjustable CPU Vcore from 0.8375V to 1.6000V. (Default value: Normal)

☞ Normal CPU Vcore

▶▶ Display your CPU Vcore voltage.

(Note) To use a DDRII 711 memory module on the motherboard, you must install a 1066MHz FSB processor and set **Memory Frequency For** to **2.66**.

To use a DDRII 600 memory module on the motherboard, you must install an 800MHz FSB processor and set **Memory Frequency For** to **3.00**.

2-8 Select Language

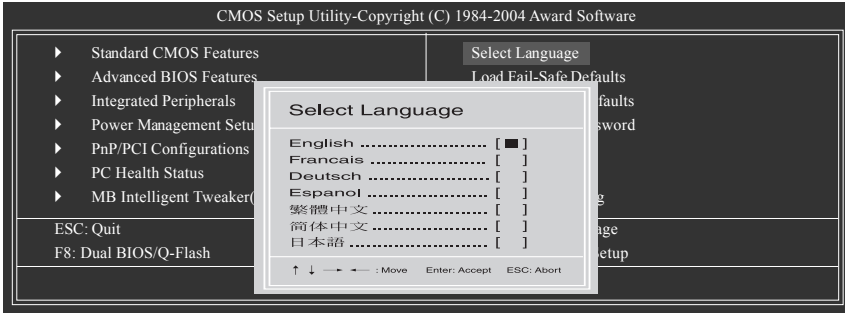

Multi-language supports 7 languages. There are English, French, German, Spanish, Traditional Chinese, Simplified Chinese, and Japanese.

2-9 Load Fail-Safe Defaults

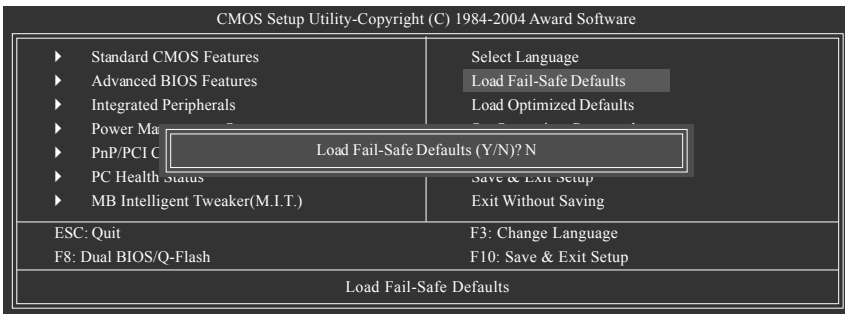

Fail-Safe defaults contain the most appropriate values of the system parameters that allow minimum system performance.

2-10 Load Optimized Defaults

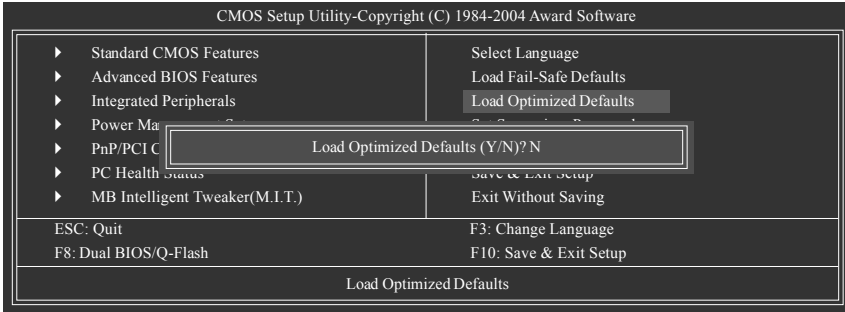

Selecting this field loads the factory defaults for BIOS and Chipset Features which the system automatically detects.

2-11 Set Supervisor/User Password

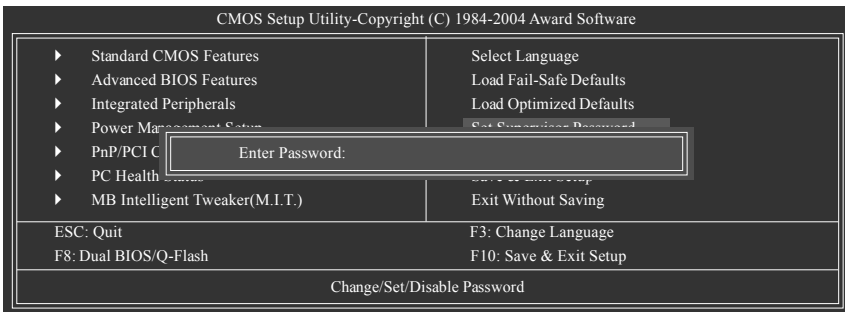

When you select this function, the following message will appear at the center of the screen to assist you in creating a password.

Type the password, up to eight characters, and press <Enter>. You will be asked to confirm the password. Type the password again and press <Enter>. You may also press <Esc> to abort the selection and not enter a password.

To disable password, just press <Enter> when you are prompted to enter password. A message "PASSWORD DISABLED" will appear to confirm the password being disabled. Once the password is disabled, the system will boot and you can enter Setup freely.

The BIOS Setup program allows you to specify two separate passwords:

SUPERVISOR PASSWORD and a USER PASSWORD. When disabled, anyone may access all BIOS Setup program function. When enabled, the Supervisor password is required for entering the BIOS Setup program and having full configuration fields, the User password is required to access only basic items.

If you select "System" at "Password Check" in Advance BIOS Features Menu, you will be prompted for the password every time the system is rebooted or any time you try to enter Setup Menu.

If you select "Setup" at "Password Check" in Advance BIOS Features Menu, you will be prompted only when you try to enter Setup.

2-12 Save & Exit Setup

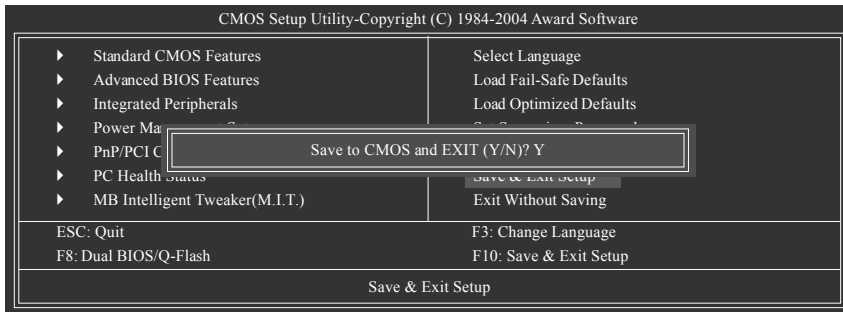

Type "Y" will quit the Setup Utility and save the user setup value to RTC CMOS.

Type "N" will return to Setup Utility.

2-13 Exit Without Saving

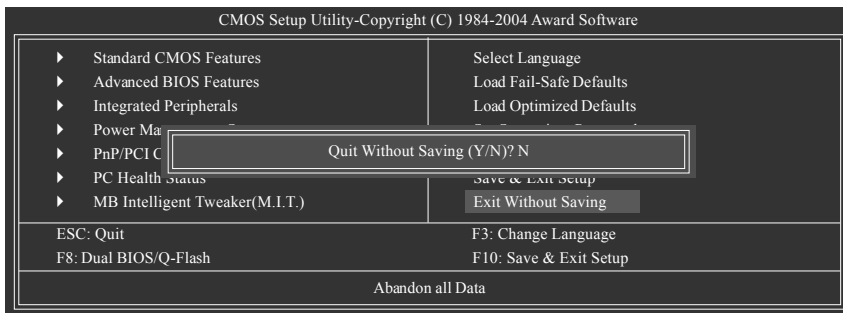

Type "Y" will quit the Setup Utility without saving to RTC CMOS.

Type "N" will return to Setup Utility.

Chapter 3 Drivers Installation



Pictures below are shown in Windows XP.

Insert the driver CD-title that came with your motherboard into your CD-ROM drive, the driver CD-title will auto start and show the installation guide. If not, please double click the CD-ROM device icon in "My computer", and execute the Run.exe.

3-1 Install Chipset Drivers

"Xpress Install " is now analyzing your computer...95%

After insert the driver CD, "Xpress Install" will scan automatically the system and then list all the drivers that recommended to install. Please pick the item that you want and press "install" followed the item; or you can press "Xpress Install" to install all items defaulted.

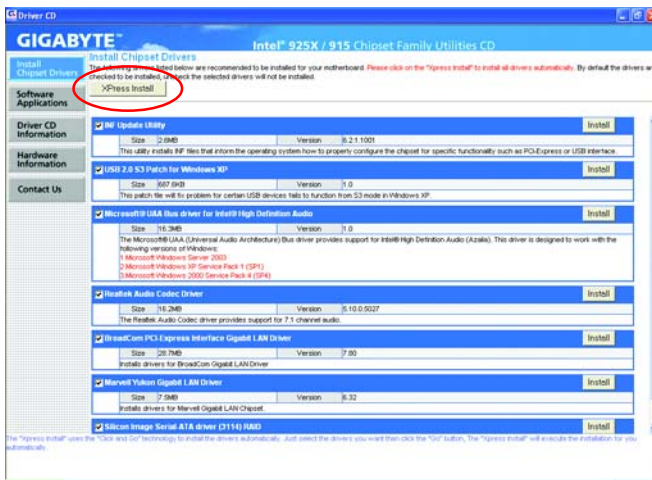

Some device drivers will restart your system automatically. After restarting your system the "Xpress Install" will continue to install other drivers. System will reboot automatically after install the drivers, afterward you can install others application.



For USB2.0 driver support under Windows XP operating system, please use Windows Service Pack. After install Windows Service Pack, it will show a question mark "?" in "Universal Serial Bus controller" under "Device Manager". Please remove the question mark and restart the system (System will auto-detect the right USB2.0 driver).

3-2 Software Applications

This page displays all the tools that Gigabyte developed and some free software, you can choose anyone you want and press "install" to install them.

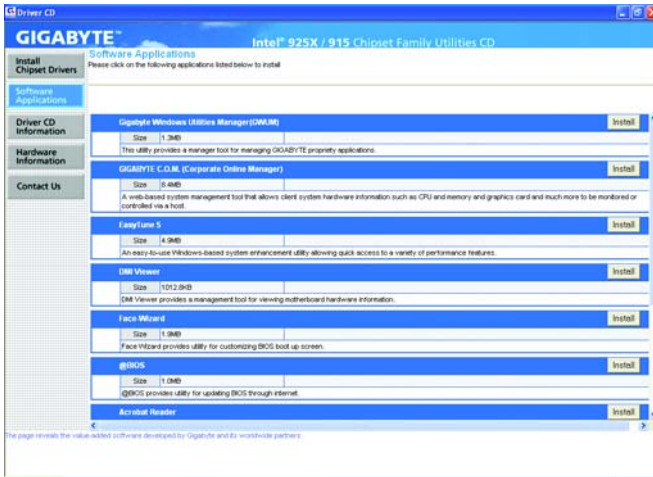

3-3 Driver CD Information

This page lists the contents of software and drivers in this CD-title.



3-4 Hardware Information

This page lists all device you have for this motherboard.

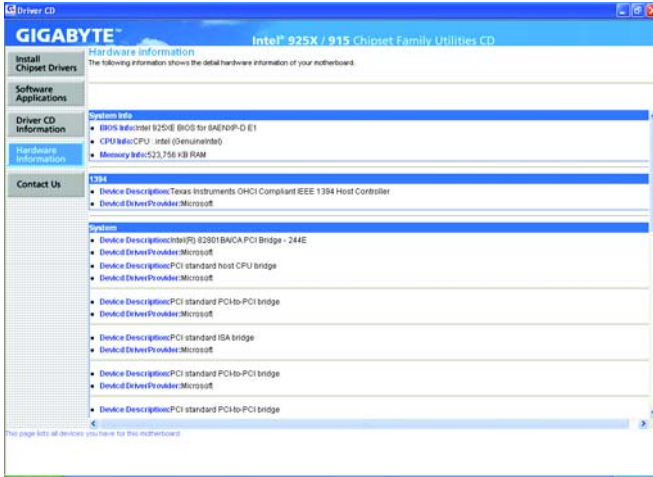

3-5 Contact Us

Please see the last page for details.



Chapter 4 Appendix

4-1 Unique Software Utilities

(Not all model support these Unique Software Utilities, please check your MB features.)



U-PLUS D.P.S. (Universal Plus Dual Power System)

The U-Plus Dual Power System (U-Plus DPS) is a revolutionary eight-phase power circuit built for ultimate system protection. Designed to withstand varying current levels and changes, the U-Plus D.P.S. provides an immensely durable and stable power circuit to the CPU for solid system stability. These characteristics make it the ideal companion with the latest LGA775 Intel® Pentium® 4 Processor as well as future Intel® processors. As well, 4 blue LED's are mounted on the U-Plus D.P.S. for intelligent indication of system loading.



M.I.T. (Motherboard Intelligent Tweaker)

Motherboard Intelligent Tweaker (M.I.T.) allows user to access and change BIOS feature settings with relative speed and ease. Through GIGABYTE M.I.T. feature the user is no longer required to switch into different modes within BIOS setup in order to change system settings such as the CPU system bus, memory timings or to enable Gigabyte's unique C.I.A. 2 and M.I.B. 2 features. M.I.T.'s integration of all platform performance settings into a single mode now gives any user the ability to control and enhance their computer system to the desired level.



C.I.A.2 (CPU Intelligent Accelerator 2)

GIGABYTE CPU Intelligent Accelerator 2(C.I.A. 2) is designed to automatically adjust CPU computing power to maximize system performance. When enabled, the program detects the current CPU loading and automatically accelerates the CPU computing performance to allow for a faster and smoother execution of programs. When the function is disabled, the CPU is returned to its initial status.



M.I.B.2 (Memory Intelligent Booster 2)

Built on the original M.I.B., the new Memory Intelligent Booster 2 (M.I.B. 2) is designed especially to maximize memory performance and boost memory bandwidth up to 10%. With added branded memory module information, users are able to optimize memory performance by selecting from a recommended memory module list.



S.O.S. (System Overclock Saver)

System Overclock Saver (S.O.S.) is a unique feature that eliminates system boot-up errors resulting from system over-enhancement by the user. With GIGABYTE's proprietary S.O.S. feature, users no longer need to open up the PC chassis and short-circuit the "Clear CMOS" pins or the battery on the motherboard to reset the system back to factory default settings. Instead, S.O.S. automatically resets the overclocked system settings back to their factory defaults to provide a more user-friendly and reliable platform for users.



Download Center

Download Center allows users to quickly download and update their BIOS as well as the latest drivers for their system. Download Center automatically runs a system check of the user PC and provides the user with the current system information as well as displaying a detailed list of all new drivers with the option for download.



C.O.M. (Corporate Online Management)

A web-based system management tool that allows system hardware information such as CPU, memory, graphics card, etc. to be monitored and controlled via the Internet. C.O.M. allows corporate MIS engineers to easily maintain corporate computers such as providing the most up-to-date drivers and BIOS. (Do not use C.O.M. and @BIOS at the same time.)

4-1-1 EasyTune 5 Introduction

EasyTune 5 presents the most convenient Windows based system performance enhancement and manageability utility. Featuring several powerful yet easy to use tools such as 1) Overclocking for enhancing system performance, 2) C.I.A. and M.I.B. for special enhancement for CPU and Memory, 3) Smart-Fan control for managing fan speed control of both CPU cooling fan and North-Bridge Chipset cooling fan, 4) PC health for monitoring system status.^(Note)

User Interface Overview



	Button / Display	Description
1.	Overclocking	Enters the Overclocking setting page
2.	C.I.A./C.I.A.2 and M.I.B./M.I.B.2	Enters the C.I.A./2 and M.I.B./2 setting page
3.	Smart-Fan	Enters the Smart-Fan setting page
4.	PC Health	Enters the PC Health setting page
5.	GO	Confirmation and Execution button
6.	"Easy Mode" & "Advance Mode"	Toggles between Easy and Advance Mode
7.	Display screen	Display panel of CPU frequency
8.	Function display LEDs	Shows the current functions status
9.	GIGABYTE Logo	Log on to GIGABYTE website
10.	Help button	Display EasyTune™ 5 Help file
11.	Exit or Minimize button	Quit or Minimize EasyTune™ 5 software

(Note) EasyTune 5 functions may vary depending on different motherboards.

4-1-2 Xpress Recovery Introduction



What is Xpress Recovery ?

Xpress Recovery is a utility used to back up and restore an OS partition. If the hard drive is not working properly, the user can restore the drive to its original state.



1. Supports FAT16, FAT32, and NTFS formats
2. Must be connected to the IDE1 Master
3. Allows installation of only one OS
4. Must be used with an IDE hard disk supporting HPA
5. The first partition must be set as the boot partition. When the boot partition is backed up, please do not alter its size.
6. Xpress Recovery is recommended when using Ghost to return boot manager to NTFS format.

How to use the Xpress Recovery

1. Boot from CD-ROM (BMP Mode)

Enter the BIOS menu, select "Advanced BIOS Feature" and set to boot from CD-ROM. Insert the provided driver CD into your CD drive, then save and exit the BIOS menu. Once the computer has restarted, the phrase "Boot from CD:" will appear at the bottom left-hand corner of the screen. When "Boot from CD:" appears, press any key to enter Xpress Recovery.

Once you have completed this step, subsequent access to Xpress Recovery can also function by pressing the F9 key during computer power on.



Boot from CD:

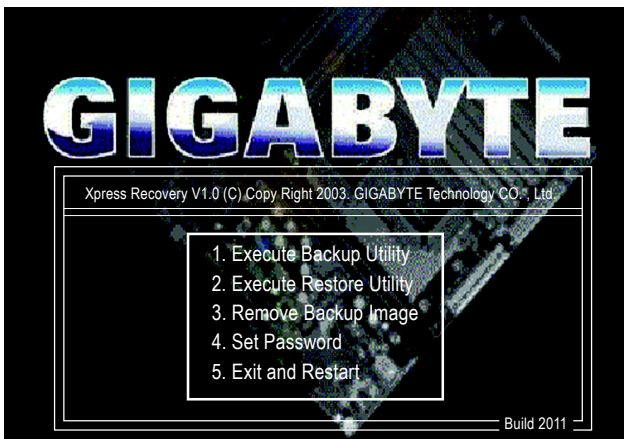

1. Execute Backup Utility:

Press B to Backup your System or Esc to Exit

The backup utility will automatically scan your system and back up data as a backup image in your hard drive.



Not all systems support access to Xpress Recovery by pressing the F9 key during computer power on. If this is the case, please use the boot from CD-ROM method to enter Xpress Recovery.

2. Execute Restore Utility:

This program will recover your system to factory default.

Press R to restore your system back to factory default or press Esc to exit

Restores backup image to original state.

3. Remove Backup Image:

Remove backup image. Are you sure? (Y/N)

Remove the backup image.

4. Set Password:

Please input a 4-16 character long password (a-z or 0-9) or press Esc to exit

You can set a password to enter Xpress Recovery to protect your hard disk data. Once this is done, password input will be required to enter Xpress Recovery during the next as well as subsequent system restarts. If you wish to remove the need for password entry, please select "Set Password" and under "New Password/Confirm Password", make sure there is no entry and then press "Enter" to remove password requirement.

5. Exit and Restart:

Exit and restart your computer.

4-1-3 Flash BIOS Method Introduction



A. What is Dual BIOS Technology?

Dual BIOS means that there are two system BIOS (ROM) on the motherboard, one is the Main BIOS and the other is Backup BIOS.

Under the normal circumstances, the system works on the Main BIOS. If the Main BIOS is corrupted or damaged, the Backup BIOS can take over while the system is powered on. This means that your PC will still be able to run stably as if nothing has happened in your BIOS.

B. How to use Dual BIOS and Q-Flash Utility?

a. After power on the computer, pressing immediately during POST (Power On Self Test) it will allow you to enter Award BIOS CMOS SETUP, then press <F8> to enter Flash utility.

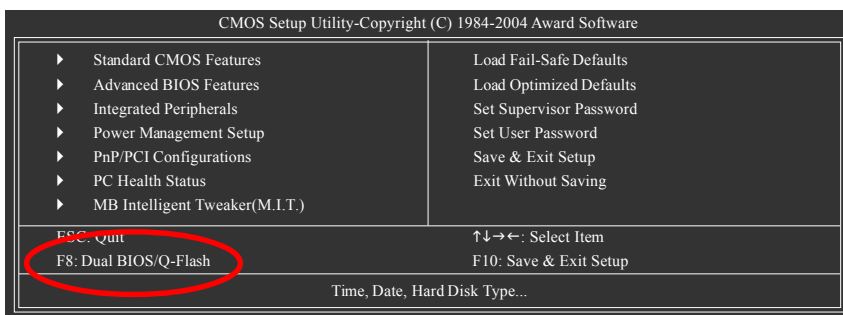

b. Dual BIOS / Q-Flash Programming Utility

Dual BIOS Utility V1.33		
Boot From.....	Main Bios	
Main ROM Type/Size.....	SST 49LF004A	512K
Backup ROM Type/Size.....	SST 49LF004A	512K
Wide Range Protection	Disable	
Boot From	Main Bios	
Auto Recovery	Enable	
Halt On Error	Disable	
Keep DMI Data	Enable	
Copy Main ROM Data to Backup		
Load Default Settings		
Save Settings to CMOS		
Q-Flash Utility		
Update Main BIOS from Floppy		
Update Backup BIOS from Floppy		
Save Main BIOS to Floppy		
Save Backup BIOS to Floppy		
PgDn/PgUp: Modify	↑↓: Move	ESC: Reset
		F10: Power Off

c. Dual BIOS Item explanation:

Wide Range Protection: Disable(Default), Enable

Status 1:

If any failure (ex. Update ESCD failure, checksum error or reset? occurs in the Main BIOS, just before the Operating System is loaded and after the power is on, and that the Wide Range Protection is set to "Enable", the PC will boot from Backup BIOS automatically.

Status 2:

If the ROM BIOS on peripherals cards(ex. SCSI Cards, LAN Cards,..) emits signals to request restart of the system after the user make any alteration on it, the boot up BIOS will not be changed to the Backup BIOS.

Boot From : Main BIOS(Default), Backup BIOS

Status 1:

The user can set to boot from Main BIOS or Backup BIOS.

Status 2:

If one of the Main BIOS or the Backup BIOS fails, this item "Boot From : Main BIOS(Default)" will become gray and will not be changed by user.

Auto Recovery : Enable(Default), Disable

When one of the Main BIOS or Backup BIOS occurs checksum failure, the working BIOS will automatically recover the BIOS of checksum failure.

(In the Power Management Setup of the BIOS Setting, if ACPI Suspend Type is set to Suspend to RAM, the Auto Recovery will be set to Enable automatically.)

(If you want to enter the BIOS setting, please press "Del" key when the boot screen appears.)

Halt On Error : Disable(Default), Enable

If the BIOS occurs a checksum error or the Main BIOS occurs a WIDE RANGE PROTECTION error and Halt On Error set to Enable, the PC will show messages on the boot screen, and the system will pause and wait for the user's instruction.

If Auto Recovery :Disable, it will show <or the other key to continue.>

If Auto Recovery :Enable, it will show <or the other key to Auto Recover.>

Keep DMI Data : Enable(Default), Disable

Enable: The DMI data won't be replaced by flashing new BIOS.(recommend)

Disable: The DMI data will be replaced by flashing new BIOS.

Copy Main ROM Data to Backup

(If you boot from Backup ROM, this item will change to Copy Backup ROM Data to Main)

Auto recovery message:

BIOS Recovery: Main to Backup

The means that the Main BIOS works normally and could automatically recover the Backup BIOS.

BIOS Recovery: Backup to Main

The means that the Backup BIOS works normally and could automatically recover the Main BIOS.

(This auto recovery utility is set by system automatically and can't be changed by user.)

Load Default Settings

Load dual BIOS default value.

Save Settings to CMOS

Save revised setting.



Method 1 : Q-Flash™ Utility

Q-Flash™ is a BIOS flash utility embedded in Flash ROM. With this utility, users only have to stay in the BIOS menu when they want to update BIOS. Q-Flash™ allows users to flash BIOS without any utility in DOS or

Windows. Using Q-Flash™ indicating no more fooling around with any complicated instructions and operating system since it is in the BIOS menu.



Please note that because updating BIOS has potential risk, please do it with caution!! We are sorry that Gigabyte Technology Co., Ltd is not responsible for damages of system because of incorrect manipulation of updating BIOS to avoid any claims from end-users.

Before You Begin:

Before you start updating BIOS with the Q-Flash™ utility, please follow the steps below first.

1. Download the latest BIOS for your motherboard from Gigabyte's website.
2. Extract the BIOS file downloaded and save the BIOS file (the one with model name.Fxx. For example, 8KNXPU.Fba) to a floppy disk.
3. Reboot your PC and press **Del** to enter BIOS menu.

The BIOS upgrading guides below are separated into two parts.

If your motherboard has dual-BIOS, please refer to **Part One**.

If your motherboard has single-BIOS, please refer to **Part Two**.

Part One:

Updating BIOS with Q-Flash™ Utility on Dual BIOS Motherboards.

Some of Gigabyte motherboards are equipped with dual BIOS. In the BIOS menu of the motherboards supporting Q-Flash and Dual BIOS, the Q-Flash utility and Dual BIOS utility are combined in the same screen. This section only deals with how to use Q-Flash utility.

In the following sections, we take GA-8KNXP Ultra as the example to guide you how to flash BIOS from an older version to the latest version. For example, from Fa3 to Fba.

The BIOS file is Fa3
before updating

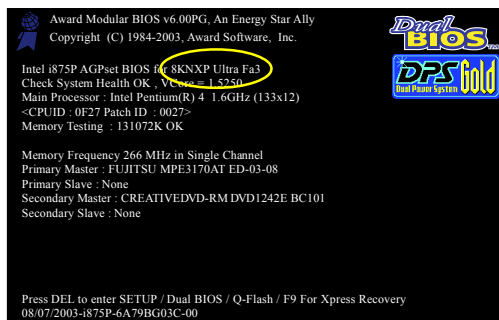

Entering the Q-Flash™ utility:

Step1: To use Q-Flash utility, you must press **Del** in the boot screen to enter BIOS menu.

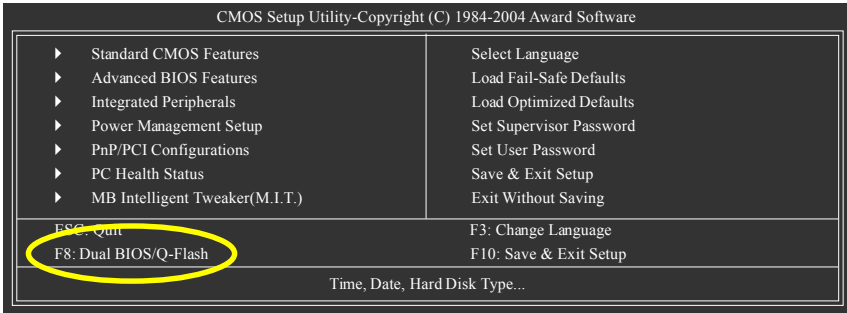

Step 2: Press **F8** button on your keyboard and then **Y** button to enter the Dual BIOS/Q-Flash utility.

Exploring the Q-Flash™ / Dual BIOS utility screen

The Q-Flash / Dual BIOS utility screen consists of the following key components.

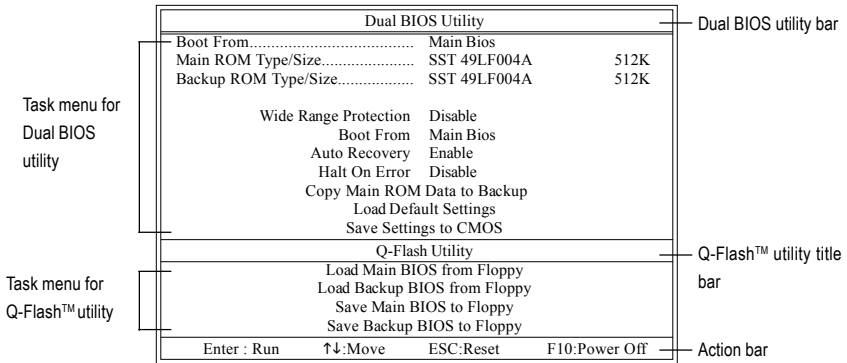

Task menu for Dual BIOS utility:

Contains the names of eight tasks and two item showing information about the BIOS ROM type. Blocking a task and pressing Enter key on your keyboard to enable execution of the task.

Task menu for Q-Flash utility:

Contains the names of four tasks. Blocking a task and pressing Enter key on your keyboard to enable execution of the task.

Action bar:

Contains the names of four actions needed to operate the Q-Flash/Dual BIOS utility. Pressing the buttons mentioned on your keyboards to perform these actions.

Using the Q-Flash™ utility:

This section tells you how to update BIOS using the Q-Flash utility. As described in the "Before you begin" section above, you must prepare a floppy disk having the BIOS file for your motherboard and insert it to your computer. If you have already put the floppy disk into your system and have entered the Q-Flash utility, please follow the steps below to flash BIOS.

Steps:

1. Press arrow buttons on your keyboard to move the light bar to "Load Main BIOS from Floppy" item in the Q-Flash menu and press Enter button.

Later, you will see a box pop up showing the BIOS files you previously downloaded to the floppy disk.



If you want to save the current BIOS for backup purpose, you can begin Step 1 with "Save Main BIOS to Floppy" item.

2. Move to the BIOS file you want to flash and press Enter.

In this example, we only download one BIOS file to the floppy disk so only one BIOS file, 8KNXPU.Fba, is listed.



Please confirm again you have the correct BIOS file for your motherboard.

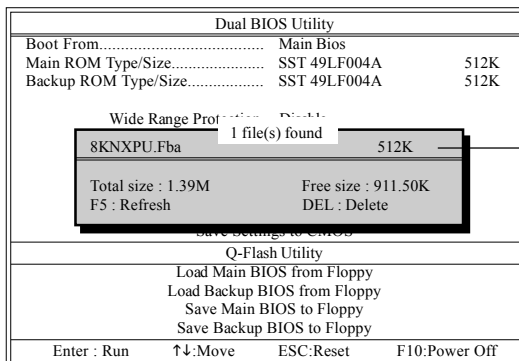

BIOS file in the floppy disk.

After pressing **Enter**, you'll then see the progress of reading the BIOS file from the floppy disk.

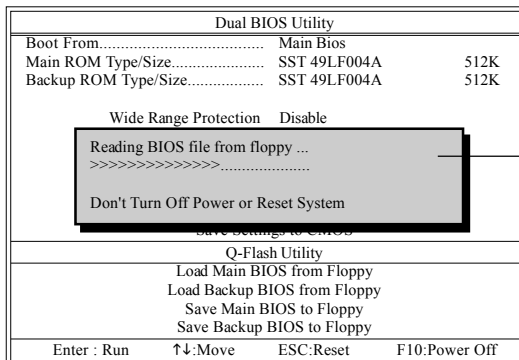

Do not turn off power or reset your system at this stage!!

After BIOS file is read, you'll see a confirmation dialog box asking you "Are you sure to update BIOS?"

- Press Y button on your keyboard after you are sure to update BIOS. Then it will begin to update BIOS. The progress of updating BIOS will be displayed.



Please do not take out the floppy disk when it begins flashing BIOS.

- Press any keys to return to the Q-Flash menu when the BIOS updating procedure is completed.

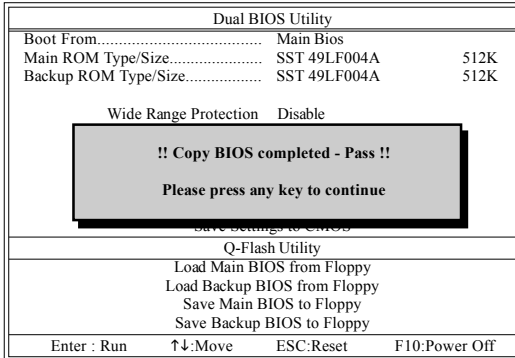

You can repeat Step 1 to 4 to flash the backup BIOS, too.

- Press Esc and then Y button to exit the Q-Flash utility. The computer will restart automatically after you exit Q-Flash.

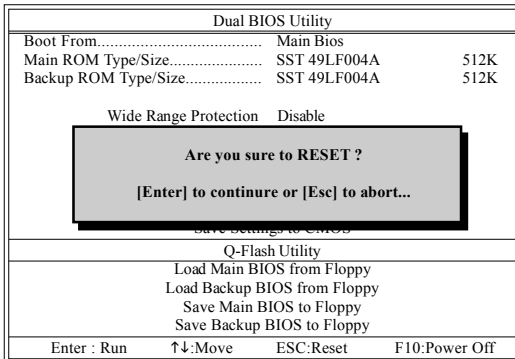

After system reboots, you may find the BIOS version on your boot screen becomes the one you flashed.

The BIOS file becomes Fba after updating.

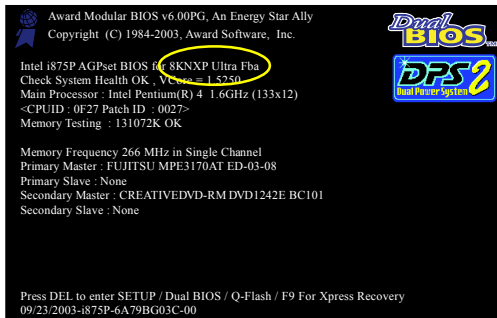

6. Press **Del** to enter BIOS menu after system reboots. When you are in BIOS menu, move to **Load Fail-Safe Defaults** item and press **Enter** to load BIOS Fail-Safe Defaults. Normally the system redetects all devices after BIOS has been upgraded. Therefore, we highly recommend reloading the BIOS defaults after BIOS has been upgraded.

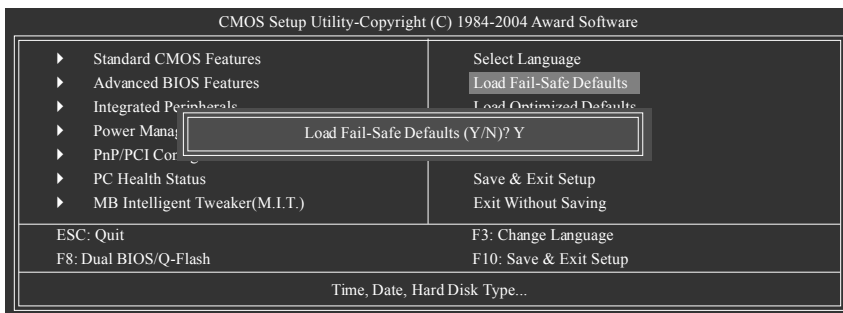

Press **Y** on your keyboard to load defaults.

7. Select **Save & Exit Setup** item to save the settings to CMOS and exit the BIOS menu. System will reboot after you exit the BIOS menu. The procedure is completed.

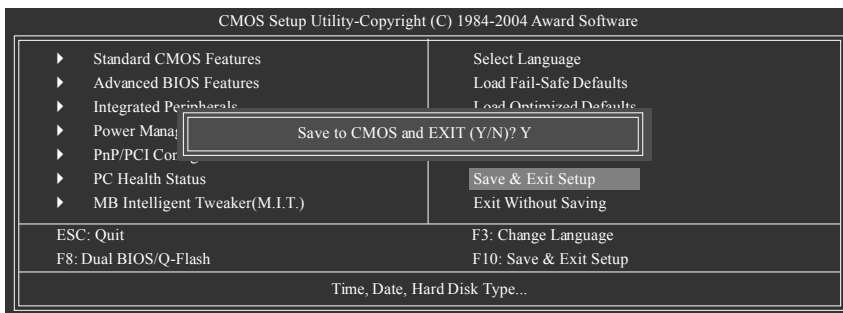

Press **Y** on your keyboard to save and exit.

Part Two:

Updating BIOS with Q-Flash™ Utility on Single-BIOS Motherboards.

This part guides users of single-BIOS motherboards how to update BIOS using the Q-Flash™ utility.

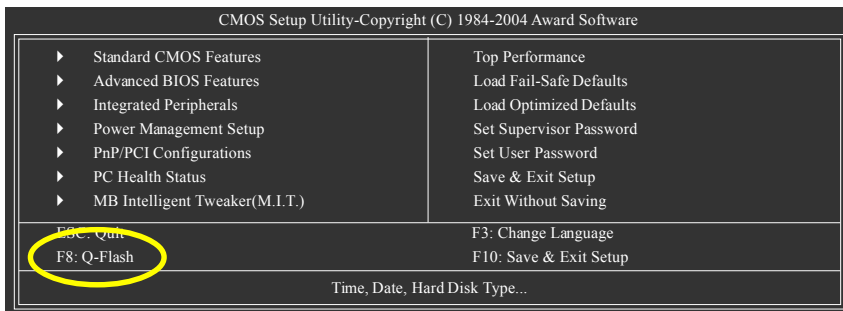

Exploring the Q-Flash™ utility screen

The Q-FlashBIOS utility screen consists of the following key components.

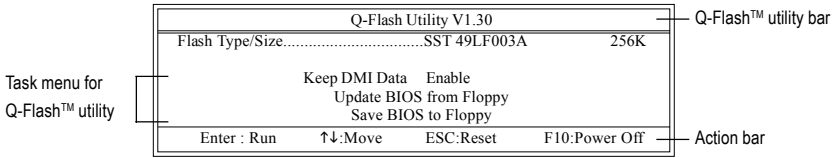

Task menu for Q-Flash utility:

Contains the names of three tasks. Blocking a task and pressing Enter key on your keyboard to enable execution of the task.

Action bar:

Contains the names of four actions needed to operate the Q-Flash utility. Pressing the buttons mentioned on your keyboards to perform these actions.

Using the Q-Flash™ utility:

This section tells you how to update BIOS using the Q-Flash utility. As described in the "Before you begin" section above, you must prepare a floppy disk having the BIOS file for your motherboard and insert it to your computer. If you have already put the floppy disk into your system and have entered the Q-Flash utility, please follow the steps below to flash BIOS.

Steps:

1. Press arrow buttons on your keyboard to move the light bar to "Update BIOS from Floppy" item in the Q-Flash menu and press Enter button.
Later, you will see a box pop up showing the BIOS files you previously downloaded to the floppy disk.



If you want to save the current BIOS for backup purpose, you can begin Step 1 with "Save BIOS to Floppy" item.

2. Move to the BIOS file you want to flash and press Enter.

In this example, we only download one BIOS file to the floppy disk so only one BIOS file, 8GE800.F4, is listed.



Please confirm again you have the correct BIOS file for your motherboard.

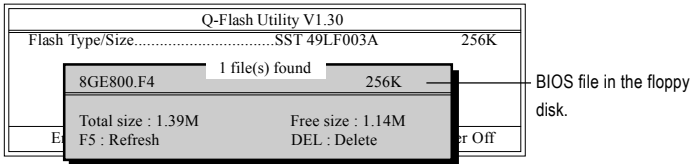

Do not turn off power or reset your system at this stage!!

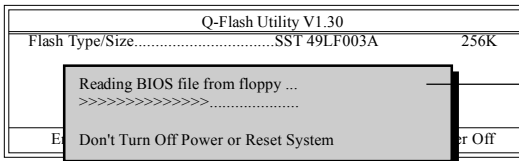

After BIOS file is read, you'll see a confirmation dialog box asking you "Are you sure to update BIOS?"



Please do not take out the floppy disk when it begins flashing BIOS.

- Press Y button on your keyboard after you are sure to update BIOS.
Then it will begin to update BIOS. The progress of updating BIOS will be shown at the same time.

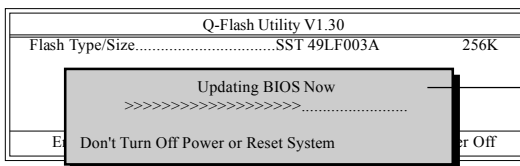

Do not turn off power or reset your system at this stage!!

- Press any keys to return to the Q-Flash menu when the BIOS updating procedure is completed.

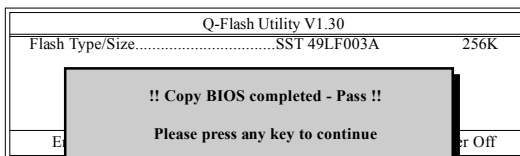

- Press Esc and then Y button to exit the Q-Flash utility. The computer will restart automatically after you exit Q-Flash.

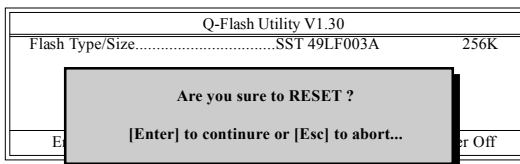

After system reboots, you may find the BIOS version on your boot screen becomes the one you flashed.

The BIOS file becomes F4 after updating

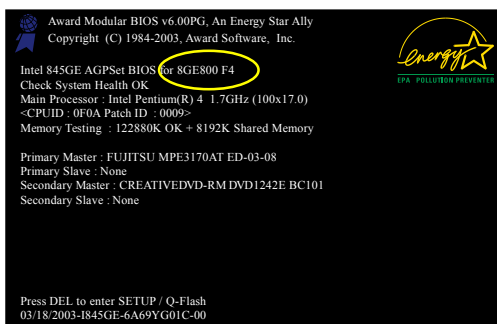

- Press Del to enter BIOS menu after system reboots and "Load BIOS Fail-Safe Defaults". See how to Load BIOS Fail-Safe Defaults, please kindly refer to Step 6 to 7 in **Part One**.

Congratulation!! You have updated BIOS successfully!!



Method 2 : @BIOS™ Utility

If you do not have a DOS startup disk, we recommend that you use the new @BIOS utility. @BIOS allows users to update their BIOS under Windows. Just select the desired @BIOS server to download the latest version of BIOS.

Fig 1. Installing the @BIOS utility

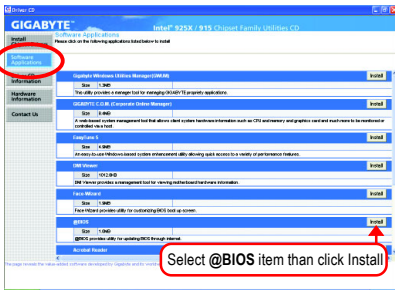

Fig 2. Installation complete and run @BIOS

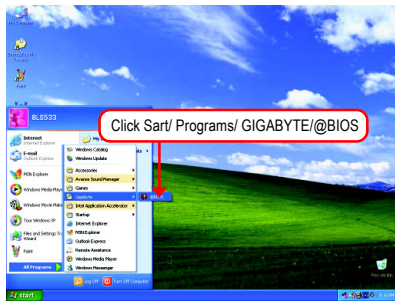

Fig 3. The @BIOS utility

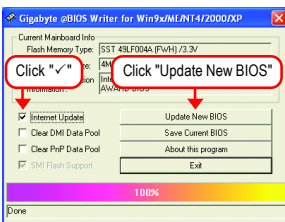
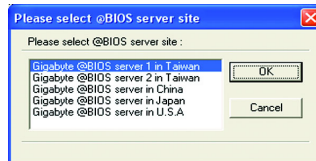

Fig 4. Select the desired @BIOS server



1. Methods and steps:

I. Update BIOS through Internet

- a. Click "Internet Update" icon
- b. Click "Update New BIOS" icon
- c. Select @BIOS™ sever
- d. Select the exact model name on your motherboard
- e. System will automatically download and update the BIOS.

II. Update BIOS NOT through Internet:

- a. Do not click "Internet Update" icon
- b. Click "Update New BIOS"
- c. Please select "All Files" in dialog box while opening the old file.
- d. Please search for BIOS unzip file, downloading from internet or any other methods (such as: 8AENXPD.F3d).
- e. Complete update process following the instruction.

III. Save BIOS

In the very beginning, there is "Save Current BIOS" icon shown in dialog box. It means to save the current BIOS version.

IV. Check out supported motherboard and Flash ROM:

In the very beginning, there is "About this program" icon shown in dialog box. It can help you check out which kind of motherboard and which brand of Flash ROM are supported.

2. Note:

- I. In method I, if it shows two or more motherboard's model names to be selected, please make sure your motherboard's model name again. Selecting wrong model name will cause the system unbooted.
- II. In method II, be sure that motherboard's model name in BIOS unzip file are the same as your motherboard's. Otherwise, your system won't boot.
- III. In method I, if the BIOS file you need cannot be found in @BIOS™ server, please go onto Gigabyte's web site for downloading and updating it according to method II.
- IV. Please note that any interruption during updating will cause system unbooted
- V. Do not use @BIOS and C.O.M. (Corporate Online Management) at the same time.

4-1-4 Serial ATA BIOS Setting Utility Introduction

RAID Levels

RAID (Redundant Array of Independent Disks) is a method of combining two hard disk drives into one logical unit. The advantage of an Array is to provide better performance or data fault tolerance. Fault tolerance is achieved through data redundant operation, where if one drives fails, a mirrored copy of the data can be found on another drive. This can prevent data loss if the operating system fails or hangs. The individual disk drives in an array are called members. The configuration information of each member is recorded in the reserved sector that identifies the drive as a member. All disk members in a formed disk array are recognized as a single physical drive to the operating system.

Hard disk drives can be combined together through a few different methods. The different methods are referred to as different RAID levels. Different RAID levels represent different performance levels, security levels and implementation costs. The RAID levels which the Intel® ICH6R chipset supports are RAID 0 and RAID 1.

RAID 0 (Striping)

RAID 0 reads and writes sectors of data interleaved between multiple drives. If any disk member fails, it affects the entire array. The disk array data capacity is equal to the number of drive members times the capacity of the smallest member. The striping block size can be set from 4KB to 128KB. RAID 0 does not support fault tolerance.

RAID 1 (Mirroring)

RAID 1 writes duplicate data onto a pair of drives and reads both sets of data in parallel. If one of the mirrored drives suffers a mechanical failure or does not respond, the remaining drive will continue to function. Due to redundancy, the drive capacity of the array is the capacity of the smallest drive. Under a RAID 1 setup, an extra drive called the spare drive can be attached. Such a drive will be activated to replace a failed drive that is part of a mirrored array. Due to the fault tolerance, if any RAID 1 drive fails, data access will not be affected as long as there are other working drives in the array.

Please follow the steps below to construct a complete RAID array:

- 1) Have ready your hard drives for RAID construction.
Note: To achieve best performance, it is recommended that the hard drives used are of similar make and storage capacity.
- 2) Please attach the hard drive connectors to their appropriate location on the motherboard ie. IDE, SCSI, or SATA.
- 3) Enter the motherboard BIOS and locate RAID setup (Please refer to the section on Integrated Peripherals).
- 4) Enter RAID setup in the BIOS and select the RAID type (For instance, enter Ctrl + I to select Intel RAID; Ctrl + S to select Silicon Image).
- 5) Complete driver installation.
- 6) Complete RAID utility installation.

More information on steps 4 and 5 is provided. (For more detailed setup information, please visit "Support\ Motherboard\ Technology Guide section" on our website at <http://www.gigabyte.com.tw> to read or download the information you need.)

Configuring the Intel RAID BIOS

The Intel RAID BIOS setup lets you choose the RAID array type and which hard drives you want to make part of the array.

Entering the RAID BIOS Setup

1. After rebooting your computer, wait until you see the RAID software prompting you to press Ctrl + I. The RAID prompt appears as part of the system POST and boot process prior to loading the OS. You have a few seconds to press Ctrl + I before the window disappears.

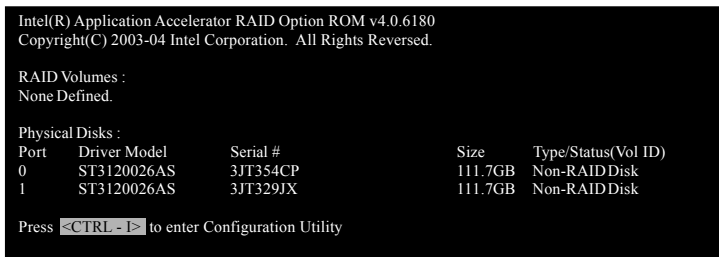

Press Ctrl + I. The Intel RAID Utility - Create RAID Volume window appears (as Figure below).

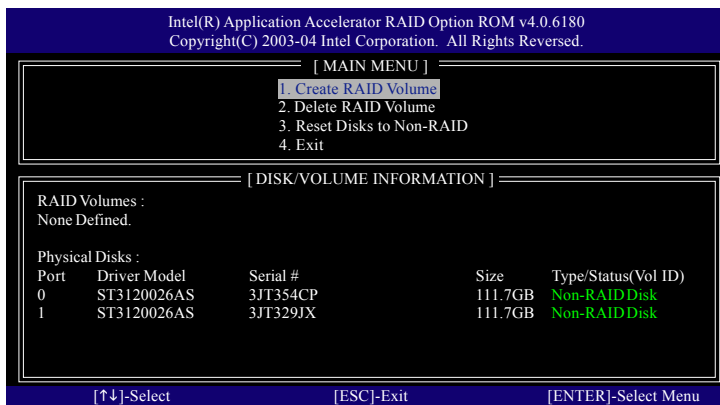

Create RAID Volume

Press **Enter** under **Create RAID Volume** to set up RAID.

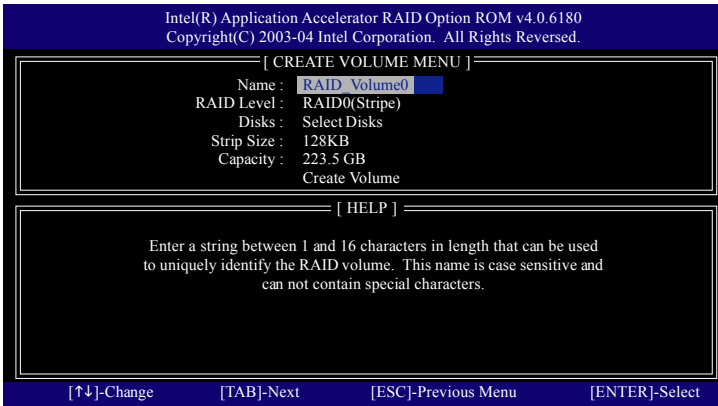

```

Intel(R) Application Accelerator RAID Option ROM v4.0.6180
Copyright(C) 2003-04 Intel Corporation. All Rights Reserved.

[ CREATE VOLUME MENU ]

Name : RAID_Volume0
RAID Level : RAID0(Stripe)
Disks : Select Disks
Strip Size : 128KB
Capacity : 223.5 GB
Create Volume

[ HELP ]

Enter a string between 1 and 16 characters in length that can be used
to uniquely identify the RAID volume. This name is case sensitive and
can not contain special characters.

[↑↓]-Change [TAB]-Next [ESC]-Previous Menu [ENTER]-Select
  
```

After entering the Create Volume Menu, you can set disk name with 1~16 letters (letters cannot be special characters) under **Name** item.

After setting disk name, press **Enter** to select **RAID Level**.

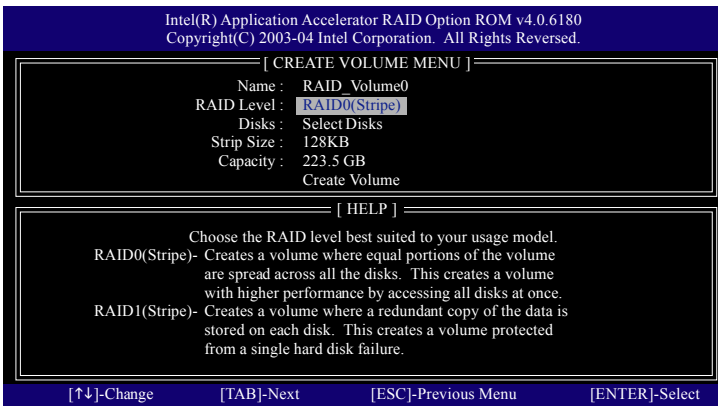

```

Intel(R) Application Accelerator RAID Option ROM v4.0.6180
Copyright(C) 2003-04 Intel Corporation. All Rights Reserved.

[ CREATE VOLUME MENU ]

Name : RAID_Volume0
RAID Level : RAID0(Stripe)
Disks : Select Disks
Strip Size : 128KB
Capacity : 223.5 GB
Create Volume

[ HELP ]

Choose the RAID level best suited to your usage model.
RAID0(Stripe)- Creates a volume where equal portions of the volume
are spread across all the disks. This creates a volume
with higher performance by accessing all disks at once.
RAID1(Stripe)- Creates a volume where a redundant copy of the data is
stored on each disk. This creates a volume protected
from a single hard disk failure.

[↑↓]-Change [TAB]-Next [ESC]-Previous Menu [ENTER]-Select
  
```

There are two RAID levels: RAID0(Stripe) and RAID1(Mirror). After selecting the RAID level, press **Enter** to select **Strip Size**.

The KB is a unit of Strip Size. You can set disk block size with this item.

The disk block size can be set from 4KB to 128KB. After you set disk block size, press **Enter** to set disk **Capacity**.

```

Intel(R) Application Accelerator RAID Option ROM v4.0.6180
Copyright(C) 2003-04 Intel Corporation. All Rights Reserved.

----- [ CREATE VOLUME MENU ] -----
Name : RAID_Volume0
RAID Level : RAID0(Stripe)
Disks : Select Disks
Strip Size : 128KB
Capacity : 223.5 GB
Create Volume

----- [ HELP ] -----

Choose the RAID level best suited to your usage model.
The following are typical values:
16KB - Best for sequential transfers
64KB - Good general purpose strip size
128KB - Best performance for most desktops and workstations

[↑↓]-Change [TAB]-Next [ESC]-Previous Menu [ENTER]-Select

```

```

Intel(R) Application Accelerator RAID Option ROM v4.0.6180
Copyright(C) 2003-04 Intel Corporation. All Rights Reserved.

----- [ CREATE VOLUME MENU ] -----
Name : RAID_Volume0
RAID Level : RAID0(Stripe)
Disks : Select Disks
Strip Size : 128KB
Capacity : 223.5 GB
Create Volume

----- [ HELP ] -----

Enter the volume capacity. The default value indicates the
maximum volume capacity using the selected disks. If less
than the maximum capacity is chosen, creation of a second
volume is needed to utilize the remaining space.

[↑↓]-Change [TAB]-Next [ESC]-Previous Menu [ENTER]-Select

```

Press **Enter** to enter **Create Volume** after setting disk capacity.

Press **Enter** under the **Create Volume** item.

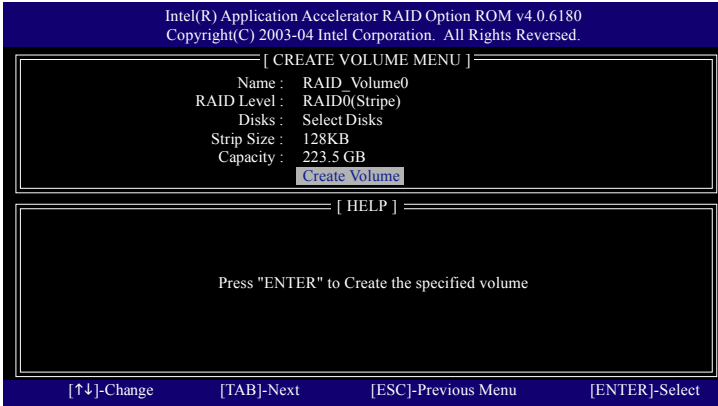

An alert bar will be displayed warning you that all data on selected disks will be lost. Please press **Y** to complete the set-up of RAID.

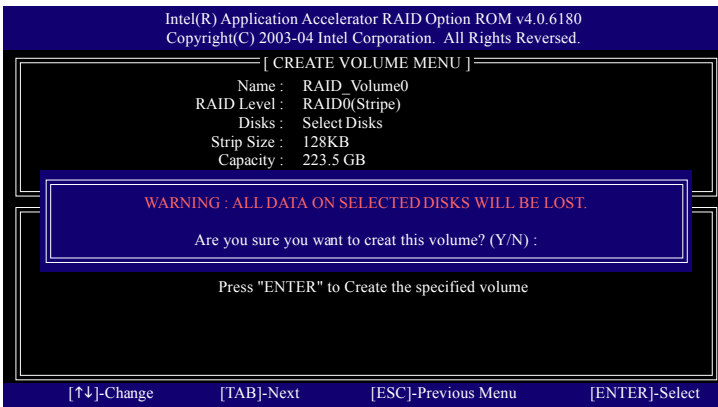

After the completion, you will see the detailed information about the RAID, such as RAID level, disk block size, disk name and disk capacity, etc.

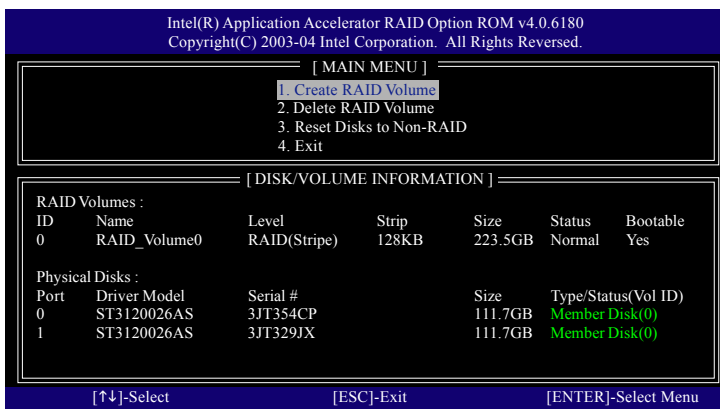

Delete RAID Volume

If you want to delete a RAID volume, please select the **Delete RAID Volume** option. Press **Enter** key and follow the instructions on the screen.

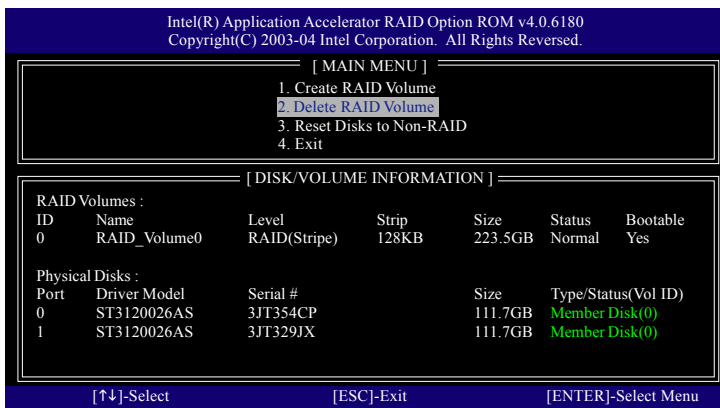



4-1-5 2-/4-/6-/8- Channel Audio Function Introduction

This motherboard provide 6 audio connector. You are able to use 2-/4-/6-/8-channels audio feature by audio software selection.

Introduction of audio connectors:

You may connect CD-ROM/DVD-ROM, walkman or others audio input to Line In.

The front channels or earphone can be connected to Line Out (Front Speaker Out).

Connect microphone to Mic In.

Connect the rear channels to Rear Speaker Out.

Connect the Center/Subwoofer channels to Center/Subwoofer Speaker Out.

Connect the side channels to Side Speaker Out.

The installation of audio software for Windows 2000/ XP is very simple. Please follow the steps to install the function.(Following pictures are in Windows XP)



If you set the **Front Panel Type** option to **HD Audio** in BIOS, make sure to connect your audio front panel cable(optional for different models) connector to the motherboard before system start-up or you'll not be able to see the front panel options from the **Sound Effect** application.



Stereo Speakers Connection and Settings:

We recommend that you use the speaker with amplifier to acquire the best sound effect if the stereo output is applied.

STEP 1:

Connect the stereo speakers or earphone to "Line Out".

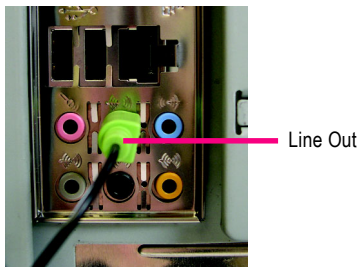

STEP 2 :

Following installation of the audio driver, you'll find a

Sound Effect  icon on the lower right hand taskbar.

Click the icon to select the function.



STEP 3:

Click "Speaker Configuration" then click on the left selection bar and select "2CH Speaker" to complete 2 channel audio configuration.

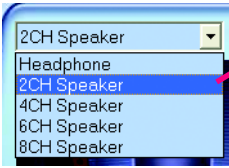

4 Channel Audio Setup

STEP 1 :

Connect the front channels to "Front Speaker Out", the rear channels to "Rear Speaker Out".

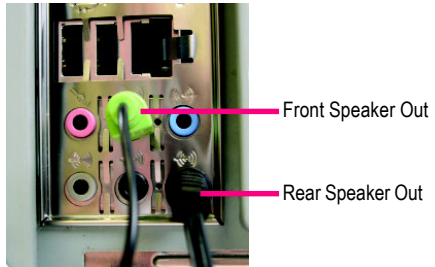

STEP 2 :

Following installation of the audio driver, you'll find a Sound Effect icon on the lower right hand taskbar. Click the icon to select the function.

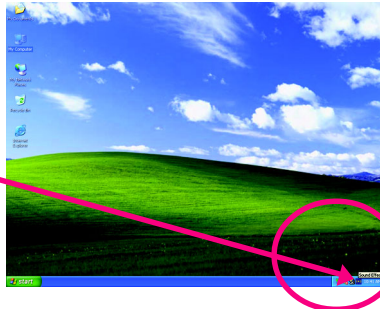

STEP 3:

Click "Speaker Configuration" then click on the left selection bar and select "4CH Speaker" to complete 4 channel audio configuration.

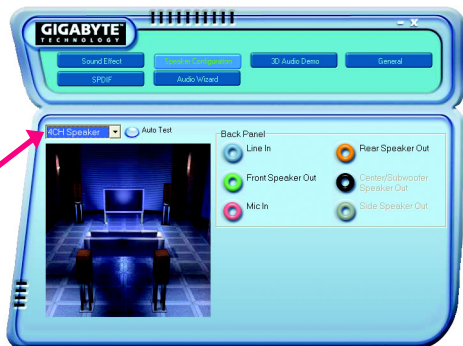
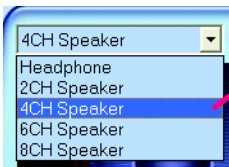

6 Channel Audio Setup

STEP 1 :

Connect the front channels to "Front Speaker Out", the rear channels to "Rear Speaker Out", and the Center/Subwoofer channels to "Center/Subwoofer Speaker Out".

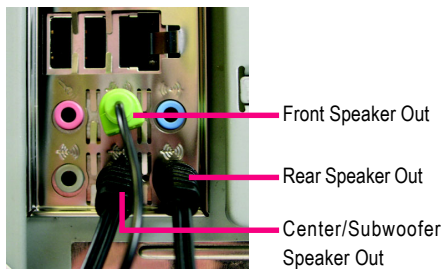

STEP 2 :

Following installation of the audio driver, you'll find a Sound Effect  icon on the lower right hand taskbar. Click the icon to select the function.

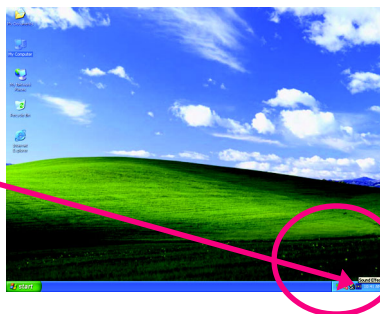

STEP 3:

Click "Speaker Configuration" then click on the left selection bar and select "6CH Speaker" to complete 6 channel audio configuration.

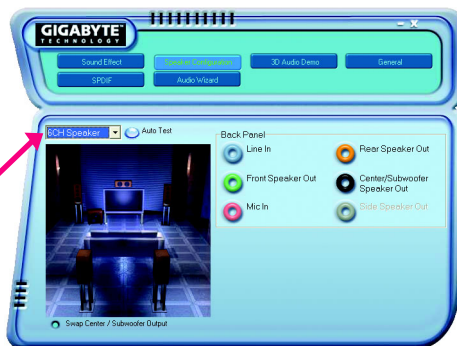
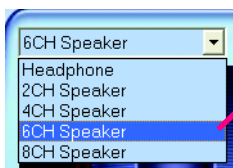

8 Channel Audio Setup

STEP 1 :

Connect the front channels to "Front Speaker Out", the rear channels to "Rear Speaker Out", the Center/Subwoofer channels to "Center/Subwoofer Speaker Out", and the side channels to "Side Speaker Out".

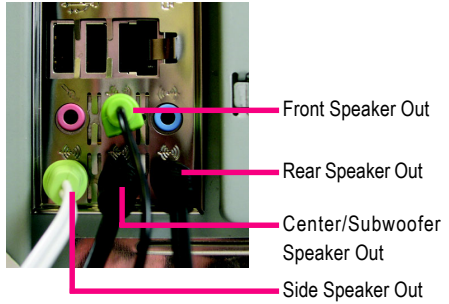

STEP 2 :

Following installation of the audio driver, you'll find a Sound Effect icon on the lower right hand taskbar. Click the icon to select the function.

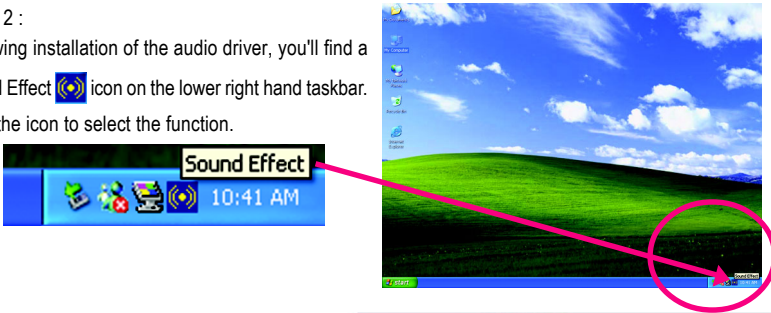

STEP 3:

Click "Speaker Configuration" then click on the left selection bar and select "8CH Speaker" to complete 8 channel audio configuration.

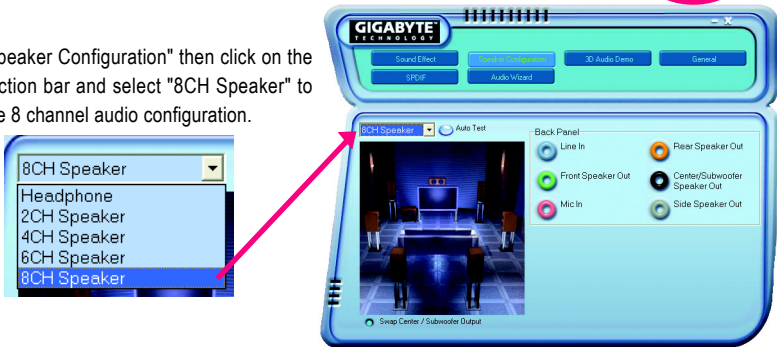

Sound Effect Configuration:

At the sound effect menu, users can adjust sound option settings as desired.



Jack-Sensing Introduction

Jack-Sensing provides audio connectors error-detection function.



Install Microsoft DirectX8.1 or later version before to enable Jack-Sensing support for Windows 2000.

After you install an audio device, a screen of a list would pop up from the audio software for you to choose the type of device you installed.

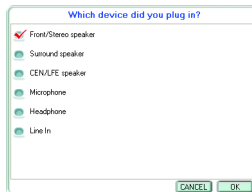

If you have connected your device to the wrong jack, the Jack-Sensing function would indicate the correct jack for your device and you can reconnect the device to the correct jack following the arrow instruction.



The correct icon for audio device will be displayed after the reinstallation.



4-2 Troubleshooting

Below is a collection of general asked questions. To check general asked questions based on a specific motherboard model, please log on to <http://www.gigabyte.com.tw>

Question 1: I cannot see some options that were included in previous BIOS after updating BIOS. Why?

Answer: Some advanced options are hidden in new BIOS version. Please press Ctrl and F1 keys after entering BIOS menu and you will be able to see these options.

Questions 2: Why is the light of my keyboard/optical mouse still on after computer shuts down?

Answer: In some boards, a small amount of electricity is kept on standby after computer shuts down and that's why the light is still on.

Question 3: How do I clear CMOS?

Answer: If your board has a Clear CMOS jumper, please refer to the Clear CMOS steps in the manual. If your board doesn't have such jumper, you can take off the on-board battery to leak voltage to clear CMOS. Please refer to the steps below:

Steps:

1. Turn off power.
2. Disconnect the power cord from MB.
3. Take out the battery gently and put it aside for about 10 minutes (Or you can use a metal object to connect the positive and negative pins in the battery holder to makethem short for one minute).
4. Re-insert the battery to the battery holder.
5. Connect power cord to MB again and turn on power.
6. Press Del to enter BIOS and load Fail-Safe Defaults(or load Optimized Defaults).
7. Save changes and reboot the system.

Question 4: Why do I still get a weak sound after turning up the speaker to the maximum volume?

Answer: Please make sure the speaker you are using is equipped with an internal amplifier. If not, please change another speaker with power/amplifier and try again later.

Question 5: Sometimes I hear different continuous beeps from computer after system boots up. What do these beeps usually stand for?

Answer: The beep codes below may help you identify the possible computer problems. However, they are only for reference purposes. The situations might differ from case to case.

→ AMI BIOS Beep Codes

*Computer gives 1 short beep when system boots successfully.

*Except for beep code 8, these codes are always fatal.

- 1 beep Refresh failure
- 2 beeps Parity error
- 3 beeps Base 64K memory failure
- 4 beeps Timer not operational
- 5 beeps Processor error
- 6 beeps 8042 - gate A20 failure
- 7 beeps Processor exception interrupt error
- 8 beeps Display memory read/write failure
- 9 beeps ROM checksum error
- 10 beeps CMOS shutdown register read/write error
- 11 beeps Cache memory bad

→ AWARD BIOS Beep Codes

- 1 short: System boots successfully
- 2 short: CMOS setting error
- 1 long 1 short: DRAM or M/B error
- 1 long 2 short: Monitor or display card error
- 1 long 3 short: Keyboard error
- 1 long 9 short: BIOS ROM error
- Continuous long beeps: DRAM error
- Continuous short beeps: Power error



Contact Us

● Taiwan (Headquarters)

GIGA-BYTE TECHNOLOGY CO., LTD.

Address: No.6, Bau Chiang Road, Hsin-Tien, Taipei 231, Taiwan

TEL: +886-2-8912-4888

FAX: +886-2-8912-4003

Tech. Support :

<http://tw.giga-byte.com/TechSupport/ServiceCenter.htm>

Non-Tech. Support(Sales/Marketing) :

<http://ggts.gigabyte.com.tw/nontech.asp>

WEB address (English): <http://www.gigabyte.com.tw>

WEB address (Chinese): <http://chinese.giga-byte.com>

● U.S.A.

G.B.T. INC.

TEL: +1-626-854-9338

FAX: +1-626-854-9339

Tech. Support :

<http://tw.giga-byte.com/TechSupport/ServiceCenter.htm>

Non-Tech. Support(Sales/Marketing) :

<http://ggts.gigabyte.com.tw/nontech.asp>

WEB address : <http://www.giga-byte.com>

● Germany

G.B.T. TECHNOLOGY TRADING GMBH

TEL: +49-40-2533040 (Sales)

+49-1803-428468 (Tech.)

FAX: +49-40-25492343 (Sales)

+49-1803-428329 (Tech.)

Tech. Support :

<http://tw.giga-byte.com/TechSupport/ServiceCenter.htm>

Non-Tech. Support(Sales/Marketing) :

<http://ggts.gigabyte.com.tw/nontech.asp>

WEB address : <http://www.gigabyte.de>

● Japan

NIPPON GIGA-BYTE CORPORATION

WEB address : <http://www.gigabyte.co.jp>

● Singapore

GIGA-BYTE SINGAPORE PTE. LTD.

Tech. Support :

<http://tw.giga-byte.com/TechSupport/ServiceCenter.htm>

Non-Tech. Support(Sales/Marketing) :

<http://ggts.gigabyte.com.tw/nontech.asp>

WEB address: <http://www.gigabyte.com.sg>

● U.K.

G.B.T. TECH. CO., LTD.

Tech. Support :

<http://tw.giga-byte.com/TechSupport/ServiceCenter.htm>

Non-Tech. Support(Sales/Marketing) :

<http://ggts.gigabyte.com.tw/nontech.asp>

WEB address : <http://uk.giga-byte.com>

● The Netherlands

GIGA-BYTE TECHNOLOGY B.V.

TEL: +31-40-290-2088

NL Tech.Support: 0900-GIGABYTE (0900-44422983)

BE Tech.Support: 0900-84034

FAX: +31-40-290-2089

Tech. Support :

<http://tw.giga-byte.com/TechSupport/ServiceCenter.htm>

Non-Tech. Support(Sales/Marketing) :

<http://ggts.gigabyte.com.tw/nontech.asp>

WEB address : <http://www.giga-byte.nl>

- **China**

NINGBO G.B.T. TECH. TRADING CO., LTD.

Tech. Support :

<http://tw.giga-byte.com/TechSupport/ServiceCenter.htm>

Non-Tech. Support(Sales/Marketing) :

<http://ggts.gigabyte.com.tw/nontech.asp>

WEB address : <http://www.gigabyte.com.cn>

Shanghai

TEL: +86-021-63410999

FAX: +86-021-63410100

Beijing

TEL: +86-10-62102838

FAX: +86-10-62102848

Wuhan

TEL: +86-27-87851061

FAX: +86-27-87851330

GuangZhou

TEL: +86-20-87586074

FAX: +86-20-85517843

Chengdu

TEL: +86-28-85236930

FAX: +86-28-85256822

Xian

TEL: +86-29-85531943

FAX: +86-29-85539821

Shenyang

TEL: +86-24-23960918

FAX: +86-24-23960918-809

- **Australia**

GIGABYTE TECHNOLOGY PTY. LTD.

Tech. Support :

<http://tw.giga-byte.com/TechSupport/ServiceCenter.htm>

Non-Tech. Support(Sales/Marketing) :

<http://ggts.gigabyte.com.tw/nontech.asp>

WEB address : <http://www.giga-byte.com.au>

- **France**

GIGABYTE TECHNOLOGY FRANCE S.A.R.L.

Tech. Support :

<http://tw.giga-byte.com/TechSupport/ServiceCenter.htm>

Non-Tech. Support(Sales/Marketing) :

<http://ggts.gigabyte.com.tw/nontech.asp>

WEB address : <http://www.gigabyte.fr>

- **Russia**

Moscow Representative Office Of GIGA-BYTE Technology Co., Ltd.

Tech. Support :

<http://tw.giga-byte.com/TechSupport/ServiceCenter.htm>

Non-Tech. Support(Sales/Marketing) :

<http://ggts.gigabyte.com.tw/nontech.asp>

WEB address : <http://www.gigabyte.ru>

- **Poland**

Office of GIGA-BYTE TECHNOLOGY Co., Ltd. in POLAND

Tech. Support :

<http://tw.giga-byte.com/TechSupport/ServiceCenter.htm>

Non-Tech. Support(Sales/Marketing) :

<http://ggts.gigabyte.com.tw/nontech.asp>

WEB address : <http://www.gigabyte.pl>

- **Serbia & Montenegro**

Representative Office Of GIGA-BYTE Technology Co., Ltd. in SERBIA & MONTENEGRO

Tech. Support :

<http://tw.giga-byte.com/TechSupport/ServiceCenter.htm>

Non-Tech. Support(Sales/Marketing) :

<http://ggts.gigabyte.com.tw/nontech.asp>

WEB address: <http://www.gigabyte.co.yu>

- **Czech Republic**

Representative Office Of GIGA-BYTE Technology Co., Ltd. in CZECH REPUBLIC

Tech. Support :

<http://tw.giga-byte.com/TechSupport/ServiceCenter.htm>

Non-Tech. Support(Sales/Marketing) :

<http://ggts.gigabyte.com.tw/nontech.asp>

WEB address: <http://www.gigabyte.cz>

- **Romania**

Representative Office Of GIGA-BYTE Technology Co., Ltd. in Romania

Tech. Support :

<http://tw.giga-byte.com/TechSupport/ServiceCenter.htm>

Non-Tech. Support(Sales/Marketing) :

<http://ggts.gigabyte.com.tw/nontech.asp>

WEB address: <http://www.gigabyte.com.ro>
