



When you installing AGP card, please make sure the following notice is fully understood and practiced. If your AGP card has "AGP 4X/8X(1.5V) notch"(show below), please make sure your AGP card is AGP 4X/8X(1.5V).



Caution: AGP 2X(3.3V) card is not supported by VIA® KM400. You might experience system unable to boot up normally. Please insert an AGP 4X/8X(1.5V) card

Example 1: Diamond Vipper V770 golden finger is compatible with 2X/4X mode AGP slot. It can be switched between AGP 2X(3.3V) or 4X(1.5V) mode by adjusting the jumper. The factory default for this card is 2X(3.3V).

The GA-7VM400M(F) motherboards might not function properly, if you install this card without switching the jumper to 4X(1.5V) mode in it.

Example 2: Some ATI Rage 128 Pro graphics cards made by "Power Color", the graphics card manufacturer & some SiS 305 cards, their golden finger is compatible with 2X(3.3V)/4X(1.5V) mode AGP slot, but they support 2X(3.3V) only.

The GA-7VM400M(F) motherboards might not function properly, If you install this card in it.

Note : Although Gigabyte's AG32S(G) graphics card is based on ATI Rage 128 Pro chip, the design of AG32S(G) is compliance with AGP 4X(1.5V) specification. Therefore, AG32S (G)will work fine with VIA® KM400 based motherboards.



Before you install PCI cards, please remove the Dual BIOS label from PCI slots if there is one.



- The author assumes no responsibility for any errors or omissions that may appear in this document nor does the author make a commitment to update the information contained herein.
- Third-party brands and names are the property of their respective owners.
- Please do not remove any labels on motherboard, this may void the warranty of this motherboard.
- Due to rapid change in technology, some of the specifications might be out of date before publication of this booklet.



WARNING: Never run the processor without the heatsink properly and firmly attached.
PERMANENT DAMAGE WILL RESULT!

Mise en garde : Ne faites jamais tourner le processeur sans que le dissipateur de chaleur soit fixé correctement et fermement. **UN DOMMAGE PERMANENT EN RÉSULTERA !**

Achtung: Der Prozessor darf nur in Betrieb genommen werden, wenn der Wärmeleiter ordnungsgemäß und fest angebracht ist. **DIES HAT EINEN PERMANENTEN SCHADEN ZUR FOLGE!**

Advertencia: Nunca haga funcionar el procesador sin el dissipador de calor instalado correcta y firmemente. **¡SE PRODUCIRÁ UN DAÑO PERMANENTE!**

Aviso: Nunca execute o processador sem o dissipador de calor estar adequado e firmemente conectado. **O RESULTADO SERÁ UM DANO PERMANENTE!**

警告: 將散熱板牢固地安裝到處理器上之前，不要運行處理器。過熱將永遠損壞處理器！

警告: 將散熱器牢固地安裝到處理器上之前，不要運行處理器。過熱將永遠損壞處理器！

경고: 히트싱크를 제대로 또 단단히 부착시키지 않은 채 프로세서를 구동시키지 마십시오. 영구적 고장이 발생할 수 있습니다!

警告: 永久的な損傷を防ぐため、ヒートシンクを正しくしっかりと取り付けきるまでは、プロセスを動作させないようにしてください。

Declaration of Conformity

We, Manufacturer/Importer
(full address)

G.B.T. Technology Trading GmbH
Ausschlagler Weg 41, 1F, 20537 Hamburg, Germany

declare that the product
(description of the apparatus, system, installation to which it refers)

Mother Board

GA-7VM400M(F)
is in conformity with

(reference to the specification under which conformity is declared)
in accordance with 89/336 EEC-EMC Directive

<input type="checkbox"/> EN 55011	Limits and methods of measurement of radio disturbance characteristics of industrial, scientific and medical (ISM) high frequency equipment	<input type="checkbox"/> EN 61000-3-2* <input checked="" type="checkbox"/> EN 60555-2	Disturbances in supply systems cause by household appliances and similar electrical equipment "Harmonics"
<input type="checkbox"/> EN 55013	Limits and methods of measurement of radio disturbance characteristics of broadcast receivers and associated equipment	<input type="checkbox"/> EN 61000-3-3* <input checked="" type="checkbox"/> EN 60555-3	Disturbances in supply systems cause by household appliances and similar electrical equipment "Voltage fluctuations"
<input type="checkbox"/> EN 55014	Limits and methods of measurement of radio disturbance characteristics of household electrical appliances, portable tools and similar electrical apparatus	<input checked="" type="checkbox"/> EN 50081-1 <input checked="" type="checkbox"/> EN 50082-1	Generic emission standard Part 1: Residual commercial and light industry Generic immunity standard Part 1: Residual commercial and light industry
<input type="checkbox"/> EN 55015	Limits and methods of measurement of radio disturbance characteristics of fluorescent lamps and luminaries	<input type="checkbox"/> EN 55081-2	Generic emission standard Part 2: Industrial environment
<input type="checkbox"/> EN 55020	Immunity from radio interference of broadcast receivers and associated equipment	<input type="checkbox"/> EN 55082-2	Generic emission standard Part 2: Industrial environment
<input checked="" type="checkbox"/> EN 55022	Limits and methods of measurement of radio disturbance characteristics of information technology equipment	<input type="checkbox"/> ENV 55104	Immunity requirements for household appliances tools and similar apparatus
<input type="checkbox"/> DIN VDE 0855 <input type="checkbox"/> part 10 <input type="checkbox"/> part 12	Cabled distribution systems; Equipment for receiving and/or distribution from sound and television signals	<input type="checkbox"/> EN 50091-2	EMC requirements for uninterruptible power systems (UPS)

CE marking



The manufacturer also declares the conformity of above mentioned product with the actual required safety standards in accordance with LVD 73/23 EEC

<input type="checkbox"/> EN 60065	Safety requirements for mains operated electronic and related apparatus for household and similar general use	<input type="checkbox"/> EN 60950	Safety for information technology equipment including electrical business equipment
<input type="checkbox"/> EN 60335	Safety of household and similar electrical appliances	<input type="checkbox"/> EN 50091-1	General and Safety requirements for uninterruptible power systems (UPS)

Manufacturer/Importer

(Stamp)

Date : June 20, 2003

Signature:

Name:

Timmy Huang
Timmy Huang

DECLARATION OF CONFORMITY

Per FCC Part 2 Section 2.1077(a)



Responsible PartName: G.B.T. INC. (U.S.A.)

**Address: 17358 Railroad Street
City of Industry, CA 91748**

Phone/Fax No: (818) 854-9338/ (818) 854-9339

hereby declares that the product

Product Name: Motherboard

Model Number: GA-7VM400M(F)

Conforms to the following specifications:

FCC Part 15, Subpart B, Section 15.107(a) and Section 15.109
(a), Class B Digital Device

Supplementary Information:

This device complies with part 15 of the FCC Rules. Operation is subject to the following two conditions: (1) This device may not cause harmful and (2) this device must accept any interference received, including that may cause undesired operation.

Representative Person's Name: ERIC LU

Signature: Eric Lu

Date: June 20, 2003

GA-7VM400M(F)
AMD Socket A Processor Motherboard

USER'S MANUAL

AMD Athlon™ / Athlon™ XP / Duron™ Socket A Processor Motherboard

Rev. 1001

12ME-7VM400MF-1001

Table of Content

Item Checklist	4
Features Summary	5
Chapter 1 Introduction	5
GA-7VM400M(F) Motherboard Layout	7
Block Diagram	8
Chapter 2 Hardware Installation Process	10
Step 1: Install the Central Processing Unit (CPU)	11
Step1-1: CPU Speed Setup	11
Step1-2: CPU Installation	12
Step1-3: CPU Cooling Fan Installation	13
Step 2: Install memory modules	14
Step 3: Install expansion cards	16
Step 4: Connect ribbon cables, cabinet wires, and power supply	17
Step4-1: I/O Back Panel Introduction	17
Step 4-2: Connectors Introduction	19
Chapter 3 BIOS Setup	31
The Main Menu (For example: BIOS Ver. : F2)	32
Standard CMOS Features	34
Advanced BIOS Features	37
Integrated Peripherals	39
Power Management Setup	43

PnP/PCI Configurations	46
PC Health Status	47
Frequency/Voltage Control	49
Load Fail-Safe Defaults	51
Load Optimized Defaults	52
Set Supervisor/User Password	53
Save & Exit Setup	54
Exit Without Saving	55
Chapter 4 Technical Reference	57
@ BIOS™ Introduction	57
Easy Tune™ 4 Introduction	58
Flash BIOS Method Introduction	59
2-/4-/6-Channel Audio Function Introuction	63
Chapter 5 Appendix	71

Item Checklist

- | | |
|---|--|
| <input checked="" type="checkbox"/> The GA-7VM400MF or GA-7VM400M motherboard | <input type="checkbox"/> 2 Port USB Cable x 1 |
| <input checked="" type="checkbox"/> IDE cable x 1/ Floppy cable x 1 | <input type="checkbox"/> 4 Port USB Cable x 1 |
| <input checked="" type="checkbox"/> CD for motherboard driver & utility | <input type="checkbox"/> SPDIF-KIT x 1 (SPDIF Out KIT) |
| <input checked="" type="checkbox"/> GA-7VM400M(F) user's manual | <input type="checkbox"/> IEEE 1394 Cable x 1 |
| <input checked="" type="checkbox"/> I/O Shield | <input type="checkbox"/> Audio Combo Kit x 1 |
| <input type="checkbox"/> Quick PC Installation Guide | (SURROUND-Kit + SPDIF Out KIT) |
| <input type="checkbox"/> RAID Manual | <input type="checkbox"/> Motherboard Settings Label |
| <input type="checkbox"/> GC-SATA Card (Optional) | <input type="checkbox"/> SATA RAID Manual |
| (Manual; SATA cable x1; Power cable x 1) | <input type="checkbox"/> SATA cable x2 |



Computer motherboards and expansion cards contain very delicate Integrated Circuit (IC) chips. To protect them against damage from static electricity, you should follow some precautions whenever you work on your computer.

1. Unplug your computer when working on the inside.
2. Use a grounded wrist strap before handling computer components. If you do not have one, touch both of your hands to a safely grounded object or to a metal object, such as the power supply case.
3. Hold components by the edges and try not to touch the IC chips, leads or connectors, or other components.
4. Place components on a grounded antistatic pad or on the bag that came with the components whenever the components are separated from the system.
5. Ensure that the ATX power supply is switched off before you plug in or remove the ATX power connector on the motherboard.

Installing the motherboard to the chassis...

If the motherboard has mounting holes, but they don't line up with the holes on the base and there are no slots to attach the spacers, do not become alarmed you can still attach the spacers to the mounting holes. Just cut the bottom portion of the spacers (the spacer may be a little hard to cut off, so be careful of your hands). In this way you can still attach the motherboard to the base without worrying about short circuits. Sometimes you may need to use the plastic springs to isolate the screw from the motherboard PCB surface, because the circuit wire may be near by the hole. Be careful, don't let the screw contact any printed circuit wire or parts on the PCB that are near the fixing hole, otherwise it may damage the board or cause board malfunctioning.

Chapter 1 Introduction

Features Summary

Form Factor	<ul style="list-style-type: none"> • 24.4cm x 23.3cm Micro ATX size form factor, 4 layers PCB.
CPU	<ul style="list-style-type: none"> • Socket A processor AMD Athlon™/Athlon™ XP/ Duron™ (K7) 128KL1 & 512K/256K/64K L2 cache on die 200/266/333MHz FSB and DDR bus speeds • Supports 1.4GHz and faster
Chipset	<ul style="list-style-type: none"> • VIA KM400 Memory/AGP/PCI Controller (PAC) • VIA VT8235 Integrated Peripheral Controller (PSIPC)
Memory	<ul style="list-style-type: none"> • 2 184-pin DDR sockets • Supports DDR333/DDR266/DDR200 DIMM • Supports up to 2GB DDR (Max) • Supports only 2.5V DDR DIMM
I/O Control	<ul style="list-style-type: none"> • IT8705
Slots	<ul style="list-style-type: none"> • 1 AGP slot supports 8X/4X/2X mode(1.5V) • 3 PCI slots supports 33MHz & PCI 2.2 compliant
On-Board IDE	<ul style="list-style-type: none"> • 2 IDE bus master (UDMA33/ATA66/ATA100/ATA133) IDE ports for up to 4 ATAPI devices • Supports PIO mode3,4 (UDMA33/ATA66/ATA100/ATA133) IDE & ATAPI CD-ROM
Hardware Monitor	<ul style="list-style-type: none"> • CPU/System Fan Revolution detect • CPU/System temperature detect • System Voltage Detect
On-Board Peripherals	<ul style="list-style-type: none"> • 1 Floppy port supports 2 FDD with 360K, 720K, 1.2M, 1.44M and 2.88M bytes. • 1 Parallel port supports Normal/EPP/ECP mode • 1 Serial port(COMA), 1 VGA port, COMB on Board • 6 USB 2.0/1.1 ports (2 x Rear, 4 xFront by cable) • 3 x IEEE1394 by cable (*) • 1 FrontAudio Connector

to be continued.....

(*) ForGA-7VM400MF only.

On-Board Sound	<ul style="list-style-type: none"> • Realtek ALC650 CODEC • Line Out / 2 front speaker • Line In / 2 rear speaker (by s/w switch) • Mic In / center & subwoofer (by s/w switch) • SPDIF Out / SPDIF In • CD_In / Game port
On-Board USB 2.0	<ul style="list-style-type: none"> • Built in VIA VT8235 Chipset
On-Board LAN	<ul style="list-style-type: none"> • Realtek RTL8100C
On-Board IEEE1394 (*)	<ul style="list-style-type: none"> • TI TSB43AB23
PS/2 Connector	<ul style="list-style-type: none"> • PS/2 Keyboard interface and PS/2 Mouse interface
BIOS	<ul style="list-style-type: none"> • Licensed Award BIOS • Supports Q-Flash
Additional Features	<ul style="list-style-type: none"> • PS/2 Keyboard power on by password, PS/2 Mouse power on • External Modem wake up • STR (Suspend-To-RAM) • AC Recovery • Poly fuse for keyboard over-current protection • USB KB/Mouse wake up from S3 • Support Thermal shutdown function • Supports @BIOS • Supports EasyTune 4
Overclocking	<ul style="list-style-type: none"> • Over Clock (DDR/AGP/CPU/PC) by BIOS



Please set the CPU host frequency in accordance with your processor's specifications. We don't recommend you to set the system bus frequency over the CPU's specification because these specific bus frequencies are not the standard specifications for CPU, chipset and most of the peripherals. Whether your system can run under these specific bus frequencies properly will depend on your hardware configurations, including CPU, Chipsets, SDRAM, Cards... etc.

(*) For GA-7VM400MF only.

GA-7VM400M(F) Motherboard Layout

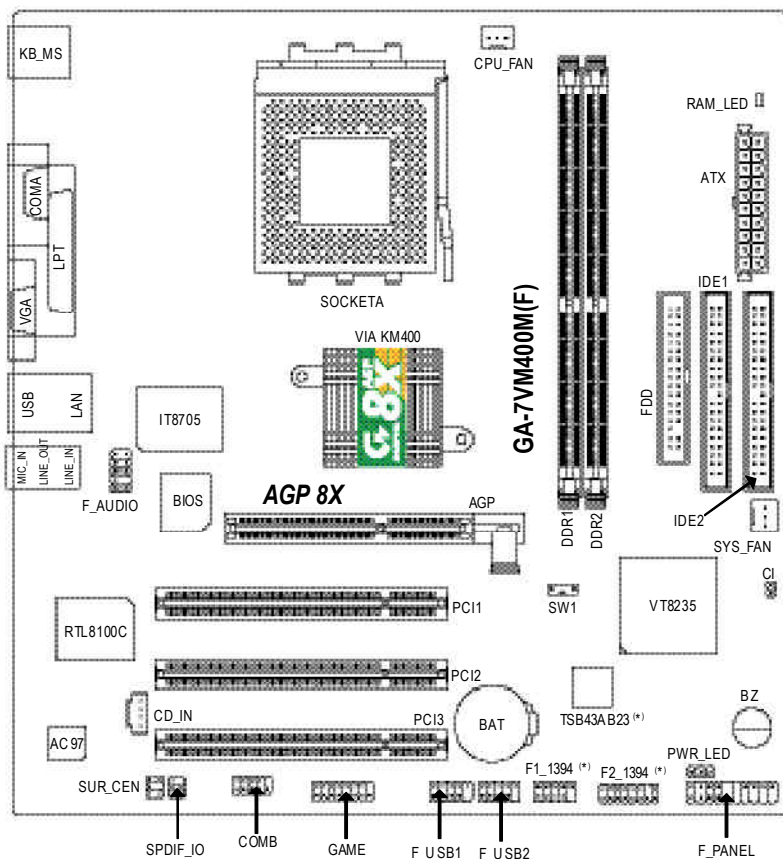

(*) For GA-7VM400MF only.

Block Diagram

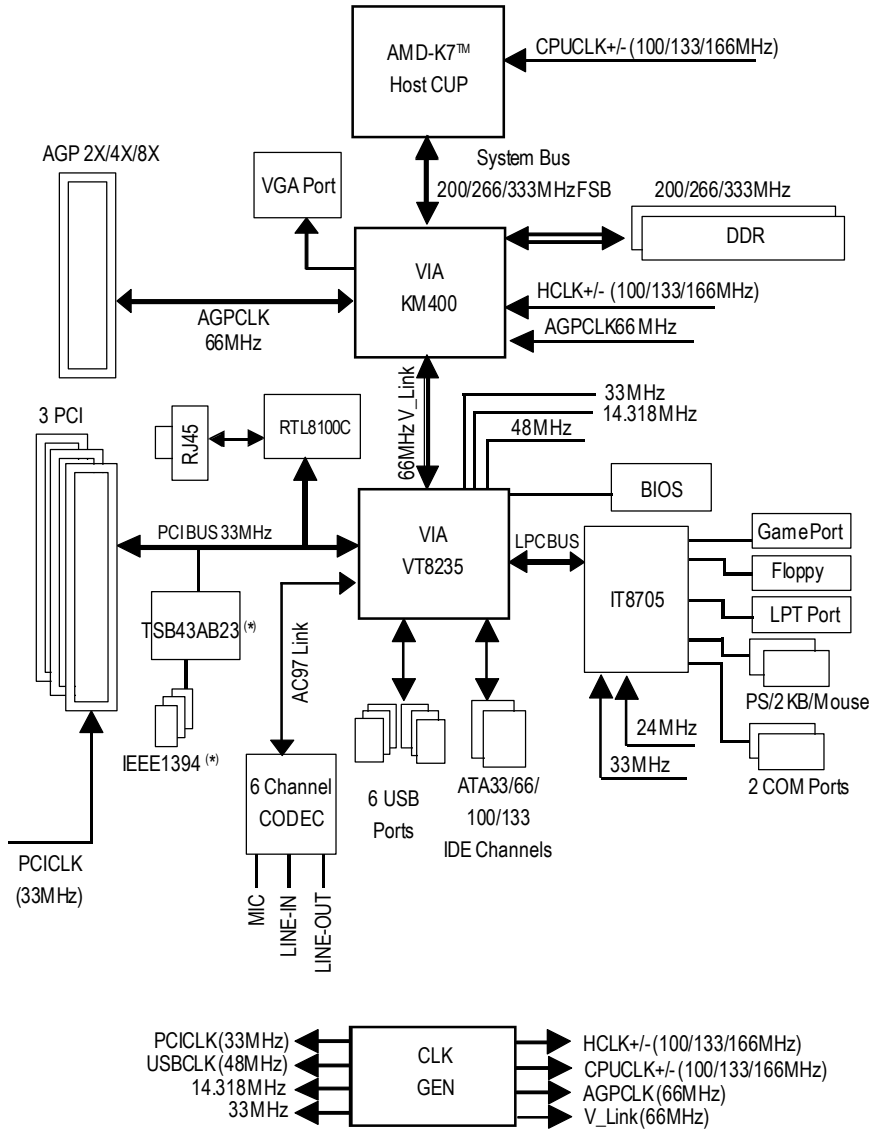

(*) For GA-7VM400MF only.

Lined writing area consisting of 20 horizontal lines.

Chapter 2 Hardware Installation Process

To set up your computer, you must complete the following steps:

- Step 1- Set system Switch (SW1)
- Step 2- Install the Central Processing Unit (CPU)
- Step 3- Install memory modules
- Step 4- Install expansion cards
- Step 5- Connect ribbon cables, cabinetwires, and power supply

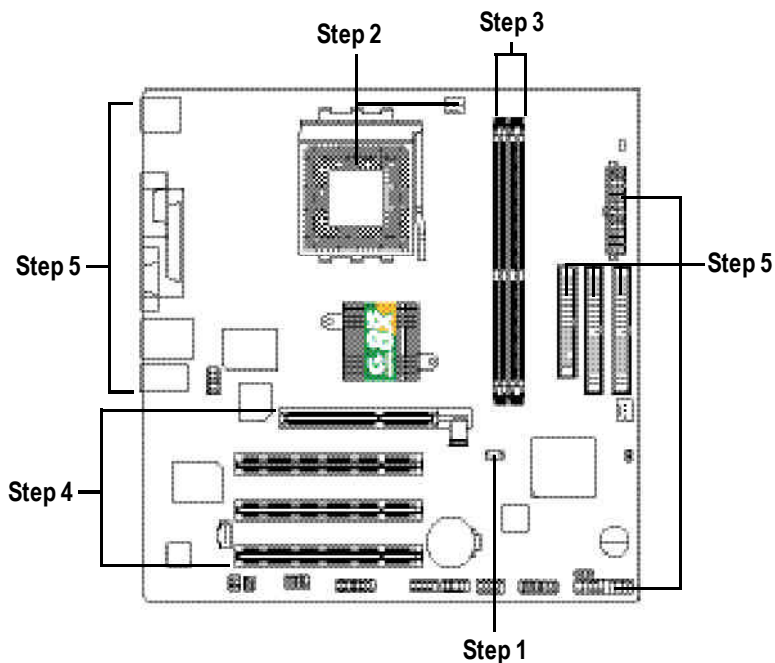

Congratulations you have accomplished the hardware installation!

Turn on the power supply or connect the power cable to the power outlet. Continue with the BIOS/ software installation.

Step 1: Install the Central Processing Unit (CPU)

Step1-1: CPU Speed Setup

The CPU FSB can be switched by SW1 and refer to below table.

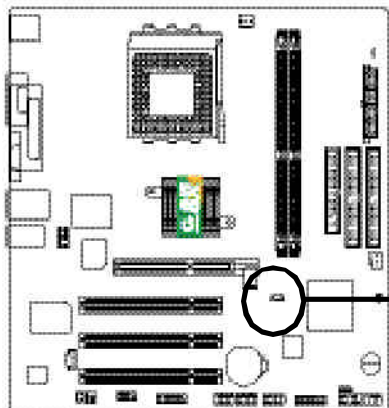

O: ON / X: OFF

SW1
ON 1

Default Setting: 100MHz

SW1	CPU CLOCK	
		100
1	ON	OFF

100 : Fix FSB 200MHz CPU

133/166: Support FSB 266/333MHz
CPU



You must set SW1 to 100MHz when
you used FSB 200MHz CPU.

Step1-2: CPU Installation



Before installing the processor, adhere to the following warning:

1. Please make sure the CPU type is supported by the motherboard.
2. If you do not match the CPU socket Pin 1 and CPU cut edge well, it will cause improper installation. Please change the insert orientation.

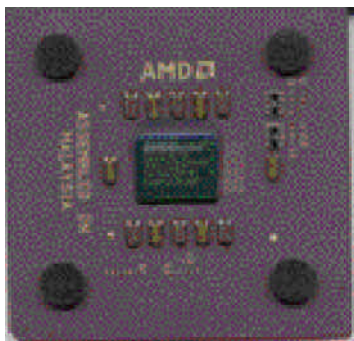

CPU Top View

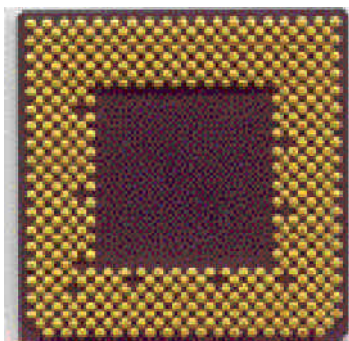

CPU Bottom View

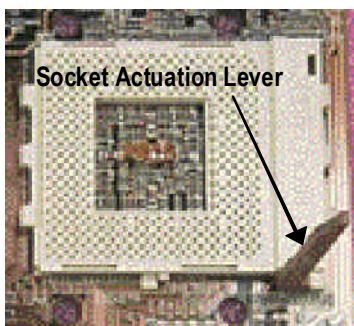

1. Pull up the CPU socket lever and up to 90-degree angle.

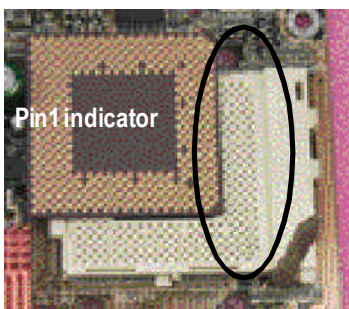

2. Locate Pin 1 in the socket and look for a (golden) cutedge on the CPU upper corner. Then insert the CPU into the socket.

Step1-3: CPU Cooling Fan Installation



Before installing the CPU Heat Sink , adhere to the following warning:

1. Please use AMD approved cooling fan.
2. We recommend you to apply the thermal paste to provide better heat conduction between your CPU and Cooling Fan.
3. Make sure the CPU fan power cable is plugged in to the CPU fan connector, this completes the installation.

Please refer to CPU cooling fan user's manual for more detail installation procedure.

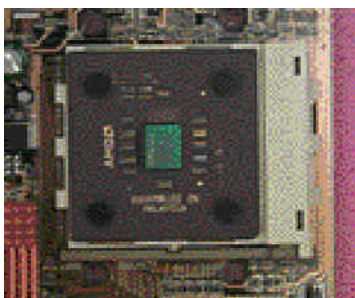

1. Press down the CPU socket lever and finish CPU installation.



2. Use qualified fan approved by AMD.

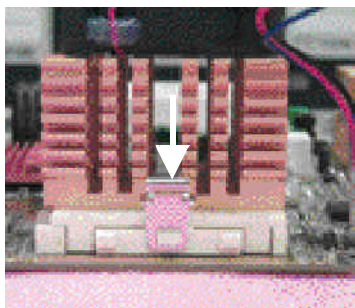

3. Fasten the cooling fan supporting-base onto the CPU socket on the main board.

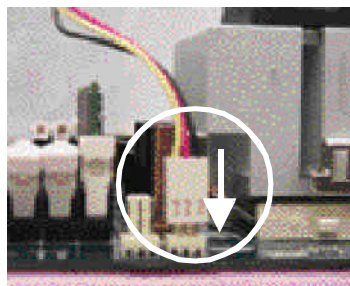

4. Make sure the CPU fan is plugged to the CPU fan connector, than install complete.

Step 2: Install memory modules



Before installing the memory modules, adhere to the following warning:

1. When RAM_LED is ON, do not install / remove DIMM from socket.
2. Please note that the DIMM module can only fit in one direction due to the one notch. Wrong orientation will cause improper installation. Please change the insert orientation.

The motherboard has 2 dual inline memory module (DIMM) sockets. The BIOS will automatically detect memory type and size. To install the memory module, just push it vertically into the DIMM Slot. The DIMM module can only fit in one direction due to the notch. Memory size can vary between sockets.

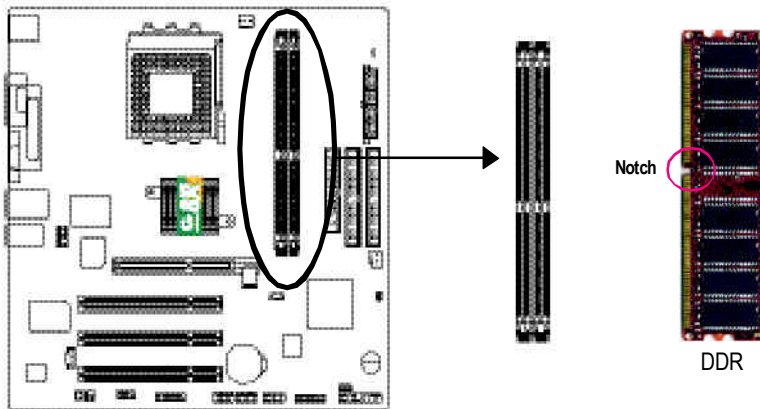

Support Unbuffered DDR DIMM Sizes type:

64 Mbit (2Mx8x4 banks)	64 Mbit (1Mx16x4 banks)	128 Mbit (4Mx8x4 banks)
128 Mbit (2Mx16x4 banks)	256 Mbit (8Mx8x4 banks)	256 Mbit (4Mx16x4 banks)
512 Mbit (16Mx8x4 banks)	512 Mbit (8Mx16x4 banks)	
Total System Memory (Max 2GB)		

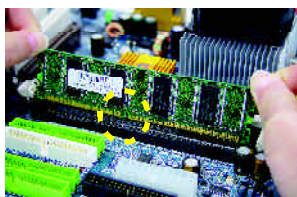

1. The DIMM slot has a notch, so the DIMM memory module can only fit in one direction.



2. Insert the DIMM memory module vertically into the DIMM slot. Then push it down.



3. Close the plastic clip at both edges of the DIMM slots to lock the DIMM module. Reverse the installation steps when you wish to remove the DIMM module.

DDR Introduction

Established on the existing SDRAM industry infrastructure, DDR (Double Data Rate) memory is a high performance and cost-effective solution that allows easy adoption for memory vendors, OEMs and system integrators.

DDR memory is a sensible evolutionary solution for the PC industry that builds on the existing SDRAM infrastructure, yet makes awesome advances in solving the system performance bottleneck by doubling the memory bandwidth. DDR SDRAM will offer a superior solution and migration path from existing SDRAM designs due to its availability, pricing and overall market support. PC2100 DDR memory (DDR266) doubles the data rate through reading and writing at both the rising and falling edge of the clock, achieving data bandwidth 2X greater than PC133 when running with the same DRAM clock frequency. With peak bandwidth of 2.664GB per second, DDR memory enables system OEMs to build high performance and low latency DRAM subsystems that are suitable for servers, workstations, high-end PC's and value desktop SMA systems. With a core voltage of only 2.5 volts compared to conventional SDRAM's 3.3 volts, DDR memory is a compelling solution for small form factor desktops and notebook applications.

Step 3: Install expansion cards

1. Read the related expansion card's instruction document before install the expansion card into the computer.
2. Remove your computer's chassis cover, necessary screws and slot bracket from the computer.
3. Press the expansion card firmly into expansion slot in motherboard.
4. Be sure the metal contacts on the card are indeed seated in the slot.
5. Replace the screw to secure the slot bracket of the expansion card.
6. Replace your computer's chassis cover.
7. Power on the computer, if necessary, setup BIOS utility of expansion card from BIOS.
8. Install related driver from the operating system.

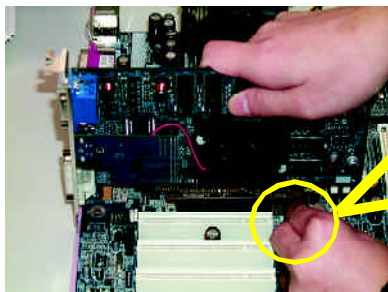

AGP Card

Please carefully pull out the small white-drawable bar at the end of the AGP slot when you try to install/ Uninstall the AGP card. Please align the AGP card to the onboard AGP slot and press firmly down on the slot. Make sure your AGP card is locked by the small white-drawable bar.

Step 4: Connect ribbon cables, cabinet wires, and power supply

Step4-1: I/O Back Panel Introduction

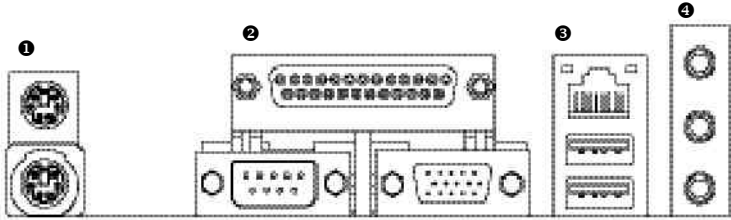

❶ PS/2 Keyboard and PS/2 Mouse Connector

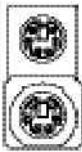

PS/2 Mouse Connector
(6 pin Female)

PS/2 Keyboard Connector
(6 pin Female)

- This connector supports standard PS/2 keyboard and PS/2 mouse.

❷ Parallel Port, Serial Port and VGA Port (LPT/COMA/VGA)

Parallel Port
(25 pin Female)

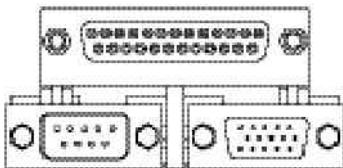

COMA

Serial Port

(9 pin Male)

VGA

VGA Port

(15 pin Female)

- This connector supports 1 standard COM port, 1 Parallel port and 1 VGA port. Device like printer can be connected to Parallel port ; mouse and modem etc can be connected to Serial ports.

③ USB / LAN Connector

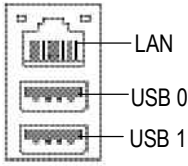

- Before you connect your device(s) into USB connector(s), please make sure your device(s) such as USB keyboard, mouse, scanner, zip, speaker...etc. Have a standard USB interface. Also make sure your OS supports USB controller.

If your OS does not support USB controller, please contact OS vendor for possible patch or driver upgrade. For more information please contact your OS or device(s) vendors.

④ Audio Connectors

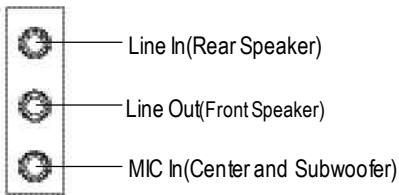

- After install onboard audio driver, you may connect speaker to Line Out jack, micro phone to MIC In jack.

Device like CD-ROM, walkman etc can be connected to Line-In jack.

Please note:

You are able to use 2-/4-/6- channel audio feature by S/W selection.

If you want to enable 6-channel function, you have 2 choose for hardware connection.

Method1:

Connect "Front Speaker" to "Line Out"

Connect "Rear Speaker" to "Line In"

Connect "Center and Subwoofer" to "MIC Out".

Method2:

You can refer to page 25, and contact your nearest dealer for optional SUR_CEN cable.



If you want the detail information for 2-/4-/6-channel audio setup installation, please refer to page 63.

Step 4-2: Connectors Introduction

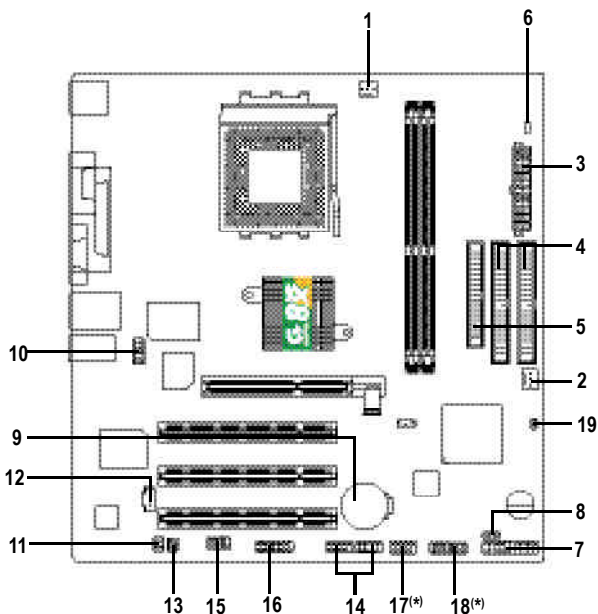

1) CPU_FAN	11) SUR_CEN
2) SYS_FAN	12) CD_IN
3) ATX	13) SPDIF_IO
4) IDE1/IDE2	14) F_USB1/F_USB2
5) FDD	15) COMB
6) RAM_LED	16) GAME
7) F_PANEL	17) F1_1394 (*)
8) PWR_LED	18) F2_1394 (*)
9) BAT	19) CI
10) F_AUDIO	

(*) For GA-7VM400MF only.

1) CPU_FAN (CPU FAN Connector)

Please note, a proper installation of the CPU cooler is essential to prevent the CPU from running under abnormal condition or damaged by overheating. The CPU fan connector supports Max. current up to 600 mA.

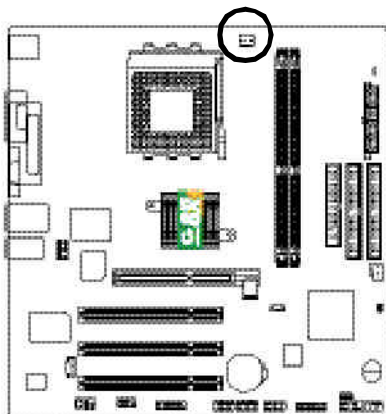

PinNo.	Definition
1	GND
2	+12V
3	Sense

2) SYS_FAN (System FAN Connector)

This connector allows you to link with the cooling fan on the system case to lower the system temperature.

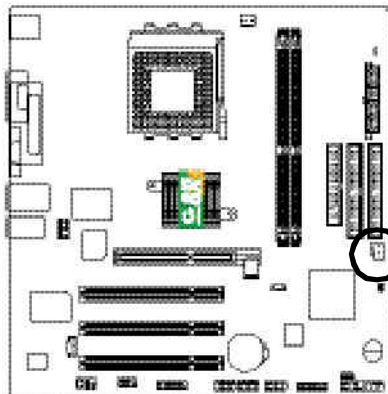

PinNo.	Definition
1	GND
2	+12V
3	Sense

3) ATX (ATX Power)

AC power cord should only be connected to your power supply unit after ATX power cable and other related devices are firmly connected to the mainboard.

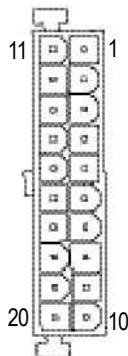
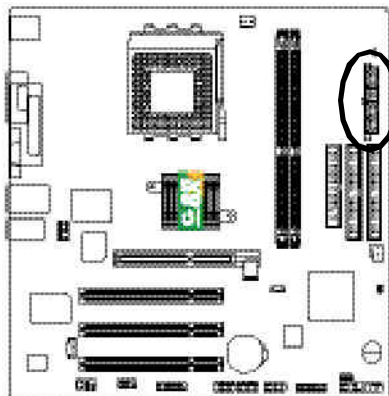

Pin No.	Definition
1	3.3V
2	3.3V
3	GND
4	VCC
5	GND
6	VCC
7	GND
8	PowerGood
9	5V SB(stand by +5V)
10	+12V
11	3.3V
12	-12V
13	GND
14	PS_ON(softOn/Off)
15	GND
16	GND
17	GND
18	-5V
19	VCC
20	VCC

4) IDE1/ IDE2(IDE1/IDE2 Connector)

Please connect first harddisk to IDE1 and connect CDROM to IDE2. The red stripe of the ribbon cable must be the same side with the Pin1.

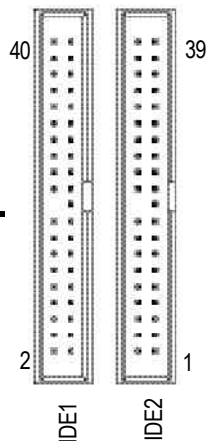
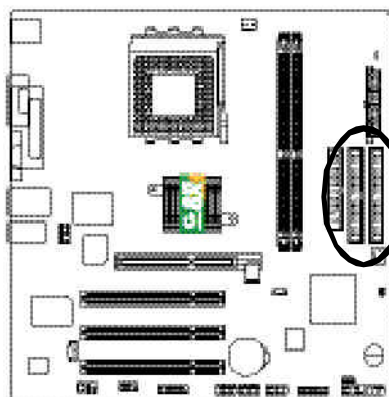

5) FDD (Floppy Connector)

Please connect the floppy drive ribbon cables to FDD. It supports 360K, 720K, 1.2M, 1.44M and 2.88Mbytes floppy disk types. The red stripe of the ribbon cable must be the same side with the Pin 1.

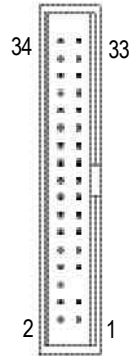
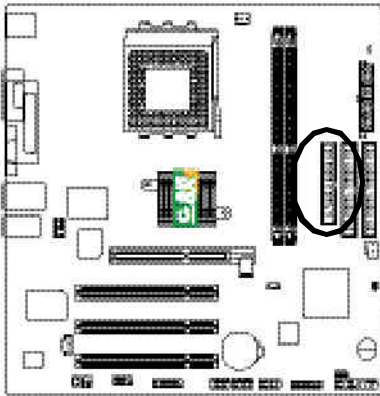

6) RAM_LED

Do not remove memory modules while RAM LED is on. It might cause short or other unexpected damages due to the standby voltage. Remove memory modules only when AC Power cord is disconnected.

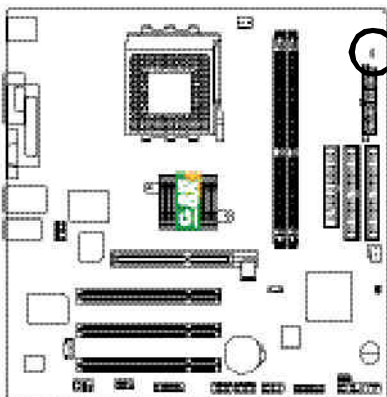

7) F_PANEL (2x10 pins connector)

Please connect the power LED, PC peaker, resetswitch and power switch etc of your chassis front panel to the F_PANEL connector according to the pin assignment above.

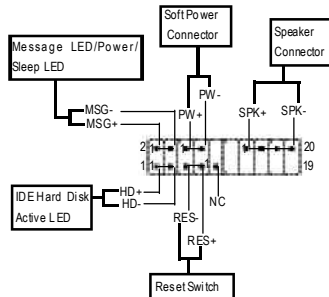
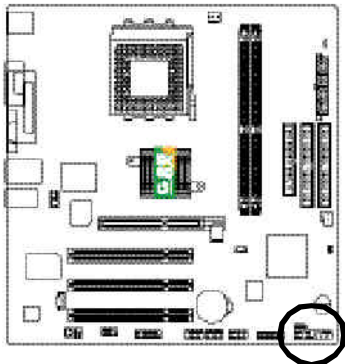

HD (IDE Hard Disk Active LED)	Pin 1: LED anode(+) Pin 2: LED cathode(-)
SPK(Speaker Connector)	Pin 1: VCC (+) Pin 2- Pin 3: NC Pin 4: Data(-)
RES(ResetSwitch)	Open: Normal Operation Close: Reset Hardware System
PW(Soft Power Connector)	Open: Normal Operation Close: Power On/Off
MSG(MessageLED/Power/SleepLED)	Pin 1: LED anode(+) Pin 2: LED cathode(-)
NC	NC

8) PWR_LED

PWR_LED is connect with the system power indicator to indicate whether the system is on/off. It will blink when the system enters suspend mode. If you use dual color LED, power LED will turn to another color.

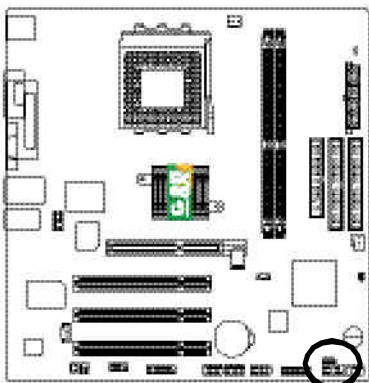

Pin No.	Definition
1	MPD+
2	MPD-
3	MPD-

9) BAT (Battery)

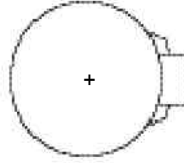
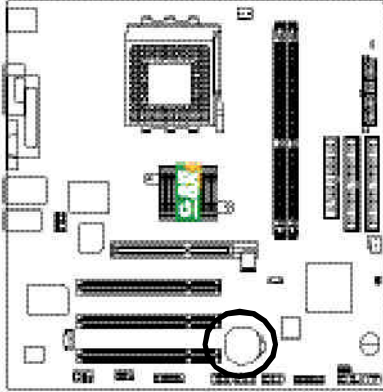

CAUTION

- ❖ Danger of explosion if battery is incorrectly replaced.
- ❖ Replace only with the same or equivalent type recommended by the manufacturer.
- ❖ Dispose of used batteries according to the manufacturer's instructions.

If you want to erase CMOS...

1. Turn OFF the computer and unplug the power cord.
2. Remove the battery, wait for 30 second.
3. Re-install the battery.
4. Plug the power cord and turn ON the computer.

10) F_AUDIO (F_AUDIO Connector)

If you want to use FrontAudio connector, you must remove 5-6, 9-10 Jumper. In order to utilize the front audio header, your chassis must have front audio connector. Also please make sure the pin assignment on the cable is the same as the pin assignment on the MB header. To find out if the chassis you are buying support front audio connector, please contact your dealer. Please note, you can have the alternative of using front audio connector or of using rear audio connector to play sound.

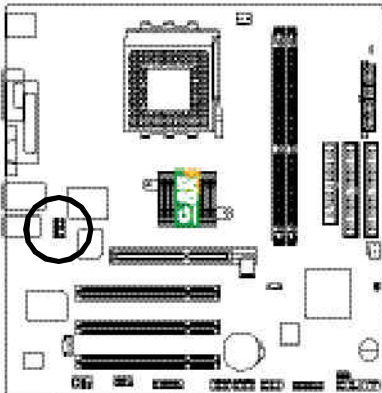

PinNo.	Definition
1	MIC
2	GND
3	REF
4	POWER
5	FrontAudio(R)
6	RearAudio(R)
7	Reserved
8	NoPin
9	FrontAudio(L)
10	RearAudio(L)

11) SUR_CEN

Please contact your nearest dealer for optional SUR_CEN cable.

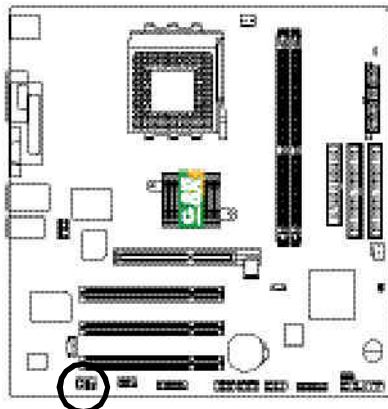

PinNo.	Definition
1	SUROUTL
2	SUROUTR
3	GND
4	No Pin
5	CENTER_OUT
6	BASS_OUT

12) CD_IN (CD IN, Black)

Connect CD-ROM or DVD-ROM audio out to the connector.

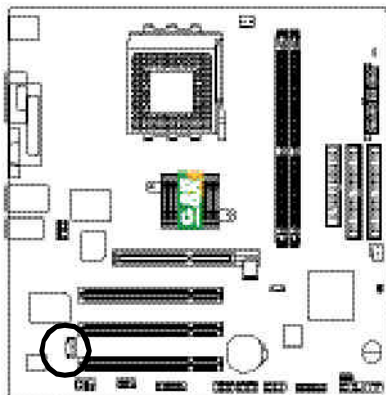

PinNo.	Definition
1	CD-L
2	GND
3	GND
4	CD R

13) SPDIF_IO (SPDIF In/Out)

The SPDIF output is capable of providing digital audio to external speakers or compressed AC3 data to an external Dolby Digital Decoder. Use this feature only when your stereo system has digital input function. Use SPDIF IN feature only when your device has digital output function.

Be careful with the polarity of the SPDIF_IO connector. Check the pin assignment carefully while you connect the SPDIF_IO cable, incorrect connection between the cable and connector will make the device unable to work or even damage it. For optional SPDIF_IO cable, please contact your local dealer.

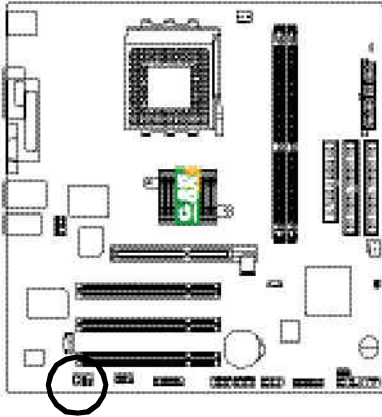

PinNo.	Definition
1	VCC
2	NoPin
3	SPDIF
4	SPDIF I
5	GND
6	GND

14) F_USB1 / F_USB2(Front USB Connector, Yellow)

Be careful with the polarity of the front USB connector. Check the pin assignment while you connect the front USB cable. Please contact your nearest dealer for optional front USB cable.

Be careful with the polarity of the F_USB connector. Check the pin assignment carefully while you connect the F_USB cable, incorrect connection between the cable and connector will make the device unable to work or even damage it. For optional F_USB cable, please contact your local dealer.

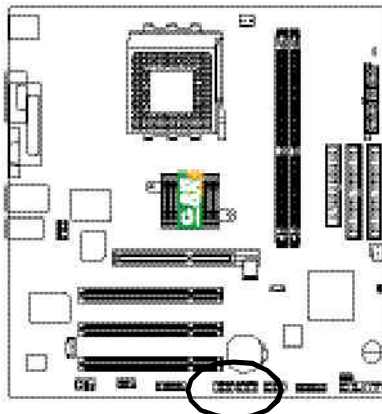

PinNo.	Definition
1	Power
2	Power
3	USB DX-
4	USB Dy-
5	USB DX+
6	USB Dy+
7	GND
8	GND
9	NoPin
10	NC

15) COMB (COM B Connector)(White)

Be careful with the polarity of the COMB connector. Check the pin assignment while you connect the COMB cable. Please contact your nearest dealer for optional COMB cable.

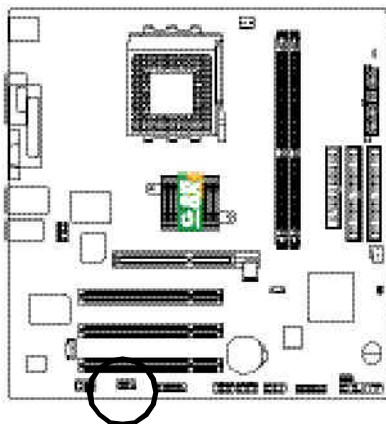

PinNo.	Definition
1	NDCDB-
2	NSINB
3	NSOUTB
4	NDRTB-
5	GND
6	NDSRB-
7	NRTSB-
8	NCTSB-
9	NRIB-
10	NoPin

16) GAME (GAME Connector)

This connector supports joystick, MIDI keyboard and other relate audio devices.

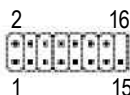
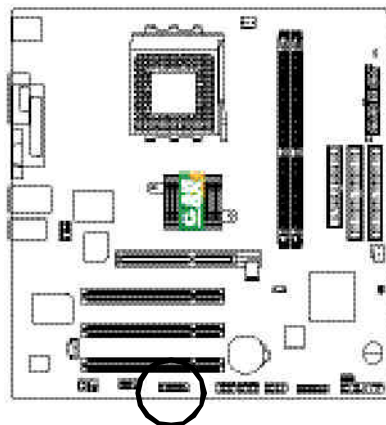

Pin No.	Definition
1	VCC
2	GRX1_R
3	GND
4	GPSA2
5	VCC
6	GPX2_R
7	GPY2_R
8	MSL_R
9	GPSA1
10	GND
11	GPY1_R
12	VCC
13	GPSB1
14	MSO_R
15	GPSB2
16	No Pin

17) F1_1394 (IEEE 1394 Connector) ^(*)

Please Note: Serial interface standard set by Institute of Electrical and Electronics Engineers, which has features like high speed, high bandwidth and hot plug.

Be careful with the polarity of the IEEE1394 connector. Check the pin assignment carefully while you connect the IEEE1394 cable, incorrect connection between the cable and connector will make the device unable to work or even damage it. For optional IEEE1394 cable, please contact your local dealer.

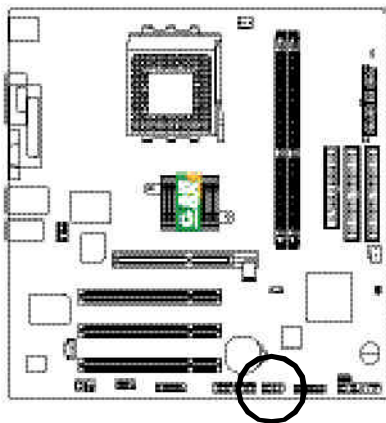

PinNo.	Definition
1	TPA2+
2	TPA2-
3	GND
4	GND
5	TPB2+
6	TPB2-
7	Power
8	Power
9	NoPin
10	GND

18) F2_1394 (IEEE 1394 Connector) ^(*)

Please Note: Serial interface standard set by Institute of Electrical and Electronics Engineers, which has features like high speed, high bandwidth and hot plug.

Be careful with the polarity of the IEEE1394 connector. Check the pin assignment carefully while you connect the IEEE1394 cable, incorrect connection between the cable and connector will make the device unable to work or even damage it. For optional IEEE1394 cable, please contact your local dealer.

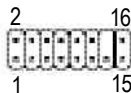
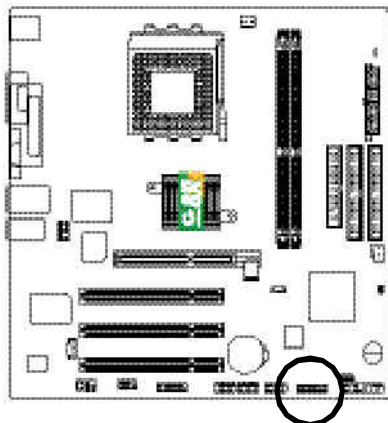

PinNo.	Definition
1	Power
2	Power
3	TPA0+
4	TPA0-
5	GND
6	GND
7	TPB0+
8	TPB0-
9	Power
10	Power
11	TPA1+
12	TPA1-
13	GND
14	NoPin
15	TPB1+
16	TPB1-

(*) For GA-7VM400MF only.

19) CI (CASE OPEN)

This 2 pin connector allows your system to enable or disable the "case open" item in BIOS if the system case begin remove.

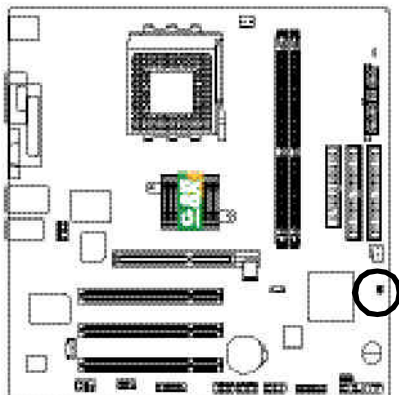

PinNo.	Definition
1	Signal
2	GND

Chapter 3 BIOS Setup

BIOS Setup is an overview of the BIOS Setup Program. The program that allows users to modify the basic system configuration. This type of information is stored in battery-backed CMOS RAM so that it retains the Setup information when the power is turned off.

ENTERING SETUP

After power on the computer, pressing immediately during POST (Power On Self Test) it will allow you to enter standard BIOS CMOS SETUP.

If you require more advanced BIOS settings, please go to "Advanced BIOS" setting menu. To enter Advanced BIOS setting menu, press "Ctrl+F1" key on the BIOS screen.

CONTROL KEYS

<↑>	Move to previous item
<↓>	Move to next item
<←>	Move to the item in the left hand
<→>	Move to the item in the right hand
Enter	Select item
<Esc>	Main Menu - Quit and not save changes into CMOS Status Page Setup Menu and Option Page Setup Menu - Exit current page and return to Main Menu
<+/PgUp>	Increase the numeric value or make changes
<-/PgDn>	Decrease the numeric value or make changes
<F1>	General help, only for Status Page Setup Menu and Option Page Setup Menu
<F2>	Item Help
<F3>	Reserved
<F4>	Reserved
<F5>	Restore the previous CMOS value from CMOS, only for Option Page Setup Menu
<F6>	Load the file-safe default CMOS value from BIOS default table
<F7>	Load the Optimized Defaults
<F8>	Q-Flash function
<F9>	System Information
<F10>	Save all the CMOS changes, only for Main Menu

GETTING HELP

Main Menu

The on-line description of the highlighted setup function is displayed at the bottom of the screen.

Status Page Setup Menu / Option Page Setup Menu

Press F1 to pop up a small help window that describes the appropriate keys to use and the possible selections for the highlighted item. To exit the Help Window press <Esc>.

The Main Menu (For example: BIOS Ver. : D1)

Once you enter Award BIOS CMOS Setup Utility, the Main Menu (Figure 1) will appear on the screen. The Main Menu allows you to select from eight setup functions and two exit choices. Use arrow keys to select among the items and press <Enter> to accept or enter the sub-menu.

CMOS Setup Utility - Copy right (C) 1984-2003 Award Software

<ul style="list-style-type: none"> ▶ Standard CMOS Features ▶ Advanced BIOS Features ▶ Integrated Peripherals ▶ Power Management Setup ▶ PnP/PCI Configurations ▶ PC Health Status ▶ Frequency/Voltage Control 	<ul style="list-style-type: none"> Load Fail-Safe Defaults Load Optimized Defaults Set Supervisor Password Set User Password Save & Exit Setup Exit Without Saving
ESC: Quit	↑↓→←: Select Item
F8: Q-Flash	F10: Save & Exit Setup
Time, Date, Hard Disk Type...	

Figure 1: Main Menu



If you can't find the setting you want, please press "Ctrl+F1" to search the advanced option widden.

- **Standard CMOS Features**

This setup page includes all the items in standard compatible BIOS.

- **Advanced BIOS Features**

This setup page includes all the items of Award special enhanced features.

- **Integrated Peripherals**
This setup page includes all onboard peripherals.
- **Power Management Setup**
This setup page includes all the items of Green function features.
- **PnP/PCI Configurations**
This setup page includes all the configurations of PCI & PnP ISA resources.
- **PC Health Status**
This setup page is the System auto detect Temperature, voltage, fan, speed.
- **Frequency/Voltage Control**
This setup page is control CPU's clock and frequency ratio.
- **Load Fail-Safe Defaults**
Fail-Safe Defaults indicates the value of the system parameters which the system would be in safe configuration.
- **Load Optimized Defaults**
Optimized Defaults indicates the value of the system parameters which the system would be in better performance configuration.
- **Load Top Performance Defaults**
Top Performance Defaults indicates the value of the system parameters which the system would be in best performance configuration.
- **Set Supervisor password**
Change, set, or disable password. It allows you to limit access to the system and Setup, or just to Setup.
- **Set User password**
Change, set, or disable password. It allows you to limit access to the system.
- **Save & Exit Setup**
Save CMOS value settings to CMOS and exit setup.
- **Exit Without Saving**
Abandon all CMOS value changes and exit setup.

Standard CMOS Features

CMOS Setup Utility -Copy right (C) 1984-2003 Award Software

Standard CMOS Features

Date (mm:dd:yy)	Tue, Aug 13 2002	Item Help
Time (hh:mm:ss)	22:31:24	
▶IDE Primary Master	[None]	Change the day, month, year
▶IDE Primary Slave	[None]	
▶IDE Secondary Master	[None]	<Week>
▶IDE Secondary Slave	[None]	Sun. to Sat.
Drive A	[1.44M, 3.5 in.]	<Month>
Drive B	[None]	Jan. to Dec.
Floppy 3 Mode Support	[Disabled]	
Halt On	[All, But Keyboard]	<Day>
		1 to 31 (or maximum allowed in the month)
Base Memory	640K	
Extended Memory	130048K	<Year>
Total Memory	131072K	1999 to 2098
↑↓→←: Move Enter:Select +/-/PU/PD:Value F10:Save ESC:Exit F1:General Help F5:Previous Values F6:Fail-Safe Defaults F7:Optimized Defaults		

Figure 2: Standard CMOS Features

☛ Date

The date format is <week>, <month>, <day>, <year>.

- ▶ Week The week, from Sun to Sat, determined by the BIOS and is display only
- ▶ Month The month, Jan. Through Dec.
- ▶ Day The day, from 1 to 31 (or the maximum allowed in the month)
- ▶ Year The year, from 1999 through 2098

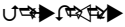
☛ Time

The times format in <hour> <minute> <second>. The time is calculated base on the 24-hour military-time clock. For example, 1 p.m. is 13:00:00.

4 IDE Primary Master, Slave / Secondary Master, Slave

The category identifies the types of hard disk from drive C to F that has been installed in the computer. There are two types: auto type, and manual type. Manual type is user-definable; Auto type which will automatically detect HDD type.

Note that the specifications of your drive must match with the drive table. The hard disk will not work properly if you enter improper information for this category.

If you select User Type, related information will be asked to enter to the following items. Enter the information directly from the keyboard and press <Enter>. Such information should be provided in the documentation from your hard disk vendor or the system manufacturer.

- ▶ Capacity: The hard disk size. The unit is Mega Bytes.
- ▶ Access Mode: The options are: Auto / Large / LBA / Normal.
- ▶ Cylinder: The cylinder number of hard disk.
- ▶ Head The read / Write head number of hard disk.
- ▶ Precomp The cylinder number at which the disk driver changes the write current.
- ▶ Landing Zone The cylinder number that the disk driver heads(read/write) are seated when the disk drive is parked.
- ▶ SECTORS The sector number of each track define on the hard disk.

If a hard disk has not been installed select NONE and press <Enter>.

4 Drive A/ Drive B

The category identifies the types of floppy disk drive A or drive B that has been installed in the computer.

- ▶ None No floppy drive installed
- ▶ 360K, 5.25". 5.25 inch PC-type standard drive; 360K byte capacity.
- ▶ 1.2M, 5.25". 5.25 inch AT-type high-density drive; 1.2M byte capacity
(3.5 inch when 3 Mode is Enabled).
- ▶ 720K, 3.5". 3.5 inch double-sided drive; 720K byte capacity
- ▶ 1.44M, 3.5". 3.5 inch double-sided drive; 1.44M byte capacity.
- ▶ 2.88M, 3.5". 3.5 inch double-sided drive; 2.88M byte capacity.

❶ Floppy 3 Mode Support (for Japan Area)

- ▶ Disabled Normal Floppy Drive. (Default value)
- ▶ Drive A Enabled 3 mode function of Drive A.
- ▶ Drive B Enabled 3 mode function of Drive B.
- ▶ Both Drive A & B are 3 mode Floppy Drives.

❷ Halt on

The category determines whether the computer will stop if an error is detected during power up.

- ▶ NO Errors The system boot will not stop for any error that may be detected and you will be prompted.
- ▶ All Errors Whenever the BIOS detects a non-fatal error the system will be stopped.
- ▶ All, But Keyboard The system boot will not stop for a keyboard error; it will stop for all other errors. (Default value)
- ▶ All, But Diskette The system boot will not stop for a disk error; it will stop for all other errors.
- ▶ All, But Disk/Key The system boot will not stop for a keyboard or disk error; it will stop for all other errors.

❸ Memory

The category is display-only which is determined by POST (Power On Self Test) of the BIOS.

Base Memory

The POST of the BIOS will determine the amount of base (or conventional) memory installed in the system.

The value of the base memory is typically 512 K for systems with 512 K memory installed on the motherboard, or 640 K for systems with 640 K or more memory installed on the motherboard.

Extended Memory

The BIOS determines how much extended memory is present during the POST.

This is the amount of memory located above 1 MB in the CPU's memory address map.

Advanced BIOS Features

CMOS Setup Utility - Copyright (C) 1984-2003 Award Software

Advanced BIOS Features

First Boot Device	[Floppy]	Item Help
Second Boot Device	[HDD-0]	
Third Boot Device	[CD-ROM]	Select Boot Device
Passw ord Check	[Setup]	priority
		[Floppy]
		Boot from floppy
		[LS120]
		Boot from LS120
		[HDD-0]
		Boot from First HDD
		[HDD-1]
		Boot from second HDD
↑↓→←: Move Enter:Select +/-/PU/PD:Value F10:Save ESC:Exit F1:General Help F5:Previous Values F6:Fail-Safe Defaults F7:Optimized Defaults		

Figure 3: Advanced BIOS Features

First / Second / Third Boot device

- This feature allows you to select the boot device priority .
 - ▶ Floppy Select your boot device priority by Floppy .
 - ▶ LS120 Select your boot device priority by LS120 .
 - ▶ HDD-0~3 Select your boot device priority by HDD-0~3 .
 - ▶ SCSI Select your boot device priority by SCSI .
 - ▶ CDROM Select your boot device priority by CDROM .
 - ▶ LAN Select your boot device priority by LAN .
 - ▶ USB-CDROM Select your boot device priority by USB-CDROM .
 - ▶ USB-ZIP Select your boot device priority by USB-ZIP .
 - ▶ USB-FDD Select your boot device priority by USB-FDD .

- » USB-HDD Select your boot device priority by USB-HDD.
- » ZIP Select your boot device priority by ZIP.
- » Disabled Disable this function.

» Password Check

- » Setup The system will boot but will not access to Setup page if the correct password is not entered at the prompt. (Default value)
- » System The system will not boot and will not access to Setup page if the correct password is not entered at the prompt.

Integrated Peripherals

CMOS Setup Utility - Copyright (C) 1984-2003 Award Software

Integrated Peripherals

		Item Help
OnChip IDE Channel0	[Enabled]	
OnChip IDE Channel1	[Enabled]	
AC97 Audio	[Enabled]	If a hard disk
USB 1.1 Controller	[Enabled]	controller card is
USB 2.0 Controller	[Enabled]	used, set at Disabled
USB Keyboard Support	[Disabled]	
USB Mouse Support	[Disabled]	[Enabled]
Onboard H/W LAN	[Enabled]	Enable onboard IDE
Onboard H/W 1394 (*)	[Enabled]	Channel
Onboard LAN Boot ROM	[Disabled]	
Onboard Serial Port 1	[3F8/IRQ4]	[Disabled]
Onboard Serial Port 2	[2F8/IRQ3]	Disable onboard IDE
Onboard Parallel Port	[378/IRQ7]	Channel
Parallel Port Mode	[SPP]	
Game Port Address	[201]	
Mdi Port Address	[330]	
Midi Port IRQ	[10]	

↑↓→←: Move Enter:Select +/-/PU/PD:Value F10:Save ESC:Exit F1:General Help
 F5:Previous Values F6:Fail-Safe Defaults F7:Optimized Defaults

Figure 4: Integrated Peripherals

(*) For GA-7VM400MF only.

OnChip IDE Channel0

When enabled, allows you to use the onboard primary PCI IDE. If a hard disk controller card is used, set at Disabled.

- ▶ Enabled Enable onboard 1st channel IDE port. (Default value)
- ▶ Disabled Disable onboard 1st channel IDE port.

OnChip IDE Channel1

When enabled, allows you to use the onboard secondary PCI IDE. If a hard disk controller card is used, set at Disabled.

- ▶ Enabled Enable onboard 2nd channel IDE port. (Default value)
- ▶ Disabled Disable onboard 2nd channel IDE port.

AC97 Audio

- ▶ Enabled Enable Onchip AC97 controller. (Default value)
- ▶ Disabled Disable Onchip AC97 controller.

USB 1.1 Controller

Disable this option if you are not using the onboard USB feature.

- ▶ Enabled Enable USB1.1 Controller. (Default value)
- ▶ Disabled Disable USB1.1 Controller.

USB 2.0 Controller

Disable this option if you are not using the onboard USB 2.0 feature.

- ▶ Enabled Enable USB 2.0 Controller. (Default value)
- ▶ Disabled Disable USB 2.0 Controller.

USB Keyboard Support

When a USB keyboard is installed, please set at Enabled.

- ▶ Enabled Enable USB Keyboard Support.
- ▶ Disabled Disable USB Keyboard Support. (Default value)

USB Mouse Support

- ▶ Enabled Enable USB Mouse Support.
- ▶ Disabled Disable USB Mouse Support. (Default value)

Onboard H/W LAN

- ▶ Enable Enable onboard LAN function.(Default value)
- ▶ Disable Disable onboard LAN function.

Onboard H/W 1394 (*)

- ▶ Enable Enable onboard IEEE 1394 function.(Default value)
- ▶ Disable Disable onboard this function.

Onboard LAN Boot ROM

This function decide whether to invoke the boot ROM of the onboard LAN chip.

- ▶ Disabled Disable this function. (Default Value)
- ▶ Enabled Enable this function.

Onboard Serial Port 1

- ▶ Auto BIOS will automatically setup the port 1 address.
- ▶ 3F8/IRQ4 Enable onboard Serial port 1 and address is 3F8,U using IRQ4. (Default value)
- ▶ 2F8/IRQ3 Enable onboard Serial port 1 and address is 2F8,U using IRQ3.
- ▶ 3E8/IRQ4 Enable onboard Serial port 1 and address is 3E8,U using IRQ4.
- ▶ 2E8/IRQ3 Enable onboard Serial port 1 and address is 2E8,U using IRQ3.
- ▶ Disabled Disable onboard Serial port 1.

Onboard Serial Port 2

- ▶ Auto BIOS will automatically setup the port 2 address.
- ▶ 3F8/IRQ4 Enable onboard Serial port 2 and address is 3F8,U using IRQ4.
- ▶ 2F8/IRQ3 Enable onboard Serial port 2 and address is 2F8,U using IRQ3. (Default Value)
- ▶ 3E8/IRQ4 Enable onboard Serial port 2 and address is 3E8,U using IRQ4.
- ▶ 2E8/IRQ3 Enable onboard Serial port 2 and address is 2E8,U using IRQ3.
- ▶ Disabled Disable onboard Serial port 2.

OnBoard Parallel port

☛ This feature allows you to select from a given set of parameters if the parallel port uses the onboard I/O controller.

- ▶ 378/IRQ7 Enable onboard LPT port and address is 378, Using IRQ7.(Default Value)

(*) For GA-7VM400MF only.

- ▶ 278/IRQ5 Enable onboard LPT port and address is 278, Using IRQ5.
- ▶ 3BC/IRQ7 Enable onboard LPT port and address is 3BC, Using IRQ7.
- ▶ Disabled Disable onboard parallel port.

⦿ **Parallel Port Mode**

🔍 This feature allows you to connect with an advanced print via the port mode it supports.

- ▶ SPP Using Parallel port as Standard Parallel Port using IRQ7. (Default Value)
- ▶ EPP Using Parallel port as Enhanced Parallel Port IRQ5.
- ▶ ECP Using Parallel port as Extended Capabilities Port using IRQ7.
- ▶ ECP+EPP Using Parallel port as ECP & EPP mode.

⦿ **Game Port Address**

- ▶ Disabled Disable this function.
- ▶ 201 Set Game Port Address to 201. (Default Value)
- ▶ 209 Set Game Port Address to 209.

⦿ **Midi Port Address**

- ▶ Disabled Disable this function.
- ▶ 300 Set Midi Port Address to 300.
- ▶ 330 Set Midi Port Address to 330. (Default Value)

⦿ **Midi Port IRQ**

- ▶ 5 Set 5 for Midi Port IRQ.
- ▶ 10 Set 10 for Midi Port IRQ. (Default value)

Power Management Setup

CMOS Setup Utility - Copyright (C) 1984-2003 Award Software

Power Management Setup

		Item Help
ACPI Suspend Type	[S1(POS)]	
x USB Device Wake Up From S3	Disabled	Menu Level →
Power LED in S1 state	[Blinking]	[S1]
Soft-Off by PWRBTN	[Instant-off]	Set suspend type to
AC Back Function	[Soft-Off]	Power On Suspend under
Keyboard Power On	[Disabled]	ACPI OS
Mouse Power On	[Disabled]	
PME Event Wake Up	[Enabled]	[S3]
ModemRingOn/WakeOnLAN	[Enabled]	Set suspend type to
Resume by Alarm	[Disabled]	Suspend to RAM under
x Date(of Month) Alarm	Every day	ACPI OS
x Time(hh:mm:ss) Alarm	0 : 0 : 0	
↑↓→←: Move Enter:Select +/-/PU/PD:Value F10:Save ESC:Exit F1:General Help F5:Previous Values F6:Fail-Safe Defaults F7:Optimized Defaults		

Figure 5: Power Management Setup

ACPI Suspend Type

- ▶ S1/POS Set suspend type to Power On Suspend under ACPI OS (Power On Suspend). (Default value)
- ▶ S3/STR Set suspend type to Suspend To RAM under ACPI OS (Suspend To RAM).

USB Device Wakeup From S3(When ACPI Suspend Type is set [S3/STR])

USB device wakeup From S3 can be set when ACPI standby state set to S3/STR.

- ▶ Enabled USB Device can wakeup system from S3.
- ▶ Disabled USB Device can't wakeup system from S3. (Default value)

⌚ Power LED in S1 state

- ▶ Blinking In standby mode(S1), power LED will blink. (Default Value)
- ▶ Dual/OFF In standby mode(S1):
 - a. If use single color LED, power LED will turn off.
 - b. If use dual color LED, power LED will turn to another color.

⌚ Soft-off by PWRBTN

- ▶ Instant-off Press power button then Power off instantly. (Default value)
- ▶ Delay 4 Sec. Press power button 4 sec to Power off. Enter suspend if button is pressed less than 4 sec.

⌚ AC Back Function

- ▶ Memory System power on depends on the status before AC lost.
- ▶ Soft-Off Always in Off state when AC back. (Default value)
- ▶ Full-On Always power on the system when AC back.

⌚ Keyboard Power On

This feature allows you to set the method for powering-on the system.

The option "Password" allows you to set up to 8 alphanumeric characters to power-on the system.

The option "Keyboard 98" allows you to use the standard keyboard 98 to power on the system.

- ▶ Password Enter from 1 to 8 characters to set the Keyboard Power On Password.
- ▶ Disabled Disabled this function. (Default value)
- ▶ Keyboard 98 If your keyboard have "POWER Key" button, you can press the key to power on your system.

⌚ Mouse Power On

- ▶ Disabled Can't Power on system by Mouse Event. (Default value)
- ▶ Enabled Can Power on system by Mouse Event.

☛ **PME Event Wake up**

- ☛ When set at Enabled, any PCI-PM event awakes the system from a PCI-PM controlled state.
- ☛ This feature requires an ATX power supply that provides at least 1A on the +5VSB lead.
 - ▶ Disabled Disable PME Event Wake up function.
 - ▶ Enabled Enable PME Event Wake up function. (Default Value)

☛ **Modem Ring On/ Wake OnLAN (When AC Back Function is set to [Soft-Off])**

- ☛ You can enable wake on LAN feature by the "ModemRingOn/WakeOnLAN" or "PME Event Wake up" when the M/B has "WOL" onboard connector. Only enabled the feature by "PME Event Wake up".
- ☛ An incoming call via modem awakes the system from its soft-off mode.
- ☛ When set at Enabled, an input signal comes from the other client.
 - Server on the LAN awaks the system from a soft off state if connected over LAN.
 - ▶ Disabled Disable Modem Ring On / Wake On LAN function.
 - ▶ Enabled Enable Modem Ring On / Wake On LAN function. (Default Value)

☛ **Resume by Alarm**

You can set "Resume by Alarm" item to enabled and key in Data/time to power on system.

- ▶ Disabled Disable this function. (Default Value)
- ▶ Enabled Enable alarm function to POWER ON system.

If RTC Alarm Lead To Power On is Enabled.

Date (of Month) Alarm : Everyday, 1~31

Time (hh: mm: ss) Alarm :(0~23) : (0~59) : (0~59)

PnP/PCI Configurations

CMOS Setup Utility - Copy right (C) 1984-2003 Award Software

PnP/PCI Configurations		
PCI 1 IRQ Assignment	[Auto]	Item Help
PCI 2 IRQ Assignment	[Auto]	↑↓→← F5 F6 F7
PCI 3 IRQ Assignment	[Auto]	Decice(s) using this INT: USB 1.1 Host Cntrl - Bus 0 Dev 16 Func 1
↑↓→←: Move Enter:Select +/-/PU/PD:Value F10:Save ESC:Exit F1:General Help F5:Previous Values F6:Fail-Safe Defaults F7:Optimized Defaults		

Figure 6: PnP/PCI Configurations

❶ PCI1 IRQ Assignment

- ▶ Auto Auto assign IRQ to PCI 1. (Default value)
- ▶ 3,4,5,7,9.,10,11,12,14,15 Set 3,4,5,7,9,10,11,12,14,15 to PCI1.

❷ PCI2 IRQ Assignment

- ▶ Auto Auto assign IRQ to PCI 2. (Default value)
- ▶ 3,4,5,7,9.,10,11,12,14,15 Set 3,4,5,7,9,10,11,12,14,15 to PCI2.

❸ PCI3 IRQ Assignment

- ▶ Auto Auto assign IRQ to PCI 3. (Default value)
- ▶ 3,4,5,7,9.,10,11,12,14,15 Set 3,4,5,7,9,10,11,12,14,15 to PCI3.

PC Health Status

CMOS Setup Utility - Copyright (C) 1984-2003 Award Software

PC Health Status

		Item Help
Reset Case Open Status	[Disabled]	
Case Opened	No	⏪ ⏩ ⏴ ⏵ ⏶ ⏷ ⏸ ⏹ ⏺
Vcore	1.772V	[Disabled]
DDR Vt	1.248V	Don't reset case
+3.3V	3.280V	open status
+5V	4.919 V	
+12V	11.968V	[Enabled]
5VSB	5.053V	Clear case open
Current System Temperature	31°C	status at next boot
Current CPU Temperature	45°C	
Current CPU FAN Speed	4440RPM	
Current SYSTEM FAN speed	0 RPM	
CPU FAN Fail Warning	[Disabled]	
SYSTEM FAN Fail Warning	[Disabled]	
↑↓→←: Move Enter: Select +/-/PU/PD: Value F10: Save ESC: Exit F1: General Help F5: Previous Values F6: Fail-Safe Defaults F7: Optimized Defaults		

Figure7: PC Health Status

❶ Reset Case Open Status

❶ Case Opened

If the case is closed, "Case Opened" will show "No".

If the case have been opened, "Case Opened" will show "Yes".

If you want to reset "Case Opened" value, set "Reset Case Open Status" to "Enabled" and save CMOS, your computer will restart.

❷ Current Voltage (V) Vcore /DDR Vt/ +3.3V/ +5V / +12V / 5VSB

Detect system's voltage status automatically.

- ❖ **Current System/CPU Temperature**
 - ▶ Detect System/CPU Temp. automatically.

- ❖ **Current CPU FAN / SYSTEM FAN Speed (RPM)**
 - Detect Fan speed status automatically.

- ❖ **Fan Fail Warning (CPU / SYSTEM)**
 - ▶ Disabled Don't monitor current fan speed. (Default value)
 - ▶ Enabled Alarm when stops.

Frequency/Voltage Control

CMOS Setup Utility - Copyright (C) 1984-2003 Award Software

Frequency/Voltage Control

Auto Detect PCI/DIMM Clk	[Enabled]	Item Help
Spread Spectrum	[Enabled]	
CPU Host/AGP/PCI Clock	[Default]	
DRAM Clock(MHz)	[Auto]	
CPU OverVoltage Control	[Auto]	
↑↓→←: Move Enter:Select +/-/PU/PD:Value F10:Save ESC:Exit F1:General Help F5:Previous Values F6:Fail-Safe Defaults F7:Optimized Defaults		

Figure 8: Frequency/Voltage Control

Auto Detect PCI/DIMM Clk

- ▶ Disabled Disable auto detect PCI/DIMM Clk.
- ▶ Enabled Enable auto detect PCI/DIMM Clk. (Default value)

Spread Spectrum

- ▶ Disabled Disable clock spread spectrum.
- ▶ Enabled Enable clock spread spectrum. (Default value)

CPU Host/AGP/PCI Clock

- ▶ Default Set CPU Host/AGP/PCI Clock by default.
- ▶ 100/66/33 MHz Set CPU Host/AGP/PCI Clock to 100/66/33 MHz.
- ▶ 102/68/34 MHz Set CPU Host/AGP/PCI Clock to 102/68/34 MHz.
- ▶ 105/70/35 MHz Set CPU Host/AGP/PCI Clock to 105/70/35 MHz.
- ▶ 114/76/38 MHz Set CPU Host/AGP/PCI Clock to 114/76/38 MHz.
- ▶ 117/78/39 MHz Set CPU Host/AGP/PCI Clock to 117/78/39 MHz.
- ▶ 120/80/40 MHz Set CPU Host/AGP/PCI Clock to 120/80/40 MHz.
- ▶ 123/82/41 MHz Set CPU Host/AGP/PCI Clock to 123/82/41 MHz.

⚙️ **DRAM Clock (MHz)**

⚠️ Wrong frequency may make system can't boot. Clear CMOS to overcome wrong frequency issue.

▶▶ Please set DRAM Clock according to your requirement.

If you use DDR266 DRAM module, please set "DRAM Clock(MHz)" to "133-DDR266". If you use DDR333 DRAM module, please set "DRAM Clock(MHz)" to "166-DDR333". If you use Incorrect using it may cause your system broken. For power End-User use only!

▶▶ Auto Auto setting Memory frequency. (Default value)

⚙️ **CPU OverVoltage Control**

▶▶ Auto BIOS will automatically setup the CPU overvoltage control. (Default value)

▶▶ +5% Set CPU OverVoltage Control to +5%.

▶▶ +7.5% Set CPU OverVoltage Control to +7.5%.

▶▶ +10% Set CPU OverVoltage Control to +10%.

Load Fail-Safe Defaults

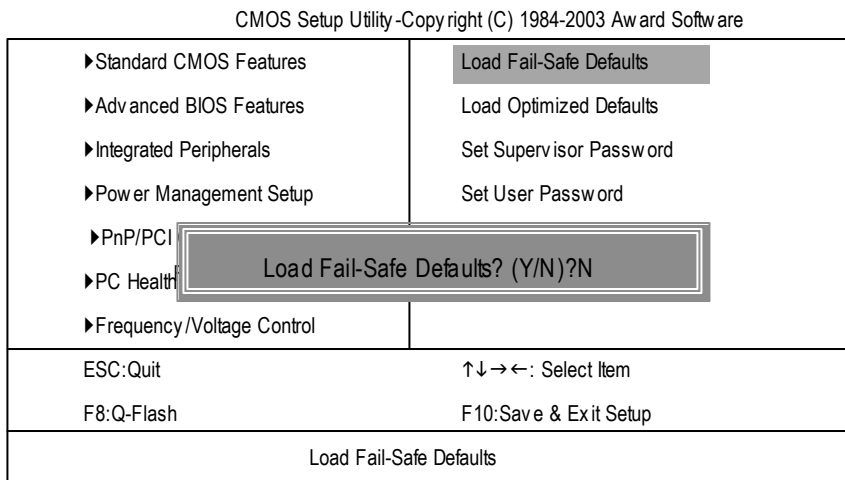

Figure 9: Load Fail-Safe Defaults

4 Load Fail-Safe Defaults

Fail-Safe defaults contain the most appropriate values of the system parameters that allow minimum system performance.

Load Optimized Defaults

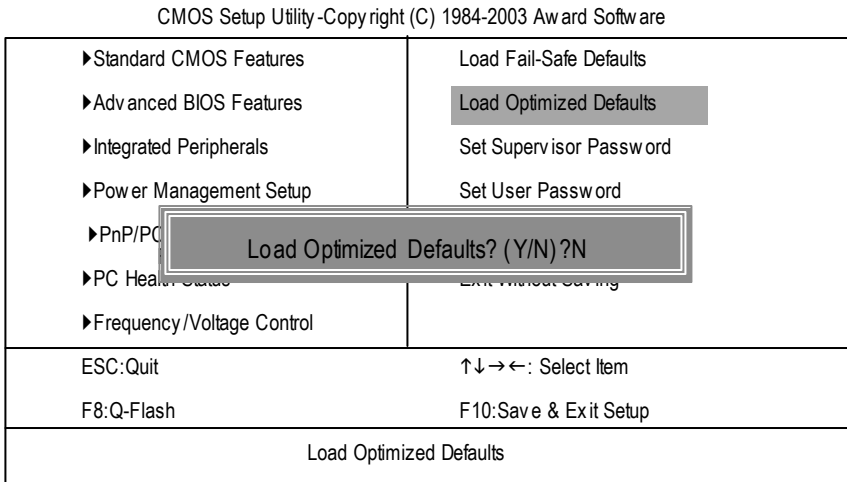

Figure 10: Load Optimized Defaults

Load Optimized Defaults

Selecting this field loads the factory defaults for BIOS and Chipset Features which the system automatically detects.

Set Supervisor/User Password

CMOS Setup Utility -Copy right (C) 1984-2003 Award Software

▶Standard CMOS Features	Load Fail-Safe Defaults
▶Advanced BIOS Features	Load Optimized Defaults
▶Integrated Peripherals	Set Supervisor Password
▶Power Management Setup	Set User Password
▶PnP/PCI	
▶PC Health	
▶Frequency/Voltage Control	
Enter Password:	
ESC:Quit	↑↓→←: Select Item
F8:Q-Flash	F10:Save & Exit Setup
Change/Set/Disable Password	

Figure 11: Password Setting

When you select this function, the following message will appear at the center of the screen to assist you in creating a password.

Type the password, up to eight characters, and press <Enter>. You will be asked to confirm the password. Type the password again and press <Enter>. You may also press <Esc> to abort the selection and not enter a password.

To disable password, just press <Enter> when you are prompted to enter password. A message "PASSWORD DISABLED" will appear to confirm the password being disabled. Once the password is disabled, the system will boot and you can enter Setup freely.

The BIOS Setup program allows you to specify two separate passwords: a SUPERVISOR PASSWORD and a USER PASSWORD. When disabled, anyone may access all BIOS Setup program function. When enabled, the Supervisor password is required for entering the BIOS Setup program and having full configuration fields, the User password is required to access only basic items.

If you select "System" at "Security Option" in Advance BIOS Features Menu, you will be prompted for the password every time the system is rebooted or any time you try to enter Setup Menu.

If you select "Setup" at "Security Option" in Advance BIOS Features Menu, you will be prompted only when you try to enter Setup.

Save & Exit Setup

CMOS Setup Utility - Copyright (C) 1984-2003 Award Software

▶Standard CMOS Features	Load Fail-Safe Defaults
▶Advanced BIOS Features	Load Optimized Defaults
▶Integrated Peripherals	Set Supervisor Password
▶Power Management Setup	Set User Password
▶PnP/PCI/Devices	
▶PC Health Status	
▶Frequency/Voltage Control	
Save to CMOS and EXIT (Y/N)? Y	
ESC:Quit	↑↓→←: Select Item
F8:Q-Flash	F10:Save & Exit Setup
Save Data to CMOS	

Figure 12: Save & Exit Setup

Type "Y" will quit the Setup Utility and save the user setup value to RTC CMOS.

Type "N" will return to Setup Utility.

Exit Without Saving

CMOS Setup Utility - Copyright (C) 1984-2003 Award Software

▶Standard CMOS Features	Load Fail-Safe Defaults
▶Advanced BIOS Features	Load Optimized Defaults
▶Integrated Peripherals	Set Supervisor Password
▶Power Management Setup	Set User Password
▶PnP/PCI Configurations	Save & Exit Setup
▶PC Health Status	Quit Without Saving (Y/N)? N
▶Frequency/Voltage Control	
ESC:Quit	↑↓→←: Select Item
F8:Q-Flash	F10:Save & Exit Setup
Abandon all Data	

Figure 13: Exit Without Saving

Type "Y" will quit the Setup Utility without saving to RTC CMOS.

Type "N" will return to Setup Utility.

Chapter 4 Technical Reference

@ BIOS™ Introduction

Gigabyte announces @ BIOS

Windows BIOS live update utility



Have you ever updated BIOS by yourself? Or like many other people, you just know what BIOS is, but always hesitate to update it? Because you think updating newest BIOS is unnecessary and actually you don't know how to update it.

Maybe not like others, you are very experienced in BIOS updating and spend quite a lot of time to do it. But of course you don't like to do it too much. First, download different BIOS from website and then switch the operating system to DOS mode. Secondly, use different flash utility to update BIOS. The above process is not a interesting job. Besides, always be carefully to store the BIOS source code correctly in your disks as if you update the wrong BIOS, it will be a nightmare.

Certainly, you wonder why motherboard vendors could not just do something right to save your time and effort and save you from the lousy BIOS updating work? Here it comes! Now Gigabyte announces @BIOS—the first Windows BIOS live update utility. This is a smart BIOS update software. It could help you to download the BIOS from internet and update it. Not like the other BIOS update software, it's a Windows utility. With the help of "@BIOS", BIOS updating is no more than a click.

Besides, no matter which mainboard you are using, if it's a Gigabyte's product*, @BIOS help you to maintain the BIOS. This utility could detect your correct mainboard model and help you to choose the BIOS accordingly. It then downloads the BIOS from the nearest Gigabyte ftp site automatically. There are several different choices; you could use "Internet Update" to download and update your BIOS directly. Or you may want to keep a backup for your current BIOS, just choose "Save Current BIOS" to save it first. You make a wise choice to use Gigabyte, and @BIOS update your BIOS smartly. You are now worry free from updating wrong BIOS, and capable to maintain and manage your BIOS easily. Again, Gigabyte's innovative product erects a milestone in mainboard industries.

For such a wonderful software, how much it costs? Impossible! It's free! Now, if you buy a Gigabyte's motherboard, you could find this amazing software in the attached driver CD. But please remember, connected to internet at first, then you could have a internet BIOS update from your Gigabyte @BIOS.

Easy Tune™ 4 Introduction

Gigabyte announces *EasyTune™ 4*

Windows based Overclocking utility

EasyTune 4 carries on the heritage so as to pave the way for future generations.



"Overclock" might be one of the most common issues in computer field. But have many users ever tried it? The answer is probably "no". Because "Overclock" is thought to be very difficult and includes a lot of technical know-how, sometimes "Overclock" is even considered as special skills found only in some enthusiasts. But as to the experts in "Overclock", what's the truth? They may spend quite a lot of time and money to study, try and use many different hard-

ware or BIOS tools to do "Overclock". And even with these technologies, they still learn that it's quite a risk because the safety and stability of an "Overclock" system is unknown. Now everything is different because of a Windows based overclocking utility "EasyTune 4" --announced by Gigabyte. This windows based utility has totally changed the gaming rule of "Overclock". This is the first windows based overclocking utility is suitable for both normal and power users. Users can choose either "Easy Mode" or "Advanced Mode" for overclocking at their convenience. For users who choose "Easy Mode", they just need to click "Auto Optimize" to have autoed and immediate CPU overclocking. This software will then overdrive CPU speed automatically with the result being shown in the control panel. If users prefer "Overclock" by them, there is also another choice. Click "Advanced Mode" to enjoy "sport drive" class Overclocking user interface. "Advanced Mode", allows users to change the system bus / AGP / Memory working frequency in small increments to get ultimate system performance. It operates in coordination with Gigabyte motherboards. Besides, it is different from other traditional over-clocking methods, EasyTune 4 doesn't require users to change neither BIOS nor hardware switch/jumper setting; on the other hand, they can do "Overclock" at easy step. Therefore, this is a safer way for "Overclock" as nothing is changed on software or hardware. If user runs EasyTune 4 over system's limitation, the biggest loss is only to restart the computer again and the side effect is then well controlled. Moreover, if one well-performed system speed has been tested in EasyTune 4, user can "Save" this setting and "Load" it in next time. Obviously, Gigabyte EasyTune 4 has already turned the "Overclock" technology toward to a newer generation. This wonderful software is now free bundled in Gigabyte motherboard attached in driver CD. Users may make a test drive of "EasyTune 4" to find out more amazing features by themselves.

*Some Gigabyte products are not fully supported by EasyTune 4. Please find the products supported list in the web site.

*Any "Overclocking action" is at user's risk, Gigabyte Technology will not be responsible for any damage or instability to your processor, motherboard, or any other components.

Flash BIOS Method Introduction

Method 1: Q-Flash

A. What is Q-Flash Utility?

Q-Flash utility is a pre-O.S. BIOS flash utility enables users to update its BIOS within BIOS mode, no more fooling around any OS.

B. How to use Q-Flash?

a. After power on the computer, pressing immediately during POST (Power On Self Test) it will allow you to enter AWARD BIOS CMOS SETUP, then press <F8> to enter Q-Flash utility.

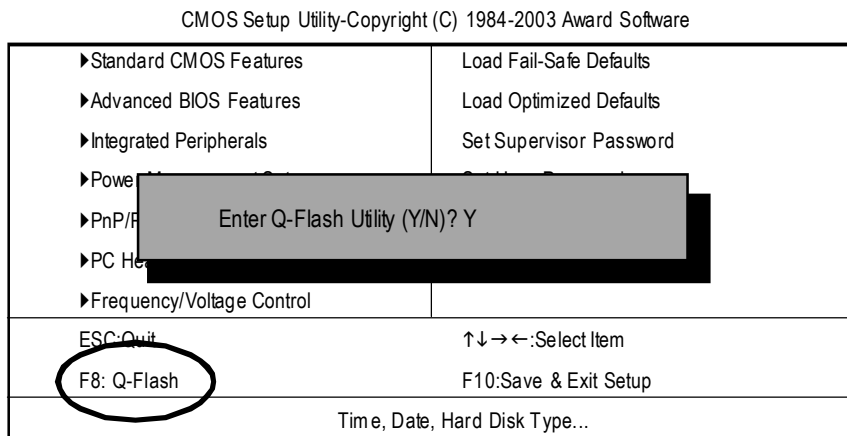

b. Q-Flash Utility

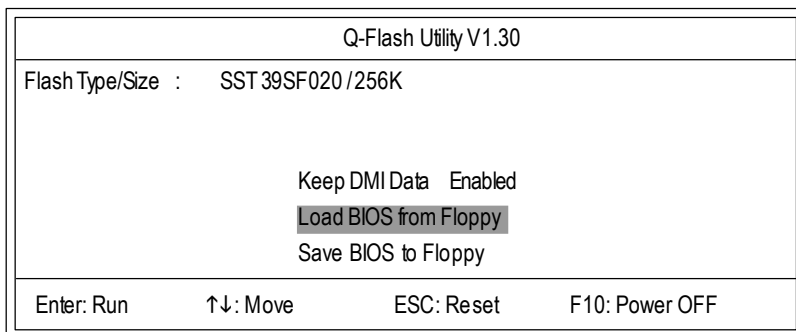

Load BIOS From Floppy

 In the A:drive, insert the "BIOS" diskette, then Press Enter to Run.

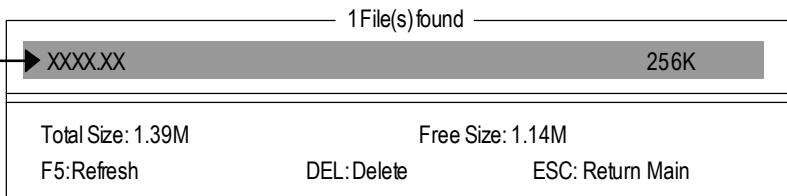

Where XXXX.XX is name of the BIOS file.

 Press Enter to Run.

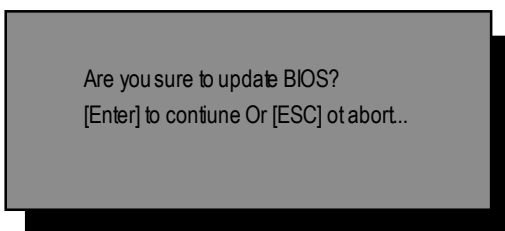

 Press Enter to Run.

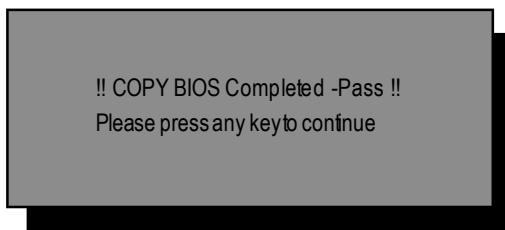

Congratulation! You have completed the flashed and now can restart system.

Method 2: @ BIOS Utility

If you don't have DOS boot disk, we recommend that you used Gigabyte @BIOS™ program to flash BIOS.



(1)

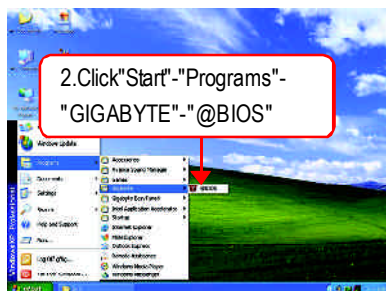

(2)

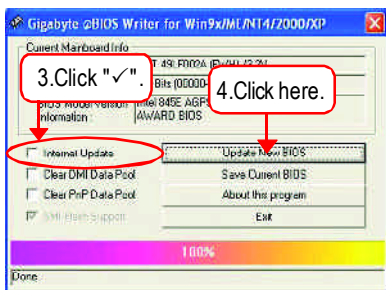

(3)

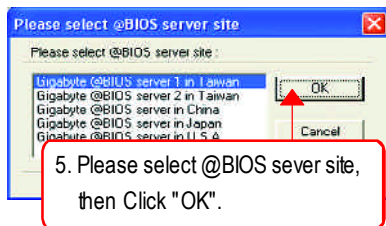

(4)

Methods and steps:

- I. Update BIOS through Internet
 - a. Click "Internet Update" icon
 - b. Click "Update New BIOS" icon
 - c. Select @BIOS™ sever
 - d. Select the exact model name on your motherboard
 - e. System will automatically download and update the BIOS.

II. Update BIOS NOT through Internet

- a. Do not click "Internet Update" icon
- b. Click "Update New BIOS"
- c. Please select "All Files" in dialog box while opening the old file.
- d. Please search for BIOS unzip file, downloading from internet or any other methods (such as: 7VM400MF.F1).
- e. Complete update process following the instruction.

III. Save BIOS

In the very beginning, there is "Save Current BIOS" icon shown in dialog box. It means to save the current BIOS version.

IV. Check out supported motherboard and Flash ROM:

In the very beginning, there is "About this program" icon shown in dialog box. It can help you check out which kind of motherboard and which brand of Flash ROM are supported.

Note:

- a. In method I, if it shows two or more motherboard's model names to be selected, please make sure your motherboard's model name again. Selecting wrong model name will cause the system unbooted.
- b. In method II, be sure that motherboard's model name in BIOS unzip file are the same as your motherboard's. Otherwise, your system won't boot.
- c. In method I, if the BIOS file you need cannot be found in @BIOS™ server, please go onto Gigabyte's web site for downloading and updating it according to method II.
- d. Please note that any interruption during updating will cause system unbooted.

2-/4-/6-Channel Audio Function Introduction

The installation of windows 98SE/2K/ME/XP is very simple. Please follow next step to install the function!

Stereo Speakers Connection and Settings:

We recommend that you use the speaker with amplifier to acquire the best sound effect if the stereo output is applied.

STEP 1:

Connect the stereo speakers or earphone to "Line Out".



Line Out

STEP 2 :

After installation of the audio driver, you'll find an  icon on the taskbar's status area. Click the audio icon "Sound Effect" from the windows tray at the bottom of the screen.

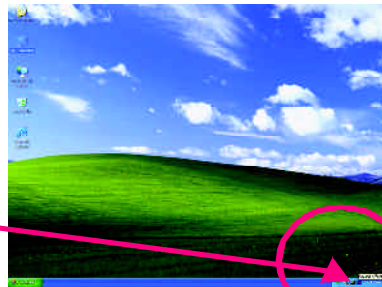

STEP 3:

Select "Speaker Configuration", and choose the "2 channels for stereo speakers out put".

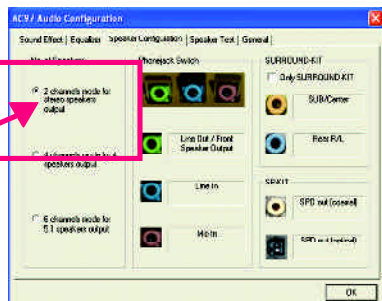

4 Channel Analog Audio Output Mode

STEP 1 :

Connect the front channels to "Line Out",
the rear channels to "Line In".



Line Out Line In

STEP 2 :

After installation of the audio driver, you'll find an  icon on the taskbar's status area. Click the audio icon "Sound Effect" from the windows tray at the bottom of the screen.

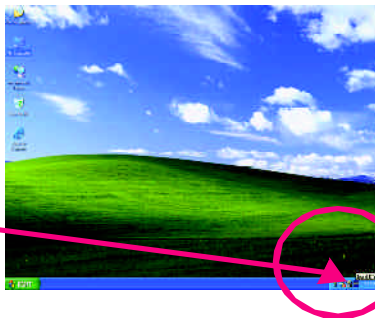

STEP 3 :

Select "Speaker Configuration", and choose the "4 channels for 4 speakers output".
Disable "Only SURROUND-KIT", and press "OK".

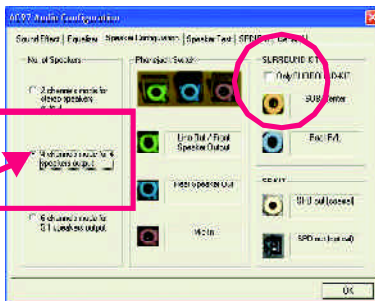

When the "Environment settings" is "None", the sound would be performed as stereo mode (2 channels output). Please select the other settings for 4 channels output.

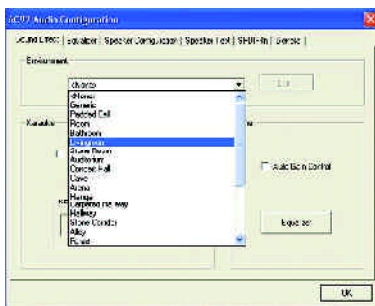

Basic 6 Channel Analog Audio Output Mode

Use the back audio panel to connect the audio output without any additional module.

STEP 1 :

Connect the front channels to "Line Out", the rear channels to "Line In", and the Center/Subwoofer channels to "MIC In".

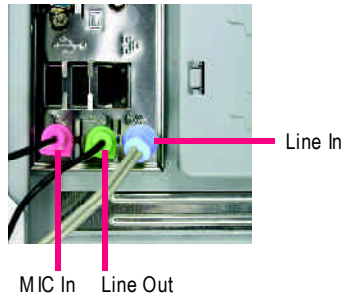

STEP 2 :

After installation of the audio driver, you'll find an  icon on the taskbar's status area. Click the audio icon "Sound Effect" from the windows tray at the bottom of the screen.

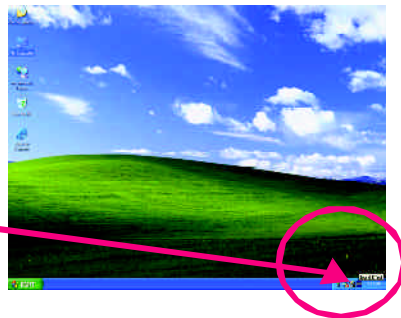

STEP 3 :

Select "Speaker Configuration", and choose the "6 channels for 5.1 speakers out put".

Disable "Only SURROUND-KIT" and press "OK".

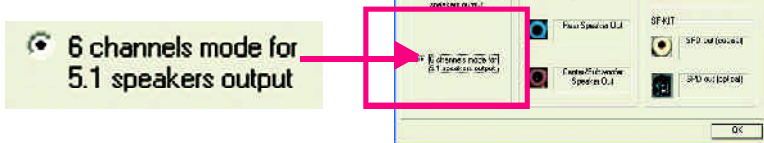

Advanced 6 Channel Analog Audio Output Mode (using Audio Combo Kit,Optional Device):

(Audio Combo Kit provides SPDIF output port : optical & coaxial and SURROUND-KIT : Rear R/L & CEN /Subwoofer)

SURROUND-KIT access analog output to rear channels and Center/Subwoofer channels. It is the best solution if you need 6 channel output, Line In and MIC at the same time. "SURROUND-KIT" is included in the GIGABYTE unique "Audio Combo Kit" as picture.

**STEP 1 :**

Insert the "SURROUND-KIT" in the back of the case ,and fix it with the screw.

**STEP 2 :**

Connect the "SURROUND-KIT" to SUR_CEN on the M/B.

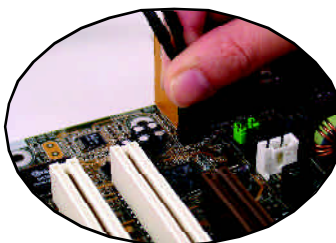
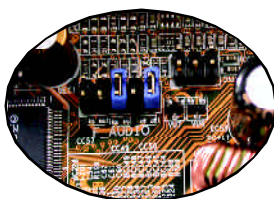

STEP 3 :

Connect the front channels to back audio panel's "Line Out", the rear channels to SURROUND-KIT's REAR R/L, and the Center/Subwoofer channels to SURROUND-KIT's SUB CENTER.

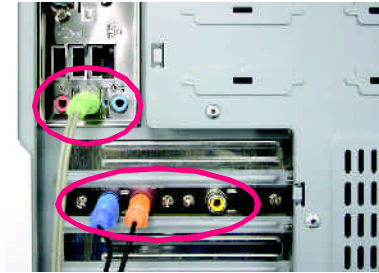

STEP 4 :

Click the audio icon "Sound Effect" from the windows tray at the bottom of the screen.

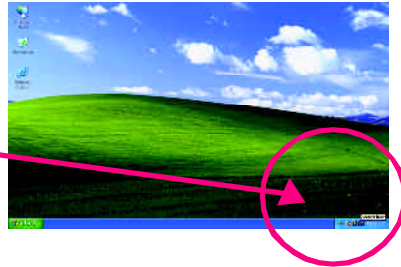
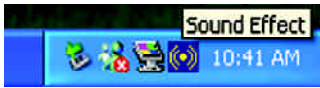

STEP 5 :

Select "Speaker Configuration", and choose the "6 channels for 5.1 speakers output".

Enable "Only SURROUND-KIT" and press "OK".

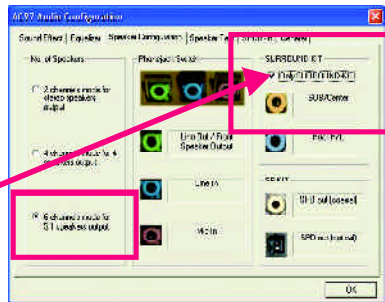

Basic & Advanced 6 Channel Analog Audio Output Mode Notes:

When the "Environment settings" is "None", the sound would be performed as stereo mode(2 channels output). Please select the other settings for 6 channels output.

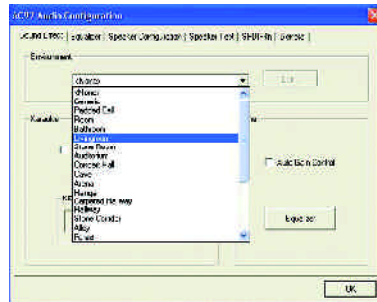

SPDIF Output Device (Optional Device)

A "SPDIF output" device is available on the motherboard. Cable with rear bracket is provided and could link to the "SPDIF output" connector (As picture.) For the further linkage to decoder, rear bracket provides coaxial cable and Fiber connecting port.

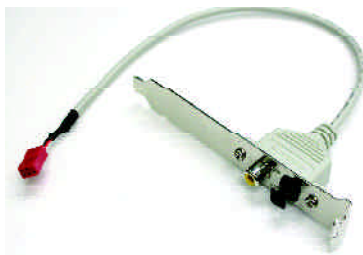

1. Connect the SPDIF output device to the rear bracket of PC, and fix it with screw.



2. Connect SPDIF device to the motherboard.

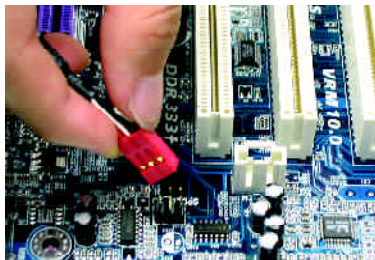

3. Connect SPDIF to the SPDIF decoder.

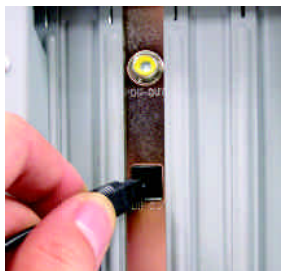

Chapter 5 Appendix

Install Drivers



Pictures below are shown in Windows XP (CD ver. 2.21)

Insert the driver CD-title that came with your motherboard into your CD-ROM drive, the driver CD-title will auto start and show the installation guide. If not, please double click the CD-ROM device icon in "My computer", and execute the setup.exe.

INSTALL CHIPSET DRIVER

This page shows the drivers that need to be installed for the system. Click each item to install the driver manually or switch to the  to install the drivers automatically.

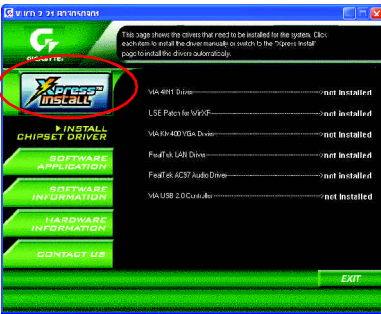

Message: Some device drivers will restart your system automatically. After restarting your system the "Xpress Install" will continue to install other drivers.

The "Xpress Install" uses the "Click and Forget" technology to install the drivers automatically. Just select the drivers you want then click the "GO" button. The  will execute the installation for you by itself.

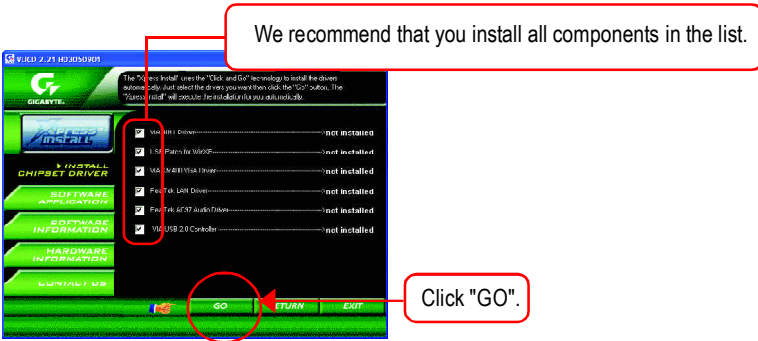

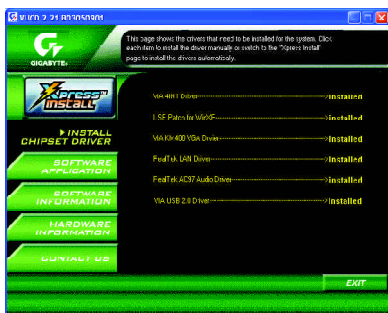

Driver install finished!! you have to reboot system!!

Item Description

- VIA 4IN1 Driver
For INF, AGP, IDE and DMA Driver
- USB Path for WinXP
This patch driver can help you to resolve the USB device wake up S3 hang up issue in XP
- VIA KM400 VGA Driver
For VIA KM400 VGA driver.
- RealTek LAN Driver
RealTek 10/100 LAN driver for 81xx series chips
- RealTek AC97 Audio Driver
Audio driver for Realtek AC97 codec chipset
- VIA USB 2.0 Controller
For VIA VT8233 (VT6203) / VIA VT8235 south bridge



For USB2.0 driver support under Windows XP operating system, please use Windows Service Pack. After install Windows Service Pack, it will show a question mark "?" in "Universal Serial Bus controller" under "Device Manager". Please remove the question mark and restart the system (System will auto-detect the right USB2.0 driver).

SOFTWARE APPLICATION

This page reveals the value-added software developed by Gigabyte and its worldwide partners.

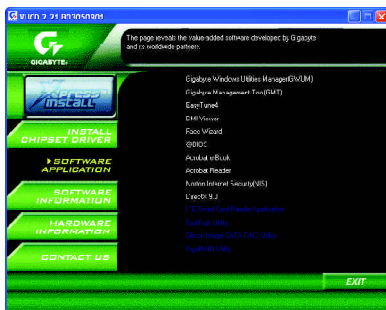

- **Gigabyte Windows Utilities Manager(GWUM)**
This utility can integrate the Gigabyte's applications in the system tray.
- **Gigabyte Management Tool(GMT)**
A useful tool which can manage the computer via the network.
- **EasyTune4**
Powerful utility that integrates the overclocking and hardware monitoring functions.
- **DMI Viewer**
Windows based utility which is used to browse the DMI/SMBIOS information of the system.
- **Face-Wizard**
New utility for adding BIOS logo.
- **@BIOS**
Gigabyte windows flash BIOS utility.
- **Acrobat e-Book**
Useful utility from Adobe.
- **Acrobat Reader**
Popular utility from Adobe for reading .PDF file format documents.
- **Norton Internet Security(NIS)**
Integrated utility which includes anti-virus, ad control, etc
- **DirectX 9.0**
Install Microsoft DirectX 9 to enable 3D hardware acceleration that support for operating system to achieve better 3D performance.

FAQ

Below is a collection of general asked questions. To check general asked questions based on a specific motherboard model, please log on to <http://tw.giga-byte.com/faq/faq.htm>

Question 1: I cannot see some options that were included in previous BIOS after updating BIOS. Why?

Answer: Some advanced options are hidden in new BIOS version. Please press Ctrl and F1 keys after entering BIOS menu and you will be able to see these options.

Questions 2: Why is the light of my keyboard/optical mouse still on after computer shuts down?
Answer: In some boards, a small amount of electricity is kept on standby after computer shuts down and that's why the light is still on.

Question 3: Why cannot I use all functions in EasyTune™ 4?

Answer: The availability of the listed functions in EasyTune™ 4 depends on the MB chipset. If the chipset doesn't support certain functions in EasyTune™ 4, these functions will be locked automatically and you will not be able to use them.

Question 4: Why do I fail to install RAID and ATA drivers under Win 2000 and XP on boards that support RAID function after I connect the boot HDD to IDE3 or IDE4 ?

Answer: First of all, you need to save some files in the CD-ROM to a floppy disk before installing drivers. You also need to go through some rather different steps in the installation process. Therefore, we suggest that you refer to the installation steps in the RAID manual at our website. (Please download it at http://tw.giga-byte.com/support/user_pdf/raid_manual.pdf)

Question 5: How do I clear CMOS?

Answer: If your board has a Clear CMOS jumper, please refer to the Clear CMOS steps in the manual. If your board doesn't have such jumper, you can take off the on-board battery to leak voltage to clear CMOS. Please refer to the steps below:

Steps:

1. Turn off power.
2. Disconnect the power cord from MB.
3. Take out the battery gently and put it aside for about 10 minutes (Or you can use a metal object to connect the positive and negative pins in the battery holder to make them short for one minute).
4. Re-insert the battery to the battery holder.
5. Connect power cord to MB again and turn on power.
6. Press Del to enter BIOS and load Fail-Safe Defaults.
7. Save changes and reboot the system.

Question 6: Why does system seem unstable after updating BIOS?

Answer: Please remember to load Fail-Safe Defaults (Or Load BIOS Defaults) after flashing BIOS. However, if the system instability still remains, please clear CMOS to solve the problem.

Question 7: Why do I still get a weak sound after turning up the speaker to the maximum volume?

Answer: Please make sure the speaker you are using is equipped with an internal amplifier. If not, please change another speaker with power/amplifier and try again later.

Question 8: How do I disable onboard VGA card in order to add an external VGA card?

Answer: Gigabyte motherboards will auto-detect the external VGA card after it is plugged in, so you don't need to change any setting manually to disable the onboard VGA.

Question 9: Why cannot I use the IDE 2?

Answer: Please refer to the user manual and check whether you have connected any cable that is not provided with the motherboard package to the USB Over Current pin in the Front USB Panel. If the cable is your own cable, please remove it from this pin and do not connect any of your own cables to it.

Question 10: Sometimes I hear different continuous beeps from computer after system boots up. What do these beeps usually stand for?

Answer: The beep codes below may help you identify the possible computer problems. However, they are only for reference purposes. The situations might differ from case to case.

→ AMI BIOS Beep Codes

*Computer gives 1 short beep when system boots successfully.

*Except for beep code 8, these codes are always fatal.

- 1 beep Refresh failure
- 2 beeps Parity error
- 3 beeps Base 64K memory failure
- 4 beeps Timer not operational
- 5 beeps Processor error
- 6 beeps 8042 - gate A20 failure
- 7 beeps Processor exception interrupt error
- 8 beeps Display memory read/write failure
- 9 beeps ROM checksum error
- 10 beeps CMOS shutdown register read/write error
- 11 beeps Cache memory bad

→ AWARD BIOS Beep Codes

- 1 short: System boots successfully
- 2 short: CMOS setting error
- 1 long 1 short: DRAM or M/B error
- 1 long 2 short: Monitor or display card error
- 1 long 3 short: Keyboard error
- 1 long 9 short: BIOS ROM error
- Continuous long beeps: DRAM error
- Continuous short beeps: Power error

Question 11: How to set in the BIOS in order to bootup from SATA HDDs by either RAID or ATA mode?

Answer: Please set in the BIOS as follow:

1. Advanced BIOS features--> SATA/RAID/SCSI boot order: "SATA"
2. Advanced BIOS features--> First boot device: "SCSI"
3. Integrated Peripherals--> Onboard H/W Serial ATA: "enable"

Then it depends on the SATA mode that you need to set "RAID" to RAID mode or "BASE" to normal ATA mode in the item named Serial ATA function.

Question 12:For the M/B which have RAID function, how to set in the BIOS in order to bootup from IDE3, 4 by either RAID or ATA mode?

Answer:Please set in the BIOS as follow:

1. Advanced BIOS features-->(SATA)/RAID/SCSI boot order: "SATA"
2. Advanced BIOS features--> First boot device: "SCSI"
3. Integrated Peripherals--> Onboard H/W ATA/RAID: "enable"

Then it depends on the RAID mode that you need to set "RAID" to RAID mode or "ATA" to normal ATA mode in the item named RAID controller function.

Question 13:How to set in the BIOS to bootup from the IDE/ SCSI/ RAID card ?

Answer:Please set in the BIOS as follow:

1. Advanced BIOS features-->(SATA)/RAID/SCSI boot order: "SCSI"
2. Advanced BIOS features--> First boot device: "SCSI"

Then it depends on the mode(RAID or ATA) that you need to set in RAID/ SCSI BIOS.

Troubleshooting



If you encounter any trouble during boot up, please follow the troubleshooting procedures .

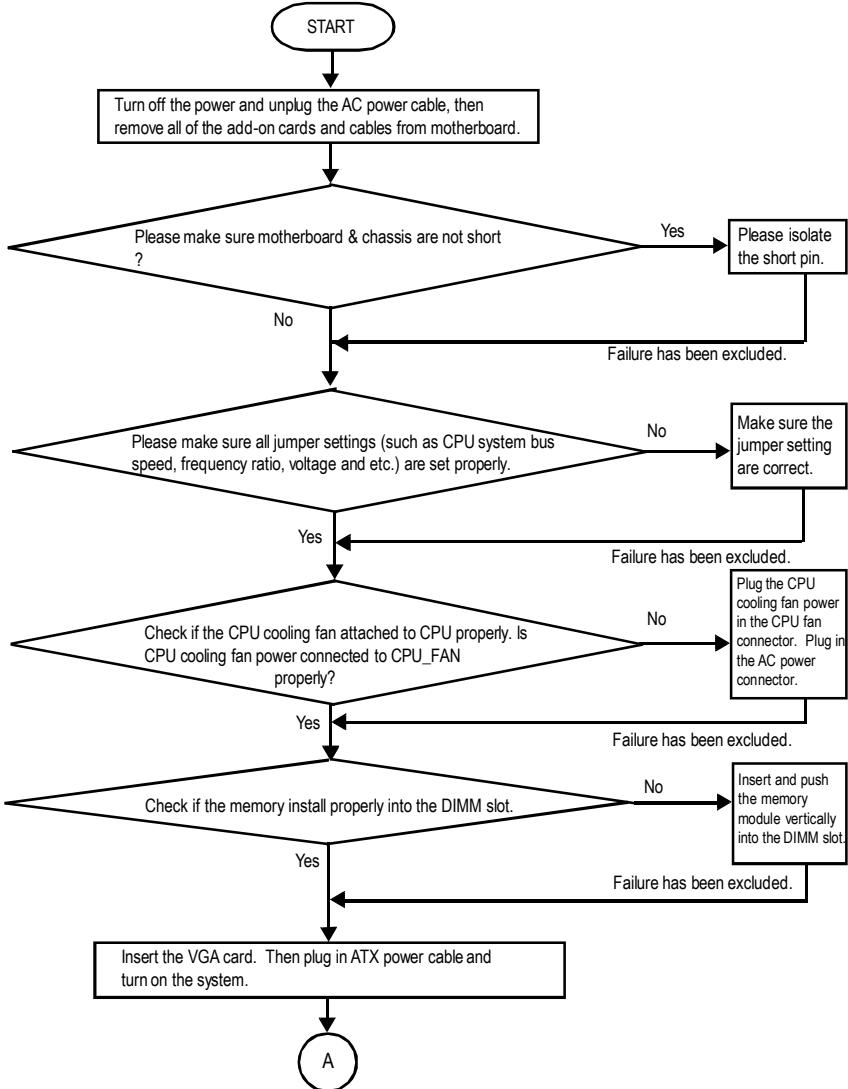

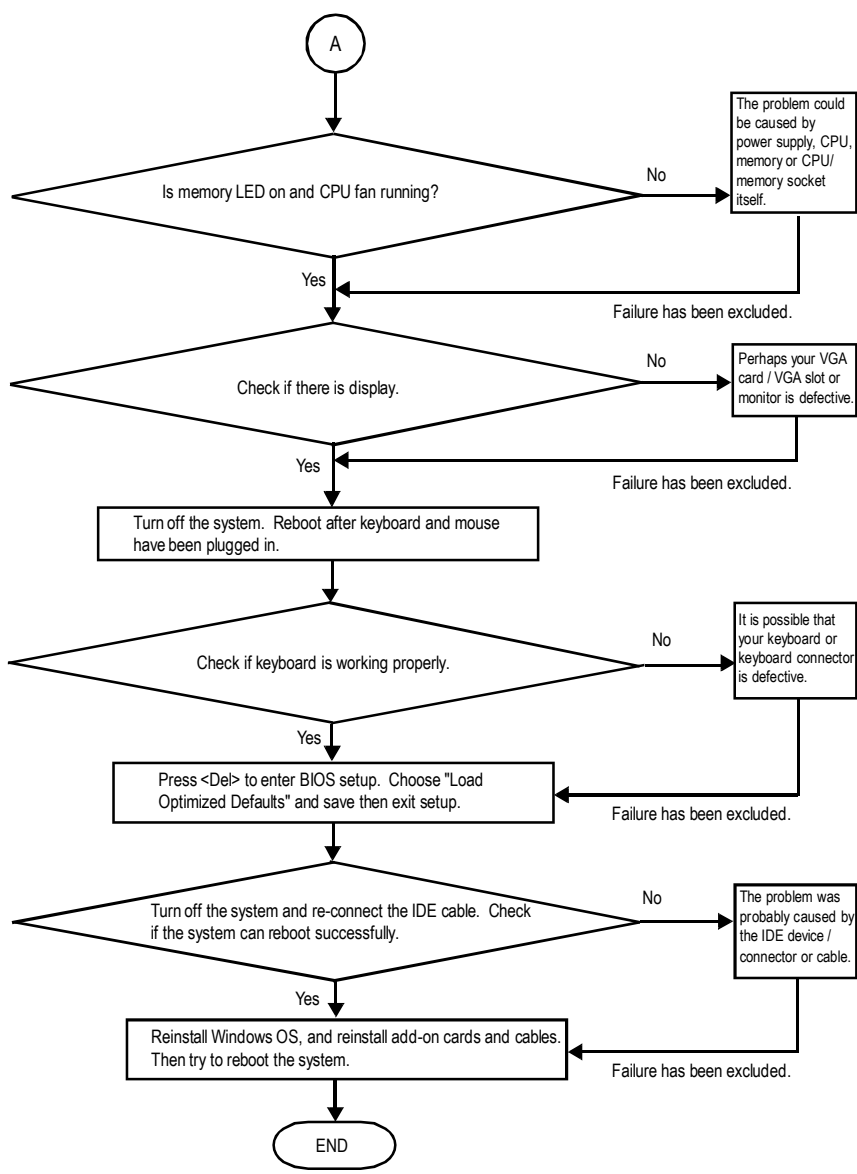

If the above procedure unable to solve your problem, please contact with your local retailer or national distributor for help. Or, you could submit your question to the service mail via Gigabyte website technical support zone (<http://www.gigabyte.com.tw>). The appropriate response will be provided ASAP.

Technical Support/RMA Sheet



Customer/Country:	Company:	Phone No.:
Contact Person:	E-mail Add. :	

Model name/Lot Number:	PCB revision:
BIOS version:	O.S./A.S.:

Hardware Configuration	Mfs.	Model name	Size:	Driver/Utility:
CPU				
Memory				
Brand				
Video Card				
Audio Card				
HDD				
CD-ROM / DVD-ROM				
Modem				
Network				
AMR / CNR				
Keyboard				
Mouse				
Power supply				
Other Device				

Problem Description:

Acronyms

Acronyms	Meaning
ACPI	Advanced Configuration and Power Interface
APM	Advanced Power Management
AGP	Accelerated Graphics Port
AMR	Audio Modem Riser
ACR	Advanced Communications Riser
BIOS	Basic Input / Output System
CPU	Central Processing Unit
CMOS	Complementary Metal Oxide Semiconductor
CRIMM	Continuity RIMM
CNR	Communication and Networking Riser
DMA	Direct Memory Access
DMI	Desktop Management Interface
DIMM	Dual Inline Memory Module
DRM	Dual Retention Mechanism
DRAM	Dynamic Random Access Memory
DDR	Double Data Rate
ECP	Extended Capabilities Port
ESCD	Extended System Configuration Data
ECC	Error Checking and Correcting
EMC	Electromagnetic Compatibility
EPP	Enhanced Parallel Port
ESD	Electrostatic Discharge
FDD	Floppy Disk Device
FSB	Front Side Bus
HDD	Hard Disk Device
IDE	Integrated Dual Channel Enhanced
IRQ	Interrupt Request

to be continued.....

Acronyms	Meaning
IOAPIC	Input Output Advanced Programmable Input Controller
ISA	Industry Standard Architecture
LAN	Local Area Network
I/O	Input / Output
LBA	Logical Block Addressing
LED	Light Emitting Diode
MHz	Megahertz
MIDI	Musical Instrument Digital Interface
MTH	Memory Translator Hub
MPT	Memory Protocol Translator
NIC	Network Interface Card
OS	Operating System
OEM	Original Equipment Manufacturer
PAC	PCI A.G.P. Controller
POST	Power-On Self Test
PCI	Peripheral Component Interconnect
RIMM	Rambus in-line Memory Module
SCI	Special Circumstance Instructions
SECC	Single Edge Contact Cartridge
SRAM	Static Random Access Memory

CONTACT US

Contact us via the information in this page all over the world.

- Taiwan

Gigabyte Technology Co., Ltd.

Address: No.6, Bau Chiang Road, Hsin-Tien, Taipei Hsien, Taiwan, R.O.C.

TEL: 886 (2) 8912-4888 (50 lines)

FAX: 886 (2) 8912-4004

Technical issue:

http://tw.giga-byte.com/support/service_main.htm

Non-Technical issue:

smsupport@gigabyte.com.tw

Web Address: <http://www.gigabyte.com.tw>

- USA

G.B.T. INC.

Address: 17358 Railroad St, City of Industry, CA 91748.

Tel: 1 (626) 854-9338

Fax: 1 (626) 854-9339

E-mail: sales@giga-byte.com

support@giga-byte.com

Web Address: www.giga-byte.com

- Germany

G.B.T. Technology Trading GmbH

Tel: 49-40-2533040

Fax: 49-40-25492343 (Sales)

Tel: 49-01803-428468 (Tech.)

Fax: 49-01803-428329 (Tech.)

E-mail: support@gigabyte.de

Web Address: www.gigabyte.de

- JAPAN/Nippon Giga-Byte Corporation

Web Address: www.gigabyte.co.jp

- U.K

G.B.T. TECH. CO. LTD.

Tel: 44-1908-362700

Fax: 44-1908-362709

E-mail: support@gbt-tech.co.uk

Web Address: www.gbt-tech.co.uk

- The Netherlands

Giga-Byte Technology B.V.

Address: Postbus 1385, 5602 BJ, Eindhoven, The Netherlands

Tel: +31 40 290 2088

Fax: +31 40 290 2089

E-mail: info@giga-byte.nl

Web Address: <http://www.giga-byte.nl>

- China

Shanghai Office

Tel: 86-21-64737410

Fax: 86-21-64453227

Web Address: www.gigabyte.com.cn

GuangZhou Office

Tel: 86-20-87586273

Fax: 86-20-87544306

Web Address: www.gigabyte.com.cn

Beijing Office

Tel: 86-10-82856054

86-10-82856064

86-10-82856094

Fax: 86-10-82856575

Web Address: www.gigabyte.com.cn

E-mail: bjsupport@gigabyte.com.cn

Chengdu Office

Tel: 86-28-85236930

Fax: 86-28-85256822

Web Address: www.gigabyte.com.cn
