



- **The author assumes no responsibility for any errors or omissions that may appear in this document nor does the author make a commitment to update the information contained herein.**
- **Third-party brands and names are the property of their respective owners.**
- **Please do not remove any labels on motherboard, this may void the warranty of this motherboard.**
- **Due to rapid change in technology, some of the specifications might be out of date before publication of this booklet.**



WARNING: Never run the processor without the heatsink properly and firmly attached. PERMANENT DAMAGE WILL RESULT!

Mise en garde : Ne faites jamais tourner le processeur sans que le dissipateur de chaleur soit fixé correctement et fermement. UN DOMMAGE PERMANENT EN RÉSULTERA !

Achtung: Der Prozessor darf nur in Betrieb genommen werden, wenn der Wärmeableiter ordnungsgemäß und fest angebracht ist. DIES HAT EINEN PERMANENTEN SCHADEN ZUR FOLGE!

Advertencia: Nunca haga funcionar el procesador sin el dissipador de calor instalado correcta y firmemente. ¡SE PRODUCIRÁ UN DAÑO PERMANENTE!

Aviso: Nunca execute o processador sem o dissipador de calor estar adequado e firmemente conectado. O RESULTADO SERÁ UM DAÑO PERMANENTE!

警告: 將散熱板牢固地安裝到處理器上之前，不要運行處理器。過熱將永遠損壞處理器！

警告: 將散熱器牢固地安裝到處理器上之前，不要運行處理器。過熱將永遠損壞處理器！

경고: 히트싱크를 제대로 또 단단히 부착시키지 않은 채 프로세서를 구동시키지 마십시오. 영구적 고장이 발생합니다!

警告: 永久的な損傷を防ぐため、ヒートシンクを正しくしっかりと取り付けるまでは、プロセッサを動作させないようにしてください。

Declaration of Conformity

We, Manufacturer/Importer
(full address)

G.B.T. Technology Trading GmbH
Ausschlag Weg 41, 1F, 20537 Hamburg, Germany

declare that the product
(description of the apparatus, system, installation to which it refers)

Mother Board

GA-7VKML
is in conformity with

(reference to the specification under which conformity is declared)
in accordance with 89/336 EEC-EMC Directive

<input type="checkbox"/> EN 55011	Limits and methods of measurement of radio disturbance characteristics of industrial, scientific and medical (ISM) high frequency equipment	<input type="checkbox"/> EN 61000-3-2* <input checked="" type="checkbox"/> EN 60555-2	Disturbances in supply systems cause by household appliances and similar electrical equipment "Harmonics"
<input type="checkbox"/> EN 55013	Limits and methods of measurement of radio disturbance characteristics of broadcast receivers and associated equipment	<input type="checkbox"/> EN 61000-3-3* <input checked="" type="checkbox"/> EN 60555-3	Disturbances in supply systems cause by household appliances and similar electrical equipment "Voltage fluctuations"
<input type="checkbox"/> EN 55014	Limits and methods of measurement of radio disturbance characteristics of household electrical appliances, portable tools and similar electrical apparatus	<input checked="" type="checkbox"/> EN 50081-1 <input checked="" type="checkbox"/> EN 50082-1	Generic emission standard Part 1: Residual commercial and light industry Generic immunity standard Part 1: Residual commercial and light industry
<input type="checkbox"/> EN 55015	Limits and methods of measurement of radio disturbance characteristics of fluorescent lamps and luminaries	<input type="checkbox"/> EN 55081-2	Generic emission standard Part 2: Industrial environment
<input type="checkbox"/> EN 55020	Immunity from radio interference of broadcast receivers and associated equipment	<input type="checkbox"/> EN 55082-2	Generic emission standard Part 2: Industrial environment
<input checked="" type="checkbox"/> EN 55022	Limits and methods of measurement of radio disturbance characteristics of information technology equipment	<input type="checkbox"/> ENV 55104	Immunity requirements for household appliances tools and similar apparatus
<input type="checkbox"/> DIN VDE 0855 <input type="checkbox"/> part 10 <input type="checkbox"/> part 12	Cabled distribution systems; Equipment for receiving and/or distribution from sound and television signals	<input type="checkbox"/> EN50091-2	EMC requirements for uninterruptible power systems (UPS)

CE marking

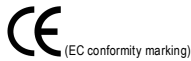

**The manufacturer also declares the conformity of above mentioned product
with the actual required safety standards in accordance with LVD 73/23 EEC**

<input type="checkbox"/> EN 60065	Safety requirements for mains operated electronic and related apparatus for household and similar general use	<input type="checkbox"/> EN 60950
<input type="checkbox"/> EN 60335	Safety of household and similar electrical appliances	<input type="checkbox"/> EN 50091-1

Manufacturer/Importer

(Stamp)

Date : July 31, 2002

Signature: Timmy Huang
Name: Timmy Huang

DECLARATION OF CONFORMITY

Per FCC Part 2 Section 2.1077(a)



Responsible Party Name: G.B.T. INC. (U.S.A.)

**Address: 17358 Railroad Street
City of Industry, CA 91748**

Phone/Fax No: (818) 854-9338/ (818) 854-9339

hereby declares that the product

Product Name: Motherboard

Model Number: GA-7VKML

Conforms to the following specifications:

FCC Part 15, Subpart B, Section 15.107(a) and Section 15.109(a),
Class B Digital Device

Supplementary Information:

This device complies with part 15 of the FCC Rules. Operation is subject to the following two conditions: (1) This device may not cause harmful and (2) this device must accept any interference received, including that may cause undesired operation.

Representative Person's Name: ERIC LU

Signature: Eric Lu

Date: July 31,2002

GA-7VKML Series
AMD Socket A Processor Motherboard

USER'S MANUAL

AMD Socket A Processor Motherboard
Rev. 3.4 First Edition
12ME-7VKML-3401

Table of Content

Item Checklist	4
WARNING!	4
Chapter 1 Introduction	5
Features Summary.....	5
GA-7VKML (PCB Ver.: 1.1) Motherboard Layout	7
GA-7VKML (PCB 3.2/3.3/3.4) Motherboard Layout.....	8
Chapter 2 Hardware Installation Process	9
Step 1: Install the Central Processing Unit (CPU)	10
Step1-1: CPU Speed Setup	10
Step1-2: CPU Installation.....	11
Step1-3: CPU Heat Sink Installation	12
Step 2: Install memory modules	13
Step 3: Install expansion cards	15
Step 4: Connect ribbon cables, cabinet wires, and power supply	16
Step4-1: I/O Back Panel Introduction	16
Step4-2: Connectors Introduction (For PCB Ver. : 3.2 ~ 3.4)	18
Step4-3: Connectors Introduction (For PCB Ver. : 1.1)	25
Chapter 3 BIOS Setup	31
The Main Menu (For example: BIOS Ver. : F9a)	32
Standard CMOS Features	34
BIOS Features Setup	37
Chipset Features Setup	39

Power Management Setup	42
PNP/PCI Configuration	45
Load Fail-Safe Defaults	47
Load Optimized Defaults	48
Integrated Peripherals	49
Hardware Monitor & MISC Setup	53
Set Supervisor / User Password	55
IDE HDD Auto Detection	56
Save & Exit Setup	57
Exit Without Saving	58
Chapter 4 Technical Reference	61
Block Diagram	61
@ BIOS™ Introduction	62
Easy Tune™ 4 Introduction	63
Q-Flash Utility Introduction	64
2-/4-/6-Channel Audio Function Introduction	79
Chapter 5 Appendix	87

Item Checklist

- | | |
|--|---|
| <input checked="" type="checkbox"/> The GA-7VKML series motherboard | <input type="checkbox"/> 2 Port USB Cable x 1 |
| <input checked="" type="checkbox"/> IDE cable x 1/ Floppy cable x 1 | <input type="checkbox"/> 4 Port USB Cable x 1 |
| <input checked="" type="checkbox"/> CD for motherboard driver & utility (VUCD) | <input type="checkbox"/> SPDIF KIT x 1 (SPD-KIT) |
| <input checked="" type="checkbox"/> GA-7VKML series user's manual | <input type="checkbox"/> IEEE 1394 Cable x 1 |
| <input checked="" type="checkbox"/> I/O Shield | <input type="checkbox"/> Center/Subwoofer Cable x 1
(SURROUND-KIT) |
| <input type="checkbox"/> Quick PC Installation Guide | <input type="checkbox"/> Motherboard Settings Label |
| <input type="checkbox"/> RAID Manual | |

WARNING!



Computer motherboards and expansion cards contain very delicate Integrated Circuit (IC) chips. To protect them against damage from static electricity, you should follow some precautions whenever you work on your computer.

1. Unplug your computer when working on the inside.
2. Use a grounded wrist strap before handling computer components. If you do not have one, touch both of your hands to a safely grounded object or to a metal object, such as the power supply case.
3. Hold components by the edges and try not touch the IC chips, leads or connectors, or other components.
4. Place components on a grounded antistatic pad or on the bag that came with the components whenever the components are separated from the system.
5. Ensure that the ATX power supply is switched off before you plug in or remove the ATX power connector on the motherboard.

Installing the motherboard to the chassis...

If the motherboard has mounting holes, but they don't line up with the holes on the base and there are no slots to attach the spacers, do not become alarmed you can still attach the spacers to the mounting holes. Just cut the bottom portion of the spacers (the spacer may be a little hard to cut off, so be careful of your hands). In this way you can still attach the motherboard to the base without worrying about short circuits. Sometimes you may need to use the plastic springs to isolate the screw from the motherboard PCB surface, because the circuit wire may be near by the hole. Be careful, don't let the screw contact any printed circuit write or parts on the PCB that are near the fixing hole, otherwise it may damage the board or cause board malfunctioning.

Chapter 1 Introduction

Features Summary

Form Factor	<ul style="list-style-type: none"> • 24.4cm x 21.7cm Micro ATX size form factor, 4 layers PCB. (For PCB Vev.: 1.1) • 24.3cm x 21.0cm Micro ATX size form factor, 4 layers PCB. (For PCB Ver.: 3.2~3.4)
Motherboard	<ul style="list-style-type: none"> • GA-7VKML Series Motherboard: GA-7VKML / GA-7VKML-P / 7VKML-DL
CPU	<ul style="list-style-type: none"> • Socket A processor AMD Athlon™/Athlon™ XP/Duron™ (K7) Socket A processor 128K L1 & 256K/64K L2 cache on die • Supports 1.4GHz and faster • 200/266MHz FSB and DDR bus speeds (PCI 33MHz)
Chipset	<ul style="list-style-type: none"> • VIA KM266 Memory/AGP/PCI Controller (PAC) • VIA VT8233A Low cost V-LINK Client Highly Integated
Memory	<ul style="list-style-type: none"> • 2 184-pin DDR DIMM sockets • Supports PC1600 DDR or PC2100 DDR DIMM • Supports up to 2GB DRAM (Max) • Supports only 2.5V DDR DIMM • Supports 64bit DRAM integrity mode
I/O Control	<ul style="list-style-type: none"> • IT8705F
Slots	<ul style="list-style-type: none"> • 1 AGP slot (2X/4X) device support • 3 PCI Slots Supports 33MHz & PCI 2.2 compliant • 1 CNR (Communication and Networking Riser) Slot (only secondary card) *
On-Board IDE	<ul style="list-style-type: none"> • 2 IDE bus master (ATA66/100/133) IDE ports for up to 4 ATAPI devices • Supports PIO mode3,4 (ATA66/100/133) IDE & ATAPI CD-ROM

*** Supported on motherboard version: 1.1 only.

to be continued.....

On-Board Peripherals	<ul style="list-style-type: none"> • 1 Floppy port supports 2 FDD with 360K, 720K, 1.2M, 1.44M and 2.88M bytes. • 1 Parallel port supports Normal/EPP/ECP mode • 2 Serial port (COM A, Internal COM B) • 1 VGA port • 4 USB ports (Rear USB x 2, Front USB x 2) • 1 IrDA connector for IR
Hardware Monitor	<ul style="list-style-type: none"> • CPU/System Fan Revolution detect • CPU/System temperature detect • System Voltage Detect
On-Board Sound #	<ul style="list-style-type: none"> • Realtek ALC101 CODEC • Line In/Line Out/Mic In/CD_In/AUX_In /Game Port
On-Board Sound **	<ul style="list-style-type: none"> • Realtek ALC650 CODEC • Line Out / 2 front speaker • Line In / 2 rear speaker(by s/w switch) • Mic In / center& subwoofer(by s/w switch) • SPDIF out • CD_In/ AUX_IN/Game Port
On-Board LAN ***	<ul style="list-style-type: none"> • Build in RTL8100 Chipset
PS/2 Connector	<ul style="list-style-type: none"> • PS/2 Keyboard interface and PS/2 Mouse interace
BIOS	<ul style="list-style-type: none"> • Licensed AMI BIOS, 2M bit Flash ROM • Support Q-Flash Utility
Additional Features	<ul style="list-style-type: none"> • STR(Suspend-To-RAM) • AC Recovery • USB KB/Mouse wake up from S3 • PS2 KB/Mouse wake up from S1, S3, S4, S5 • Supports @BIOS™ • Supports Easy Tune™ 4

"# " Supported 7VKML PCB VER: 3.2 / 3.3 / 3.4.

" " Supported GA-7VKML-P / GA-7VKML-DL (PCB VER:3.4)**

"* " Supported 7VKML (PCB VER: 3.2 ~ 3.4 and 7VKML-P)**

- Please set the CPU host frequency in accordance with your processor's specifications. We don't recommend you to set the system bus frequency over the CPU's specification because these specific bus frequencies are not the standard specifications for CPU, chipset and most of the peripherals. Whether your system can run under these specific bus frequencies properly will depend on your hardware configurations, including CPU, Chipsets, SDRAM, Cards....etc.

GA-7VKML (PCB Ver.: 1.1) Motherboard Layout

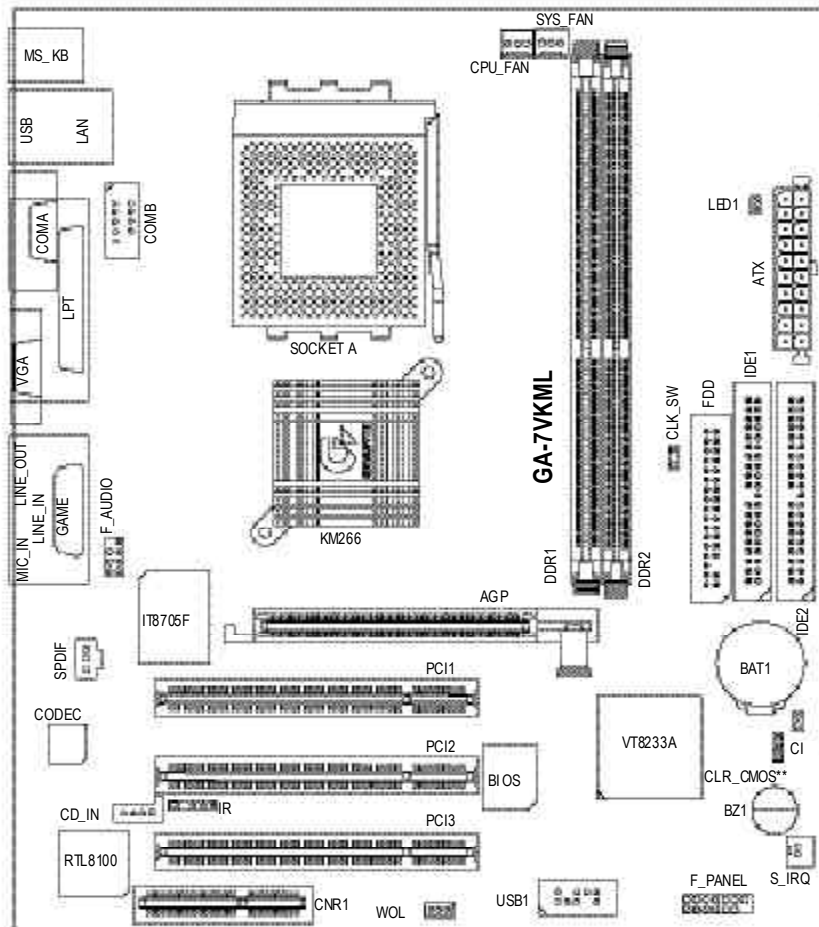

**** Supported on motherboard version: 1.1 only. Default doesn't include the "Shunter" to prevent from improper use this jumper. To clear CMOS, temporarily short 1-2 pin.

GA-7VKML (PCB 3.2/3.3/3.4) Motherboard Layout

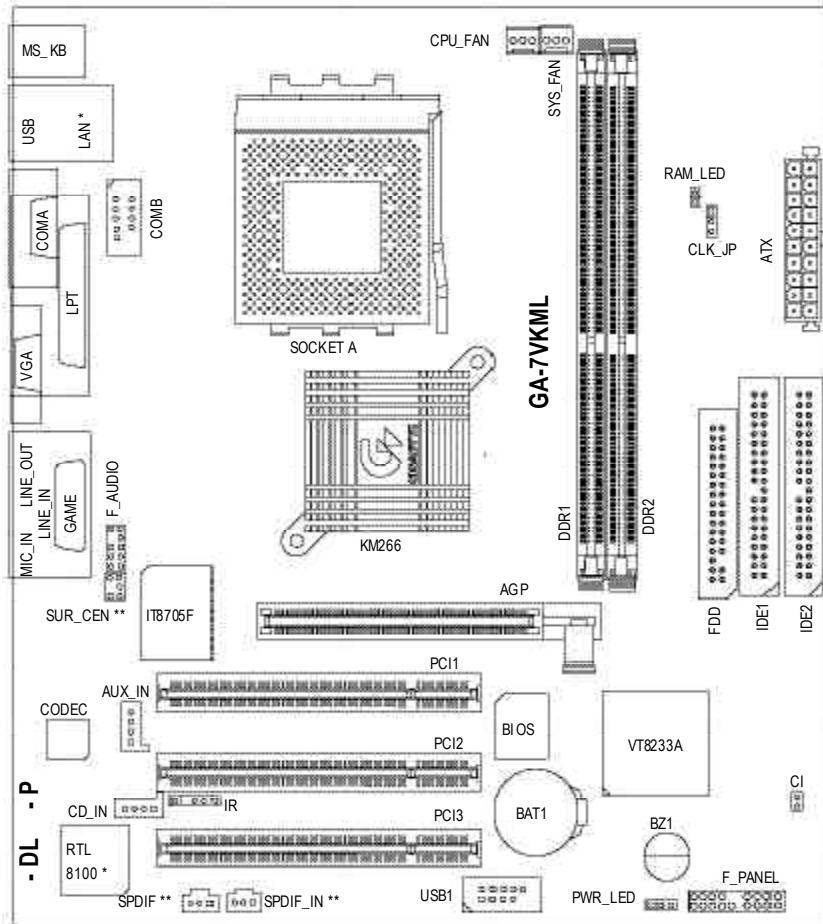

*** Not Supported 7VKML-DL (PCB VER:3.4)

*** Supported 7VKML-P / 7VKML-DL (PCB VER:3.4)

Chapter 2 Hardware Installation Process

To set up your computer, you must complete the following setups:

- Step 1- Set system Switch (CLK_SW)...for PCB Ver. 1.1
- Step 1- Set system Jumper(CLK_JP)...for PCB Ver. 3.2
- Step 2- Install the Central Processing Unit (CPU)
- Step 3- Install memory modules
- Step 4- Install expansion cards
- Step 5- Connect ribbon cables, cabinet wires, and power supply
- Step 6- Setup BIOS software
- Step 7- Install supporting software tools

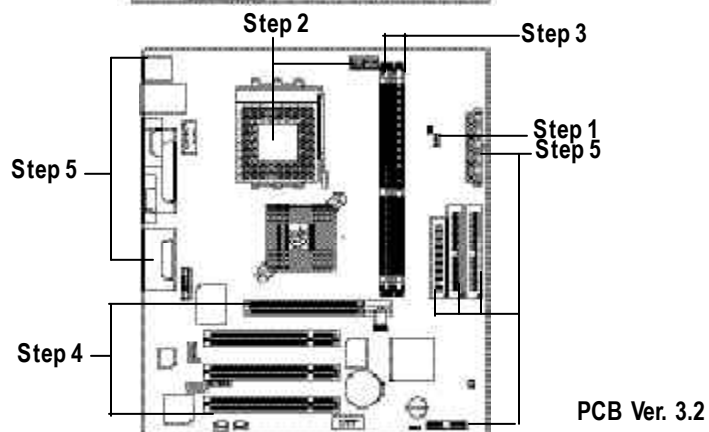
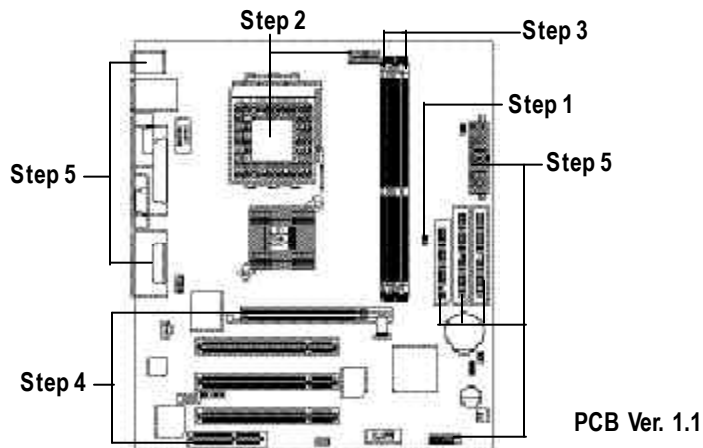

Step 1: Install the Central Processing Unit (CPU)

Step1-1: CPU Speed Setup

The system bus frequency can be switched at 100/133MHz by adjusting CLK_SW.
(The frequency ratio depend on CPU.)

PCB Ver: 1.1 used

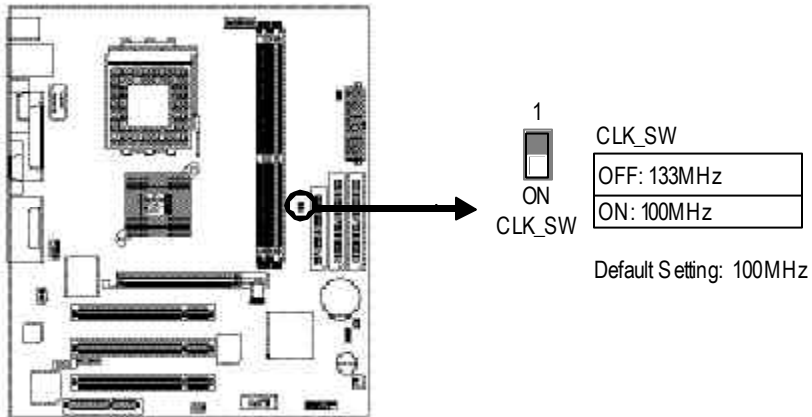

The system bus frequency can be switched at 100/133MHz by adjusting CLK_JP.
(The frequency ratio depend on CPU.)

PCB Ver: 3.2 ~ 3.4 used

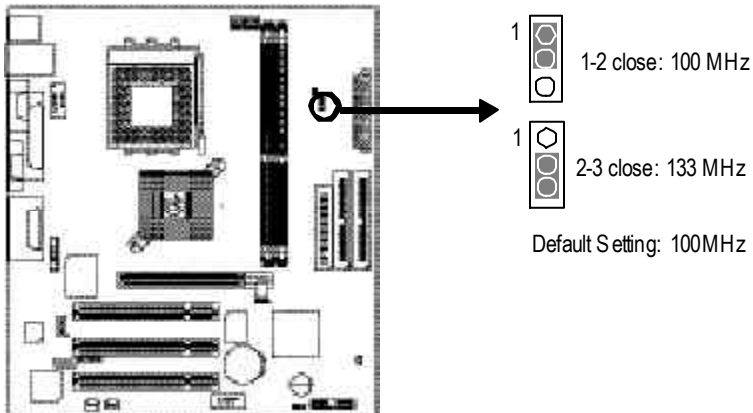

Step1-2: CPU Installation



CPU Top View

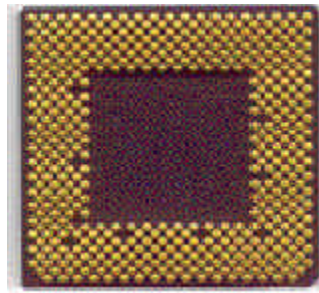

CPU Bottom View

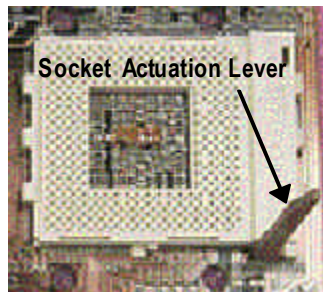

1. Pull up the CPU socket lever and up to 90-degree angle.

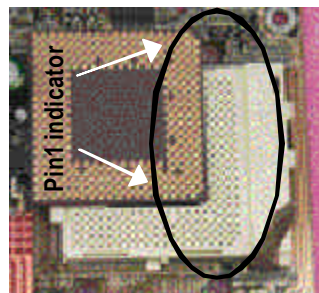

2. Locate Pin 1 in the socket and look for a (golden) cut edge on the CPU upper corner. Then insert the CPU into the socket.

- Please make sure the CPU type is supported by the motherboard.
- If you do not match the CPU socket Pin 1 and CPU cut edge well, it will cause improper installation. Please change the insert orientation.

Step1-3: CPU Heat Sink Installation

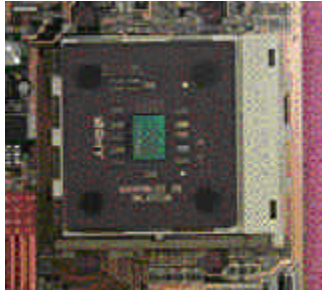

1. Press down the CPU socket lever and finish CPU installation.



2. Use qualified fan approved by AMD.



3. Fasten the heatsink supporting-base onto the CPU socket on the main-board.

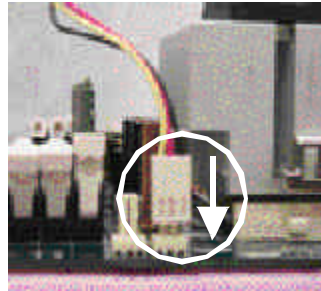

4. Make sure the CPU fan is plugged to the CPU fan connector, than install complete.

- Please use AMD approved cooling fan.
- We recommend you to apply the thermal paste to provide better heat conduction between your CPU and heatsink.
- Make sure the CPU fan power cable is plugged in to the CPU fan connector, this completes the installation.
- Please refer to CPU heat sink user's manual for more detail installation procedure.

Step 2: Install memory modules

The motherboard has 2 dual inline memory module (DIMM) sockets. The BIOS will automatically detects memory type and size. To install the memory module, just push it vertically into the DIMM Slot. The DIMM module can only fit in one direction due to the notch. Memory size can vary between sockets.

Total Memory Sizes With Unbuffered DDR DIMM

Devices used on DIMM	1 DIMMx64/x72	2 DIMMsx64/x72
64 Mbit (2Mx8x4 banks)	128 MBytes	256 MBytes
64 Mbit (1Mx16x4 banks)	64 MBytes	128 MBytes
128 Mbit(4Mx8x4 banks)	256 MBytes	512 MBytes
128 Mbit(2Mx16x4 banks)	128 MBytes	256 MBytes
256 Mbit(8Mx8x4 banks)	512 MBytes	1 GBytes
256 Mbit(4Mx16x4 banks)	256 MBytes	512 MBytes
512 Mbit(8Mx16x4 banks)	512 MBytes	1 GBytes

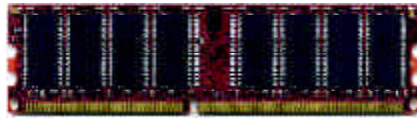

DDR



1. The DIMM slot has a notch, so the DIMM memory module can only fit in one direction.
 2. Insert the DIMM memory module vertically into the DIMM slot. Then push it down.
 3. Close the plastic clip at both edges of the DIMM slots to lock the DIMM module.
- Reverse the installation steps when you wish to remove the DIMM module.

DDR Introduction

Established on the existing SDRAM industry infrastructure, DDR (Double Data Rate) memory is a high performance and cost-effective solution that allows easy adoption for memory vendors, OEMs and system integrators.

DDR memory is a sensible evolutionary solution for the PC industry that builds on the existing SDRAM infrastructure, yet makes awesome advances in solving the system performance bottleneck by doubling the memory bandwidth. DDR SDRAM will offer a superior solution and migration path from existing SDRAM designs due to its availability, pricing and overall market support. PC2100 DDR memory (DDR266) doubles the data rate through reading and writing at both the rising and falling edge of the clock, achieving data bandwidth 2X greater than PC133 when running with the same DRAM clock frequency. With peak bandwidth of 2.1GB per second, DDR memory enables system OEMs to build high performance and low latency DRAM subsystems that are suitable for servers, workstations, high-end PC's and value desktop SMA systems. With a core voltage of only 2.5 Volts compared to conventional SDRAM's 3.3 volts, DDR memory is a compelling solution for small form factor desktops and notebook applications.

- **When RAM_LED is ON, do not install/remove DDR from socket.**
- **Please note that the DIMM module can only fit in one direction due to the two notches. Wrong orientation will cause improper installation. Please change the insert orientation.**

Step 3: Install expansion cards

1. Read the related expansion card's instruction document before install the expansion card into the computer.
2. Remove your computer's chassis cover, screws and slot bracket from the computer.
3. Press the expansion card firmly into expansion slot in motherboard.
4. Be sure the metal contacts on the card are indeed seated in the slot.
5. Replace the screw to secure the slot bracket of the expansion card.
6. Replace your computer's chassis cover.
7. Power on the computer, if necessary, setup BIOS utility of expansion card from BIOS.
8. Install related driver from the operating system

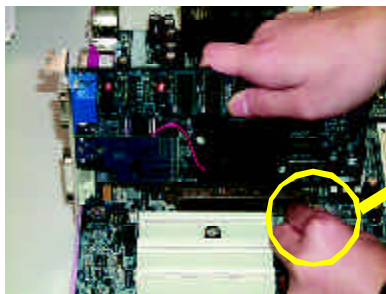

AGPCard



Please carefully pull out the small white-drawable bar at the end of the AGP slot when you try to install/ Uninstall the AGP card. Please align the AGP card to the onboard AGP slot and press firmly down on the slot. Make sure your AGP card is locked by the small white-drawable bar.

Issues To Beware Of When Installing CNR (Only for PCB Ver.: 1.1)

Please use standard CNR card like the one in order to avoid mechanical problem.



Standard CNR card

Step 4: Connect ribbon cables, cabinet wires, and power supply

Step4-1: I/O Back Panel Introduction

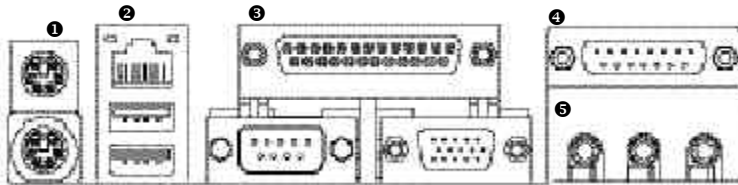

❶ PS/2 Keyboard and PS/2 Mouse Connector



PS/2 Mouse Connector
(6 pin Female)

PS/2 Keyboard Connector
(6 pin Female)

➤ This connector supports standard PS/2 keyboard and PS/2 mouse.

❷ USB & LAN Connector

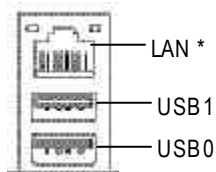

➤ Before you connect your device(s) into USB connector(s), please make sure your device(s) such as USB keyboard, mouse, scanner, zip, speaker...etc. Have a standard USB interface. Also make sure your OS supports USB controller. If your OS does not support USB controller, please contact OS vendor for possible patch or driver upgrade. For more information please contact your OS or device(s) vendors.

" * " Not Supported 7VKML-DL (PCB VER:3.4)

3 Parallel Port and VGA Port/COMA Port

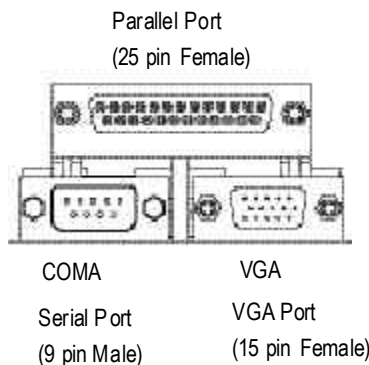

- This mainboard supports 1 standard COM port, 1 VGA port and 1 LPT port. Device like printer can be connected to LPT port; mouse and modem etc can be connected to COM port.

4 Game /MIDI Ports

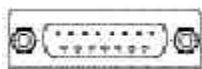

Joystick/ MIDI (15 pin Female)

- This connector supports joystick, MIDI keyboard and other relate audio devices.

5 Audio Connectors

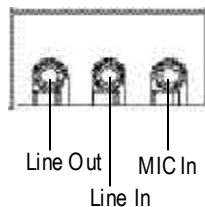

- After install onboard audio driver, you may connect speaker to Line Out jack, micro phone to MIC In jack. Device like CD-ROM, walkman etc can be connected to Line-In jack.

Please note:

You are able to use 2-/4-/6- channel audio feature by S/W selection.

If you want to enable 6-channel function, you have 2 choose for hardware connection.

Method1:

Connect "Front Speaker" to "Line Out"

Connect "Rear Speaker" to "Line In"

Connect "Center and Subwoofer" to "MIC Out".

Method2:

You can refer to page 24, and contact your nearest dealer for optional SUR_CEN cable.



If you want the detail information for 2-/4-/6-channel audio setup installation, please refer to page 79.

Step4-2: Connectors Introduction (For PCB Ver. : 3.2 ~ 3.4)

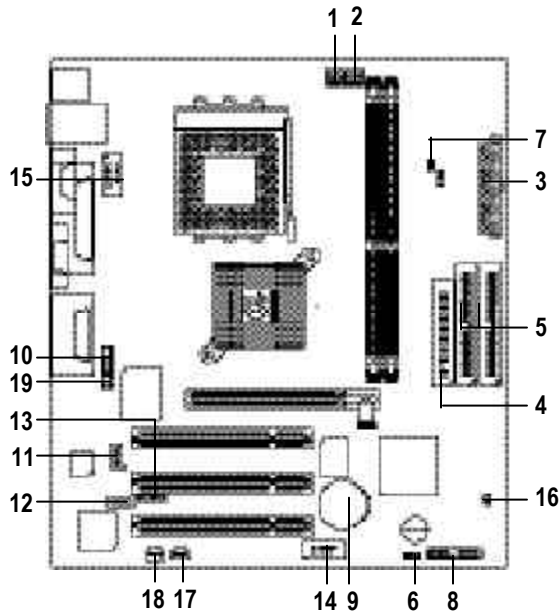

1) CPU_FAN	10) F_AUDIO
2) SYS_FAN	11) AUX_IN
3) ATX	12) CD_IN
4) FDD	13) IR
5) IDE1/IDE2	14) USB1
6) PWR_LED	15) COMB
7) RAM_LED	16) CI
8) F_PANEL	17) SPDIF_IN *
9) BAT1	18) SPDIF *
	19) SUR_GEN *

*** Supported 7VKML / 7VKML-P / 7VKML-DL (PCB VER:3.4)

1) CPU_FAN (CPU FAN Connector)

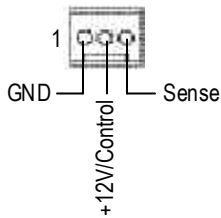

- Please note, a proper installation of the CPU cooler is essential to prevent the CPU from running under abnormal condition or damaged by overheating. The CPU fan connector supports Max. current up to 600mA .

2) SYS_FAN (System FAN Connector)

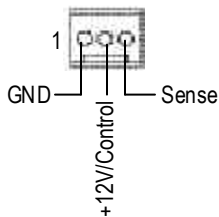

- This connector allows you to link with the cooling fan on the system case to lower the system temperature.

3) ATX (ATX Power)

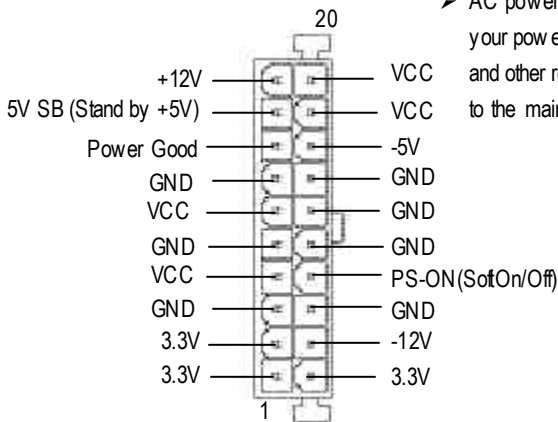

- AC power cord should only be connected to your power supply unit after ATX power cable and other related devices are firmly connected to the mainboard.

4) FDD (Floppy Connector)

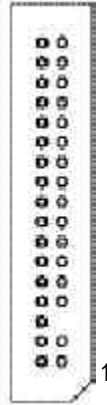

- Please connect the floppy driver ribbon cables to FDD. It supports 360K, 1.2M, 720K, 1.44M and 2.88M bytes floppy disk types. The red stripe of the ribbon cable must be the same side with the P in 1.

5) IDE1/IDE2 [IDE1 (Primary), IDE2(Secondary) Connector]

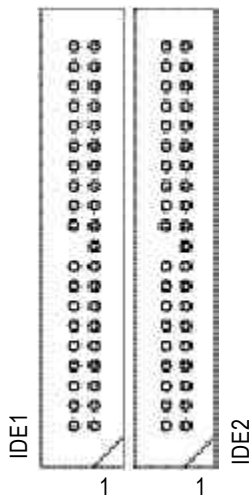

- Important Notice:
Please connect first harddisk to IDE1 and connect CDROM to IDE2.
The red stripe of the ribbon cable must be the same side with the P in 1.

6) PWR_LED

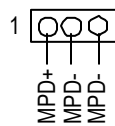

- PWR_LED is connect with the system power indicator to indicate whether the system is on/off. It will blink when the system enters suspend mode. If you use dual color LED, power LED will turn to another color.

7) RAM_LED



- Do not remove memory modules while DIMM LED is on. It might cause short or other unexpected damages due to the 2.5V stand by voltage. Remove memory modules only when AC Power cord is disconnected.

8) F_PANEL (2x10 pins jumper)

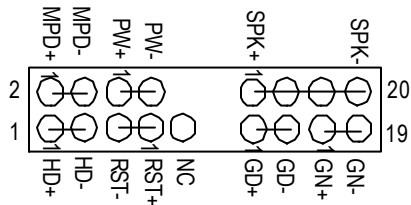

GN (Green Switch)	Open: Normal Operation Close: Entering Green Mode
GD (Green LED)	Pin 1: LED anode(+) Pin 2: LED cathode(-)
HD (IDE Hard Disk Active LED)	Pin 1: LED anode(+) Pin 2: LED cathode(-)
SPK (Speaker Connector)	Pin 1: VCC(+) Pin 2- Pin 3: NC Pin 4: Data(-)
RST (Reset Switch)	Open: Normal Operation Close: Reset Hardware System
PW (Soft Power Connector)	Open: Normal Operation Close: Power On/Off
MPD(Message LED/Power/Sleep LED)	Pin 1: LED anode(+) Pin 2: LED cathode(-)

- Please connect the power LED, PC speaker, reset switch and power switch etc of your chassis front panel to the F_PANEL connector according to the pin assignment above.

9) BAT1 (Battery)

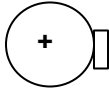

CAUTION

- ❖ Danger of explosion if battery is incorrectly replaced.
- ❖ Replace only with the same or equivalent type recommended by the manufacturer.
- ❖ Dispose of used batteries according to the manufacturer's instructions.

10) F_AUDIO (Front Audio)

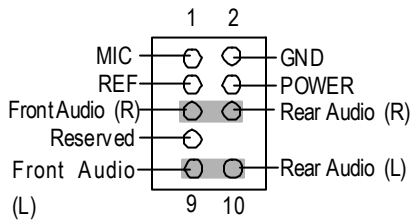

➤ If you want to use "FrontAudio" connector, you must move 5-6, 9-10 Jumper. In order to utilize the front audio header, your chassis must have front audio connector. Also please make sure the pin assignment on the cable is the same as the pin assignment on the MB header. To find out if the chassis you are buying support front audio connector, please contact your dealer.

11) CD_IN (CD Audio Line In)

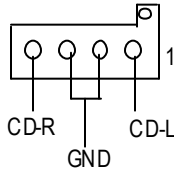

➤ Connect CD-ROM or DVD-ROM audio out to the connector.

12) AUX_IN (AUX_IN Connector)

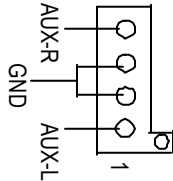

➤ Connect other device (such as PCI TV Tuner audio out) to the connector.

13) IR (IR)

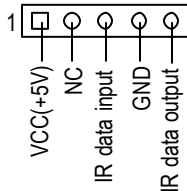

➤ Please note, Be careful with the polarity of the IR connector while you connect the IR. Please contact your nearest dealer for optional IR device.

14) F_USB1 (Front USB Connector)
(F_USB1 connector in yellow is for USB 1.1)

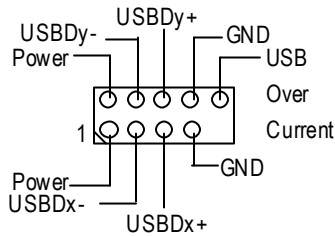

- Be careful with the polarity of the front USB connector. Check the pin assignment while you connect the front USB cable. Please contact your nearest dealer for optional front USB cable.

15) COMB (White)

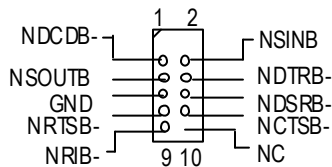

- Be careful with the polarity of the COMB connector. Check the pin assignment while you connect the COMB cable. Please contact your nearest dealer for optional COMB cable.

16) CI (Case Open)

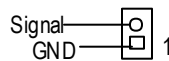

- This 2 pin connector allows your system to enable or disable the "case open" item in BIOS if the system case begins to remove.

17) SPDIF_IN *

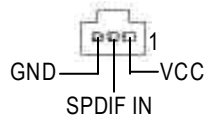

- The SPDIF output is capable of providing digital audio to external speakers or compressed AC3 data to an external Dolby Digital Decoder. Use this feature only when your stereo system has digital input function.

18) SPDIF *

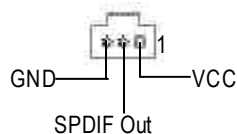

- Use this feature only when your device has digital output function.

" * " Supported 7VKML / 7VKML-P / 7VKML-DL (PCB VER:3.4)

19) SUR_CEN *

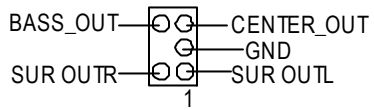

➤ Please contact your nearest dealer for optional SUR_CEN cable.

"*" Supported 7VKML / 7VKML-P / 7VKML-DL (PCB VER:3.4)

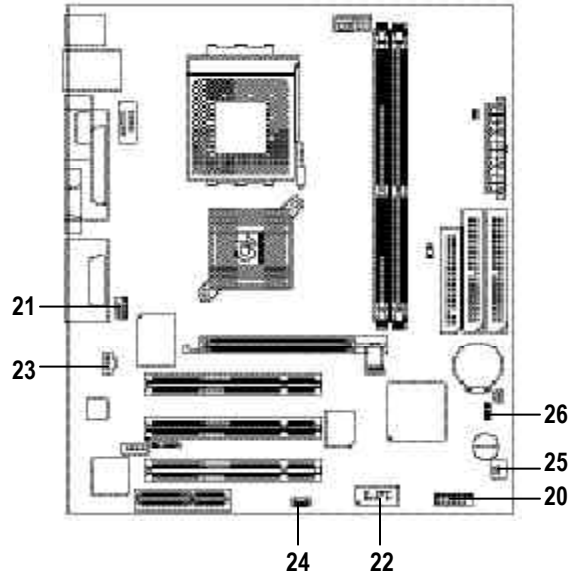
Step4-3: Connectors Introduction (For PCB Ver. : 1.1)

20) F_Panel	24) WOL
21) F_AUDIO	25) S_IRQ
22) USB1	26) CLR_CMOS
23) SPDIF	

20) F_PANEL (2x7 pins connector)

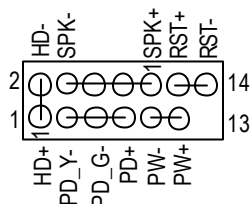

HD (IDE Hard Disk Active LED)	Pin 1: LED anode(+) Pin 2: LED cathode(-)
SPK (Speaker Connector)	Pin 1: VCC(+) Pin 2- Pin 3: NC Pin 4: Data(-)
RST (Reset Switch)	Open: Normal Operation Close: Reset Hardware System
PD+/PD_G-/PD_Y-(Power LED)	Pin 1: LED anode(+) Pin 2: LED cathode(-) Pin 3: LED cathode(-)
PW (Soft Power Connector)	Open: Normal Operation Close: Power On/Off

- Please connect the power LED, PC speaker, reset switch and power switch etc of your chassis front panel to the F_PANEL connector according to the pin assignment above.

21) F_AUDIO (Front Audio)

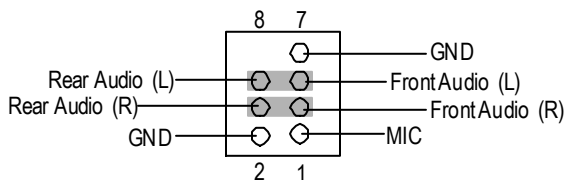

- If you want to use "FrontAudio" connector, you must remove 3-4, 5-6 Jumper. In order to utilize the front audio header, your chassis must have front audio connector. Also please make sure the pin assignment on the cable is the same as the pin assignment on the MB header. To find out if the chassis you are buying support front audio connector, please contact your dealer.

22) USB1 (Front USB)

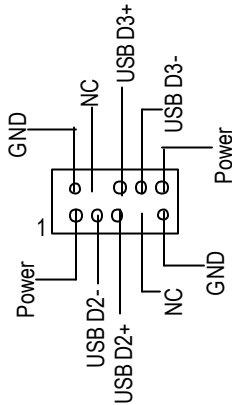

- Be careful with the polarity of the front panel USB connector. Check the pin assignment while you connect the front panel USB cable. Please contact your nearest dealer for optional front panel USB cable.

23) SPDIF (SPDIF)

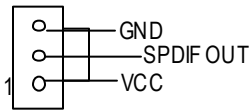

- The SPDIF output is capable of providing digital audio to external speakers or compressed AC3 data to an external Dolby Digital Decoder. Use this feature only when your stereosystem has digital output function.

24) WOL (Wake On Lan)

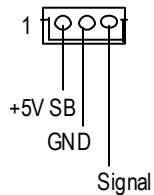

- This connector allows the remote servers to manage the system that is installed on this mainboard via your network adapter which also supports WOL.

25) S_IRQ (Serial IRQ)

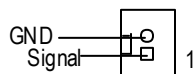

- Please Note: For special design, for example: PCMCIA add on card.

26) CLR_CMOS (Clear CMOS Function)



1-2 close: Clear CMOS



2-3 close: Normal (Default)

➤ Please note: You may clear the CMOS data to its default values by this jumper.

**Default doesn't include the "Shunter" to prevent from improper use this jumper.
To clear CMOS, temporarily short 1-2 pin.**

Chapter 3 BIOS Setup

BIOS Setup is an overview of the BIOS Setup Program. The program that allows users to modify the basic system configuration. This type of information is stored in battery-backed CMOS RAM so that it retains the Setup information when the power is turned off.

ENTERING SETUP

Powering ON the computer and pressing immediately will allow you to enter Setup. If you require more advanced BIOS settings, please go to "Advanced BIOS" setting menu. To enter Advanced BIOS setting menu, press "Ctrl+F1" key on the BIOS screen.

CONTROL KEYS

<↑>	Move to previous item
<↓>	Move to next item
<←>	Move to the item in the left hand
<→>	Move to the item in the right hand
<Enter>	Select item
<Esc>	Main Menu - Quit and not save changes into CMOS Status Page Setup Menu and Option Page Setup Menu - Exit current page and return to Main Menu
<+/PgUp>	Increase the numeric value or make changes
<-/PgDn>	Decrease the numeric value or make changes
<F1>	General help, only for Status Page Setup Menu and Option Page Setup Menu
<F2>	Reserved
<F3>	Reserved
<F4>	Reserved
<F5>	Restore the previous CMOS value from CMOS, only for Option Page Setup Menu
<F6>	Load the file-safe default CMOS value from BIOS default table
<F7>	Load the Optimized Defaults
<F8>	Q-Flash utility
<F9>	System Information
<F10>	Save all the CMOS changes, only for Main Menu

GETTING HELP

Main Menu

The on-line description of the highlighted setup function is displayed at the bottom of the screen.

Status Page Setup Menu / Option Page Setup Menu

Press F1 to pop up a small help window that describes the appropriate keys to use and the possible selections for the highlighted item. To exit the Help Window press <Esc>.

The Main Menu (For example: BIOS Ver. : F9a)

Once you enter AMI BIOS CMOS Setup Utility, the Main Menu (Figure 1) will appear on the screen. The Main Menu allows you to select from eight setup functions and two exit choices. Use arrow keys to select among the items and press <Enter> to accept or enter the sub-menu.

AMIBIOS SIMPLE SETUP UTILITY - VERSION 2.00			
(C) 2001 American Megatrends, Inc. All Rights Reserved			
STANDARD CMOS SETUP	INTEGRATED PERIPHERALS		
BIOS FEATURES SETUP	HARDWARE MONITOR & MISC SETUP		
CHIPSET FEATURES SETUP	SUPERVISOR PASSWORD		
POWER MANAGEMENT SETUP	USER PASSWORD		
PNP / PCI CONFIGURATION	IDE HDD AUTO DETECTION		
LOAD FAIL-SAFE DEFAULTS	SAVE & EXIT SETUP		
LOAD OPTIMIZED DEFAULTS	EXIT WITHOUT SAVING		
ESC: Quit	↑↓←→: Select Item	F5: Old Values	F6: Fail-Safe Values
F7: Optimized Values	F8: Q-Flash Utility	F10: Save & Exit	
Time, Date , Hard Disk Type...			

Figure 1: Main Menu

- **Standard CMOS Features**
This setup page includes all the items in standard compatible BIOS.
- **BIOS Features Setup**
This setup page includes all the adjustable items of AMI special enhanced features.
- **Chipset Features Setup**
This setup page includes all the adjustable items of chipset special features.

- **Power Management Setup**
This setup page includes all the adjustable items of Green function features.
- **PNP/PCI Configurations**
This setup page includes all the adjustable configurations of PCI & PnP ISA resources.
- **Load Fail-Safe Defaults**
Load Fail-Safe Defaults option loads preset system parameter values to set the system in its most stable configurations.
- **Load Optimized Defaults**
Load Optimized Defaults option loads preset system parameter values to set the system in its highest performance configurations.
- **Integrated Peripherals**
This setup page includes all onboard peripherals.
- **Hardware Monitor & MIS C Setup**
This setup page is auto detect fan and temperature status.
- **Set Supervisor Password**
Set Change or disable password. It allows you to limit access to the system and/or BIOS setup.
- **Set User Password**
Set Change or disable password. It allows you to limit access to the system.
- **IDE HDD Auto Detection**
Automatically configure hard disk parameters.
- **Save & Exit Setup**
Save CMOS value settings to CMOS and exit setup.
- **Exit Without Saving**
Abandon all CMOS value changes and exit setup.

Standard CMOS Features

AMIBIOS SETUP - STANDARD CMOS SETUP	
(C) 2001 American Megatrends, Inc. All Rights Reserved	
System Date : Jan 08 2002 Tue	
System Time : 14:44:35	
<u>TYPE SIZE CYLS HEAD PRECOMP LANDZ SECTOR MODE</u>	
Pri Master : Auto	
Pri Slave : Auto	
Sec Master : Auto	
Sec Slave : Auto	
Floppy Drive A : 1.44 MB 3 ^{1/2}	Base Memory : 640 Kb
Floppy Drive B : Not Installed	Other Memory : 384 Kb
Virus Protection : Disabled	Extended Memory : 95 Mb
	Total Memory : 96 Mb
Date is standard format	ESC : Exit
Month : Jan - Dec	↑↓ : Select Item
Day : 01- 31	PU / PD / + / - :Modify
Year : 1990 - 2099	(Shift) F2 : Color

Figure 2: Standard CMOS Setup

☞ System Date

The date format is <week>, <month>, <day>, <year>.

- ▶▶Week The week, from Sun to Sat, determined by the BIOS and is display only
- ▶▶Month The month, Jan. Through Dec.
- ▶▶Day The day, from 1 to 31 (or the maximum allowed in the month)
- ▶▶Year The year, from 1990 through 2099

☞ System Time

The times format in <hour> <minute> <second>. The time is calculated base on the 24-hour military time clock. For example, 1 p.m. is 13:00:00.

☞ Primary Master, Slave / Secondary Master, Slave

The category identifies the types of hard disk from drive C to F that has been installed in the computer. There are two types: auto type, and manual type. Manual type is user-definable; Auto type which will automatically detect HDD type.

Note that the specifications of your drive must match with the drive table. The hard disk will not work properly if you enter improper information for this category.

If you select User Type, related information will be asked to enter to the following items. Enter the information directly from the keyboard and press <Enter>. Such information should be provided in the documentation form your hard disk vendor or the system manufacturer.

▶▶ SIZE	HDD Size
▶▶ CYLS.	Number of cylinders
▶▶ HEADS	number of heads
▶▶ PRECOMP	write precomp
▶▶ LANDZONE	Landing zone
▶▶ SECTORS	number of sectors
▶▶ MODE	Logical block addressing

If a hard disk has not been installed select NONE and press <Enter>.

☞ Floppy Drive A / Drive B

The category identifies the types of floppy disk drive A or drive B that has been installed in the computer.

▶▶ Not Installed	No floppy drive installed
▶▶ 1.2M, 5.25 in.	5.25 inch AT-type high-density drive; 1.2M byte capacity (3.5 inch when 3 Mode is Enabled).
▶▶ 720K, 3.5 in.	3.5 inch double-sided drive; 720K byte capacity
▶▶ 1.44M, 3.5 in.	3.5 inch double-sided drive; 1.44M byte capacity.
▶▶ 2.88M, 3.5 in.	3.5 inch double-sided drive; 2.88M byte capacity.

☞ Virus Protection

If it is set to enable, the category will flash on the screen when there is any attempt to write to the boot sector or partition table of the hard disk drive. The system will halt and the following error message will appear in the mean time. You can run anti-virus program to locate the problem.

- ▶▶ Enabled Activate automatically when the system boots up causing a warning message to appear when anything attempts to access the boot sector or hard disk partition table
- ▶▶ Disabled No warning message to appear when anything attempts to access the boot sector or hard disk partition table (Default Value)

☞ Memory

The category is display-only which is determined by POST (Power On Self Test) of the BIOS.

Base Memory

The POST of the BIOS will determine the amount of base (or conventional) memory installed in the system.

The value of the base memory is typically 512 K for systems with 512 K memory installed on the motherboard, or 640 K for systems with 640 K or more memory installed on the motherboard.

Other Memory

This refers to the memory located in the 640 K to 1024 K address space. This is memory that can be used for different applications.

DOS uses this area to load device drivers to keep as much base memory free for application programs. Most use for this area is Shadow RAM.

Extended Memory

The BIOS determines how much extended memory is present during the POST.

This is the amount of memory located above 1 MB in the CPU's memory address map.

BIOS Features Setup

AMIBIOS SETUP - BIOS FEATURES SETUP	
(C) 2001 American Megatrends, Inc. All Rights Reserved	
BIOS Flash Protection	: Auto
1st Boot Device	: Floppy
2nd Boot Device	: IDE-0
3rd Boot Device	: CDROM
Floppy Drive Seek	: Disabled
BootUp Num-Lock	: On
Password Check	: Setup
S.M.A.R.T. for Hard Disks	: Disabled
Interrupt Mode	: APIC
ESC: Quit ↑↓←→: Select Item F1 : Help PU/PD+/-: Modify F5 : Old Values (Shift)F2: Color F6 : Fail-Safe F7:Optimized F8 : Q-Flash Utility	

Figure 3: BIOS Feature Setup

☞ BIOS Flash Protection

This field lets you determine the states that flash BIOS.

- ▶▶ Auto BIOS enables flash write access automatically when updating BIOS data/DMI/ESCD. (Default Value)
- ▶▶ Enabled During POST, DMI/ESCD would not be updated. But flash tools can update BIOS always.

☞ 1st / 2nd / 3rd Boot device

- ▶▶ Floppy Select your boot device priority by Floppy .
- ▶▶ CDROM Select your boot device priority by CDROM.
- ▶▶ Disabled Disable this function.
- ▶▶ IDE-0~3 Select your boot device priority by IDE-0~3.
- ▶▶ Realtek Boot Select your boot device priority by Realtek Lan function.

☞ Floppy Drive Seek

During POST, BIOS will determine the floppy disk drive installed is 40 or 80 tracks. 360 K type is 40 tracks 720 K, 1.2 M and 1.44 M are all 80 tracks.

- ▶▶ Enabled BIOS searches for floppy disk drive to determine it is 40 or 80 tracks. Note that BIOS can not tell from 720 K, 1.2 M or 1.44 M drive type as they are all 80 tracks.
- ▶▶ Disabled BIOS will not search for the type of floppy disk drive by track number. Note that there will not be any warning message if the drive installed is 360 K. (Default value)

☞ Boot Up Num-Lock

- ▶▶ On Keypad is number keys. (Default value)
- ▶▶ Off Keypad is arrow keys.

☞ Password Check

Please refer to the detail on P.55

- ▶▶ Always The user must enter correct password in order to access the system and/or BIOS Setup.
- ▶▶ Setup The user must enter correct password in order to access BIOS setup utility. (Default Value)

☞ S.M.A.R.T. for HardDisks

- ▶▶ Enabled Enable HDD S.M.A.R.T. Capability.
- ▶▶ Disabled Disable HDD S.M.A.R.T. Capability. (Default value)

☞ Interrupt Mode

- ▶▶ APIC Through IOAPIC generate more IRQ for system use. (Default value)
- ▶▶ PIC Use AT standard IRQ controller to generate IRQ.

When you already have IOAPIC enable system and want to upgrade the system please note, since running an IOAPIC enabled OS (like Windows NT, Windows 2000, Windows XP...) system with none IOAPIC HW support will cause the system to hang. Following are some situations users might run into:

1. An IOAPIC enabled OS and change the BIOS setting from IOAPIC to PIC, this will cause your system to hang.

Chipset Features Setup

We would not suggest you change the chipset default setting unless you really need it.

AMBIOS SETUP - CHIPSET FEATURES SETUP	
(C) 2001 American Megatrends, Inc. All Rights Reserved	
Configure SDRAM by SPD	:Enabled
SDRAM Frequency	:Auto
SDRAM CAS# Latency	:2.5
SDRAM Command Rate	:2T Command
AGP Mode	:4X
AGP Comp. Driving	:Auto
Manual AGP Comp. Driving	:DA
AGP Fast Write	:Disabled
AGP Aperture Size	:64MB
AGP Read Synchronization	:Disabled
PCI Delay Transaction	:Disabled
USB Controller	:4 USB Ports
USB Legacy Support	:Disabled
USB Port 64/60 Emulation	:Disabled
ESC: Quit ↑↓←→: Select Item F1 : Help PU/PD+/- : Modify F5 : Old Values (Shift)F2: Color F6 : Fail-Safe F7:Optimized F8 : Q-Flash Utility	

Figure 4: Chipset Features Setup

#These two items will be available when "Configure SDRAM by SPD" is set to Disabled.

☞ Configure SDRAM by SPD

- ▶▶ Disabled Disable Configure SDRAM by SPD.
- ▶▶ Enabled Enable Configure SDRAM by SPD. (Default Value)

☞ SDRAM Frequency

- ▶▶ 200MHz Set SDRAM Frequency to 200MHz.
- ▶▶ 266MHz Set SDRAM Frequency to 266MHz.
- ▶▶ Auto Set SDRAM Frequency to Auto. (Default Value)

☞ SDRAM CAS# Latency

- ▶▶ 2 For Fastest SDRAM DIMM module.
- ▶▶ 2.5 For Slower SDRAM DIMM module. (Default Value)

☞ SDRAM Command Rate

- ▶▶ 2T Command Set SDRAM Command Rate to 2T Command. (Default Value)
- ▶▶ 1T Command Set SDRAM Command Rate to 1T Command.

☞ AGP Mode

- ▶▶ 4X Set AGP Mode to 4X. (Default Value)
- ▶▶ 1X Set AGP Mode to 1X.
- ▶▶ 2X Set AGP Mode to 2X.

☞ AGP Comp. Driving

- ▶▶ Auto Set AGP Comp. Driving to Auto. (Default Value)
- ▶▶ Manual Set AGP Comp. Driving to Manual.

If AGP Comp. Driving is Manual.

Manual AGP Comp. Driving : 00~FF

☞ AGP Fast Write

- ▶▶ Disabled Disable AGP Fast Write. (Default Value)
- ▶▶ Enabled Enable AGP Fast Write.

☞ AGP Aperture Size

- ▶▶ 4MB Set AGP Aperture Size to 4MB.
- ▶▶ 8MB Set AGP Aperture Size to 8 MB.
- ▶▶ 16MB Set AGP Aperture Size to 16 MB.
- ▶▶ 32MB Set AGP Aperture Size to 32 MB.
- ▶▶ 64MB Set AGP Aperture Size to 64 MB. (Default Value)
- ▶▶ 128MB Set AGP Aperture Size to 128 MB.
- ▶▶ 256MB Set AGP Aperture Size to 256 MB.

☞ AGP Read Synchronization

- ▶▶ Enabled Enable AGP Read Synchronization.
- ▶▶ Disabled Disable AGP Read Synchronization. (Default Value)

☞ PCI Delay Transaction

- ▶▶ Enabled Enable PCI Delay Transaction.
- ▶▶ Disabled Disable PCI Delay Transaction. (Default Value)

☞ USB Controller

- ▶▶ Disabled Disable USB Controller function.
- ▶▶ 2USB Ports Enable 2USB Ports.
- ▶▶ 4USB Ports Enable 4USB Ports.

☞ USB Legacy Support

- ▶▶ No Mice Set USB Legacy Support Key board / Floppy .
- ▶▶ All Device Set USB Legacy Support Key board / Mouse / Floppy .
- ▶▶ Disabled Disable USB Legacy Support Function. (Default Value)

☞ Port 64/60 Emulation

- ▶▶ Enabled To use USB mouse under Win NT environment, set USB Legacy Support to KB/Mouse/FDD and USB Port 64/60 Emulation to enabled.
- ▶▶ Disabled Disable this Function. (Default Value)

Power Management Setup

AMIBIOS SETUP - POWER MANAGEMENT SETUP			
(C) 2001 American Megatrends, Inc. All Rights Reserved			
ACPI Standby State	:S1/POS	Resume On RTC Alarm	:Disabled
Power LED in S1 state	:Blinking	RTC Alarm Date	:15
USB Dev Wakeup From S3-S5	:Disabled	RTC Alarm Hour	:12
Suspend Time Out(Minute)	:Disabled	RTC Alarm Minute	:30
IRQ3	:Monitor	RTC Alarm Second	:30
IRQ 4	:Monitor		
IRQ 5	:Ignore		
IRQ 7	:Monitor		
IRQ 9	:Ignore		
IRQ 10	:Ignore		
IRQ 11	:Ignore		
IRQ 13	:Ignore		
IRQ 14	:Monitor		
IRQ 15	:Ignore		
Soft-off by Power Button	:Instant off		
AC Back Function	:Soft-Off	ESC: Quit	↑↓←→: Select Item
Modem Ring / Wake On Lan	:Enabled	F1 : Help	PU/PD+/-/: Modify
PME Event Wake Up	:Enabled	F5 : Old Values	(Shift)F2: Color
Keyboard Wakeup From	:S1(Suspend)	F6 : Fail-Safe	F7:Optimized
PS/2 Mouse Wakeup From	:S1(Suspend)	F8 : Q-Flash Utility	

Figure 5: Power Management Setup

☞ ACPI Standby State

- ▶▶ S1/POS SetACPI standby state is S1. (Default Value)
- ▶▶ S3/STR SetACPI standby state is S3.

☞ Power LED in S1 state

- ▶▶ Blinking In standby mode(S1), power LED will blink. (Default Value)
- ▶▶ Dual/Off In standby mode(S1):
 - a. If use single color LED, power LED will turn off.
 - b. If use dual color LED, power LED will turn to another color.

☞ **USB Dev Wakeup From S3~S5**

USB Dev Wakeup From S3~S5 can be set when ACPI standby state set to S3/STR.

- ▶▶ Enabled Enable USB Dev Wakeup From S3~S5.
- ▶▶ Disabled Disable USB Dev Wakeup From S3~S5. (Default Value).

☞ **Suspend Time Out (Minute.)**

- ▶▶ Disabled Disabled Suspend Time Out Function. (Default Value)
- ▶▶ 1 Enabled Suspend Time Out after 1min.
- ▶▶ 2 Enabled Suspend Time Out after 2min.
- ▶▶ 4 Enabled Suspend Time Out after 4min.
- ▶▶ 8 Enabled Suspend Time Out after 8min.
- ▶▶ 10 Enabled Suspend Time Out after 10min.
- ▶▶ 20 Enabled Suspend Time Out after 20min.
- ▶▶ 30 Enabled Suspend Time Out after 30min.
- ▶▶ 40 Enabled Suspend Time Out after 40min.
- ▶▶ 50 Enabled Suspend Time Out after 50min.
- ▶▶ 60 Enabled Suspend Time Out after 60min.

☞ **IRQ 3~IRQ15**

- ▶▶ Ignore Ignore IRQ3 ~IRQ15.
- ▶▶ Monitor Monitor IRQ3~IRQ15.

☞ **Soft-off by Power Button**

- ▶▶ Instant-off Soft switch ON/OFF for POWER ON/OFF. (Default Value)
- ▶▶ Suspend Soft switch ON/OFF for suspend.

☞ **AC Back Function**

- ▶▶ Soft-Off When AC-power back to the system, the system will be in "Soft-Off" state.
(Default Value)
- ▶▶ Full-On When AC-power back to the system, the system will be in "Full-On" state.
- ▶▶ Memory When AC-power back to the system, the system will return to the Last state
before AC-power off.

☞ **Modem Ring /Wake On LAN**

- ▶▶ Disabled Disabled Resume Modem Ring / Wake On LAN.
- ▶▶ Enabled Enabled Resume Modem Ring / Wake On LAN. (Default Value)

☞ **PME Event Wake Up**

- ▶▶ Disabled Disable PME Event Wake Up.
- ▶▶ Enabled Enabled PME Event Wake Up. (Default Value)

☞ **Keyboard Wakeup From**

- ▶▶ S1(Suspend) Keyboard is able to Wakeup the system from S1(Suspend) state.
(Default value)
- ▶▶ S1/S3 Keyboard is able to Wakeup the system from S1/S3 state.
- ▶▶ S1/S3/S4/S5 Keyboard is able to Wakeup the system from S1/S3/S4/S5 state.

☞ **PS/2 Wakeup From**

- ▶▶ S1(Suspend) PS/2 Mouse is able to Wakeup the system from S1(Suspend) state.
(Default value)
- ▶▶ S1/S3 PS/2 Mouse is able to Wakeup the system from S1/S3 state.
- ▶▶ S1/S3/S4/S5 PS/2 Mouse is able to Wakeup the system from S1/S3/S4/S5 state.

☞ **Resume On RTC Alarm**

You can set "RTC Alarm Power On" item to enabled and key in Data/time to power on system.

- ▶▶ Disabled Disable this function. (Default Value)
- ▶▶ Enabled Enable alarm function to POWER ON system.

If RTC Alarm Lead To Power On is Enabled.

RTC Alarm Date: Everyday, 1~31

RTC Alarm Hour:0~23

RTC Alarm Minute : 0~59

RTC Alarm Second:0~59

PNP/PCI Configuration

AMIBIOS SETUP - PNP/PCI CONFIGURATION	
(C) 2001 American Megatrends, Inc. All Rights Reserved	
OnChip VGA Frame Buffer	: 32MB
VGA Boot From	: AGP
PCI Slot 1 IRQ Priority	: Auto
PCI Slot 2 IRQ Priority	: Auto
PCI Slot 3 IRQ Priority	: Auto
Realtek LAN ROM initial	: Yes
ESC: Quit ↑↓←→: Select Item F1 : Help PU/PD/+/- : Modify F5 : Old Values (Shift)F2: Color F6 : Fail-Safe F7 : Optimized F8 : Q-Flash Utility	

Figure 6: PNP/PCI Configuration

☞ OnChip VGA Frame Buffer

- ▶▶ 8MB Set OnChip VGA Frame Buffer to 8MB.
- ▶▶ 16MB Set OnChip VGA Frame Buffer to 16MB.
- ▶▶ 32MB Set OnChip VGA Frame Buffer to 32MB. (Default Value)
- ▶▶ None Disable this function.

☞ VGA Boot From

- ▶▶ AGP Set VGA Boot from AGP VGA Card. (Default Value)
- ▶▶ PCI Set VGA Boot from PCI VGA Card.

PCISlot1, 2, 3 IRQ Priority

- ▶▶ Auto The system will reserved a free IRQ for PCI slot 1, 2, 3 device. (Default Value)
- ▶▶ 3 The system will reserved IRQ3 for PCI slot 1, 2, 3 device if no legacy ISA device using IRQ3.
- ▶▶ 4 The system will reserved IRQ4 for PCI slot 1, 2, 3 device if no legacy ISA device using IRQ4.
- ▶▶ 5 The system will reserved IRQ5 for PCI slot 1, 2, 3 device if no legacy ISA device using IRQ5.
- ▶▶ 7 The system will reserved IRQ7 for PCI slot 1, 2, 3 device if no legacy ISA device using IRQ7.
- ▶▶ 9 The system will reserved IRQ9 for PCI slot 1, 2, 3 device if no legacy ISA device using IRQ9.
- ▶▶ 10 The system will reserved IRQ10 for PCI slot 1, 2, 3 device if no legacy ISA device using IRQ10.
- ▶▶ 11 The system will reserved IRQ11 for PCI slot 1, 2, 3 device if no legacy ISA device using IRQ11.

Realtek LAN ROM initial

- ▶▶ Yes Enabled Realtek LAN ROM initial. (Default Value)
- ▶▶ No Disabled Realtek LAN ROM initial.

Load Fail-Safe Defaults

AMIBIOS SIMPLE SETUP UTILITY - VERSION 2.00 (C) 2001 American Megatrends, Inc. All Rights Reserved	
STANDARD CMOS SETUP	INTEGRATED PERIPHERALS
BIOS FEATURES SETUP	HARDWARE MONITOR & MISC SETUP
CHIPSET FEATURES SETUP	SUPERVISOR PASSWORD
POWER MANAGEMENT	
PNP / PCI CONFIGURATION	
Load Fail-Safe Defaults? (Y/N)?N	
LOAD FAIL-SAFE DEFAULTS	SAVE & EXIT SETUP
LOAD OPTIMIZED DEFAULTS	EXIT WITHOUT SAVING
ESC: Quit ↑↓←→: Select Item F5: Old Values F6: Fail-Safe Values	
F7: Optimized Values F8: Q-Flash Utility F10: Save & Exit	
Load Fail-Safe Defaults	

Figure 7: Load Fail-Safe Defaults

☞ Load Fail-Safe Defaults

Fail-Safe defaults contain the most appropriate system parameter values of to configure the system to achieve maximum stability.

Load Optimized Defaults

AMIBIOS SIMPLE SETUP UTILITY - VERSION 2.00 (C) 2001 American Megatrends, Inc. All Rights Reserved	
STANDARD CMOS SETUP	INTEGRATED PERIPHERALS
BIOS FEATURES SETUP	HARDWARE MONITOR & MISC SETUP
CHIPSET FEATURES SETUP	SUPERVISOR PASSWORD
POWER MANAGE	
PNP / PCI CONF	Load Optimized Defaults? (Y/N)?N
LOAD FAIL-SAFE DEFAULTS	SAVE & EXIT SETUP
LOAD OPTIMIZED DEFAULTS	EXIT WITHOUT SAVING
ESC: Quit ↑↓←→: Select Item F5: Old Values F6: Fail-Safe Values	
F7: Optimized Values F8: Q-Flash Utility F10: Save & Exit	
Load Optimized Defaults	

Figure 8: Load Optimized Defaults

☞ Load Optimized Defaults

Optimized defaults contain the most appropriate system parameter values to configure the system to achieve maximum performance.

☞ IDE2 Conductor Cable

- ▶▶ Auto Will be automatically detected by BIOS. (Default Value)
- ▶▶ ATA66/100 Set IDE2 Conductor Cable to ATA66/100 (Please make sure your IDE device and cable is compatible with ATA66/100).
- ▶▶ ATA33 Set IDE2 Conductor Cable to ATA33 (Please make sure your IDE device and cable is compatible with ATA33).

☞ On Board FDC

- ▶▶ Auto Set On Board FDC is Auto (Default Value).
- ▶▶ Disabled Disabled On Board FDC
- ▶▶ Enabled Enabled On Board FDC

☞ Onboard Serial Port 1

- ▶▶ Auto BIOS will automatically setup the port 1 address (Default Value).
- ▶▶ 3F8/COM1 Enable onboard Serial port 1 and address is 3F8.
- ▶▶ 2F8/COM2 Enable onboard Serial port 1 and address is 2F8.
- ▶▶ 3E8/COM3 Enable onboard Serial port 1 and address is 3E8.
- ▶▶ 2E8/COM4 Enable onboard Serial port 1 and address is 2E8.
- ▶▶ Disabled Disable onboard Serial port 1.

☞ Onboard Serial Port 2

- ▶▶ Auto BIOS will automatically setup the port 2 address (Default Value).
- ▶▶ 3F8/COM1 Enable onboard Serial port 2 and address is 3F8.
- ▶▶ 2F8/COM2 Enable onboard Serial port 2 and address is 2F8.
- ▶▶ 3E8/COM3 Enable onboard Serial port 2 and address is 3E8.
- ▶▶ 2E8/COM4 Enable onboard Serial port 2 and address is 2E8.
- ▶▶ Disabled Disable onboard Serial port 2.

☞ Serial Port 2 Mode

- ▶▶ Normal Normal operation. (Default Value)
- ▶▶ IrDA Onboard I/O chip supports IrDA.
- ▶▶ ASKIR Onboard I/O chip supports ASKIR.

☞ OnBoard Parallel port

- ▶▶ 378 Enable On Board LPT port and address is 378.
- ▶▶ 278 Enable On Board LPT port and address is 278.
- ▶▶ 3BC Enable On Board LPT port and address is 3BC.
- ▶▶ Auto Set On Board LPT port is Auto. (Default Value)
- ▶▶ Disabled Disable On Board LPT port.

☞ Parallel Port Mode

- ▶▶ EPP Using Parallel port as Enhanced Parallel Port.
- ▶▶ ECP Using Parallel port as Extended Capabilities Port. (Default Value)
- ▶▶ Normal Normal Operation.
- ▶▶ EPP+ECP Using Parallel port as Enhanced Parallel Port & Extended Capabilities Port.

☞ Parallel Port IRQ

- ▶▶ 7 Set Parallel Port IRQ is 7.
- ▶▶ Auto Set Auto to parallel Port IRQ DMA Channel. (Default Value)
- ▶▶ 5 Set Parallel Port IRQ is 5.

☞ Parallel Port DMA

- ▶▶ 3 Set Parallel Port DMA is 3.
- ▶▶ Auto Set Auto to parallel port mode DMA Channel. (Default Value)
- ▶▶ 1 Set Parallel Port DMA is 1.
- ▶▶ 0 Set Parallel Port DMA is 0.

☞ OnBoard MIDI Port

- ▶▶ 300 Set 300 for MIDI Port. (Default Value)
- ▶▶ 310 Set 310 for MIDI Port .
- ▶▶ 320 Set 320 for MIDI Port.
- ▶▶ 330 Set 330 for MIDI Port.
- ▶▶ Disabled Disabled this function.

⇨ Midi Port IRQ

- ▶▶ 5 Set Midi Port IRQ to 5. (Default Value)
- ▶▶ 10 Set Midi Port IRQ to 10.
- ▶▶ 11 Set Midi Port IRQ to 11.

⇨ OnBoard Game Port

- ▶▶ 201 Set 201 for Game Port.(Default Value)
- ▶▶ 209 Set 209 for Game Port.
- ▶▶ Disabled Disabled this function.

⇨ OnBoard AC97 Audio

- ▶▶ Auto Enable auto detect onboard AC'97 audio. (Default v alue)
- ▶▶ Disabled Disable this function.

⇨ Onboard Lan Chip *

- ▶▶ Disabled Disable this function.
- ▶▶ Enabled Enable Onboard Lan Chip function. (Default Value)

" * " Not Supported 7VKML-DL (PCB VER:3.4)

Hardware Monitor & MISC Setup

AMIBIOS SETUP - HARDWARE MONITOR & MISC SETUP	
(C) 2001 American Megatrends, Inc. All Rights Reserved	
Thermal Shut Down Temp.	:110°C/230°F
Reset Case Open Status	: No
Case Status	: Open
CPU Host Clock (Mhz)	: 100
CPU Temp.	: 35°C/ 95°F
System Temp.	: 33°C/ 91°F
CPU Fan Speed	: 5273 RPM
System Fan Speed	: 0 RPM
Vcore	: +1.632V
Vtt	: +3.344V
+3.300V	: +3.296V
+5.000V	: +5.080V
+12.000V	: +11.840V
5V SB	: +4.972V
ESC: Quit ↑↓←→: Select Item F1 : Help PU/PD+/-: Modify F5 : Old Values (Shift)F2: Color F6 : Fail-Safe F7:Optimized F8 : Q-Flash Utility	

Figure 10: Hardware Monitor & MISC Setup

☞ Thermal Shut Down Temp.

- ☞ Disabled Disabled this function.
- ☞ 80°C/176°F Set Thermal Shut Down Temperature is 80°C/176°F.
- ☞ 85°C/185°F Set Thermal Shut Down Temperature is 85°C/185°F.
- ☞ 90°C/194°F Set Thermal Shut Down Temperature is 90°C/194°F.
- ☞ 95°C/203°F Set Thermal Shut Down Temperature is 95°C/203°F.
- ☞ 100°C/212°F Set Thermal Shut Down Temperature is 100°C/212°F.
- ☞ 105°C/221°F Set Thermal Shut Down Temperature is 105°C/221°F.
- ☞ 110°C/230°F Set Thermal Shut Down Temperature is 110°C/230°F.(Default Value)

☞ **Reset Case Open Status**

☞ **Case Status**

If the case is closed, "Case Opened" will show "No".

If the case have been opened, "Case Opened" will show "Yes".

If you want to reset "Case Opened" value, set "Reset Case Open Status" to "Enabled" and save CMOS, your computer will restart.

☞ **CPU Host Clock (Mhz)**

- ▶▶ By Hw Set CPU Host Clock by Hw. (Default Value)
- ▶▶ 133 Set CPU Host Clock to 133MHz~161MHz.
- ▶▶ 100 Set CPU Host Clock to 100Mhz~128MHz.

☞ **CPU / System Temp.**

- ▶▶ Detect CPU / System Temperature automatically.

☞ **CPU / System FAN Speed**

- ▶▶ Detect CPU / System Fan speed status automatically .

☞ **Current Voltage (V) V_{CORE} / V_{tt} / +3.3V / +12V / +5V / 5VSB**

- ▶▶ Detect system's voltage status automatically.

Set Supervisor / User Password

When you select this function, the following message will appear at the center of the screen to assist you in creating a password.

AMBIOS SIMPLE SETUP UTILITY - VERSION 2.00 (C) 2001 American Megatrends, Inc. All Rights Reserved	
STANDARD CMOS SETUP	INTEGRATED PERIPHERALS
BIOS FEATURES SETUP	HARDWARE MONITOR & MISC SETUP
CHIPSET FEATURES SETUP	SUPERVISOR PASSWORD
POWER MANAGEMENT SETUP	USER PASSWORD
PNP / PCI CONFIGURATION	Enter new supervisor password:
LOAD FAIL-SAFE DEFAULTS	SAVE & EXIT SETUP
LOAD OPTIMIZED DEFAULTS	EXIT WITHOUT SAVING
ESC: Quit	↑↓←→: Select Item
F5: Old Values	F6: Fail-Safe Values
F7: Optimized Values	F8: Q-Flash Utility
	F10: Save & Exit
Change / Set / Disable Password	

Figure 11: Password Setting

Type the password, up to six characters, and press <Enter>. You will be asked to confirm the password. Type the password again and press <Enter>. You may also press <Esc> to abort the selection and not enter a password.

To disable password, just press <Enter> when you are prompted to enter password. A message "PASSWORD DISABLED" will appear to confirm the password being disabled. Once the password is disabled, the system will boot and you can enter Setup freely.

The BIOS Setup program allows you to specify two separate passwords: a SUPERVISOR PASSWORD and a USER PASSWORD. When disabled, anyone may access all BIOS Setup program function. When enabled, the Supervisor password is required for entering the BIOS Setup program and having full configuration fields, the User password is required to access only basic items.

If you select "Always" at "Password Check" in BIOS Features Setup Menu, you will be prompted for the password every time the system is rebooted or any time you try to enter Setup Menu.

If you select "Setup" at "Password Check" in BIOS Features Setup Menu, you will be prompted only when you try to enter Setup.

IDE HDD Auto Detection

AMBIOS SETUP - STANDARD CMOS SETUP																																									
(C) 2001 American Megatrends, Inc. All Rights Reserved																																									
System Date : Jan 08 2002 Tue																																									
System Time : 14:44:35																																									
<table border="1"> <thead> <tr> <th>TYPE</th> <th>SIZE</th> <th>CYLS</th> <th>HEAD</th> <th>PRECOMP</th> <th>LANDZ</th> <th>SECTOR</th> <th>MODE</th> </tr> </thead> <tbody> <tr> <td>Pri Master</td> <td>: Auto</td> <td></td> <td></td> <td></td> <td></td> <td></td> <td></td> </tr> <tr> <td>Pri Slave</td> <td>: Auto</td> <td></td> <td></td> <td></td> <td></td> <td></td> <td></td> </tr> <tr> <td>Sec Master</td> <td>: Auto</td> <td></td> <td></td> <td></td> <td></td> <td></td> <td></td> </tr> <tr> <td>Sec Slave</td> <td>: Auto</td> <td></td> <td></td> <td></td> <td></td> <td></td> <td></td> </tr> </tbody> </table>		TYPE	SIZE	CYLS	HEAD	PRECOMP	LANDZ	SECTOR	MODE	Pri Master	: Auto							Pri Slave	: Auto							Sec Master	: Auto							Sec Slave	: Auto						
TYPE	SIZE	CYLS	HEAD	PRECOMP	LANDZ	SECTOR	MODE																																		
Pri Master	: Auto																																								
Pri Slave	: Auto																																								
Sec Master	: Auto																																								
Sec Slave	: Auto																																								
Floppy Drive A : 1.44 MB 3 ^{1/2}	Base Memory : 640 Kb																																								
Floppy Drive B : Not Installed	Other Memory : 384 Kb																																								
	Extended Memory : 95 Mb																																								
Virus Protection : Disabled	Total Memory : 96 Mb																																								
Date is standard format	ESC : Exit																																								
Month : Jan - Dec	↑↓ : Select Item																																								
Day : 01- 31	PU / PD / + / - :Modify																																								
Year : 1990 - 2099	(Shift) F2 : Color																																								

Figure 12: IDE HDD Auto Detection

Type "Y" will accept the H.D.D. parameter reported by BIOS.

Type "N" will keep the old H.D.D. parameter setup. If the hard disk cylinder number is over 1024, then the user can select LBA mode or LARGER mode for DOS partition larger than 528 MB.

Save & Exit Setup

AMIBIOS SIMPLE SETUP UTILITY - VERSION 2.00 (C) 2001 American Megatrends, Inc. All Rights Reserved	
STANDARD CMOS SETUP	INTEGRATED PERIPHERALS
BIOS FEATURES SETUP	HARDWARE MONITOR & MISC SETUP
CHIPSET FEATURES SETUP	SUPERVISOR PASSWORD
POWER MANAGEMENT SETUP	USER PASSWORD
PNP / PCI CONFIGURATION	SAVE & EXIT SETUP
LOAD FAIL-SAFE DEFAULTS	EXIT WITHOUT SAVING
LOAD OPTIMIZED DEFAULTS	
ESC: Quit ↑↓←→: Select Item F5: Old Values F6: Fail-Safe Values	
F7: Optimized Values F8: Q-Flash Utility F10: Save & Exit	
Save Data to CMOS & Exit SETUP	

Figure 13: Save & Exit Setup

Type "Y" will quit the Setup Utility and save the user setup value to RTC CMOS.

Type "N" will return to Setup Utility.

Exit Without Saving

AMBIOS SIMPLE SETUP UTILITY - VERSION 2.00 (C) 2001 American Megatrends, Inc. All Rights Reserved	
STANDARD CMOS SETUP	INTEGRATED PERIPHERALS
BIOS FEATURES SETUP	HARDWARE MONITOR & MISC SETUP
CHIPSET FEATURES SETUP	SUPERVISOR PASSWORD
POWER MANAGE	
PNP / PCI CONF	Quit Without Saving (Y/N)? N
LOAD FAIL-SAFE DEFAULTS	SAVE & EXIT SETUP
LOAD OPTIMIZED DEFAULTS	EXIT WITHOUT SAVING
ESC: Quit	↑↓←→: Select Item
F5: Old Values	F6: Fail-Safe Values
F7: Optimized Values	F8: Q-Flash Utility
	F10: Save & Exit
Abandon all Datas & Exit SETUP	

Figure 14: Exit Without Saving

Type "Y" will quit the Setup Utility without saving to RTC CMOS.

Type "N" will return to Setup Utility.

Chapter 4 Technical Reference

Block Diagram

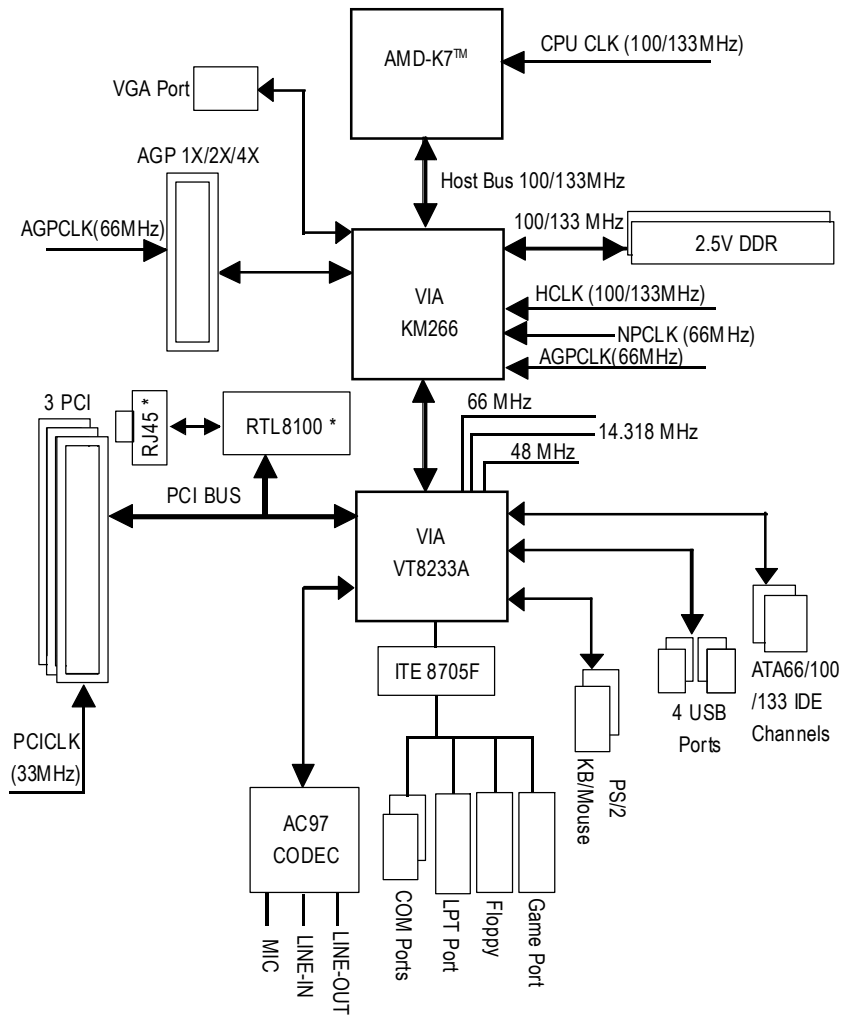

*** Not Supported 7VKML-DL (PCB VER:3.4)

@ BIOS™ Introduction

Gigabyte announces @ BIOS Windows BIOS live update utility



Have you ever updated BIOS by yourself? Or like many other people, you just know what BIOS is, but always hesitate to update it? Because you think updating newest BIOS is unnecessary and actually you don't know how to update it.

Maybe not like others, you are very experienced in BIOS updating and spend quite a lot of time to do it. But of course you don't like to do it too much. First, download different BIOS from website and then switch the operating system to DOS mode. Secondly, use different flash utility to update BIOS. The above process is not a interesting job. Besides, always be carefully to store the BIOS source code correctly in your disks as if you update the wrong BIOS, it will be a nightmare.

Certainly, you wonder why motherboard vendors could not just do something right to save your time and effort and save you from the lousy BIOS updating work? Here it comes! Now Gigabyte announces @BIOS—the first Windows BIOS live update utility. This is a smart BIOS update software. It could help you to download the BIOS from internet and update it. Not like the other BIOS update software, it's a Windows utility. With the help of '@BIOS', BIOS updating is no more than a click.

Besides, no matter which mainboard you are using, if it's a Gigabyte's product*, @BIOS help you to maintain the BIOS. This utility could detect your correct mainboard model and help you to choose the BIOS accordingly. It then downloads the BIOS from the nearest Gigabyte ftp site automatically. There are several different choices; you could use "Internet Update" to download and update your BIOS directly. Or you may want to keep a backup for your current BIOS, just choose "Save Current BIOS" to save it first. You make a wise choice to use Gigabyte, and @BIOS update your BIOS smartly. You are now worry free from updating wrong BIOS, and capable to maintain and manage your BIOS easily. Again, Gigabyte's innovative product erects a milestone in mainboard industries.

For such a wonderful software, how much it costs? Impossible! It's free! Now, if you buy a Gigabyte's motherboard, you could find this amazing software in the attached driver CD. But please remember, connected to internet at first, then you could have a internet BIOS update from your Gigabyte @BIOS.

Easy Tune™ 4 Introduction

Gigabyte announces *EasyTune™ 4*

Windows based Overclocking utility

EasyTune 4 carries on the heritage so as to pave the way for future generations.



"Overclock" might be one of the most common issues in computer field. But have many users ever tried it? The answer is probably "no". Because "Overclock" is thought to be very difficult and includes a lot of technical know-how, sometimes "Overclock" is even considered as special skills found only in some enthusiasts. But as to the experts in "Overclock", what's the truth? They may spend quite a lot of time and money to study, try and use many different hard-

ware or BIOS tools to do "Overclock". And even with these technologies, they still learn that it's quite a risk because the safety and stability of an "Overclock" system is unknown. Now everything is different because of a Windows based overclocking utility "EasyTune 4" --announced by Gigabyte. This windows based utility has totally changed the gaming rule of "Overclock". This is the first windows based overclocking utility is suitable for both normal and power users. Users can choose either "Easy Mode" or "Advanced Mode" for overclocking at their convenience. For users who choose "Easy Mode", they just need to click "Auto Optimize" to have autoed and immediate CPU overclocking. This software will then overdrive CPU speed automatically with the result being shown in the control panel. If users prefer "Overclock" by them, there is also another choice. Click "Advanced Mode" to enjoy "sport drive" class Overclocking user interface. "Advanced Mode", allows users to change the system bus / AGP / Memory working frequency in small increments to get ultimate system performance. It operates in coordination with Gigabyte motherboards. Besides, it is different from other traditional over-clocking methods, EasyTune 4 doesn't require users to change neither BIOS nor hardware switch/jumper setting; on the other hand, they can do "Overclock" at easy step. Therefore, this is a safer way for "Overclock" as nothing is changed on software or hardware. If user runs EasyTune 4 over system's limitation, the biggest loss is only to restart the computer again and the side effect is then well controlled. Moreover, if one well-performed system speed has been tested in EasyTune 4, user can "Save" this setting and "Load" it in next time. Obviously, Gigabyte EasyTune 4 has already turned the "Overclock" technology toward to a newer generation. This wonderful software is now free bundled in Gigabyte motherboard attached in driver CD. Users may make a test drive of "EasyTune 4" to find out more amazing features by themselves.

*Some Gigabyte products are not fully supported by EasyTune 4. Please find the products supported list in the web site.

*Any "Overclocking action" is at user's risk, Gigabyte Technology will not be responsible for any damage or instability to your processor, motherboard, or any other components.

Q-Flash Utility Introduction

A. What is Q-Flash Utility?

Q-Flash utility is a pre-O.S. BIOS flash utility enables users to update its BIOS within BIOS mode, no more fooling around any OS.

B. How to use Q-Flash?

a. After power on the computer, pressing immediately during POST (Power On Self Test) it will allow you to enter AMI BIOS CMOS SETUP, then press <F8> to enter Flash utility.

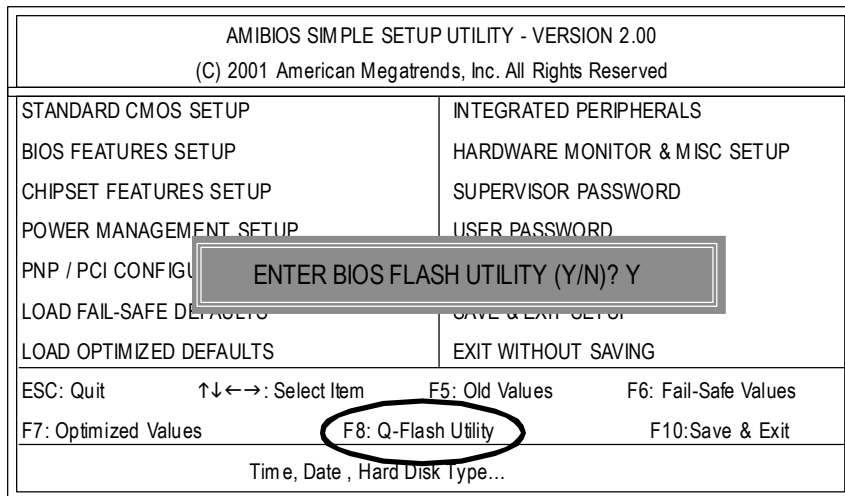

b. Q-Flash Utility

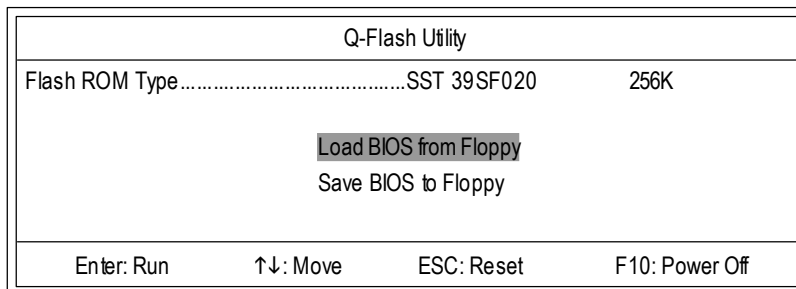

Load BIOS From Floppy

 In the A:drive, insert the "BIOS" diskette, then Press Enter to Run.

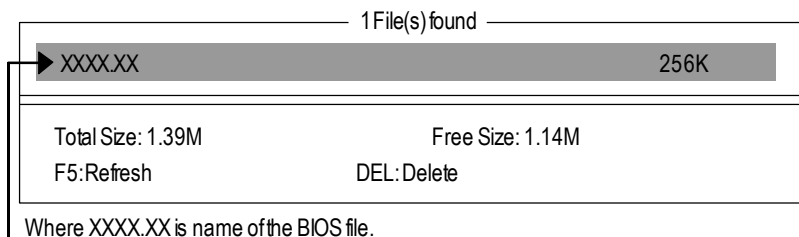

 Press Enter to Run.

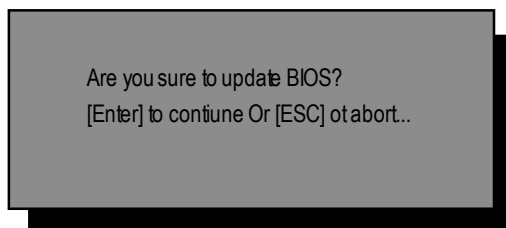

 Press Enter to Run.

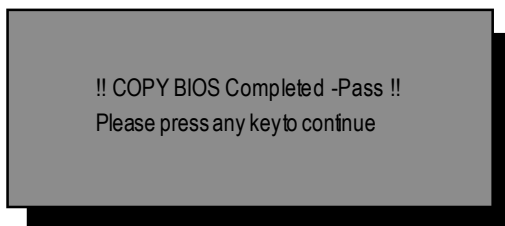

Congratulation! You have completed the flashed and now can restartsystem.

- (2) Select the "Quick (erase)" for FormatType, and pick both "Displaysummary when finished" and "Copy system files", after that press "Start". That will format the floppy and transfer the needed system files to it.

Beware: This procedure will erase all the prior data on that floppy, so please proceed accordingly.

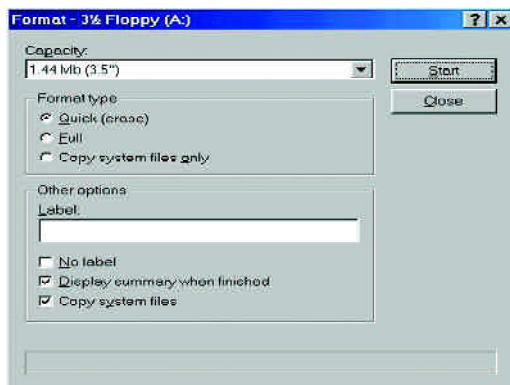

- (3) After the floppy has been formatted completely, please press "Close".

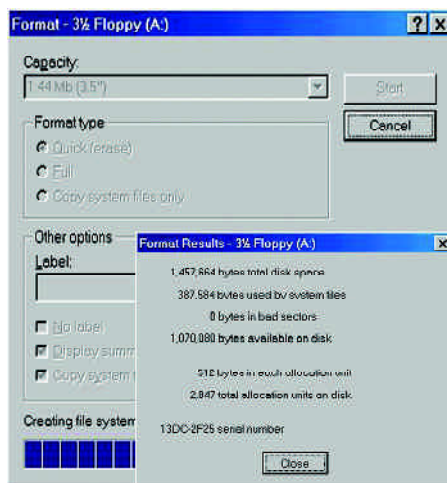

STEP 3: Download BIOS and BIOS utility program.

(1) Please go to Gigabyte website <http://www.gigabyte.com.tw/index.html>, and click "Support".



(2) From Supportzone, click the "Motherboards BIOS & Drivers".

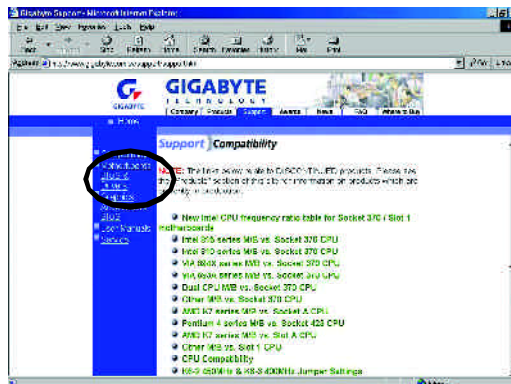

- (5) At this time the screen shows the following picture, please click "Extract" button to unzip the files.

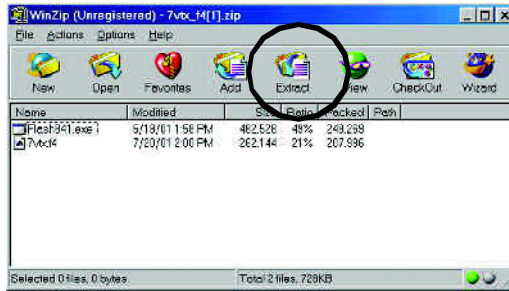

- (6) Please extract the download files into the clean bootable floppy disk A mentioned in STEP 2, and press "Extract".

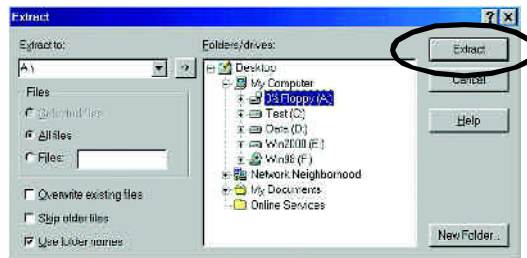

STEP 4: Make sure the system will boot from the floppy disk.

- (1) Insert the floppy disk (contains bootable program and unzip file) into the floppy drive A. Then, restart the system. The system will boot from the floppy disk. Please press key to enter BIOS setup main menu when system is bootup.

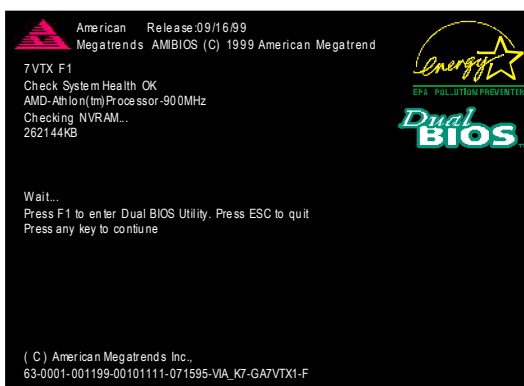

- (2) Once you enter the BIOS setup utility, the main menu will appear on the screen. Use the arrows to highlight the item "BIOS FEATURES SETUP".

AMBIOS SIMPLE SETUP UTILITY - VERSION 1.24b (C) 1999 American Megatrends, Inc. All Rights Reserved	
STANDARD CMOS SETUP	INTEGRATED PERIPHERALS
BIOS FEATURES SETUP	HARDWARE MONITOR & MISC SETUP
CHIPSET FEATURES SETUP	SUPERVISOR PASSWORD
POWER MANAGEMENT SETUP	USER PASSWORD
PNP / PCI CONFIGURATION	IDE HDD AUTO DETECTION
LOAD BIOS DEFAULTS	SAVE & EXIT SETUP
LOAD SETUP DEFAULTS	EXIT WITHOUT SAVING
ESC: Quit ↑↓←→ : Select Item (Shift)F2 : Change Color F5: Old Values	
F6: Load BIOS Defaults F7: Load Setup Defaults F10: Save & Exit	
Time, Date, Hard Disk Type...	

- (3) Press "Enter" to enter "BIOS FEATURES SETUP" menu. Use the arrows to highlight the item "1st Boot Device", and then use the "Page Up" or "Page Down" keys to select "Floppy".

AMIBIOS SETUP - BIOS FEATURES SETUP	
(C) 2001 American Megatrends, Inc. All Rights Reserved	
1st Boot Device : Floppy	
2nd Boot Device : IDE-0	
3rd Boot Device : CDROM	
S.M.A.R.T. for Hard Disks : Disabled	
BootUp Num-Lock : On	ESC: Quit ↑↓←→: Select Item
Floppy Drive Seek : Disabled	F1 : Help PU/PD/+/- : Modify
Password Check : Setup	F5 : Old Values (Shift) F2: Color
	F6 : Load BIOS Defaults
	F7 : Load Setup Defaults

- (4) Press "ESC" to go back to previous screen. Use the arrows to highlight the item "SAVE & EXIT SETUP" then press "Enter". System will ask "SAVE to CMOS and EXIT (Y/N)?" Press "Y" and "Enter" keys to confirm. Now the system will reboot automatically, the new BIOS setting will be taken effect next boot-up.

AMIBIOS SIMPLE SETUP UTILITY - VERSION 1.24b	
(C) 2001 American Megatrends, Inc. All Rights Reserved	
STANDARD CMOS SETUP	INTEGRATED PERIPHERALS
BIOS FEATURES SETUP	HARDWARE MONITOR & MISC SETUP
CHIPSET FEATURES SETUP	SUPERVISOR PASSWORD
POWER MANAGEMENT SETUP	USER PASSWORD
PNP / PCI CONF	SAVE & EXIT SETUP
LOAD BIOS DEFAULTS	EXIT WITHOUT SAVING
LOAD SETUP DEFAULTS	
ESC: Quit ↑↓←→ : Select Item (Shift)F2: Change Color F5: Old Values	
F6: Load BIOS Defaults F7: Load Setup Defaults F10: Save & Exit	
Save Data to CMOS & Exit SETUP	

STEP 5: BIOS flashing.

- (1) After the system boot from floppy disk, type "A:\> dir/w" and press "Enter" to check the entire files in floppy A. Then type the "BIOS flash utility" and "BIOS file" after A:\>. In this case you have to type "A:\> Flash841 7VTX.F4" and then press "Enter".

```
Starting Windows 98...

Microsoft(R) Windows98
©Copyright Microsoft Corp 1981-1999

A:\> dir/w
Volume in drive A has no label
Volume Serial Number is 16EB-353D
Directory of A:\
COMMAND.COM    7VTX.F4    FLASH841.EXE
                3 file(s)   838,954 bytes
                0 dir(s)   324,608 bytes free

A:\> Flash841 7VTX.F4
```

- (2) Now screen appears the following Flash Utility main menu. Press "Enter", the highlighted item will locate on the model name of the right-upper screen. Right after that, press "Enter" to start BIOS Flash Utility.

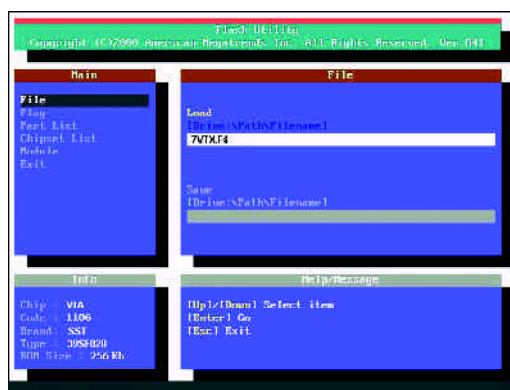

- (3) It will pop up a screen and asks "Are you sure to flash the BIOS?" Press [Enter] to continue the procedure, or press [ESC] to quit.

Beware: Please do not turn off the system while you are upgrading BIOS. It will render your BIOS corrupted and system totally inoperative.

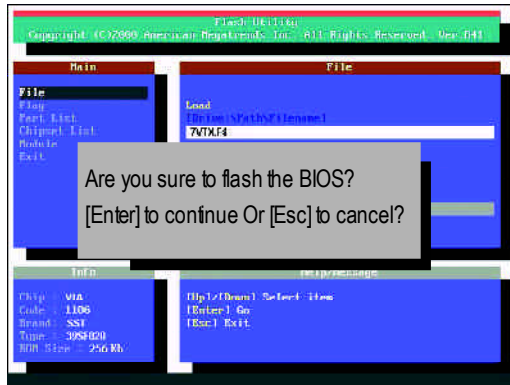

- (4) The BIOS flash completed. Please press [ESC] to exit Flash Utility.

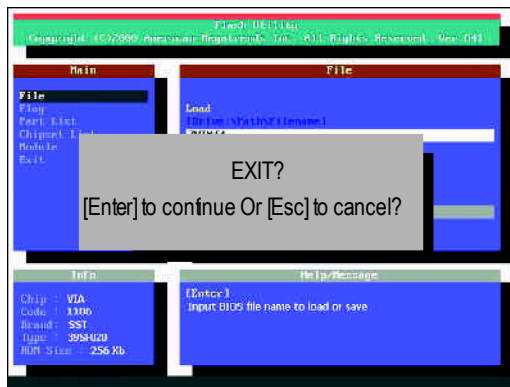

STEP 6: Load BIOS defaults.

Normally the system re-detects all devices after BIOS has been upgraded. Therefore, we highly recommend reloading the BIOS defaults after BIOS has been upgraded. This important step resets everything after the flash.

- (1) Take out the floppy diskette from floppy drive, and then restart the system. The bootup screen will indicate your motherboard model and current BIOS version.

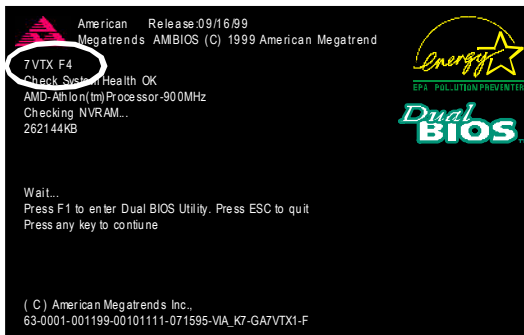

- (2) Don't forget to press key to enter BIOS setup again when system is bootup. Use the arrows to highlight the item "LOAD SETUP DEFAULTS" then press "Enter". System will ask "Load Setup Defaults (Y/N)?" Press "Y" and "Enter" keys to confirm.

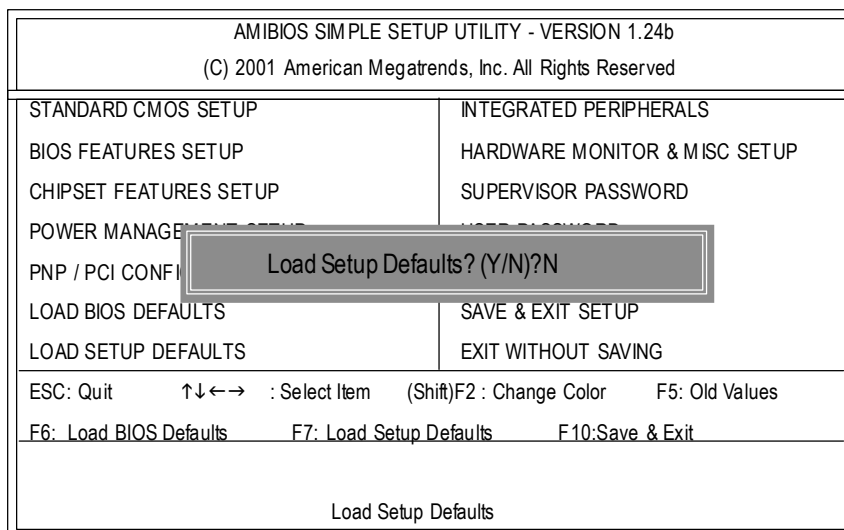

- (3) Use the arrows to highlight the item "SAVE & EXIT SETUP" and press "Enter". System will ask "SAVE to CMOS and EXIT (Y/N)?" Press "Y" and "Enter" keys to confirm. Now the system will reboot automatically, the new BIOS setting will be taken effect next boot-up.

AMIBIOS SIMPLE SETUP UTILITY - VERSION 1.24b (C) 2001 American Megatrends, Inc. All Rights Reserved	
STANDARD CMOS SETUP	INTEGRATED PERIPHERALS
BIOS FEATURES SETUP	HARDWARE MONITOR & MISC SETUP
CHIPSET FEATURES SETUP	SUPERVISOR PASSWORD
POWER MANAGEMENT SETUP	USER PASSWORD
PNP / PCI CONF	SAVE & EXIT SETUP
LOAD BIOS DEFAULTS	EXIT WITHOUT SAVING
LOAD SETUP DEFAULTS	
ESC: Quit ↑↓←→ : Select Item (Shift)F2 : Change Color F5: Old Values	
F6: Load BIOS Defaults F7: Load Setup Defaults F10: Save & Exit	
Save Data to CMOS & Exit SETUP	

- (4) Congratulate you have accomplished the BIOS flash procedure.

BIOS update procedure:

If your OS is Win9X, we recommend that you used Gigabyte @BIOS™ Program to flash BIOS.



(1)



(2)

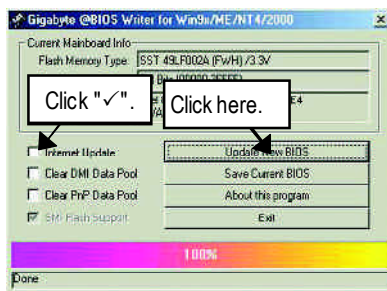

(3)

Methods and steps:

- I. Update BIOS through Internet
 - a. Click "Internet Update" icon
 - b. Click "Update New BIOS" icon
 - c. Select @BIOS™ sever ("Gigabyte @BIOS™ sever 1 in Taiwan" and "Gigabyte @BIOS™ sever 2 in Taiwan" are available for now, the others will be completed soon)
 - d. Select the exact model name on your motherboard
 - e. System will automatically download and update the BIOS.

II. Update BIOS NOT through Internet:

- a. Do not click "Internet Update" icon
- b. Click "Update New BIOS"
- c. Please select "All Files" in dialog box while opening the old file.
- d. Please search for BIOS unzip file, downloading from internet or any other methods (such as: 7VKML.F9a).
- e. Complete update process following the instruction.

III. Save BIOS

In the very beginning, there is "Save Current BIOS" icon shown in dialog box. It means to save the current BIOS version.

IV. Check out supported motherboard and Flash ROM:

In the very beginning, there is "About this program" icon shown in dialog box. It can help you check out which kind of motherboard and which brand of Flash ROM are supported.

Note:

- a. In method I, if it shows two or more motherboard's model names to be selected, please make sure your motherboard's model name again. Selecting wrong model name will cause the system unbooted.
- b. In method II, be sure that motherboard's model name in BIOS unzip file are the same as your motherboard's. Otherwise, your system won't boot.
- c. In method I, if the BIOS file you need cannot be found in @BIOS™ server, please go onto Gigabyte's web site for downloading and updating it according to method II.
- d. Please note that any interruption during updating will cause system unbooted.

2-/4-/6-Channel Audio Function Introduction

The installation of windows 98SE/2K/ME/XP is very simple. Please follow next step to install the function!

Stereo Speakers Connection and Settings:

We recommend that you use the speaker with amplifier to acquire the best sound effect if the stereo output is applied.

STEP 1:

Connect the stereo speakers or earphone to "Line Out".

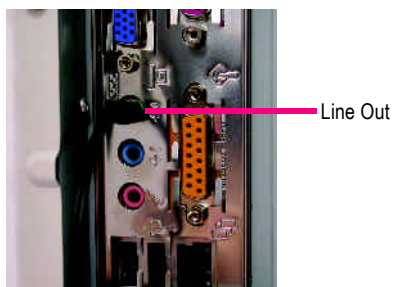

STEP 2 :

After installation of the audio driver, you'll find  icon on the taskbar's status area. Click the audio icon "Sound Effect" from the windows tray at the bottom of the screen.

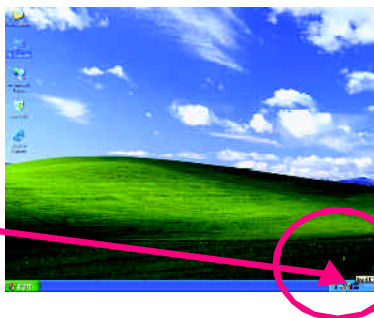
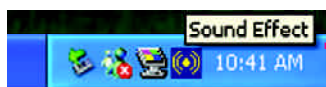

STEP 3:

Select "Speaker Configuration", and choose the "2 channels for stereo speakers output".



4 Channel Analog Audio Output Mode

STEP 1 :

Connect the front channels to "Line Out",
the rear channels to "Line In".

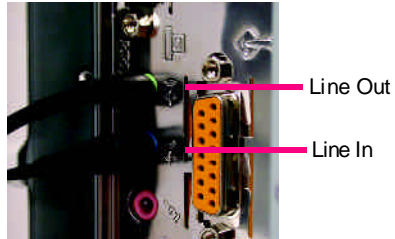

STEP 2 :

After installation of the audio driver, you'll find  icon on the taskbar's status area. Click the audio icon "Sound Effect" from the windows tray at the bottom of the screen.

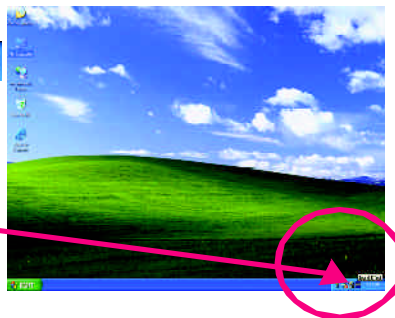

STEP 3 :

Select "Speaker Configuration", and choose the "4 channels for 4 speakers output".
Disable "Only SURROUND-KIT", and press "OK".

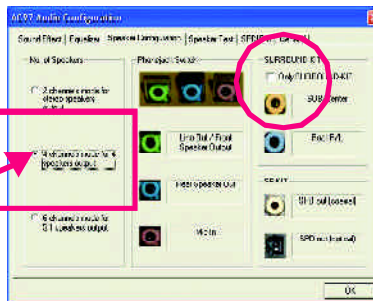

When the "Environment settings" is "None", the sound would be performed as stereo mode (2 channels output). Please select the other settings for 4 channels output.

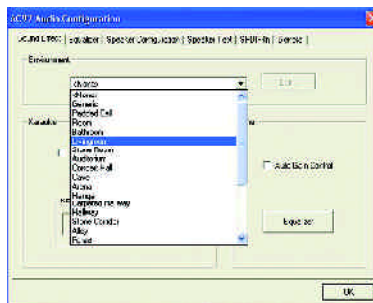

4 Channel Analog Audio Output Mode

STEP 1 :

Connect the front channels to "Line Out", the rear channels to "Line In".

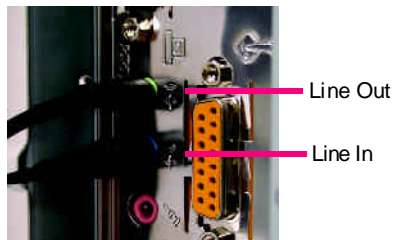

STEP 2 :

After installation of the audio driver, you 'll find  icon on the taskbar's status area. Click the audio icon "Sound Effect" from the windows tray at the bottom of the screen.

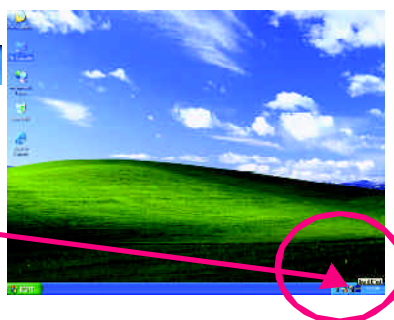

STEP 3 :

Select "Speaker Configuration", and choose the "4 channels for 4 speakers output". Disable "Only SURROUND-KIT", and press "OK".

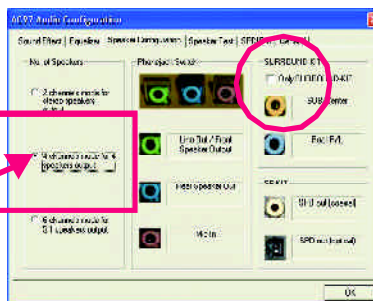

When the "Environment settings" is "None", the sound would be performed as stereo mode (2 channels output). Please select the other settings for 4 channels output.

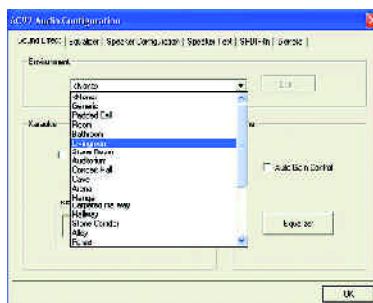

Advanced 6 Channel Analog Audio Output Mode (using Audio Combo Kit, Optional Device):

(Audio Combo Kit provides SPDIF output port : optical & coaxial and SURROUND-KIT : Rear R/L & Center/subwoofer)

SURROUND-KIT access analog output to rear channels and Center/Subwoofer channels. It is the best solution if you need 6 channel output, Line In and MIC at the same time. "SURROUND-KIT" is included in the GIGABYTE unique "Audio Combo Kit" as picture.



STEP 1 :

Insert the "Audio Combo Kit" in the back of the case ,and fix it with the screw.



STEP 2 :

Connect the "SURROUND-KIT" to SUR_CEN on the M/B.

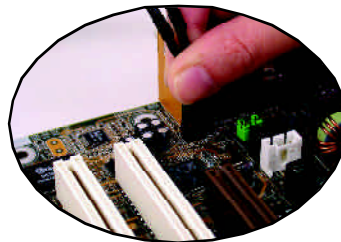
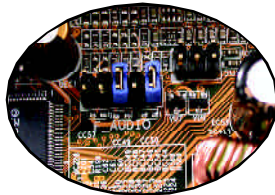

STEP 3 :

Connect the front channels to back audio panel's "Line Out", the rear channels to SURROUND-KIT's REAR R/L, and the Center/Subwoofer channels to SURROUND-KIT's SUB CENTER.

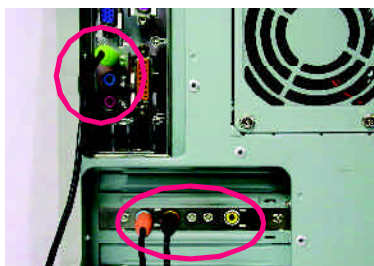

STEP 4 :

Click the audio icon "Sound Effect" from the windows tray at the bottom of the screen.

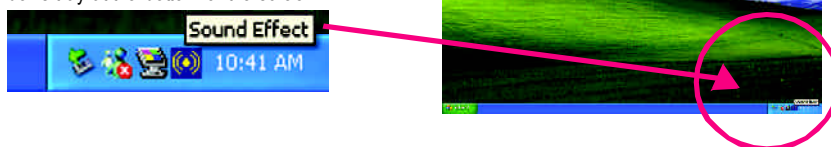

STEP 5 :

Select "Speaker Configuration", and choose the "6 channels for 5.1 speakers output". Enable "Only SURROUND-KIT" and press "OK".

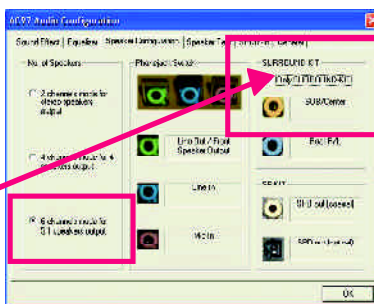

Basic & Advanced 6 Channel Analog Audio Output ModeNotes:

When the "Environment settings" is "None", the sound would be performed as stereo mode(2 channels output). Please select the other settings for 6 channels output.

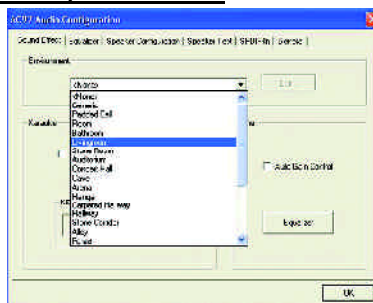

SPDIF Output Device (Optional Device)

A “SPDIF output” device is available on the motherboard. Cable with rear bracket is provided and could link to the “SPDIF output” connector (As picture.) For the further linkage to decoder, rear bracket provides coaxial cable and Fiber connecting port.

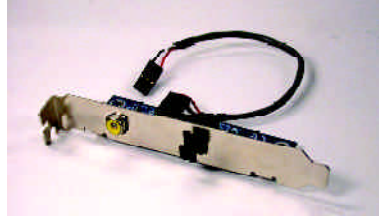

1. Connect the SPDIF output device to the rear bracket of PC, and fix it with screw.

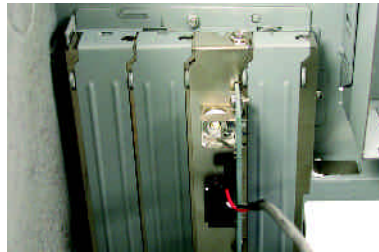

2. Connect SPDIF wire to the motherboard.

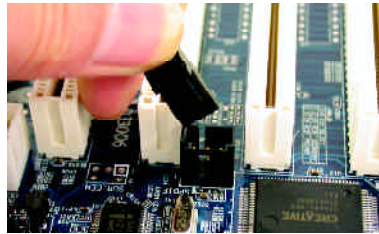

3. Connect co-axial or optical output to the SPDIF decoder.



Chapter 5 Appendix

Picture below are shown in Windows XP (VUCD driver version 2.1)

Appendix A: KM266 Chipset Drivers Installation

A. VIA 4 in 1 Service Pack Driver Utility:

Insert the driver CD-title that came with your motherboard into your CD-ROM driver, the driver CD-title will auto start and show the installation guide. If not, please double click the CD-ROM device icon in "My computer", and execute the setup.exe.



(1)

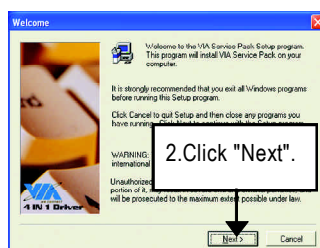

(2)

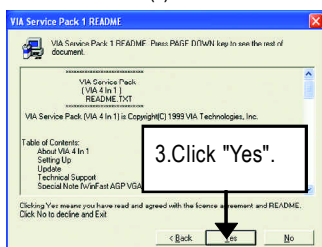

(3)

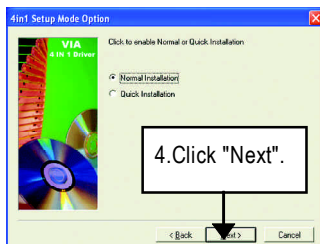

(4)

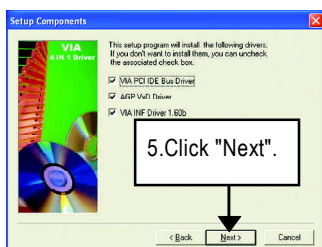

(5)

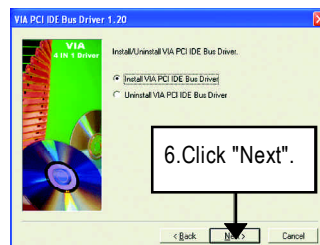

(6)

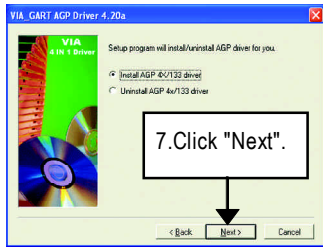

(7)

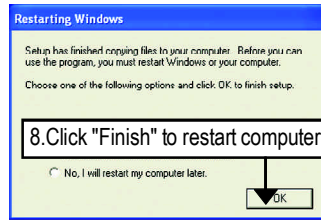

(8)

B. KM266 VGA Driver:

Insert the driver CD-title that came with your motherboard into your CD-ROM driver, the driver CD-title will auto start and show the installation guide. If not, please double click the CD-ROM device icon in "My computer", and execute the setup.exe.



(1)

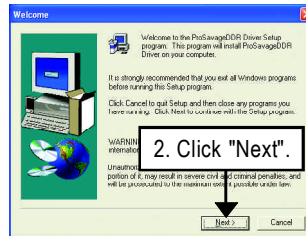

(2)

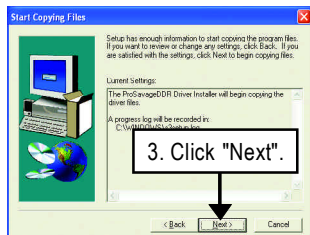

(3)

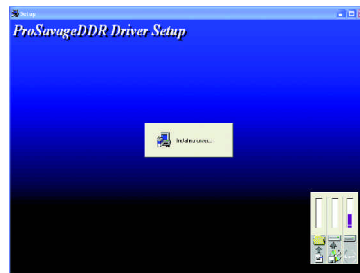

(4)

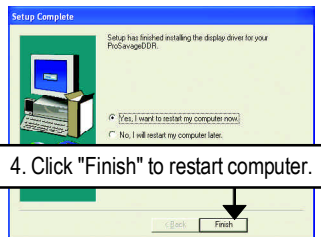

(5)

Appendix B: RealTek AC'97 Audio Driver

Insert the driver CD-title that came with your motherboard into your CD-ROM driver, the driver CD-title will auto start and show the installation guide. If not, please double click the CD-ROM device icon in "My computer", and execute the setup.exe.

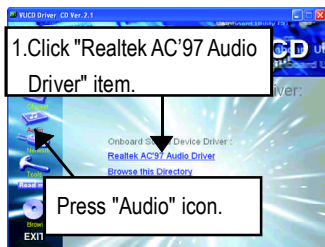

(1)

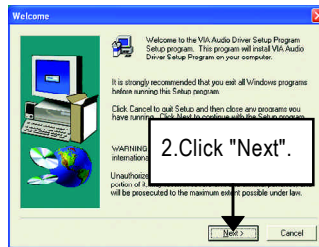

(2)

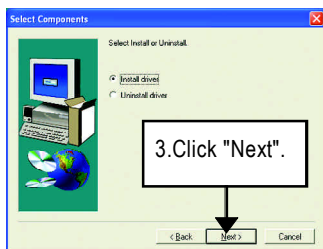

(3)

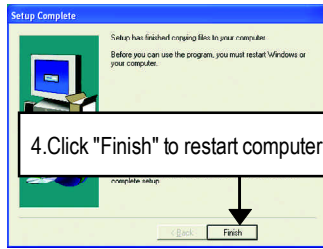

(4)

Appendix C: RealTek 8139/8100 LAN Driver *

Insert the driver CD-title that came with your motherboard into your CD-ROM driver, the driver CD-title will auto start and show the installation guide. If not, please double click the CD-ROM device icon in "My computer", and execute the setup.exe.



(1)

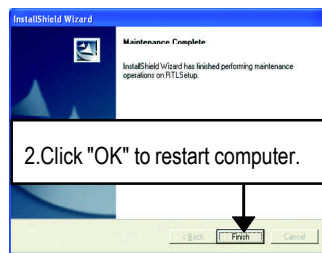

(2)

*** Not Supported 7VKML-DL (PCB VER:3.4)

Appendix D: EasyTune 4 Utilities Installation

Insert the driver CD-title that came with your motherboard into your CD-ROM driver, the driver CD-title will auto start and show the installation guide. If not, please double click the CD-ROM device icon in "My computer", and execute the setup.exe.

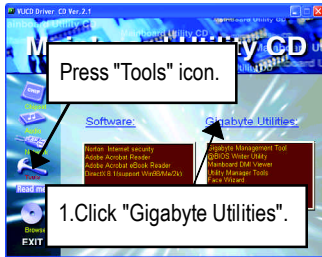

(1)



(2)

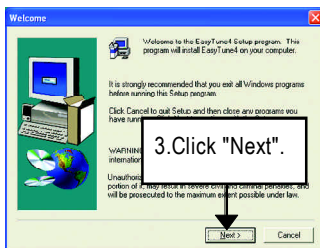

(3)

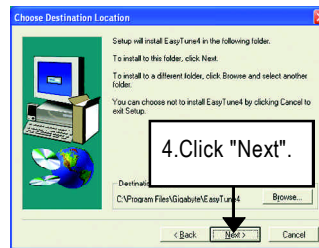

(4)

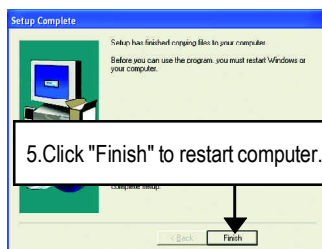

(5)

Appendix E: Acronyms

Acronyms	Meaning
ACPI	Advanced Configuration and Power Interface
APM	Advanced Power Management
AGP	Accelerated Graphics Port
AMR	Audio Modem Riser
ACR	Advanced Communications Riser
BIOS	Basic Input / Output System
CPU	Central Processing Unit
CMOS	Complementary Metal Oxide Semiconductor
CRIMM	Continuity RIMM
CNR	Communication and Networking Riser
DMA	Direct Memory Access
DMI	Desktop Management Interface
DIMM	Dual Inline Memory Module
DRM	Dual Retention Mechanism
DRAM	Dynamic Random Access Memory
DDR	Double Data Rate
ECP	Extended Capabilities Port
ESCD	Extended System Configuration Data
ECC	Error Checking and Correcting
EMC	Electromagnetic Compatibility
EPP	Enhanced Parallel Port
ESD	Electrostatic Discharge
FDD	Floppy Disk Device
FSB	Front Side Bus
HDD	Hard Disk Device
IDE	Integrated Dual Channel Enhanced
IRQ	Interrupt Request
I/O	Input / Output
IOAPIC	Input Output Advanced Programmable Input Controller
ISA	Industry Standard Architecture
LAN	Local Area Network

to be continued.....

FAQ

Below is a collection of general asked questions. To check general asked questions based on a specific motherboard model, please log on to <http://tw.giga-byte.com/faq/faq.htm>

Question 1: I cannot see some options that were included in previous BIOS after updating BIOS. Why?

Answer: Some advanced options are hidden in new BIOS version. Please press Ctrl and F1 keys after entering BIOS menu and you will be able to see these options.

Questions 2: Why is the light of my keyboard/optical mouse still on after computer shuts down?

Answer: In some boards, a small amount of electricity is kept on standby after computer shuts down and that's why the light is still on.

Question 3: Why cannot I use all functions in EasyTune™ 4?

Answer: The availability of the listed functions in EasyTune™ 4 depends on the MB chipset. If the chipset doesn't support certain functions in EasyTune™ 4, these functions will be locked automatically and you will not be able to use them.

Question 4: Why do I fail to install RAID and ATA drivers under Win 2000 and XP on boards that support RAID function after I connect the boot HDD to IDE3 or IDE4 ?

Answer: First of all, you need to save some files in the CD-ROM to a floppy disk before installing drivers. You also need to go through some rather different steps in the installation process. Therefore, we suggest that you refer to the installation steps in the RAID manual at our website.

(Please download it at http://tw.giga-byte.com/support/user_pdf/raid_manual.pdf)

Question 5: How do I clear CMOS?

Answer: If your board has a Clear CMOS jumper, please refer to the Clear CMOS steps in the manual. If your board doesn't have such jumper, you can take off the on-board battery to leak voltage to clear CMOS. Please refer to the steps below:

Steps:

1. Turn off power.
2. Disconnect the power cord from MB.
3. Take out the battery gently and put it aside for about 10 minutes (Or you can use a metal object to connect the positive and negative pins in the battery holder to make them short for one minute).
4. Re-insert the battery to the battery holder.
5. Connect power cord to MB again and turn on power.
6. Press Del to enter BIOS and load Fail-Safe Defaults.
7. Save changes and reboot the system.

Question 6: Why does system seem unstable after updating BIOS?

Answer: Please remember to load Fail-Safe Defaults (Or Load BIOS Defaults) after flashing BIOS. However, if the system instability still remains, please clear CMOS to solve the problem.

Question 7: Why do I still get a weak sound after turning up the speaker to the maximum volume?

Answer: Please make sure the speaker you are using is equipped with an internal amplifier. If not, please change another speaker with power/amplifier and try again later.

Question 8: How do I disable onboard VGA card in order to add an external VGA card?

Answer: Gigabyte motherboards will auto-detect the external VGA card after it is plugged in, so you don't need to change any setting manually to disable the onboard VGA.

Question 9: Why cannot I use the IDE 2?

Answer: Please refer to the user manual and check whether you have connected any cable that is not provided with the motherboard package to the USB Over Current pin in the Front USB Panel. If the cable is your own cable, please remove it from this pin and do not connect any of your own cables to it.

Question 10: Sometimes I hear different continuous beeps from computer after system boots up. What do these beeps usually stand for?

Answer: The beep codes below may help you identify the possible computer problems. However, they are only for reference purposes. The situations might differ from case to case.

→ AMI BIOS Beep Codes

*Computer gives 1 short beep when system boots successfully.

*Except for beep code 8, these codes are always fatal.

- 1 beep Refresh failure
- 2 beeps Parity error
- 3 beeps Base 64K memory failure
- 4 beeps Timer not operational
- 5 beeps Processor error
- 6 beeps 8042 - gate A20 failure
- 7 beeps Processor exception interrupt error
- 8 beeps Display memory read/write failure
- 9 beeps ROM checksum error
- 10 beeps CMOS shutdown register read/write error
- 11 beeps Cache memory bad

→ AWARD BIOS Beep Codes

- 1 short: System boots successfully
- 2 short: CMOS setting error
- 1 long 1 short: DRAM or M/B error
- 1 long 2 short: Monitor or display card error
- 1 long 3 short: Keyboard error
- 1 long 9 short: BIOS ROM error
- Continuous long beeps: DRAM error
- Continuous short beeps: Power error

Troubleshooting



If you encounter any trouble during boot up, please follow the troubleshooting procedures.

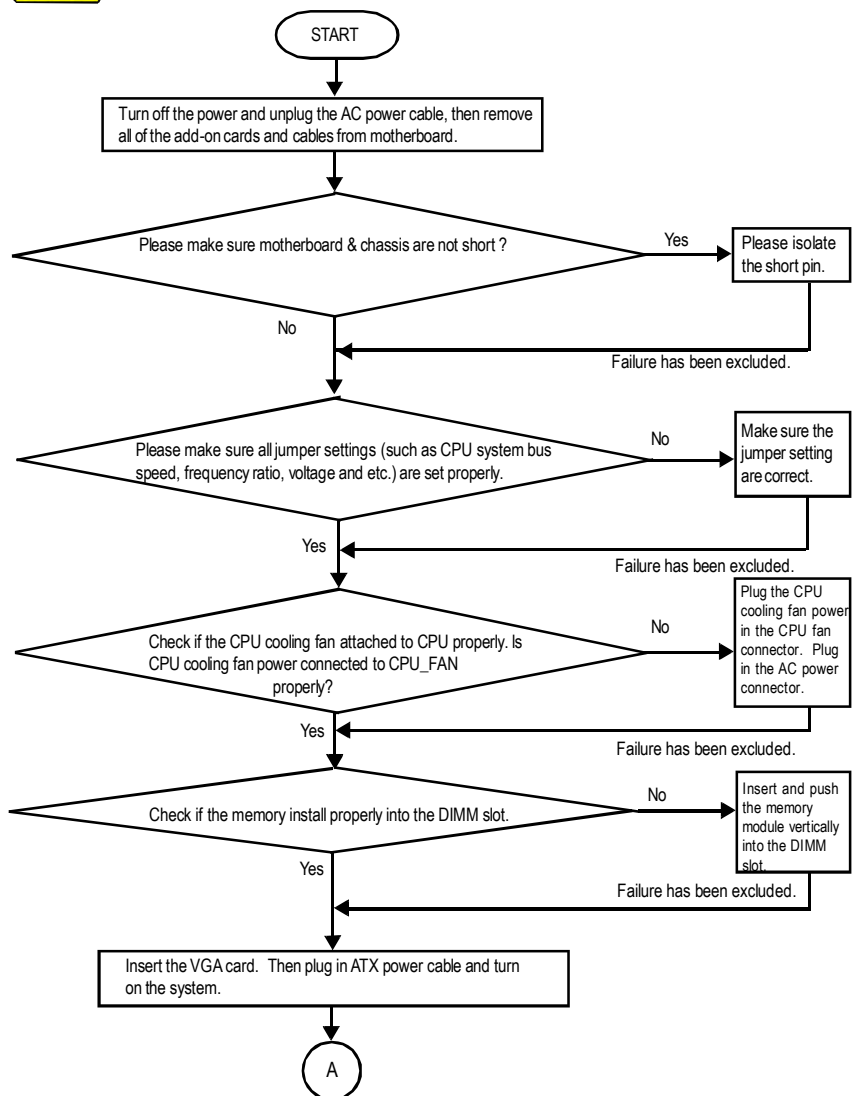

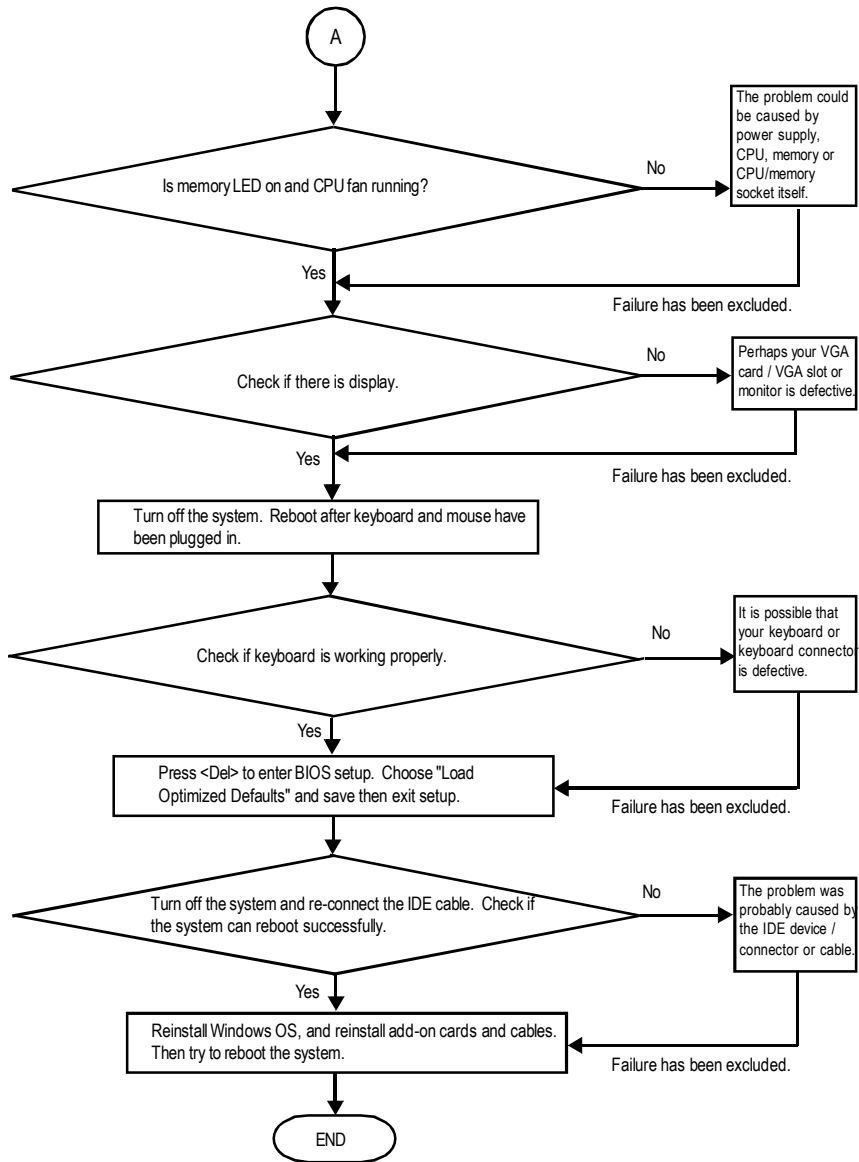

If the above procedure unable to solve your problem, please contact with your local retailer or national distributor for help. Or, you could submit your question to the service mail via Gigabyte website technical support zone (<http://www.gigabyte.com.tw>). The appropriate response will be provided ASAP.

✂ **Technical Support/RMA Sheet**

Customer/Country:	Company:	Phone No.:
Contact Person:	E-mail Add. :	

Model name/Lot Number:	PCB revision:
BIOS version:	O.S./A.S.:

Hardware Configuration	Mfs.	Model name	Size:	Driver/Utility:
CPU				
Memory				
Brand				
Video Card				
Audio Card				
HDD				
CD-ROM / DVD-ROM				
Modem				
Network				
AMR / CNR				
Keyboard				
Mouse				
Power supply				
Other Device				

Problem Description:



Acronyms

Acronyms	Meaning
ACPI	Advanced Configuration and Power Interface
APM	Advanced Power Management
AGP	Accelerated Graphics Port
AMR	Audio Modem Riser
ACR	Advanced Communications Riser
BIOS	Basic Input / Output System
CPU	Central Processing Unit
CMOS	Complementary Metal Oxide Semiconductor
CRIMM	Continuity RIMM
CNR	Communication and Networking Riser
DMA	Direct Memory Access
DMI	Desktop Management Interface
DIMM	Dual Inline Memory Module
DRM	Dual Retention Mechanism
DRAM	Dynamic Random Access Memory
DDR	Double Data Rate
ECP	Extended Capabilities Port
ESCD	Extended System Configuration Data
ECC	Error Checking and Correcting
EMC	Electromagnetic Compatibility
EPP	Enhanced Parallel Port
ESD	Electrostatic Discharge
FDD	Floppy Disk Device
FSB	Front Side Bus
HDD	Hard Disk Device
IDE	Integrated Dual Channel Enhanced
IRQ	Interrupt Request

to be continued.....

Acronyms	Meaning
IOAPIC	Input Output Advanced Programmable Input Controller
ISA	Industry Standard Architecture
LAN	Local Area Network
I/O	Input / Output
LBA	Logical Block Addressing
LED	Light Emitting Diode
MHz	Megahertz
MIDI	Musical Instrument Digital Interface
MTH	Memory Translator Hub
MPT	Memory Protocol Translator
NIC	Network Interface Card
OS	Operating System
OEM	Original Equipment Manufacturer
PAC	PCI A.G.P. Controller
POST	Power-On Self Test
PCI	Peripheral Component Interconnect
RIMM	Rambus in-line Memory Module
SCI	Special Circumstance Instructions
SECC	Single Edge Contact Cartridge
SRAM	Static Random Access Memory

