



When you installing AGP card, please make sure the following notice is fully understood and practiced. If your AGP card has "AGP 4X/8X (1.5V) notch"(show below), please make sure your AGP card is AGP 4X/8X.



**Caution: AGP 2X card is not supported by nVIDIA® nForce™ 2 400. You might experience system unable to boot up normally. Please insert an AGP Pro 4X/8X card.**



Example 1: Diamond Vipper V770 golden finger is compatible with 2X/4X mode AGP slot. It can be switched between AGP 2X(3.3V) or 4X(1.5V) mode by adjusting the jumper. The factory default for this card is 2X(3.3V). The GA-7N400E(-L) (or any AGP 4X/8X only) motherboards might not function properly, if you install this card without switching the jumper to 4X(1.5V) mode in it.

Example 2: Some ATi Rage 128 Pro graphics cards made by "Power Color", the graphics card manufacturer & some SiS 305 cards, their golden finger is compatible with 2X(3.3V) / 4X(1.5V) mode AGP slot, but they support 2X(3.3V) only. The GA-7N400E(-L) (or any AGP 4X/8X only) motherboards might not function properly, if you install this card in it.

Note : Although Gigabyte's AG32S(G) graphics card is based on ATi Rage 128 Pro chip, the design of AG32S(G) is compliance with AGP 4X(1.5V) specification. Therefore, AG32S(G) will work fine with nVIDIA® nForce2 400 based motherboards.



Before you install PCI cards, please remove the Dual BIOS label from PCI slots if there is one.



- 💣 The author assumes no responsibility for any errors or omissions that may appear in this document nor does the author make a commitment to update the information contained herein.
- 💣 Third-party brands and names are the property of their respective owners.
- 💣 Please do not remove any labels on motherboard, this may void the warranty of this motherboard.
- 💣 Due to rapid change in technology, some of the specifications might be out of date before publication of this booklet.



**WARNING:** Never run the processor without the heatsink properly and firmly attached. **PERMANENT DAMAGE WILL RESULT!**

**Mise en garde :** Ne faites jamais tourner le processeur sans que le dissipateur de chaleur soit fixé correctement et fermement. **UN DOMMAGE PERMANENT EN RÉSULTERA !**

**Achtung:** Der Prozessor darf nur in Betrieb genommen werden, wenn der W-Heatbleiter ordnungsgemäß und fest angebracht ist. **DIES HAT EINEN PERMANENTEN SCHADEN ZUM FOLGE!**

**Advertencia:** Nunca haga funcionar el procesador sin el dissipador de calor instalado correcto y firmemente. **¡SE PRODUCIRÁ UN DAÑO PERMANENTE!**

**Atenção:** Nunca execute o processador sem o dissipador de calor estar adequadamente e firmemente conectado. **O RESULTADO SERÁ UM DANO PERMANENTE!**

**警告:** 將溫度感測器安裝到處理器上之前，不要運行處理器。這將導致永久性處理損傷！

**警告:** 將溫度感測器安裝到處理器上之前，不要運行處理器。這將導致永久性處理損傷！

**注意:** 온도 센서를 설치하기 전에 반드시 프로세서에 온도 센서를 올바르게 부착하십시오. (부적절한 부착은 영구적 손상을 유발합니다.)

**警告:** 永久的な損傷を防ぐため、ヒートシンクを正しくしっかりと取り付けるまで、プロセッサを動作させないようにしてください。

## Declaration of Conformity

We, Manufacturer/Importer  
(full address)

**G.B.T. Technology Trading GmbH**  
Ausschlag Weg 41, 1F, 20537 Hamburg, Germany

declare that the product  
(description of the apparatus, system, installation to which it refers)

### Mother Board

GA-7N400E

is in conformity with

(reference to the specification under which conformity is declared)

in accordance with 89/336 EEC-EMC Directive

<input type="checkbox"/> EN 55011	Limits and methods of measurement of radio disturbance characteristics of industrial, scientific and medical (ISM) high frequency equipment	<input type="checkbox"/> EN 61000-3-2* <input checked="" type="checkbox"/> EN 60555-2	Disturbances in supply systems cause by household appliances and similar electrical equipment "Harmonics"
<input type="checkbox"/> EN 55013	Limits and methods of measurement of radio disturbance characteristics of broadcast receivers and associated equipment	<input type="checkbox"/> EN 61000-3-3* <input checked="" type="checkbox"/> EN 60555-3	Disturbances in supply systems cause by household appliances and similar electrical equipment "Voltage fluctuations"
<input type="checkbox"/> EN 55014	Limits and methods of measurement of radio disturbance characteristics of household electrical appliances, portable tools and similar electrical apparatus	<input checked="" type="checkbox"/> EN 50081-1 <input checked="" type="checkbox"/> EN 50082-1	Generic emission standard Part 1: Residual commercial and light industry Generic immunity standard Part 1: Residual commercial and light industry
<input type="checkbox"/> EN 55015	Limits and methods of measurement of radio disturbance characteristics of fluorescent lamps and luminaries	<input type="checkbox"/> EN 55081-2	Generic emission standard Part 2: Industrial environment
<input type="checkbox"/> EN 55020	Immunity from radio interference of broadcast receivers and associated equipment	<input type="checkbox"/> EN 55082-2	Generic emission standard Part 2: Industrial environment
<input checked="" type="checkbox"/> EN 55022	Limits and methods of measurement of radio disturbance characteristics of information technology equipment	<input type="checkbox"/> ENV 55104	Immunity requirements for household appliances tools and similar apparatus
<input type="checkbox"/> DIN VDE 0 855 <input type="checkbox"/> part 10 <input type="checkbox"/> part 12	Cabled distribution systems; Equipment for receiving and/or distribution from sound and television signals	<input type="checkbox"/> EN 50091-2	EMC requirements for uninterruptible power systems (UPS)
<input checked="" type="checkbox"/> CE marking			(EC conformity marking)

The manufacturer also declares the conformity of above mentioned product  
with the actual required safety standards in accordance with LVD 73/23 EEC

<input type="checkbox"/> EN 60065	Safety requirements for mains operated electronic and related apparatus for household and similar general use	<input type="checkbox"/> EN 60950	Safety for information technology equipment including electrical business equipment
<input type="checkbox"/> EN 60335	Safety of household and similar electrical appliances	<input type="checkbox"/> EN 50091-1	General and Safety requirements for uninterruptible power systems (UPS)

Manufacturer/Importer

(Stamp)

Date : July 4, 2003

Signature:

Name:

Timmy Huang

Timmy Huang

## DECLARATION OF CONFORMITY

Per FCC Part 2 Section 2.1077(a)



**Responsible Party Name: G.B.T. INC. (U.S.A.)**

**Address: 17358 Railroad Street**

**City of Industry, CA 91748**

**Phone/FaxNo: (818) 854-9338/ (818) 854-9339**

hereby declares that the product

**Product Name: Motherboard**

**Model Number: GA-7N400E**

Conforms to the following specifications:

FCC Part 15, Subpart B, Section 15.107(a) and Section 15.109(a),  
Class B Digital Device

### **Supplementary Information:**

This device complies with part 15 of the FCC Rules. Operation is subject to the following two conditions: (1) This device may not cause harmful and (2) this device must accept any interference received, including that may cause undesired operation.

Representative Person's Name: ERIC LU

Signature: Eric Lu

Date: July 4, 2003

GA-7N400E(-L)

AMD Socket A Processor Motherboard

# USER'S MANUAL

AMD Athlon™ / Athlon™ XP / Duron™ Socket A Processor Motherboard

Rev. 1001

12ME-7N400E-1001

## Table of Content

Item Checklist .....	4
Chapter 1 Introduction .....	5
Features Summary .....	5
GA-7N400E(-L) Motherboard Layout .....	7
Block Diagram - GA-7N400E(-L) .....	8
Chapter 2 Hardware Installation Process .....	9
Step 1: Set System Jumper (CLK_SW)&(CLK_RATIO) .....	10
Step 2: Install the Central Processing Unit (CPU) .....	11
Step 2-1: CPU Installation .....	11
Step 2-2: CPU Cooling Fan Installation .....	12
Step 3: Install Memory Modules .....	14
Step 4: Install expansion cards .....	15
Step 5: Connect ribbon cables, cabinet wires and power supply .....	16
Step 5-1: I/O Back Panel Introduction .....	16
Step 5-2: Connectors Introduction .....	18
Chapter 3 BIOS Setup .....	31
The Main Menu (For example: BIOS Ver. : E2) .....	32
Standard CMOS Features .....	34
Advanced BIOS Features .....	36
Advanced Chipset Features .....	39

Integrated Peripherals ..... 41  
Power Management Setup ..... 46  
PnP/PCI Configurations ..... 49  
PC Health Status ..... 50  
Frequency/Voltage Control ..... 52  
Load Fail-Safe Defaults ..... 53  
Load Optimized Defaults ..... 54  
Set Supervisor/User Password ..... 55  
Save & Exit Setup ..... 56  
Exit Without Saving ..... 57

Chapter 4 Technical Reference ..... 59  
Flash BIOS Method Introduction ..... 59  
@BIOS™ Introduction ..... 63  
2- / 4- / 6-Channel Audio Function Introduction ..... 64  
Xpress Recovery Introduction ..... 70

Chapter 5 Appendix ..... 75

## Item Checklist

- The GA-7N400E(-L) motherboard
- CD for motherboard driver & utility
- The GA-7N400E(-L) user's manual
- Quick PC Installation Guide
- IDE cable x 1 / Floppy cable x 1
- 2 Port USB Cable x 1
- I/O Shield
- Motherboard Settings Label
- ATX 12V Cable (\*)



Computer motherboards and expansion cards contain very delicate Integrated Circuit (IC) chips. To protect them against damage from static electricity, you should follow some precautions whenever you work on your computer.

1. Unplug your computer when working on the inside.
2. Use a grounded wrist strap before handling computer components. If you do not have one, touch both of your hands to a safely grounded object or to a metal object, such as the power supply case.
3. Hold components by the edges and try not touch the IC chips, leads or connectors, or other components.
4. Place components on a grounded antistatic pad or on the bag that came with the components whenever the components are separated from the system.
5. Ensure that the ATX power supply is switched off before you plug in or remove the ATX power connector on the motherboard.

### Installing the motherboard to the chassis...

If the motherboard has mounting holes, but they don't line up with the holes on the base and there are no slots to attach the spacers, do not become alarmed you can still attach the spacers to the mounting holes. Just cut the bottom portion of the spacers (the spacer may be a little hard to cut off, so be careful of your hands). In this way you can still attach the motherboard to the base without worrying about short circuits. Sometimes you may need to use the plastic springs to isolate the screw from the motherboard PCB surface, because the circuit wire may be near by the hole. Be careful, don't let the screw contact any printed circuit write or parts on the PCB that are near the fixing hole, otherwise it may damage the board or cause board malfunctioning.

(\*) If this "ATX\_12V connector" is not connected, system cannot boot.



## Chapter 1 Introduction

### Features Summary

Form Factor	<ul style="list-style-type: none"> <li>• 30.5cm x 24.4cm ATX size form factor, 4 layers PCB</li> </ul>
CPU	<ul style="list-style-type: none"> <li>• Socket A processor for AMD Athlon™ / Athlon™ XP / Duron™ (K7)</li> <li>• 128K L1 &amp; 256K/64K L2 cache on die</li> <li>• 400/333/266/200 MHz FSB</li> <li>• Supports 1.4GHz and faster</li> </ul>
Chipset	<ul style="list-style-type: none"> <li>• nVIDIA® nForce™ 2 400 Memory/AGP/ PCI Controller (PAC)</li> <li>• nVIDIA® nForce™ 2 MCP Integrated Peripheral Controller (PSIPC)</li> </ul>
Memory	<ul style="list-style-type: none"> <li>• 4 184-pin DDR DIMM sockets</li> <li>• Supports 128MB/256MB/512MB/1GB unbuffered DRAM</li> <li>• Supports up to 3GB DRAM (Max)</li> <li>• Supports only 2.5V DDR DIMM</li> </ul>
I/O Control	<ul style="list-style-type: none"> <li>• IT8712F</li> </ul>
Slots	<ul style="list-style-type: none"> <li>• 1 AGP slot supports 8X/4X mode, AGP3.0 8X interface at 533MHz</li> <li>• 5 PCI slots support 33MHz &amp; PCI 2.2 compliant</li> </ul>
On-Board IDE	<ul style="list-style-type: none"> <li>• 2 IDE controllers provides IDE HDD/CD-ROM (IDE1, IDE2) with PIO, Bus Master (Ultra DMA33/ATA66/ATA100/ATA133) operation modes</li> </ul>
Hardware Monitor	<ul style="list-style-type: none"> <li>• CPU/System fan revolution detect</li> <li>• CPU/System temperature detect</li> <li>• CPU warning temperature</li> <li>• System voltage detect</li> <li>• CPU/System fan fail warning</li> <li>• Thermal shutdown function</li> </ul>
On-Board Peripherals	<ul style="list-style-type: none"> <li>• 1 Floppy port supports 2 FDD with 360K, 720K, 1.2M, 1.44M and 2.88M bytes</li> <li>• 1 Parallel port supports Normal/EPP/ECP mode</li> <li>• 2 Serial ports (COM1 &amp; COM2)</li> <li>• 6 USB 2.0/1.1 ports (4 x Rear, 2 x Front by cable)</li> <li>• 1 IrDA connector for IR</li> <li>• 1 Front Audio connector</li> </ul>

to be continued.....

On-Board LAN(*)	<ul style="list-style-type: none"> <li>Built in Realtek 8100C</li> <li>1 RJ45 port</li> </ul>
On-Board Sound	<ul style="list-style-type: none"> <li>Realtek ALC650 CODEC</li> <li>Line Out / 2 front speaker</li> <li>Line In / 2 rear speaker (by s/w switch)</li> <li>Mic In / center &amp; subwoofer (by s/w switch)</li> <li>SPDIF In / Out</li> <li>CD In / AUX In / Game port</li> </ul>
PS/2 Connector	<ul style="list-style-type: none"> <li>PS/2 Keyboard interface and PS/2 Mouse interface</li> </ul>
BIOS	<ul style="list-style-type: none"> <li>Licensed AWARD BIOS</li> <li>Supports Q-Flash</li> </ul>
Additional Features	<ul style="list-style-type: none"> <li>PS/2 Keyboard power on by password</li> <li>PS/2 Mouse power on</li> <li>External Modem wake up</li> <li>STR(Suspend-To-RAM)</li> <li>AC Recovery</li> <li>Poly fuse for keyboard over-current protection</li> <li>USB KB/Mouse wake up from S3</li> <li>Supports Thermal Shutdown function</li> <li>Supports @BIOS</li> </ul>
Overclocking	<ul style="list-style-type: none"> <li>Over Voltage (CPU/DDR/AGP) by BIOS</li> <li>Over Clock (CPU/DDR/AGP) by BIOS</li> </ul>

(\*)For GA-7N400E-L only.



Please set the CPU host frequency in accordance with your processor's specifications.

We don't recommend you to set the system bus frequency over the CPU's specification because these specific bus frequencies are not the standard specifications for CPU, chipset and most of the peripherals. Whether your system can run under these specific bus frequencies properly will depend on your hardware configurations, including CPU, Chipsets, SDRAM, Cards...etc.

# GA-7N400E(-L) Motherboard Layout

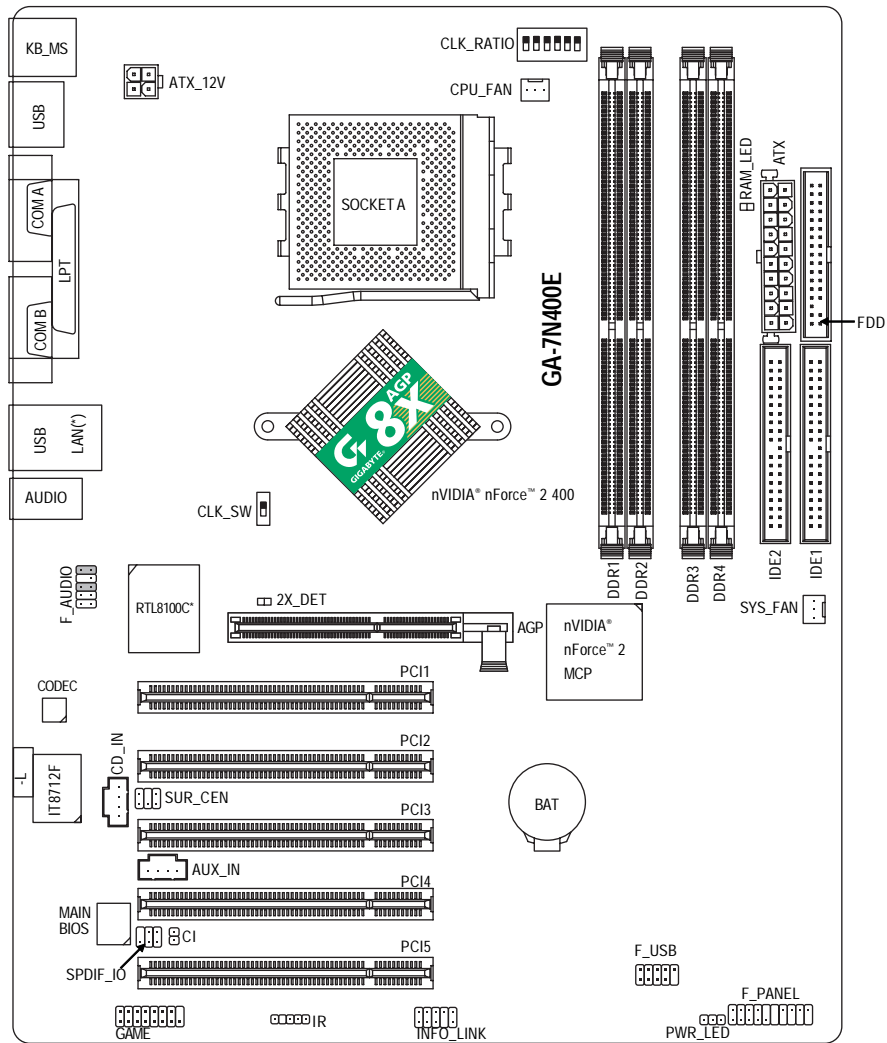

(\*)For GA-7N400E-L only.

**Block Diagram - GA-7N400E(-L)**

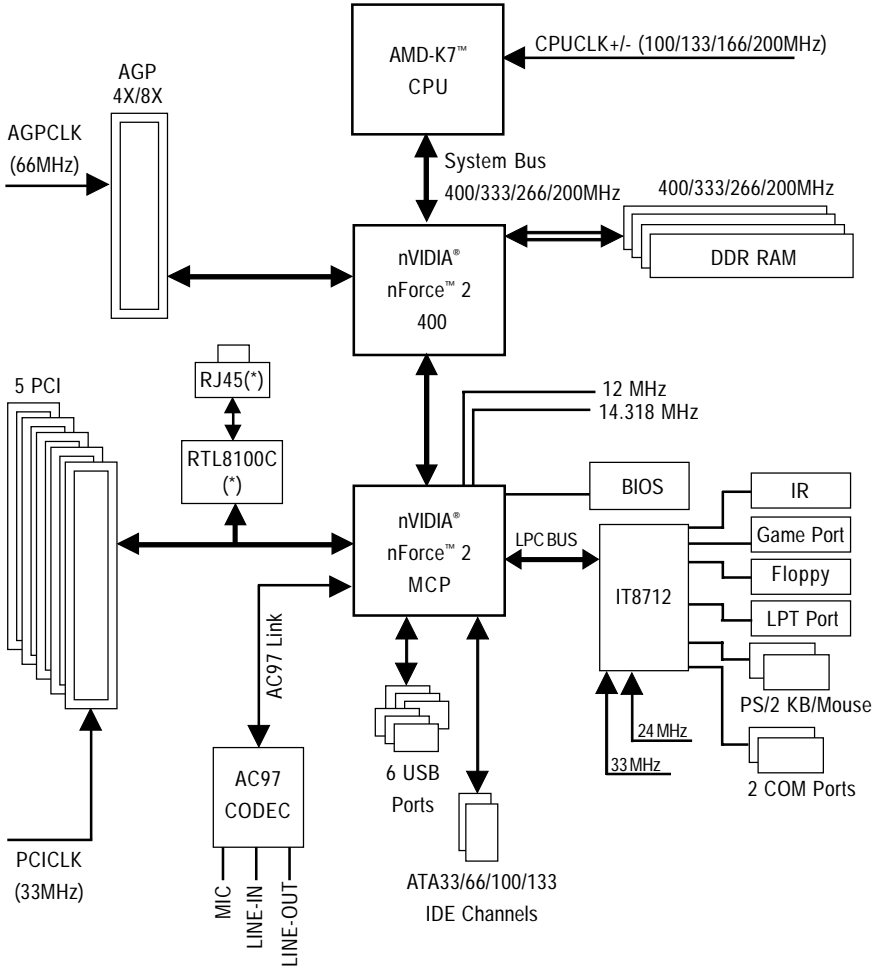

(\*)For GA-7N400E-L only.

## Chapter 2 Hardware Installation Process

To set up your computer, you must complete the following steps:

- Step 1- Set system jumper (CLK\_SW)& (CLK\_RATIO)
- Step 2- Install the Central Processing Unit (CPU)
- Step 3- Install memory modules
- Step 4- Install expansion cards
- Step 5- Connect ribbon cables, cabinet wires, and power supply

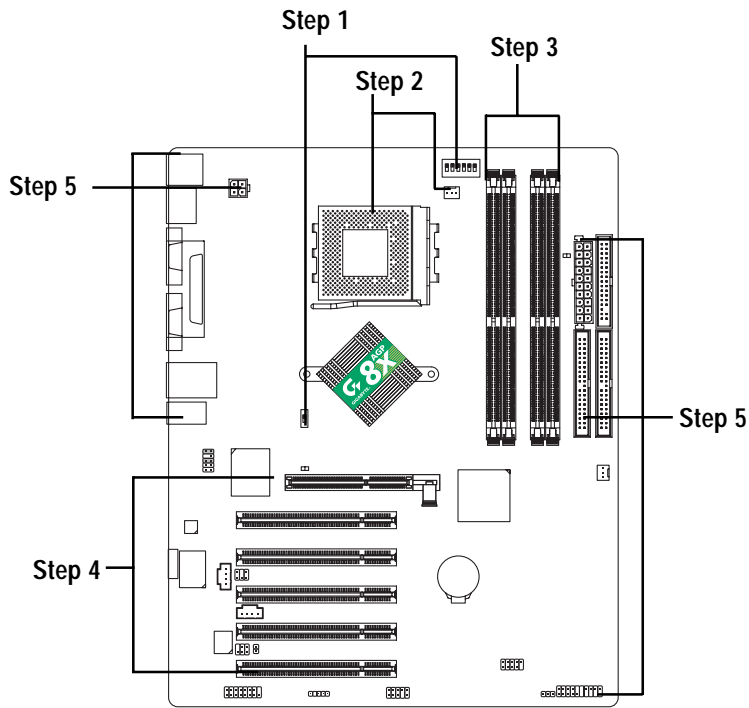

Congratulations! You have accomplished the hardware installation!

Turn on the power supply or connect the power cable to the power outlet. Continue with the BIOS/software installation.

## Step 1: Set System Jumper (CLK\_SW) & (CLK\_RATIO)

The clock ratio can be switched by CLK\_RATIO and refer to below table. The system bus frequency can be switched at 100MHz and auto by adjusting CLK\_SW.

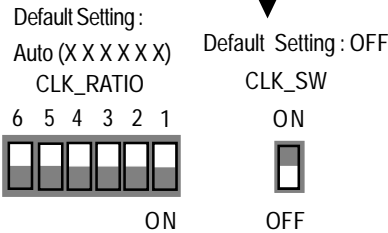
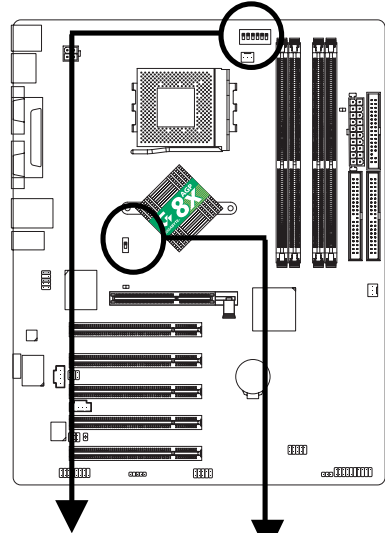

CLK_SW	
ON	AUTO
OFF	100MHz

AUTO : Supports FSB 400/333/266 MHz CPU  
 100MHz : Fix FSB 200MHz CPU

CLK_RATIO	O: ON / X:OFF					
RATIO	1	2	3	4	5	6
AUTO (Default)	X	X	X	X	X	X
5x	O	O	X	O	O	O
5.5x	X	O	X	O	O	O
6x	O	X	X	O	O	O
6.5x	X	X	X	O	O	O
7x	O	O	O	X	O	O
7.5x	X	O	O	X	O	O
8x	O	X	O	X	O	O
8.5x	X	X	O	X	O	O
9x	O	O	X	X	O	O
9.5x	X	O	X	X	O	O
10x	O	X	X	X	O	O
10.5x	X	X	X	X	O	O
11x	O	O	O	O	O	O
11.5x	X	O	O	O	O	O
12x	O	X	O	O	O	O
12.5x	X	X	O	O	O	O
13x	O	O	X	O	X	O
13.5x	X	O	X	O	X	O
14x	O	X	X	O	X	O
15x	O	O	O	X	X	O
16x	O	X	O	X	X	O
16.5x	X	X	O	X	X	O
17x	O	O	X	X	X	O
18x	X	O	X	X	X	O



You must set CLK\_SW to 100MHz when you used FSB 200MHz CPU.

Note: In order to BIOS can auto detecting when your CPU multiplier over 18x, please adjust multiplier switch in CLK\_RATIO to "AUTO."

## Step 2: Install the Central Processing Unit (CPU)



Before installing the processor, adhere to the following warning:

1. Please make sure the CPU type is supported by the motherboard.
2. If you do not match the CPU socket Pin 1 and CPU cut edge well, it will cause improper installation. Please change the insert orientation.

### Step 2-1: CPU Installation

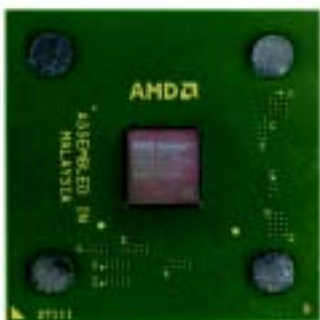

CPU Top View

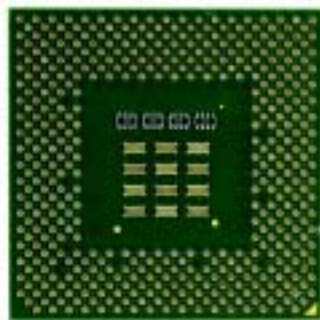

CPU Bottom View

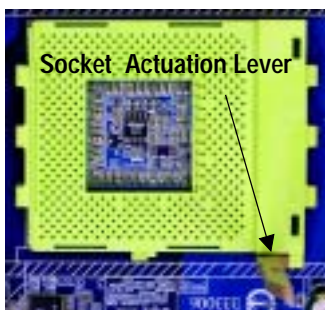

- 1 Pull up the CPU socket lever and up to 90-degree angle.

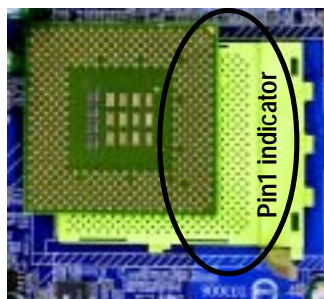

2. Locate Pin 1 in the socket and look for a (golden) cut edge on the CPU upper corner. Then insert the CPU into the socket.

## Step 2-2: CPU Cooling Fan Installation



Before installing the CPU cooling fan, adhere to the following warning:

1. Please use AMD approved cooling fan.
2. We recommend you to apply the thermal tape to provide better heat conduction between your CPU and cooling fan.
3. Make sure the CPU fan power cable is plugged in to the CPU fan connector, this completes the installation.

Please refer to CPU cooling fan user's manual for more detail installation procedure.

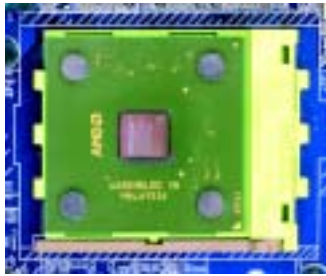

1. Press down the CPU socket lever and finish CPU installation.



2. Use qualified fan approved by AMD.

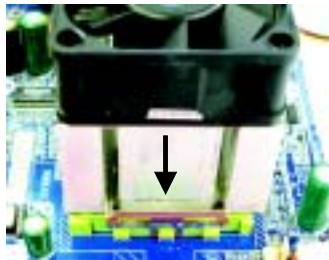

3. Fasten the cooling fan supporting-base onto the CPU socket on the motherboard.

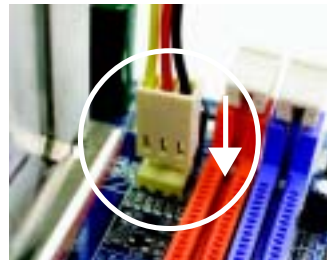

4. Make sure the CPU fan is plugged to the CPU fan connector, then install complete.



### Step 3: Install Memory Modules



Before installing the memory modules, adhere to the following warning:

1. When DIMM LED is ON, do not install / remove DIMM from socket.
2. Please note that the DIMM module can only fit in one direction due to the one notch. Wrong orientation will cause improper installation. Please change the insert orientation.

The motherboard has 4 dual inline memory module (DIMM) sockets, but it can only support a maximum of 4 banks of DDR memory. DDR slot 1 uses 2 banks, DDR slot 2 uses 2 banks, DDR slot 3&4 share the remaining 2 banks. Please refer to the following tables for possible memory configurations supported. The BIOS will automatically detects memory type and size. To install the memory module, just push it vertically into the DIMM Slot. The DIMM module can only fit in one direction due to the notch. Memory size can vary between sockets.

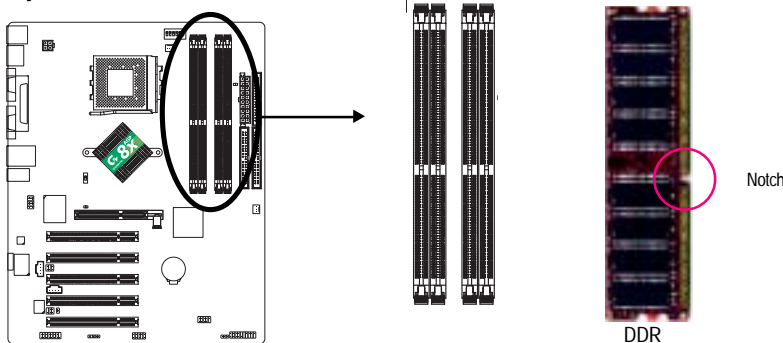

The following tables include all memory-installed combination types:  
(Please note that those types not in the tables will not boot up.) (DS: Double Side, SS: Single Side)

	DIMM 1	DIMM 2	DIMM 3	DIMM 4
1 memory module	DS/SS	X	X	X
	X	DS/SS	X	X
	X	X	DS/SS	X
	X	X	X	DS
2 memory modules	DS/SS	DS/SS	X	X
	X	X	SS	SS
	DS/SS	X	DS/SS	X
	X	DS/SS	DS/SS	X
	DS/SS	X	X	DS
	X	DS/SS	X	DS
3 memory modules	DS/SS	DS/SS	DS/SS	X
	DS/SS	DS/SS	X	DS
	X	DS/SS	SS	SS
	DS/SS	X	SS	SS
4 memory modules	DS/SS	DS/SS	SS	SS



If memories are inserted on dimm3 and dimm4 at the same time, please note that the memories must be exactly identical in device, type, size and single side. This is essential to let system boot up correctly

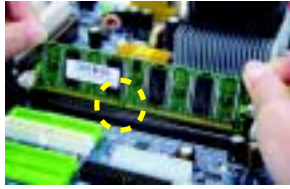

1. The DIMM socket has a notch, so the DIMM memory module can only fit in one direction.



2. Insert the DIMM memory module vertically into the DIMM socket. Then push it down.



3. Close the plastic clip at both edges of the DIMM sockets to lock the DIMM module. Reverse the installation steps when you wish to remove the DIMM module.

Support Unbuffered DDR DIMM Sizes type:

64 Mbit (2Mx8x4 banks)	64 Mbit (1Mx16x4 banks)	128 Mbit(4Mx8x4 banks)
128 Mbit(2Mx16x4 banks)	256 Mbit(8Mx8x4 banks)	256 Mbit(4Mx16x4 banks)
512 Mbit(16Mx8x4 banks)	512 Mbit(8Mx16x4 banks)	
Total System Memory (Max3GB)		

### DDR Introduction

Established on the existing SDRAM infrastructure, DDR (Double Data Rate) memory is a high performance and cost-effective solution that allows easy adoption for memory vendors, OEMs, and system integrators.

DDR memory is a great evolutionary solution for the PC industry that builds on the existing SDRAM architecture, yet make the awesome advances in solving the system performance bottleneck by doubling the memory bandwidth. Nowadays, with the highest bandwidth of 3.2GB/s of DDR400 memory and complete line of DDR400/333/266/200 memory solutions, DDR memory is the best choice for building high performance and low latency DRAM subsystem that are suitable for servers, workstations, and full range of desktop PCs.

## Step 4: Install expansion cards

1. Read the related expansion card's instruction document before install the expansion card into the computer.
2. Remove your computer's chassis cover, screws and slot bracket from the computer.
3. Press the expansion card firmly into expansion slot in motherboard.
4. Be sure the metal contacts on the card are indeed seated in the slot.
5. Replace the screw to secure the slot bracket of the expansion card.
6. Replace your computer's chassis cover.
7. Power on the computer, if necessary, setup BIOS utility of expansion card from BIOS.
8. Install related driver from the operating system.

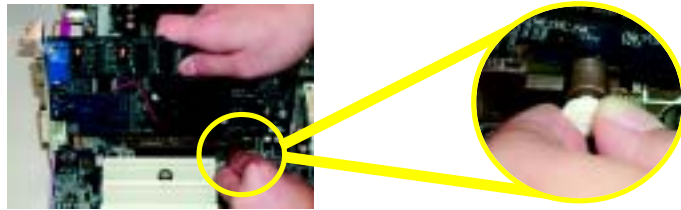

Please carefully pull out the small white-drawable bar at the end of the AGP slot when you try to install / uninstall the AGP card. Please align the AGP card to the onboard AGP slot and press firmly down on the slot. Make sure your AGP card is locked by the small white-drawable bar.



When an AGP 2X (3.3V) card is installed the 2X\_DET will light up, indicating a non-supported graphics card is inserted. Informing users that system might not boot up normally due to AGP 2X (3.3V) is not supported by the chipset.

**Step 5: Connect ribbon cables, cabinet wires and power supply**

**Step 5-1: I/O Back Panel Introduction**

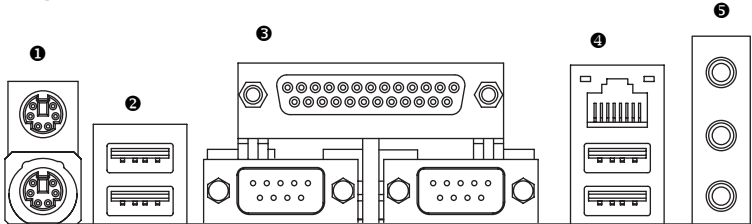

**GA-7N400E-L**

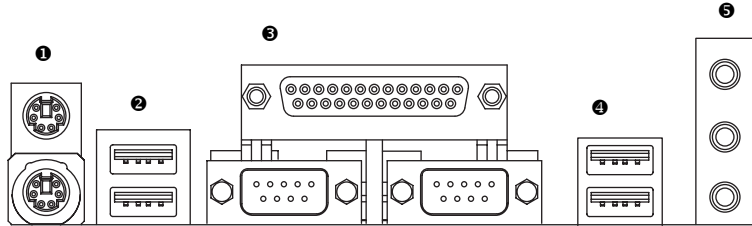

**GA-7N400E**

**❶ PS/2 Keyboard and PS/2 Mouse Connector**

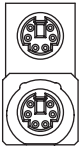

PS/2 Mouse Connector  
(6 pin Female)

PS/2 Keyboard Connector  
(6 pin Female)

➤ This connector supports standard PS/2 keyboard and PS/2 mouse.

**❷/❹ USB/LAN Connector**

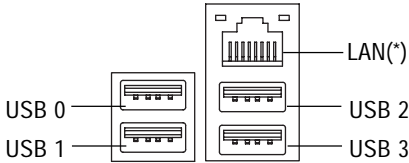

➤ Before you connect your device(s) into USB connector(s), please make sure your device(s) such as USB keyboard, mouse, scanner, zip, speaker...etc. Have a standard USB interface. Also make sure your OS supports USB controller. If your OS does not support USB controller, please contact OS vendor for possible patch or driver upgrade. For more information please contact your OS or device(s) vendors.

(\*)For GA-7N400E-L only.

### ③ Parallel Port, Serial Ports COM1 / COM2

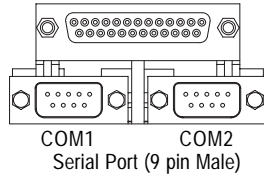

- According to your motherboard, please see the following descriptions for the devices. Device like printer can be connected to Parallel port; mouse and modem etc. can be connected to Serial ports.

### ⑤ Audio Connectors

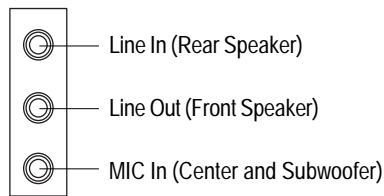

- After install onboard audio driver, you may connect speaker to Line Out jack, microphone to MIC In jack. Device like CD-ROM, walkman etc. can be connected to Line-In jack.

**Please note:**

You are able to use 2-/4-/6-channel audio feature by S/W selection.

If you want to enable 6-channel function, you have 2 choose for hardware connection.

**Method1:**

Connect "Front Speaker" to "Line Out"

Connect "Rear Speaker" to "Line In"

Connect "Center and Subwoofer" to "MIC Out".

**Method2:**

You can refer to page 25, and contact your nearest dealer for optional SUR\_CEN cable.



*If you want the detail information for 2-/4-/6-channel audio setup installation, please refer to page 64.*

Step 5-2: Connectors Introduction

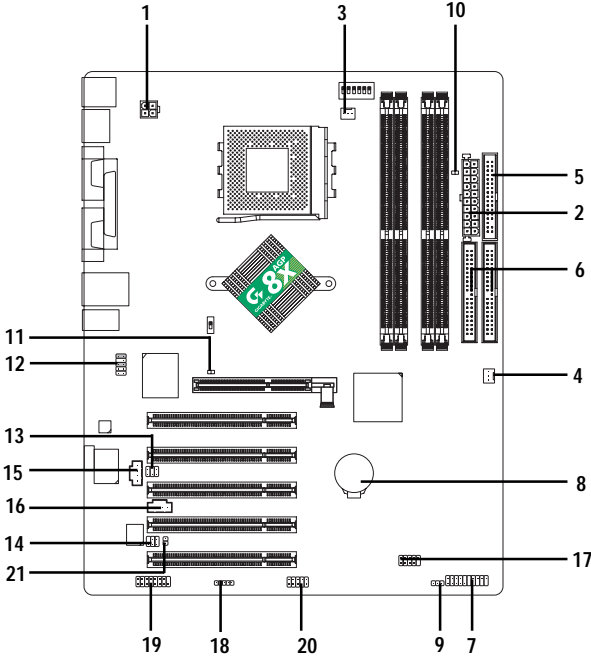

1) ATX_12V	12) F_AUDIO
2) ATX	13) SUR_CEN
3) CPU_FAN	14) SPDIF_IO
4) SYS_FAN	15) CD_IN
5) FDD	16) AUX_IN
6) IDE1 / IDE2	17) F_USB
7) F_PANEL	18) IR
8) BAT	19) GAME
9) PWR_LED	20) INFO_LINK
10) RAM_LED	21) CI
11) 2X_DET	

### 1) ATX\_12V (+12V Power Connector)

This connector (ATX\_12V) supplies the CPU operation voltage (Vcore).  
 If this "ATX\_12V connector" is not connected, system cannot boot.

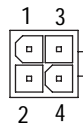
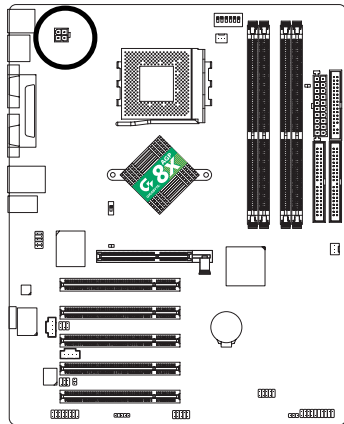

Pin No.	Definition
1	GND
2	GND
3	+12V
4	+12V

### 2) ATX (ATX Power)

AC power cord should only be connected to your power supply unit after ATX power cable and other related devices are firmly connected to the mainboard.

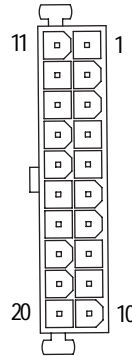
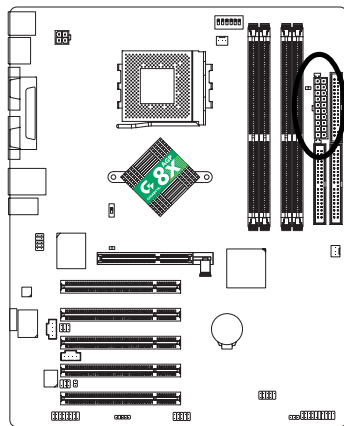

Pin No.	Definition
1	3.3V
2	3.3V
3	GND
4	VCC
5	GND
6	VCC
7	GND
8	Power Good
9	5V SB (stand by +5V)
10	+12V
11	3.3V
12	-12V
13	GND
14	PS_ON(soft on/off)
15	GND
16	GND
17	GND
18	-5V
19	VCC
20	VCC

### 3) CPU\_FAN (CPU Fan Connector)

Please note, a proper installation of the CPU cooler is essential to prevent the CPU from running under abnormal condition or damaged by overheating. The CPU fan connector supports Max. current up to 600 mA.

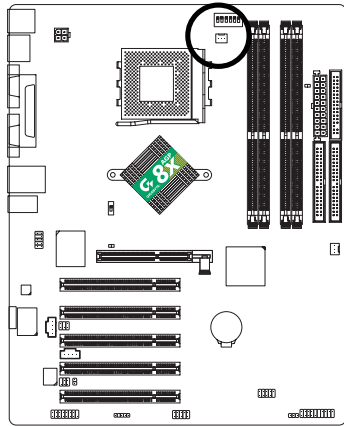

Pin No.	Definition
1	GND
2	+12V
3	Sense

### 4) SYS\_FAN (System Fan Connector)

This connector allows you to link with the cooling fan on the system case to lower the system temperature.

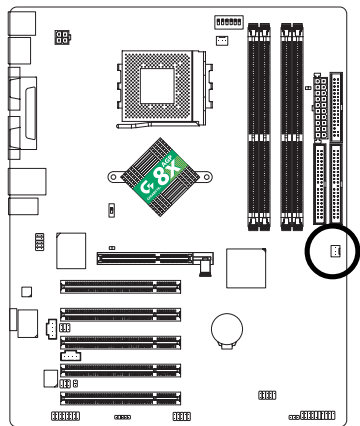

Pin No.	Definition
1	GND
2	+12V
3	Sense



### 5) FDD (Floppy Connector)

Please connect the floppy drive ribbon cables to FDD. It supports 360K, 1.2M, 720K, 1.44M and 2.88M bytes floppy disk types.

The red stripe of the ribbon cable must be the same side with the Pin1.

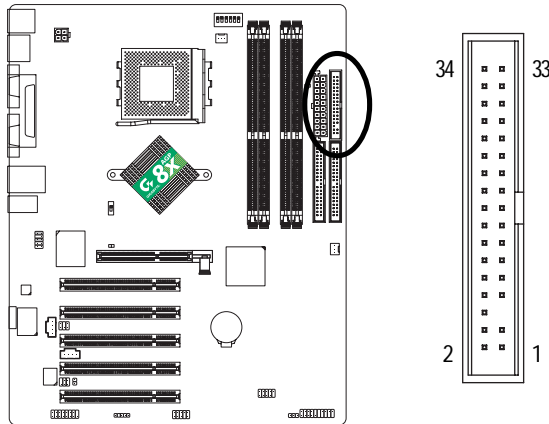

### 6) IDE1 / IDE2 (IDE1 / IDE2 Connector)

Important Notice:

Please connect first hard disk to IDE1 and connect CD-ROM to IDE2.

The red stripe of the ribbon cable must be the same side with the Pin1.

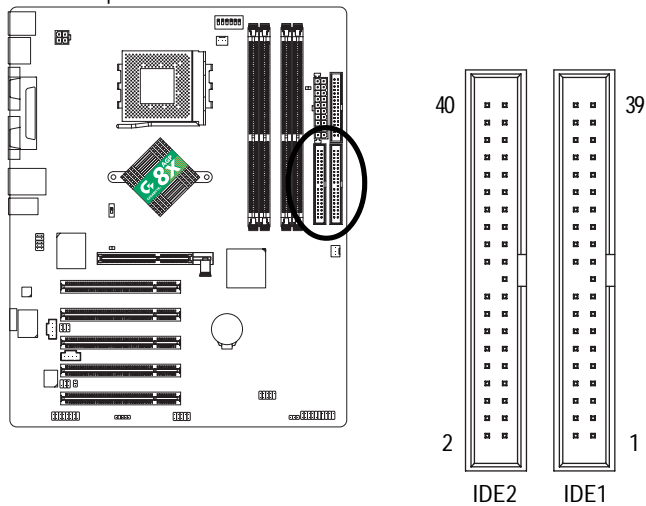

### 7) F\_PANEL (2 x 10 pins Connector)

Please connect the power LED, PC speaker, reset switch and power switch etc. of your chassis front panel to the F\_PANEL connector according to the pin assignment above.

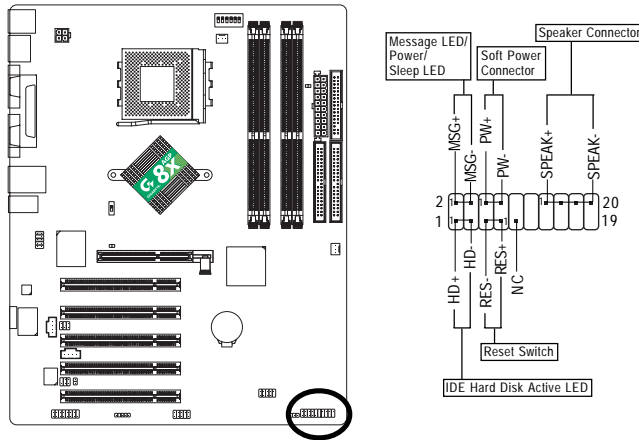

HD (IDE Hard Disk Active LED) (Blue)	Pin 1: LED anode(+) Pin 2: LED cathode(-)
SPK (Speaker Connector) (Amber)	Pin 1: VCC(+) Pin 2- Pin 3: NC Pin 4: Data(-)
RES (Reset Switch) (Green)	Open: Normal Operation Close: Reset Hardware System
PW (Soft Power Connector) (Red)	Open: Normal Operation Close: Power On/Off
MSG(Message LED/ Power/ Sleep LED) (Yellow)	Pin 1: LED anode(+) Pin 2: LED cathode(-)
NC (Purple)	NC

## 8) BATTERY

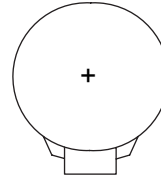
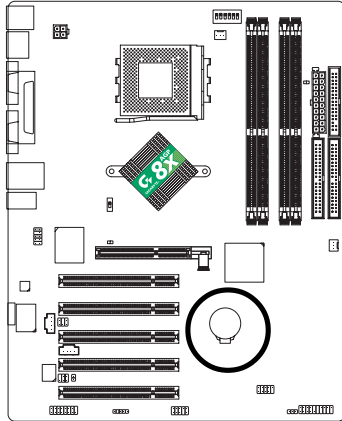

### CAUTION

- ❖ Danger of explosion if battery is incorrectly replaced.
- ❖ Replace only with the same or equivalent type recommended by the manufacturer.
- ❖ Dispose of used batteries according to the manufacturer's instructions.

If you want to erase CMOS...

1. Turn OFF the computer and unplug the power cord.
2. Remove the battery, wait for 30 second.
3. Re-install the battery.
4. Plug the power cord and turn ON the computer.

## 9) PWR\_LED

PWR\_LED is connect with the system power indicator to indicate whether the system is on/off. It will blink when the system enters suspend mode. If you use dual color LED, power LED will turn to another color.

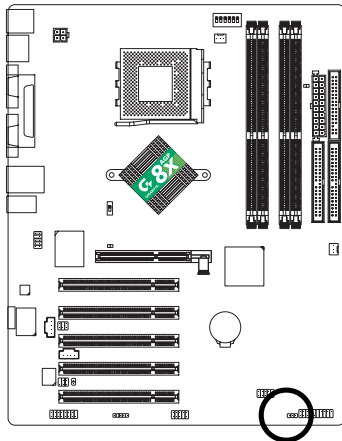

1

Pin No.	Definition
1	MPD+
2	MPD-
3	MPD-

### 10) RAM\_LED

Do not remove memory modules while RAM\_LED is on. It might cause short or other unexpected damages due to the stand by voltage. Remove memory modules only when AC power cord is disconnected.

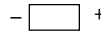
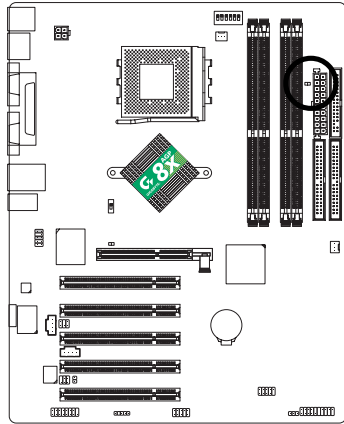

### 11) 2X\_DET

When an AGP 2X (3.3V) card is installed the 4X\_AGP will light up, indicating a non-supported graphics card is inserted. Informing users that system might not boot up normally due to AGP 2X (3.3V) is not supported by the chipset.

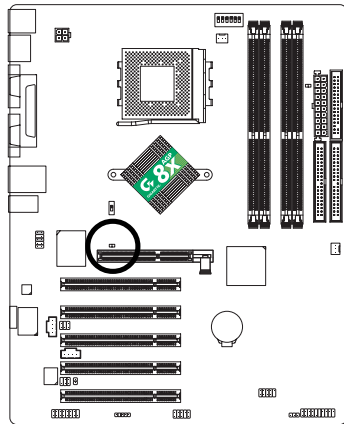

### 12) F\_AUDIO (Front Audio Connector)

If you want to use Front Audio connector, you must remove 5-6, 9-10 Jumper. In order to utilize the front audio header, your chassis must have front audio connector. Also please make sure the pin assignment on the cable is the same as the pin assignment on the MB header. To find out if the chassis you are buying support front audio connector, please contact your dealer. Please note, you can have the alternative of using front audio connector or of using rear audio connector to play sound.

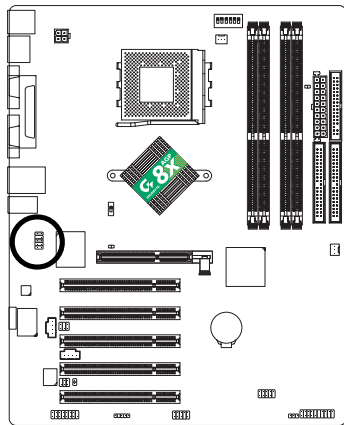

Pin No.	Definition
1	MIC
2	GND
3	REF
4	Power
5	Front Audio (R)
6	Rear Audio (R)
7	Reserved
8	No Pin
9	Front Audio (L)
10	Rear Audio (L)

### 13) SUR\_CEN (Surround Center Connector)

Please contact your nearest dealer for optional SUR\_CEN cable.

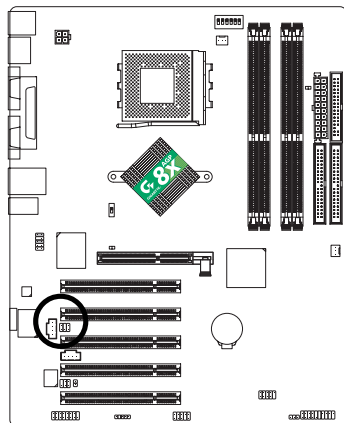

Pin No.	Definition
1	SUR OUTL
2	SUR OUTR
3	GND
4	No Pin
5	CENTER_OUT
6	BASS_OUT

#### 14) SPDIF\_IO (SPDIF In / Out Connector)

The SPDIF output is capable of providing digital audio to external speakers or compressed AC3 data to an external Dolby Digital Decoder. Use this feature only when your stereo system has digital input function. Use SPDIF IN feature only when your device has digital output function. Be careful with the polarity of the SPDIF\_IO connector. Check the pin assignment carefully while you connect the SPDIF\_IO cable, incorrect connection between the cable and connector will make the device unable to work or even damage it. For optional SPDIF\_IO cable, please contact your local dealer.

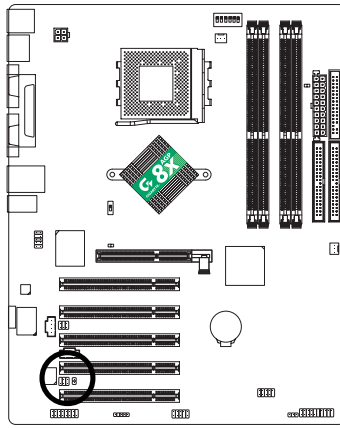

Pin No.	Definition
1	VCC
2	No Pin
3	SPDIF
4	SPDIF I
5	GND
6	GND

#### 15) CD\_IN (CD In Connector)

Connect CD-ROM or DVD-ROM audio out to the connector.

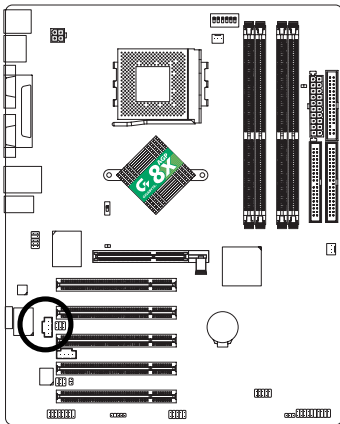

Pin No.	Definition
1	CD-L
2	GND
3	GND
4	CD-R

### 16) AUX\_IN (AUX In Connector)

Connect other device (such as PCI TV Tuner audio out) to the connector.

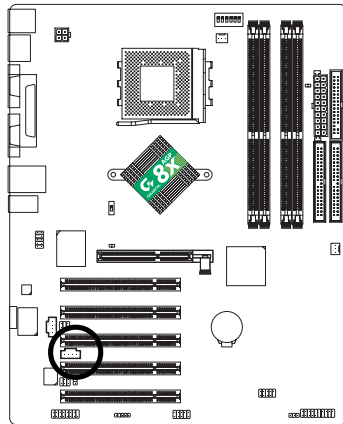

Pin No.	Definition
1	AUX-L
2	GND
3	GND
4	AUX-R

### 17) F\_USB (Front USB Connector, Yellow)

Be careful with the polarity of the front USB connector. Check the pin assignment while you connect the front USB cable. Please contact your nearest dealer for optional front USB cable.  
 Be careful with the polarity of the F\_USB connector. Check the pin assignment carefully while you connect the F\_USBCable, incorrect connection between the cable and connector will make the device unable to work or even damage it. For optional F\_USB cable, please contact your local dealer.

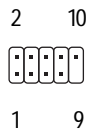
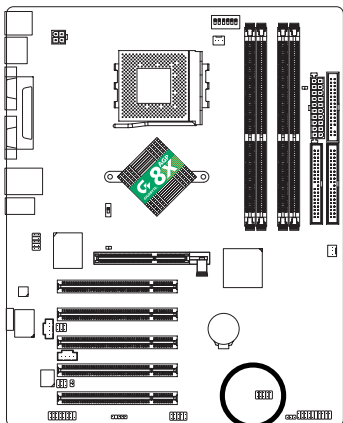

Pin No.	Definition
1	Power
2	Power
3	USB Dx-
4	USB Dy-
5	USB Dx+
6	USB Dy+
7	GND
8	GND
9	No Pin
10	NC

### 18) IR

Make sure the pin 1 on the IR device is along with pin one the connector. To enable the IR function on the board, you are required to purchase an option IR module. Be careful with the polarity of the IR connector. For optional IR cable, please contact your local dealer.

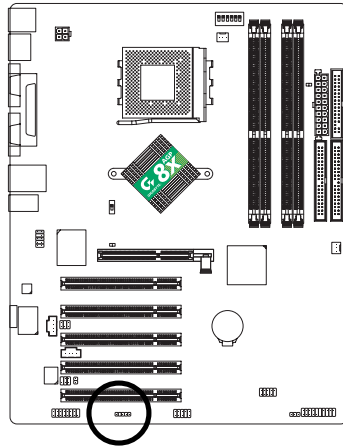

IR



Pin No.	Definition
1	VCC(+5V)
2	No Pin
3	IR Data Input
4	GND
5	IR Data Output

### 19) GAME (Game Connector)

This connector supports joystick, MIDI keyboard and other relate audio devices. Check the pin assignment while you connect the game cables. Please contact your nearest dealer for optional game cables.

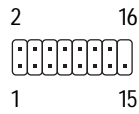
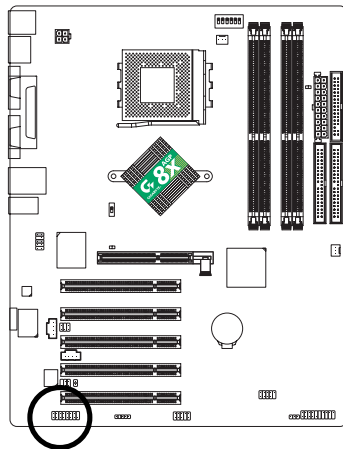

Pin No.	Definition
1	VCC
2	GRX1_R
3	GND
4	GPSA2
5	VCC
6	GPX2_R
7	GPY2_R
8	MSL_R
9	GPSA1
10	GND
11	GPY1_R
12	VCC
13	GPSB1
14	MSO_R
15	GPSB2
16	No Pin



## 20) INFO\_LINK

This connector allows you to connect some external devices to provide you extra function. Check the pin assignment while you connect the external device cable. Please contact your nearest dealer for optional external device cable.

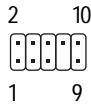
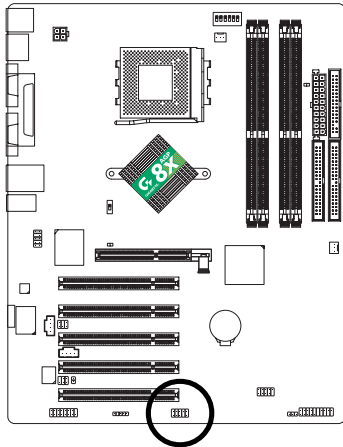

Pin No.	Definition
1	SMBCLK
2	VCC
3	SMBDATA
4	GPIO
5	GND
6	GND
7	No Pin
8	NC
9	+12V
10	+12V

## 21) CI (CASE OPEN)

This 2-pin connector allows your system to enable or disable the "Case Open" item in BIOS, if the system case begin remove.

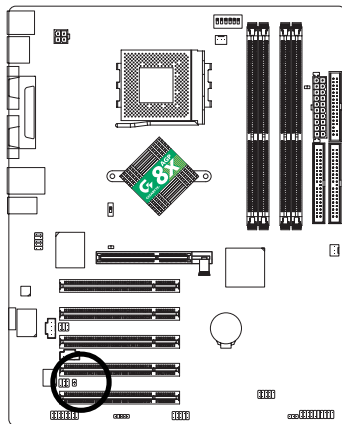

Pin No.	Definition
1	Signal
2	GND



## Chapter 3 BIOS Setup

BIOS Setup is an overview of the BIOS Setup Program. The program that allows users to modify the basic system configuration. This type of information is stored in battery-backed CMOS RAM so that it retains the Setup information when the power is turned off.

### ENTERING SETUP

Powering ON the computer and pressing <Del> immediately will allow you to enter Setup. If you require more advanced BIOS settings, please go to "Advanced BIOS" setting menu. To enter Advanced BIOS setting menu, press "Ctrl+F1" key on the BIOS screen.

### CONTROL KEYS

<↑>	Move to previous item
<↓>	Move to next item
<←>	Move to the item in the lefthand
<→>	Move to the item in the righthand
Enter	Select item
<Esc>	Main Menu - Quit and not save changes into CMOS Status Page Setup Menu and Option Page Setup Menu - Exit current page and return to Main Menu
<+/PgUp>	Increase the numeric value or make changes
<-/PgDn>	Decrease the numeric value or make changes
<F1>	General help, only for Status Page Setup Menu and Option Page Setup Menu
<F2>	Item Help
<F3>	Reserved
<F4>	Reserved
<F5>	Restore the previous CMOS value from CMOS, only for Option Page Setup Menu
<F6>	Load the file-safe default CMOS value from BIOS default table
<F7>	Load the Optimized Defaults
<F8>	Dual BIOS/Q-Flash function
<F9>	System Information
<F10>	Save all the CMOS changes, only for Main Menu

## GETTING HELP

### Main Menu

The on-line description of the highlighted setup function is displayed at the bottom of the screen.

### Status Page Setup Menu/ Option Page Setup Menu

Press F1 to pop up a small help window that describes the appropriate keys to use and the possible selections for the highlighted item. To exit the Help Window press <Esc>.

## The Main Menu (For example: BIOS Ver. : E2)

Once you enter Award BIOS CMOS Setup Utility, the Main Menu (Figure 1) will appear on the screen. The Main Menu allows you to select from eight setup functions and two exit choices. Use arrow keys to select among the items and press <Enter> to accept or enter the sub-menu.

CMOS Setup Utility-Copyright (C) 1984-2003 Award Software

▶ Standard CMOS Features	▶ Frequency/Voltage Control
▶ Advanced BIOS Features	Load Fail-Safe Defaults
▶ Advanced Chipset Features	Load Optimized Defaults
▶ Integrated Peripherals	Set Supervisor Password
▶ Power Management Setup	Set User Password
▶ PnP/PCI Configurations	Save & Exit Setup
▶ PC Health Status	Exit Without Saving
ESC: Quit	↑↓→←: Select Item
F8: Dual BIOS / Q-Flash	F10: Save & Exit Setup
Time, Date, Hard Disk Type...	

Figure 1: Main Menu



If you can't find the setting you want, please press "Ctrl+F1" to search the advanced option widden.

- **Standard CMOS Features**  
This setup page includes all the items in standard compatible BIOS.
- **Advanced BIOS Features**  
This setup page includes all the items of Award special enhanced features.

- **Advanced Chipset Features**  
This setup page includes all the items of Chipset special enhanced features.
- **Integrated Peripherals**  
This setup page includes all onboard peripherals.
- **Power Management Setup**  
This setup page includes all the items of Green function features.
- **PnP/PCI Configurations**  
This setup page includes all the configurations of PCI & PnP ISA resources.
- **PC Health Status**  
This setup page is the System auto detect Temperature, voltage, fan, speed.
- **Frequency/Voltage Control**  
This setup page is control CPU's clock and frequency ratio.
- **Load Fail-Safe Defaults**  
Fail-Safe Defaults indicates the value of the system parameters which the system would be in safe configuration.
- **Load Optimized Defaults**  
Optimized Defaults indicates the value of the system parameters which the system would be in best performance configuration.
- **Set Supervisor password**  
Change, set, or disable password. It allows you to limit access to the system and Setup, or just to Setup.
- **Set User password**  
Change, set, or disable password. It allows you to limit access to the system.
- **Save & Exit Setup**  
Save CMOS value settings to CMOS and exit setup.
- **Exit Without Saving**  
Abandon all CMOS value changes and exit setup.

## Standard CMOS Features

CMOS Setup Utility-Copyright (C) 1984-2003 Award Software

### Standard CMOS Features

Date (mm:dd:yy)	Tue, May 20 2003	Item Help
Time (hh:mm:ss)	22:31:24	Menu Level ► Change the day, month, year
►IDE Primary Master	[None]	<Week> Sun. to Sat.
►IDE Primary Slave	[None]	
►IDE Secondary Master	[None]	
►IDE Secondary Slave	[None]	
Drive A	[1.44M, 3.5"]	<Month> Jan. to Dec.
Drive B	[None]	
Floppy 3 Mode Support	[Disabled]	
Halt On	[All, But Keyboard]	<Day> 1 to 31 (or maximum allowed in the month)
Base Memory	640K	
Extended Memory	95M	<Year> 1999 to 2098
Total Memory	96M	
↑↓→←: Move Enter:Select +/-/PU/PD: Value F10: Save ESC:Exit F1: General Help F5: Previous Values F6: Fail-Safe Defaults F7: Optimized Defaults		

Figure 2: Standard CMOS Features

### ☞ Date

The date format is <week>, <month>, <day>, <year>.

- Week The week, from Sun to Sat, determined by the BIOS and is display only
- Month The month, Jan. Through Dec.
- Day The day, from 1 to 31 (or the maximum allowed in the month)
- Year The year, from 1999 through 2098

### ☞ **Time**

The times format in <hour> <minute> <second>. The time is calculated base on the 24-hour military-time clock. For example, 1 p.m. is 13:00:00.

### ☞ **IDE Primary Master, Slave / IDE Secondary Master, Slave**

The category identifies the types of hard disk from drive C to F that has been installed in the computer. There are two types: auto type, and manual type. Manual type is user-definable; Auto type which will automatically detect HDD type.

Note that the specifications of your drive must match with the drive table. The hard disk will not work properly if you enter improper information for this category.

If you select User Type, related information will be asked to enter to the following items. Enter the information directly from the keyboard and press <Enter>. Such information should be provided in the documentation form your hard disk vendor or the system manufacturer.

- ▶▶ CYLS.            Number of cylinders
- ▶▶ HEADS            Number of heads
- ▶▶ PRECOMP        Write precomp
- ▶▶ LANDZONE        Landing zone
- ▶▶ SECTORS         Number of sectors

If a hard disk has not been installed select NONE and press <Enter>.

### ☞ **Drive A/Drive B**

The category identifies the types of floppy disk drive A or drive B that has been installed in the computer.

- ▶▶ None            No floppy drive installed
- ▶▶ 360K, 5.25"      5.25 inch PC-type standard drive; 360K byte capacity.
- ▶▶ 1.2M, 5.25"      5.25 inch AT-type high-density drive; 1.2M byte capacity  
(3.5 inch when 3 Mode is Enabled).
- ▶▶ 720K, 3.5"        3.5 inch double-sided drive; 720K byte capacity
- ▶▶ 1.44M, 3.5"      3.5 inch double-sided drive; 1.44M byte capacity.
- ▶▶ 2.88M, 3.5"      3.5 inch double-sided drive; 2.88M byte capacity.

### ☞ **Floppy 3 Mode Support (for Japan Area)**

- ▶ Disabled Normal Floppy Drive. (Default value)
- ▶ Drive A Drive A is 3 mode Floppy Drive.
- ▶ Drive B Drive B is 3 mode Floppy Drive.
- ▶ Both Drive A & B are 3 mode Floppy Drives.

### ☞ **Halt on**

The category determines whether the computer will stop if an error is detected during power up.

- ▶ NO Errors The system boot will not stop for any error that may be detected and you will be prompted.
- ▶ All Errors Whenever the BIOS detects a non-fatal error the system boot will be stopped.
- ▶ All, But Keyboard The system boot will not stop for all errors except a keyboard error. (Default value)
- ▶ All, But Diskette The system boot will not stop for all errors except a disk error.
- ▶ All, But Disk/Key The system boot will not stop for all errors except keyboard and disk errors.

### ☞ **Memory**

The category is display-only which is determined by POST (Power On Self Test) of the BIOS.

#### **Base Memory**

The POST of the BIOS will determine the amount of base (or conventional) memory installed in the system.

The value of the base memory is typically 512 K for systems with 512K memory installed on the motherboard, or 640 K for systems with 640 K or more memory installed on the motherboard.

#### **Extended Memory**

The BIOS determines how much extended memory is present during the POST.

This is the amount of memory located above 1MB in the CPU's memory address map.



## Advanced BIOS Features

CMOS Setup Utility-Copyright (C) 1984-2003 Award Software

### Advanced BIOS Features

First Boot Device	[Floppy]	Item Help
Second Boot Device	[HDD-0]	Menu Level ►
Third Boot Device	[CDROM]	Select onboard RAID or
x SATA/RAID/SCSI Boot Order	SCSI	PCI SCSI boot rom
Boot Up Floppy Seek	[Disabled]	order
Flexible AGP 8X	[Auto]	
Init Display First	[PCI]	
↑↓→←: Move    Enter:Select    +/-/PU/PD: Value    F10: Save    ESC:Exit    F1: General Help F5: Previous Values    F6: Fail-Safe Defaults    F7: Optimized Defaults		

Figure 3: Advanced BIOS Features

### ☞ First / Second / Third Boot Device

- ☛ Floppy            Select your boot device priority by Floppy.
- ☛ LS120            Select your boot device priority by LS120.
- ☛ HDD 0~3         Select your boot device priority by Hard Disk 0~3.
- ☛ SCSI             Select your boot device priority by SCSI.
- ☛ CDROM          Select your boot device priority by CDROM.
- ☛ ZIP                Select your boot device priority by ZIP.
- ☛ USB-FDD         Select your boot device priority by USB-FDD.
- ☛ USB-ZIP         Select your boot device priority by USB-ZIP.
- ☛ USB-CDROM     Select your boot device priority by USB-CDROM.
- ☛ USB-HDD         Select your boot device priority by USB-HDD.
- ☛ LAN                Select your boot device priority by LAN.
- ☛ Disabled         Select your boot device priority by Disabled.

### ☞ **SATA/RAID/SCSI Boot Order**

This function will available when Boot up device set at "SCSI".

This feature allows you to select the boot order Serial ATA, RAID or SCSI device.

- ▶▶ SCSI                    Select your boot device priority by PCI SCSI.
- ▶▶ RAID                    Select your boot device priority by RAID.
- ▶▶ SATA                    Select your boot device priority by Serial ATA.

### ☞ **Boot Up Floppy Seek**

During POST, BIOS will determine the floppy disk drive installed is 40 or 80 tracks. 360K type is 40 tracks 720K, 1.2M and 1.44M are all 80 tracks.

- ▶▶ Enabled                BIOS searches for floppy disk drive to determine it is 40 or 80 tracks. Note that BIOS can not tell from 720K, 1.2M or 1.44M drive type as they are all 80tracks.
- ▶▶ Disabled                BIOS will not search for the type of floppy disk drive by track number. Note that there will not be any warning message if the drive installed is 360K. (Default value)

### ☞ **Flexible AGP8X**

- ▶▶ Auto                    Automatically set AGP transfer rate according to AGP compatibility and stability. (Default value)
- ▶▶ 4X                        Set AGP transfer rate to 4X mode no matter what the AGP transfer rate the card is.

### ☞ **Init Display First**

This feature allows you to select the first initiation of the monitor display from which card when you install an AGP card and a PCI VGA card on board.

- ▶▶ PCI                      Set initial display first to PCI slot. (Default value)
- ▶▶ AGP                      Set initial display first to AGP.

## Advanced Chipset Features

CMOS Setup Utility-Copyright (C) 1984-2003 Award Software

### Advanced Chipset Features

System Performance	[Normal]	Item Help
FSB Frequency	[133MHz]	Menu Level ▶
Memory Frequency	By SPD	
Resulting Frequency	266MHz	
AGP Frequency	[Normal]	[Normal] - Use the most stable settings.
		[Turbo] -Use over colocked settings for higher performance but with higher risk of instability.
↑↓→←: Move    Enter:Select    +/-/PU/PD: Value    F10: Save    ESC:Exit    F1: General Help F5: Previous Values    F6: Fail-Safe Defaults    F7: Optimized Defaults		

Figure 4: Advanced Chipset Features

### System Performance

- ▶ Normal            Set system at the most stable settings. (Default Value)
- ▶ Turbo            Use over colocked settings for higher performance but with higher risk of instability.
- ▶ Manual            Allows full customization of performance options.
- ⚠ Incorrect using it may cause your system to fail. For power End-User use only!

### FSB Frequency

- ▶ 100 MHz            Set FSB frequency at 100MHz.
- ▶ 133 MHz            Set FSB frequency at 133MHz. (Default Value)
- ▶ 166 MHz            Set FSB frequency at 166MHz.
- ▶ 200 MHz            Set FSB frequency at 200MHz.

**Memory Frequency**

- ▶ By SPD            Set memory frequency by SPD. (Default Value)
  - ▶ 50%~200%        Set the memory frequency manually.
  - ▶ Auto                Set the best memory frequency for system.
- ⚠ Incorrect using it may cause your system to fail. For power End-User use only!

**Resulting Frequency**

- ▶ The value depends on FSB/Memory Frequency.

**AGP Frequency**

- ▶ Normal            Set the best AGP frequency for system. (Default Value)
  - ▶ 50MHz~100MHz   Set the AGP frequency manually.
- ⚠ Incorrect using it may cause your system broken. For power End-User use only!

## Integrated Peripherals

CMOS Setup Utility-Copyright (C) 1984-2003 Award Software

### Integrated Peripherals

		Item Help
On-Chip Primary PCI IDE	[Enabled]	
On-Chip Secondary PCI IDE	[Enabled]	Menu Level ►
USB Host Controller	[V1.1+V2.0]	If a hard disk
USB Keyboard Support	[Disabled]	controller card is
USB Mouse Support	[Disabled]	used, set at Disabled
AC97 Audio	[Auto]	
Onboard LAN Chip(*)	[Enabled]	[Enabled]
Onboard LAN Boot ROM(*)	[Disabled]	Enabled onboard IDE
Onboard Serial Port 1	[3F8/IRQ4]	Port
Onboard Serial Port 2	[2F8/IRQ3]	
UART Mode Select	[Normal]	[Disabled]
x UR2 Duplex Mode	Half	Disabled onboard IDE
Onboard Parallel Port	[378/IRQ7]	Port
Parallel Port Mode	[ECP]	
ECP Mode Use DMA	[3]	
Game Port Address	[201]	
Midi Port Address	[330]	
Midi Port IRQ	[10]	

↑↓→←: Move    Enter:Select    +/-/PU/PD: Value    F10: Save    ESC:Exit    F1: General Help  
 F5: Previous Values    F6: Fail-Safe Defaults    F7: Optimized Defaults

Figure 5: Integrated Peripherals

(\*)For GA-7N400E-L only.

#### ☞ **On-Chip Primary PCI IDE**

- ▶ Enabled            Enable onboard 1st channel IDE port. (Default value)
- ▶ Disabled           Disable onboard 1st channel IDE port.

#### ☞ **On-Chip Secondary PCI IDE**

- ▶ Enabled            Enable onboard 2nd channel IDE port. (Default value)
- ▶ Disabled           Disable onboard 2nd channel IDE port.

#### ☞ **USB Host Controller**

- ▶ Disabled           Disable USB controller.
- ▶ V1.1+V2.0        Set USB controller at USB1.1 and USB2.0. (Default Value)
- ▶ V1.1                Set USB controller at USB1.1.

#### ☞ **USB Keyboard Support**

- ▶ Enabled            Enable USB Keyboard Support.
- ▶ Disabled           Disable USB Keyboard Support. (Default value)

#### ☞ **USB Mouse Support**

- ▶ Enabled            Enable USB Mouse Support.
- ▶ Disabled           Disable USB Mouse Support. (Default value)

#### ☞ **AC'97 Audio**

- ▶ Auto                Auto detect AC'97 audio function. (Default Value)
- ▶ Disabled           Disable AC'97 audio function.

#### ☞ **Onboard LAN chip(\*)**

- ▶ Enabled            Auto detect onborad LAN function. (Default Value)
- ▶ Disabled           Disable this function.

(\*)For GA-7N400E-L only.

### ☞ Onboard LAN Boot ROM(\*)

This function decide whether to invoke the boot ROM of the onboard LAN chip.

- ▶ Enabled            Enable Onboard LAN chip function.
- ▶ Disabled           Disable this function. (Default value)

### ☞ Onboard Serial Port 1

- ▶ Disabled            Disable onboard Serial port 1.
- ▶ 3F8/IRQ4            Enable onboard Serial port 1 and address is 3F8, using IRQ4. (Default value)
- ▶ 2F8/IRQ3            Enable onboard Serial port 1 and address is 2F8, using IRQ3.
- ▶ 3E8/IRQ4            Enable onboard Serial port 1 and address is 3E8, using IRQ4.
- ▶ 2E8/IRQ3            Enable onboard Serial port 1 and address is 2E8, using IRQ3.
- ▶ Auto                BIOS will automatically setup the port 1 address.

### ☞ Onboard Serial Port 2

- ▶ Disabled            Disable onboard Serial port 2.
- ▶ 3F8/IRQ4            Enable onboard Serial port 2 and address is 3F8, using IRQ4.
- ▶ 2F8/IRQ3            Enable onboard Serial port 2 and address is 2F8, using IRQ3. (Default value)
- ▶ 3E8/IRQ4            Enable onboard Serial port 2 and address is 3E8, using IRQ4.
- ▶ 2E8/IRQ3            Enable onboard Serial port 2 and address is 2E8, using IRQ3.
- ▶ Auto                BIOS will automatically setup the port 2 address.

### ☞ UARTMode Select

This item allows you to determine which Infra Red(IR) function of Onboard I/O chip.

- ▶ Normal              Set onboard I/O chip UART to Normal Mode. (Default Value)
- ▶ IrDA                Set onboard I/O chip UART to IrDA Mode.
- ▶ ASKIR              Set onboard I/O chip UART to ASKIR Mode.

(\*)For GA-7N400E-L only.

### UR2DuplexMode

This feature allows you to select IR mode.

This function will be available when "UART Mode Select" is not set at "Normal" nor "SCR".

- ▶▶ Half IR Function Duplex Half. (Default Value)
- ▶▶ Full IR Function Duplex Full.

### OnboardParallel port

This feature allows you to select from a given set of parameters if the parallel port uses the onboard I/O controller.

- ▶▶ Disabled Disable onboard LPT port.
- ▶▶ 378/IRQ7 Enable onboard LPT port and address is 378, using IRQ7. (Default Value)
- ▶▶ 278/IRQ5 Enable onboard LPT port and address is 278, using IRQ5.
- ▶▶ 3BC/IRQ7 Enable onboard LPT port and address is 3BC, using IRQ7.

### ParallelPort Mode

This feature allows you to connect with an advanced printer via the port mode it supports.

- ▶▶ SPP Using Parallel port as Standard Parallel Port.
- ▶▶ EPP Using Parallel port as Enhanced Parallel Port.
- ▶▶ ECP Using Parallel port as Extended Capabilities Port. (Default Value)
- ▶▶ ECP+EPP Using Parallel port as ECP & EPP mode.

### ECPMode UseDMA

This feature allows you to select Direct Memory Access(DMA) channel if the ECP mode is selected.

This function will be available when "Parallel Port Mode" is set at ECP or ECP+EPP.

- ▶▶ 3 Set ECP Mode Use DMA to 3. (Default Value)
- ▶▶ 1 Set ECP Mode Use DMA to 1.

### Game Port Address

- ▶▶ Disabled Disable this function.
- ▶▶ 201 Set Game Port Address to 201. (Default Value)
- ▶▶ 209 Set Game Port Address to 209.



**Midi Port Address**

- ▶ Disabled      Disable this function.
- ▶ 330            Set Midi Port Address to 330. (Default Value)
- ▶ 300            Set Midi Port Address to 300.

**Midi Port IRQ**

- ▶ 5              Set Midi Port IRQ to 5.
- ▶ 10             Set Midi Port IRQ to 10. (Default Value)

## Power Management Setup

CMOS Setup Utility-Copyright (C) 1984-2003 Award Software

### Power Management Setup

ACPI Suspend Type	[S1(POS)]	Item Help
Soft-Off by PWR-BTTN	[Instant-off]	Menu Level ►
PME Event Wake Up	[Enabled]	[S1]
ModemRingOn	[Enabled]	Set suspend type to
S3 Resume by USB	[Disabled]	Power On Suspend under
Resume by Alarm	[Disabled]	ACPI OS
x Date (ofMonth) Alarm	Everyday	
x Time (hh:mm:ss) Alarm	0 : 0 : 0	[S3]
Power On by Mouse	[Disabled]	Set suspend type to
Power On by Keyboard	[Disabled]	Suspend to RAM under
x KB Power ON Password	Enter	ACPI OS
AC Back Function	[Soft-Off]	
↑↓→←: Move    Enter:Select    +/-/PU/PD: Value    F10: Save    ESC:Exit    F1: General Help F5: Previous Values    F6: Fail-Safe Defaults    F7: Optimized Defaults		

Figure 6: Power Management Setup

#### ⤵ ACPI Suspend Type

- ▶ S1(POS)      Set ACPI suspend type to S1. (Default Value)
- ▶ S3(STR)      Set ACPI suspend type to S3.

#### ⤵ Soft-Off by PWR-BTTN

- ▶ Instant-off      Press power button then Power off instantly. (Default value)
- ▶ Delay 4 Sec.      Press power button 4 sec. to Power off. Enter suspend if button is pressed less than 4 sec.

**PMEEvent Wake Up**

- ▶ Disabled      Disable this function.
- ▶ Enabled      Enable PME Event Wake up. (Default Value)

**ModemRingOn**

An incoming call via modem can awake the system from any suspend state .

- ▶ Disabled      Disable Modem Ring on function.
- ▶ Enabled      Enable Modem Ring on function. (Default Value)

**S3 Resume by USB**

You can resume the system from USB device.

- ▶ Disabled      Disable this function. (Default Value)
- ▶ Enabled      Enable this function.

**Resume by Alarm**

You can set "Resume by Alarm" item to enabled and key in Date/time to power on system.

- ▶ Disabled      Disable this function. (Default Value)
- ▶ Enabled      Enable alarm function to POWER ON system.  
If RTC Alarm Lead To Power On is Enabled.  
Date (of Month) Alarm : Everyday, 1~31  
Time (hh: mm: ss) Alarm : (0~23) : (0~59) : (0~59)

**PowerOn By Mouse**

- ▶ Disabled      Disabled this function. (Default value)
- ▶ Mouse Click      Double click on PS/2 mouse left button to power on the system.

### ☞ **PowerOnByKeyboard**

This feature allows you to set the method for powering-on the system.

The option "Password" allows you to set up to 5 alphanumeric characters to power-on the system.

The option "Keyboard 98" allows you to use the standard keyboard 98 to power on the system.

- ▶ Password            Enter from 1 to 5 characters to set the Keyboard Power On Password.
- ▶ Disabled            Disabled this function. (Default value)
- ▶ Keyboard 98        If your keyboard have "POWER Key" button, you can press the key to power on the system.

### ☞ **KB PowerONPassword**

When "Power On by Keyboard" set at Password, you can set the password here.

- ▶ Enter                Input password (from 1 to 5 characters) and press Enter to set the Keyboard Power On password.

### ☞ **ACBACKFunction**

- ▶ Soft-Off            When AC-power back to the system, the system will be in "Off" state. (Default Value)
- ▶ Full-On             When AC-power back to the system, the system always in "On" state.
- ▶ Memory             When AC-power back to the system, the system will return to the Last state before AC-power off.

## PnP/PCI Configurations

CMOS Setup Utility-Copyright (C) 1984-2003 Award Software

PnP/PCI Configurations		
PCI 1/PCI 5 IRQ Assignment	[Auto]	Item Help
PCI 2 IRQ Assignment	[Auto]	Menu Level ►
PCI 3 IRQ Assignment	[Auto]	Device(s) using this
PCI 4 IRQ Assignment	[Auto]	INT :
		Network Cntrl - Bus 1 Dev 11 Func 0
↑↓→←: Move    Enter:Select    +/-/PU/PD: Value    F10: Save    ESC:Exit    F1: General Help F5: Previous Values    F6: Fail-Safe Defaults    F7: Optimized Defaults		

Figure 7: PnP/PCI Configurations

### ☞ PCI1/PCI5 IRQ Assignment

- ▶ Auto                      Auto assign IRQ to PCI 1/PCI 5. (Default value)
- ▶ 3,4,5,7,9,10,11,12,14,15    Set IRQ 3,4,5,7,9,10,11,12,14,15 to PCI 1/PCI 5.

### ☞ PCI2 IRQ Assignment

- ▶ Auto                      Auto assign IRQ to PCI 2. (Default value)
- ▶ 3,4,5,7,9,10,11,12,14,15    Set IRQ 3,4,5,7,9,10,11,12,14,15 to PCI 2.

### ☞ PCI3 IRQ Assignment

- ▶ Auto                      Auto assign IRQ to PCI 3. (Default value)
- ▶ 3,4,5,7,9,10,11,12,14,15    Set IRQ 3,4,5,7,9,10,11,12,14,15 to PCI 3.

### ☞ PCI4 IRQ Assignment

- ▶ Auto                      Auto assign IRQ to PCI 4. (Default value)
- ▶ 3,4,5,7,9,10,11,12,14,15    Set IRQ 3,4,5,7,9,10,11,12,14,15 to PCI 4.

## PC Health Status

CMOS Setup Utility-Copyright (C) 1984-2003 Award Software

### PC Health Status

Reset Case Open Status	[Disabled]	Item Help
Case Opened	Yes	Menu Level ►
Vcore	OK	[Disabled]
DDR25V	OK	Don't reset case
+3.3V	OK	open status
+5V	OK	
+12V	OK	[Enabled]
Current System Temperature	32°C	Clear case open
Current CPU Temperature	34°C	status at next boot
Current CPU FAN Speed	4687 RPM	
Current SYSTEM FAN Speed	0 RPM	
CPU Warning Temperature	[Disabled]	
CPU FAN Fail Warning	[Disabled]	
SYSTEM FAN Fail Warning	[Disabled]	
↑↓→←: Move    Enter:Select    +/-/PU/PD: Value    F10: Save    ESC:Exit    F1: General Help F5: Previous Values    F6: Fail-Safe Defaults    F7: Optimized Defaults		

Figure 8: PC Health Status

### Reset Case Open Status

- Disabled            Don't reset case open status. (Default value)
- Enabled            Clear case open status at next boot.

### Case Opened

If the case is closed, "Case Opened" will show "No".

If the case have been opened, "Case Opened" will show "Yes".

If you want to reset "Case Opened" value, set "Reset Case Open Status" to "Enabled" and save CMOS, your computer will restart.

☞ **Current Voltage (V) Vcore /DDR25V / +3.3V / +5V / +12V**

▶▶ Detect system's voltage status automatically.

☞ **Current System Temperature**

▶▶ Detect System temperature automatically.

☞ **Current CPU Temperature**

▶▶ Detect CPU temperature automatically.

☞ **Current CPU/SYSTEMFAN Speed (RPM)**

▶▶ Detect CPU/SYSTEM Fan speed status automatically.

☞ **CPU Warning Temperature**

▶▶ 60°C / 140°F Monitor CPU Temp. at 60°C / 140°F.

▶▶ 70°C / 158°F Monitor CPU Temp. at 70°C / 158°F.

▶▶ 80°C / 176°F Monitor CPU Temp. at 80°C / 176°F.

▶▶ 90°C / 194°F Monitor CPU Temp. at 90°C / 194°F.

▶▶ Disabled Disable this function.(Default value)

☞ **CPUFAN Fail Warning**

▶▶ Disabled Fan Warning Function Disable. (Default value)

▶▶ Enabled Fan Warning Function Enable.

☞ **SYSTEMFAN Fail Warning**

▶▶ Disabled Fan Warning Function Disable. (Default value)

▶▶ Enabled Fan Warning Function Enable.

## Frequency/Voltage Control

CMOS Setup Utility-Copyright (C) 1984-2003 Award Software

### Frequency/Voltage Control

VCORE OverVoltage Control	[Normal]	Item Help
DIMM OverVoltage Control	[Normal]	Menu Level ►
AGP OverVoltage Control	[Normal]	
↑↓→←: Move    Enter:Select    +/-/PU/PD: Value    F10: Save    ESC:Exit    F1: General Help F5: Previous Values    F6: Fail-Safe Defaults    F7: Optimized Defaults		

Figure 9: Frequency/Voltage Control

#### ☞ VCORE OverVoltage Control

Increase VCORE voltage may get stable for Over\_Clock. But it may damage to CPU when enable this feature.

- ▶ Normal                      Supply voltage as CPU required. (Default value)
- ▶ +5% / +7.5% / +10%      Increase voltage range as user selected.

#### ☞ DIMM OverVoltage Control

- ▶ Normal                      Set DIMM OverVoltage Control to Normal. (Default value)
- ▶ +0.1V                        Set DIMM OverVoltage Control to +0.1V.
- ▶ +0.2V                        Set DIMM OverVoltage Control to +0.2V.

⚠ Incorrect using it may cause your system to fail. For power End-User use only!

#### ☞ AGP OverVoltage Control

- ▶ Normal                      Set AGP OverVoltage Control to Normal. (Default value)
- ▶ +0.1V                        Set AGP OverVoltage Control to +0.1V.
- ▶ +0.2V                        Set AGP OverVoltage Control to +0.2V.
- ▶ +0.3V                        Set AGP OverVoltage Control to +0.3V.

⚠ Incorrect using it may cause your system to fail. For power End-User use only!



## Load Fail-Safe Defaults

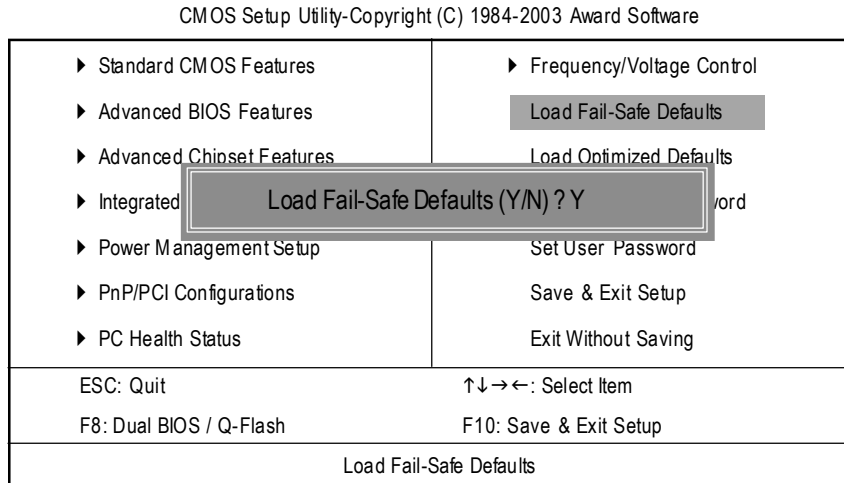

Figure 10: Load Fail-Safe Defaults

### Load Fail-Safe Defaults

Fail-Safe defaults contain the most appropriate values of the system parameters that allow minimum system performance.





## Save & Exit Setup

CMOS Setup Utility-Copyright (C) 1984-2003 Award Software

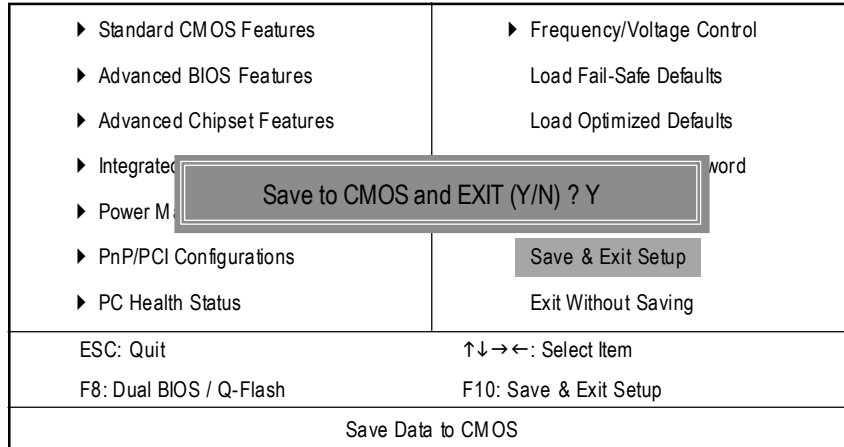

Figure 13: Save & Exit Setup

Type "Y" will quit the Setup Utility and save the user setup value to RTC CMOS.

Type "N" will return to Setup Utility.

## Exit Without Saving

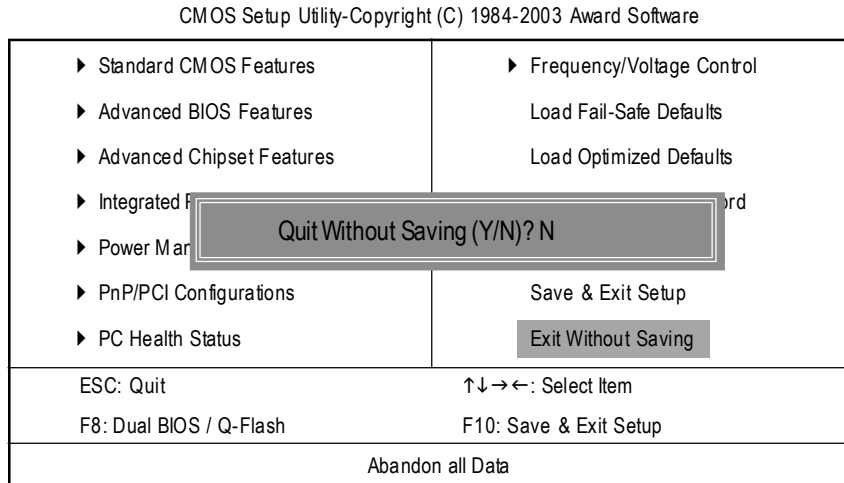

Figure 14: Exit Without Saving

Type "Y" will quit the Setup Utility without saving to RTC CMOS.

Type "N" will return to Setup Utility.









### Load BIOS From Floppy

 In the A: drive, insert the "BIOS" diskette, then Press Enter to Run.

1 File(s) found		
XXXX.XX	256K	
Total Size: 1.39M	Free Size: 1.14M	
F5: Refresh	DEL: Delete	ESC: Return Main

Where XXXX.XX is name of the BIOS file.

 Press Enter to Run.

Are you sure to update BIOS?  
[Enter] to contiune Or [ESC] of abort..

 Press Enter to Run.

!! COPY BIOS Completed -Pass !!  
Please press any key to continue

Congratulation! You have completed the flashed and now can restart system.



**Method 2:**

If you don't have DOS boot disk, we recommend that you used Gigabyte @BIOS™ program to flash BIOS.

Follow the setup that showing on the screen to install the Utility.



(1)

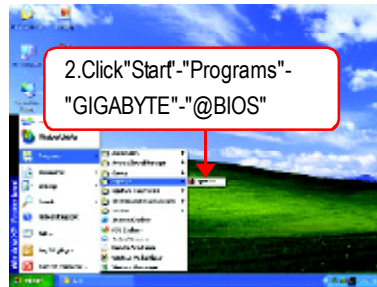

(2)



(3)

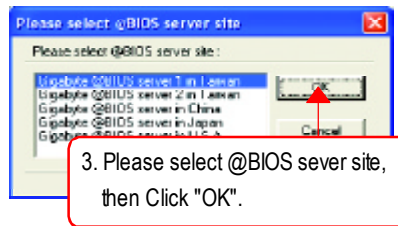

(4)

**Methods and steps:**

- I. Update BIOS through Internet
  - a. Click "Internet Update" icon
  - b. Click "Update New BIOS" icon
  - c. Select @BIOS™ sever
  - d. Select the exact modelname on your motherboard
  - e. System will automatically download and update the BIOS.

## II. Update BIOS NOT through Internet

- a. Do not click "Internet Update" icon
- b. Click "Update New BIOS"
- c. Please select "All Files" in dialog box while opening the old file.
- d. Please search for BIOS unzip file, downloading from internet or any other methods (such as: 7N400E.F1).
- e. Complete update process following the instruction.

## III. Save BIOS

In the very beginning, there is "Save Current BIOS" icon shown in dialog box. It means to save the current BIOS version.

## IV. Check out supported motherboard and Flash ROM:

In the very beginning, there is "About this program" icon shown in dialog box. It can help you check out which kind of motherboard and which brand of Flash ROM are supported.

### Note:

- a. In method I, if it shows two or more motherboard's model names to be selected, please make sure your motherboard's model name again. Selecting wrong model name will cause the system unbooted.
- b. In method II, be sure that motherboard's model name in BIOS unzip file are the same as your motherboard's. Otherwise, your system won't boot.
- c. In method I, if the BIOS file you need cannot be found in @BIOS™ server, please go onto Gigabyte's web site for downloading and updating it according to method II.
- d. Please note that any interruption during updating will cause system unbooted.

## @ BIOS Introduction

### Gigabyte announces @ BIOS Windows BIOS live update utility



Have you ever updated BIOS by yourself? Or like many other people, you just know what BIOS is, but always hesitate to update it? Because you think updating newest BIOS is unnecessary and actually you don't know how to update it.

Maybe not like others, you are very experienced in BIOS updating and spend quite a lot of time to do it. But of course you don't like to do it too much. First, download different BIOS from website and then switch the operating system to DOS mode. Secondly, use different flash utility to update BIOS. The above process is not a interesting job. Besides, always be carefully to store the BIOS source code correctly in your disks as if you update the wrong BIOS, it will be a nightmare.

Certainly, you wonder why motherboard vendors could not just do something right to save your time and effort and save you from the lousy BIOS updating work? Here it comes! Now Gigabyte announces @BIOS—the first Windows BIOS live update utility. This is a smart BIOS update software. It could help you to download the BIOS from internet and update it. Not like the other BIOS update software, it's a Windows utility. With the help of '@BIOS', BIOS updating is no more than a click.

Besides, no matter which mainboard you are using, if it's a Gigabyte's product\*, @BIOS help you to maintain the BIOS. This utility could detect your correct mainboard model and help you to choose the BIOS accordingly. It then downloads the BIOS from the nearest Gigabyte ftp site automatically. There are several different choices; you could use "Internet Update" to download and update your BIOS directly. Or you may want to keep a backup for your current BIOS, just choose "Save Current BIOS" to save it first. You make a wise choice to use Gigabyte, and @BIOS update your BIOS smartly. You are now worry free from updating wrong BIOS, and capable to maintain and manage your BIOS easily. Again, Gigabyte's innovative product erects a milestone in mainboard industries.

For such a wonderful software, how much it costs? Impossible! It's free! Now, if you buy a Gigabyte's motherboard, you could find this amazing software in the attached driver CD. But please remember, connected to internet at first, then you could have a internet BIOS update from your Gigabyte @BIOS.

## 2-/4-/6-Channel Audio Function Introduction

The installation of windows 98SE/2K/ME/XP is very simple. Please follow next step to install the function!

### Stereo Speakers Connection and Settings:

We recommend that you use the speaker with amplifier to acquire the best sound effect if the stereo output is applied.

#### STEP 1:

Connect the stereo speakers or earphone to "Line Out".



Line Out

#### STEP 2 :

After installation of the audio driver, you'll find an  icon on the taskbar's status area. Click the audio icon "Sound Effect" from the windows tray at the bottom of the screen.



#### STEP 3:

Select "Speaker Configuration", and choose the "2 channel for stereo speakers output".

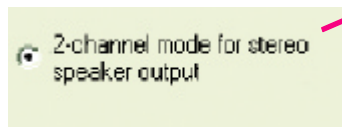

### 4 Channel Analog Audio Output Mode

STEP 1 :

Connect the front channels to "Line Out",  
the rear channels to "Line In".

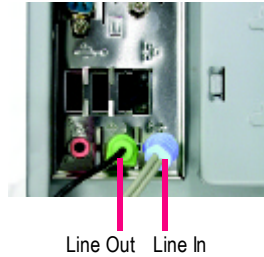

STEP 2 :

After installation of the audio driver, you'll find an  icon on the taskbar's status area. Click the audio icon "Sound Effect" from the windows tray at the bottom of the screen.

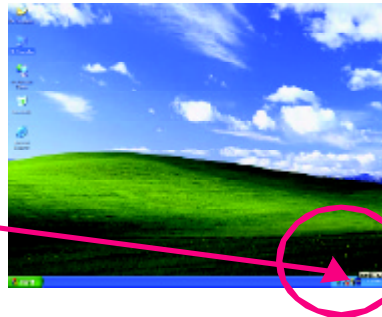

STEP 3 :

Select "Speaker Configuration", and choose the "4 channel for 4 speakers output".  
Disable "Only SURROUND-KIT", and press "OK".

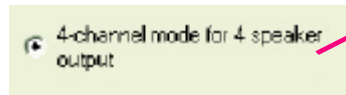

When the "Environment settings" is "None", the sound would be performed as stereo mode (2 channels output). Please select the other settings for 4 channels output.

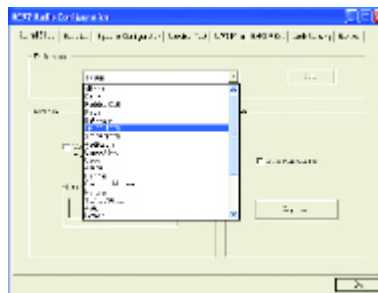

### Basic 6 Channel Analog Audio Output Mode

Use the back audio panel to connect the audio output without any additional module.

STEP 1 :

Connect the front channels to "Line Out", the rear channels to "Line In", and the Center/Subwoofer channels to "MIC In".

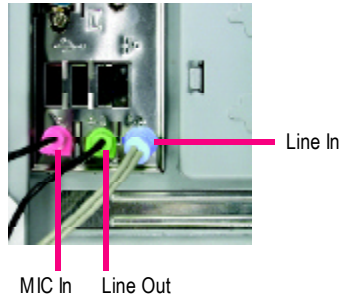

STEP 2 :

After installation of the audio driver, you'll find an  icon on the taskbar's status area. Click the audio icon "Sound Effect" from the windows tray at the bottom of the screen.

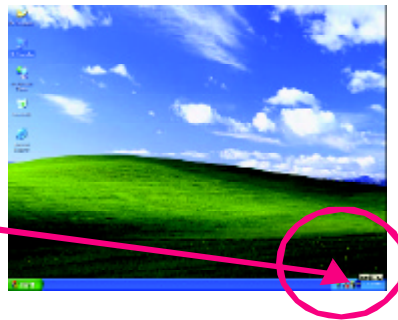

STEP 3 :

Select "Speaker Configuration", and choose the "6 channel for 5.1 speakers output".

Disable "Only SURROUND-KIT" and press "OK".

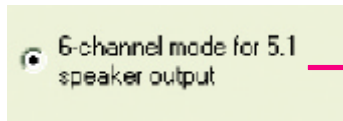

**Advanced 6 Channel Analog Audio Output Mode (using Audio Combo Kit, Optional Device):**

(Audio Combo Kit provides SPDIF output port : optical & coaxial and SURROUND-KIT : Rear R/L & CEN / Subwoofer)

SURROUND-KIT access analog output to rear channels and Center/Subwoofer channels. It is the best solution if you need 6 channel output, Line In and MIC at the same time. "SURROUND-KIT" is included in the GIGABYTE unique "Audio Combo Kit" as picture.

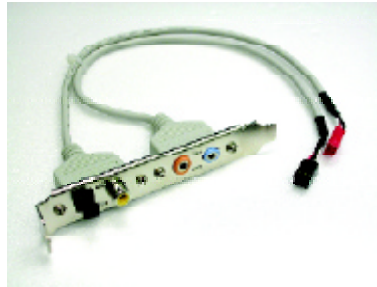

**STEP 1 :**

Insert the "SURROUND-KIT" in the back of the case , and fix it with the screw.



**STEP 2 :**

Connect the "SURROUND-KIT" to SUR\_CEN on the M/B.

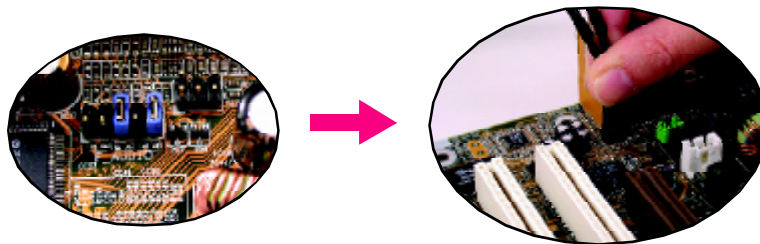



**STEP 3 :**

Connect the frontchannels to back audio panel's "Line Out", the rear channels to SURROUND-KIT's REAR R/L, and the Center/Subwoofer channels to SURROUND-KIT's SUB CENTER.

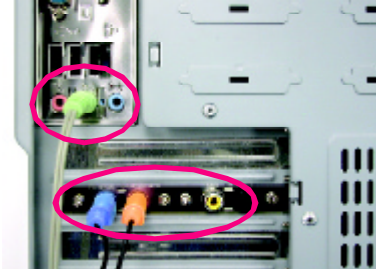

**STEP 4 :**

Click the audio icon "Sound Effect" from the windows tray at the bottom of the screen.



**STEP 5 :**

Select "Speaker Configuration", and choose the "6 channels for 5.1 speakers output". Enable "Only SURROUND-KIT" and press "OK".

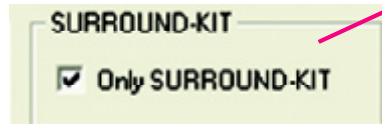

**Basic & Advanced 6 Channel Analog Audio Output ModeNotes:**

When the "Environment settings" is "None", the sound would be performed as stereo mode(2 channels output). Please select the other settings for 6 channels output.

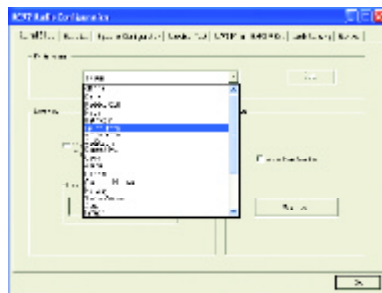

**SPDIF Output Device (Optional Device)**

A "SPDIF output" device is available on the motherboard. Cable with rear bracket is provided and could link to the "SPDIF output" connector (As picture.) For the further linkage to decoder, rear bracket provides coaxial cable and Fiber connecting port.

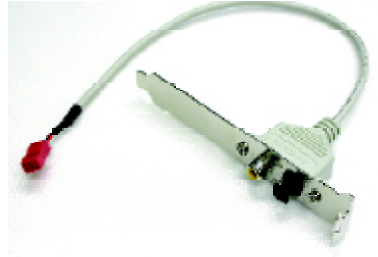

1. Connect the SPDIF output device to the rear bracket of PC, and fix it with screw.



2. Connect SPDIF device to the motherboard.

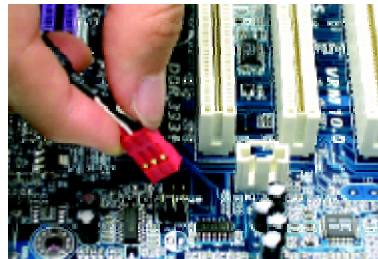

3. Connect SPDIF to the SPDIF decoder.

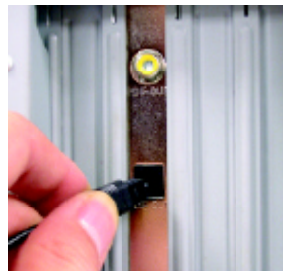

## Xpress Recovery Introduction

### What is Xpress Recovery?

Xpress Recovery utility is an utility for backing up and restoring O.S. partition . If the hard drive can not work properly, you can restore it to the original state.



1. It supports FAT16, FAT32, NTFS Operation System .
2. It does not work when you install Boot Manager .
3. It must be used with IDE hard disk supporting HPA .
4. The first partition must be set as the boot partition. When the boot partition is backed up, please do not change its size.
5. It must be connected to IDE1 Master .



1. System data and hard disk's reading/writing speed will affect backing up speed.
2. It is supported by Intel 865 / 875 chipset, nVIDIA nForce 2 chipset and SiS 648FX chipset based motherboard from Gigabyte.

### How to use the Xpress Recovery

a. There are two ways to enter the Xpress Recovery utility:

1. Press F9 during powering on the computer . (see the below)



F9 For Xpress Recovery

2. Please go to "Advanced BIOS" setting menu and set boot from CD-ROM, then save and exit the BIOS menu. Later, when "CD-ROM:" appears at the bottom of the screen, press any key to enter Xpress Recovery.

b. Xpress Recovery:

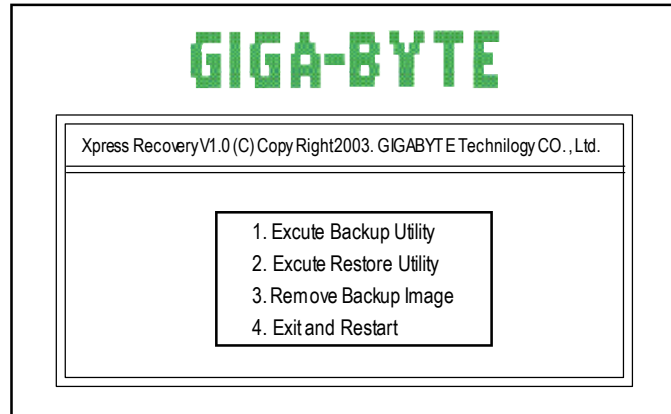

#### 1. Excute Backup Utility:

 **Press B to Backup your System or Esc to Exit**

The Backup utility will scan the system automatically and back it up.

The backed up data will be saved as a hidden image .

#### 2. Excute Restore Utility:

 **This program will recover your system to factory default.**

**Press R to recover your system.**

**Press Esc to exit**

Restore the backup image to the original state.

#### 3. Remove Backup Image:

 **Do you sure to remove backup image? (Y/N)**

Remove the backup image.

#### 4. Exit and Restart:

Exit and restart your computer.







## Chapter 5 Appendix

### Install Drivers



**Pictures below are shown in Windows XP**

Insert the driver CD-title that came with your motherboard into your CD-ROM drive, the driver CD-title will auto start and show the installation guide. If not, please double click the CD-ROM device icon in "My computer", and execute the setup.exe.

### INSTALL CHIPSET DRIVER

This page shows the drivers that need to be installed for the system. Click each item to install the driver manually or switch to the to install the drivers automatically.

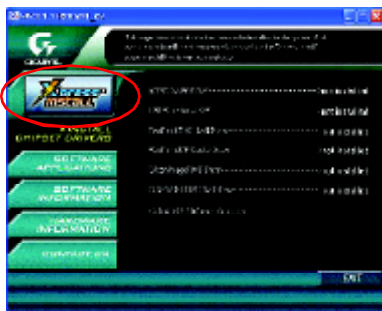

The "Xpress Install" uses the "Click and Forget" technology to install the drivers automatically. Just select the drivers you want then click the "GO" button. The will finish the installation for you automatically.

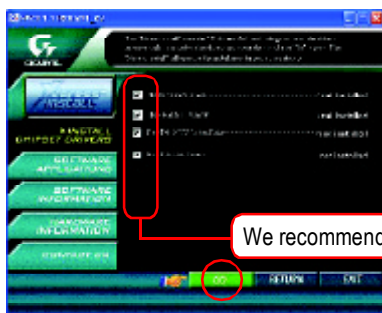

Message: Some device drivers will restart your system automatically. After restarting your system the "Xpress Install" will continue to install other drivers.

We recommend that you install all components in the list.





Driver installation finished !  
You have to reboot system !

### Item Description

- Nvidia System Driver  
nVIDIA Chipset Driver
- USB Patch for WinXP  
This patch driver can help you to resolve the USB device wake up S3 hang up issue in XP.
- RealTek LAN Drive(\*)  
RealTek 10/100 LAN driver for 81xx series chips(\*)
- RealTek AC97 Codec Driver  
Realtek Audio Driver
- Nvidia USB 2.0 Driver Information  
nVIDIA USB 2.0 Host Controller use the inbox driver in Service Pack 1  
Please upgrade to Windows XP Service Pack 1 and rescan for hardware change in Device Manage.



*For USB2.0 driver support under Windows XP operating system, please use Windows Service Pack. After install Windows Service Pack, it will show a question mark "?" in "Universal Serial Bus controller" under "Device Manager". Please remove the question mark and restart the system (System will auto-detect the right USB2.0 driver).*

(\*)For GA-7N400E-L only.

## SOFTWARE APPLICATION

This page reveals the value-added software developed by Gigabyte and its worldwide partners.



- Gigabyte Windows Utilities Manager (GWUM)  
This utility can integrate the Gigabyte's applications in the system tray
- Gigabyte Management Tool (GMT)  
A useful tool which can manage the computer via the network
- EasyTune 4  
Powerful utility that integrates the overclocking and hardware monitoring functions
- DMI Viewer  
Windows based utility which is used to browse the DMI/SMBIOS information of the system
- Face-Wizard  
New utility for adding BIOS logo
- @BIOS  
Gigabyte windows flash BIOS utility
- Acrobat e-Book  
Useful utility from Adobe
- Acrobat Reader  
Popular utility from Adobe for reading .PDF file format documents
- Norton Internet Security (NIS)  
Integrated utility which includes anti-virus, ads, etc.
- DirectX 9.0  
Install Microsoft DirectX9 to enable 3D hardware acceleration that support for operating system to achieve better 3D performance.



## FAQ

Below is a collection of general asked questions. To check general asked questions based on a specific motherboard model, please go to <http://tw.giga-byte.com/faq/faq.htm>

**Question 1:** I cannot see some options that were included in previous BIOS after updating BIOS. Why?

**Answer:** Some advanced options are hidden in new BIOS version. Please press Ctrl and F1 keys after entering BIOS menu and you will be able to see these options.

**Questions 2:** Why is the light of my keyboard/optical mouse still on after computer shuts down?  
**Answer:** In some boards, a small amount of electricity is kept on standby after computer shuts down and that's why the light is still on.

**Question 3:** Why cannot I use all functions in EasyTune™ 4?

**Answer:** The availability of the listed functions in EasyTune™ 4 depends on the MB chipset. If the chipset doesn't support certain functions in EasyTune™ 4, these functions will be locked automatically and you will not be able to use them.

**Question 4:** Why do I fail to install RAID and ATA drivers under Win 2000 and XP on boards that support RAID function after I connect the boot HDD to IDE3 or IDE4 ?

**Answer:** First of all, you need to save some files in the CD-ROM to a floppy disk before installing drivers. You also need to go through some rather different steps in the installation process. Therefore, we suggest that you refer to the installation steps in the RAID manual at our website. (Please download it at [http://tw.giga-byte.com/support/user\\_pdf/raid\\_manual.pdf](http://tw.giga-byte.com/support/user_pdf/raid_manual.pdf))

**Question 5:** How do I clear CMOS?

**Answer:** If your board has a Clear CMOS jumper, please refer to the Clear CMOS steps in the manual. If your board doesn't have such jumper, you can take off the on-board battery to leak voltage to clear CMOS. Please refer to the steps below:

Steps:

1. Turn off power.
2. Disconnect the power cord from MB.
3. Take out the battery gently and put it aside for about 10 minutes (Or you can use a metal object to connect the positive and negative pins in the battery holder to make them short for one minute).
4. Re-insert the battery to the battery holder.
5. Connect power cord to MB again and turn on power.
6. Press Del to enter BIOS and load Fail-Safe Defaults.
7. Save changes and reboot the system.

**Question 6:** Why does system seem unstable after updating BIOS?

**Answer:** Please remember to load Fail-Safe Defaults (Or Load BIOS Defaults) after flashing BIOS. However, if the system instability still remains, please clear CMOS to solve the problem.

**Question 7:** Why do I still get a weak sound after turning up the speaker to the maximum volume?

**Answer:** Please make sure the speaker you are using is equipped with an internal amplifier. If not, please change another speaker with power/amplifier and try again later.

**Question 8:** How do I disable onboard VGA card in order to add an external VGA card?

**Answer:** Gigabyte motherboards will auto-detect the external VGA card after it is plugged in, so you don't need to change any setting manually to disable the onboard VGA.

**Question 9:** Why cannot I use the IDE 2?

**Answer:** Please refer to the user manual and check whether you have connected any cable that is not provided with the motherboard package to the USB Over Current pin in the Front USB Panel. If the cable is your own cable, please remove it from this pin and do not connect any of your own cables to it.

**Question 10:** Sometimes I hear different continuous beeps from computer after system boots up. What do these beeps usually stand for?

**Answer:** The beep codes below may help you identify the possible computer problems. However, they are only for reference purposes. The situations might differ from case to case.

→ AMI BIOS Beep Codes

\*Computer gives 1 short beep when system boots successfully.

\*Except for beep code 8, these codes are always fatal.

- 1 beep Refresh failure
- 2 beeps Parity error
- 3 beeps Base 64K memory failure
- 4 beeps Timer not operational
- 5 beeps Processor error
- 6 beeps 8042 - gate A20 failure
- 7 beeps Processor exception interrupt error
- 8 beeps Display memory read/write failure
- 9 beeps ROM checksum error
- 10 beeps CMOS shutdown register read/write error
- 11 beeps Cache memory bad

→ AWARD BIOS Beep Codes

- 1 short: System boots successfully
- 2 short: CMOS setting error
- 1 long 1 short: DRAM or M/B error
- 1 long 2 short: Monitor or display card error
- 1 long 3 short: Keyboard error
- 1 long 9 short: BIOS ROM error
- Continuous long beeps: DRAM error
- Continuous short beeps: Power error

**Question 11:** How to set in the BIOS in order to bootup from SATA HDDs by either RAID or ATA mode?

**Answer:** Please set in the BIOS as follow:

1. Advanced BIOS features--> SATA/RAID/SCSI boot order: "SATA"
2. Advanced BIOS features--> First boot device: "SCSI"
3. Integrated Peripherals--> Onboard H/W Serial ATA: "enable"

Then it depends on the SATA mode that you need to set "RAID" to RAID mode or "BASE" to normal ATA mode in the item named Serial ATA function.

**Question 12:** For the M/B which have RAID function, how to set in the BIOS in order to bootup from IDE3, 4 by either RAID or ATA mode?

**Answer:** Please set in the BIOS as follow:

1. Advanced BIOS features-->(SATA)/RAID/SCSI boot order: "SATA"
2. Advanced BIOS features--> First boot device: "SCSI"
3. Integrated Peripherals--> Onboard H/W ATA/RAID: "enable"

Then it depends on the RAID mode that you need to set "RAID" to RAID mode or "ATA" to normal ATA mode in the item named RAID controller function.

**Question 13:** How to set in the BIOS to bootup from the IDE/ SCSI/ RAID card ?

**Answer:** Please set in the BIOS as follow:

1. Advanced BIOS features-->(SATA)/RAID/SCSI boot order: "SCSI"
2. Advanced BIOS features--> First boot device: "SCSI"

Then it depends on the mode(RAID or ATA) that you need to set in RAID/ SCSI BIOS.

## Troubleshooting



If you encounter any trouble during boot up, please follow the troubleshooting procedures.

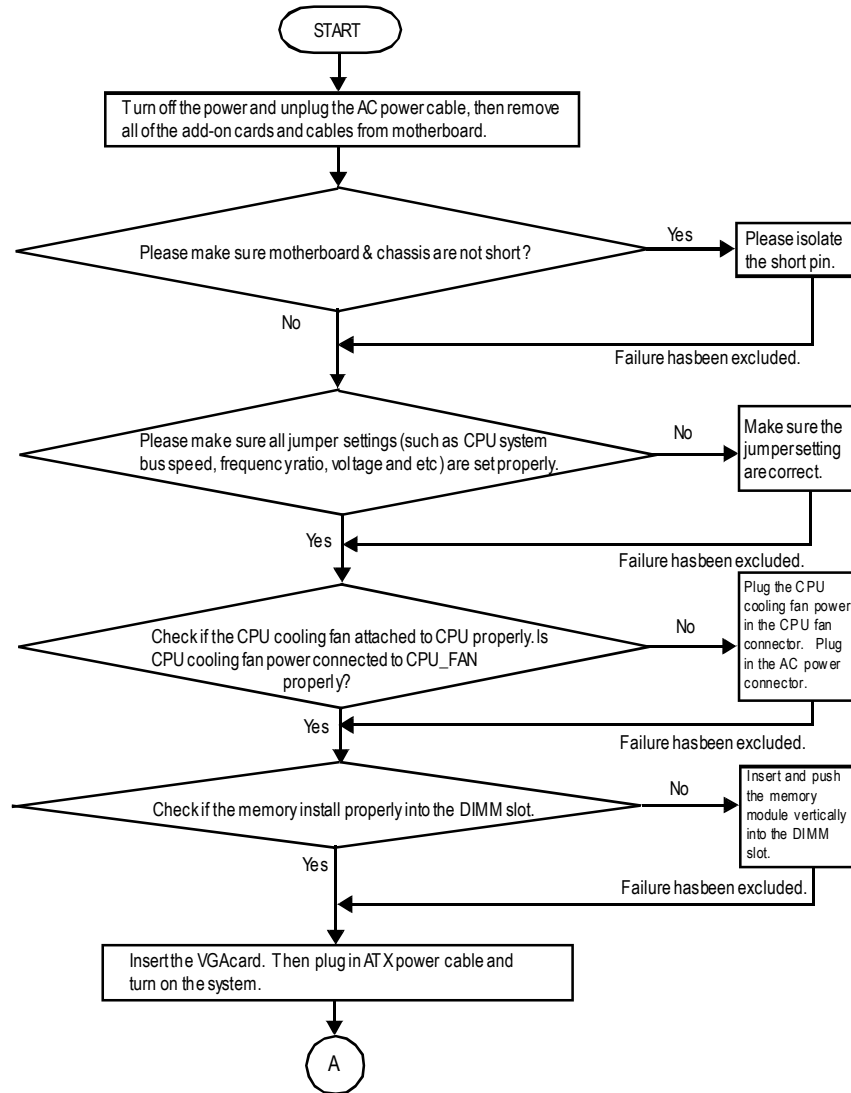

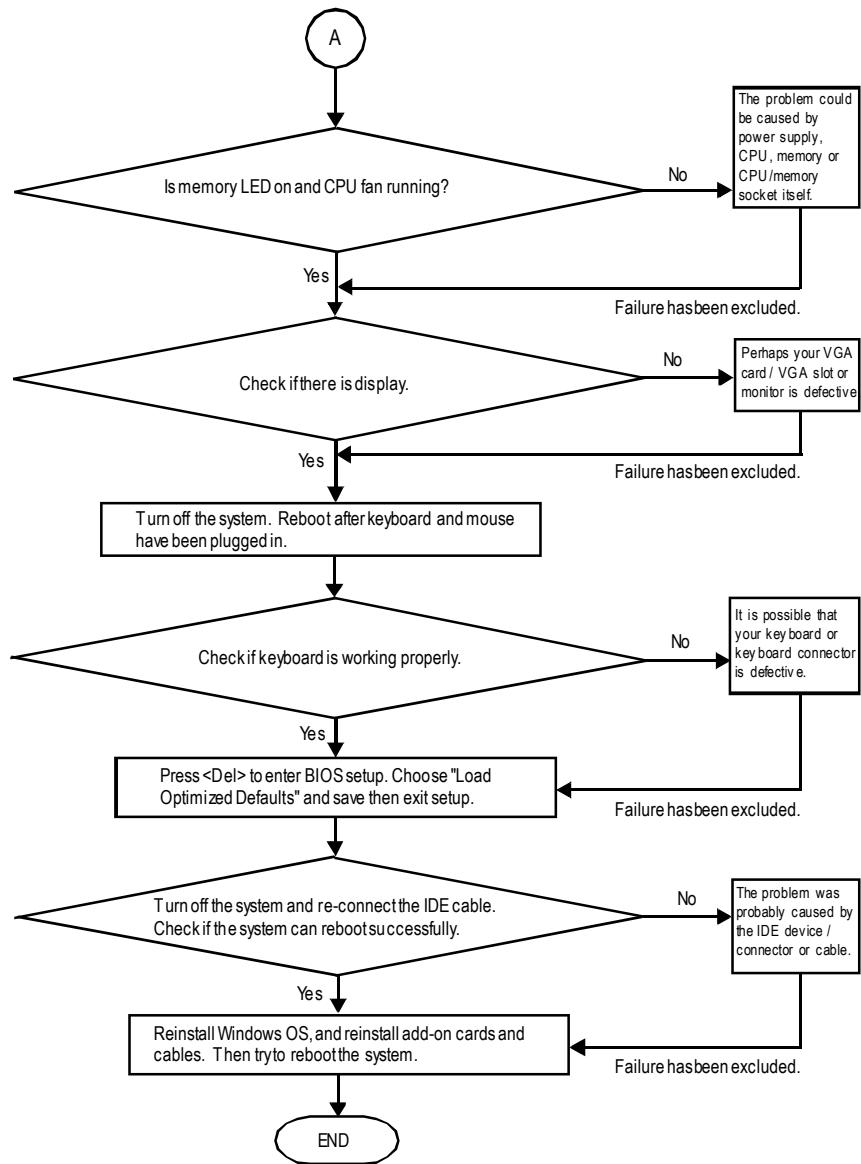

If the above procedure unable to solve your problem, please contact with your local retailer or national distributor for help. Or, you could submit your question to the service mail via Gigabyte website technical support zone (<http://www.gigabyte.com.tw>). The appropriate response will be provided ASAP.



## Technical Support/RMA Sheet

Customer/Country:	Company:	Phone No.:
Contact Person:	E-mail Add. :	

Modelname/LotNumber:	PCB revision:
BIOS version:	O.S./A.S.:

Hardware Configuration	Mfs.	Modelname	Size:	Driver/Utility:
CPU				
Memory				
Brand				
Video Card				
Audio Card				
HDD				
CD-ROM / DVD-ROM				
Modem				
Network				
AMR / CNR				
Keyboard				
Mouse				
Powersupply				
Other Device				

Problem Description:

---



---

## Acronyms

Acronyms	Meaning
ACPI	Advanced Configuration and Power Interface
APM	Advanced Power Management
AGP	Accelerated Graphics Port
AMR	Audio Modem Riser
ACR	Advanced Communications Riser
BIOS	Basic Input/ Output System
CPU	Central Processing Unit
CMOS	Complementary Metal Oxide Semiconductor
CRIMM	Continuity RIMM
CNR	Communication and Networking Riser
DMA	Direct Memory Access
DMI	Desktop Management Interface
DIMM	Dual Inline Memory Module
DRM	Dual Retention Mechanism
DRAM	Dynamic Random Access Memory
DDR	Double Data Rate
ECP	Extended Capabilities Port
ESCD	Extended System Configuration Data
ECC	Error Checking and Correcting
EMC	Electromagnetic Compatibility
EPP	Enhanced Parallel Port
ESD	Electrostatic Discharge
FDD	Floppy Disk Device
FSB	Front Side Bus
HDD	Hard Disk Device
IDE	Integrated Dual Channel Enhanced
IRQ	Interrupt Request

to be continued.....

Acronyms	Meaning
IOAPIC	Input Output Advanced Programmable Input Controller
ISA	Industry Standard Architecture
LAN	Local Area Network
I/O	Input / Output
LBA	Logical Block Addressing
LED	Light Emitting Diode
MHz	Megahertz
MIDI	Musical Instrument Digital Interface
MTH	Memory Translator Hub
MPT	Memory Protocol Translator
NIC	Network Interface Card
OS	Operating System
OEM	Original Equipment Manufacturer
PAC	PCI A.G.P. Controller
POST	Power-On Self Test
PCI	Peripheral Component Interconnect
RIMM	Rambus in-line Memory Module
SCI	Special Circumstance Instructions
SECC	Single Edge Contact Cartridge
SRAM	Static Random Access Memory













## CONTACT US

Contact us via the information in this page all over the world.

---

- Taiwan

Gigabyte Technology Co., Ltd.  
 Address: No.6, Bau Chiang Road, Hsin-Tien, Taipei  
 Hsien, Taiwan, R.O.C.  
 TEL: 886 (2) 8912-4888 (50 lines)  
 FAX: 886 (2) 8912-4004  
 E-mail:english@gigabyte.com.tw  
 Web Address: <http://www.gigabyte.com.tw>

---

- USA

G.B.T. INC.  
 Address: 17358 Railroad St, City of Industry, CA  
 91748.  
 Tel: 1 (626) 854-9338  
 Fax: 1 (626) 854-9339  
 E-mail:sales@giga-byte.com  
 support@giga-byte.com  
 Web Address: [www.giga-byte.com](http://www.giga-byte.com)

---

- Germany

G.B.T. Technology Trading GmbH  
 Tel: 49-40-2533040  
 Fax: 49-40-25492343 (Sales)  
 Tel: 49-01803-428468 (Tech.)  
 Fax: 49-01803-428329 (Tech.)  
 E-mail:support@gigabyte.de  
 Web Address: [www.gigabyte.de](http://www.gigabyte.de)

---

- JAPAN/Nippon Giga-Byte Corporation

Web Address: [www.gigabyte.co.jp](http://www.gigabyte.co.jp)

---

- U.K

G.B.T. TECH. CO. LTD.  
 Tel: 44-1908-362700  
 Fax: 44-1908-362709  
 E-mail:support@gbt-tech.co.uk  
 Web Address: [www.gbt-tech.co.uk](http://www.gbt-tech.co.uk)

---

- The Netherlands

Giga-Byte Technology B.V.  
 Address: Postbus 1385, 5602 BJ, Eindhoven, The  
 Netherlands  
 Tel: +31 40 290 2088  
 Fax: +31 40 290 2089  
 E-mail:info@giga-byte.nl  
 Web Address: <http://www.giga-byte.nl>

---

- China

Shanghai Office  
 Tel: 86-21-64737410  
 Fax: 86-21-64453227  
 Web Address: [www.gigabyte.com.cn](http://www.gigabyte.com.cn)  
GuangZhou Office  
 Tel: 86-20-87586273  
 Fax: 86-20-87544306  
 Web Address: [www.gigabyte.com.cn](http://www.gigabyte.com.cn)

---

- Beijing Office

Tel: 86-10-82856054  
 86-10-82856064  
 86-10-82856094  
 Fax: 86-10-82856575  
 Web Address: [www.gigabyte.com.cn](http://www.gigabyte.com.cn)  
 E-mail:bjsupport@gigabyte.com.cn

---

- Chengdu Office

Tel: 86-28-85236930  
 Fax: 86-28-85256822  
 Web Address: [www.gigabyte.com.cn](http://www.gigabyte.com.cn)