

# **6VXE7+**

## **USER'S MANUAL**

- 1. System power on by PS/2 Mouse: First, enable this function in CMOS Setup, then you can power on the system by double clicking the right or left button of your PS/2 Mouse.**
- 2. System power on by Keyboard: If your ATX power supply supports larger than 300 mA 5V Stand-By current (depends on the specification of keyboards), you can power on your system by entering password from the Keyboard after setting the "Keyboard power on" jumper and password in CMOS Setup.**
- 3. Support 3 steps ACPI LED selectable.**
- 4. Support Modem Ring-On. (Include internal Modem and external modem on COM A and COM B)**
- 5. Support Wake-up On LAN. (Your ATX power supply must support larger than 720 mA 5V Stand-By current)**

**Celeron™/Pentium® !!! Socket 370 Processor Motherboard**

**REV. 1.0 Second Edition**

R-10-02-000427



The author assumes no responsibility for any errors or omissions which may appear in this document nor does it make a commitment to update the information contained herein.

Third-party brands and names are the property of their respective owners.

Sound Blaster is a registered trademark of Creative Technology Ltd in the United States and certain other countries. Sound Blaster-LINK and SB-LINK are trademarks of Creative Technology Ltd.

Apr. 27, 2000 Taipei, Taiwan

**I. Quick Installation Guide :**

The system bus speed can be set for 66,100,133MHz. The user can select the system bus speed (**SW2**) and change the DIP SWITCH (**SW1**) selection to set up the CPU speed for 300 - 866MHz processor.

- **The CPU speed must match with the frequency RATIO. It will cause system hanging up if the frequency RATIO is higher than CPU's.**

**SW1: (O:ON / X:OFF)**

FREQ. RATIO	DIP SWITCH (SW)			
	1	2	3	4
X 3	O	X	O	O
X 3.5	X	X	O	O
X 4	O	O	X	O
X 4.5	X	O	X	O
X 5	O	X	X	O
X 5.5	X	X	X	O
X 6	O	O	O	X
X 6.5	X	O	O	X
X 7	O	X	O	X
X 7.5	X	X	O	X
X 8	O	O	X	X
X 8.5	X	O	X	X
X 9	O	X	X	X
X 9.5	X	X	X	X

**Set System Bus Speed**

**SW2: (O:ON / X:OFF)**

CPU	PCICLK	1	2	3	4	5	6
66/100/ 133/Auto	33.3	X	X	X	X	O	O
66	33.3	O	O	X	X	X	X
75	37.5	O	O	O	X	X	X
83	41.6	O	O	X	O	X	X
100	33.3	O	X	X	X	X	X
112	37.3	O	X	O	X	X	X
124	31	X	X	X	O	X	X
133	33.3	X	X	X	X	X	X
140	35	X	X	O	O	X	X
150	37.5	X	X	O	X	X	X

● **Note:** We don't recommend you to set up your system speed to 75,83,112,124,140 or 150MHz because these frequencies are not the standard specifications for CPU, Chipset and most of the peripherals. Whether your system can run under 75,83,112,124,140 or 150 MHz properly will depend on your hardware configurations: CPU, SDRAM, Cards, etc.

1. Celeron™ 300A/ 66 MHz FSB

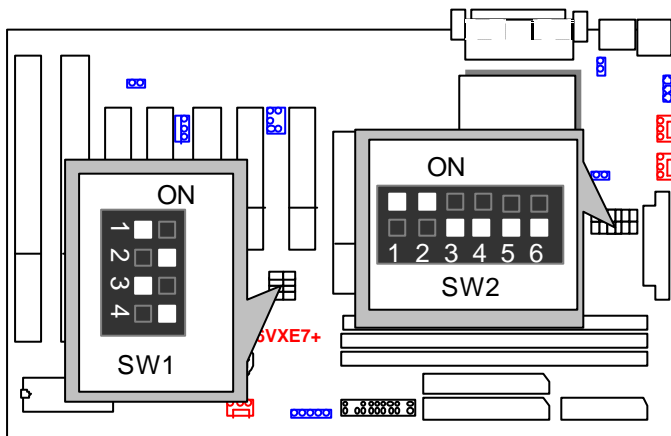

2. Celeron™ 333/ 66 MHz FSB

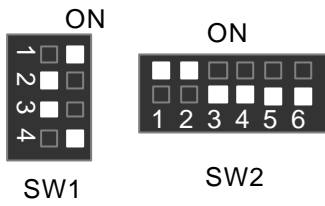

3. Celeron™ 366/ 66 MHz FSB

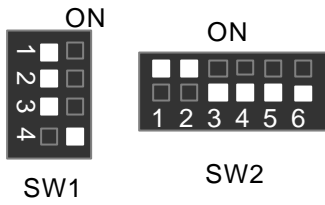

4. Celeron™ 400/ 66 MHz FSB

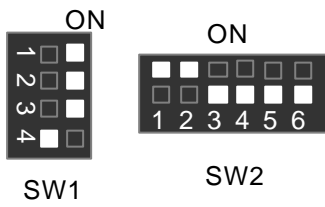

5. Celeron™ 433/ 66 MHz FSB

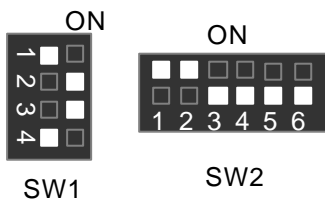

6. Celeron™ 466/ 66 MHz FSB

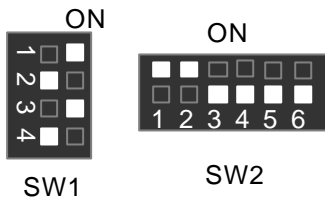

7. Celeron™ 500/ 66 MHz FSB

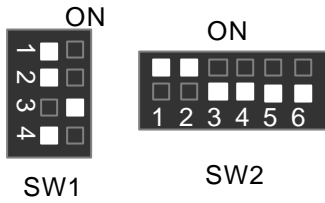

8. Celeron™ 533/ 66 MHz FSB

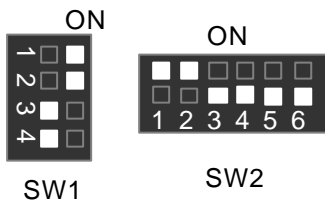

9. Celeron™ 566/ 66 MHz FSB

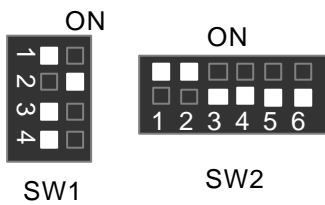

10. Cyrix Joshua 300/100MHz FSB

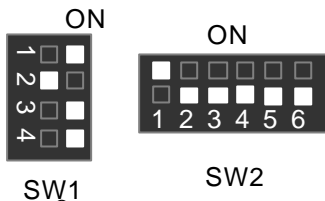

11. Pentium® !!! 500/100MHz FSB

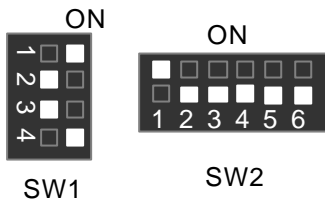

12. Pentium® !!! 550/100MHz FSB

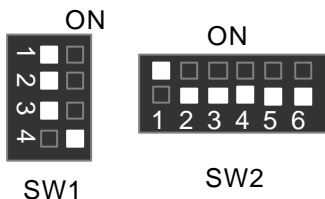

13. Pentium® !!! 600/100MHz FSB

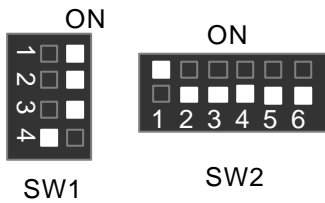



14. Pentium<sup>®</sup>!!! 650/100MHz FSB

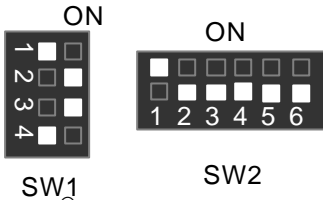

15. Pentium<sup>®</sup>!!! 700/100MHz FSB

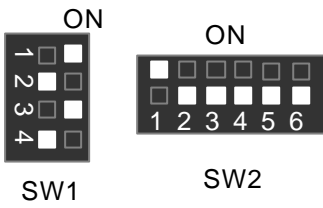

16. Pentium<sup>®</sup>!!! 750/100MHz FSB

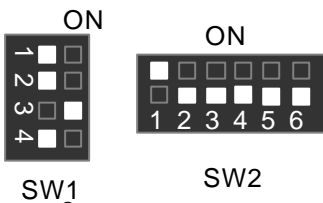

17. Pentium<sup>®</sup>!!! 800/100MHz FSB

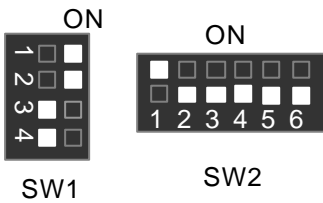

18. Pentium® !!! 850/100MHz FSB

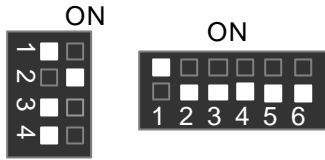

SW1

SW2

19. Pentium® !!! 533/133MHz FSB

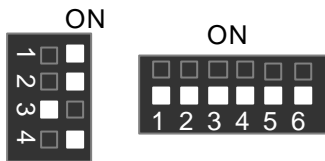

SW1

SW2

20. Pentium® !!! 600/133 MHz FSB

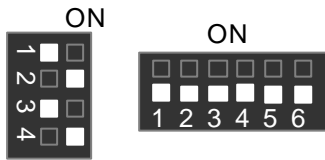

SW1

SW2

21. Pentium® !!! 667/133MHz FSB

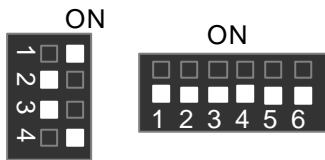

SW1

SW2

22. Pentium® !!! 733/133MHz FSB

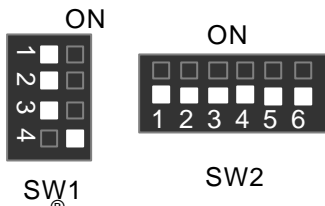

23. Pentium® !!! 800/133MHz FSB

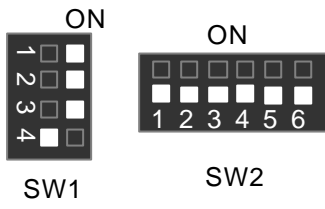

24. Pentium® !!! 866/133MHz FSB

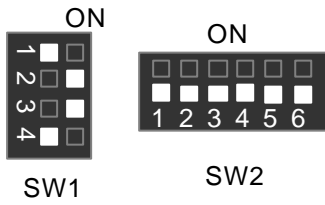

**II. Jumper setting :**

SPK : Speaker Connector

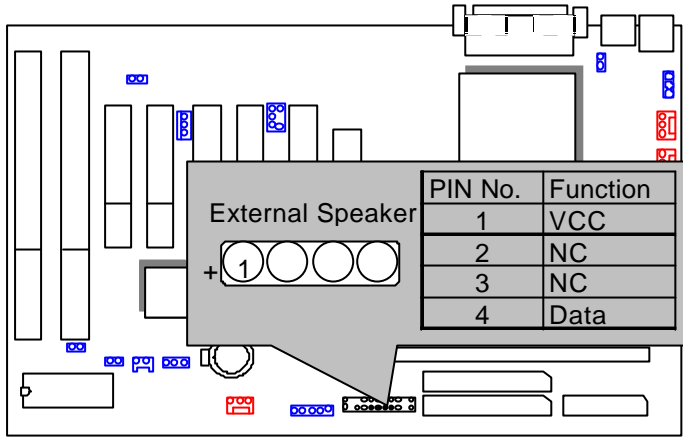

RST : Reset Switch

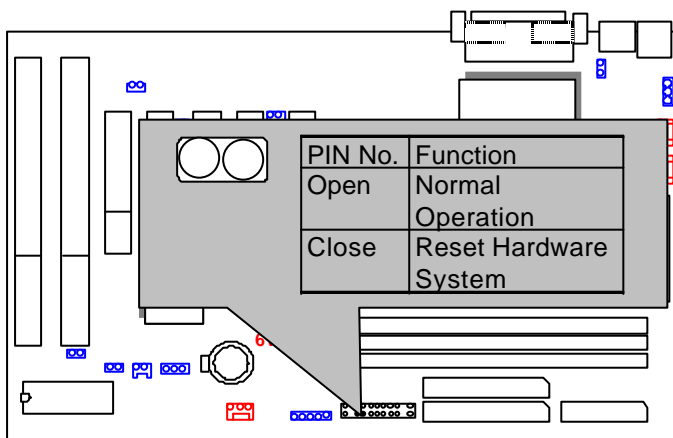

PW LED : Power LED Connector

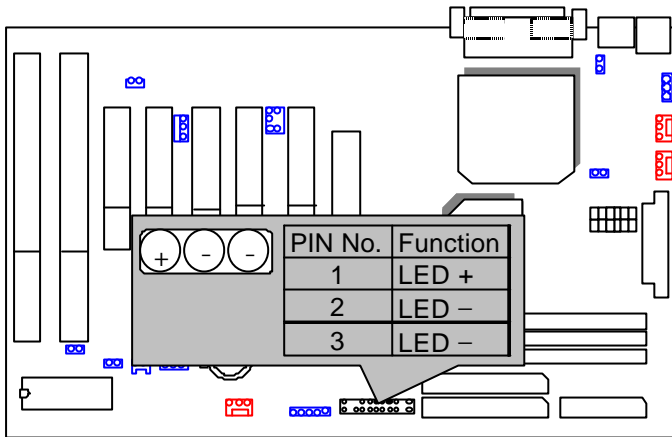

HD : IDE Hard Disk Active LED

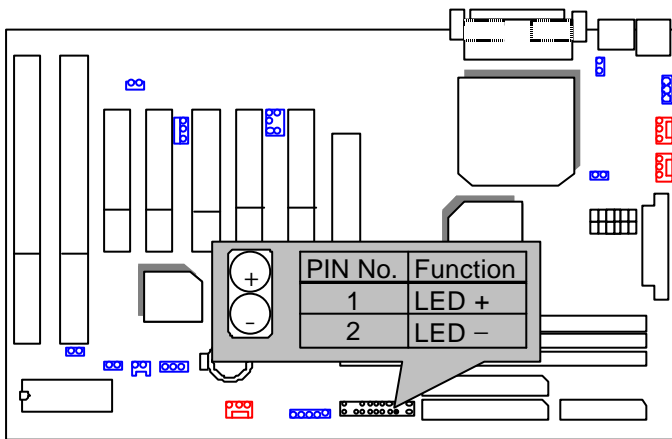

GN : Green Function Switch

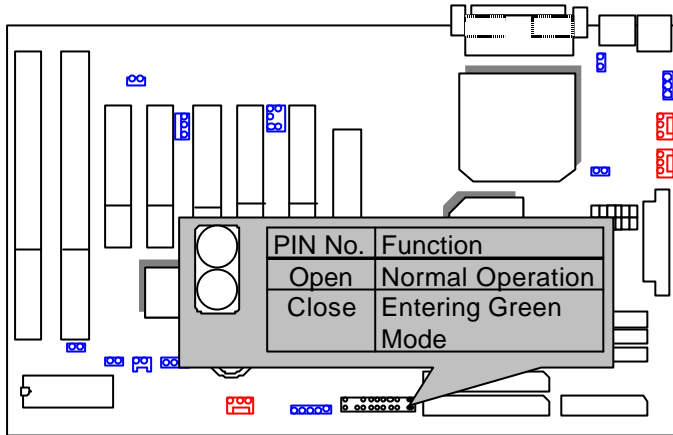

GD : Green LED

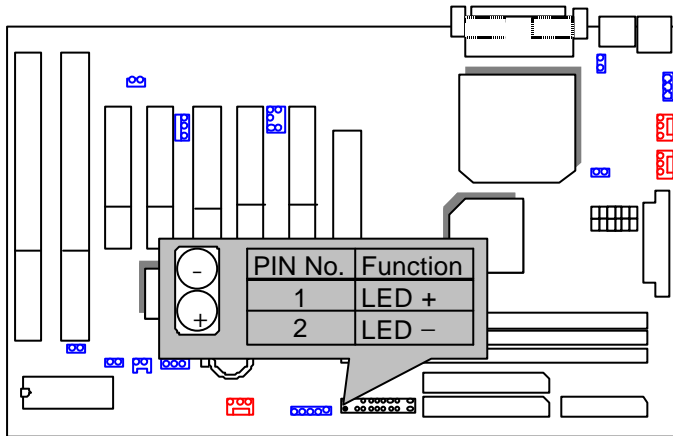

Soft POWER : Soft Power Connector

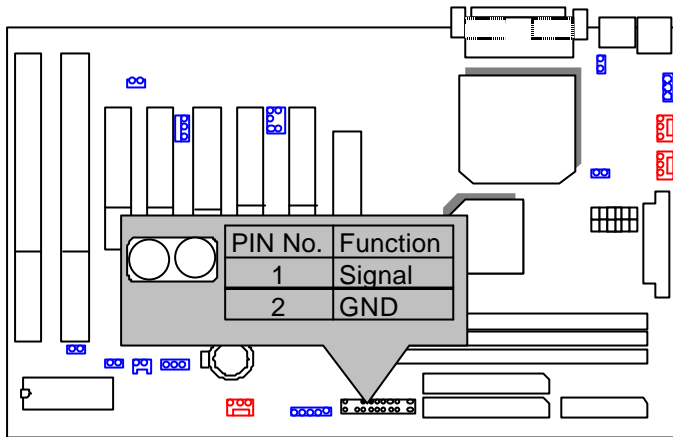

IR : Infrared Connector (Optional)

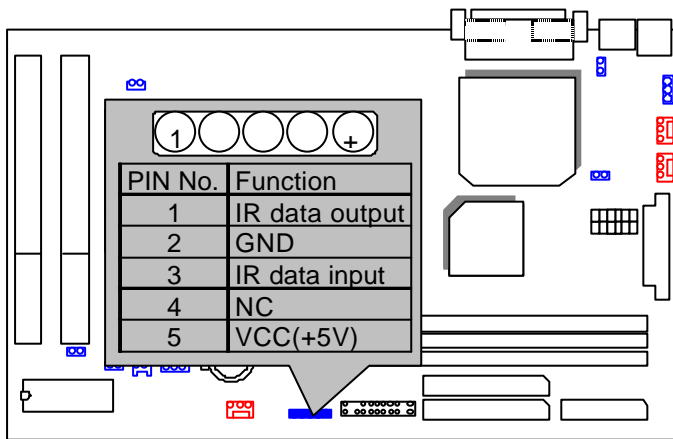

ATX POWER : ATX Power Connector

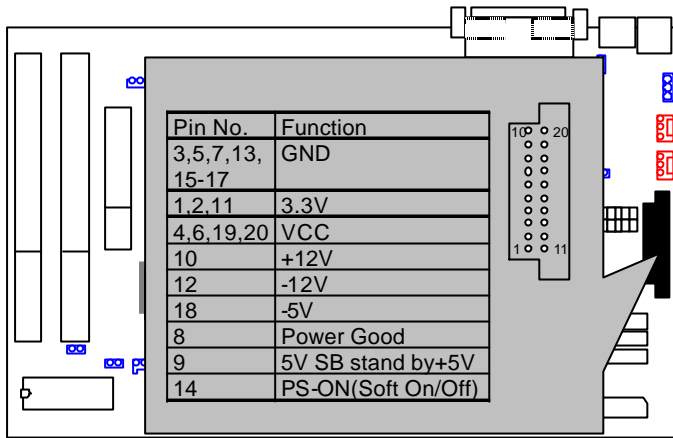

PS/2 Mouse / Keyboard Connector

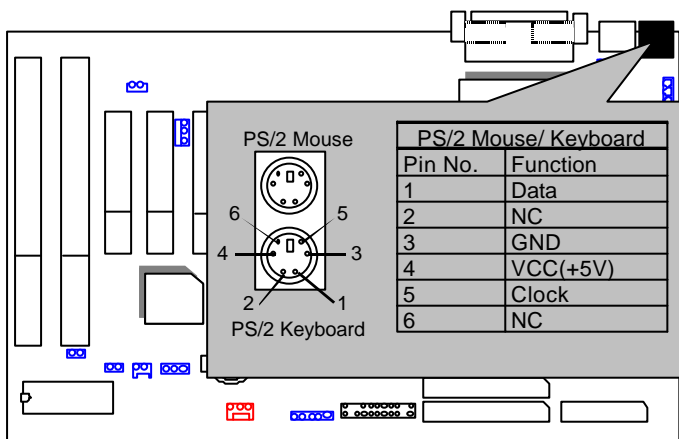



J2: CPU FAN

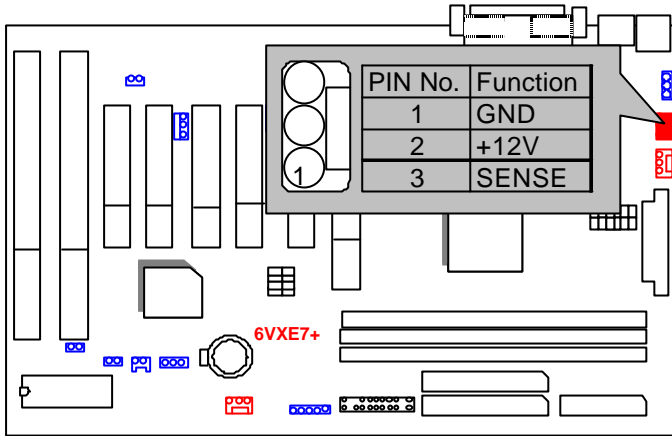

J3: PWR FAN

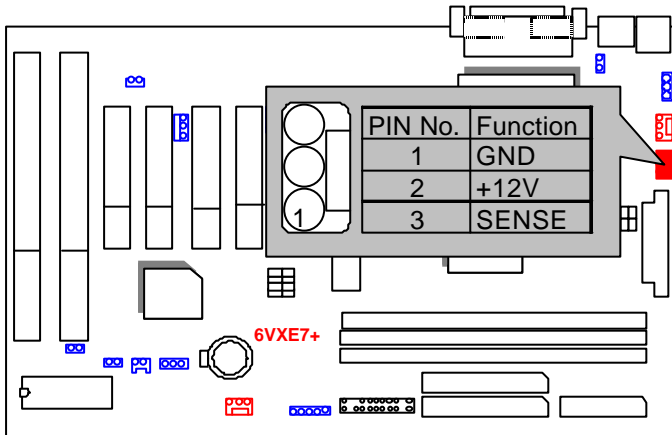

J15 :SYSTEM FAN

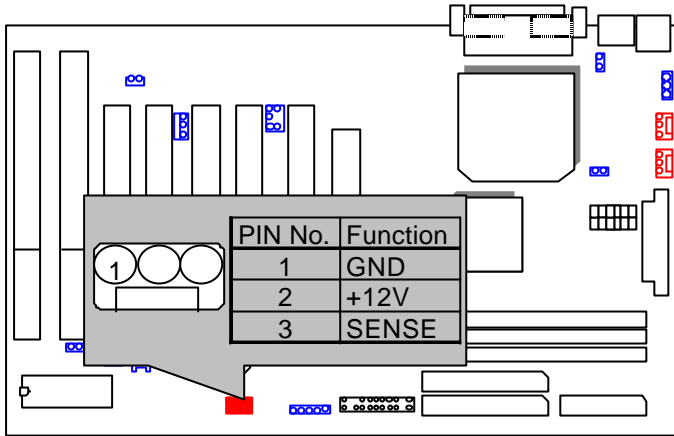

IDE1: For Primary IDE Port

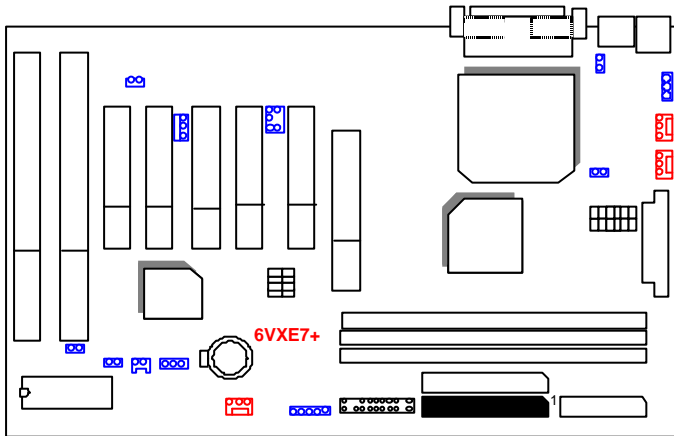

IDE2: For Secondary IDE Port

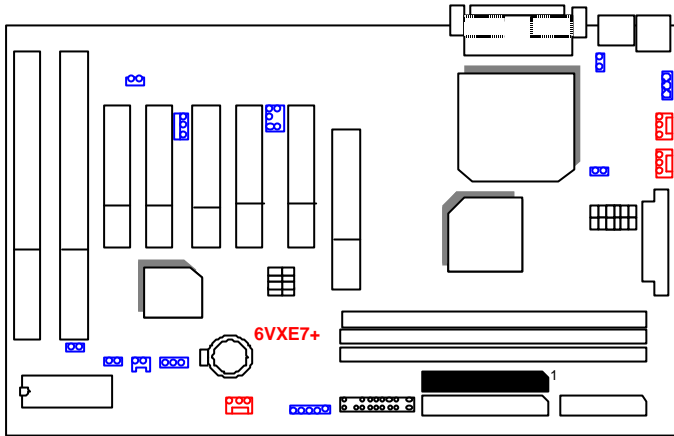

FLOPPY : Floppy Port

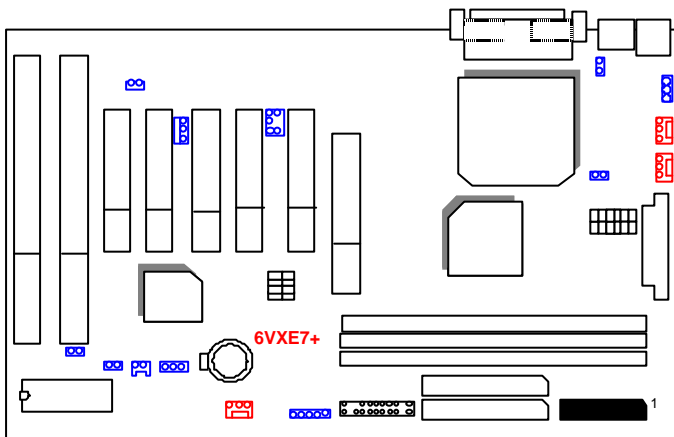

LPT PORT / COM A / COM B

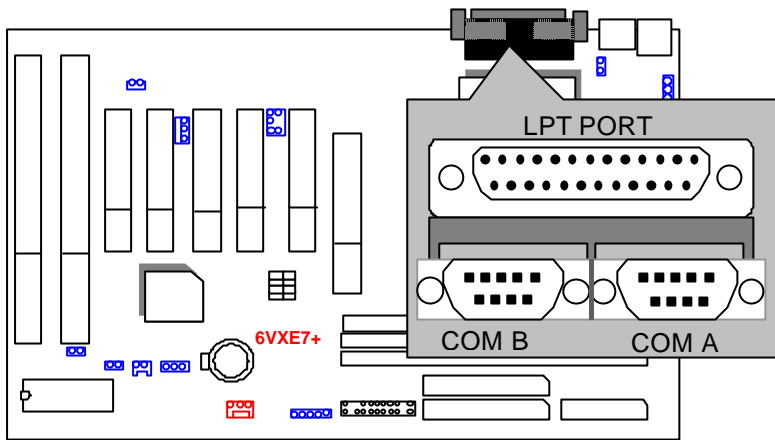

JP1 : PS/2 Keyboard Power On Selection

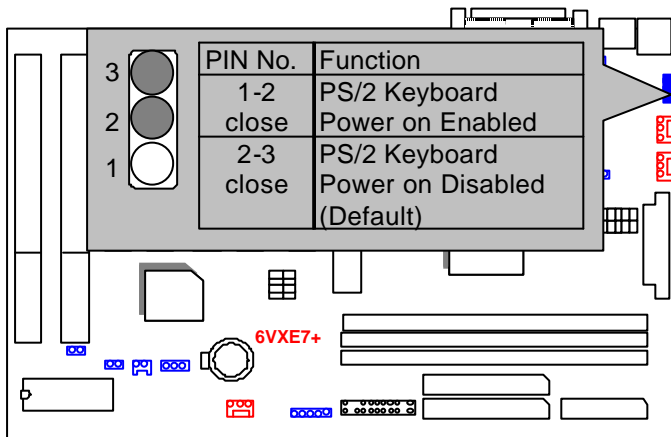

USB : USB Port

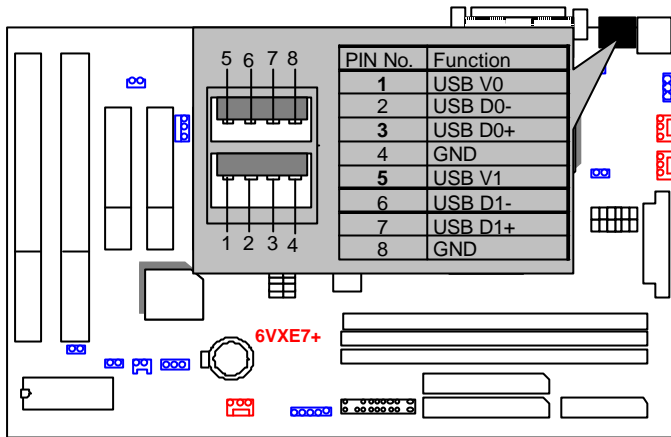

JP7: Wake On LAN

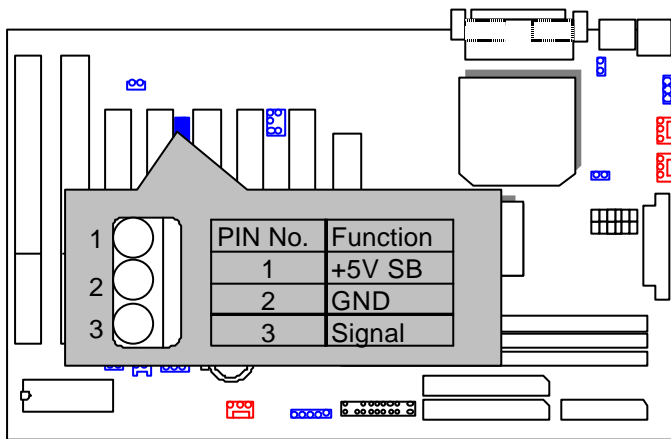

JP9 : Clear CMOS Function

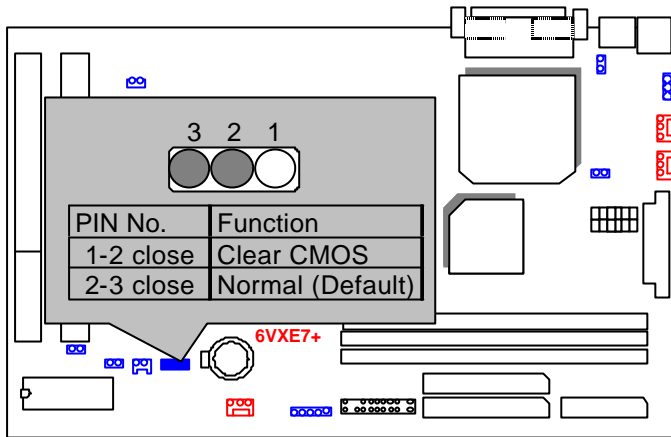

J14 :SB-LINK

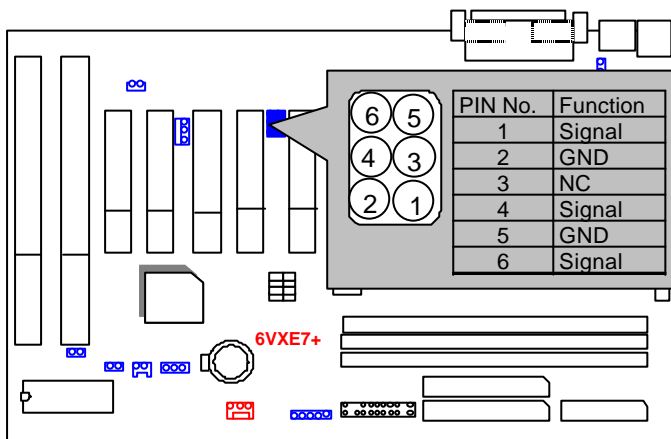

J16: Internal Modem Ring On

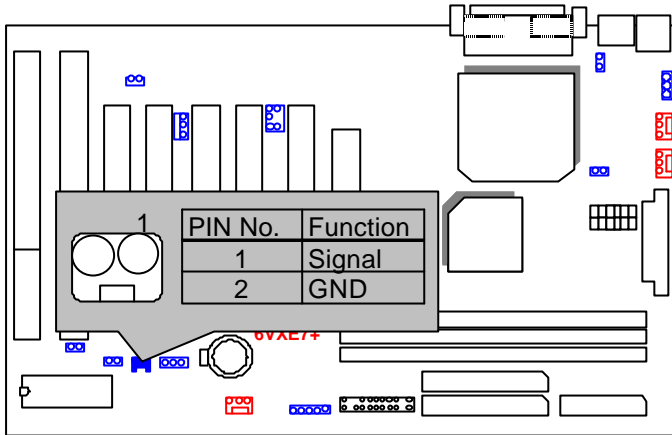

JP10 : Case Open (Optional)

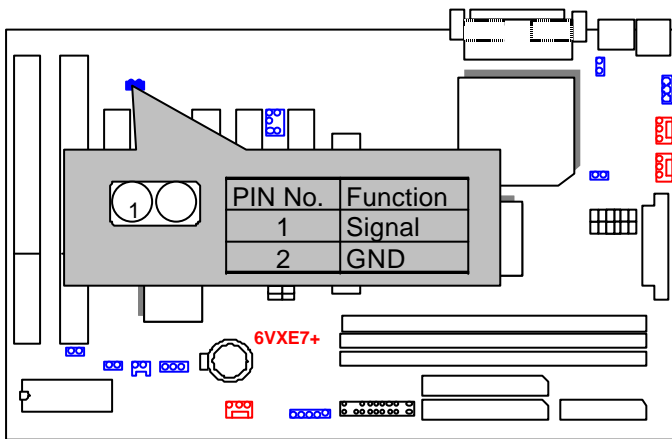

JP15 : Over Voltage(**Magic Booster**)(Optional)  
 (When JP15 set "Open", CPU Voltage is rising 10%)

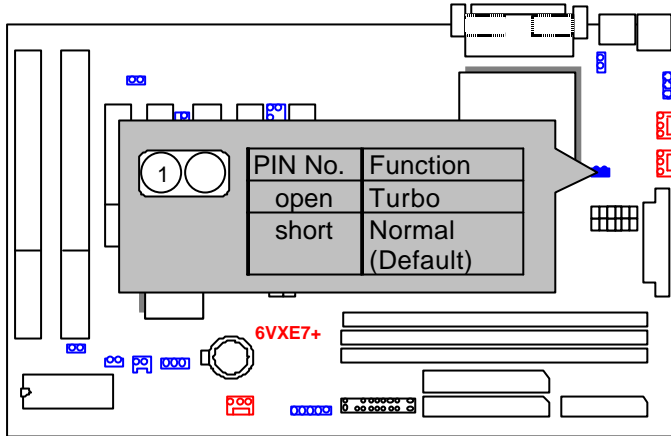

JP16 : BIOS Flash ROM Write Protection

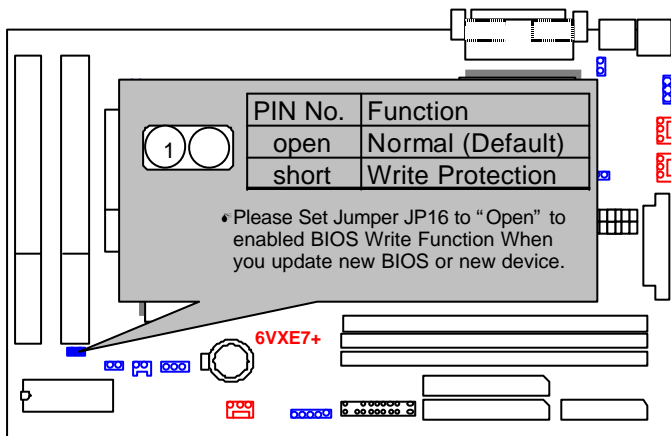



J17 : Cyrix CPU Turbo Function (Optional)

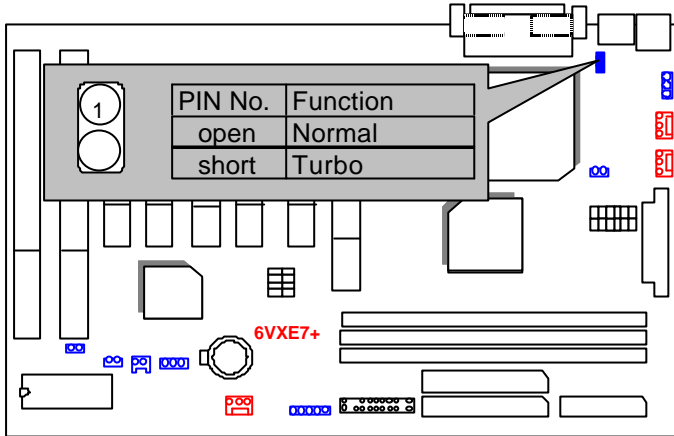

JP17 : System After AC Back

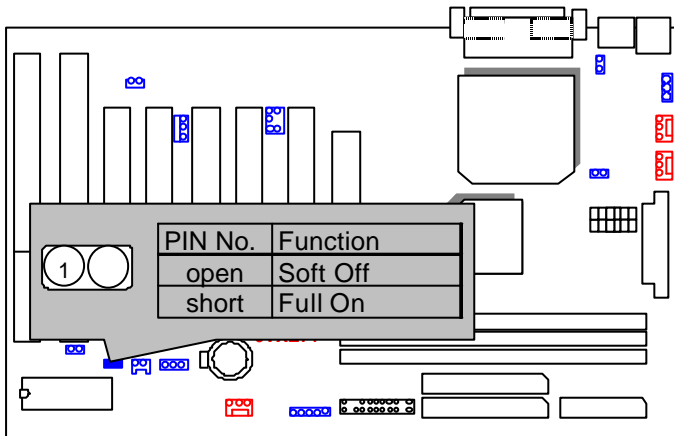

BAT1 :Battery

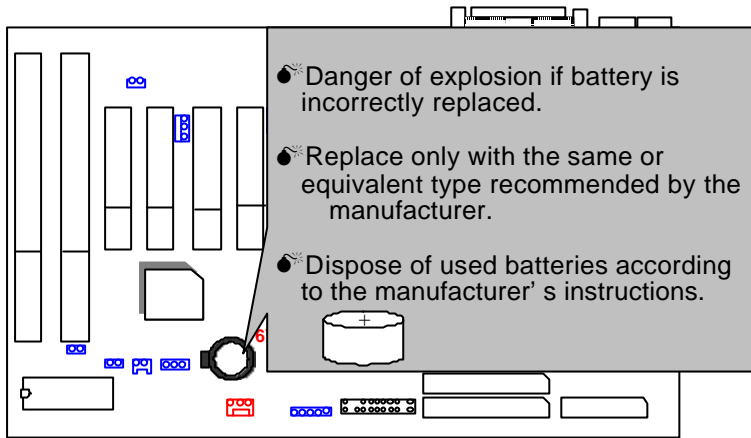

### III. Top Performance Test Setting:

Users have to modify the value for each item in chipset features as follow for top performance setting.

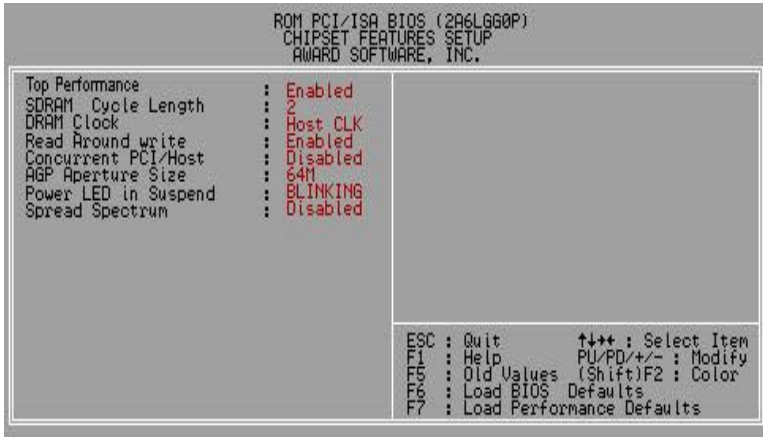

\*\* Each value of items as above depends on your hardware configuration : CPU , SDRAM , Cards , etc.

Please modify each value of items If your system does not work properly .

The following performance data list is the testing results of some popular benchmark testing programs.

These data are just referred by users, and there is no responsibility for different testing data values gotten by users. (Different Hardware & Software configuration will result in different benchmark testing results.)

- CPU Intel Socket 370 Processor
- DRAM (128 x 1) MB SAMSUNG (SECKM48S803CT-GA)
- CACHE SIZE 128 KB included in CPU (Celeron);  
256 KB included in CPU (Pentium® !!!)
- DISPLAY GA-660 AGP Card (32MB SDRAM)
- STORAGE Onboard IDE (IBM DJNA-371800) (18GB)
- O.S. Windows NT™4.0 (SP6a)
- DRIVER Display Driver at 1024 x 768 x 64K x 75Hz

Processor	Intel Celeron™ Socket 370		Intel Pentium® !!! Socket 370	
	400MHz (100x4)	533MHz (66x8)	700MHz (100x7)	600MHz (133x4.5)
<b>Winbench99</b>				
CPU mark99	33.8	38.4	62.1	55.8
FPU Winmark 99	2140	2860	3760	3210
Business Disk Winmark 99	4950	4670	5550	5140
Hi-End Disk Winmark 99	13000	12300	12700	13200
Business Graphics Winmark 99	181	188	312	298
Hi-End Graphics Winmark 99	352	400	626	572
<b>Winstone99</b>				
Business Winstone99	29.7	30.7	40.5	39.5
Hi-End Winstone99	27.4	30.1	39.9	38.4

**TABLE OF CONTENTS**

**1. INTRODUCTION**

1.1. PREFACE..... 1-1  
1.2. KEY FEATHERS ..... 1-1  
1.3. PERFORMANCE LIST ..... 1-2  
1.4. BLOCK DIAGRAM..... 1-3  
1.5. INTRODUCE THE INTEL® Celeron™ Socket 370 Processor..... 1-4  
1.6. WHAT IS AGP?..... 1-4

**2. SPECIFICATION**

2.1. HARDWARE..... 2-1  
2.2. SOFTWARE..... 2-2  
2.3. ENVIRONMENT ..... 2-2

**3. HARDWARE INSTALLATION**

3.1. UNPACKING..... 3-1  
3.2. MOTHERBOARD LAYOUT ..... 3-2  
3.3. QUICK REFERENCE FOR JUMPERS & CONNECTORS ..... 3-2  
3.4. DRAM INSTALLATION..... 3-6  
3.5. CPU SPEED SETUP..... 3-6  
3.6. CMOS RTC & ISA CFG CMOS RAM..... 3-7  
3.7. SPEAKER CONNECTOR INSTALLATION..... 3-8  
3.8. HARDWARE RESET SWITCH CONNECTOR INSTALLATION..... 3-8  
3.9. POWER LED CONNECTOR INSTALLATION ..... 3-8  
3.10. IDE & ATAPI DEVICE INSTALLATION..... 3-8

3.11. PERIPHERAL DEVICE INSTALLATION.....	3-8
3.12. KEYBOARD & PS/2 MOUSE INSTALLATION.....	3-8
<b>4. BIOS CONFIGURATION</b>	
4.1. ENTERING SETUP.....	4-1
4.2. CONTROL KEYS.....	4-2
4.3. GETTING HELP .....	4-3
4.3.1. Main Menu .....	4-3
4.3.2. Status Page Setup Menu / Option Page Setup Menu .....	4-3
4.4. THE MAIN MENU.....	4-3
4.5. STANDARD CMOS SETUP MENU.....	4-5
4.6. BIOS FEATURES SETUP.....	4-9
4.7. CHIPSET FEATURES SETUP .....	4-13
4.8. POWER MANAGEMENT SETUP.....	4-15
4.9. PNP/PCI CONFIGURATION.....	4-19
4.10. LOAD BIOS DEFAULTS.....	4-21
4.11. LOAD PERFORMANCE DEFAULTS.....	4-22
4.12. INTEGRATED PERIPHERALS.....	4-23
4.13.SUPERVISOR/USER PASSWORD.....	4-26
4.14. IDE HDD AUTO DETECTION .....	4-27
4.15. SAVE & EXIT SETUP .....	4-28
4.16. EXIT WITHOUT SAVING.....	4-29
<b>APPENDIX .....</b>	<b>A-1</b>

## 1. INTRODUCTION

### 1.1. PREFACE

Welcome to use the **6VXE7+** motherboard. It is a Intel<sup>®</sup> (Celeron™ /Pentium<sup>®</sup> !!! )and Cyrix Joshua Socket 370 Processor based PC / AT Compatible system with AGP / PCI / ISA Bus, and has been designed to be the fastest PC / AT system. There are some new features allow you to operate the system with just the performance you want.

This manual also explains how to install the motherboard for operation, and how to set up your CMOS CONFIGURATION with BIOS SETUP program.

### 1.2. KEY FEATURES

- ❑ Intel Socket 370 Processor based PC / AT compatible Motherboard.
- ❑ Socket 370 Pins ZIF white socket on board.
- ❑ Supports Socket 370 processor running at 300-866MHz.
- ❑ VIA Apollo chipset, Supports AGP / SDRAM / Ultra DMA 33 / ATA 66 IDE / Keyboard and PS/2 Mouse Power On / ACPI features.
- ❑ Supports 3xDIMMs using 3.3V EDO or SDRAM DIMM module.
- ❑ Supports external Modem Ring-On on COMA & COMB and internal Modem Ring-On.
- ❑ Supports EDO 16MB ~ 384 MB, SDRAM 16MB ~ 1.5GB (256Mb DRAM technology) memory on board.
- ❑ Supports Wake-up on LAN .
- ❑ Supports ECC or Non-ECC type DRAM module.
- ❑ 1xAGP slot, 5xPCI Bus slots, 2xISA Bus slots.
- ❑ Supports 2 channels Ultra DMA33/ATA66 IDE ports for 4 IDE Devices.
- ❑ Supports 2xCOM (16550), 1xLPT (EPP / ECP), 1x Floppy port.
- ❑ Supports 2xUSB port & PS/2 Mouse/ Keyboard port.
- ❑ Licensed AWARD BIOS, 2M bits FLASH ROM.
- ❑ 30.5cm x 19 cm ATX SIZE form factor, 4 layers PCB.

### 1.3. PERFORMANCE LIST

The following performance data list is the testing results of some popular benchmark testing programs.

These data are just referred by users, and there is no responsibility for different testing data values gotten by users. (Different Hardware & Software configuration will result in different benchmark testing results.)

- CPU Intel Socket 370 Processor
- DRAM (128 x 1) MB SAMSUNG (SECKM48S803CT-GA)
- CACHE SIZE 128 KB included in CPU (Celeron);  
256 KB included in CPU (Pentium® !!!)
- DISPLAY GA-660 AGP Card (32MB SDRAM)
- STORAGE Onboard IDE (IBM DJNA-371800) (18GB)
- O.S. Windows NT™4.0 (SP6a)
- DRIVER Display Driver at 1024 x 768 x 64K x 75Hz

Processor	Intel Celeron™ Socket 370		Intel Pentium® !!! Socket 370	
	400MHz (100x4)	533MHz (66x8)	700MHz (100x7)	600MHz (133x4.5)
<b>Winbench99</b>				
CPU mark99	33.8	38.4	62.1	55.8
FPU Winmark 99	2140	2860	3760	3210
Business Disk Winmark 99	4950	4670	5550	5140
Hi-End Disk Winmark 99	13000	12300	12700	13200
Business Graphics Winmark 99	181	188	312	298
Hi-End Graphics Winmark 99	352	400	626	572
<b>Winstone99</b>				
Business Winstone99	29.7	30.7	40.5	39.5
Hi-End Winstone99	27.4	30.1	39.9	38.4



### 1.4. BLOCK DIAGRAM

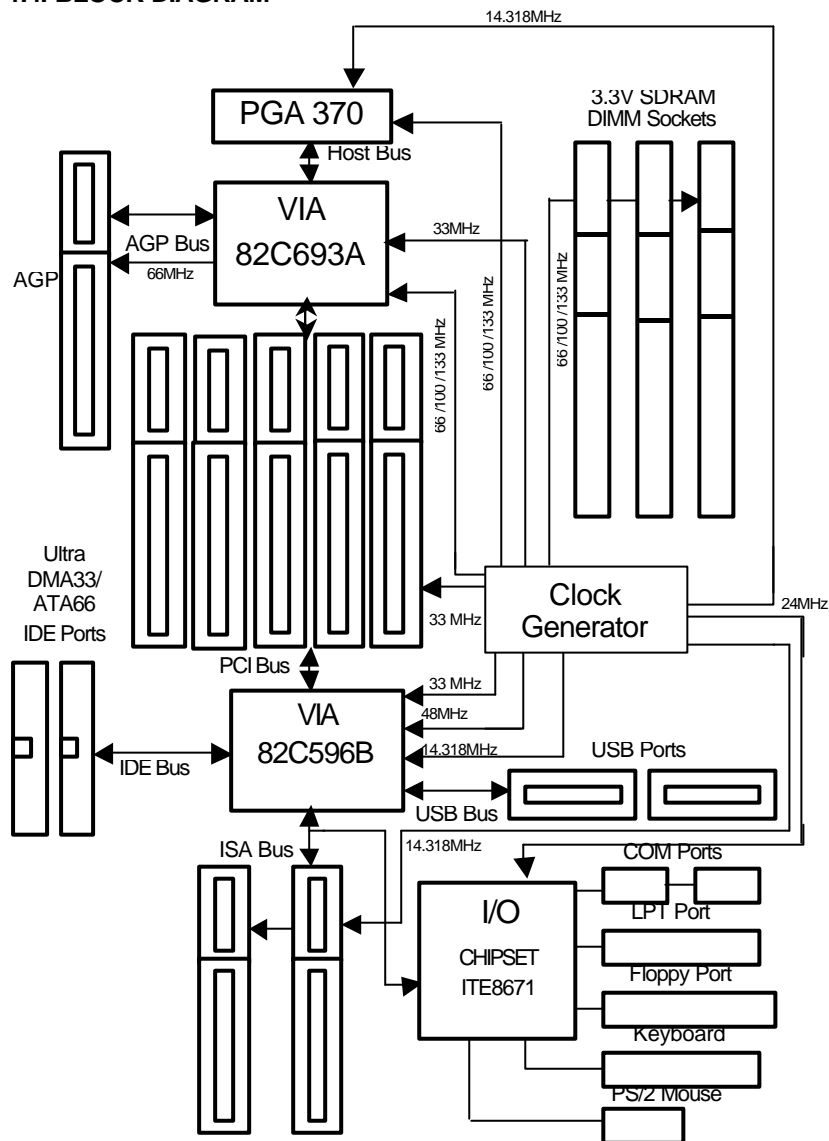

## 1.5. INTRODUCE THE INTEL® Socket 370 Processor

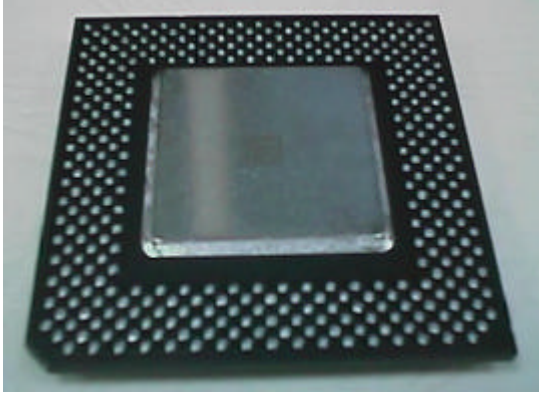

Figure 1: INTEL® Socket370 Processor

## 1.6 What is AGP?

The Accelerated Graphics Port (AGP) is a new port on the Host-To-PCI bridge device that supports an AGP port. The main purpose of the AGP port is to provide fast access to system memory.

The AGP port can be used either as fast PCI port (32-bits at 66MHz vs. 32-Bits at 33MHz) or as an AGP port which supports 2x data-rate, a read queue, and side band addressing. When the 2x-data rate is used the port can transmit data at 533MB/sec ( $66.6 \times 2 \times 4$ ). The read-queue can be used to pipeline reads – removing the effects of the reads-latency. Side band addressing can be used to transmit the data address on a separate line in order to speed up the transaction.

## 2. SPECIFICATION

### 2.1. HARDWARE

- CPU
  - Support Socket 370 Processor: 300–866MHz.
  - 370 pins 66/100/133MHz socket on board.
- CHIPSET
  - VT82C693A PCI/AGP Controller(PAC)
  - VT82C596B PCI ISA IDE Controller.
- SPEED
  - 66/100/133MHz system speed.
  - 66 MHz AGP bus speed. (2X mode 133MHz)
  - 33 MHz PCI-Bus speed.
  - 8 MHz AT bus speed.
- DRAM MEMORY
  - 3 banks 168 pins DIMM module sockets on board.
  - Use 16 / 32 / 64 / 128 / 256 / 512MB DIMM module DRAM.(256Mb DRAM technology)
  - Supports EDO 16MB ~ 384 MB,  
SDRAM 16MB~1.5GB.  
(256Mb DRAM technology)
  - Supports 3.3V EDO / SDRAM.
  - Supports ECC or Non -ECC type DRAM.
- CACHE MEMORY
  - 32 KB L1 cache memory included in CPU.
  - 128/256 KB L2 cache memory (included in CPU).
  - Supports DIB speed mode for L2 Cache.
- I/O BUS SLOTS
  - 5 33MHz Master / Slave PCI-BUS.
  - 2 8MHz 16 bits ISA BUS.
  - 1 66MHz / 133MHz AGP bus.
- IDE PORTS
  - 2 Ultra DMA 33/ATA66 Bus Master IDE channels onboard. (Using IRQ14,15)
  - Support Mode 3,4 IDE & ATAPI CD–ROM.

- I/O PORTS
  - Supports 2 16550 COM ports.
  - Supports 1 EPP/ECP LPT port.
  - Supports 1 Floppy port.
  - Supports 2 USB ports.
  - Supports PS/2 Mouse & PS/2 Keyboard.
- GREEN FUNCTION
  - Suspend mode support.
  - Green switch & Green LED support.
  - IDE & Display power down support.
  - Monitor all IRQ / DMA / Display / I/O events.
- BIOS
  - 2M bits FLASH ROM.
  - Supports Plug & Play, DMI Function.
- DIMENSION
  - ATX Form Factor, 4 layers PCB.

## 2.2. SOFTWARE

- DRIVER
  - TUCD (Bus Master + Utilities)
- BIOS
  - Licensed AWARD BIOS.
  - AT CMOS Setup, BIOS / Chipset Setup, Green Setup, Hard Disk Utility included.
- O.S.
  - Operation with MS-DOS<sup>®</sup>, Windows<sup>®</sup>95, Windows<sup>®</sup>98, Windows NT<sup>™</sup>, OS/2, NOVELL and SCO UNIX.

## 2.3. ENVIRONMENT

- Ambient Temp.
  - 0°C to +50°C (Operating).
- Relative Hum.
  - 0 to +85% (Operating).
- Altitude
  - 0 to 10,000 feet (Operating).
- Vibration
  - 0 to 1,000 Hz.
- Electricity
  - 4.9 V to 5.2 V. (Max. 20A current at 5V.)

## 3. HARDWARE INSTALLATION

### 3.1. UNPACKING

The Motherboard package should contain the following:

- The **6VXE7+** Motherboard.
- USER' S MANUAL for Motherboard.
- Cable set for IDE, Floppy devices.
- A CD for Motherboard Utility.(TUCD)

The motherboard contains sensitive electric components, which can be easily damaged by static electricity, so the Motherboard should be left in its original packing until it is installed.

Unpacking and installation should be done on a grounded anti-static mat. The operator should be wearing an anti static wristband, grounded at the same point as the anti -static mat.

Inspect the Motherboard carton for obvious damage. Shipping and handling may cause damage to your board. Be sure there are no shipping and handling damages on the board before proceeding.

After opening the Motherboard carton, extract the system board and place it only on a grounded anti-static surface component side up. Again inspect the board for damage. Press down on all of the socket IC's to make sure that they are properly seated. Do this only on with the board placed on a firm flat surface.

⚡ **DO NOT APPLY POWER TO THE BOARD IF IT HAS BEEN DAMAGED.**

### 3.2. MOTHERBOARD LAYOUT

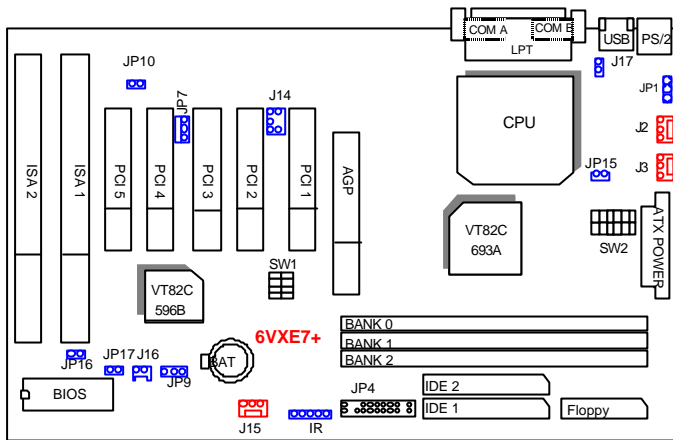

<Figure 3.1>

### 3.3. QUICK REFERENCE FOR JUMPERS & CONNECTORS

◆ I/O Ports Connector	
USB	USB port.
PS/2	For PS/2 Keyboard and Mouse port.
IDE 1/ IDE 2	For Primary / Secondary IDE port.
Floppy	For Floppy port.
COM B	For Serial port2 (COM B).
COM A	For Serial port1 (COM A).
LPT	For LPT port.
ATX Power	For ATX Power Connector.

◆ Socket 370
For Celeron™, Pentium® III, Cyrix Joshua Socket 370 processor installed

◆ J2: CPU FAN	
Pin No.	Function
1	GND.
2	+12V.
3	Sense.

◆ J3: PWR FAN	
Pin No.	Function
1	GND.
2	+12V.
3	Sense.

◆ J15: System FAN	
Pin No.	Function
1	GND.
2	+12V.
3	Sense.

◆ JP1: PS/2 Keyboard Power On Selection	
Pin No.	Function
1-2 short	Enable PS/2 Keyboard power on.
2-3 short	Disable PS/2 Keyboard power on.(Default)

◆ JP7: WAKE ON LAN ( Wake on LAN Connector)	
Pin No.	Function
1	+5VSB.
2	GND.
3	Signal.

◆ J16: RING PWR ON ( Internal Modem Ring On)	
Pin No.	Function
1	Signal.
2	GND.

◆ IR: INFRARED Connector (Optional)	
Pin No.	Function
1	IR DATA OUTPUT.
2	GND.
3	IR DATA INPUT.
4	NC.
5	VCC ( +5V).

◆ JP9: Clear CMOS Function	
Pin No.	Function
1-2 Short	Clear CMOS .
2-3 Short	Normal.(Default)

◆ JP10 : Case Open (Optional)	
Pin No.	Function
1	Signal
2	GND

◆ J14: SB-LINK ( For PCI Audio / Sound Card use only )	
Pin No.	Function
1	Signal
2	GND
3	NC
4	Signal
5	GND
6	Signal

◆ JP15 :Over Voltage(Optional)	
Pin No.	Function
Open	Turbo
Short	Normal(Default)

◆ JP16 : BIOS Flash ROM Write Protection	
Pin No.	Function
Open	Normal(Default)
Short	Write Protection

◆ J17 : Cyrix CPU Turbo Function (Optional)	
Pin No.	Function
Open	Normal
Short	Turbo

◆ JP17 : System After AC Back	
Pin No.	Function
Open	Soft Off
Short	Full On

**JP4 : 2\*11PIN Jumper**

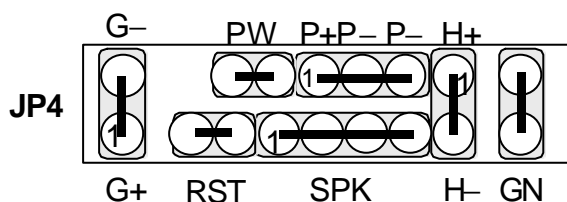



PW : Soft Power Connector



On – Off : For POWER ON or Suspend IN / OUT.  
On 4 sec : For POWER OFF before VGA Enable or  
CMOS setup select “delay 4sec.” For  
POWER OFF mode.

RST : Reset Switch



Open: Normal Operation  
Short: For Hardware Reset System

P+P- P-: Power LED



PIN 1: anode (+)  
PIN 2: cathode (-)  
PIN 3: cathode (-)

SPK: Speaker Connector

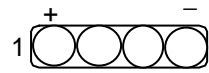

PIN 1 : VCC (+)  
PIN 2 : NC  
PIN 3 : NC  
PIN 4 : Data (-)

HD: IDE Hard Disk Active LED



PIN 1: LED anode (+)  
PIN 2: LED cathode (-)

GN: Green Switch



Open: Normal operation  
Short: Entering Green Mode

GD: Green Function Active LED



PIN 1: LED anode (+)  
PIN 2: LED cathode (-)

### 3.4. DRAM INSTALLATION

The Motherboard can be installed with 16 / 32 / 64 / 128 / 256 / 512MB (256Mb Technology) 168 pins DIMM module DRAM, and the DRAM speed must be 67~100 MHz for SDRAM when system bus speed is set to 66MHz. When system bus speed is set to 100MHz, 100MHz SDRAM is required. The DRAM memory system on Motherboard consists of bank 0, 1, 2 & bank 3.

Since 168 pins DIMM module is 64 bits width, therefore 1 piece of DIMM module may match a 64 bits system. The total memory size is 16 MB ~ 1.5GMB(256Mb Techonloy) SDRAM, EDO DRAM size is 16MB ~ 384MB. The DRAM installation position refer to Figure 3.1, and notice the Pin 1 of DIMM module must match with the Pin 1 of DIMM socket. Insert the DRAM DIMM module into the DIMM socket at Vertical angle. If there is a wrong direction of Pin 1, the DRAM DIMM module could not be inserted into socket completely.

### 3.5. CPU SPEED SETUP

The system bus speed can be set for 66,100,133 MHz. The user can select the system bus speed (**SW2**) and change the DIP SWITCH (**SW1**) selection to set up the CPU speed for 300 - 866MHz processor.

● The CPU speed must match with the frequency RATIO. It will cause system hanging up if the frequency RATIO is higher than CPU's.

SW1: (O:ON / X:OFF)

FREQ. RATIO	DIP SWITCH (SW)			
	1	2	3	4
X 3	O	X	O	O
X 3.5	X	X	O	O
X 4	O	O	X	O
X 4.5	X	O	X	O
X 5	O	X	X	O
X 5.5	X	X	X	O
X 6	O	O	O	X
X 6.5	X	O	O	X
X 7	O	X	O	X
X 7.5	X	X	O	X
X 8	O	O	X	X
X 8.5	X	O	X	X
X 9	O	X	X	X
X 9.5	X	X	X	X

### Set System Bus Speed

SW2: (O:ON / X:OFF)

CPU	PCICLK	1	2	3	4	5	6
66/100/ 133/Auto	33.3	X	X	X	X	O	O
66	33.3	O	O	X	X	X	X
75	37.5	O	O	O	X	X	X
83	41.6	O	O	X	O	X	X
100	33.3	O	X	X	X	X	X
112	37.3	O	X	O	X	X	X
124	31	X	X	X	O	X	X
133	33.3	X	X	X	X	X	X
140	35	X	X	O	O	X	X
150	37.5	X	X	O	X	X	X

- ⚠ Note: We don't recommend you to set up your system speed to 75,83,112,124,140 or 150MHz because these frequencies are not the standard specifications for CPU, Chipset and most of the peripherals. Whether your system can run under 75,83,112,124,140 or 150 MHz properly will depend on your hardware configurations: CPU, SDRAM, Cards, etc.

### 3.6. CMOS RTC & ISA CFG CMOS RAM

There're RTC & CMOS RAM on board; they have a power supply from external battery to keep the DATA inviolate & effective. The RTC is a REAL-TIME CLOCK device, which provides the DATE & TIME to system. The CMOS RAM is used for keeping the information of system configuration, so the system can automatically boot OS every time. Since the lifetime of internal battery is 5 years, the user can change a new Battery to replace old one after it cannot work.

- ⚠ Danger of explosion if battery is incorrectly replaced.
- ⚠ Replace only with the same or equivalent type recommended by the manufacturer.
- ⚠ Dispose of used batteries according to the manufacturer's instructions.

### **3.7. SPEAKER CONNECTOR INSTALLATION**

There is a speaker in AT system for sound purpose. The 4 - Pins connector **SPK** is used to connect speaker.

### **3.8. HARDWARE RESET SWITCH CONNECTOR INSTALLATION**

The RESET switch on panel provides users with HARDWARE RESET function. The system will do a cold start after the RESET switch is pushed and released by user. The RESET switch is a 2 PIN connector and should be installed to **RST** on Motherboard.

### **3.9. POWER LED CONNECTOR INSTALLATION**

System has Power LED lamp on the panel of case. The Power LED will light on off or flash to indicate which step on the system. The connector should be connected to **PW** of Motherboard in correct direction.

### **3.10. IDE & ATAPI DEVICE INSTALLATION**

There are two-Enhanced PCI IDE ports (**IDE1, IDE2**) on board, which following ATAPI standard SPEC. Any one IDE port can connected to two ATAPI devices (IDE Hard Disk, CD-ROM & Tape Driver), so total four ATAPI devices can exist in a system. The **HD** is the active LED port for ATAPI devices.

### **3.11. PERIPHERAL DEVICE INSTALLATION**

After the I/O device installation and jumpers setup, the Motherboard can be mounted into the case and fixed by screw. To complete the Motherboard installation, the peripheral device could be installed now. The basic system needs a display interface card. If the PCI - Bus device is to be installed in the system, any one of four PCI - Bus slots can be used.

### **3.12. KEYBOARD & PS/2 MOUSE INSTALLATION**

The Motherboard supports PS/2 Mouse. The BIOS will auto detect whether the PS/2 Mouse is installed or not & assign IRQ12 for PS/2 Mouse port if it is installed. After installing the peripheral device, the user should check everything again, and prepare to power-on the system.

## 4. BIOS CONFIGURATION

Award's BIOSROM has a built-in Setup program that allows users to modify the basic system configuration.

This type of information is stored in battery-backed CMOS RAM so that it retains the Setup information when the power is turned off.

### 4.1. ENTERING SETUP

Power ON the computer and press <Del> immediately will allow you to enter Setup.

The other way to enter Setup is to power on the computer, when the below message appears briefly at the bottom of the screen during the POST (Power On Self Test), press <Del> Key or simultaneously press <Ctrl>, <Alt>, and <Esc> keys.

- **Press DEL to enter SETUP.**

If the message disappears before you respond and you still wish to enter Setup, restart the system to try again by turning it OFF then ON or pressing the "RESET" button on the system case.

You may also restart by simultaneously press <Ctrl>,<Alt>, and <Del> keys.

---

## 4.2. CONTROL KEYS

Up arrow	Move to previous item.
Down arrow	Move to next item.
Left arrow	Move to the item in the left hand.
Right arrow	Move to the item in the right hand.
Esc key	Main Menu - Quit and not save changes into CMOS Status Page Setup Menu and Option Page Setup Menu - Exit current page and return to Main Menu.
PgUp key	Increase the numeric value or make changes.
PgDn key	Decrease the numeric value or make changes.
F1 key	General help, only for Status Page Setup Menu and Option Page Setup Menu.
F2 key	Change color from total 16 colors.
F3 key	Calendar, only for Status Page Setup Menu.
F4 key	Reserved.
F5 key	Restore the previous CMOS value from CMOS, only for Option Page Setup Menu.
F6 key	Load the default CMOS value from BIOS default table, only for Option Page Setup Menu.
F7 key	Load the default.
F8 key	Reserved.
F9 key	Reserved.
F10 key	Save all the CMOS changes, only for Main Menu.

### 4.3. GETTING HELP

#### 4.3.1 Main Menu

The on-line description of the highlighted setup function is displayed at the bottom of the screen.

#### 4.3.2 Status Page Setup Menu / Option Page Setup Menu

Press F1 to pop up a small help window that describes the appropriate keys to use and the possible selections for the highlighted item. To exit the Help Window press <Esc>.

### 4.4. THE MAIN MENU

Once you enter Award BIOS CMOS Setup Utility, the Main Menu (Figure 4.1) will appear on the screen.

The Main Menu allows you to select setup functions and exit choices. Use arrow keys to select among the items and press <Enter> to accept or enter the sub-menu.



Figure 4.1: Main Menu

- Standard CMOS setup  
This setup page includes all the items in a standard compatible BIOS.
- BIOS features setup  
This setup page includes all the items of Award special enhanced features.

- Chipset features setup  
This setup page includes all the items of chipset special features.
- Power management setup  
This setup page includes all the items of Green function features.
- PNP/PCI configuration  
This setup page includes all the items of PNP/PCI configuration features.
- Load BIOS defaults  
BIOS defaults indicates the most appropriate value of the system parameter which the system would be in safe configuration.
- Load Performance defaults  
Performance Defaults indicates the value of the system parameters which the system would be in best performance configuration.
- Integrated Peripherals  
This setup page includes all the items of peripherals features.
- Supervisor Password  
Change, set, or disable password. It allows you to limit access to the system and Setup, or just to Setup.
- User Password  
Change, set, or disable password. It allows you to limit access to the system.
- IDE HDD auto detection  
Automatically configure hard disk parameter.
- Save & exit setup  
Save CMOS value changes to CMOS and exit setup.
- Exit without save  
Abandon all CMOS value changes and exit setup.



## 4.5. STANDARD CMOS SETUP

The items in Standard CMOS Setup (Figure 4.2) are divided into 9 categories. Each category includes no, one or more than one setup items. Use the arrows to highlight the item and then use the <PgUp> or <PgDn> keys to select the value you want in each item.



Figure 4.2: Standard CMOS Setup

- Date

The date format is <week>, <month>, <day>, <year>. Press <F3> to show the calendar.

Week	The week, from Sun to Sat, determined by the BIOS and is display-only
Month	The month, Jan. through Dec.
Day	The day, from 1 to 31 (or the maximum allowed in the month)
Year	The year, from 1994 through 2079

- Time

The time format is <hour> <minute> <second>.

The time is calculated base on the 24-hour military-time clock.

For example, 1 p.m. is 13:00:00.

- Primary HDDs / Secondary HDDs

The category identify the types of hard disk from drive C to drive F 4 devices that has been installed in the computer.

There are three options for definable type; User, Auto and None .

Type User is user-definable; and type Auto means automatically detecting HDD's type and None means No IDE HDD installed.

If you select Type User, related information is asked to be entered to the following items.

Enter the information directly from the keyboard and press <Enter>.

Those information should be provided in the documentation from your hard disk vendor or the system manufacturer.

CYLS.	number of cylinders
HEADS	number of heads
PRECOMP	write precomp
LANDZONE	landing zone
SECTORS	number of sectors

If a hard disk has not been installed select NONE and press <Enter>.

- Drive A type / Drive B type

The category identify the types of floppy disk drive A or drive B that has been installed in the computer.

None	No floppy drive installed
360K, 5.25 in.	5-1/4 inch PC-type standard drive; 360 kilobyte capacity.
1.2M, 5.25 in.	5-1/4 inch AT-type high-density drive; 1.2 megabyte capacity (3-1/2 inch when 3 Mode is Enabled).
720K, 3.5 in.	3-1/2 inch double-sided drive; 720 kilobyte capacity
1.44M, 3.5 in.	3-1/2 inch double-sided drive; 1.44 megabyte capacity.
2.88M, 3.5 in.	3-1/2 inch double-sided drive; 2.88 megabyte capacity.

- Floppy 3 Mode Support (for Japan Area)

Disabled	Normal Floppy Drive.
Drive A	Drive A is 3 mode Floppy Drive.
Drive B	Drive B is 3 mode Floppy Drive.
Both	Drive A & B are 3 mode Floppy Drives.

- Video

The category detects the type of adapter used for the primary system monitor that must match your video display card and monitor.

Although secondary monitors are supported, you do not have to select the type in setup.

EGA/VGA	Enhanced Graphics Adapter/Video Graphics Array. For EGA, VGA, SVGA, or PGA monitor adapters
CGA 40	Color Graphics Adapter, power up in 40 column mode
CGA 80	Color Graphics Adapter, power up in 80 column mode
MONO	Monochrome adapter, includes high resolution monochrome adapters

- Halt on

The category determines whether the computer will stop if an error is detected during power up.

NO Errors	The system boot will not be stopped for any error that may be detected
All Errors	Whenever the BIOS detects a non-fatal error, the system will be stopped and you will be prompted
All, But Keyboard	The system boot will not stop for a keyboard error; it will stop for all other errors
All, But Diskette	The system boot will not stop for a disk error; it will stop for all other errors
All, But Disk/Key	The system boot will not stop for a keyboard or disk error; it will stop for all other errors

- Memory

The category is display-only which is determined by POST (Power On Self Test) of the BIOS.

**Base Memory**

The POST of the BIOS will determine the amount of base (or conventional) memory installed in the system.

The value of the base memory is typically 512 K for systems with 512 K memory installed on the motherboard, or 640 K for systems with 640 K or more memory installed on the motherboard.

**Extended Memory**

The BIOS determines how much extended memory is present during the POST.

This is the amount of memory located above 1 MB in the CPU's memory address map.

**Expanded Memory**

Expanded Memory in memory defined by the Lotus / Intel / Microsoft (LIM) standard as EMS.

Many standard DOS applications can not utilize memory above 640, the Expanded Memory Specification (EMS) swaps memory which not utilized by DOS with a section, or frame, so these applications can access all of the system memory.

Memory can be swapped by EMS is usually 64K within 1 MB or memory above 1 MB, depends on the chipset design.

Expanded memory device driver is required to use memory as Expanded Memory.

**Other Memory**

This refers to the memory located in the 640 to 1024 address space. This is memory that can be used for different applications.

DOS uses this area to load device drivers to keep as much base memory free for application programs. Most use for this area is Shadow RAM.

## 4.6. BIOS FEATURES SETUP

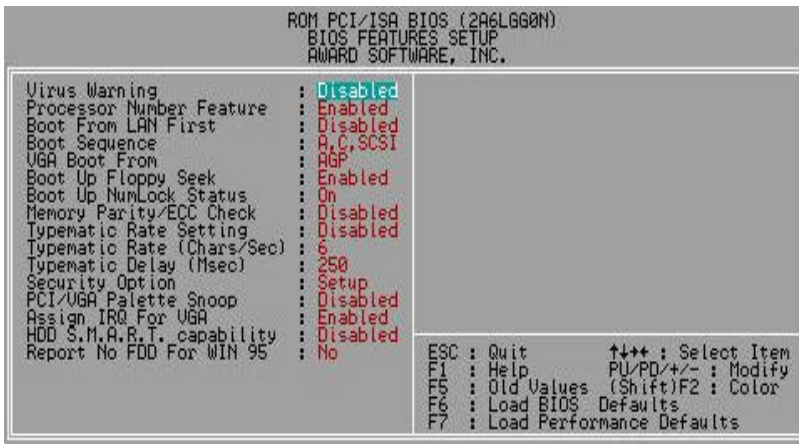

Figure 4.3: BIOS Features Setup

- Virus Warning

This category flashes on the screen. During and after the system boots up, any attempt to write to the boot sector or partition table of the hard disk drive will halt the system and the following error message will appear, in the mean time, you can run anti-virus program to locate the problem.

The default value is Disabled.

Enabled	Activate automatically when the system boots up causing a warning message to appear when anything attempts to access the boot sector or hard disk partition table.
Disabled	No warning message appears when anything attempts to access the boot sector or hard disk partition table.

- Processor Number Feature

The default value is Enabled.

Enabled	Enable Processor Number Feature.
Disabled	Disable Processor Number Feature.

- Boot From LAN First

The default value is Disabled.

Enabled	Enable Boot From LAN First.
Disabled	Disable Boot From LAN First.
AUTO	Auto detect Boot From LAN First.

- Boot Sequence

This category determines which drive computer searches first for the disk operating system (i.e., DOS). Default value is A, C, SCSI.

X1, X2, X3	System will first search for X1 disk drive then X2 disk drive and then X3 disk drive.
------------	---

- VGA Boot From

The default value is AGP

AGP	System will boot from AGP Display Card.
PCI Slot	System will boot from PCI Slot VGA Card.

- Boot Up Floppy Seek

During POST, BIOS will determine the floppy disk drive installed is 40 or 80 tracks. 360 K type is 40 tracks 720 K, 1.2 M and 1.44 M are all 80 tracks. The default value is Enabled.

Enabled	BIOS searches for floppy disk drive to determine it is 40 or 80 tracks. Note that BIOS can not tell from 720 K, 1.2 M or 1.44 M drive type as they are all 80 tracks.
Disabled	BIOS will not search for the type of floppy disk drive by track number. Note that there will not be any warning message if the drive installed is 360 K.

- Boot Up NumLock Status

The default value is On.

On	Keypad is number keys.
Off	Keypad is arrow keys.

- Memory Parity/ECC Check

The default value is Disabled.

Enabled	Enabled Memory Parity/ECC Check Function.
Disabled	Disabled Memory Parity/ECC Check Function.

- Typematic Rate Setting

The default value is Disabled.

Enabled	Enable Keyboard Typematic rate setting.
Disabled	Disable Keyboard Typematic rate setting.

- Typematic Rate (Chars / Sec.)

The default value is 6.

6-30	Set the maximum Typematic rate from 6 chars. Per second to 30 characters. Per second.
------	---

- Typematic Delay (Msec.)

The default value is 250.

250-1000	Set the time delay from first key to repeat the same key in to computer.
----------	--

- Security option

The default value is Setup.

Setup	The system will boot and access to Setup will be denied if the correct password is not entered at the prompt.
System	The system will not boot and access to Setup will be denied if the correct password is not entered at the prompt.

- To disable security, select PASSWORD SETTING at Main Menu and then you will be asked to enter password. If the user does not type anything and just press <Enter>, it will disable security. Once the security is disabled, the system will boot and you can enter Setup freely.

- PCI/VGA Palette Snoop

The default value are Disabled.

Enabled	For having Video Card on ISA Bus and VGA Card on PCI Bus.
Disabled	For VGA Card only.

- Assign IRQ For VGA

The default value is Enabled.

Enabled	Assign IRQ For VGA
Disabled	Not assign IRQ For VGA

- HDD S.M.A.R.T. Capability

The default value is Disable.

Enable	Enable HDD S.M.A.R.T. Capability
Disable	Disable HDD S.M.A.R.T. Capability

- Report No FDD For WIN 95

The default value is No.

No	Assign IRQ6 For FDD.
Yes	FDD Detect IRQ6 Automatically.



#### 4.7. CHIPSET FEATURES SETUP

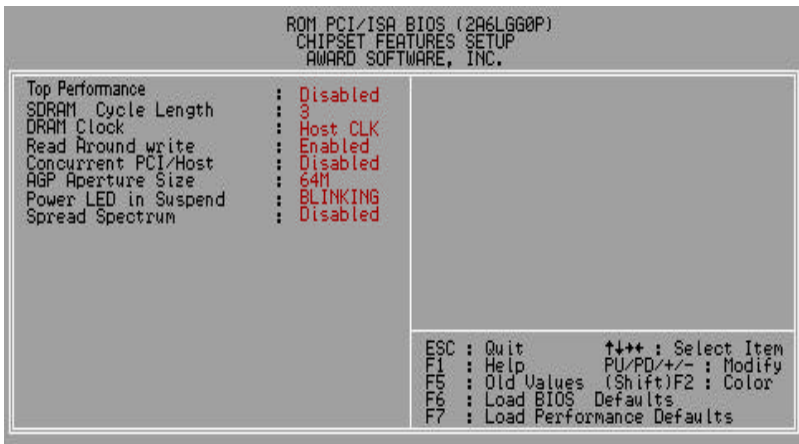

Figure 4.4: Chipset Features Setup

- Top Performance

The default value is Disabled.

Enabled	Enabled Top Performance.
Disabled	Disabled Top Performance. (Default)

- SDRAM Cycle Length

The default value is 3.

Auto	Set SDRAM Cycle Length is Auto
3	For Slower SDRAM DIMM module.
2	For Fastest SDRAM DIMM module.

- DRAM Clock

The default value is Host CLK

CPU CLK	DRAM CLK
66,75,83	Host CLK
	Host CLK +33M
100,112,124,133,140,150	Host CLK.

- Read Around write

The default value is Enabled.

Enabled	When set Enabled this feature speeds up data read performance.
Disabled	Normal operation.

- Concurrent PCI/Host

The default value is Disabled.

Enabled	Enabled Concurrent PCI/Host.
Disabled	Disabled Concurrent PCI/Host.

- AGP Aperture Size

The default value is 64MB

64MB	Set AGP Aperture Size to 64MB.
32MB	Set AGP Aperture Size to 32MB.
16MB	Set AGP Aperture Size to 16MB.
8MB	Set AGP Aperture Size to 8MB.
4MB	Set AGP Aperture Size to 4MB.
128MB	Set AGP Aperture Size to 128MB.

- Power LED in Suspend

The default value is BLINKING

BLINKING	Set Power LED in Suspend at BLINKING mode.
ON	Set Power LED in Suspend at ON mode.
OFF/DUAL	Set Power LED in Suspend at OFF/DUAL mode, if you use a dual color power LED, it will show dual color.

- Spread Spectrum

The default value is Disabled.

Disabled	Spread Spectrum Disabled
Enabled	Set Spread Spectrum Enabled.

## 4.8. POWER MANAGEMENT SETUP

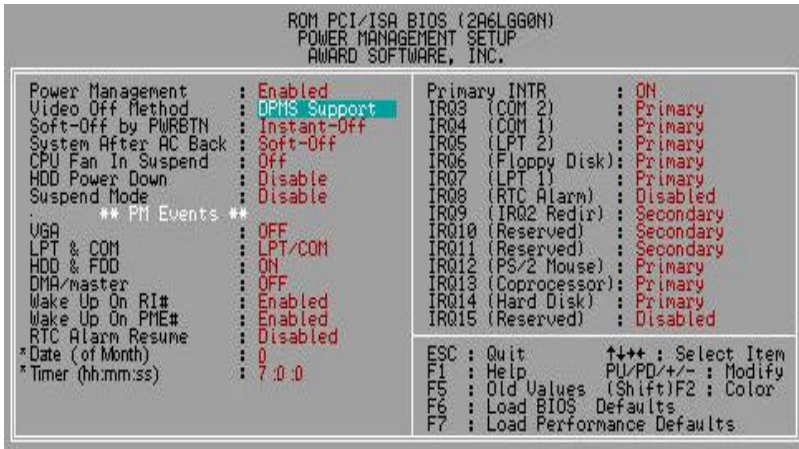

Figure 4.5: Power Management Setup

\* These two items will show up when “RTC Alarm Resume” is enabled.

- Power Management

The default value is Enabled.

Enabled	For configuring our own power management features.
Min Saving	Enable Green function.
Max Saving	Disable Green function.

- Video Off Method

The default value is DPMS Support.

V/H SYNC + Blank	BIOS will turn off V/H-SYNC when gets into Green mode for Green monitor power saving.
Blank Screen	BIOS will only black monitor when gets into Green mode.
DPMS Support	BIOS will use DPMS Standard to control VGA card. (The Green type VGA card will turn of V/H-SYNC automatically.)

- Soft-off by PWRBTN

The default value is Instant-off.

Instant-off	Soft switch ON/OFF for power ON/OFF.
Delay 4 sec	Soft switch on 4sec for power OFF.

- System After AC Back

The default value is Soft-Off.

Memory	This function depends on computer status
Soft-Off	Set System Soft-Off Status.
Full-On	Set System Full-On Status.

- CPU FAN In Suspend

The default value is Off.

On	Disable this function.
Off	Stop CPU FAN when entering Suspend mode.

- HDD Power Down

The default value is Disabled.

Disabled	Disabled HDD Power Down mode function.
1-15 mins.	Enabled HDD Power Down mode between 1 to 15 mins.

- Suspend Mode

The default value is Disabled.

Disabled	Disabled Suspend Mode.
10 Sec - 1 Hour	Setup the timer to enter Suspend Mode.

- VGA

The default value is OFF.

OFF	Disable monitor VGA activity.
ON	Enable monitor VGA activity.

- LPT & COM

The default value is LPT/COM.

LPT/COM	Enabled LPT/COM Ports Activity.
NONE	Normal Operation.
LPT	Enabled LPT Ports Activity.
COM	Enabled COM Ports Activity.

- HDD & FDD

The default value is ON.

ON	Enabled HDD & FDD Ports Activity
OFF	Disabled HDD & FDD Ports Activity

- DMA/master

The default value is OFF.

ON	Don' t detect DMA/master PM event.
OFF	Normal Operation.

- Wake Up On RI#

The default value is Enabled .

Enabled	Enable Wake Up On LAN/Ring
Disabled	Disable Wake Up On LAN/Ring

- Wake Up On PME#

The default value is Enabled.

Enabled	Enable Wake Up On PME#
Disabled	Disable Wake Up On PME#

- RTC Alarm Resume

You can set "RTC Alarm Resume" item to Enabled and key in date/time to power on system. The default value is Disabled.

Disabled	Disable this function.
Enabled	Enable alarm function to POWER ON system.

If the "RTC Alarm Resume" is Enabled.

Date ( of Month) Alarm :	0~31
Time ( hh: mm: ss) Alarm :	(0~23) : (0~59) : (0~59)

- Primary INTR

The default value is ON.

ON	Primary INTR function is on.
OFF	Normal Operation.

- IRQ [3~15]

The default value is Primary/Secondary/Disabled.

Disabled	Disable this function.
Primary	The resource is used by Primary device .
Secondary	The resource is used by Secondary device .

## 4.9. PNP/PCI CONFIGURATION

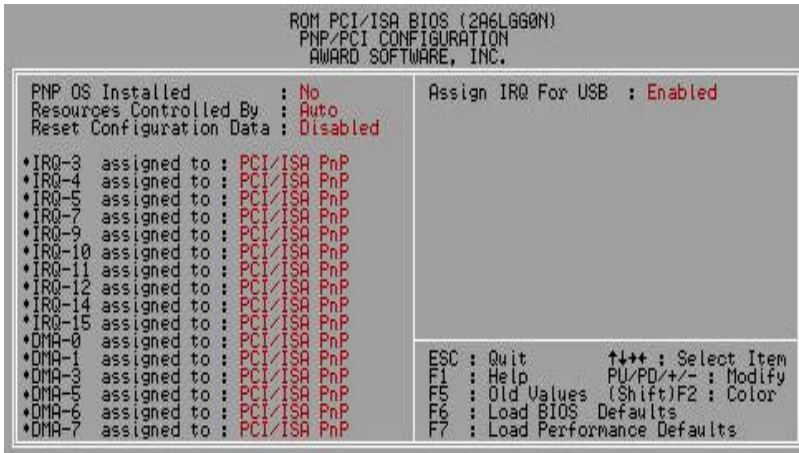

Figure 4.6: PNP/PCI Configuration

- ☛ IRQ[3.4.5.7.9.10.11.12.14.15] & DMA[1.3.5.6.7] These items will show up when “Resources Controlled By” is Manual.

- PNP OS Installed

The default value is No.

Yes	Enable PNP OS Installed function.
No	Disable PNP OS Installed function.

- Resources Controlled by

The default value is Auto.

Manual	User can set the PnP resource (I/O Address, IRQ & DMA channels) used by legacy ISA DEVICE.
Auto	BIOS automatically use these PnP rescuers.

- Reset Configuration Data

The default value is Disabled.

Disabled	Disable this function.
ESCD	Enable clear PnP information in ESCD.
DMI	Enable clear PnP information in DMI.
BOTH	Enable clear PnP information in ESCD and DMI.

- IRQ (3,4,5,7,9,10,11,12,14,15), DMA(0,1,3,5,6,7) assigned to

The default value is "Legacy ISA" or "PCI/ISA PnP".

Legacy ISA	The resource is used by Legacy ISA device.
PCI/ISA PnP	The resource is used by PCI/ISA PnP device (PCI or ISA).

- Assign IRQ For USB

The default value is Enabled.

Enabled	Assign a specific IRQ for USB.
Disabled	No IRQ is assigned for USB.



#### 4.10. LOAD BIOS DEFAULTS

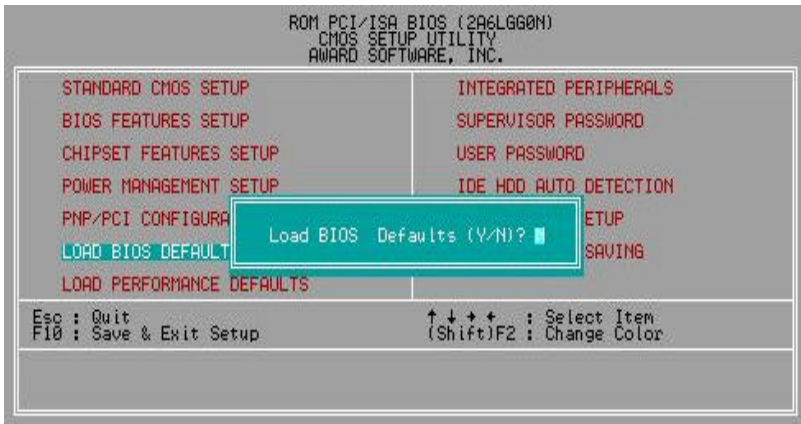

Figure 4.7: Load BIOS Defaults

- Load BIOS Defaults

To load BIOS defaults value to CMOS , enter "Y". If not, enter "N".

#### 4.11. LOAD PERFORMANCE DEFAULTS



Figure 4.8: Load Performance Defaults

- Load Performance Defaults

To load Performance defaults value to CMOS, enter "Y". If not, enter "N".

- If there is any problem occurred, loading PERFORMANCE DEFAULTS step is recommended.

## 4.12. INTEGRATED PERIPHERALS



Figure 4.9: Integrated peripherals

\*\* This items will show up when "UART2 Mode Select" is set to IrDA 1.0or ASKIR.

\* This item will show up when "Keyboard Power On: Multikey" is selected.

- USB Controller

The default value is Enabled.

Enabled	Enabled USB Controller.
Disabled	Disabled USB Controller.

- USB Keyboard Support

The default value is Disabled.

Enabled	Enabled USB Keyboard Support.
Disabled	Disabled USB Keyboard Support.

- Onboard Serial Port 1

The default value is 3F8/IRQ4.

Auto	BIOS will automatically setup the port 1 address.
3F8/IRQ4	Enable onboard Serial port 1 and address is 3F8.
2F8/IRQ3	Enable onboard Serial port 1 and address is 2F8.
3E8/IRQ4	Enable onboard Serial port 1 and address is 3E8.

2E8/IRQ3	Enable onboard Serial port 1 and address is 2E8.
Disabled	Disable onboard Serial port 1.

- Onboard Serial Port 2

The default value is 2F8/IRQ3.

Auto	BIOS will automatically setup the port 2 address.
3F8/IRQ4	Enable onboard Serial port 2 and address is 3F8.
2F8/IRQ3	Enable onboard Serial port 2 and address is 2F8.
3E8/IRQ4	Enable onboard Serial port 2 and address is 3E8.
2E8/IRQ3	Enable onboard Serial port 2 and address is 2E8.
Disabled	Disable onboard Serial port 2.

- Onboard Parallel port

The default value is 378/IRQ7.

378/IRQ7	Enable onboard LPT port and address is 378/IRQ7.
278/IRQ5	Enable onboard LPT port and address is 278/IRQ5.
3BC/IRQ7	Enable onboard LPT port and address is 3BC/IRQ7.
Disabled	Disable onboard LPT port.

- Parallel Port Mode

The default value is SPP.

SPP	Using Parallel port as Standard Parallel Port.
EPP	Using Parallel port as Enhanced Parallel Port.
ECP	Using Parallel port as Extended Capabilities Port.
ECP+EPP	Using Parallel port as ECP & EPP mode.

- UART2 Mode

(This item allows you to determine which UART2 Mode of onboard I/O chip), the default value is Standard.

ASKIR	Set onboard I/O chip UART2 to ASKIR Mode.
IrDA 1.0	Set onboard I/O chip UART2 to IrDA Mode.
Standard	Set onboard I/O chip UART2 to Standard Mode.

- UART2 Duplex Mode

The default value is Half.

Half	Set UART2 Duplex Mode to Half.
Full	Set UART2 Duplex Mode to Full.

- PS/2 Mouse Power on

The default value is Disabled.

Disabled	Disable PS/2 Mouse Power on .
Db Click	Double click PS/2 Mouse bottom.

- Keyboard Power on

The default value is POWER Key.

POWER Key	If your keyboard have "POWER Key" button, you can press the key to power on your system.
Multi key	Enter multikey combination to Power on system.

- KB Power On Password

Enter	Enter from 1 to 5 characters to set the Keyboard Power On Password.
-------	---

### 4.13. SUPERVISOR / USER PASSWORD

When you select this function, the following message will appear at the center of the screen to assist you in creating a password.



Figure 4.10: Password Setting

Type the password, up to eight characters, and press <Enter>. The password typed now will clear previously entered password from CMOS memory.

You will be asked to confirm the password. Type the password again and press <Enter>. You may also press <Esc> to abort the selection and not enter a password.

To disable password, just press <Enter> when you are prompted to enter password. A message will confirm the password being disabled.

Once the password is disabled, the system will boot and you can enter Setup freely.

#### PASSWORD DISABLED

If you select "System" at "Security Option" of BIOS Features Setup Menu, you will be prompted for the password every time the system is rebooted or any time you try to enter Setup.

If you select "Setup" at "Security Option" of BIOS Features Setup Menu, you will be prompted only when you try to enter Setup.

#### 4.14. IDE HDD AUTO DETECTION

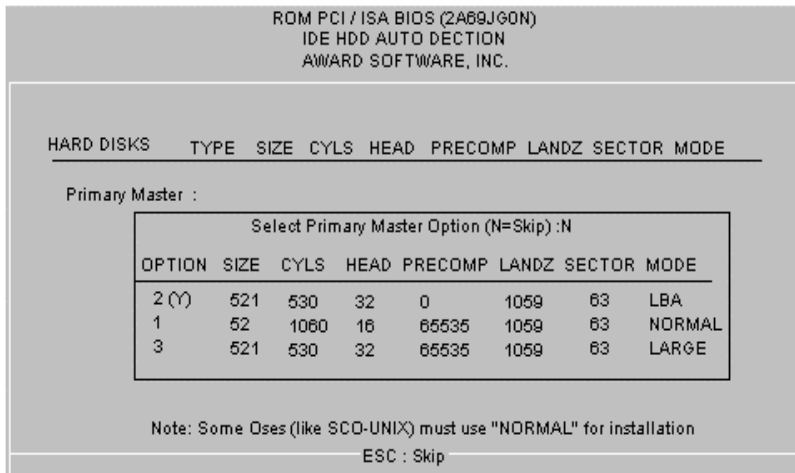

Figure 4.11: IDE HDD Auto Detection

Type "Y" will accept the H.D.D. parameter reported by BIOS.

Type "N" will keep the old H.D.D. parameter setup. If the hard disk cylinder NO. is over 1024, then the user can select LBA mode or LARGE mode for DOS partition larger than 528 MB.

#### 4.15. SAVE & EXIT SETUP



Figure 4.12: Save & Exit Setup

Type "Y" will quit the Setup Utility and save the user setup value to RTC CMOS .

Type "N" will return to Setup Utility.



#### 4.16. EXIT WITHOUT SAVING



Figure 4.13: Exit Without Saving

Type "Y" will quit the Setup Utility without saving to RTC CMOS .

Type "N" will return to Setup Utility.



## Appendix A: BIOS Flash Procedure

BIOS update procedure:

- ✓ Please check your BIOS vendor (AMI or AWARD) on the motherboard.
- ✓ It is recommended you copy the AWDFlash.exe or AMIFlash.exe in driver CD (D:\>Utility\BIOSFlash) and the BIOS binary files into the directory you made in your hard disk. 【i.e:C:\>Utility\ (C:\>Utility : denotes the driver and the directory where you put the flash utilities and BIOS file in.)】
- ✓ Restart your computer into MS-DOS mode or command prompt only for Win95/98, go into the directory where the new BIOS file are located Use the utility AWDFlash.exe or AMIFlash.exe to update the BIOS.
- ✓ Type the following command once you have enter the directory where all the files are located  
C:\utility\ AWDFlash or AMIFlash <filename of the BIOS binary file intended for flashing>
- ✓ Once the process is finished, reboot the system

● Note : Please download the newest BIOS from our website ([www.gigabyte.com.tw](http://www.gigabyte.com.tw)) or contact your local dealer for the file.

## Appendix B : VIA Chipsets Driver Installation

### VIA 4 in 1 Service Pack Utility:

Insert the support CD that came with your motherboard into your CD-ROM driver or double -click the CD driver icon in My Computer to bring up the screen.



(1)

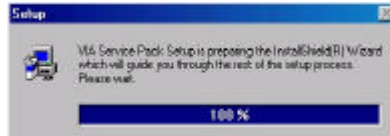

(2)

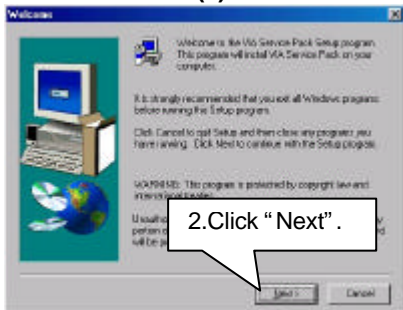

(3)

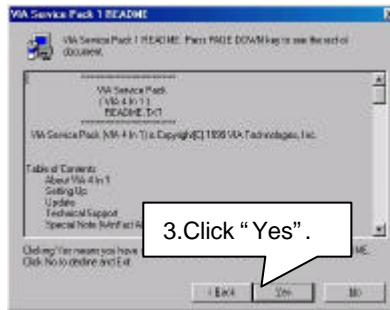

(4)

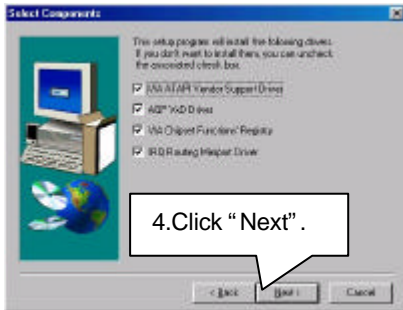

(5)

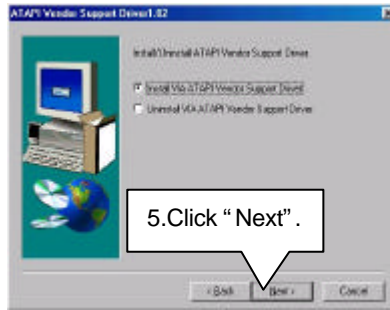

(6)

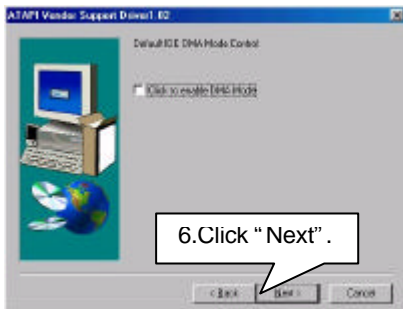

(7)



(8)

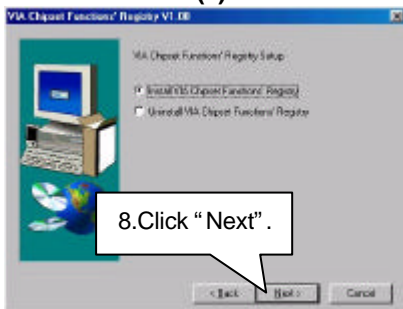

(9)

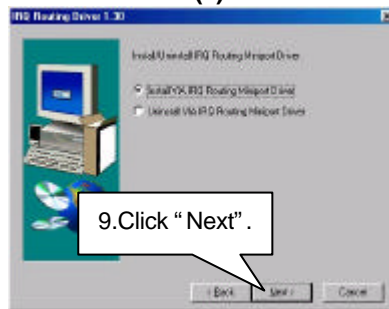

(10)

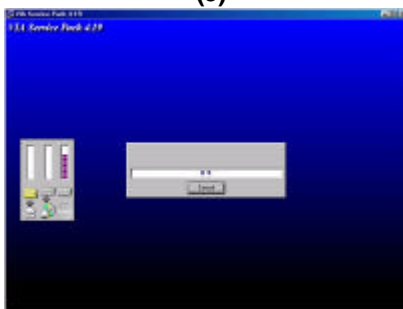

(11)

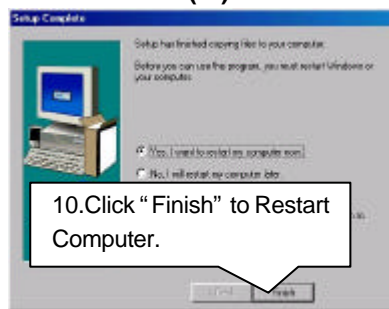

(12)



**DECLARATION OF CONFORMITY**  
Per FCC Part 15 Section 2.1071(a)

**FCC**

Responsible Party Name: G.B.T. INC.  
Address: 18365 Valley Blvd., Suite#A  
LA Puente, CA 91744  
Phone/Fax No: (818) 854-9338 / (818) 854-9339

I hereby declare that the product  
Product Name: Mother Board  
Model Number: GA-6VXE7

Conforms to the following specifications:  
FCC Part 15, Subpart B, Section 15.107(a) and Section 15.109(a).  
Class B Digital Device.

**Supplementary Information:**  
This device complies with part 5 of the FCC Rules. Operation is subject to the following two conditions: (1) This device may not cause harmful interference and (2) this device must accept any interference received, including that may cause undesired operation.

Representative Person's Name: Eric L. G.  
Signature: Eric L. G.  
Date: Mar. 16, 2009

**FCC Compliance Statement:**

This equipment has been tested and found to comply with limits for a Class B digital device, pursuant to Part 15 of the FCC rules. These limits are designed to provide reasonable protection against harmful interference in residential installations. This equipment generates, uses, and can radiate radio frequency energy, and if not installed and used in accordance with the instructions, may cause harmful interference to radio communications. However, there is no guarantee that interference will not occur in a particular installation. If this equipment does cause

interference to radio or television equipment reception, which can be determined by turning the equipment off and on, the user is encouraged to try to correct the interference by one or more of the following measures:

- Reorient or relocate the receiving antenna
- Move the equipment away from the receiver
- Plug the equipment into an outlet on a circuit different from that to which the receiver is connected
- Consult the dealer or an experienced radio/television technician for additional suggestions

You are cautioned that any change or modifications to the equipment not expressly approved by the party responsible for compliance could void Your authority to operate such equipment.

This device complies with Part 15 of the FCC Rules. Operation is subjected to the following two conditions 1) this device may not cause harmful interference and 2) this device must accept any interference received, including interference that may cause undesired operation.

## Declaration of Conformity

We, Manufacturer/Importer  
(full address)

**G.B.T. Technology Trading GMBH**  
Ausschlagler Weg 41, 1F, 20537 Hamburg, Germany

declare that the product  
(description of the apparatus, system, installation to which it refers)

**Mother Board**  
GA-6VXE7+

is in conformity with  
(reference to the specification under which conformity is declared)  
in accordance with 89/336 EEC-EMC Directive

- |   |  |  |  |
|---|--|--|--|
| <input type="checkbox"/> EN 55011   | Limits and methods of measurement of radio disturbance characteristics of industrial, scientific and medical (ISM) high frequency equipment                | <input type="checkbox"/> EN 61000-3-2*   | Disturbances in supply systems caused by household appliances and similar electrical equipment "Harmonics"   |
| <input type="checkbox"/> EN55013  | Limits and methods of measurement of radio disturbance characteristics of broadcast receivers and associated equipment                                     | <input type="checkbox"/> EN61000-3-3*<br><input checked="" type="checkbox"/> EN60555-3           | Disturbances in supply systems caused by household appliances and similar electrical equipment "Voltage fluctuations"                                  |
| <input type="checkbox"/> EN 55014   | Limits and methods of measurement of radio disturbance characteristics of household electrical appliances, portable tools and similar electrical apparatus | <input checked="" type="checkbox"/> EN 50081-1<br><input checked="" type="checkbox"/> EN 50082-1 | Generic emission standard Part 1: Residual, commercial and light industry<br>Generic immunity standard Part 1: Residual, commercial and light industry |
| <input type="checkbox"/> EN 55015   | Limits and methods of measurement of radio disturbance characteristics of fluorescent lamps and luminaries   | <input type="checkbox"/> EN 55081-2  | Generic emission standard Part 2: Industrial environment   |
| <input type="checkbox"/> EN 55020   | Immunity from radio interference of broadcast receivers and associated equipment   | <input type="checkbox"/> EN 55082-2  | Generic immunity standard Part 2: Industrial environment   |
| <input checked="" type="checkbox"/> EN 55022  | Limits and methods of measurement of radio disturbance characteristics of information technology equipment   | <input type="checkbox"/> ENV 55104   | Immunity requirements for household appliances tools and similar apparatus   |
| <input type="checkbox"/> DIN VDE 0855<br><input type="checkbox"/> part 10<br><input type="checkbox"/> part 12 | Cabled distribution systems; Equipment for receiving and/or distribution from sound and television signals   | <input type="checkbox"/> EN 50091- 2   | EMC requirements for uninterruptible power systems (UPS)   |

CE marking



The manufacturer also declares the conformity of above mentioned product with the actual required safety standards in accordance with LVD 73/23 EEC

- |                                   |   |                                     |   |
|-----------------------------------|---|-------------------------------------|---|
| <input type="checkbox"/> EN 60065 | Safety requirements for mains operated electronic and related apparatus for household and similar general use | <input type="checkbox"/> EN 60950   | Safety for information technology equipment including electrical business equipment |
| <input type="checkbox"/> EN 60335 | Safety of household and similar electrical appliances   | <input type="checkbox"/> EN 50091-1 | General and Safety requirements for uninterruptible power systems (UPS)             |

**Manufacturer/Importer**

(Stamp)

Date : Mar. 16 ,2000

Signature : RexLin  
Name : Rex Lin