

6BXE

USER'S MANUAL

- 1. System power on by PS/2 Mouse: First, enable this function in CMOS Setup, then you can power on the system by double clicking the right or left button of your PS/2 Mouse.**
- 2. System power on by Keyboard: If your ATX power supply supports larger than 300 mA 5V Stand-By current (dependent on the specification of keyboards), you can power on your system by entering password from the keyboard after setting the " Keyboard power on " password in CMOS Setup.**
- 3. Supports 3 steps ACPI LED.**
- 4. Support Modem Ring-On. (Include internal Modem and external modem on COM A and COM B)**
- 5. Wake-Up on LAN. (on JP7) (The ATX power supply supports larger than 720 mA 5V Stand-By current)**
- 6. CPU Over Voltage Protect**

**For Intel Pentium[®] II / III / Celeron[™] Processor MAINBOARD
REV. 2.0 First Edition**

R-20-01-090310

The author assumes no responsibility for any errors or omissions which may appear in this document nor does it make a commitment to update the information contained herein.

Third-party brands and names are the property of their respective owners.

Sound Blaster is a registered trademark of Creative Technology Ltd in the United States and certain other countries. Sound Blaster-LINK and SB-LINK are trademarks of Creative Technology Ltd.

Mar. 10 , 1999 Taipei, Taiwan

I. Quick Installation Guide :**CPU SPEED SETUP**

The system bus speed is selectable between 66 / 100 MHz. The user can select the system bus speed and change the DIP SWITCH (**SW**) selection to set up the CPU speed for 233 - 650MHz processor.

ON: O OFF: X

CPU Type	SW1	SW2	SW3	SW4	SW5	SW6	SW7	SW8
Pentium® II 233 MHz (Celeron™ 233MHz)	X	X	O	O	O	X	X	O
Pentium® II 266 MHz (Celeron™ 266MHz)	O	O	X	O	O	X	X	O
Pentium® II 300 MHz (Celeron™ 300MHz)	X	O	X	O	O	X	X	O
Pentium® II 333 MHz (Celeron™ 333MHz)	O	X	X	O	O	X	X	O
Pentium® II 366 MHz (Celeron™ 366MHz)	X	X	X	O	O	X	X	O
Pentium® II 400 MHz (Celeron™ 400MHz)	O	O	O	X	O	X	b	O
Pentium® II 433 MHz (Celeron™ 433MHz)	X	O	O	X	O	X	X	O
Pentium® II 350 MHz	X	X	O	O	X	X	X	X
Pentium® II 400 MHz	O	O	X	O	X	X	X	X
Pentium® III 450 MHz	X	O	X	O	X	X	X	X
Pentium® III 500 MHz	O	X	X	O	X	X	X	X
Pentium® III 550 MHz	X	X	X	O	X	X	X	X
Pentium® III 600 MHz	O	O	O	X	X	X	X	X
Pentium® III 650 MHz	X	O	O	X	b	b	b	b

CLK RATIO	SW1	SW2	SW3	SW 4
X3	O	X	O	O
X3.5	X	X	O	O
X4	O	O	X	O
X4.5	X	O	X	O
X5	O	X	X	O
X5.5	X	X	X	O
X6	O	O	O	X
X6.5	X	O	O	X
X 7	O	X	O	X
X 7.5	X	X	O	X
X 8	O	O	X	X
X 8.5	X	O	X	X
X 9	O	X	X	X
X 9.5	X	X	X	X

Main Clock Table				
CLK	SW5	SW6	SW7	SW8
66 MHz	O	X	X	ⓐ
75 MHz	O	X	O	O
83 MHz	O	O	X	O
100 MHz	X	X	X	X
112 MHz	X	X	O	X
124 MHz	X	O	O	X
133MHz	X	O	X	X
PCI Run 44.3 MHz	←			
133 MHz	O	O	O	X
PCI Run 33.3 MHz	←			

★ **Note:** We don't recommend you to setup your system speed to 75, 83, 112, 124 or 133MHz because these frequencies are not the standard specifications for CPU, Chipset and most of the peripherals. Whether your system can run under 75, 83, 112, 124 or 133MHz properly will depend on your hardware configurations: CPU, SDRAM, Cards, etc.

1. Pentium® II / Celeron™ 233 MHz / 66MHz FSB

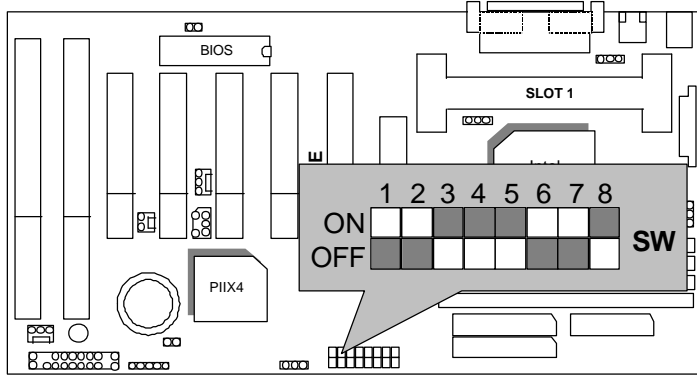

2. Pentium® II / Celeron™ 266MHz / 66MHz FSB

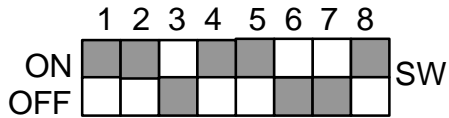

3. Pentium® II / Celeron™ 300MHz / Celeron™ 300A MHz / 66MHz FSB

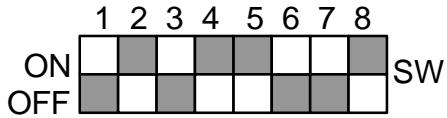

4. Pentium® II / Celeron™ 333MHz / 66MHz FSB

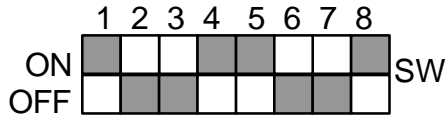

5. Pentium® II / Celeron™ 366 MHz / 66MHz FSB

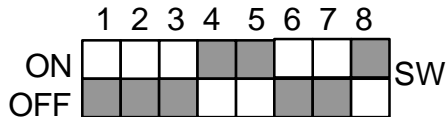

6. Pentium® II / Celeron™ 400 MHz / 66MHz FSB

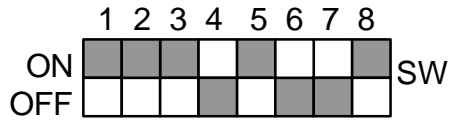

7. Pentium® II / Celeron™ 433 MHz / 66MHz FSB

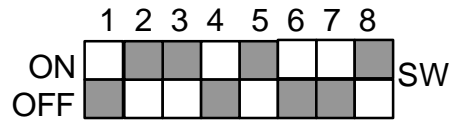

8. Pentium® II 350MHz / 100MHz FSB

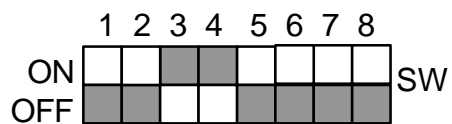

9. Pentium® II 400MHz / 100MHz FSB

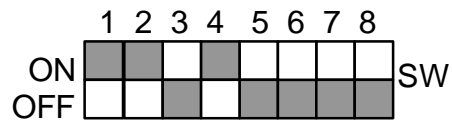

10. Pentium® III 450MHz / 100MHz FSB

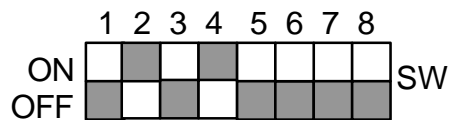

11. Pentium® III 500MHz / 100MHz FSB

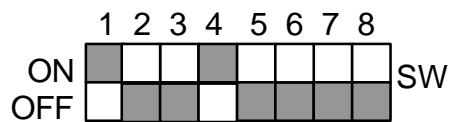

12. Pentium® III 550MHz / 100MHz FSB

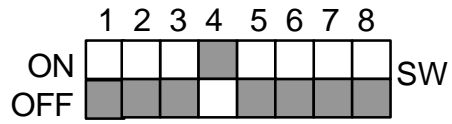

13. Pentium® III 600MHz / 100MHz FSB

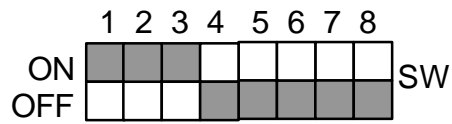

14. Pentium® III 650MHz / 100MHz FSB

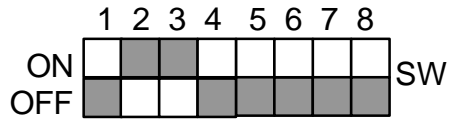

II. Jumper setting :

SPK : External Speaker/ Internal Buzzer Connector

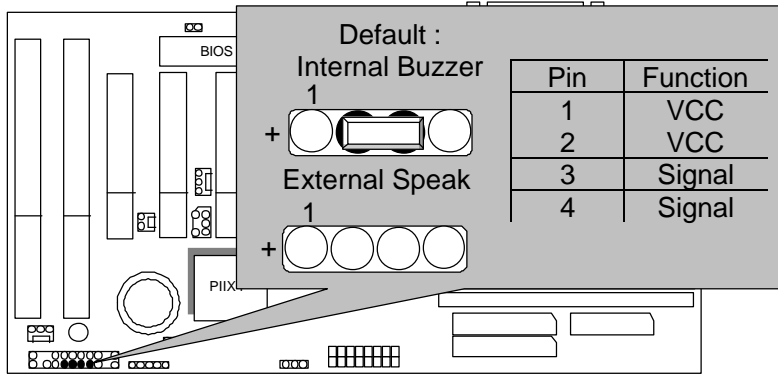

RST : Reset Switch

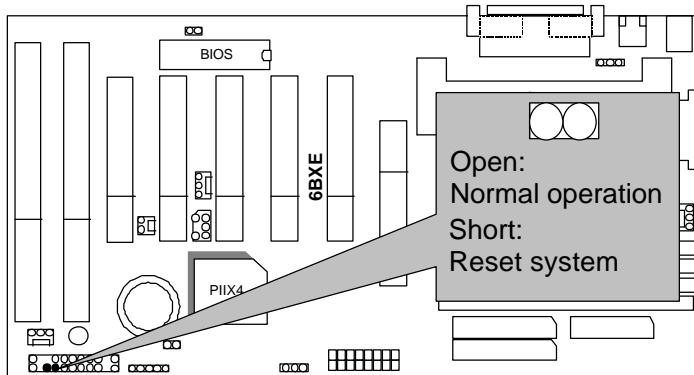

PW LED : Power LED Connector

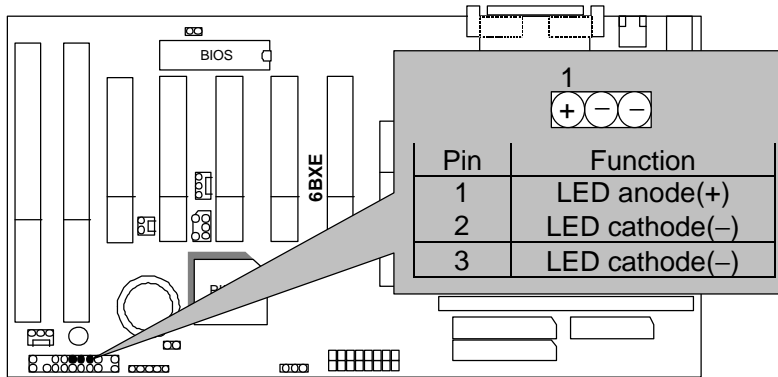

HD : IDE Hard Disk Active LED

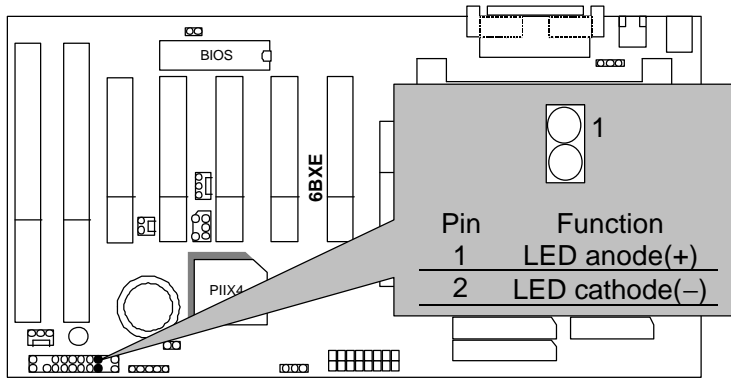

IR : Infrared Connector (Optional)

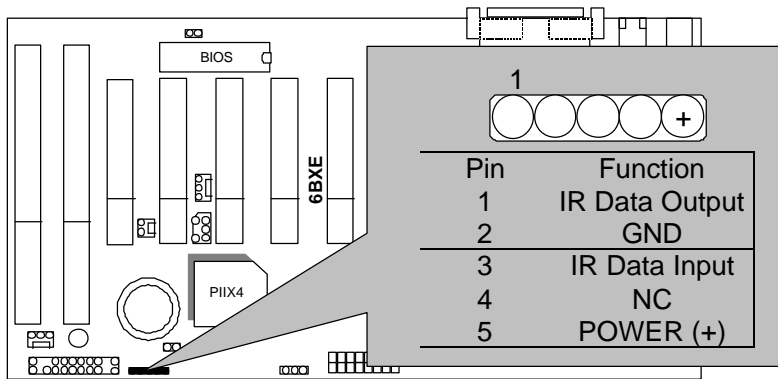

GN : Green Function Switch

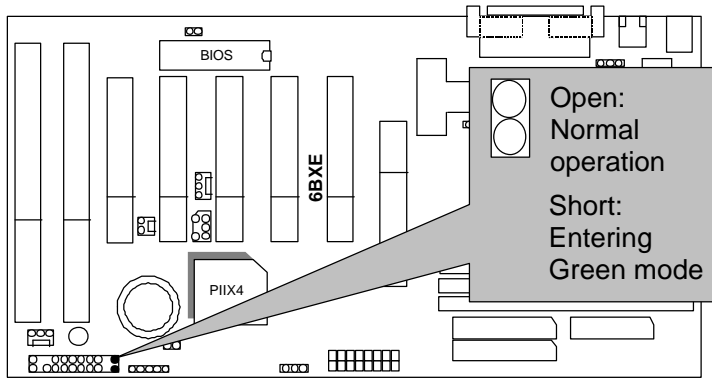

GD : Green LED

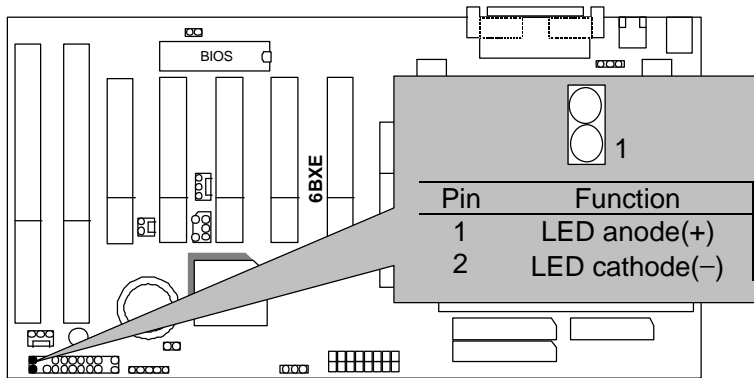

Soft POWER : Soft Power Connector

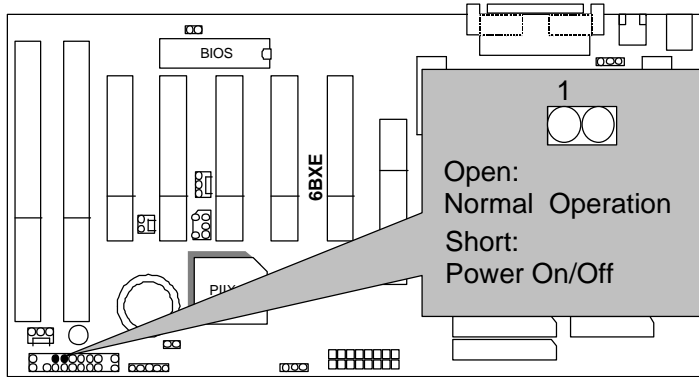

ATX POWER : ATX POWER Connector

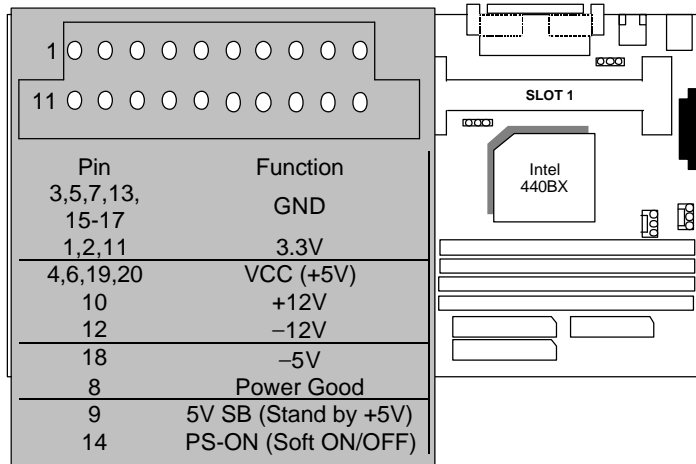

PS/2 Mouse / Keyboard Connector

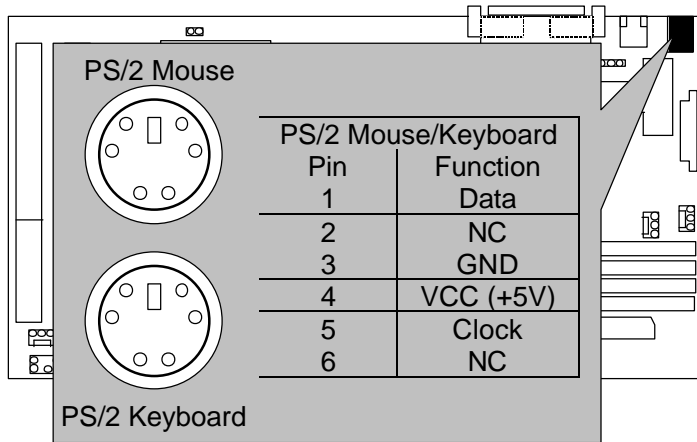

CPU FAN : CPU Cooling Fan Power Connector

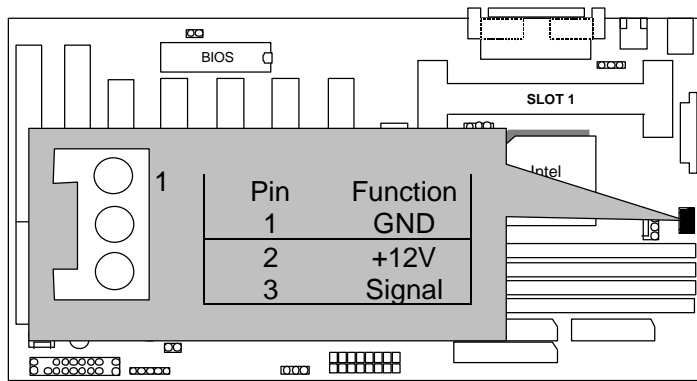

POWER FAN : Power Fan Connector

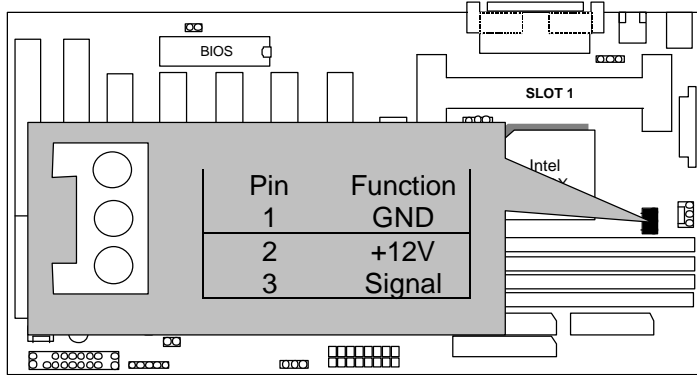

PANEL FAN : Panel Fan Connector

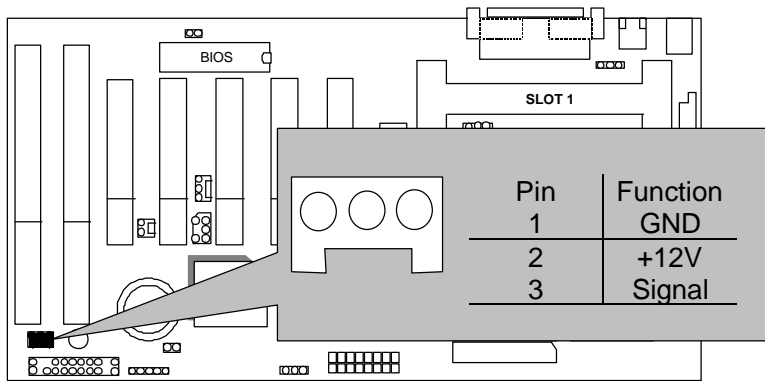

IDE1: For Primary IDE port

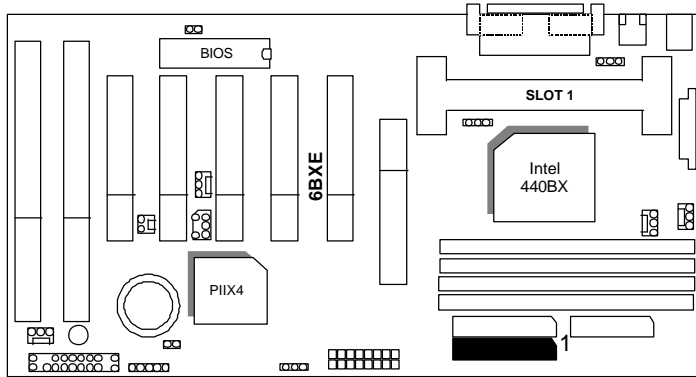

IDE2: For Secondary IDE port

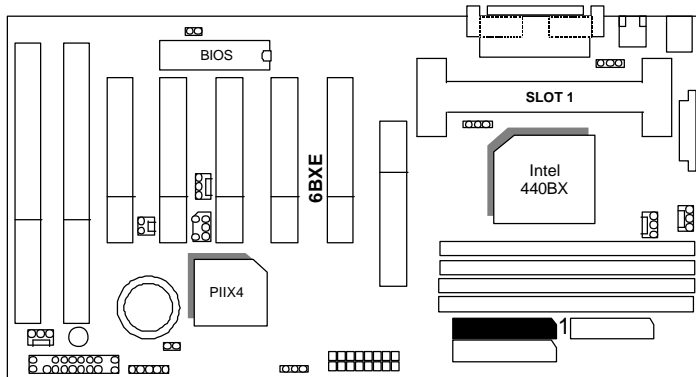

FLOPPY : FLOPPY PORT

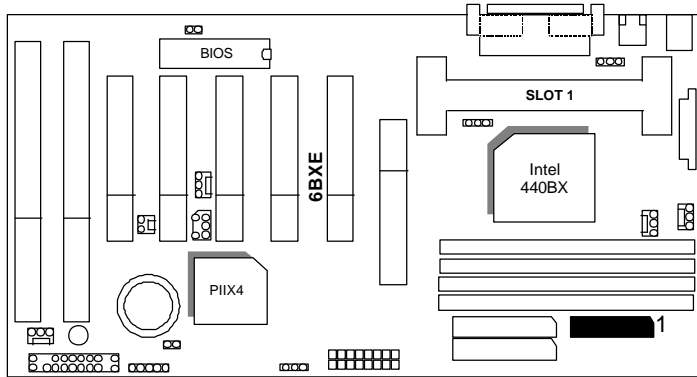

LPT PORT / COM A / COM B

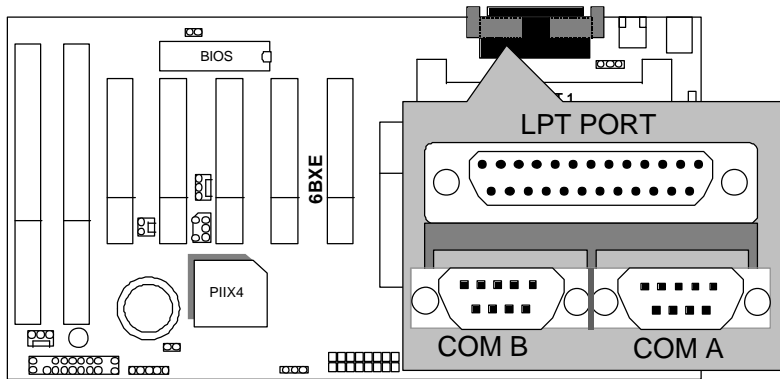

JP1 : Keyboard Power On Selection

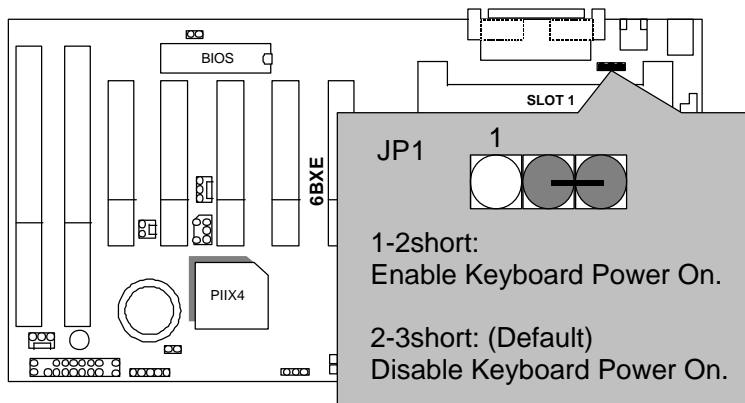

USB : USB Port

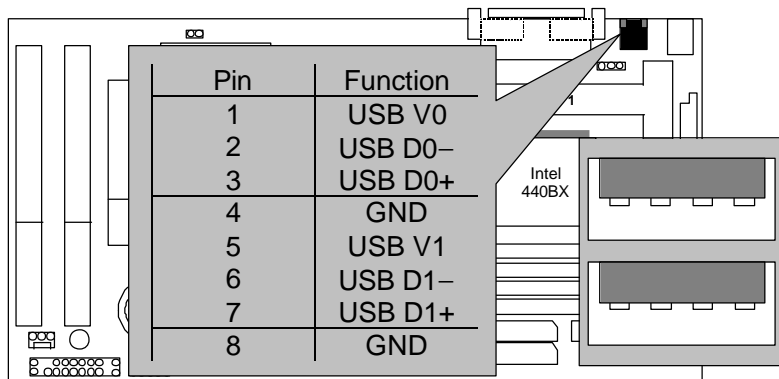

J15: System After AC Back

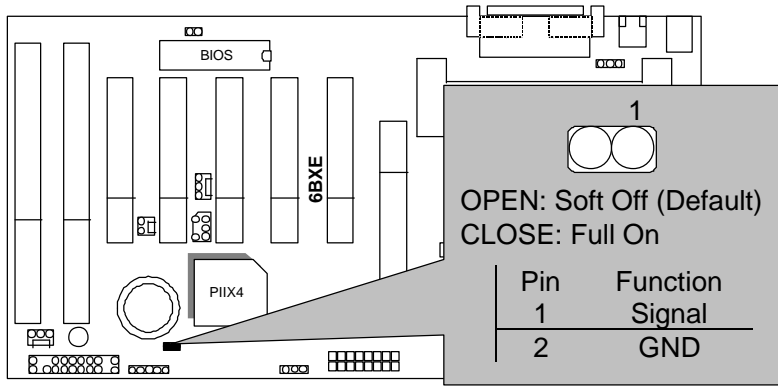

JP7: Wake On LAN

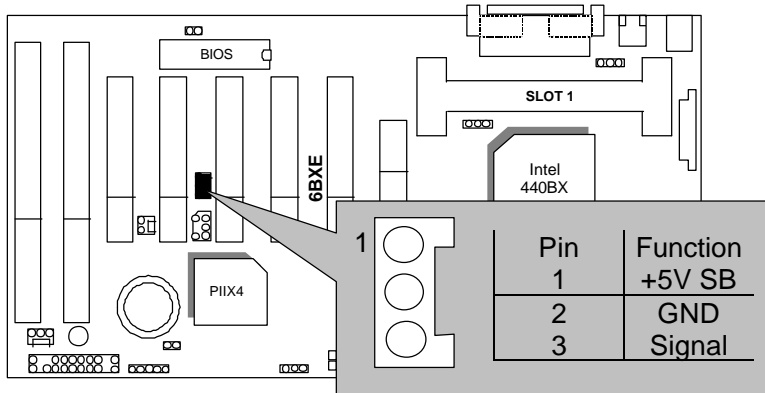

JP8:SB-LINK Creative PCI Sound Card Support

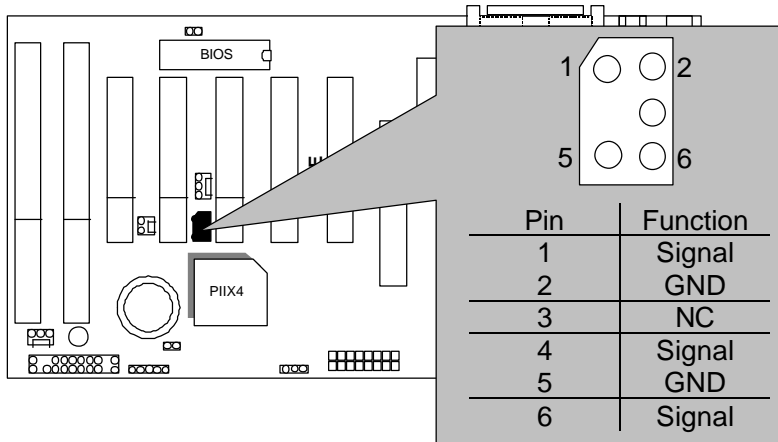

JP11 : System Acceleration

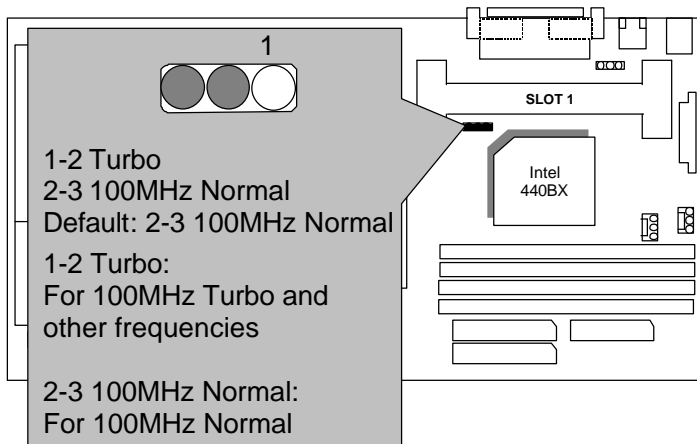

JP12 : CASE OPEN (Optional)

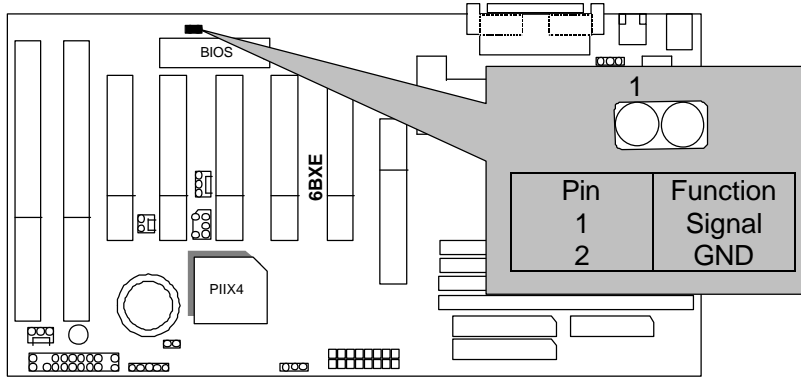

JP14 : CLEAR CMOS FUNCTION

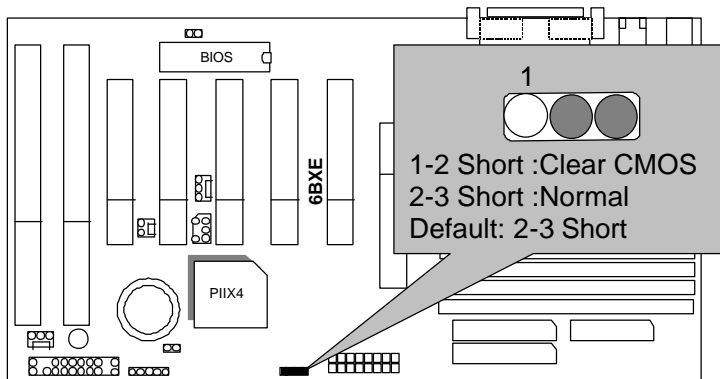

J18:Internal Modem Card Ring PWR On

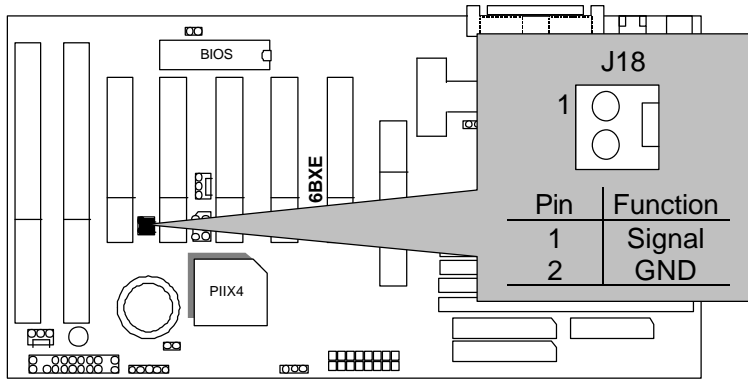

BAT1 :BATTERY

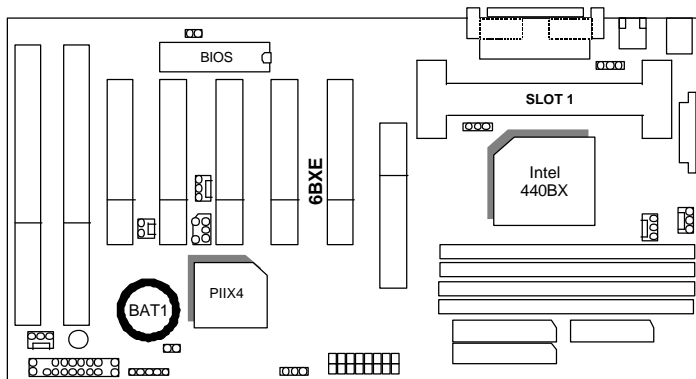

- ⚠ Danger of explosion if battery is incorrectly replaced.
- ⚠ Replace only with the same or equivalent type recommended by the manufacturer.

- Dispose of used batteries according to the manufacturer's instructions.

III. Top Performance Test Setting:

The following performance data list is the testing results of some popular benchmark testing programs.

```

ROM PCI/ISA BIOS (2A69K60E)
CHIPSET FEATURES SETUP
AWARD SOFTWARE, INC.

Reset Case Open Status      : No
Case Opened                 : No
Slow Down CPU Duty Cycle    : Normal
Shutdown Temp.(°C/°F)      : 75/167
**Temp. Select (°C/°F)**
CPU :70/158
**Temperature Alarm**
CPU :No
**Current Temp.(°C/°F)**
CPU :33/91
**Fan Fail Alarm**
CPU:No    POWER:No    PANEL:No
**Current Fan Speed (RPM)**
CPU:5443  POWER:0     PANEL:0
**Current Voltage (V)**
UCORE :1.95  VGTL :1.52  UCC3:3.35
+5V: 5.08  +12V:12.52 -12V:-11.86
-5V:-5.09  VBAT: 3.26  5USB:5.05

EDO CAS# Wait State        : 1
EDO RAS# Wait State        : 1
SDRAM CAS Latency Time     : 2
DRAM Data Integrity Mode   : Non-ECC
System BIOS Cacheable      : Enabled
Video BIOS Cacheable       : Enabled
Video RAM Cacheable        : Enabled
16Bit I/O Recovery Time    : 1
Memory Hole At 15M-16M     : Disabled
Delayed Transaction        : Disabled
Clock Spread Spectrum      : Disabled

ESC : Quit          ↑↓↓ : Select Item
F1  : Help          PU/PD/+/- : Modify
F5  : Old Values   (Shift)F2 : Color
F6  : Load BIOS   Defaults
F7  : LOAD PERFORMANCE DEFAULTS

```

Users have to modify the value for each item in chipset features as follow for top performance setting.

These data are just referred by users, and there is no responsibility for different testing data values gotten by users. (Different Hardware & Software configuration will result in different benchmark testing results.)

- CPU Pentium® II / III processor
- DRAM (128 x 1) MB SDRAM (TOSHIBA TC59S6408FTL-80H)
- CACHE SIZE 512 KB included in CPU
- DISPLAY GA-630 AGP Display Card (16MB SGRAM)
- STORAGE Onboard IDE (Seagate ST34520A)
- O.S. Windows NT™ 4.0 (SP4)
- DRIVER Display Driver at 1024 x 768 x 256 colors x 75Hz.
TRIONES Bus Master IDE Driver 3.60

Processor	Pentium® II	Pentium® III
	400MHz(100x4)	500MHz(100x5)
Winbench99		
CPU mark32	1040	1260
FPU Winmark	2060	2550
Business Disk	4360	4450
Hi-End Disk	10400	10900
Business Graphics	145	166
Hi-End Graphics	368	442
Winstone99		
Business	29.8	33
Hi-End	27.6	31.5

TABLE OF CONTENTS

1. INTRODUCTION

1.1. PREFACE.....1-1
1.2. KEY FEATHERS.....1-1
1.3. PERFORMANCE LIST.....1-2
1.4. BLOCK DIAGRAM.....1-3
1.5. INTRODUCE THE PENTIUM® II / III PROCESSOR1-4
1.6. WHAT IS AGP?.....1-5

2. SPECIFICATION

2.1. HARDWARE2-1
2.2. SOFTWARE.....2-2
2.3. ENVIRONMENT.....2-2

3. HARDWARE INSTALLATION

3.1. UNPACKING3-1
3.2. MAINBOARD LAYOUT3-2
3.3. QUICK REFERENCE FOR JUMPERS & CONNECTORS.....3-2
3.4. DRAM INSTALLATION3-6
3.5. CPU SPEED SETUP.....3-6
3.6. CMOS RTC & ISA CFG CMOS SRAM.....3-7
3.7. SPEAKER CONNECTOR INSTALLATION.....3-7
3.8. HARDWARE RESET SWITCH CONNECTOR INSTALLATION.....3-7
3.9. POWER LED CONNECTOR INSTALLATION.....3-7
3.10. IDE & ATAPI DEVICE INSTALLATION3-8

3.11. PERIPHERAL DEVICE INSTALLATION.....3-8

3.12. KEYBOARD & PS/2 MOUSE INSTALLATION.....3-8

4. BIOS CONFIGURATION

4.1. ENTERING SETUP4-1

4.2. CONTROL KEYS4-1

4.3. GETTING HELP4-2

 4.3.1. Main Menu4-2

 4.3.2. Status Page Setup Menu / Option Page Setup Menu.....4-2

4.4. THE MAIN MENU.....4-2

4.5. STANDARD CMOS SETUP MENU4-4

4.6. BIOS FEATURES SETUP4-8

4.7. CHIPSET FEATURES SETUP.....4-13

4.8. POWER MANAGEMENT SETUP.....4-17

4.9. PNP/PCI CONFIGURATION.....4-21

4.10. LOAD BIOS DEFAULTS4-23

4.11. LOAD PERFORMANCE DEFAULTS4-24

4.12. INTEGRATED PERIPHERALS4-25

4.13. SPUERVISOR PASSOWORD/USER PASSWORD.....4-30

4.14. IDE HDD AUTO DETECTION.....4-31

4.15. SAVE & EXIT SETUP.....4-32

4.16. EXIT WITHOUT SAVING4-33

1. INTRODUCTION

1.1. PREFACE

Welcome to use the **6BXE** motherboard. It is a Pentium® II / III / Celeron™ Processor based PC / AT compatible system with AGP / PCI / ISA Bus, and has been designed to be the fastest PC / AT system. There are some new features allow you to operate the system with just the performance you want.

This manual also explains how to install the motherboard for operation, and how to set up your CMOS CONFIGURATION with BIOS SETUP program.

1.2. KEY FEATURES

- ❑ Intel Pentium® II / III / Celeron™ Processor based PC / AT compatible main board.
- ❑ Slot 1 supports Pentium® II / III / Celeron™ processor running at 233-650 MHz.
- ❑ Intel 440BX chipset, Supports AGP / SDRAM / Ultra DMA33 IDE / Keyboard and PS/2 Mouse Power On / ACPI features.
- ❑ Supports 4xDIMMs using 3.3V SDRAM DIMM module.
- ❑ Supports Intel LDCM® Network Manageability.
- ❑ Supports external Modem Ring-On on COMA & COMB and internal Modem Ring-On.
- ❑ Supports 16MB – 1GB SDRAM memory on board.
- ❑ Supports CPU Over Voltage Protect.
- ❑ Supports ECC or Non-ECC type DRAM module.
- ❑ 1xAGP slot, 5xPCI Bus slots, 2xISA Bus slots.
- ❑ Supports 2 channels Ultra DMA 33 IDE ports for 4 IDE Devices.
- ❑ Supports 2xCOM (16550), 1xLPT (EPP / ECP), 1xFDD port.
- ❑ Supports 2xUSB ports, 1xPS/2 Mouse & 1xPS/2 Keyboard.
- ❑ Licensed AWARD BIOS, 2M bits FLASH RAM.
- ❑ 30.5 cm x 19 cm ATX SIZE form factor, 4 layers PCB.

1.3. PERFORMANCE LIST

The following performance data list is the testing results of some popular benchmark testing programs.

These data are just referred by users, and there is no responsibility for different testing data values gotten by users. (Different Hardware & Software configuration will result in different benchmark testing results.)

- CPU Pentium® II / III processor
- DRAM (128 x 1) MB SDRAM (TOSHIBA TC59S6408FTL-80H)
- CACHE SIZE 512 KB included in CPU
- DISPLAY GA-630 AGP Display Card (16MB SGRAM)
- STORAGE Onboard IDE (Seagate ST34520A)
- O.S. Windows NT™ 4.0 (SP4)
- DRIVER Display Driver at 1024 x 768 x 256 colors x 75Hz.
TRIONES Bus Master IDE Driver 3.60

Processor	Pentium® II	Pentium® III
	400MHz(100x4)	500MHz(100x5)
Winbench99		
CPU mark32	1040	1260
FPU Winmark	2060	2550
Business Disk	4360	4450
Hi-End Disk	10400	10900
Business Graphics	145	166
Hi-End Graphics	368	442
Winstone99		
Business	29.8	33
Hi-End	27.6	31.5

1.4. BLOCK DIAGRAM

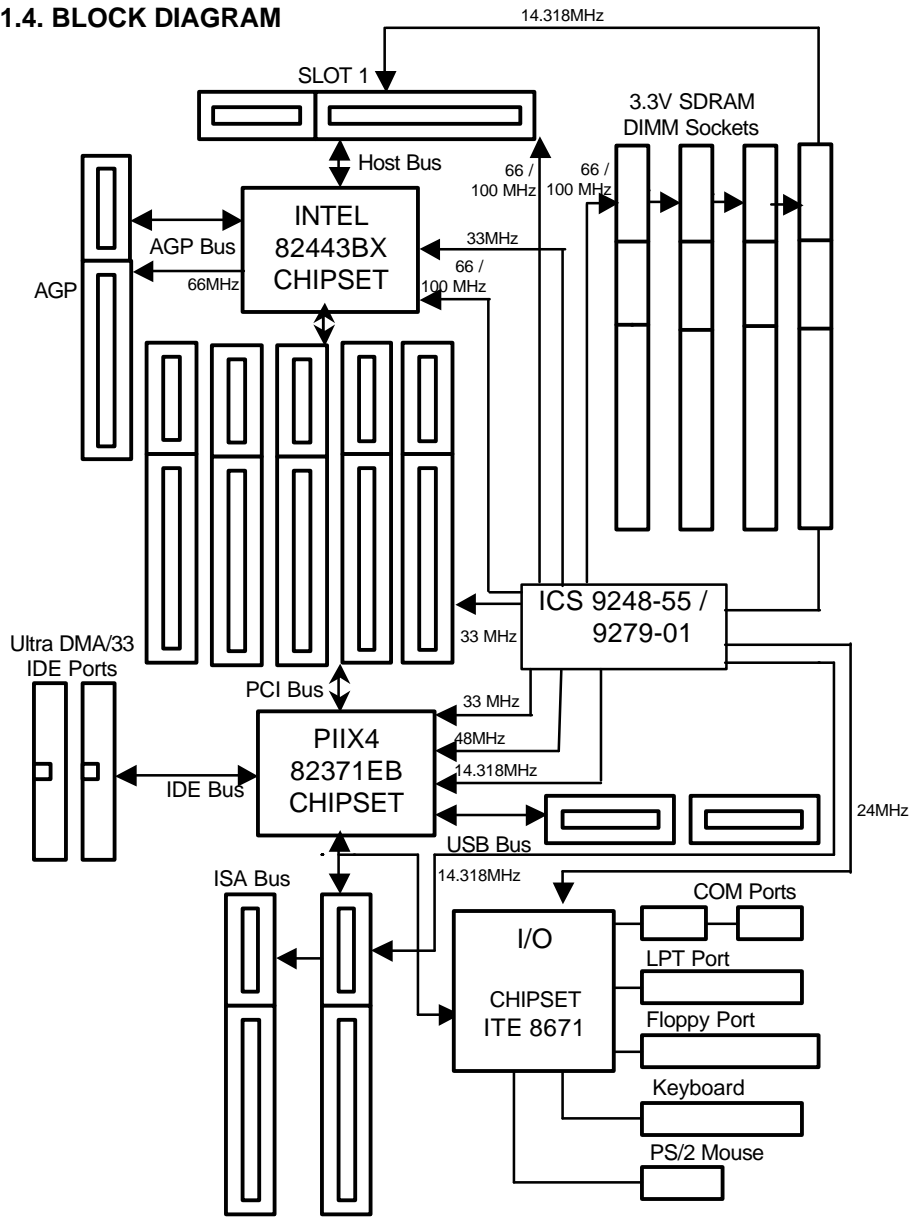

1.5. INTRODUCE THE Pentium® II / III Processor

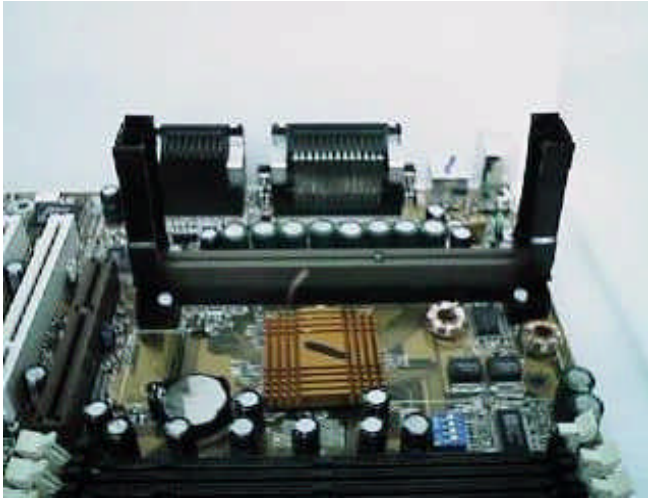

Figure 1: Universal Retention Mechanism & attach Mount



Figure 2: OEM Pentium® II Processor



Figure 3: OEM Pentium® III Processor

1.6 What is AGP?

The Accelerated Graphics Port (AGP) is a new port on the Host-To-PCI bridge device that supports an AGP port. The main purpose of the AGP port is to provide fast access to system memory.

The AGP port can be used either as fast PCI port (32-bits at 66MHz vs.32-Bits at 33MHz) or as an AGP port which supports 2x data-rate, a read queue, and side band addressing. When the 2x-data rate is used the port can transmit data at 533MB/sec ($66.6 \times 2 \times 4$). The read-queue can be used to pipeline reads – removing the effects of the reads-latency. Side band addressing can be used to transmit the data address on a separate line in order to speed up the transaction.

2. SPECIFICATION

2.1. HARDWARE

- CPU
 - Pentium® II / III / Celeron™ processor 233 – 650 MHz.
 - 242 pins 66 / 100MHz slot1 on board.
- PROTECTION
 - Speaker Alarm when detect "CPU FAN Failure" or "CPU Overheat".
 - Automatically slow down CPU speed when "CPU Overheat".
 - Intel LDCM® supported.
 - H/W monitor power status ($\pm 5V$, $\pm 12V$, VGTL, 5VSB, CPU voltage & CMOS battery voltage).(Optional)
- SPEED
 - 66/100 MHz system speed.
 - 66 MHz AGP bus speed. (2X mode 133MHz)
 - 33 MHz PCI-Bus speed.
 - 8 MHz AT bus speed.
- DRAM MEMORY
 - 4 banks 168 pins DIMM module sockets on board.
 - Use 16 / 32 / 64 / 128 / 256 MB DIMM module DRAM.
 - 16 ~ 1GB SDRAM.
 - Supports 3.3V SDRAM.
 - Supports ECC or Non-ECC type DRAM.
- CACHE MEMORY
 - 32 KB L1 cache memory included in CPU.
 - 128KB / 512 KB L2 cache memory included in CPU.
 - Supports DIB speed mode for L2 Cache.
- I/O BUS SLOTS
 - 5 33MHz Master / Slave PCI-BUS.
 - 2 8MHz 16 bits ISA BUS.
 - 1 66MHz / 133MHz AGP bus.
- IDE PORTS
 - 2 Ultra DMA/33 Bus Master IDE channels onboard. (Using IRQ14,15)
 - Support Mode 3,4 IDE & ATAPI CD – ROM.

- I/O PORTS
 - Supports 2 16550 COM ports.
 - Supports 1 EPP/ECP LPT port.
 - Supports 1 1.44 / 2.88 MB Floppy port.
 - Supports 2 USB ports.
 - Supports PS/2 Mouse & PS/2 Keyboard.
- GREEN FUNCTION
 - Suspend mode support.
 - Green switch & ACPI LED support.
 - IDE & Display power down support.
 - Monitor all IRQ / DMA / Display / I/O events.
- BIOS
 - 2M bits FLASH RAM.
 - Supports Plug & Play, DMI , ACPI Function.
- DIMENSION
 - ATX Form Factor, 4 layers PCB.

2.2. SOFTWARE

- DRIVER
 - INTEL Bus Master IDE Driver.
 - Suspend to HD utility.
 - INTEL LDCM®.
- BIOS
 - Licensed AWARD BIOS.
 - AT CMOS Setup, BIOS / Chipset Setup, Green Setup, Hard Disk Utility included.
- O.S.
 - Operation with MS-DOS®, Windows®95, Windows®98, WINDOWS NT™, OS/2, NOVELL and SCO UNIX.

2.3. ENVIRONMENT

- Ambient Temp.
 - 0°C to +50°C (Operating).
- Relative Hum.
 - 0 to +85% (Operating).
- Altitude
 - 0 to 10,000 feet (Operating).
- Vibration
 - 0 to 1,000 Hz.
- Electricity
 - 4.9 V to 5.2 V. (Max. 20A current at 5V.)

3. HARDWARE INSTALLATION

3.1. UNPACKING

The main board package should contain the following:

- The **6BXE** main board.
- Universal Retention Mechanism & Attach Mount
- USER'S MANUAL for main board.
- Cable set for IDE, Floppy devices.
- Diskette or CD for main board Utility.

The main board contains sensitive electric components, which can be easily damaged by static electricity, so the main board should be left in its original packing until it is installed.

Unpacking and installation should be done on a grounded anti-static mat. The operator should be wearing an anti static wristband, grounded at the same point as the anti-static mat.

Inspect the main board carton for obvious damage. Shipping and handling may cause damage to your board. Be sure there are no shipping and handling damages on the board before proceeding.

After opening the main board carton, extract the system board and place it only on a grounded anti-static surface component side up. Again inspect the board for damage. Press down on all of the socket IC's to make sure that they are properly seated. Do this only on with the board placed on a firm flat surface.

⚠ DO NOT APPLY POWER TO THE BOARD IF IT HAS BEEN DAMAGED.

3.2. MAINBOARD LAYOUT

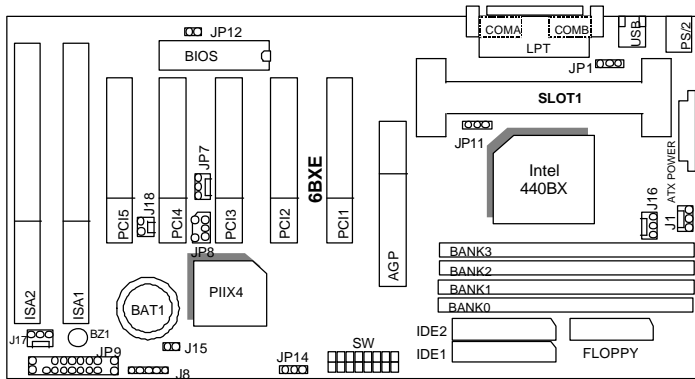

<Figure 3.1>

3.3. QUICK REFERENCE FOR JUMPERS & CONNECTORS

◆ I/O Ports Connector	
USB	USB port.
IDE 1	For Primary IDE port.
IDE 2	For Secondary IDE port.
PS/2	For PS/2 Keyboard port.
PS/2	For PS/2 Mouse port.
Floppy	For Floppy port
COM B	For Serial port2 (COM B).
COM A	For Serial port1 (COM A).
ATX POWER	For ATX Power Connector.
LPT	For LPT port.

◆ Slot 1
For Pentium® II / III / Celeron™ Processor installed

◆ J1 :CPU FAN : CPU Cooling FAN Power Connector	
Pin	Function
1	GND.
2	+12V
3	Signal

◆ J16:POWER FAN : POWER FAN Power Connector	
Pin	Function
1	GND.
2	+12V
3	Signal

◆ J17 :PANEL FAN: PANEL FAN Power Connector	
Pin	Function
1	GND.
2	+12V
3	Signal

◆ J15 : System After Ac Back	
Open	Soft Off
Short	Full On

◆ JP1 : Keyboard Power On Selection	
Pin	Function
1-2	Enabled Keyboard power on.
2-3	Disabled Keyboard power on.

◆ JP11 : System Acceleration	
Pin	Function
1-2 short	For 100MHz Turbo and other frequencies
2-3 short	For 100MHz Normal

◆ JP7 :Wake on LAN Connector	
Pin	Function
1	+5VSB
2	GND
3	Signal

◆ SB-LINK (For PCI Sound Card Connector)	
Pin	Function
1	Signal
2	GND
3	NC

4	Signal
5	GND
6	Signal

◆ JP12 : CASE OPEN (Optional)	
Pin	Function
1	Signal
2	GND

◆ IR: INFRARED Connector (OPTIONAL)	
Pin	Function
1	IR DATA OUTPUT
2	GND
3	IR DATA INPUT
4	NC
5	POWER(+)

◆ JP14 : CLEAR CMOS	
Pin	Function
1-2 short	Clear CMOS
2-3 short	Normal

JP9 : 2*11PIN Jumper

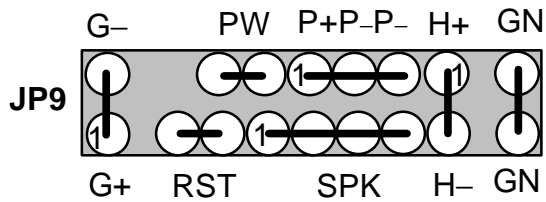

PW : Soft Power Connector



Open: Normal Operation
Short: Power On/Off

RST : Reset Switch



Open: Normal Operation
Short: For Hardware Reset System

P+P- P- : Power LED



PIN 1 : LED anode (+)
PIN 2 : LED cathode (-)
PIN 3 : LED cathode (-)

SPK : External Speaker Connector



PIN 1 : VCC (+)
PIN 2 : VCC
PIN 3 : Signal
PIN 4 : Signal

SPK : Internal Speaker Connector (Default)



PIN 1 : VCC (+)
PIN 2-PIN3 : Short
PIN 4 : Data (-)

H+H- : IDE Hard Disk Active LED



PIN 1: LED anode (+)
PIN 2: LED cathode (-)

GN: Green Function Switch



Open : Normal operation
Short : Entering Green Mode

G- G+: Green LED



PIN 1 : LED anode (+)
PIN 2 : LED cathode (-)

3.4. DRAM INSTALLATION

The main board can be installed with 16 / 32 / 64 / 128 / 256 MB 168 pins DIMM module DRAM, and the DRAM speed must be 67~100 MHz for SDRAM when system bus speed is set to 66MHz. When system bus speed is set to 100MHz, 100MHz SDRAM is required. The DRAM memory system on main board consists of bank 0, 1, 2 & bank 3.

Since 168 pins DIMM module is 64 bits width, therefore 1 piece of DIMM module may match a 64 bits system. The total memory size is 16 MB ~1GB SDRAM. The DRAM installation position refer to Figure 3.1, and notice the Pin 1 of DIMM module must match with the Pin 1 of DIMM socket. Insert the DRAM DIMM module into the DIMM socket at Vertical angle. If there is a wrong direction of Pin 1, the DRAM DIMM module could not be inserted into socket completely.

3.5. CPU SPEED SETUP

The system bus speed can be set to 66 / 100MHz form the DIP SWITCH (**SW**). The user can change the DIP SWITCH selection to set up the CPU speed for different processors.

ON: O OFF: X

CPU Type	SW1	SW2	SW3	SW4	SW5	SW6	SW7	SW8
Pentium® II 233 MHz (Celeron™ 233MHz)	X	X	O	O	O	X	X	O
Pentium® II 266 MHz (Celeron™ 266MHz)	O	O	X	O	O	X	X	O
Pentium® II 300 MHz (Celeron™ 300MHz)	X	O	X	O	O	X	X	O
Pentium® II 333 MHz (Celeron™ 333MHz)	O	X	X	O	O	X	X	O
Pentium® II 366 MHz	X	X	X	O	O	X	X	O

(Celeron™ 366MHz)								
Pentium® II 400 MHz (Celeron™ 400MHz)	○	○	○	×	○	×	b	○
Pentium® II 433 MHz (Celeron™ 433MHz)	×	○	○	×	○	×	×	○
Pentium® II 350 MHz	×	×	○	○	×	×	×	×
Pentium® II 400 MHz	○	○	×	○	×	×	×	×
Pentium® III 450 MHz	×	○	×	○	×	×	×	×
Pentium® III 500 MHz	○	×	×	○	×	×	×	×
Pentium® III 550 MHz	×	×	×	○	×	×	×	×
Pentium® III 600 MHz	○	○	○	×	×	×	×	×
Pentium® III 650 MHz	×	○	○	×	b	b	b	b

- ⚠ The CPU is a sensitive electric component and it can be easily damaged by static electricity, so users must keep it away from metal surface when the CPU is installed onto main board.

3.6. CMOS RTC & ISA CFG CMOS SRAM

There're RTC & CMOS SRAM on board; they have a power supply from external battery to keep the DATA inviolate & effective. The RTC is a REAL-TIME CLOCK device, which provides the DATE & TIME to system. The CMOS SRAM is used for keeping the information of system configuration, so the system can automatically boot OS every time. Since the lifetime of internal battery is 5 years, the user can change a new Battery to replace old one after it cannot work.

- ⚠ Danger of explosion if battery is incorrectly replaced.
- ⚠ Replace only with the same or equivalent type recommended by the manufacturer.
- ⚠ Dispose of used batteries according to the manufacturer's instructions.

3.7. SPEAKER CONNECTOR INSTALLATION

There is a speaker in AT system for sound purpose. The 4 - Pins connector **SPK** is used to connect speaker. Anode connects +, Cathode connects –.

3.8. HARDWARE RESET SWITCH CONNECTOR INSTALLATION

The RESET switch on panel provides users with HARDWARE RESET function. The system will do a cold start after the RESET switch is pushed and

released by user. The RESET switch is a 2 PIN connector and should be installed to **RST** on main board.

3.9. POWER LED CONNECTOR INSTALLATION

System has Power LED lamp on the panel of case. The Power LED will light on off or flash to indicate which step on the system. The connector should be connected to **PW** of main board in correct direction.

3.10. IDE & ATAPI DEVICE INSTALLATION

There are two-Enhanced PCI IDE ports (**IDE1, IDE2**) on board, which following ATAPI standard SPEC. Any one IDE port can connected to two ATAPI devices (IDE Hard Disk, CD-ROM & Tape Driver), so total four ATAPI devices can exist in a system. The **HD** is the active LED port for ATAPI devices.

3.11. PERIPHERAL DEVICE INSTALLATION

After the I/O device installation and jumpers setup, the main board can be mounted into the case and fixed by screw. To complete the main board installation, the peripheral device could be installed now. The basic system needs a display interface card. If the PCI - Bus device is to be installed in the system, any one of four PCI - Bus slots can be used.

3.12. KEYBOARD & PS/2 MOUSE INSTALLATION

The main board supports PS/2 Mouse (**J2**). The BIOS will auto detect whether the PS/2 Mouse is installed or not & assign IRQ12 for PS/2 Mouse port if it is installed. After installing the peripheral device, the user should check everything again, and prepare to power-on the system.

4. BIOS CONFIGURATION

Award's BIOS ROM has a built-in Setup program that allows users to modify the basic system configuration. This type of information is stored in battery-backed CMOS SRAM so that it retains the Setup information when the power is turned off.

4.1. ENTERING SETUP

Power ON the computer and press immediately will allow you to enter Setup. If the message disappears before you respond and you still wish to enter Setup, restart the system to try again by turning it OFF then ON or pressing the "RESET" button on the system case. You may also restart by simultaneously press <Ctrl>, <Alt>, and keys.

4.2. CONTROL KEYS

Up arrow	Move to previous item
Down arrow	Move to next item
Left arrow	Move to the item in the left hand
Right arrow	Move to the item in the right hand
Esc key	Main Menu - Quit and not save changes into CMOS Status Page Setup Menu and Option Page Setup Menu - Exit current page and return to Main Menu
PgUp key	Increase the numeric value or make changes
PgDn key	Decrease the numeric value or make changes
F1 key	General help, only for Status Page Setup Menu and Option Page Setup Menu
F2 key	Change color from total 16 colors
F3 key	Reserved
F4 key	Reserved
F5 key	Restore the previous CMOS value from CMOS, only for Option Page Setup Menu
F6 key	Load the default CMOS value from BIOS default table, only for Option Page Setup Menu
F7 key	Load the default
F8 key	Reserved
F9 key	Reserved
F10 key	Save all the CMOS changes, only for Main Menu

4.3. GETTING HELP

4.3.1. Main Menu

The on-line description of the highlighted setup function is displayed at the bottom of the screen.

4.3.2. Status Page Setup Menu / Option Page Setup Menu

Press F1 to pop up a small help window that describes the appropriate keys to use and the possible selections for the highlighted item. To exit the Help Window press <Esc>.

4.4. THE MAIN MENU

Once you enter Award BIOS CMOS Setup Utility, the Main Menu (Figure 4.1) will appear on the screen. The Main Menu allows you to select from nine setup functions and two exit choices. Use arrow keys to select among the items and press <Enter> to accept or enter the sub-menu.

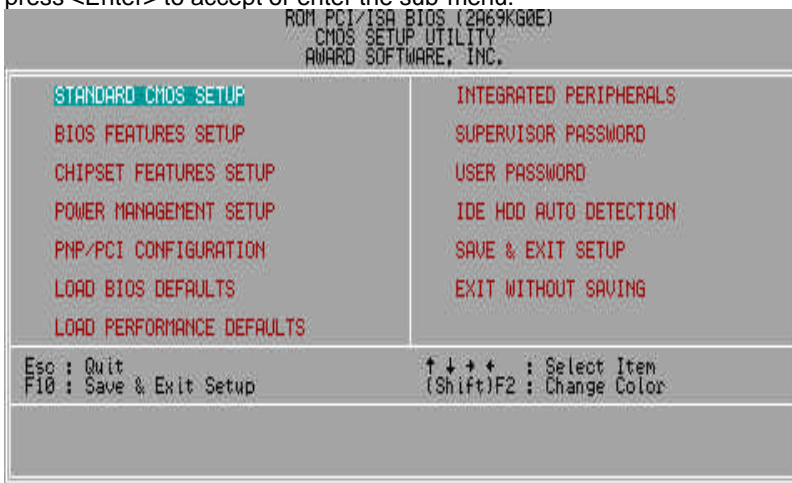

Figure 4.1: Main Menu

- Standard CMOS setup
This setup page includes all the items in standard compatible BIOS.
- BIOS features setup
This setup page includes all the items of Award special enhanced features.

- Chipset features setup
This setup page includes all the items of chipset special features.
- Power management setup
This setup page includes all the items of Green function features.
- PNP/PCI configuration
This setup page includes all the configurations of PCI & PnP ISA resources.
- Load BIOS defaults
BIOS Defaults indicates the most appropriate value of the system parameters that the system would be in safe configuration.
- Load Performance defaults
Performance Defaults indicates the value of the system parameters that the system would be in the best performance configuration.
- Integrated peripherals
This setup page includes all onboard peripherals.
- Supervisor password
Change, set, or disable password. It allows you to limit access to the system and Setup, or just to Setup.
- User password
Change, set, or disable password. It allows you to limit access to the system.
- IDE HDD auto detection
Automatically configure hard disk parameters.
- Save & exit setup
Save CMOS value settings to CMOS and exit setup.
- Exit without saving
Abandon all CMOS value changes and exit setup.

4.5. STANDARD CMOS SETUP MENU

The items in Standard CMOS Setup Menu (Figure 4.2) are divided into 9 categories. Each category includes no, one or more than one setup items. Use the arrows to highlight the item and then use the <PgUp> or <PgDn> keys to select the value you want in each item.



Figure 4.2: Standard CMOS Setup Menu

- Date

The date format is <day>, <month> <date> <year>.

day	The day, from Sun to Sat, determined by the BIOS and is display-only
month	The month, Jan. through Dec.
date	The date, from 1 to 31 (or the maximum allowed in the month)
year	The year, from 1994 through 2079

- Time

The times format in <hour> <minute> <second>. The time is calculated base on the 24-hour military-time clock. For example, 1 p.m. is 13:00:00.

- Primary HDDs / Secondary HDDs

The category identifies the types of hard disk from drive C to F that has been installed in the computer. There are two types: auto type, and user definable type. User type is user-definable; Auto type which will automatically detect HDD type.

Note that the specifications of your drive must match with the drive table. The hard disk will not work properly if you enter improper information for this category.

If you select User Type, related information will be asked to enter to the following items. Enter the information directly from the keyboard and press <Enter>. Such information should be provided in the documentation form your hard disk vendor or the system manufacturer.

CYLS.	Number of cylinders
HEADS	number of heads
PRECOMP	write precomp
LANDZONE	Landing zone
SECTORS	number of sectors

If a hard disk has not been installed select NONE and press <Enter>.

- Drive A type / Drive B type

The category identifies the types of floppy disk drive A or drive B that has been installed in the computer.

None	No floppy drive installed
360K, 5.25 in.	5.25 inch PC-type standard drive; 360K byte capacity.
1.2M, 5.25 in.	5.25 inch AT-type high-density drive; 1.2M byte capacity (3.5 inch when 3 Mode is Enabled).
720K, 3.5 in.	3.5 inch double-sided drive; 720K byte capacity
1.44M, 3.5 in.	3.5 inch double-sided drive; 1.44M byte capacity.
2.88M, 3.5 in.	3.5 inch double-sided drive; 2.88M byte capacity.

- Floppy 3 Mode Support (for Japan Area)

Disabled	Normal Floppy Drive.
Drive A	Drive A is 3 mode Floppy Drive.
Drive B	Drive B is 3 mode Floppy Drive.
Both	Drive A & B are 3 mode Floppy Drives.

- Video

The category detects the type of adapter used for the primary system monitor that must match your video display card and monitor. Although secondary monitors are supported, you do not have to select the type in setup.

EGA/VGA	Enhanced Graphics Adapter/Video Graphics Array. For EGA, VGA, SVGA, or PGA monitor adapters
CGA 40	Color Graphics Adapter, power up in 40 column mode
CGA 80	Color Graphics Adapter, power up in 80 column mode
MONO	Monochrome adapter, includes high resolution monochrome adapters

- Halt on

The category determines whether the computer will stop if an error is detected during power up.

NO Errors	The system boot will not stop for any error that may be detected
All Errors	Whenever the BIOS detects a non-fatal error the system will be stopped and you will be prompted
All, But Keyboard	The system boot will not stop for a keyboard error; it will stop for all other errors
All, But Diskette	The system boot will not stop for a disk error; it will stop for all other errors
All, But Disk/Key	The system boot will not stop for a keyboard or

	disk error; it will stop for all other errors
--	---

- Memory

The category is display-only which is determined by POST (Power On Self Test) of the BIOS.

Base Memory

The POST of the BIOS will determine the amount of base (or conventional) memory installed in the system.

The value of the base memory is typically 512 K for systems with 512 K memory installed on the motherboard, or 640 K for systems with 640 K or more memory installed on the motherboard.

Extended Memory

The BIOS determines how much extended memory is present during the POST.

This is the amount of memory located above 1 MB in the CPU's memory address map.

Expanded Memory

Expanded Memory in memory defined by the Lotus /Intel/ Microsoft (LIM) standard as EMS.

Many standard DOS applications can not utilize memory above 640 K; the Expanded Memory Specification (EMS) swaps memory, which not utilized by DOS with a section, or frame, so these applications, can access all of the system memory.

Memory can be swapped by EMS is usually 64 K within 1 MB or memory above 1 MB, depends on the chipset design.

Expanded memory device driver is required to use memory as Expanded Memory.

Other Memory

This refers to the memory located in the 640 K to 1024 K address space. This is memory that can be used for different

applications.

DOS uses this area to load device drivers to keep as much base memory free for application programs. Most use for this area is Shadow RAM.



4.6. BIOS FEATURES SETUP

Figure 4.3: BIOS Features Setup

*System will detect automatically and show up when you install the Pentium III processor.

- Virus Warning

If it is set to enable, the category will flash on the screen when there is any attempt to write to the boot sector or partition table of the hard disk drive. The system will halt and the warning message will appear in the mean time. You can run anti-virus program to locate the problem.

Default value is Disabled.

Enabled	Activate automatically when the system boots up causing a warning message to appear when anything attempts to access the boot sector or hard disk partition table
Disabled	No warning message to appear when anything attempts to access the boot sector or hard disk partition table

- CPU Internal Cache / External Cache

These two categories speed up memory access. However, it depends on CPU / chipset design. The default value is Enabled.

Enabled	Enable cache
Disabled	Disable cache

- CPU L2 Cache ECC Checking

The default value is Disabled.

Enabled	Enable CPU L2 Cache ECC Checking
Disabled	Disable CPU L2 Cache ECC Checking

- Processor Number Feature

This item will set Enabled when you install the Pentium III processor

The default value is Enabled.

Enabled	Pentium III Processor Number Feature.
Disabled	Disable this function

- Quick Power On Self Test

This category speeds up Power On Self Test (POST) after you power on the computer. If it is set to Enable, BIOS will shorten or skip some check items during POST.

The default value is Enabled.

Enabled	Enable quick POST
Disabled	Normal POST

- CPU Update Data

The default value is Enabled.

Enabled	Enable CPU Update Data
Disabled	Normal CPU Update Data

- Boot From LAN First

The default value is Enabled.

Enabled	Enable Boot From LAN First Function
Disabled	Disable Boot From LAN First Function

- Boot Sequence

This category determines which drive computer searches first for the disk operating system (i.e., DOS). Default value is A, C, SCSI.

X1, X2, X3	System will first search for X1 disk drive then X2 disk drive and then X3 disk drive.
------------	---

- Swap Floppy Drive

The default value is Disabled.

Enabled	Floppy A & B will be swapped under DOS
Disabled	Floppy A & B will be normal definition

- VGA Boot From

The default value is AGP.

AGP	VGA Boot From AGP
PCI	VGA Boot From PCI

- Boot Up Floppy Seek

During POST, BIOS will determine the floppy disk drive installed is 40 or 80 tracks. 360 K type is 40 tracks 720 K, 1.2 M and 1.44 M are all 80 tracks. The default value is Enabled.

Enabled	BIOS searches for floppy disk drive to determine it is 40 or 80 tracks. Note that BIOS can not tell from 720 K, 1.2 M or 1.44 M drive type as they are all 80 tracks
Disabled	BIOS will not search for the type of floppy disk drive by track number. Note that there will not be any warning message if the drive installed is 360 K

- Boot Up NumLock Status

The default value is On.

On	Keypad is number keys
Off	Keypad is arrow keys

- Typematic Rate Setting

The default value is Disabled.

Enabled	Enable Keyboard Typematic rate setting.
Disabled	Disable Keyboard Typematic rate setting.

- Typematic Rate (Chars / Sec)

The default value is 6.

6-30	Set the maximum Typematic rate from 6 chars. Per second to 30 chars. Per second.
------	--

- Typematic Delay (Msec)

The default value is 250.

250-1000	Set the time delay from first key to repeat the same key in to computer.
----------	--

- Security Option

This category allows you to limit access to the system and Setup, or just to Setup. The default value is Setup.

System	The system can not boot and can not access to Setup page will be denied if the correct password is not entered at the prompt
Setup	The system will boot, but access to Setup will be denied if the correct password is not entered at the prompt

- **To disable security, select PASSWORD SETTING at Main Menu and then you will be asked to enter password. Do not type anything and just press <Enter>, it will disable security. Once the security is disabled, the system will boot and you can enter Setup page freely.**

- PCI/VGA Palette Snoop

The default value is Disabled.

Enabled	For having Video Card on ISA Bus and VGA Card on PCI Bus.
Disabled	For VGA Card only.

- Assign IRQ For VGA

The default value is Enabled.

Enabled	Assign a specific IRQ for VGA
Disabled	No IRQ is assigned for VGA

- OS Select For DRAM>64MB

The default value is Non-OS2.

Non-OS2	Using non-OS2 operating system.
OS2	Using OS2 operating system and DRAM>64MB.

- HDD S.M.A.R.T. Capability

The default value is Disabled.

Enabled	Enabled HDD S.M.A.R.T. Capability
Disabled	Disabled HDD S.M.A.R.T. Capability

- Report No FDD For WIN 95

The default value is No.

No	Assign IRQ6 For FDD.
Yes	FDD Detect IRQ6 Automatically.

- Video BIOS Shadow

It determines whether video BIOS is able to copy to RAM, however, it is optional from chipset design. Video Shadow will increase the video speed. The default value is Enabled.

Enabled	Video shadow is enabled
Disabled	Video shadow is disabled

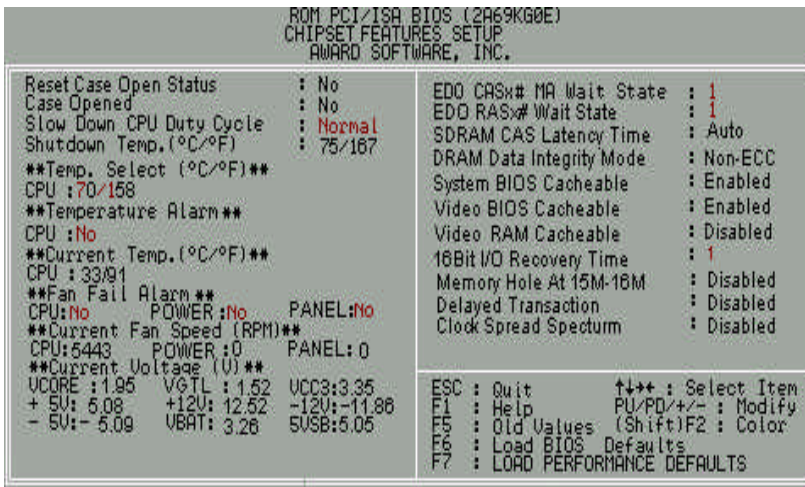

4.7. CHIPSET FEATURES SETUP

Figure 4.4: Chipset Features Setup

- Reset Case Open Status
- Case Opened

If the case is closed, “Case Opened” will show “No” .

If the case have been opened, “Case Opened” will show “Yes” .

If you want to reset “Case Opened” value, set “Reset Case Open Status” to “Yes” and restart your computer.

- Slow Down CPU Duty Cycle

The default value is Normal.

Normal	Normal Operation
12.5%~75.0%	Monitor CPU Temp. will cause system slow down

	CPU Duty Cycle to 12.5%~75.0%.
--	--------------------------------

- Shutdown Temp. (°C / °F) (Optional)

(This function will be effective only for the operating systems that support ACPI Function.)

The default value is 75°C / 167°F

Disabled	Normal Operation
60°C / 140°F	Monitor CPU Temp. at 60°C / 140°F, if Temp. > 60°C / 140°F system will automatically power off .
65°C / 149°F	Monitor CPU Temp. at 65°C / 149°F, if Temp. > 65°C / 149°F system will automatically power off .
70°C / 158°F	Monitor CPU Temp. at 70°C / 158°F, if Temp. > 70°C / 158°F system will automatically power off .
75°C / 167°F	Monitor CPU Temp. at 75°C / 167°F, if Temp. > 75°C / 167°F system will automatically power off .

- Temp. Select (°C / °F) (Optional)

The default value is 70°C / 158°F

60°C / 140°F	Monitor CPU Temp. at 60°C / 140°F
65°C / 149°F	Monitor CPU Temp. at 65°C / 149°F
70°C / 158°F	Monitor CPU Temp. at 70°C / 158°F
75°C / 167°F	Monitor CPU Temp. at 75°C / 167°F

- Temperature Alarm (Optional)

The default value is No

No	When CPU Temp. overheat, then system won't alarm.
Yes	When CPU Temp. overheat, then system will alarm.

- Current Temp. (Optional)

Detect Temp. automatically.

- Fan Fail Alarm (Optional)

CPU/POWER/PANEL

No	Fan Fail Alarm Function Disabled.
Yes	Fan Fail Alarm Function Enabled.

- Current FAN Speed (RPM) (Optional)

Detect Fan speed status automatically.

- Current Voltage (v) V_{CORE} / V_{GTL} / V_{CC3} / ±12V / ±5V / V_{BAT} / 5V_{SB} (Optional)

Detect system's voltage status automatically.

- EDO CAS# MA Wait State

The default value is 1

1	Set EDO CAS# MA Wait State to 1.
2	Set EDO CAS# MA Wait State to 2.

- EDO RAS# Wait State

The default value is 1

1	Set EDO RAS# Wait State to 1.
2	Set EDO RAS# Wait State to 2.

- SDRAM CAS latency Time

The default value is Auto

3	For 67 / 83 MHz SDRAM DIMM module.
2	For 100 MHz SDRAM DIMM module.

Auto	CAS latency time will be set automatically if you have SPD on SDRAM
------	---

- DRAM Data Integrity Mode

The default value is Non-ECC.

Non-ECC	For 64bit standard type DIMM module.
ECC	For 72bit ECC type DIMM module.

- System BIOS Cacheable

The default value is Enabled.

Enabled	Enable System BIOS Cacheable.
Disabled	Disable System BIOS Cacheable.

- Video BIOS Cacheable

The default value is Enabled.

Enabled	Enable video BIOS Cacheable.
Disabled	Disable video BIOS Cacheable.

- Video RAM Cacheable

The default value is Disabled.

Disabled	Disable this function.
Enabled	Enable this function to get better VGA performance; while some brands of VGA must be disabled this function (e.g.ET4000W32P).

- 16 Bit I/O Recovery Time

The default value is 1.

1-4	Set 16 Bit I/O recovery time from 1 to 4.
NA	None.

- Memory Hole At 15M-16M

The default value is Disabled.

Disabled	Normal Setting.
Enabled	Set Address=15~16MB remap to ISA BUS.

- Delayed Transaction

The default value is Disabled.

Disabled	Normal operation.
Enabled	For slow speed ISA device in system.

- Clock Spread Spectrum

The default value is Disabled.

Disabled	Disabled this function.
Enabled	Enabled Clock Spread Spectrum.

4.8. POWER MANAGEMENT SETUP

Figure 4.5: Power Management Setup



* These two items will show up when "Resume by Alarm" is Enabled.

- Power Management

The default value is Enabled.

Enabled	Enable Green function.
Disabled	Disable Green function.

- PM Control by APM

The default value is Yes.

Yes	Enable software APM function.
No	Disable software APM function.

- Video off Method

The default value is DPMS.

V/H SYNC + Blank	BIOS will turn off V/H-SYNC when gets into Green mode for Green monitor power saving.
Blank Screen	BIOS will only black monitor when gets into Green mode.

DPMS	BIOS will use DPMS Standard to control VGA card. (The Green type VGA card will turn of V/H-SYNC automatically.)
------	---

- Suspend Mode

The default value is Disable.

Disabled	Disable Suspend Mode.
1 min - 1 Hour	Setup the timer to enter Suspend Mode.

- HDD Power Down

The default value is Disable.

Disable	Disable HDD Power Down mode function.
1-15 mins.	Enable HDD Power Down mode between 1 to 15 mins.

- VGA Active Monitor

The default value is Disabled.

Disabled	Disable monitor VGA activity.
Enabled	Enable monitor VGA activity.

- Soft-off by PWR-BTTN

The default value is Instant-Off.

Instant-off	Soft switch ON/OFF for POWER ON/OFF
Delay 4 Sec.	Soft switch ON 4sec. for POWER OFF.

- System After AC Back

The default value is Soft-Off.

Memory By S/W	This function depends on computer status
Soft-Off	Set System Soft-Off Status.
Full-On	Set System Full-On Status.

- Power LED In Suspend

The default value is BLINKING.

OFF/ Dual	Set Power LED In Suspend to OFF/Dual.
ON	Set Power LED In Suspend to ON.
BLINKING	Set Power LED In Suspend to BLINKING.

⊗ **This function is support in PCB version 2.0 and above.**

- CPUFAN Off In Suspend

The default value is Enabled.

Disabled	Disable this function.
Enabled	Stop CPU FAN when entering Suspend mode.

- PME Event Wakeup

The default value is Disabled.

Disabled	Disable PME Event Wakeup.
Enabled	Enable PME Event Wakeup.

- ModemRingOn / WakeOnLan

The default value is Enabled.

Disabled	Disable these functions.
Enabled	Enable these functions.

- Resume by Alarm

The default value is Disabled.

Disabled	Disable this function.
Enabled	Enable alarm function to POWER ON system.

If the "Resume by Alarm" is Enabled.

Date (of Month) Alarm :	0~31
Time (hh: mm: ss) Alarm :	(0~23) : (0~59) : (0~59)

- IRQ [3-7,9-15] , NMI

The default value is Enabled.

Disabled	Disable this function.
Enabled	Enable monitor IRQ [3-7,9-15] for Green event.

- Primary IDE 0/1

The default value is Disabled.

Disabled	Disable this function.
Enabled	Enable monitor Primary IDE 0/1 for Green event.

- Secondary IDE 0/1

The default value is Disabled.

Disabled	Disable this function.
Enabled	Enable monitor Secondary IDE 0/1 for Green event.

- Floppy Disk

The default value is Enabled.

Disabled	Disable this function.
Enabled	Enable monitor Floppy Disk for Green event.

- Serial Port

The default value is Enabled.

Disabled	Disable this function.
Enabled	Enable monitor Serial Port for Green event.

- Parallel Port

The default value is Disabled.

Disabled	Disabled this function.
----------	-------------------------

Enabled	Enabled monitor Parallel Port for Green event.
---------	--

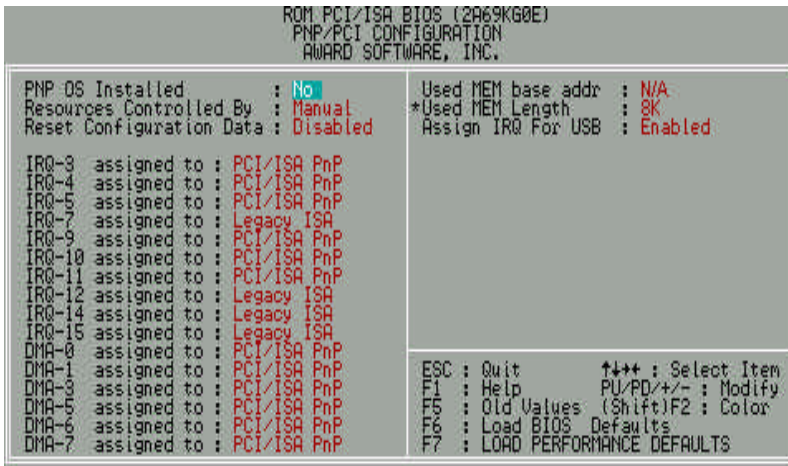

4.9. PNP/PCI CONFIGURATION

Figure 4.6: PCI Slot Configuration

* This item will show up when "Used MEM base addr" has been set.

- PNP OS Installed

The default value is No.

Yes	Enable PNP OS Installed function.
No	Disable PNP OS Installed function.

- Resources Controlled by

The default value is Manual.

Manual	User can set the PnP resource (I/O Address, IRQ & DMA channels) used by legacy ISA DEVICE.
Auto	BIOS automatically use these PnP rescuers.

- Reset Configuration Data

The default value is Disabled.

Disabled	Disable this function.
Enabled	Enable clear PnP information in ESCD.

- IRQ (3,4,5,7,9,10,11,12,14,15), DMA(0,1,3,5,6,7) assigned to

The default value is "Legacy ISA" or "PCI/ISA PnP".

Legacy ISA	The resource is used by Legacy ISA device.
PCI/ISA PnP	The resource is used by PCI/ISA PnP device (PCI or ISA).

- Used MEM base addr.

The default value is N/A.

N/A	Disable the MEM. block using.
C800 ~ DC00	Select the MEM. block starting address.

- Used MEM Length

The default value is 8K.

8K ~ 64K	Select the MEM. block size.
----------	-----------------------------

- Assign IRQ For USB

The default value is Enabled.

Enabled	Assign a specific IRQ for USB
Disabled	No IRQ is assigned for USB

4.10. LOAD BIOS DEFAULTS

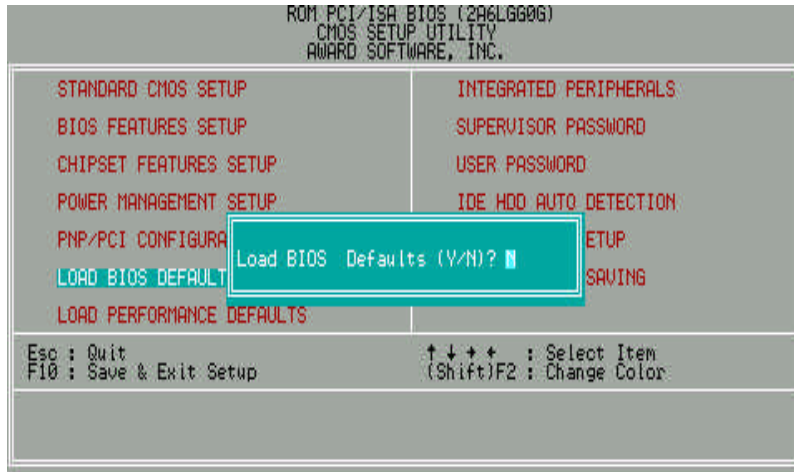
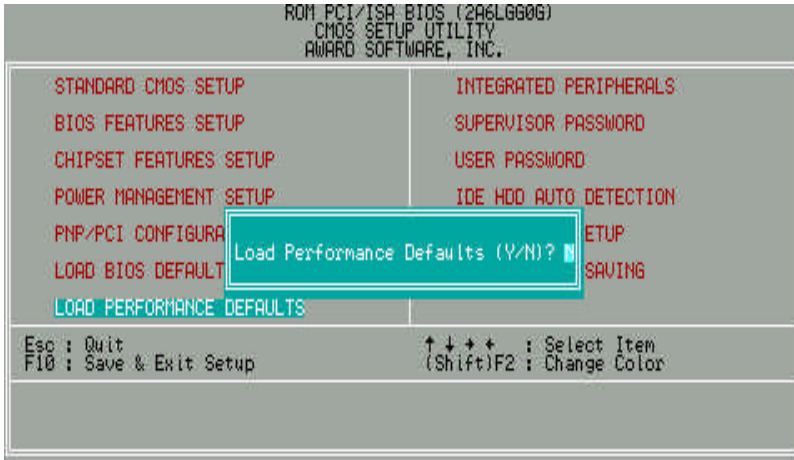

Figure 4.7: Load BIOS Defaults

- Load BIOS Defaults
To load BIOS defaults value to CMOS SRAM, enter "Y". If not, enter "N".



4.11. LOAD PERFORMANCE DEFAULTS

Figure 4.8: Load PERFORMANCE Defaults

- Load PERFORMANCE Defaults

To load PERFORMANCE defaults value to CMOS SRAM, enter "Y". If not, enter "N".

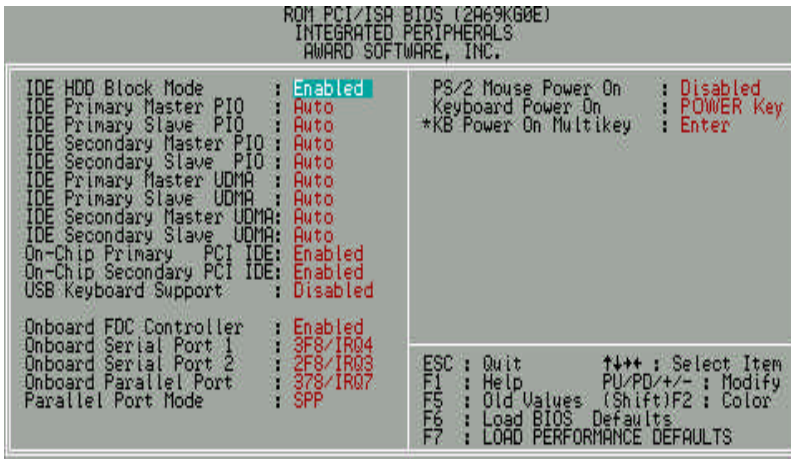

4.12. INTEGRATED PERIPHERALS

Figure 4.9: Integrated Peripherals

* This item will show up when “Keyboard Power On: Multikey” is selected.

- IDE HDD Block Mode

The default value is Enabled.

Enabled	Enable IDE HDD Block Mode
Disabled	Disable IDE HDD Block Mode

- IDE Primary Master PIO (for onboard IDE 1st channel).

The default value is Auto.

Auto	BIOS will automatically detect the IDE HDD Accessing mode.
Mode0~4	Manually set the IDE Accessing mode.

- IDE Primary Slave PIO (for onboard IDE 1st channel).

The default value is Auto.

Auto	BIOS will automatically detect the IDE HDD Accessing mode.
Mode0~4	Manually set the IDE Accessing mode.

- IDE Secondary Master PIO (for onboard IDE 2nd channel).

The default value is Auto.

Auto	BIOS will automatically detect the IDE HDD Accessing mode.
Mode0~4	Manually set the IDE Accessing mode.

- IDE Secondary Slave PIO (for onboard IDE 2nd channel).

The default value is Auto.

Auto	BIOS will automatically detect the IDE HDD Accessing mode.
Mode0~4	Manually set the IDE Accessing mode.

- IDE Primary Master UDMA.

The default value is Auto.

Auto	BIOS will automatically detect the IDE HDD Accessing mode.
Disabled	Disable UDMA function.

- IDE Primary Slave UDMA.

The default value is Auto.

Auto	BIOS will automatically detect the IDE HDD Accessing mode.
Disabled	Disable UDMA function.

- IDE Secondary Master UDMA.

The default value is Auto.

Auto	BIOS will automatically detect the IDE HDD Accessing mode.
Disabled	Disable UDMA function.

- IDE Secondary Slave UDMA.

The default value is Auto.

Auto	BIOS will automatically detect the IDE HDD Accessing mode.
Disabled	Disable UDMA function.

- On-Chip Primary PCI IDE

The default value is Enabled.

Enabled	Enable onboard 1st channel IDE port.
Disabled	Disable onboard 1st channel IDE port.

- On-Chip Secondary PCI IDE

The default value is Enabled.

Enabled	Enable onboard 2nd channel IDE port.
Disabled	Disable onboard 2nd channel IDE port.

- USB Keyboard Support

The default value is Disabled.

Enabled	Enable USB Keyboard Support.
Disabled	Disable USB Keyboard Support.

- Onboard FDC Controller

The default value is Enabled.

Enabled	Enable onboard FDC port.
Disabled	Disable onboard FDC port.

- Onboard Serial Port 1

The default value is 3F8/IRQ4.

Auto	BIOS will automatically setup the port 1 address.
3F8/IRQ4	Enable onboard Serial port 1 and address is 3F8.
2F8/IRQ3	Enable onboard Serial port 1 and address is 2F8.
3E8/IRQ4	Enable onboard Serial port 1 and address is 3E8.
2E8/IRQ3	Enable onboard Serial port 1 and address is 2E8.
Disabled	Disable onboard Serial port 1.

- Onboard Serial Port 2

The default value is 2F8/IRQ3.

Auto	BIOS will automatically setup the port 2 address.
3F8/IRQ4	Enable onboard Serial port 2 and address is 3F8.
2F8/IRQ3	Enable onboard Serial port 2 and address is 2F8.
3E8/IRQ4	Enable onboard Serial port 2 and address is 3E8.
2E8/IRQ3	Enable onboard Serial port 2 and address is 2E8.
Disabled	Disable onboard Serial port 2.

- Onboard Parallel port

The default value is 378/IRQ7.

378/IRQ7	Enable onboard LPT port and address is 378/IRQ7.
278/IRQ5	Enable onboard LPT port and address is 278/IRQ5.
Disabled	Disable onboard LPT port.
3BC/IRQ7	Enable onboard LPT port and address is 3BC/IRQ7.

- Parallel Port Mode

The default value is SPP.

SPP	Using Parallel port as Standard Printer Port.
EPP	Using Parallel port as Enhanced Parallel Port.

ECP	Using Parallel port as Extended Capabilities Port.
ECP+EPP	Using Parallel port as ECP & EPP mode.

- PS/2 Mouse Power on

The default value is Disabled.

Disabled	Disable PS/2 Mouse Power on .
DbiClick	Click twice on PS/2 mouse left/right button to Power on system.

- Keyboard Power on

The default value is POWER Key.

Disabled	Disable Keyboard Power on .
Multikey	Enter multikey combination to Power on system.
POWER Key	If you keyboard have " POWER Key " button, you can press the key to power on your system .

- KB Power ON Multikey

Enter	Enter from 1 to 5 characters to set the Keyboard Power On Password.
-------	---

- **You can power on your system by entering the keyboard power on password. If your password consists of more than one character, you have to press the ENTER key after entering the password.**

4.13. SUPERVISOR PASSWORD / USER PASSWORD

When you select this function, the following message will appear at the center of the screen to assist you in creating a password.

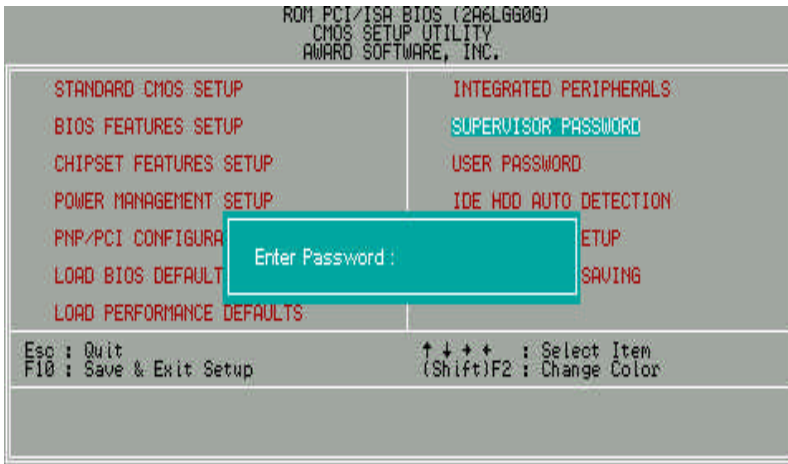

Figure 4.10: Password Setting

Type the password, up to eight characters, and press <Enter>. The password typed now will clear the previously entered password from CMOS memory. You will be asked to confirm the password. Type the password again and press <Enter>.

To disable password, just press <Enter> when you are prompted to enter password. A message "PASSWORD DISABLED" will appear to confirm the password being disabled. Once the password is disabled, the system will boot and you can enter Setup freely.

If you select System at Security Option in BIOS Features Setup Menu, you will be prompted for the password every time the system is rebooted or any time you try to enter Setup Menu. If you select Setup at Security Option in BIOS Features Setup Menu, you will be prompted only when you try to enter Setup.

4.14. IDE HDD AUTO DETECTION

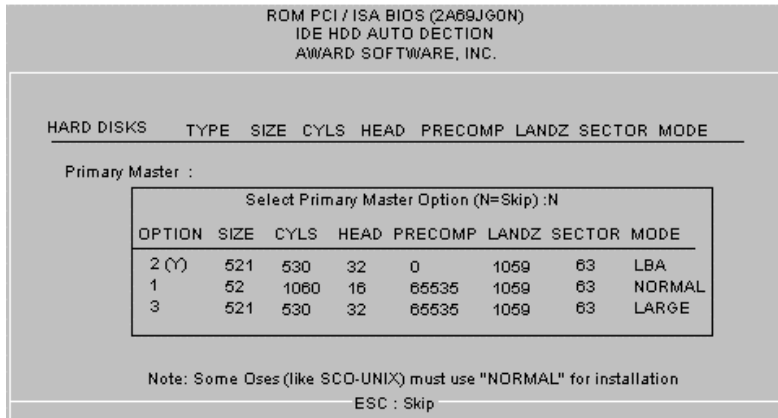
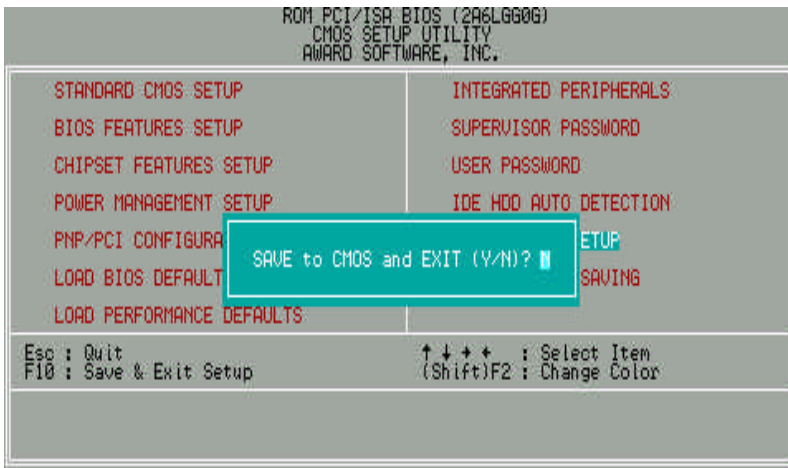

Figure 4.11: IDE HDD Auto Detection

Type "Y" will accept the H.D.D. parameter reported by BIOS.

Type "N" will keep the old H.D.D. parameter setup. If the hard disk cylinder number is over 1024, then the user can select LBA mode or LARGER mode for DOS partition larger than 528 MB.



4.15. SAVE & EXIT SETUP

Figure 4.12: Save & Exit Setup

Type "Y" will quit the Setup Utility and save the user setup value to RTC CMOS SRAM.

Type "N" will return to Setup Utility.

4.16. EXIT WITHOUT SAVING

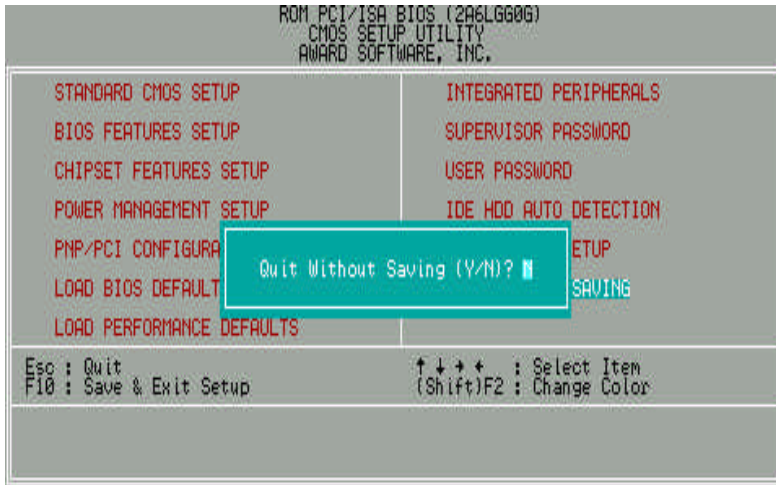

Figure 4.13: Exit Without Saving

Type "Y" will quit the Setup Utility without saving to RTC CMOS SRAM.

Type "N" will return to Setup Utility.

<p align="center">DECLARATION OF CONFORMITY Per FCC Part 2 Section 2.107(a)</p> <p align="center">FC</p> <p>Responsible Party Name: G.B.T. INC.</p> <p>Address: 18385 Valley Blvd., Suite#A LA Puente, CA 91744</p> <p>Phone/Fax No: (818) 854-9338 / (818) 854-9339</p> <p>hereby declares that the product</p> <p>Product Name: Mother Board</p> <p>Model Number: GA-6BXE</p> <p>Conforms to the following specifications:</p> <p>FCC Part 15, Subpart B, Section 15.107(a) and Section 15.109(a), Class B Digital Device</p> <p>Supplementary Information:</p> <p>This device complies with part 15 of the FCC Rules. Operation is subject to the following two conditions: (1) This device may not cause harmful interference, and (2) this device must accept any interference received, including interference that may cause undesired operation.</p> <p>Representative Person's Name: <u>ERIC LU</u></p> <p>Signature: <u>Eric Lu</u></p> <p>Date: <u>Aug. 05, 1998</u></p>

FCC Compliance Statement:

This equipment has been tested and found to comply with limits for a Class B digital device , pursuant to Part 15 of the FCC rules. These limits are designed to provide reasonable protection against harmful interference in residential installations. This equipment generates, uses, and can radiate radio frequency energy, and if not installed and used in accordance with the instructions, may cause harmful interference to radio communications. However, there is no guarantee that interference will not occur in a particular installation. If this equipment does cause

interference to radio or television equipment reception, which can be determined by turning the equipment off and on, the user is encouraged to try to correct the interference by one or more of the following measures:

- Reorient or relocate the receiving antenna
- Move the equipment away from the receiver
- Plug the equipment into an outlet on a circuit different from that to which the receiver is connected
- Consult the dealer or an experienced radio/television technician for additional suggestions

You are cautioned that any change or modifications to the equipment not expressly approve by the party responsible for compliance could void Your authority to operate such equipment.

This device complies with Part 15 of the FCC Rules. Operation is subjected to the following two conditions 1) this device may not cause harmful interference and 2) this device must accept any interference received, including interference that may cause undesired operation.

Declaration of Conformity

We, Manufacturer/Importer
(full address)

G.B.T. Technology Trading GmbH
Ausschlagler Weg 41, 1F, 20537 Hamburg, Germany

declare that the product
(description of the apparatus, system, installation to which it refers)

Mother Board
GA-6BXE

is in conformity with
(reference to the specification under which conformity is declared)
in accordance with 89/336 EEC-EMC Directive

- | | | | |
|---|--|--|--|
| <input type="checkbox"/> EN 55011 | Limits and methods of measurement of radio disturbance characteristics of industrial, scientific and medical (ISM) high frequency equipment | <input checked="" type="checkbox"/> EN 61000-3-2*
<input checked="" type="checkbox"/> EN60555-2 | Disturbances in supply systems caused by household appliances and similar electrical equipment "Harmonics" |
| <input type="checkbox"/> EN55013 | Limits and methods of measurement of radio disturbance characteristics of broadcast receivers and associated equipment | <input checked="" type="checkbox"/> EN61000-3-3*
<input checked="" type="checkbox"/> EN60555-3 | Disturbances in supply systems caused by household appliances and similar electrical equipment "Voltage fluctuations" |
| <input type="checkbox"/> EN 55014 | Limits and methods of measurement of radio disturbance characteristics of household electrical appliances, portable tools and similar electrical apparatus | <input checked="" type="checkbox"/> EN 50081-1
<input checked="" type="checkbox"/> EN 50082-1 | Generic emission standard Part 1: Residual, commercial and light industry
Generic immunity standard Part 1: Residual, commercial and light industry |
| <input type="checkbox"/> EN 55015 | Limits and methods of measurement of radio disturbance characteristics of fluorescent lamps and luminaries | <input type="checkbox"/> EN 55081-2 | Generic emission standard Part 2: Industrial environment |
| <input type="checkbox"/> EN 55020 | Immunity from radio interference of broadcast receivers and associated equipment | <input type="checkbox"/> EN 55082-2 | Generic immunity standard Part 2: Industrial environment |
| <input checked="" type="checkbox"/> EN 55022 | Limits and methods of measurement of radio disturbance characteristics of information technology equipment | <input type="checkbox"/> ENV 55104 | Immunity requirements for household appliances tools and similar apparatus |
| <input type="checkbox"/> DIN VDE 0855
<input type="checkbox"/> part 10
<input type="checkbox"/> part 12 | Cabled distribution systems; Equipment for receiving and/or distribution from sound and television signals | <input type="checkbox"/> EN 50091-2 | EMC requirements for uninterruptible power systems (UPS) |

CE marking



The manufacturer also declares the conformity of above mentioned product with the actual required safety standards in accordance with LVD 73/23 EEC

- | | | | |
|-----------------------------------|---|-------------------------------------|---|
| <input type="checkbox"/> EN 60065 | Safety requirements for mains operated electronic and related apparatus for household and similar general use | <input type="checkbox"/> EN 60950 | Safety for information technology equipment including electrical business equipment |
| <input type="checkbox"/> EN 60335 | Safety of household and similar electrical appliances | <input type="checkbox"/> EN 50091-1 | General and Safety requirements for uninterruptible power systems (UPS) |

Manufacturer/Importer

Signature : Rex Lin

(Stamp)

Date : Aug. 05, 1998

Name : Rex Lin