

SUPER  [®]

SUPER  [®] C2SBC-Q

USER'S MANUAL

Revision 1.1b

The information in this User's Manual has been carefully reviewed and is believed to be accurate. The vendor assumes no responsibility for any inaccuracies that may be contained in this document, makes no commitment to update or to keep current the information in this manual, or to notify any person or organization of the updates. **Please Note: For the most up-to-date version of this manual, please see our web site at www.supermicro.com.**

Super Micro Computer, Inc. ("Supermicro") reserves the right to make changes to the product described in this manual at any time and without notice. This product, including software, if any, and documentation may not, in whole or in part, be copied, photocopied, reproduced, translated or reduced to any medium or machine without prior written consent.

IN NO EVENT WILL SUPER MICRO COMPUTER, INC. BE LIABLE FOR DIRECT, INDIRECT, SPECIAL, INCIDENTAL, SPECULATIVE OR CONSEQUENTIAL DAMAGES ARISING FROM THE USE OR INABILITY TO USE THIS PRODUCT OR DOCUMENTATION, EVEN IF ADVISED OF THE POSSIBILITY OF SUCH DAMAGES. IN PARTICULAR, SUPER MICRO COMPUTER, INC. SHALL NOT HAVE LIABILITY FOR ANY HARDWARE, SOFTWARE, OR DATA STORED OR USED WITH THE PRODUCT, INCLUDING THE COSTS OF REPAIRING, REPLACING, INTEGRATING, INSTALLING OR RECOVERING SUCH HARDWARE, SOFTWARE, OR DATA.

Any disputes arising between manufacturer and customer shall be governed by the laws of Santa Clara County in the State of California, USA. The State of California, County of Santa Clara shall be the exclusive venue for the resolution of any such disputes. Supermicro's total liability for all claims will not exceed the price paid for the hardware product.

FCC Statement: This equipment has been tested and found to comply with the limits for a Class A digital device pursuant to Part 15 of the FCC Rules. These limits are designed to provide reasonable protection against harmful interference when the equipment is operated in a commercial environment. This equipment generates, uses, and can radiate radio frequency energy and, if not installed and used in accordance with the manufacturer's instruction manual, may cause harmful interference with radio communications. Operation of this equipment in a residential area is likely to cause harmful interference, in which case you will be required to correct the interference at your own expense.

California Best Management Practices Regulations for Perchlorate Materials: This Perchlorate warning applies only to products containing CR (Manganese Dioxide) Lithium coin cells. "Perchlorate Material-special handling may apply. See www.dtsc.ca.gov/hazardouswaste/perchlorate".

WARNING: Handling of lead solder materials used in this product may expose you to lead, a chemical known to the State of California to cause birth defects and other reproductive harm.

Manual Revision 1.1b

Release Date: December 18, 2009

Unless you request and receive written permission from Super Micro Computer, Inc., you may not copy any part of this document.

Information in this document is subject to change without notice. Other products and companies referred to herein are trademarks or registered trademarks of their respective companies or mark holders.

Copyright © 2009 by Super Micro Computer, Inc.

All rights reserved.

Printed in the United States of America

Preface

About This Manual

This manual is written for system integrators, PC technician and knowledgeable PC users. It provides information for the installation and use of the **SUPER** C2SBC-Q motherboard. The C2SBC-Q supports single Core 2 Duo/Core 2 Quad Processor with a system bus speed of 1333 MHz/1066 MHz/800 MHz. The Intel Core 2 Duo/Core 2 Quad Processor supports the 775-Land Grid Array Package that interfaces with the motherboard via an LGA775 socket. With support of the Dual-Core Technology, Intel Hyper-Threading (HT) Technology, Wide Dynamic Execution, FSB Dynamic Bus Inversion (DBI), Advanced Digital Media Boost, Smart Memory Access, and Thermal Management 2 (TM2), the C2SBC-Q delivers unparalleled system performance and great power efficiency in a slim package. Please refer to the motherboard specifications pages on our web site (<http://www.supermicro.com/Products/>) for updates on supported processors. This product is intended to be installed and serviced by professional technicians.

Manual Organization

Chapter 1 describes the features, specifications and performance of the mainboard and provides detailed information about the chipset.

Chapter 2 provides hardware installation instructions. Read this chapter when installing the processor, memory modules and other hardware components into the system. If you encounter any problems, see **Chapter 3**, which describes troubleshooting procedures for video, memory and system setup stored in the CMOS.

Chapter 4 includes an introduction to BIOS and provides detailed information on running the CMOS Setup utility.

Appendix A provides BIOS POST Error Codes.

Appendix B lists the Windows OS Installation Instructions.

Appendix C lists Other Software Program Installation Instructions.

Conventions Used in the Manual:

Special attention should be given to the following symbols for proper installation and to prevent damage done to the components or injury to yourself:



Warning: Important information given to ensure proper system installation, to prevent bodily injury or damage to the components.



Note: Additional Information given to differentiate various models or to ensure correct system setup.

Table of Contents

Preface

About This Manual	iii
Manual Organization	iii
Conventions Used in the Manual	iii

Chapter 1: Introduction

1-1 Overview	1-1
Checklist	1-1
Contacting Super Micro.....	1-2
SUPER C2SBC-Q Image	1-3
SUPER C2SBC-Q Layout.....	1-4
SUPER C2SBC-Q Quick Reference.....	1-5
Motherboard Features	1-6
Intel Q35 Chipset: System Block Diagram.....	1-8
1-2 Chipset Overview	1-9
1-3 Recovery from AC Power Loss	1-10
1-4 PC Health Monitoring	1-10
1-5 ACPI Features.....	1-10
1-6 Power Supply	1-11
1-7 Versatile Media Capabilities.....	1-12
1-8 Super I/O	1-12

Chapter 2: Installation

2-1 Static-Sensitive Devices	2-1
2-2 Motherboard Installation	2-1
2-3 Processor and Heatsink Installation	2-2
2-4 Installing DIMMS.....	2-6
2-5 Control Panel Connectors/IO Ports	2-8
1. Back Panel Connectors/IO Ports.....	2-8
2. Front Control Panel	2-9
3. Front Control Panel Pin Definitions	2-10
PWR LED	2-10
HDD LED.....	2-10
NIC1/NIC2 LED Indicators	2-11
OH/Fan Fail LED	2-11
Reset Button.....	2-12

PWR Button.....	2-12
2-6 Connecting Cables	2-13
ATX/Auxiliary Power Connectors	2-13
GLAN1 and GLAN2 Ports.....	2-13
Universal Serial Bus (USB).....	2-14
Chassis Intrusion	2-14
Fan Headers.....	2-15
VGA Connector	2-15
ATX PS/2 Keyboard and PS/2 Mouse Ports.....	2-16
Serial Ports.....	2-16
Wake-On-Ring	2-17
Wake-On-LAN	2-17
Speaker/Buzzer.....	2-18
System Management Bus.....	2-18
High Definition Audio (HDA).....	2-19
CD Header/Auxiliary Audio Header.....	2-19
Front Panel Audio Control.....	2-20
Power LED	2-20
2-7 Jumper Settings	2-21
Explanation of Jumpers	2-21
GLAN Enable/Disable	2-21
Watch Dog Enable	2-22
PCI/PCI-Exp. Slots to SMB Speeds.....	2-23
Clear CMOS.....	2-23
IDE Enable/Disable	2-24
Audio Enable	2-24
USB Wake-up.....	2-25
2-8 Onboard Indicators	2-26
GLAN LED Indicators.....	2-26
Power LED	2-27
2-9 Parallel Port Connections	2-28
Parallel Port Connector.....	2-28
IDE Connector.....	2-29

Chapter 3: Troubleshooting

3-1 Troubleshooting Procedures	3-1
Before Power On.....	3-1
No Power.....	3-1

No Video	3-2
Memory Errors.....	3-2
Losing the System's Setup Configuration	3-2
3-2 Technical Support Procedures	3-3
3-3 Frequently Asked Questions	3-4
3-4 Returning Merchandise for Service	3-5

Chapter 4: BIOS

4-1 Introduction	4-1
4-2 Running Setup	4-2
4-3 Main BIOS Setup	4-2
4-4 Advanced Setup.....	4-6
4-5 Security Setup	4-18
4-6 Trusted Platform Moudule (TPM).....	4-20
4-7 Boot Settings.....	4-21
4-8 Exit	4-22

Appendices:

Appendix A: BIOS POST Error Codes	A-1
Appendix B: Installing the Windows OS	B-1
Appendix C: Installing Other Software Programs and Drivers.....	C-1

Chapter 1

Introduction

1-1 Overview

Checklist

Congratulations on purchasing your computer motherboard from an acknowledged leader in the industry. Super Micro boards are designed with the utmost attention to detail to provide you with the highest standards in quality and performance.

Please check that the following items have all been included with your motherboard. If anything listed here is damaged or missing, contact your retailer.

All the following items are included in the retail box only:

One (1) Super Micro Mainboard

Six (6) SATA cables (CBL-0044L)

One (1) IDE hard drive cable (CBL-0036L-3)

One (1) Super Micro CD containing drivers and utilities

One (1) User's/BIOS Manual

Contacting Supermicro

Headquarters

Address: Super Micro Computer, Inc.
980 Rock Ave.
San Jose, CA 95131 U.S.A.

Tel: +1 (408) 503-8000

Fax: +1 (408) 503-8008

Email: marketing@supermicro.com (General Information)
support@supermicro.com (Technical Support)

Web Site: www.supermicro.com

Europe

Address: Super Micro Computer B.V.
Het Sterrenbeeld 28, 5215 ML
's-Hertogenbosch, The Netherlands

Tel: +31 (0) 73-6400390

Fax: +31 (0) 73-6416525

Email: sales@supermicro.nl (General Information)
support@supermicro.nl (Technical Support)
rma@supermicro.nl (Customer Support)

Asia-Pacific

Address: Super Micro Computer, Inc.
4F, No. 232-1 Liancheng Road
Chung-Ho 235, Taipei Hsien, Taiwan, R.O.C.

Tel: +886-(2) 8226-3990

Fax: +886-(2) 8226-3991

Web Site: www.supermicro.com.tw

Technical Support:

Email: support@supermicro.com.tw

Tel: 886-2-82261900

SUPER C2SBC-Q Image

Note: All pictures and drawings shown in this manual were based upon the latest PCB Revision available at the time of publishing of the manual. The motherboard you have received may or may not look exactly the same as those in this manual.

Motherboard Layout

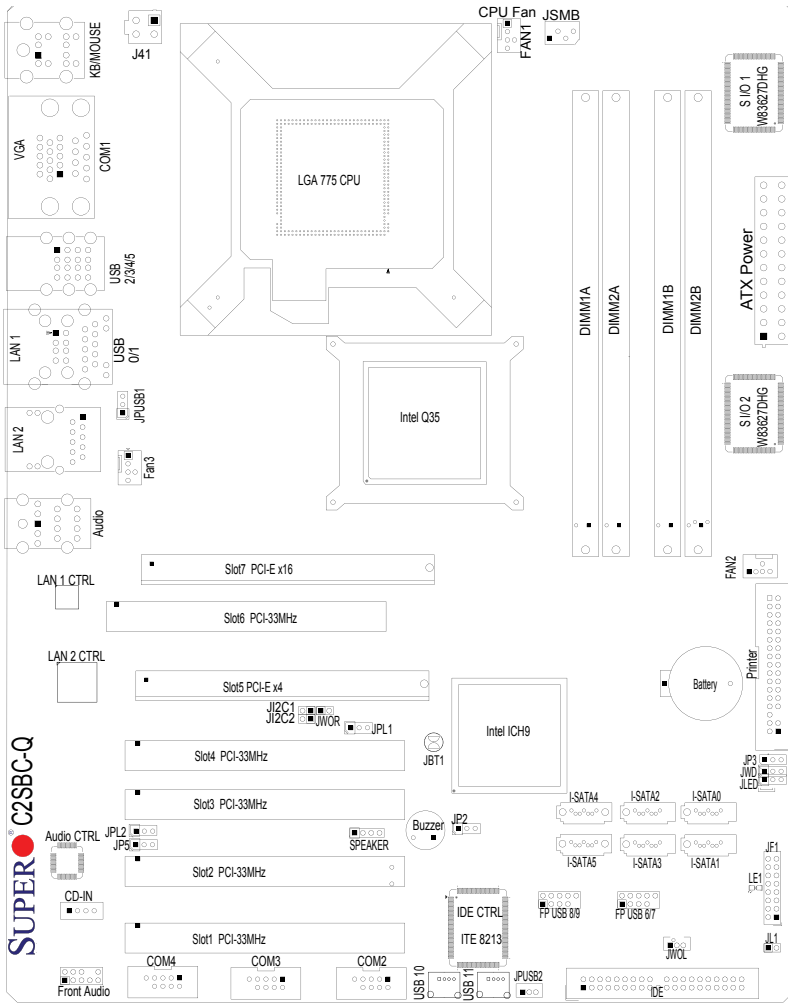

Important Notes to the User

- Jumpers not indicated are for testing only.
- See Chapter 2 for detailed information on jumpers, I/O ports and JF1 front panel connections.
- "■" indicates the location of Pin 1.
- For RAID Configuration and OS installation instructions, please refer to the user guides posted on our web site at www.supermicro.com.

SUPER[®] C2SBC-Q Quick Reference

<u>Jumpers</u>	<u>Description</u>	<u>Default Setting</u>
JBT1	CMOS Clear	See Chapter 2
JP3	TPM (See Page 4-21)	Leave at Disabled
J1 C1/J1 ² C2	SMB to PCI Slots	Open/Open (Disabled)
JP2	IDE Enabled	Pins 1-2 (Enabled)
JP5	Audio Enabled	Pins 1-2 (Enabled)
JPL1/JPL2	Gigabit LAN 1/LAN 2 Enable	Pins 1-2 (Enabled)
JUSB1/JUSB2	USB 0-5 Enable/USB 6-11 Enable	Pins 1-2 (Enabled)
JWD	Watch Dog Timer Out	Pins 1-2 (Reset)

<u>Connectors</u>	<u>Description</u>
CD1	Audio CD Input Header
COM 1	COM Port 1
COM 2/3/4	Serial Port Headers 2/3/4
Fans 1-3	Fan 1: CPU Fan, Fan 2/3: Chassis Fan Headers
IDE	IDE # 1 Connector
J9	Speaker Header
J12	Front Panel Audio Connector
ATX PWR/J41	ATX 24-Pin Power /12V 4-Pin Power Connectors
J46	Audio Port
JF1	FP Control Panel Header
JL1	Chassis Intrusion Header
JLED	Onboard Power LED Indicator
JSMB	System Management Bus (SMB) Header
JWOL	Wake-on-LAN Header
JWOR	Wake-on-Ring Header
LAN1/LAN2	Ethernet RJ45 (Gigabit LAN) Connectors
SATA 0-5	SATA Headers
SPKR1	Internal Buzzer
S_GPIO	Serial_Link_General Purpose I/O Header
USB 0-1	(Back Panel) Universal Serial Ports
USB 2-5	(Back Panel) Universal Serial Ports
USB 6/7-8/9	(Front Panel) USB Headers
USB 10-11	Front Accessible USB Ports
VGA	Video Graphics Connector

<u>LED Indicator</u>	<u>Description</u>
LE1	Standby Power LED Indicator

Motherboard Features

Processor

- Single Intel Core 2 Duo/Core 2 Quad processor with a system bus speed of 1333/1066/800 MHz

Memory

- Single or dual channel non-ECC unbuffered DDR2 up to 8GB/s at 800/667 MH for single channel mode or dual-channel interleaved mode in four DIMM sockets

Chipset

- Intel Q35 GMCH
- ICH9DO with support for RAID 0,1,5,10 (for Windows) and RAID 0,1,10 (for Linux)

Expansion Slots

- One (1) PCI-Express x16
- One (1) PCI-Express x4 (x8 physical slot)
- Five (5) 32-bit PCI 33MHz

BIOS

- 16 Mb Firmware SPI Phoenix BIOS Flash BIOS
- DMI 2.3, PCI 2.2, ACPI 1.0/2.0, SMBIOS 2.3, and Plug and Play (PnP)

PC Health Monitoring

- Onboard voltage monitors for CPU Core Voltage, Memory Voltage, +1.8V, +3.3V, +5V standby, +5V, $\pm 12V$, Vbat (battery voltage), and Hyper-Threading.
- Fan status monitor with firmware 4 pin fan speed control
- 3-Phase CPU switching voltage regulator
- SuperDoctor III, Watch Dog, NMI
- Power-up mode control for recovery from AC power loss
- CPU/System overheat LED and control
- System resource alert via Supero Doctor III
- Auto-switching voltage regulator for the CPU core
- CPU Thermal Trip support
- Thermal Management 2 (TM2) support

ACPI Features

- Slow blinking LED for suspend state indicator
- BIOS support for USB keyboard

- Main switch override mechanism
- External modem ring-on

Onboard I/O

- Built in ICH9DO SATA Controller, 6 connectors for up to 6 devices
- 4 Fast UART 16550 compatible serial port/header
- Intel 82566DM and Intel 82573 Gigabit Ethernet controllers
- PS/2 mouse and PS/2 keyboard ports
- ITE-8213 IDE Controller with one IDE channel/two devices supported
- 12 USB (Universal Serial Bus) 2.0 ports
- Realtek ALC 883 7.1 Channel High Definition Audio (HDA) codecs supports 10 DAC Channels
- Built-in GMCH and onboard VGA Connector

Other

- Wake-on-LAN (WOL)
- Wake-on-Ring (WOR)
- Suspend-to-RAM
- Onboard +5V Standby Power Warning LED ("LE1")
- Lead Free

CD Utilities

- BIOS flash upgrade utility
- Drivers and software for Intel Q35 chipset utilities

Dimensions

- ATX form factor, 12.0" x 9.6" (304.8 x 243.8 mm)

Note:



For RAID Configuration and OS installation instructions, please refer to the user guides posted on our web site at www.supermicro.com.

Block Diagram

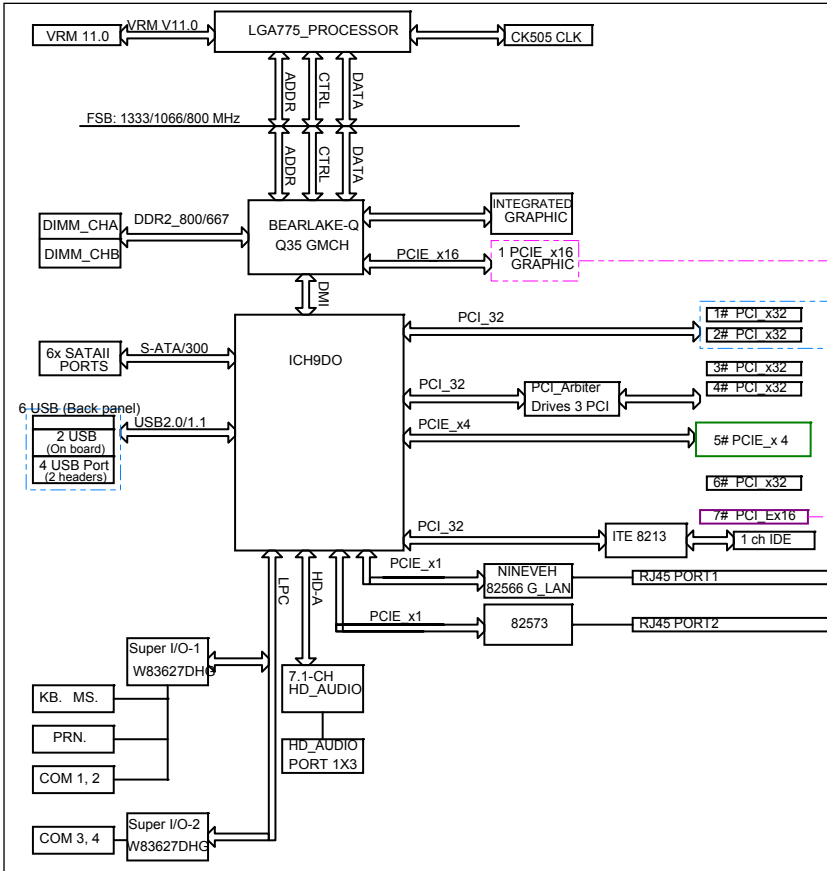

**C2SBC-Q
System Block Diagram**



Note: This is a general block diagram and may not exactly represent the features on your motherboard. See the following pages for the actual specifications of each motherboard.

1-2 Chipset Overview

The Intel Q35 Chipset is specially designed for use with Intel Core 2 Duo and Quad core processors. It consists of two primary components: the Graphic Memory Controller Hub (GMCH) and the I/O Controller Hub (ICH9). The GMCH manages the data flow between the CPU interface, the System Memory interface, the External Graphics interface, and the I/O Controller through the Direct Media Interface (DMI). The ICH9DO provides a multitude of I/O related functions.

Graphic Memory Controller Hub (GMCH)

Utilizing a single LGA 775 socket processor, the Q35 GMCH supports an FSB frequency of 1333/1066/800 MHz. Host-initiated I/O cycles are decoded to the PCI-Express, the DMI, or the GMCH configuration space. Host-initiated memory cycles are decoded to PCI-Express, DMI or system memory. The GMCH supports 36-bit host bus addressing and a cache line size of 64 bytes.

The GMCH supports one or two channels of DDR2 memory with up to two DIMMs per channel with a maximum bandwidth of 6.4 GB/s in asymmetric mode or 12.8 GB/s in symmetric mode using DDR2 800 MHz memory. It also supports an opportunistic refresh scheme, a memory thermal management scheme and Partial Writes to Memory using Data Mask (DM) signals.

The GMCH contains one PCI-Express x16 port intended for an external PCI-Express graphics card that is compatible with the PCI Express Base Specification revision 1.1. This PCI-E x16 port runs at a frequency of 2.5 GB/s on each lane and supports a maximum theoretical bandwidth of 40 GB/s in each direction for an aggregate of 8 GB/s @ x16. It supports traditional PCI-/AGP-style traffic and a PCI Enhanced Addressing Mechanism with advanced capabilities in automatic discovery, negotiation and training of link out of reset.

Providing the high-speed, chip-to-chip connection between the GMCH and ICH9DO is the Direct Media Interface (DMI). The DMI integrates advanced priority-based servicing, allowing for concurrent traffic, true isochronous transfer capabilities and permitting current as well as legacy software to function seamlessly.

Intel ICH9DO System Features

The Intel 9th Generation I/O Controller Hub (ICH9DO) supports a variety of I/O related functions and PCI devices, including the following:

- DMI-to PCI Bridge
- LPC Controller
- SATA Controllers #1 and #2
- Thermal Subsystem
- SMBus Controller
- USB FS/LS UHCI Controllers #1, #2 and #3

1-3 Recovery from AC Power Loss

BIOS provides a setting for you to determine how the system will respond when AC power is lost and then restored to the system. You can choose for the system to remain powered off (in which case you must hit the power switch to turn it back on) or for it to automatically return to a power on state. See the Power Lost Control setting in the BIOS chapter of this manual to change this setting. The default setting is **Last State**.

1-4 PC Health Monitoring

This section describes the PC health monitoring features of the C2SBC-Q. The motherboard has an onboard System Hardware Monitor chip that supports PC health monitoring.

The onboard voltage monitor will scan the Onboard Voltage Monitors for the CPU Core, +1.8V, +3.3V, +5V standby, +5V, Vbat and $\pm 12V$ continuously. Once a voltage becomes unstable, it will give a warning or send an error message to the screen. Users can adjust the voltage thresholds to define the sensitivity of the voltage monitor by using SuperO Doctor III.

1-5 ACPI Features

ACPI stands for Advanced Configuration and Power Interface. The ACPI specification defines a flexible and abstract hardware interface that provides a standard to integrate power management features throughout a PC system, including its hardware, operating system and application software. This enables the system to automatically turn on and off peripherals such as CD-ROMs, network cards, hard disk drives and printers. This also includes consumer devices connected to the PC such as VCRs, TVs, telephones and stereos.

In addition to enabling operating system-directed power management, ACPI provides a generic system event mechanism for Plug and Play and an operating-system-independent interface for configuration control. ACPI leverages the Plug and Play BIOS data structures while providing a processor architecture-independent implementation that is compatible with Windows 2000, Windows XP, Windows 2003, Windows 2003 Servers.

Enhanced Power Management

The onboard ICH9DO chip provides advanced power management functions that will greatly improve the performance of various low-power (suspend) states and en-

hance clock control. A hardware-based component provides software-independent thermal management that is compatible with the ACPI Revision 3.0a.

Slow Blinking LED for Suspend-State Indicator

When the CPU goes into a suspend state, the chassis power LED will start blinking to indicate that the CPU is in suspend mode. When the user presses any key, the CPU will wake-up and the LED will automatically stop blinking and remain on.

BIOS Support for USB Keyboard

If the USB keyboard is the only keyboard in the system, it will function like a normal keyboard during system boot-up.

Wake-On-LAN (WOL)

Wake-On-LAN is defined as the ability of a management application to remotely power up a computer that is powered off. Remote PC setup, up-dates and asset tracking can occur after hours and on weekends so that daily LAN traffic is kept to a minimum and users are not interrupted. The motherboard has a 3-pin header (WOL) to connect to the 3-pin header on a Network Interface Card (NIC) that has WOL capability. In addition, an onboard LAN controller can also support WOL without any connection to the WOL header. The 3-pin WOL header is to be used with a LAN add-on card only.



***Note:** Wake-On-LAN requires an ATX 2.01 (or above) compliant power supply.*

1-6 Power Supply

As with all computer products, a stable power source is necessary for proper and reliable operation. It is even more important for processors that have high CPU clock rates of 1 GHz and faster.

The **SUPER**® C2SBC-Q accommodates 12V ATX power supplies. Although most power supplies generally meet the specifications required by the CPU, some are inadequate. A 2A of current supply on a 5V Standby rail is strongly recommended.

It is strongly recommended that you use a high quality power supply that meets 12V ATX power supply Specification 1.1 or above. It is also required that the 12V 4-pin power connection (J41) be used for high-load configurations. In areas where noisy power transmission is present, you may choose to install a line filter to shield the computer from noise. It is recommended that you also install a power surge protector to help avoid problems caused by power surges.

1-7 Versatile Media Capabilities

High Definition Audio

The High Definition Audio Controller embedded in the ICH9DO delivers up to four codecs that can be used for different types of codecs, such as audio and modem codecs. Operating at 3.3V or 1.5V, the embedded Audio Controller supports a multi-channel audio stream, 32-bit sample depth, up to 192 kHz of same rate, and can be used with a variety of microphones for input. With these versatile audio capabilities built in, the C2SBC-Q provides the user with a state of the art audio experience that is larger than life.

I/O Virtualization Technology (VT-d)

With the Intel ICH9DO built in, the C2SBC-Q supports I/O Virtualization Technology (VT-d) that enables multiple operating systems and applications to run in independent partitions. Each partition uses its own subset of host physical memory, and behaves like a virtual machine (VM), providing isolation and protection across multiple partitions. This feature is available when a processor that supports the virtualization of platforms is installed on the motherboard.

1-8 Super I/O

The disk drive adapter functions of the Super I/O chip include a data separator, write pre-compensation circuitry, decode logic, data rate selection, a clock generator, drive interface control logic and interrupt and DMA logic. The wide range of functions integrated onto the Super I/O greatly reduces the number of components required for interfacing with floppy disk drives. The Super I/O supports two 360 K, 720 K, 1.2 M, 1.44 M or 2.88 M disk drives and data transfer rates of 250 Kb/s, 500 Kb/s or 1 Mb/s.

It also provides two high-speed, 16550 compatible serial communication ports (UARTs). Each UART includes a 16-byte send/receive FIFO, a programmable baud rate generator, complete modem control capability and a processor interrupt system. Both UARTs provide legacy speed with baud rate of up to 115.2 Kbps as well as an advanced speed with baud rates of 250 K, 500 K, or 1 Mb/s, which support higher speed modems.

The Super I/O provides functions that comply with the ACPI (Advanced Configuration and Power Interface), which includes support of legacy and ACPI power management through a SMI or SCI function pin. It also features auto power management to reduce power consumption.

Chapter 2

Installation

2-1 Static-Sensitive Devices

Electro-static Discharge (ESD) can damage electronic components. To prevent damage to your system board, it is important to handle it very carefully. The following measures are generally sufficient to protect your equipment from ESD.

Precautions

- Use a grounded wrist strap designed to prevent static discharge. Touch a grounded metal object before removing the board from the antistatic bag.
- Handle the board by its edges only; do not touch its components, peripheral chips, memory modules or gold contacts.
- When handling chips or modules, avoid touching their pins.
- Put the motherboard and peripherals back into their antistatic bags when not in use.
- For grounding purposes, make sure your computer chassis provides excellent conductivity between the power supply, the case, the mounting fasteners and the motherboard.
- Use only the correct type of onboard CMOS battery as specified by the manufacturer. Do not install the onboard battery upside down to avoid possible explosion.

Unpacking

The motherboard is shipped in antistatic packaging to avoid static damage. When unpacking the board, make sure the person handling it is static protected.

2-2 Motherboard Installation

Note: Be sure to mount the motherboard into the chassis before you install the CPU onto the motherboard.

All motherboards have standard mounting holes to fit different types of chassis. Make sure that the locations of all the mounting holes for both motherboard and chassis match. Make sure that the metal standoffs click in or are screwed in tightly. Then use a screwdriver to secure the motherboard onto the motherboard tray. (**Caution:** 1. Please do not use a force greater than 8 lb/inch on each mounting screw during motherboard installation. 2. Some components are very close to the mounting holes. Please take precautionary measures to prevent damage to these components when installing the motherboard to the chassis.)

2-3 Processor and Heatsink Installation



Warning: When handling the processor package, avoid placing direct pressure on the label area of the fan.



Notes:

1. Always connect the power cord last and always remove it before adding, removing or changing any hardware components. Make sure that you install the processor into the CPU LGA 775 socket before you install the CPU heatsink.
2. The Intel LGA 775 Processor package contains the CPU fan and heatsink assembly. If you buy a CPU separately, make sure that you use only Intel-certified multi-directional heatsink and fan.
4. Make sure to install the motherboard into the chassis before you install the CPU heatsink and fan.
5. When receiving a motherboard with an LGA 775 Processor pre-installed, make sure that the CPU plastic cap is in place and none of the CPU pins are bent; otherwise, contact the retailer immediately. Refer to the MB Features Section for more details on CPU support.

Installing an LGA 775 Processor

1. Press the load lever to release the load plate, which covers the CPU socket, from its locking position.

PnP Cap on top of the Load Plate
Load Lever

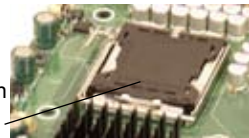

2. Gently lift the load lever to open the load plate.

Load Plate (with PnP Cap attached)



3. Use your thumb and your index finger to hold the CPU at the top center edge and the bottom center edge of the CPU.

4. Align CPU Pin1 (the CPU corner marked with a triangle) against the socket corner that is marked with a triangle cutout.

5. Align the CPU key that is the semi-circle cutout below a golden dot against the socket key, the Notch on the same side of the triangle cutout on the socket.

6. Once aligned, carefully lower the CPU straight down to the socket. (Do not drop the CPU on the socket. Do not move the CPU horizontally or vertically. Do not rub the CPU against the surface or against any pins of the socket to avoid damage to the CPU or the socket.)

7. With the CPU inside the socket, inspect the four corners of the CPU to make sure that the CPU is properly installed.

8. Use your thumb to gently push the load lever down to the lever lock.

9. If the CPU is properly installed into the socket, the plastic PnP cap will be automatically released from the load plate when the load lever is pushed in the lever lock. Remove the PnP cap from the motherboard.

 **Warning:** Please save the plastic PnP cap. The motherboard must be shipped with the PnP cap properly installed to protect the CPU socket pins. Shipment without the PnP cap properly installed will cause damage to the socket pins.

Top Center Edge



Bottom Center Edge

golden dot

Socket Key
(Socket Notch)CPU Key (semi-
circle cutout)
below the circle.Corner with a
triangle cutout

CPU Pin1

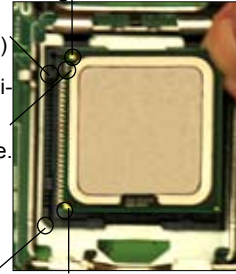

Load Lever

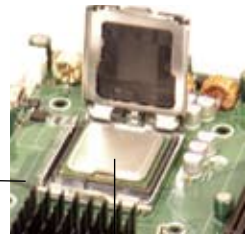

CPU in the CPU socket



Plastic cap is released from the load plate if CPU properly installed.



Installing the Heatsink

1. Locate the CPU Fan on the motherboard. (Refer to the layout on the right for the CPU Fan location.)
2. Position the heatsink in such a way that the heatsink fan wires are closest to the CPU fan and are not interfered with other components.
3. Inspect the CPU Fan wires to make sure that the wires are routed through the bottom of the heatsink.
4. Remove the thin layer of the protective film from the copper core of the heatsink.



Warning: CPU overheating may occur if the protective film is not removed from the heatsink.

5. Apply the proper amount of thermal grease on the CPU.



Note: if your heatsink came with a thermal pad, please ignore this step.)

6. If necessary, rearrange the wires to make sure that the wires are not pinched between the heatsink and the CPU. Also make sure to keep clearance between the fan wires and the fins of the heatsink.

7. Align the four heatsink fasteners with the mounting holes on the motherboard. Gently push the pairs of diagonal fasteners (#1 & #2, and #3 & #4) into the mounting holes until you hear a click.



Note: Make sure to orient each fastener in a way that the narrow end of the groove is pointing outward.

Thermal Grease

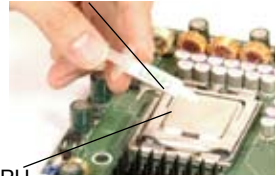

CPU

Fan Wires

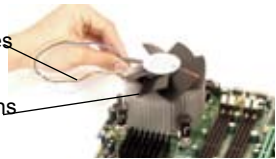

Heatsink Fins



Heatsink Fastener

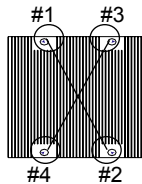

Narrow end of the groove points outward

8. Repeat Step 6 to insert all four heatsink fasteners into the mounting holes.
9. Once all four fasteners are securely inserted into the mounting holes and the heatsink is properly installed on the motherboard, connect the heatsink fan wires to the CPU Fan connector.

Removing the Heatsink

1. Unplug the power cord from the power supply.
2. Disconnect the heatsink fan wires from the CPU fan header.
3. Use your finger tips to gently press on the fastener cap and turn it counterclockwise to make a 1/4 (90°) turn, and then pull the fastener upward to loosen it.
4. Repeat Step 3 to loosen all fasteners from the mounting holes.
5. With all fasteners loosened, remove the heatsink from the CPU.



2-4 Installing DIMMs



Note: Check the Supermicro web site for recommended memory modules.



Warning: Exercise extreme care when installing or removing DIMM modules to prevent any possible damage. Also note that the memory is interleaved to improve performance. (See step 1).

DIMM Installation

1. Insert the desired number of DIMMs into the memory slots, starting with DIMM1A. The memory scheme is interleaved; therefore, we recommend that you install two modules at a time, beginning with DIMM1A, DIMM1B, then, DIMM2A and DIMM2B
2. Insert each DIMM module vertically into its slot. Pay attention to the notch along the bottom of the module to prevent inserting the DIMM module incorrectly.
3. Gently press down on the DIMM module until it snaps into place in the slot. Repeat for all modules. (See step 1 above).

Memory Support

The C2SBC-Q supports up to 8 GB Unbuffered Non-ECC DDR2 800/677 MHz in 4 DIMMs. Populating DIMM1A, DIMM1B, and/or DIMM2A, DIMM2B with memory modules of the same size and of the same type will result in dual channel, two-way interleaved memory which is faster than the single channel, non-interleaved memory.

Notes:



1. Due to the OS limitations, some operating systems may not show more than 4GB of memory.
2. Both Unbuffered ECC and Non-ECC memory modules can be installed in the memory slots. However, the functionality of ECC is not supported by the chipset.
3. Due to memory allocation to system devices, memory remaining available for operational use will be reduced when 4 GB of RAM is used. The reduction in memory availability is disproportional. (Refer to the following Memory Availability Table for details.) For Microsoft Windows users: Microsoft implemented a design change in Windows XP with Service Pack 2 (SP2) and Windows Vista. This change is specific to the Physical Address Extension (PAE) mode behavior which improves driver compatibility. For more information, please read the following article at Microsoft's Knowledge Base website at: <http://support.microsoft.com/kb/888137>.

Possible System Memory Allocation & Availability		
System Device	Size	Physical Memory Remaining (-Available) (4 GB Total System Memory)
Firmware Hub flash memory (System BIOS)	1 MB	3.99
Local APIC	4 KB	3.99
Area Reserved for the chipset	2 MB	3.99
I/O APIC (4 Kbytes)	4 KB	3.99
PCI Enumeration Area 1	256 MB	3.76
PCI Express (256 MB)	256 MB	3.51
PCI Enumeration Area 2 (if needed) -Aligned on 256-MB boundary-	512 MB	3.01
VGA Memory	16 MB	2.85
TSEG	1 MB	2.84
Memory available to OS and other applications		2.84

Installing and Removing DIMMs

To Install:

Insert module vertically and press down until it snaps into place. Pay attention to the notch.

To Remove:

Use your thumbs to gently push each release tab outward to release the DIMM from the slot.

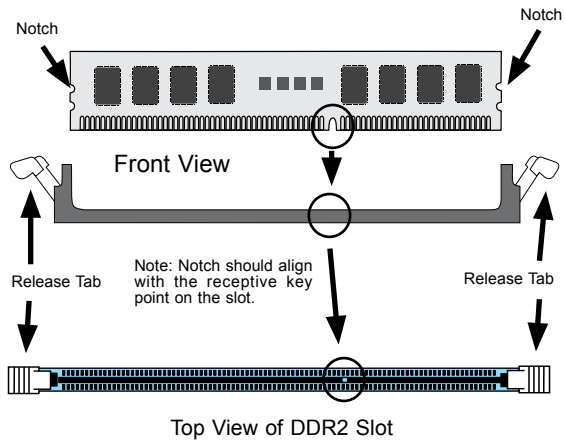

2-5 Control Panel Connectors/IO Ports

The I/O ports are color coded in conformance with the PC 99 specification. See the graphics below for the colors and locations of the various I/O ports.

1. Back Panel Connectors/IO Ports

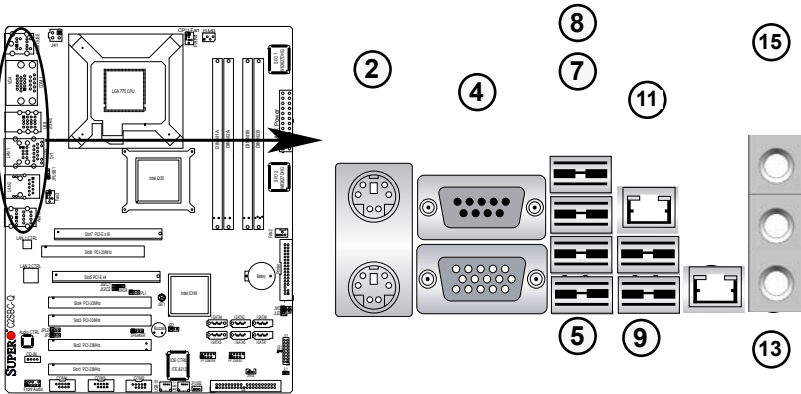

Back Panel I/O Port Locations and Definitions

Back Panel Connectors

1. Keyboard (Purple)
 2. PS/2 Mouse (Green)
 3. COM 1
 4. VGA
 5. USB Port 0
 6. USB Port 1
 7. USB Port 2
 8. USB Port 3
 9. USB Port 4
 10. USB Port 5
 11. Gigabit LAN 1
 12. Gigabit LAN 2
 13. Microphone-In (Pink)
 14. Front (Green)
 15. Line-In (Blue)
- (See Section 2-5 for details.)

2. Front Control Panel

JF1 contains header pins for various buttons and indicators that are normally located on a control panel at the front of the chassis. These connectors are designed specifically for use with Super Micro server chassis. See graphics for the descriptions of the various control panel buttons and LED indicators. Refer to the following section for descriptions and pin definitions.

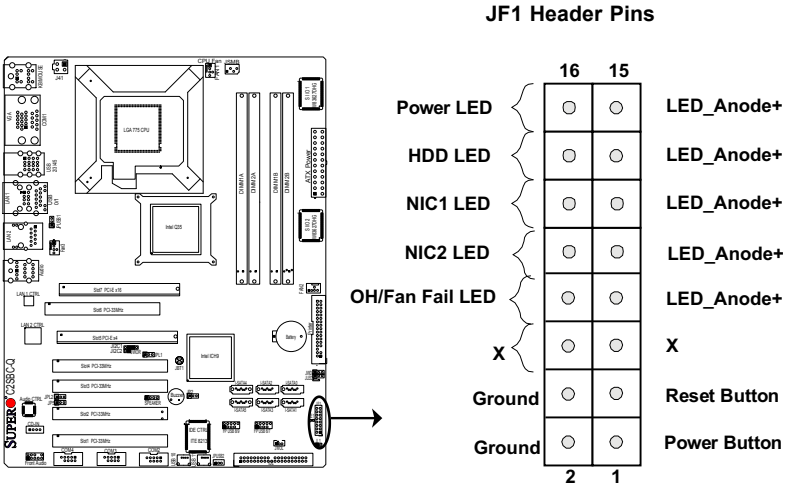

3. Front Control Panel Pin Definitions

Power LED

The Power LED connection is located on pins 15 and 16 of JF1. Refer to the table on the right for pin definitions.

Power LED Pin Definitions (JF1)	
Pin#	Definition
15	LED_Anode+
16	PWR LED Signal

HDD LED

The HDD LED connection is located on pins 13 and 14 of JF1. Attach a hard drive LED cable here to display disk activity (for any hard drives on the system, including SAS and Serial ATA). See the table on the right for pin definitions.

HDD LED Pin Definitions (JF1)	
Pin#	Definition
13	LED_Anode+
14	HD Active

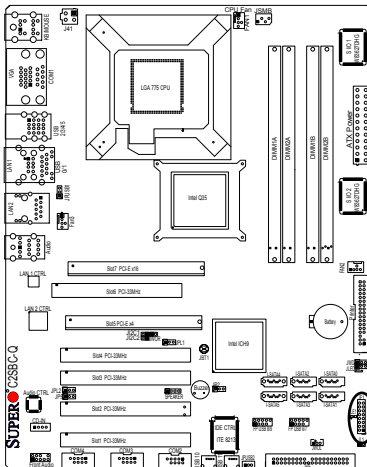

- A. PWR LED connector
- B. HDD LED connector

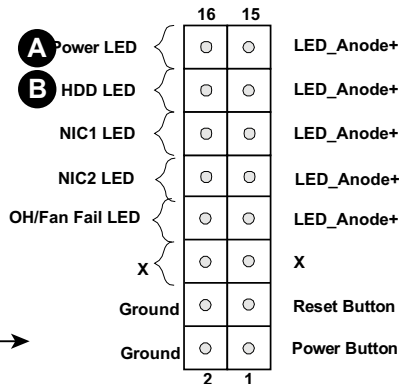

NIC1/NIC2 LED Indicators

The NIC (Network Interface Controller) LED connection for GLAN port1 is located on pins 11 and 12 of JF1, and the LED connection for GLAN Port2 is on Pins 9 and 10. Attach NIC LED cables to display network activity. Refer to the table on the right for pin definitions.

GLAN1/2 LED Pin Definitions (JF1)	
Pin#	Definition
9/11	Vcc
10/12	Ground

Overheat/Fan Fail LED (OH)

Connect an LED cable to the OH/Fan Fail connection on pins 7 and 8 of JF1 to provide advanced warnings of chassis overheating or fan failure. Refer to the table on the right for pin definitions.

OH/Fan Fail LED Pin Definitions (JF1)	
Pin#	Definition
7	LED_Anode+
8	OH/Fan Fail LED Signal

OH/Fan Fail Indicator Status	
State	Definition
Off	Normal
On	Overheat
Flash-ing	Fan Fail

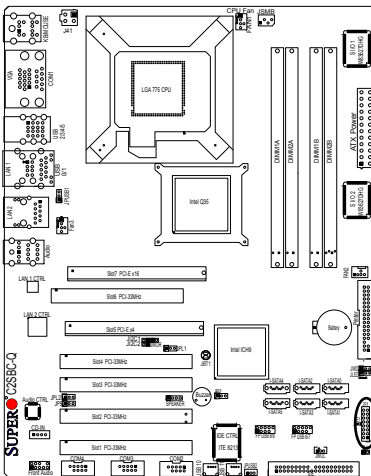

- A. NIC1 LED
- B. NIC2 LED
- C. OH/Fan Fail LED

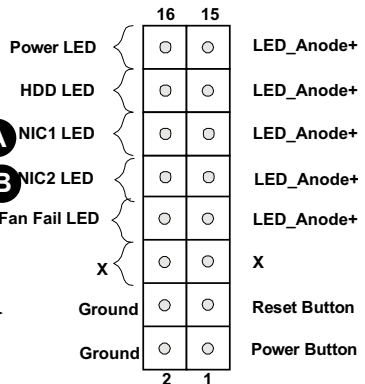

Reset Button

The Reset Button connection is located on pins 3 and 4 of JF1. Attach it to a hardware reset switch on the computer case. Refer to the table on the right for pin definitions.

Reset Button Pin Definitions (JF1)	
Pin#	Definition
3	Reset
4	Ground

Power Button

The Power Button connection is located on pins 1 and 2 of JF1. Momentarily contacting both pins will power on/off the system. This button can also be configured to function as a suspend button (with a setting in the BIOS - see Chapter 4). To turn off the power when set to suspend mode, press the button for at least 4 seconds. Refer to the table on the right for pin definitions.

Power Button Pin Definitions (JF1)	
Pin#	Definition
1	Signal
2	+3V Standby



Note: Do not close or short Pins 1 & 2 since this will cause the system to continuously reboot.

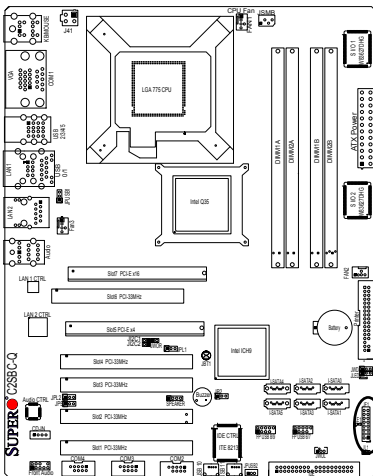

- A. Reset
- B. PWR Button

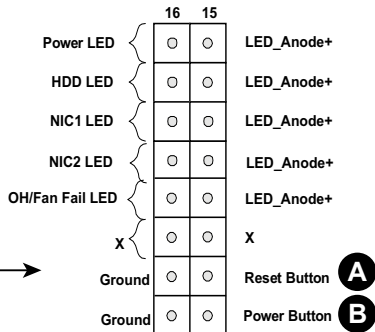

2-6 Connecting Cables

ATX/Auxiliary Power Connectors

A 24-pin main power connector is located at J40, and a 4-pin power connector is located at J41 on the motherboard. These power connectors meet the SSI EPS 12V specification.



Note: The 4-pin 12V PWR supply is also required to provide adequate power to the system. See the table on the right for pin definitions.

ATX Power 24-pin Connector Pin Definitions			
Pin#	Definition	Pin #	Definition
13	+3.3V	1	+3.3V
14	-12V	2	+3.3V
15	COM	3	COM
16	PS_ON	4	+5V
17	COM	5	COM
18	COM	6	+5V
19	COM	7	COM
20	Res (NC)	8	PWR_OK
21	+5V	9	5VSB
22	+5V	10	+12V
23	+5V	11	+12V
24	COM	12	+3.3V

GLAN 1 and GLAN 2 (Giga-bit Ethernet Port)

Two (Giga-bit) Ethernet ports are located on the IO backplane. GLAN 1 is located above USB Ports 1 & 2. Both GLAN ports accept RJ45 type cables.



12V 4-pin Power Connector Pin Definitions	
Pins	Definition
1 and 2	Ground
3 and 4	+12V

Required Connection

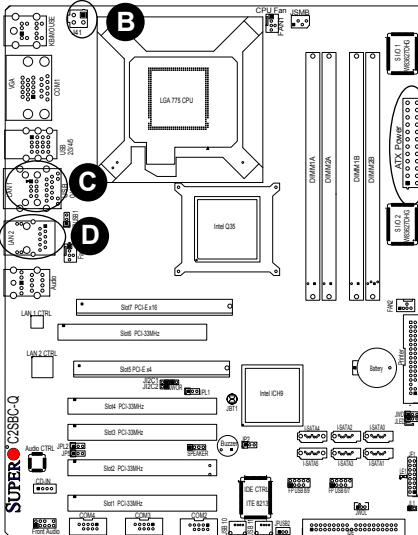

- A. 24-pin ATX PWR
- B. 4-pin PWR

Universal Serial Bus (USB)

There are 12 USB 2.0 (Universal Serial Bus) ports/headers on the motherboard. Six of them are Back Panel USB ports: USB 0/1 (J11) and USB 2/3/4/5 (J43). USB 6/7 (J44), and USB 8/9 (J45) are headers that can be used for front panel connections. Additionally, USB 10 (J47) and USB 11 (J48) are onboard USB connectors that can be accessed from the front side of the chassis. See the tables on the right for pin definitions.

Back Panel USB (0-5)	
Pin#	Definitions
1	+5V
2	PO-
3	PO+
4	Ground
5	N/A

Front Panel USB (6/7/8/9 and Front-Accessible Onboard USB (10/11) Connections			
Pin #	Definition	Pin #	Definition
1	+5V	1	+5V
2	PO-	2	PO-
3	PO+	3	PO+
4	Ground	4	Ground
5	Key	5	No connection

Chassis Intrusion

A Chassis Intrusion header is located at JL1 on the motherboard. Attach an appropriate cable from the chassis to inform you of a chassis intrusion when it is opened.

Chassis Intrusion Pin Definitions (JL1)	
Pin#	Definition
1	Intrusion Input
2	Ground

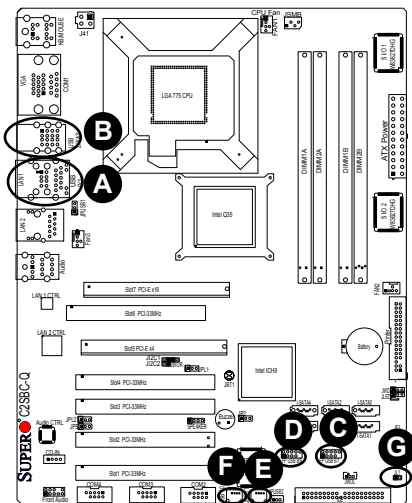

- A. Back panel USB Ports 0/1
- B. Back panel USB Ports 2/3/4/5
- C. Front Panel USB 6/7
- D. Front Panel USB 8/9
- E. USB 10
- F. USB 11
- G. Chassis Intrusion

Fan Headers

The C2SBC-Q has three chassis fan headers (Fan 1 to Fan 3). Fan 1 is the CPU Fan. Fan 2 to Fan 3 are system/chassis fans.

Note: Pins 1-3 of a 4-pin fan headers are backward compatible with the traditional 3-pin fans. See the table on the right for pin definitions. The onboard fan speeds are controlled by Thermal Management via BIOS Hardware Monitoring in the Advanced Setting. (**Note:** Default: **Disabled**. When using Thermal Management settings, please use all 3-pin fans or all 4-pin fans on the motherboard.)



Fan Header Pin Definitions (Fan1-3)	
Pin#	Definition
1	Ground
2	+12V
3	Tachometer
4	PWR Modulation

VGA Connector

A VGA connector (JG1) is located next to the USB ports on the IO backplane. Refer to the board layout below for the location.

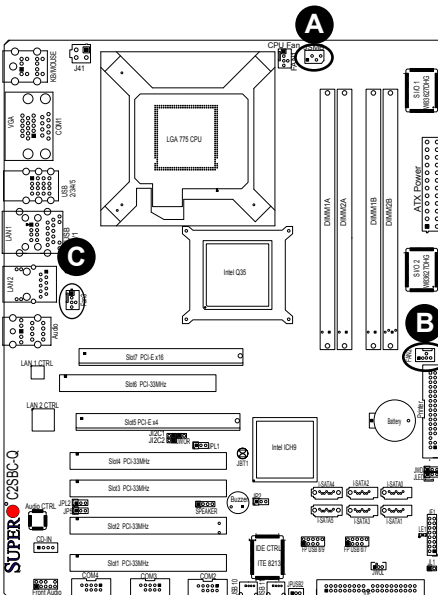

- A. Fan 1 (CPU Fan)
- B. Fan 2
- C. Fan 3

ATX PS/2 Keyboard and PS/2 Mouse Ports

The ATX PS/2 keyboard and the PS/2 mouse are located at J28. See the table on the right for pin definitions. (The mouse port is above the keyboard port. See the table on the right for pin definitions.)

PS/2 Keyboard and Mouse Port Pin Definitions	
Pin#	Definition
1	Data
2	NC
3	Ground
4	VCC
5	Clock
6	NC

Serial Ports

COM1 (JGS1) is a connector located on the IO Backpanel, and COM2-4 are headers located at J13-15. See the table on the right for pin definitions.

Serial Port Pin Definitions Pin Definitions			
Pin #	Definition	Pin #	Definition
1	DCD	6	DSR
2	RXD	7	RTS
3	TXD	8	CTS
4	DTR	9	RI
5	Ground	10	NC

(Pin 10 is available on COM2, COM3, COM4 only. NC: No Connection.)

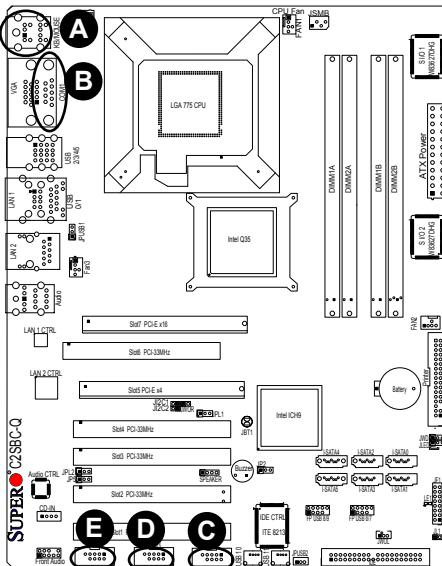

- A. Keyboard/Mouse
- B. COM1
- C. COM2
- D. COM3
- E. COM4

Wake-On-Ring

The Wake-On-Ring header is designated JWOR. This function allows your computer to receive and be "awakened" by an incoming call when in the suspend state. See the table on the right for pin definitions. You must have a Wake-On-Ring card and cable to use this feature.

Wake-On-Ring Pin Definitions (JWOR)	
Pin#	Definition
1	Ground
2	Wake-up

Wake-On-LAN

The Wake-On-LAN header is located at JWOL on the motherboard. See the table on the right for pin definitions. (You must also have a LAN card with a Wake-On-LAN connector and cable to use this feature.)

Wake-On-LAN Pin Definitions (JWOL)	
Pin#	Definition
1	+5V Standby
2	Ground
3	Wake-up

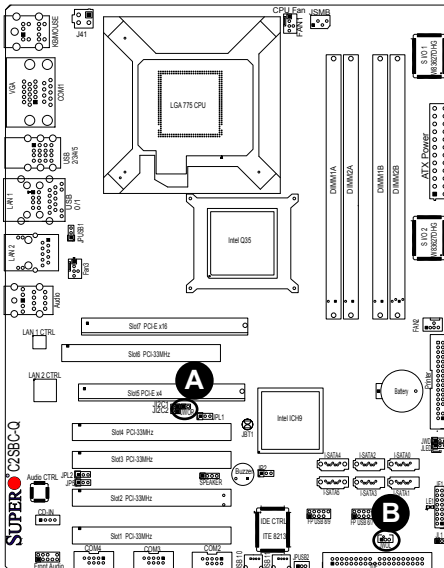

A. JWOR

B. JWOL

Speaker

A Speaker/Buzzer header is located on the motherboard. See the table on the right for speaker pin definitions.



Note: The speaker connector pins are for use with an external speaker. If you wish to use the onboard speaker, you should close pins 3-4 with a jumper.

Speaker Connector Pin Definitions	
Pin Setting	Definition
Pins 3-4	Internal Speaker
Pins 1-4	External Speaker

SMB

The System Management Bus Header (For the PCI bus) is located at JSMB near the CPU fan. Connect the appropriate cable here to utilize SMB on your system. See the table on the right for pin definitions.

PWR SMB Pin Definitions	
Pin#	Definition
1	Data
2	Ground
3	Clock
4	No connection

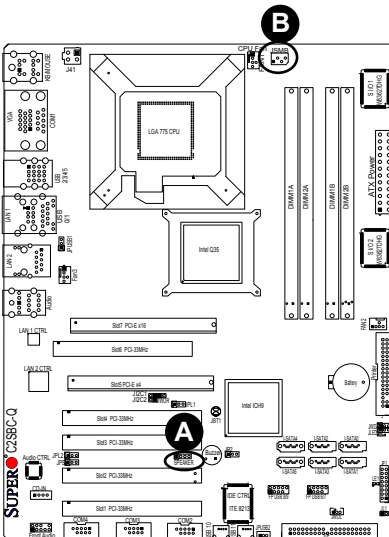

- A. Speaker/Buzzer
- B. SM Bus Header

High Definition Audio (HDA)

The C2SBC-Q features a 7.1+2 Channel High Definition Audio (HDA) (J46) codec that provides 10 DAC channels, simultaneously supporting 7.1 sound playback, and two channels of independent stereo sound output (multiple streaming) through the front panel stereo out for front L&R, and center. This feature is activated with the software included in the CD-ROM that came with your motherboard. Sound is then output through the Line In, Line Out and MIC jacks (See at the picture at right).

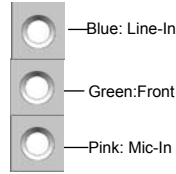

CD Header

A 4-pin CD header is located at CD1, and an Auxiliary header is located at J12 on the motherboard. These headers allow you to use the onboard sound for audio CD playback. Connect an audio cable from your CD drive to the header that fits your cable's connector. Only one CD header can be used at any one time. See the tables at right for pin definitions.

CD1 Pin Definition	
Pin#	Definition
1	Left Stereo Signal
2	Ground
3	Ground
4	Right Stereo Signal

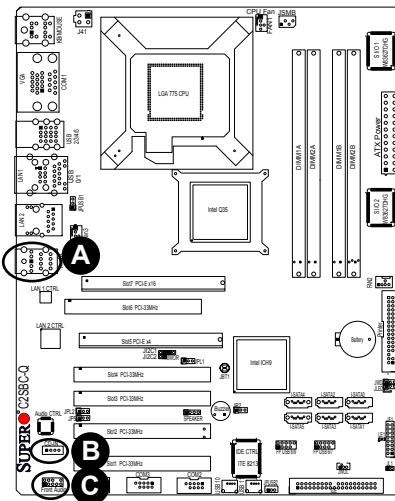

- A. HD Audio
- B. CD-In
- C. Front Panel Audio

Front Panel Audio Control

When front panel headphones are plugged in, the back panel audio output is disabled. This is done through the FP Audio header (J12). If the front panel interface card is not connected to the front panel audio header, jumpers should be installed on the header (J12) pin pairs: 1-2, 5-6, and 9-10. If these jumpers are not installed, the back panel line out connector will be disabled and microphone input Pin 1 will be left floating, which can lead to excessive back panel microphone noise and cross talk. See the table below for pin definitions.

FP Audio Pin Definitions	
Pin#	Defin.
1	MIC_L
2	AUD_GND
3	MIC_R
4	FP-Audio-Detect
5	Line_2_R
6	Ground
7	FP-Jack-Detect
8	Key
9	Line_2_L
10	Ground

Power LED

The Power LED connector is designated JLED. This connection is used to provide LED Indication of power supplied to the system. See the table on the right for pin definitions.

PWR LED Pin Definitions	
Pin#	Definition
1	+5V
2	Key
3	Ground

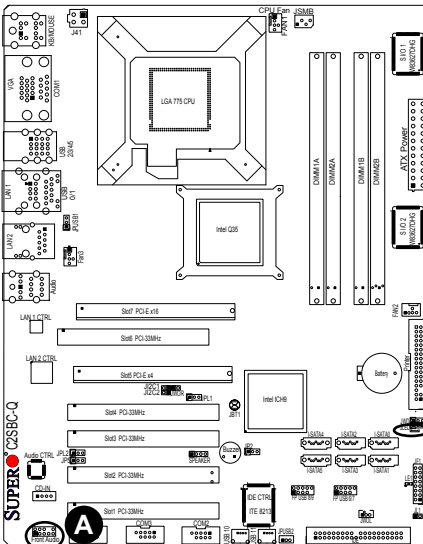

- A. Front Panel Audio
- B. PWR LED

2-7 Jumper Settings

Explanation of Jumpers

To modify the operation of the motherboard, jumpers can be used to choose between optional settings. Jumpers create shorts between two pins to change the function of the connector. Pin 1 is identified with a square solder pad on the printed circuit board. See the motherboard layout pages for jumper locations.



Note: On two pin jumpers, "Closed" means the jumper is on and "Open" means the jumper is off the pins.

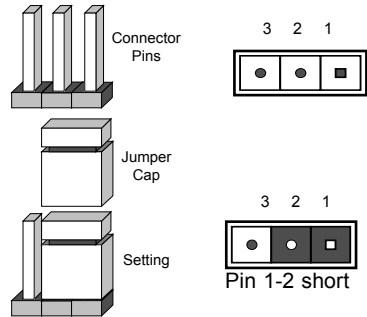

GLAN Enable/Disable

JPL1 enables or disables GLAN 1 Port and JPL2 enables or disables GLAN 2 Port on the motherboard. See the table on the right for jumper settings. The default setting is enabled.

GLAN Enable JPL1/JPL2	
Pin#	Definition
1-2	Enabled (default)
2-3	Disabled

- A. GLAN Port 1 Enable
- B. GLAN Port 2 Enable

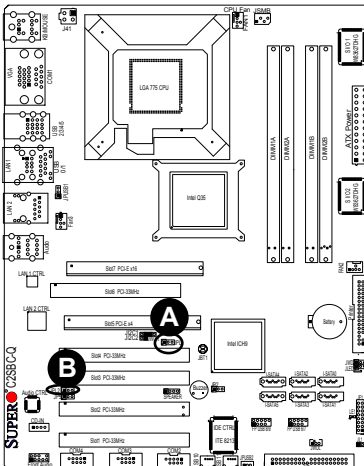

Watch Dog Enable/Disable

Watch Dog is a system monitor that can reboot the system when a software application hangs. Close pins 1-2 to reset the system if an application hangs. Close pins 2-3 to generate a non-maskable interrupt signal for the application that hangs. See the table on the right for jumper settings. Watch Dog must also be enabled in the BIOS. (**Note:** When enabled, the user needs to write his/her own application software to disable the Watch Dog Timer.)

Watch Dog Jumper Settings (JWD)	
Jumper Setting	Definition
Pins 1-2	Reset (default)
Pins 2-3	NMI
Open	Disabled

A. Watch Dog Enable

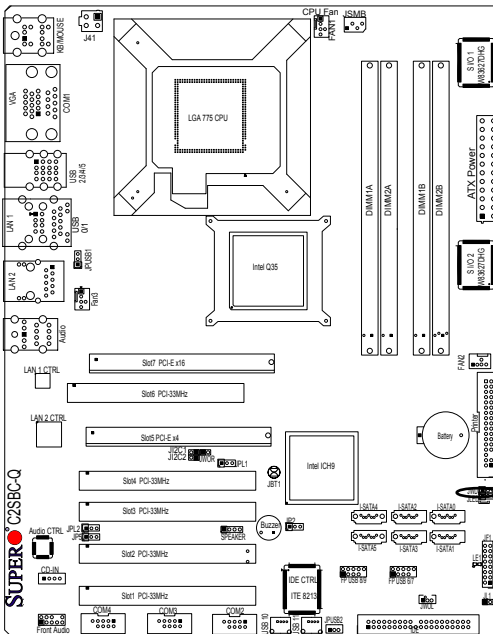

PCI/PCI-E Slots to SMB Speeds

Jumpers J1²C1/J1²C2 allow you to connect PCI/PCI-Exp. Slots to the System Management Bus. The default setting is open to disable the connection. See the table on the right for jumper settings.

SMBus to PCI-X/PCI-Exp Slots Jumper Settings	
Jumper Setting	Definition
Closed	Enabled
Open	Disabled (Default)

Clear CMOS

JBT1 is used to clear CMOS. Instead of pins, this "jumper" consists of contact pads to prevent the accidental clearing of CMOS. To clear CMOS, use a metal object such as a small screwdriver to touch both pads at the same time to short the connection. Always remove the AC power cord from the system before clearing CMOS. 



Note: For an ATX power supply, you must completely shut down the system, remove the AC power cord and then close pins 1 and 2 to clear CMOS.

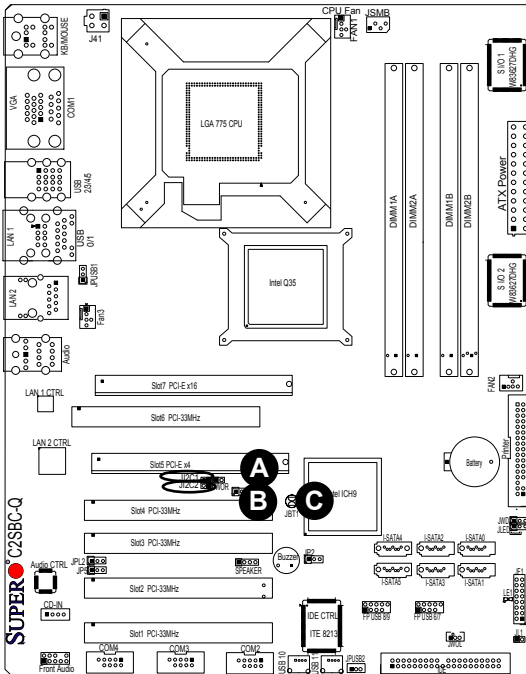

- A. J1²C1
- B. J1²C2
- C. JBT1

IDE Enable/Disable

JP2 enables or disables IDE on the C2SBC-Q. See the table on the right for jumper settings. The default setting is **Enabled**.

IDE Enable (JP2)	
Pin#	Definition
1-2	Enabled (default)
2-3	Disabled

Audio Enable

JP5 enables or disables the onboard audio connections. See the table on the right for jumper settings. The default setting is Enabled.

Audio Enable (JP5)	
Pin#	Definition
1-2	Enabled (default)
2-3	Disabled

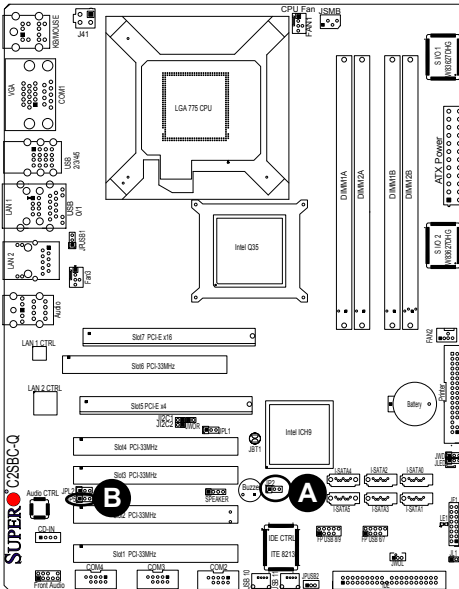

- A. IDE Enable
- B. Audio Enable

USB Wake-Up

Use JPUSB jumpers to enable the function of "System Wake-Up via USB devices", which allows you to "wake-up" the system by pressing a key on the USB keyboard or by clicking the USB mouse of your system. The JPUSB jumpers are used together with the USB Wake-Up function in the BIOS. Enable both the jumpers and the BIOS setting to allow the system to "wake-up via USB Devices". See the table on the right for jumper settings and jumper connections.



Note: JPUSB1 is for Back Panel USB ports:0/1/2/3/4/5, and JPUSB2 is for Front Panel USB ports:6/7/8/9 and 10/11.)

The default jumper setting for the USB ports is **Disabled**. However, when the "USB Wake-Up" function is enabled in the BIOS, and the desired USB ports are enabled via the JPUSB jumper, please be sure to remove all USB devices from the USB ports whose USB jumpers are set to "Disabled" before the system goes into the standby mode.

JPUSB1 (Back Panel USB Wake-up)	
Pin#	Definition
1-2	Enabled (Default)
2-3	Disabled

JPUSB2 (Front Panel USB Wake-up)	
Pin#	Definition
1-2	Enabled
2-3	Disabled (default)

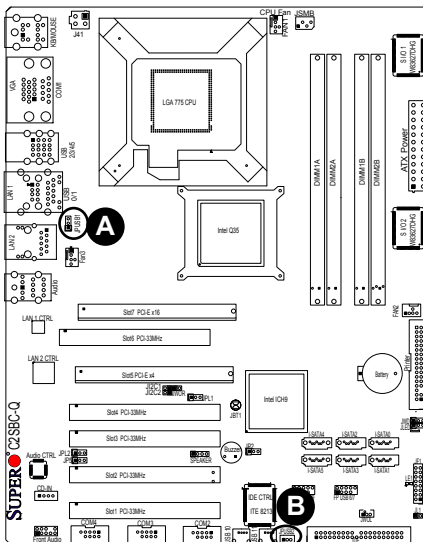

A. JPUSB1

B. JPUSB2

2-8 Onboard Indicators

GLAN LEDs

There are two Gigabit-LAN port (J50, J11). Each Gigabit Ethernet LAN port has two LEDs. The yellow GLAN Activity LED (right, see below) indicates activity, while the GLAN Link/Speed LED (left) may be green, amber or off to indicate the speed of the connection. See the tables at right for more information.

GLAN Link/Speed LED Indicator	
LED Color	Definition
Off	No Connection or 10 Mbps
Green (On)	100 Mbps
Amber (On)	1 Gbps

GLAN Activity LED Indicator	
Color	Definition
Yellow (Flashing)	ConnectionActive

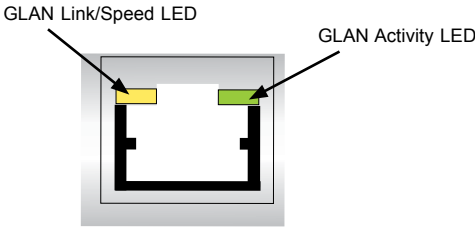

Rear View
(When viewing from the rear side of the chassis.)

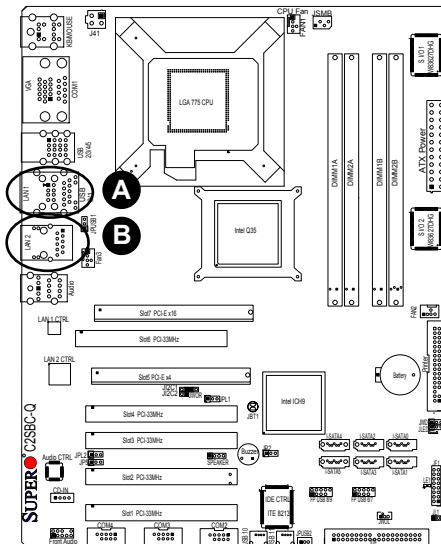

- A. GLAN 1 LEDs
- B. GLAN 2 LEDs

Onboard Power LED (LE1)

The Onboard 3.3V Standby Power LED is located at LE1 on the motherboard. When LE1 is off, the system is off. When the LED is on, the power is on. Unplug the power cable before removing or installing components. See the layout below for the LED location.

Onboard PWR LED Indicator (LE1)	
LED Color	Definition
Off	System Off
On	Standby Power On

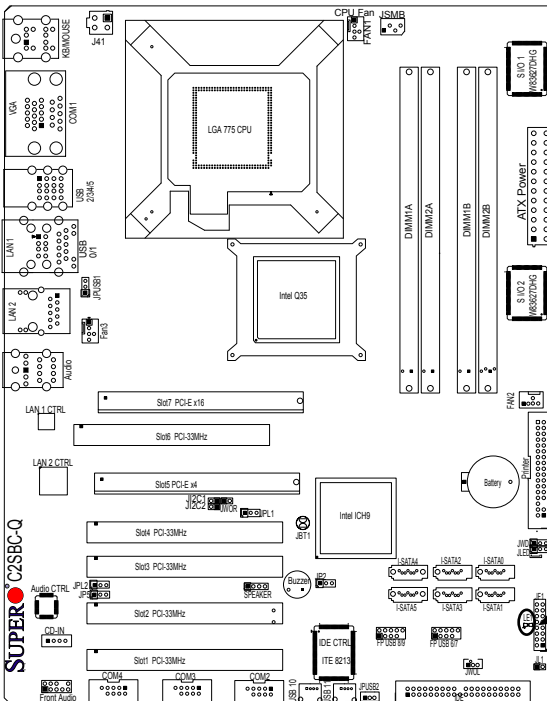

A. Power LED

2-9 Parallel Port Connector and IDE Hard Drive Connections

Note the following when connecting the hard disk drive cables:

- A red mark on a wire typically designates the location of pin 1.

Parallel Port Connector

The parallel (printer) connector is located next to Fan 2. See the table on the right for pin definitions.

Parallel (Printer) Connector Pin Definitions			
Pin#	Definition	Pin #	Definition
1	Strobe-	2	Auto Feed-
3	Data Bit 0	4	Error-
5	Data Bit 1	6	Init-
7	Data Bit 2	8	SLCT IN-
9	Data Bit 3	10	GND
11	Data Bit 4	12	GND
13	Data Bit 5	14	GND
15	Data Bit 6	16	GND
17	Data Bit 7	18	GND
19	ACK	20	GND
21	BUSY	22	Write Data
23	PE	24	Write Gate
25	SLCT	26	NC

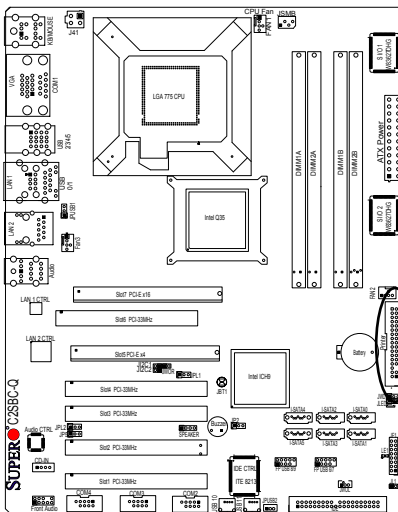

A. Parallel connector

IDE Connector

There is one IDE Connector on the C2SBC-Q. This connection supports two IDE devices. Be sure to close Pin 1 and Pin 2 of JP2 to enable the IDE connector before using it. (Please refer to section 2-7 for more details.) See the table on the right for pin definitions.

IDE Connector Pin Definitions			
Pins#	Definition	Pin #	Definition
1	Reset IDE	2	Ground
3	Host Data 7	4	Host Data 8
5	Host Data 6	6	Host Data 9
7	Host Data 5	8	Host Data 10
9	Host Data 4	10	Host Data 11
11	Host Data 3	12	Host Data 12
13	Host Data 2	14	Host Data 13
15	Host Data 1	16	Host Data 14
17	Host Data 0	18	Host Data 15
19	Ground	20	Key
21	DRQ3	22	Ground
23	I/O Write	24	Ground
25	I/O Read	26	Ground
27	IOCHRDY	28	BALE
29	DACK3	30	Ground
31	IRQ14	32	IOCS16
33	Addr1	34	Ground
35	Addr0	36	Addr2
37	Chip Select 0	38	Chip Select 1
39	Activity	40	Ground

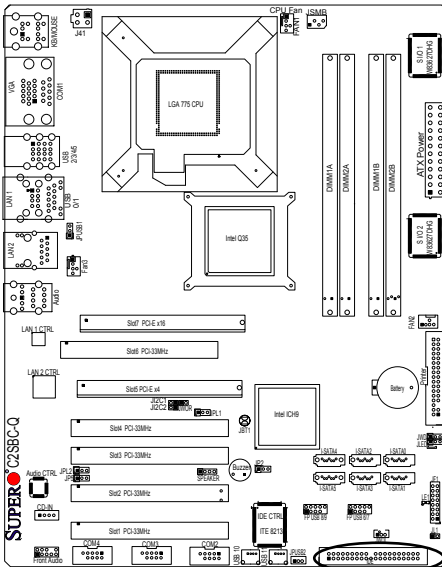

A. IDE

Notes

Chapter 3

Troubleshooting

3-1 Troubleshooting Procedures

Use the following procedures to troubleshoot your system. If you have followed all of the procedures below and still need assistance, refer to the 'Technical Support Procedures' and/or 'Returning Merchandise for Service' section(s) in this chapter. Always disconnect the AC power cord before adding, changing or installing any hardware components.

Before Power On

1. Make sure that there are no short circuits between the motherboard and chassis.
2. Disconnect all ribbon/wire cables from the motherboard, including those for the keyboard and mouse.
3. Remove all add-on cards.
4. Install a CPU and heatsink (making sure it is fully seated) and connect the chassis speaker and the power LED to the motherboard. Check all jumper settings as well.
5. Use the correct type of onboard CMOS battery as specified by the Manufacturer. Do not install the CMOS battery upside down to avoid possible explosion.
6. Make sure the 4-pin 12v power connector at J41 is connected to your power supply.

No Power

1. Make sure that there are no short circuits between the motherboard and chassis.
2. Verify that all jumpers are set to their default positions.

3. Check that the 115V/230V switch on the power supply is properly set.
4. Turn the power switch on and off to test the system.
5. The battery on your motherboard may be old. Check to verify that it still supplies ~3VDC. If it does not, replace it with a new one.

No Video

1. If the power is on but you have no video, remove all the add-on cards and cables.
2. Use the speaker to determine if any beep codes exist. Refer to Appendix A for details on beep codes.



Note: If you are a system integrator, VAR or OEM, a POST diagnostics card is recommended. For I/O port 80h codes, refer to App. B.

Memory Errors

1. Make sure that the DIMM modules are properly and fully installed.
2. You should be using unbuffered DDR2 memory (see the next page). Also, it is recommended that you use the same memory speed for all DIMMs in the system. See Section 2-4 for memory limitations.
3. Check for bad DIMM modules or slots by swapping modules between slots and noting the results.
4. Check the power supply voltage 115V/230V switch.

Losing the System's Setup Configuration

1. Make sure that you are using a high quality power supply. A poor quality power supply may cause the system to lose the CMOS setup information. Refer to Section 1-6 for details on recommended power supplies.
2. The battery on your motherboard may be old. Check to verify that it still supplies ~3VDC. If it does not, replace it with a new one.
3. If the above steps do not fix the Setup Configuration problem, contact your vendor for repairs.

3-2 Technical Support Procedures

Before contacting Technical Support, please take the following steps. Also, note that as a motherboard manufacturer, Supermicro does not sell directly to end-users, so it is best to first check with your distributor or reseller for troubleshooting services. They should know of any possible problem(s) with the specific system configuration that was sold to you.

1. Please go through the 'Troubleshooting Procedures' and 'Frequently Asked Question' (FAQ) sections in this chapter or see the FAQs on our web site (<http://www.supermicro.com/support/faqs/>) before contacting Technical Support.
2. BIOS upgrades can be downloaded from our web site at (<http://www.supermicro.com/support/bios/>).

Note: *Not all BIOS can be flashed; it depends on the modifications to the boot block code.*

3. *If you still cannot resolve the problem, include the following information when contacting Super Micro for technical support:*
 - Motherboard model and PCB revision number
 - BIOS release date/version (this can be seen on the initial display when your system first boots up)
 - System configuration
 - An example of a Technical Support form is on our web site at (<http://www.supermicro.com/support/contact.cfm>).
4. Distributors: For immediate assistance, please have your account number ready when placing a call to our technical support department. We can be reached by e-mail at support@supermicro.com, by phone at:(408) 503-8000, option 2, or by fax at (408)503-8019.

3-3 Frequently Asked Questions

Question: What type of memory does my motherboard support?

Answer: The C2SBC-Q supports **unbuffered**, DDR2 667/800 MHz memory modules. [See Section 2-4 for details on installing memory.](#)

Question: Why does Microsoft Windows XP (SP2) and Windows Vista show less memory than what is physically installed?

Answer: Microsoft implemented a design change in Windows XP with Service Pack 2 (SP2) and Windows Vista. This change is specific to the Physical Address Extension (PAE) mode behavior which improves driver compatibility. For more information, please read the following article at Microsoft's Knowledge Base website at: <http://support.microsoft.com/kb/888137>.

Question: How do I update my BIOS?

Answer: It is recommended that you **do not** upgrade your BIOS if you are not experiencing any problems with your system. Updated BIOS files are located on our web site at <http://www.supermicro.com/support/bios/>. Please check our BIOS warning message and the information on how to update your BIOS on our web site. Select your motherboard model and download the BIOS (.rom) file to your computer. Also, check the current BIOS revision and make sure that it is newer than your BIOS before downloading. You may choose the zip file or the .exe file. If you choose the zipped BIOS file, please unzip the BIOS file onto a bootable device or a USB pen/thumb drive. To flash the BIOS, run the batch file named "flash.bat" with the new BIOS .rom file from your bootable device or USB pen/thumb drive. Use the following format:

```
F:\> flash xxxxxxxx.rom <Enter>
```

Note: Be sure to insert a space immediately after "flash" and use only the file named "flash.bat" to update the BIOS.

When completed, your system will automatically reboot. If you choose the .exe file, please run the .exe file under Windows to create the BIOS flash floppy disk. Insert the floppy disk into the system you wish to flash the BIOS. Then, boot the system to the floppy disk. The BIOS utility will automatically flash the BIOS without any prompts. Please note that this process may take a few minutes to complete. Do not be concerned if the screen is paused for a few minutes.

Warning: Do not shut down or reset the system while updating the BIOS to prevent possible system boot failure!

When the BIOS flashing screen is completed, the system will reboot and will show "Press F1 or F2". At this point, you will need to load the BIOS defaults. Press <F1> to go to the BIOS setup screen, and press <F9> to load the default settings. Next, press <F10> to save and exit. The system will then reboot.

Note: The SPI BIOS chip installed on this motherboard is not removable. To repair or replace a damaged BIOS chip, please send your motherboard to RMA at Supermicro for service.

Question: What's on the CD that came with my motherboard?

Answer: The supplied compact disc has quite a few drivers and programs that will greatly enhance your system. We recommend that you review the CD and install the applications you need. Applications on the CD include chipset drivers for Windows and security and audio drivers.

Question: How do I utilize the onboard HD sound?

Answer: The onboard HD sound available on the C2SBC-Q can be enabled with the audio driver software that was included in your motherboard package. When activated, sound will be routed through the jacks next to the LAN Port according to the audio connection descriptions listed on Page 2-8. You must also set the HD Audio setting to "Auto" in the Advanced Chipset section of the BIOS setup.

Question: I installed my microphone correctly but I can't record any sound. What should I do?

Answer: Go to <Start>, <Programs>, <Accessories>, <Entertainment> and then <Volume Control>. Under the Properties tab, scroll down the list of devices in the menu and check the box beside "Microphone".

Question: After I have installed 4 pieces of 1GB Memory, why does the BIOS only detect about 3.145 GB of memory during POST?

Answer: Because the chipset does not support memory remapping, and PCI-E memory requires a great deal of memory, so there is a memory hole located around the 4GB memory address.

Question: How do I connect the ATA100/66 cable to my IDE device(s)?

Answer: The 80-wire/40-pin high-density ATA100/66 IDE cable that came with your system has two connectors to support two drives. This special cable must be used to take advantage of the speed the ATA100/66 technology offers. **Connect the blue connector to the onboard IDE header and the other connector(s) to your hard drive(s).** Consult the documentation that came with your disk drive for details on actual jumper locations and settings.

Question: Why doesn't my USB devices work after installing the Intel Chipset Software Installation Utility in Windows XP or Windows Server 2003?

Answer: This is a timing conflict between Windows File Protection and the Setup program. This is described in greater detail, and a hotfix is available at Microsoft's website at <http://support.microsoft.com/kb/921411/en-us>

3-4 Returning Merchandise for Service

A receipt or copy of your invoice marked with the date of purchase is required before any warranty service will be rendered. You can obtain service by calling your vendor for a Returned Merchandise Authorization (RMA) number. When returning to the manufacturer, the RMA number should be prominently displayed on the outside of the shipping carton, and mailed prepaid or hand-carried. Shipping and handling charges will be applied for all orders that must be mailed when service is complete.

For faster service, RMA authorizations may be requested online (<http://www.supermicro.com/support/rma/>).

This warranty only covers normal consumer use and does not cover damages incurred in shipping or from failure due to the alteration, misuse, abuse or improper maintenance of products.

During the warranty period, contact your distributor first for any product problems.

Chapter 4

BIOS

4-1 Introduction

This chapter describes the Phoenix BIOS™ Setup utility for the C2SBM-Q. The Phoenix ROM BIOS is stored in a flash chip and can be easily upgraded using a floppy disk-based program.



Note: Due to periodic changes to the BIOS, some settings may have been added or deleted and might not yet be recorded in this manual. Please refer to the Manual Download area of the Super Micro web site <<http://www.supermicro.com>> for any changes to the BIOS not reflected in this manual.

System BIOS

The BIOS is the Basic Input Output System used in all IBM® PC, XT™, AT®, and PS/2® compatible computers. The Phoenix BIOS stores the system parameters, types of disk drives, video displays, etc. in the CMOS. The CMOS memory requires very little electrical power. When the computer is turned off, a backup battery provides power to the CMOS logic, enabling it to retain system parameters. Each time the computer is powered on, the computer is configured with the values stored in the CMOS logic by the system BIOS, which gains control at boot-up.

How To Change the Configuration Data

The CMOS information that determines the system parameters may be changed by entering the BIOS Setup utility. This Setup utility can be accessed by pressing the <Delete> key during the POST (Power On Self Test) routine. From the main menu, you can access the other setup screens, such as the Security and Power menus. Beginning with Section 4-3, detailed descriptions are given for each parameter setting in the Setup utility.



Warning: Do not shut down or reset the system while updating the BIOS to prevent possible boot failure.

4-2 Running Setup

Default settings are in bold text unless otherwise noted.

The BIOS setup options described in this section are selected by choosing the appropriate text from the main BIOS Setup screen. All displayed text is described in this section, although the screen display is often all you need to understand how to set the options (see the next page).

When you first power on the computer, the Phoenix BIOS™ is immediately activated.

While the BIOS is in control, the Setup program can be activated in one of two ways:

1. By pressing <Delete> immediately after turning the system on, or
2. When the message shown below appears briefly at the bottom of the screen during the POST (Power On Self-Test), press the <Delete> key to activate the main Setup menu.

Press the <Delete> key to enter Setup

4-3 Main BIOS Setup

All main Setup options are described in this section. The main BIOS Setup screen is displayed below.

Use the Up/Down arrow keys to move among the different settings in each menu. Use the Left/Right arrow keys to change the options for each setting.

Press the <Esc> key to exit the CMOS Setup Menu. The next section describes in detail how to navigate through the menus.

Items that use submenus are indicated with the ► icon. With the item highlighted, press the <Enter> key to access the submenu.

Main BIOS Setup Menu

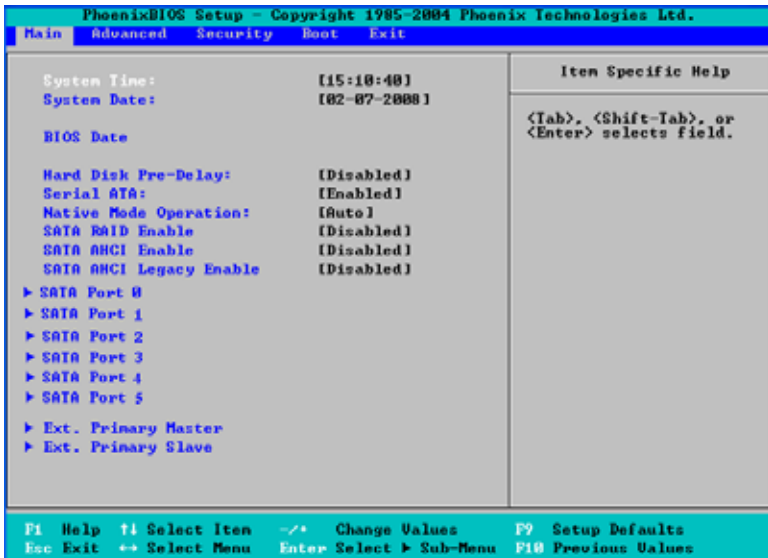

Main Setup Features

System Time

To set the system date and time, key in the correct information in the appropriate fields. Then press the <Enter> key to save the data.

System Date

Using the arrow keys, highlight the month, day and year fields, and enter the correct data. Press the <Enter> key to save the data.

BIOS Date

The item displays the date that the BIOS was built.

Hard Disk Pre-Delay

When enabled, this feature will add a delay to provide time needed for HDD self-initialization before the HDD is accessed by the BIOS for the first time. Some HDDs will hang if accessed by the BIOS without proper initialization. The options are Enabled and **Disabled**.

Serial ATA

This setting allows the user to enable or disable the function of the Serial ATA. The options are Disabled and **Enabled**.

Native Mode Operation

Select Serial ATA for SATA or select Auto (Native Mode) for ATA. The options are: Serial ATA and **Auto**.

Serial ATA (SATA) RAID Enable

Select Enable to enable Serial ATA RAID Functions. (For the Windows OS environment, use the RAID driver if this feature is set to Enabled. When this item is set to Enabled, the item: ICH RAID Code Base will be available for you to select either Intel or Adaptec HOST RAID firmware to be activated. Is this item is set to **Disabled**, the item SATA AHCI Enable will be available.) The options are Enabled and **Disabled**.

SATA AHCI Enable

Select Enable to enable the function of Serial ATA Advanced Host Interface. (Take caution when using this function. This feature is for advanced programmers only. The Enhanced AHCI mode is available when the Windows XP-SP1 OS and the IAA driver is used.) The options are Enabled and **Disabled**.

► SATA Port0/SATA Port1/SATA Port2/SATA Port3/SATA Port4/SATA Port5/Ext. Primary Master/Slave

These settings allow the user to set the parameters of slots indicated above. Hit <Enter> to activate the following sub-menu screen for detailed options of these items. Set the correct configurations accordingly. The items included in the sub-menu are the following:

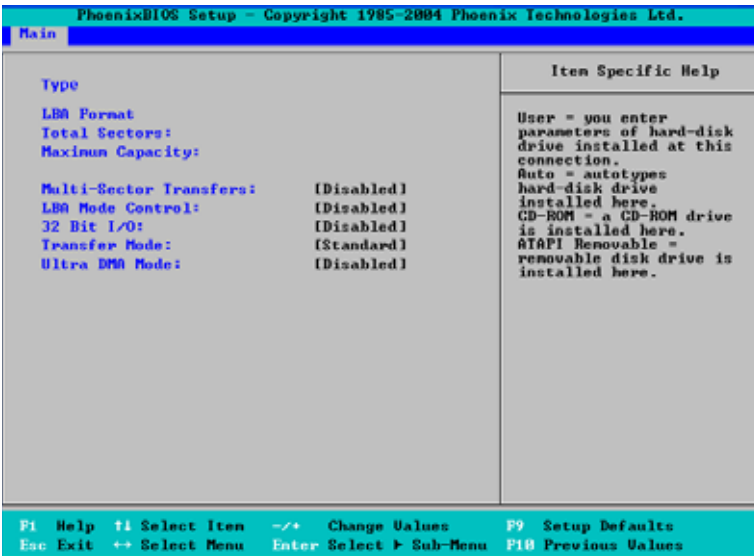

Type

This option allows you to select the type of IDE hard drive. Select **Auto** to allow the BIOS to automatically determine the hard drive's capacity, number of heads, etc.). Select **User** to allow the user to enter the parameters for the HDD installed at this connection. Enter a number between 1 to 39 to select a predetermined HDD type. Select **CDROM** if a CDROM drive is installed. Select **ATAPI** if a removable disk drive is installed.

The following items will be displayed by the BIOS:

LBA Mode Control

This item determines whether the Phoenix BIOS will access the IDE Channel 0 Master Device via the LBA mode. The options are **Enabled** and **Disabled**.

32 Bit I/O

This option allows the user to enable or disable the function of a 32-bit data transfer. The options are **Enabled** and **Disabled**.

Transfer Mode

This option allows the user to set the transfer mode. The options are **Standard**, **Fast PIO1**, **Fast PIO2**, **Fast PIO3**, **Fast PIO4**, **FPIO3/DMA1** and **FPIO4/DMA2**.

Ultra DMA Mode

This option allows the user to select Ultra DMA Mode. The options are **Disabled**, **Mode 0**, **Mode 1**, **Mode 2**, **Mode 3**, **Mode 4**, and **Mode 5**.

4-4 Advanced Setup

Choose Advanced from the Phoenix BIOS Setup Utility main menu with the arrow keys. You should see the following display. The items with a triangle beside them have sub-menus that can be accessed by highlighting the item and pressing <Enter>.

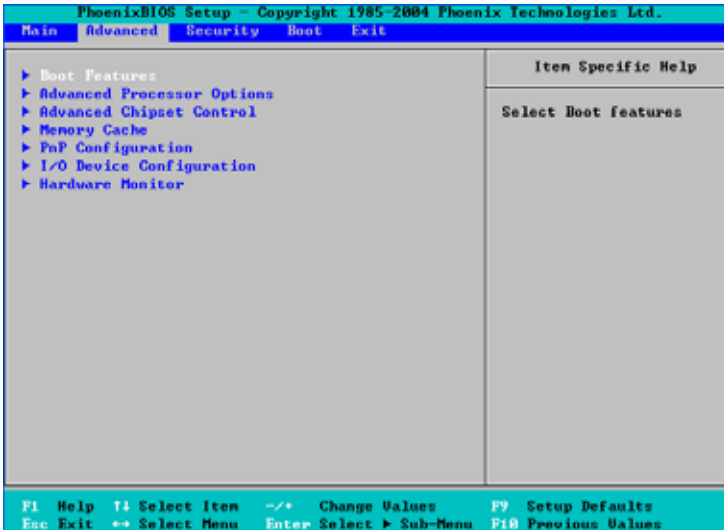

▶ Boot Features

Quiet Mode

This setting allows you to **Enable** or Disable the graphic logo screen display during bootup.

QuickBoot Mode

If enabled, this feature will speed up the POST (Power On Self Test) routine by skipping certain tests after the computer is turned on. The settings are **Enabled** and Disabled. If Disabled, the POST routine will run at normal speed.

ACPI Mode

Use the setting to determine whether you want to use the ACPI (Advanced Configuration and Power Interface) power management on your system. The options are **Yes** and No.

ACPI Sleep Mode

Use the setting to determine if you want to use the ACPI (Advanced Configuration and Power Interface) power management on your system when the system enters into the sleep mode. The options are **S1**, S3 and S1S3.

High Precision Event Time

Select **Yes** to activate the High Precision Event Timer (HPET), which is capable of producing periodic interrupts at a much higher frequency than a Real-time Clock (RTC) in synchronizing multimedia streams, providing smooth playback and reducing the dependency on other timestamp calculation devices in a CPU. The HPET is used to replace the 8254 Programmable Interval Timer. The default setting is **No**.

Power Button Behavior

If set to **Instant-Off**, the system will power on or power off immediately as soon as the user hits the power button. The options are **Instant-Off** and 4-second Override.

Resume On Modem Ring

Select **On** to "wake your system up" when an incoming call is received by your modem. The options are **On** and **Off**.

Resume On PME#

Select **On** to "wake your system up" from the PME#. The options are **On** and **Off**.

PS2 KB/MS Wake Up

Select **Enable** to "wake your system up" from the S1 and S3 state via a PS2 keyboard or mouse. The options are **Enabled** and **Disabled**.

USB Wake Up

Select **Enable** to "wake your system up" from the S1 and S3 state via a USB device. The options are **Enabled** and **Disabled**.

Power Loss Control

This setting allows you to decide how the system will react when power returns after an unexpected loss of power. The default setting is **Last State**.

Legacy USB Support

Select **Enabled** to enable Legacy USB Support. The default setting is **Enabled**.

Watch Dog

Set to **Enabled** to automatically reset the system if it is not active for more than a predefined time period. The options are **Enabled** and **Disabled**.

Summary Screen

Select **Enable** to show the summary screen which displays the system configuration during bootup.

►Advanced Processor Options

Access the submenu to make changes to the following settings.

CPU Speed

This is a display that indicates the speed of the installed processor.

Frequency Ratio (Available when supported by the CPU.)

The feature allows the user to set the internal frequency multiplier for the CPU. The options are: **Default**, x6, x7, x8, x9, x10 and x11.

Frequency High Ratio (Available when supported by the CPU.)

The feature allows the user to set the high ratio internal frequency multiplier for the Intel SpeedStep CPUs. The default setting is X12.



Note: If a wrong ratio that is not supported by the CPU is selected, the system may hang. If this happens, clear the CMOS to recover the system.

Hyperthreading (Available when supported by the CPU.)

Set to Enabled to use the Hyperthreading Technology, which will result in increased CPU performance. The options are Disabled and **Enabled**.

Core-Multi-Processing (Available when supported by the CPU.)

Set to Enabled to use a processor's Second Core and beyond (Please refer to Intel's web site for more information). The options are Disabled and **Enabled**.

Intel Enhanced Debug (Available when supported by the CPU.)

Set to Enabled to use a processor's Second Core and beyond (Please refer to Intel's web site for more information). The options are Disabled and **Enabled**.

Machine Checking (Available when supported by the CPU.)

Set to Enabled to activate the function of Machine Checking and allow the CPU to detect and report hardware (machine) errors via a set of model-specific registers (MSRs). The options are Disabled and **Enabled**.

L3 Cache (Available when supported by the CPU.)

Set to Enabled to enable the function of L3 Cache to optimize the system and CPU performance. The options are Disabled and **Enabled**.

Thermal Management 2 (Available when supported by the CPU.)

Set to **Enabled** to use Thermal Management 2 (TM2,) which will lower the CPU voltage and frequency when the CPU temperature reaches a predefined overheat

threshold. Set to Disabled to use Thermal Manager 1 (TM1), allowing CPU clocking to be regulated via the CPU Internal Clock modulation when the CPU temperature reaches the overheat threshold. The options are Disabled and **Enabled**.

Adjacent Cache Line Prefetch (Available when supported by the CPU.)

The CPU fetches the cache line for 64 bytes if this option is set to Disabled. The CPU fetches both cache lines for 128 bytes as comprised if set to Enabled. The options are Disabled and **Enabled**.

Set Maximum Ext. CPUID=3

When set to Enabled, the Maximum Extended CPUID will be set to 3. The options are **Disabled** and Enabled.

C1 Enhanced Mode (Available when supported by the CPU.)

Set to Enabled to enable the Enhanced Halt State to lower CPU voltage/frequency to prevent overheat. The options are Enabled and **Disabled**.



Note: Please refer to Intel's web site for detailed information.

Intel® Virtualization Technology (Available when supported by the CPU.)

Select Enabled to use the feature of Virtualization Technology to allow one platform to run multiple operating systems and applications in independent partitions, creating multiple virtual systems in one computer. The options are Enabled and **Disabled**.



Note: If there is any change to this setting, you will need to power off and restart the system for the change to take effect. Please refer to Intel's web site for detailed information.

No Execute Mode Memory Protection (Available when supported by the CPU and the OS.)

Set to Enabled to enable Execute Disable Bit and allow the processor to classify areas in memory where an application code can execute and where it cannot, and thus preventing a worm or a virus from inserting and creating a flood of codes to overwhelm the processor or damage the system during an attack. The options are Disabled and Enabled.



Note: For more information regarding the hardware/software support for this function, please refer to Intel's and Microsoft's web sites.

Enhanced Intel Speed Step Support (Available when supported by the CPU.)

Select Enabled to use the Enhanced Intel SpeedStep Technology and allows the system to automatically adjust the processor voltage and core frequency in an effort

to reduce power consumption and heat dissipation. The options are Enabled (-C States, GV1/GV3 are enabled), **GV1/GV3 Only** (C States: Disabled), C-States Only (-G1/G3: Disabled), and Disabled (-C States, GV1/GV3 are disabled).

► Advanced Chipset Control

Access the submenu to make changes to the following settings.



Warning: Be cautious when changing the Advanced settings. An incorrect setting, a very high DRAM frequency or an incorrect DRAM timing may result in system instability. When this occurs, revert to the default setting.

► Integrated Device Control Sub-menu

Memory Reclaiming

Select Enable to enable the functionality of Memory Remapping above 4GB. The settings are **Enabled** and Disabled.

Enable VT-d

Select Enable to enable the functionality of the Intel Virtualization Technology for Direct I/O support, which offers fully-protected I/O resource-sharing across the Intel platforms, providing the user with greater reliability, security and availability in networking and data-sharing. The settings are Enabled and **Disabled**.

Default Primary Video Adapter

This feature allows the user to select the video device used by the BIOS during POST. If set to **Auto**, PEG, PCI, and IGD (Internal Graphics Device) devices will be selected. If set to IGD (Internal Graphics Device), IGD and PCI devices will be selected. If set to PEG, PEG and PCI devices will be selected. If set to PCI, PCI, PEG and IGD devices will be selected.

IGD-Device 2

This feature allows the user to enable or disable Internal Graphics Device#2 by entering a specified value. Select **Auto** to allow this device to be automatically enabled when detected by the BIOS.

IGD-Device 2, Function 1

This feature allows the user to **auto** or disable Function#1 of Internal Graphics Device#2 by entering a specified value. Select **Auto** to allow this device to be automatically enabled when detected by the BIOS.

DVMT 4.0 Mode

This feature allows the user to configure the DVMT 4.0 Graphics Memory to be used by the Internal Graphics Device. The options are Fixed, **DVMT** and Auto.

Pre-allocated Memory Size

This feature allows the user to set the total amount of pre-allocated graphics memory to be used by the Internal Graphics Device. The options are 1 MB and **8 MB**.

IGD Memory Size

This feature allows the user to set the total amount of graphics memory to be used by the Internal Graphics Device. The settings are 128 MB, **256 MB** (default in Fixed mode) and **MAXDVMT** (default in DVMT mode).

Fixed Graphics Memory

This feature will allow the BIOS to automatically display the Fixed Graphics settings.

DVMT Graphics Memory

This feature allows the user to display the DVMT Graphics settings.

Azalia Audio

Select **Auto** to enable Azalia Audio automatically when detected by the BIOS. The settings are **Auto** and Disabled.

Route Port 80h Cycles to

This feature allows the user to decide which bus to send debug information to. The options are Disabled, **PCI** and LPC.

► Memory Cache

Cache System BIOS Area

Use this setting to designate a reserve area in the system memory to be used as a System BIOS buffer and allow BIOS to write (cache) data into this reserved memory area. Select **Write Protect** to enable this function, and this area will be reserved for BIOS ROM access only. Select **Uncached** to disable this function and make this area available for other devices.

Cache Video BIOS Area

Use this setting to designate a reserve area in the system memory to be used as a Video BIOS buffer and allow the BIOS to write (cache) data into this reserved memory area. Select **Write Protect** to enable the function and this area will be reserved for Video BIOS ROM access only. Select **Uncached** to disable this function and make this area available for other devices.

Cache Base 0-512K

If enabled, this feature allows the data stored in the base memory area of block 0-512K to be cached into a buffer, a storage area in the Static DROM (SDROM) or to be written into L1, L2 cache inside the CPU to speed up CPU operations. Select **Uncached** to disable this function. Select **Write Through** to allow data to be cached into the buffer and written into the system memory at the same time. Select **Write Protect** to prevent data from being written into the base memory area of Block 0-512K. Select **Write Back** to allow the CPU to write data back directly from the buffer without writing data to the System Memory for fast CPU data processing and operation. The options are **Uncached**, **Write Through**, **Write Protect**, and **Write Back**.

Cache Base 512K-640K

If enabled, this feature allows the data stored in the memory area of 512K-640K to be cached into a buffer, a storage area in the Static DROM (SDROM) or written into L1, L2, L3 cache inside the CPU to speed up CPU operations. Select **Uncached** to disable this function. Select **Write Through** to allow data to be cached into the buffer and written into the system memory at the same time. Select **Write Protect** to prevent data from being written into the base memory area of Block 512K-640K. Select **Write Back** to allow the CPU to write data back directly from the buffer without writing data to the System Memory for fast CPU data processing and operation. The options are **Uncached**, **Write Through**, **Write Protect**, and **Write Back**.

Cache Extended Memory

If enabled, this feature allows the data stored in the extended memory area to be cached (written) into a buffer, a storage area in the Static DROM (SDROM) or written

into L1, L2, L3 cache inside the CPU to speed up CPU operations. Select Uncached to disable this function. Select Write Through to allow data to be cached into the buffer and written into the system memory at the same time. Select Write Protect to prevent data from being written into the extended memory area above 1 MB. Select Write Back to allow the CPU to write data back directly from the buffer without writing data to the System Memory for fast CPU data processing and operation. The options are Uncached, Write Through, Write Protect, and **Write Back**.

► PNP Configuration

Access the submenu to make changes to the following settings for PNP (Play & Plug) devices.

► PCI 32 Device Slot # 1, 2, 3, 4, and 6

Access the submenu for each of the settings above to make changes to the following:

Option ROM Scan

When enabled, this setting will initialize the device expansion ROM. The options are **Enabled** and Disabled.

Enable Master

This setting allows you to enable the selected device as the PCI bus master. The options are Enabled and **Disabled**.

Latency Timer

This setting allows you to set the clock rate for Bus Master. A high-priority, high-throughput device may benefit from a greater clock rate. The options are **Default**, 0020h, 0040h, 0060h, 0080h, 00A0h, 00C0h, and 00E0h. For Unix, Novelle and other Operating Systems, please select the option: other. If a drive fails after the installation of a new software, you might want to change this setting and try again. A different OS requires a different Bus Master clock rate.

► PCI-E x4 Slot 5

Access the submenu for each of the settings above to make changes to the following:

Option ROM Scan

When enabled, this setting will initialize the device expansion ROM. The options are **Enabled** and Disabled.

Enable Master

This setting allows you to enable the selected device as the PCI bus master. The options are Enabled and **Disabled**.

Latency Timer

This setting allows you to set the clock rate for Bus Master. A high-priority, high-throughput device may benefit from a greater clock rate. The options are **Default**, 0020h, 0040h, 0060h, 0080h, 00A0h, 00C0h, and 00E0h. For Unix, Novelle and other Operating Systems, please select the option: other. If a drive fails after the installation of a new software, you might want to change this setting and try again. A different OS requires a different Bus Master clock rate.

► PEG (PCI-Express Graphics) Port Sub-menu (Slot 7)

Access the submenu for each of the settings above to make changes to the following:

PCI-Express Graphics (PEG) Port (This submenu is for debugging only.)

Select **Auto** to automatically enable the PCI-Express Graphics Port if a PCI add-on card is detected. Select Disabled to always disable the PEG Port. Select Enabled to always enable the PEG Port. (Debugging is enabled if a Debug card is detected.) The default setting is **Auto**.

When the PCI-Exp. Graphics Port is enabled, the following items will be displayed:

PEG Port Enabled=

PEG Port Number=

PEG Port Width=

PEG Port Slot Number=

PEG Port Power Limit=

PEG Port Slot Detect=

► Onboard LAN 1, LAN 2

Option ROM Scan

When enabled, this setting will initialize the device expansion ROM. The options are Enabled and **Disabled**.

Enable Master

This setting allows you to enable the selected device as the PCI bus master. The options are Enabled and **Disabled**.

Latency Timer

This setting allows you to set the clock rate for Bus Master. A high-priority, high-throughput device may benefit from a greater clock rate. The options are **Default**, 0020h, 0040h, 0060h, 0080h, 00A0h, 00C0h, and 00E0h. For Unix, Novelle and other Operating Systems, please select the option: other. If a drive fails after the installation of a new software, you may want to change this setting and try again. A different OS requires a different Bus Master clock rate.

► I/O Device Configuration

Access the submenu to make changes to the following settings.

KBC Clock Input

This setting allows you to select the clock frequency for the Keyboard Controller. The options are 6MHz, 8MHz, **12MHz**, and 16MHz.

COM 1

This setting allows you to decide how the system controls COM 1. The options are **Enabled** (user defined), Disabled, and Auto (BIOS- or OS-controlled).

Base I/O Address

This setting allows you to select the base I/O address for Serial Port A. The options are **3F8**, 2F8, 3E8, and 2E8.

Interrupt

This setting allows you to select the IRQ (interrupt request) for Serial Port A. The options are IRQ3 and **IRQ4**.

COM 2

This setting allows you to decide how the system controls COM 2. The options are **Enabled** (user defined), Disabled, Auto (BIOS controlled) and OS Controlled.

Mode

This setting allows you to set the type of device that will be connected to Serial Port B. The options are **Normal** and IR (for an infrared device).

Base I/O Address

This setting allows you to select the base I/O address for Serial Port B. The options are 3F8, **2F8**, 3E8 and 2E8.

Interrupt

This setting allows you to select the IRQ (interrupt request) for Serial Port B. The options are **IRQ3** and IRQ4.

COM 3

This setting allows you to decide how the system controls COM 3. The options are **Enabled** (user defined), Disabled, Auto (BIOS controlled) and OS Controlled.

Base I/O Address

This setting allows you to select the base I/O address for Serial Port C. The options are **220** and 238.

Interrupt

This setting allows you to select the IRQ (interrupt request) for Serial Port C. The options are **IRQ5** and IRQ10.

COM 4

This setting allows you to decide how the system controls COM 4. The options are **Enabled** (user defined), Disabled, Auto (BIOS controlled) and OS Controlled.

Base I/O Address

This setting allows you to select the base I/O address for Serial Port D. The options are 220 and **238**.

Interrupt

This setting allows you to select the IRQ (interrupt request) for Serial Port D. The options are IRQ5 and **IRQ10**.

Parallel Port

This setting allows you to decide how the system controls the parallel port. The options are **Enabled** (user defined), Disabled, and Auto (BIOS or OS-controlled).

Base I/O Address

This setting allows you to select the base I/O address for the parallel port. The options are **378**, 278 and 3BC.

Interrupt

This setting allows you to select the IRQ (interrupt request) for the parallel port. The options are IRQ5 and **IRQ7**.

Mode

This feature allows you to specify the parallel port mode. The options are Output Only, Bi-Directional, EPP, and **ECP**.

DMA Channel

This setting allows you to specify the DMA channel for the parallel port. The options are DMA1 and **DMA3**.

► Hardware Monitoring**CPU Overheat Alarm**

This option allows the user to select the CPU Overheat Alarm setting which determines when the CPU OH alarm will be activated to provide warning of possible CPU overheat.



Warning: Any temperature that exceeds the CPU threshold temperature predefined by the CPU manufacturer may result in CPU overheat or system instability. When the CPU temperature reaches this predefined threshold, the CPU and system cooling fans will run at full speed.

The options are:

The **Default Alarm Setting:** Select this setting if you want the CPU overheat alarm (including the LED and the buzzer) to be triggered when the CPU temperature reaches about 5°C above the threshold temperature as predefined by the CPU manufacturer to give the CPU and system fans additional time needed for CPU and system cooling.

The Early Alarm Setting: Select this setting if you want the CPU overheat alarm (including the LED and the buzzer) to be triggered as soon as the CPU temperature reaches the CPU overheat threshold as predefined by the CPU manufacturer.



Note: In the Windows OS environment, the Supero Doctor III settings take precedence over the BIOS settings. When first installed, Supero Doctor III adopts the temperature threshold settings previously set in the BIOS. Any subsequent changes to these thresholds must be made within Supero Doctor, since the SD III settings override the BIOS settings. For the Windows OS to adopt the BIOS temperature threshold settings, please change the SDIII settings to be the same as those set in the BIOS.

CPU Temperature

The CPU Temperature feature will display the CPU temperature status as detected by the BIOS:

Low – This level is considered as the ‘normal’ operating state. The CPU temperature is well below the CPU ‘Temperature Tolerance’. The motherboard fans and CPU will run normally as configured in the BIOS (Fan Speed Control).

User intervention: No action required.

Medium – The processor is running warmer. This is a ‘precautionary’ level and generally means that there may be factors contributing to this condition, but the CPU is still within its normal operating state and below the CPU ‘Temperature Tolerance’. The motherboard fans and CPU will run normally as configured in the BIOS. The fans may adjust to a faster speed depending on the Fan Speed Control settings.

User intervention: No action is required. However, consider checking the CPU fans and the chassis ventilation for blockage.

High – The processor is running hot. This is a ‘caution’ level since the CPU’s ‘Temperature Tolerance’ has been reached (or has been exceeded) and may activate an overheat alarm:

The Default Alarm – the Overheat LED and system buzzer will activate if the High condition continues for some time after it is reached. The CPU fan will run at full speed to bring the CPU temperature down. If the CPU temperature still increases even with the CPU fan running at full speed, the system buzzer will activate and the Overheat LED will turn on.

The Early Alarm – the Overheat LED and system buzzer will be activated exactly when the High level is reached. The CPU fan will run at full speed to bring the CPU temperature down.

Note: In both the alarms above, please take immediate action as shown below. See CPU Overheat Alarm to modify the above alarm settings.

User intervention: If the system buzzer and Overheat LED has activated, take action immediately by checking the system fans, chassis ventilation and room temperature to correct any problems. Note: the system may shut down if it continues for a long period to prevent damage to the CPU.



Notes: The CPU thermal technology that reports absolute temperatures (Celsius/Fahrenheit) has been upgraded to a more advanced feature by Intel in its newer processors. The basic concept is each CPU is embedded by unique temperature information that the motherboard can read. This ‘Temperature Threshold’ or ‘Temperature Tolerance’ has been assigned at the factory and is the baseline on which the motherboard takes action during different CPU temperature conditions (i.e., by increasing CPU Fan speed, triggering the Overheat Alarm, etc). Since CPUs can have different ‘Temperature Tolerances’, the installed CPU can now send information to the motherboard what its ‘Temperature Tolerance’ is, and not the other way around. This results in better CPU thermal management.

Supermicro has leveraged this feature by assigning a temperature status to certain thermal conditions in the processor (Low, Medium and High). This makes it easier for the user to understand the CPU's temperature status, rather than by just simply seeing a temperature reading (i.e., 25°C).

The information provided above is for your reference only. For more information on thermal management, please refer to Intel's Web site at www.Intel.com.

System Temperature

This feature displays the system's absolute temperature as detected.

Voltage Monitoring

The following items will be monitored and displayed:

Vcore A, 12V/-12V, V_DIMM, 5V, 3.3V/3.3Vsb, Vbat

4-5 Security Settings

Choose Security from the Phoenix BIOS Setup Utility main menu with the arrow keys. You should see the following display. Security setting options are displayed by highlighting the setting using the arrow keys and pressing <Enter>. All Security BIOS settings are described in this section.

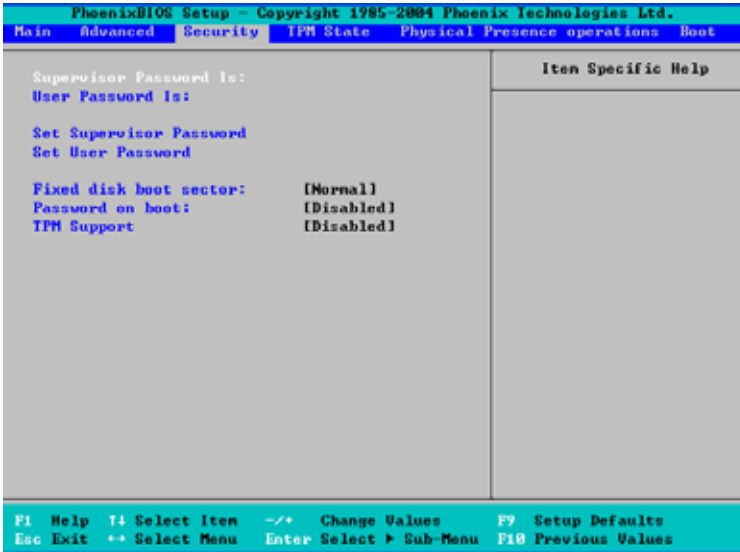

Supervisor Password Is:

This item indicates if a supervisor password has been entered for the system. Clear means such a password has not been used and Set means a supervisor password has been entered for the system.

User Password Is:

This item indicates if a user password has been entered for the system. Clear means such a password has not been used and Set means a user password has been entered for the system.

Set Supervisor Password

When the item Set Supervisor Password is highlighted, hit the <Enter> key. When prompted, type the Supervisor's password in the dialogue box to set or to change supervisor's password, which allows access to the BIOS.

Set User Password

When the item Set User Password is highlighted, hit the <Enter> key. When prompted, type the user's password in the dialogue box to set or to change the user's password, which allows access to the system at boot-up.

Fixed Disk Boot Sector

Select **Normal** to enable the function of Write-Protect to protect the boot sector on the hard drives against viruses.

Password on Boot

When this feature is set to Enabled, a password is required for a user to enter the system at bootup. The options are Enabled (password required) and **Disabled** (password not required).

Trusted Platform Support

Select Enabled to enable support for trusted platforms and allow the BIOS to automatically download the drivers needed to provide support for the platforms specified. The options are Enabled and **Disabled**.

If set to Enabled, the Trusted Platform Module (TPM) State submenu will display. (See the next section.)



NOTE: The TPM feature has been updated and is now exclusively enabled or disabled using this BIOS feature. As a result, jumper JP3 on this particular motherboard is no longer used to enable/disable the TPM feature. For security reasons, leave jumper JP3's setting to Disabled (default setting) regardless of the BIOS' Trusted Platform Support setting.

4-6 Trusted Platform Module (TPM) State



(**Note:** This submenu is available when the TPM Support Option is enabled in the Security Setting on the previous page. For detailed information on TPM Support settings, please refer to the note on the bottom of the same page.)

Choose the TPM State menu from the Phoenix BIOS Setup Utility with the arrow keys. You should see the following display.

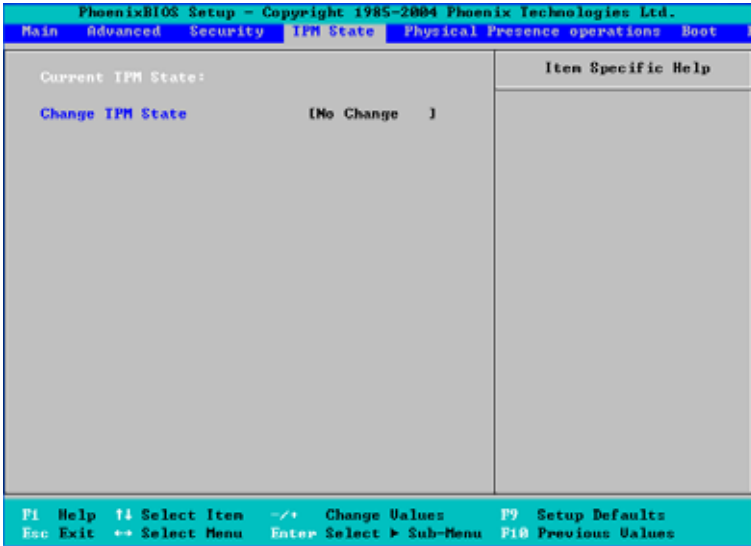

Current TPM State

This item shows the current TPM State only.

Change TPM State

Select Enabled & Activate to enable TPM support for the system. Select De-activate & Disabled to disable the function of TPM support. If No Change is selected, no changes will be done to the current TPM State. Select Clear to clear or erase all information related to TPM support.

If set to Clear, the sub-menu: Physical Presence Operations will appear. Select Reject to cancel the selection. Select Execute to proceed with selection. All information related to TPM Support will be erased.

4-7 Boot Settings

Choose Boot from the Phoenix BIOS Setup Utility main menu with the arrow keys. You should see the following display. See details on how to change the order and specs of boot devices in the Item Specific Help window. All Boot BIOS settings are described in this section.

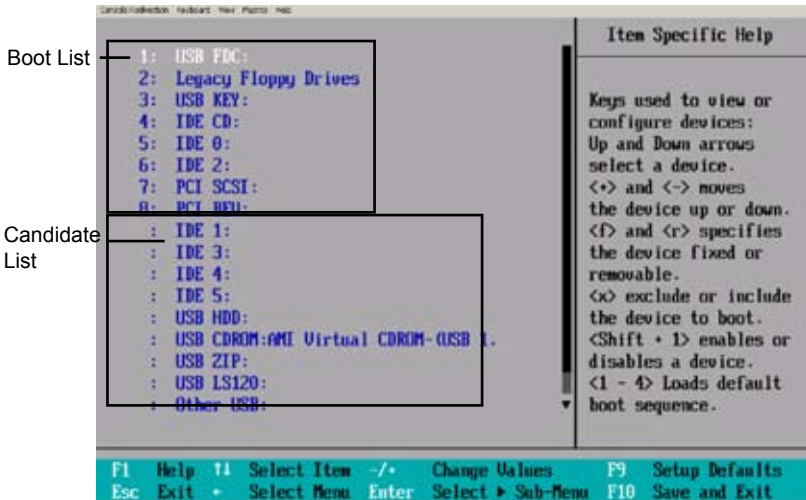

Boot Priority Order/Excluded from Boot Orders

The devices included in the boot list section (above) are bootable devices listed in the sequence of boot order as specified. The boot functions for the devices included in the candidate list (above) are currently disabled. Use a <+> key or a <-> key to move the device up or down. Use the <f> key or the <r> key to specify the type of an USB device, either fixed or removable. You can select one item from the boot list and hit the <x> key to remove it from the list of bootable devices (to make its resource available for other bootable devices). Subsequently, you can select an item from the candidate list and hit the <x> key to remove it from the candidate list and put it in the boot list. This item will then become a bootable device. See details on how to change the priority of boot order of devices in the Item Specific Help window.

4-8 Exit

Choose Exit from the Phoenix BIOS Setup Utility main menu with the arrow keys. You should see the following display. All Exit BIOS settings are described in this section.

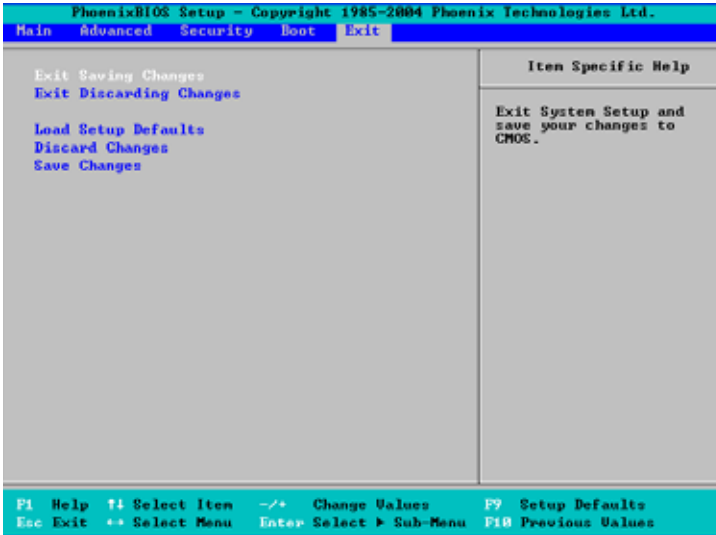

Exit Discarding Changes

Highlight this item and hit <Enter> to exit the BIOS Setup utility without saving any changes you may have made.

Load Setup Defaults

Highlight this item and hit <Enter> to load the default settings for all items in the BIOS Setup. These are the safest settings to use.

Discard Changes

Highlight this item and hit <Enter> to discard (cancel) any changes you made. You will remain in the Setup utility.

Save Changes

Highlight this item and hit <Enter> to save any changes you made. You will remain in the Setup utility.

Exit Saving Changes

Highlight this item and hit <Enter> to save any changes you made and to exit the Setup Utility.

Appendix A

POST Error Beep Codes

This section lists POST (Power On Self Test) error beep codes for the Phoenix BIOS. POST error beep codes are divided into two categories: recoverable and terminal. This section lists Beep Codes for recoverable POST errors.

Recoverable POST Error Beep Codes

When a recoverable type of error occurs during POST, BIOS will display a POST code that describes the problem. BIOS may also issue one of the following beep codes:

- 1 long and two short beeps - video configuration error
- 1 repetitive long beep - no memory detected
- 1 continuous beep w/Front Panel Overheat LED on - System Overheat

Notes

Appendix B

Installing the Windows OS

After all hardware components have been installed, you must first configure Intel South Bridge RAID Settings before installing the Windows OS and other software drivers. To configure RAID settings, please refer to RAID Configuration User Guides posted on our web site at www.supermicro.com/support/manuals. (**Note:** The Intel ICH9R HostRAID Controller does not support the Windows 2000 OS.)

B-1 Installing the Windows XP/2003 OS for Systems with RAID Functions

1. Insert Microsoft's Windows XP/2003 Setup CD in the CD Drive, and the system will start booting up from CD.
2. Press the <F6> key when the message-" Press F6 if you need to install a third party SCSI or RAID driver" displays.
3. When the Windows XP/2003 Setup screen appears, press "S" to specify additional device(s).
4. Insert the driver diskette-"Intel AA RAID XP/2003 Driver for ICH9R" into Drive A: and press the <Enter> key.
5. Choose the Intel(R) ICH9R *SATA RAID Controller* from the list indicated in the XP/2003 Setup Screen, and press the <Enter> key.
6. Press the <Enter> key to continue the installation process. (If you need to specify any additional devices to be installed, do it at this time.) Once all devices are specified, press the <Enter> key to continue with the installation.
7. From the Windows XP/2003 Setup screen, press the <Enter> key. The XP/2003 Setup will automatically load all device files and then, continue the Windows XP/2003 installation.
8. After the Windows XP/2003 OS Installation is completed, the system will automatically reboot.

B-2 Installing the Windows XP/2000/2003 OS for Systems without RAID Functions

1. Insert Microsoft's Windows XP/2000/2003 Setup CD in the CD Driver, and the system will start booting up from CD.
2. From the Windows XP/2000/2003 Setup screen, press the <Enter> key. The XP/2000/2003 Setup will automatically load all device files and then continue with the Windows XP/2000/2003 installation.
3. After the Windows XP/2000/2003 OS Installation is completed, the system will automatically reboot.
4. Insert the Supermicro Setup CD that came with your motherboard into the CD Drive during system boot, and the main screen will display.

Appendix C

Software Installation Instructions

C-1 Installing Drivers

After you've installed the Windows Operating System, a screen as shown below will appear. You are ready to install software programs and drivers that have not yet been installed. To install these software programs and drivers, click the icons to the right of these items.

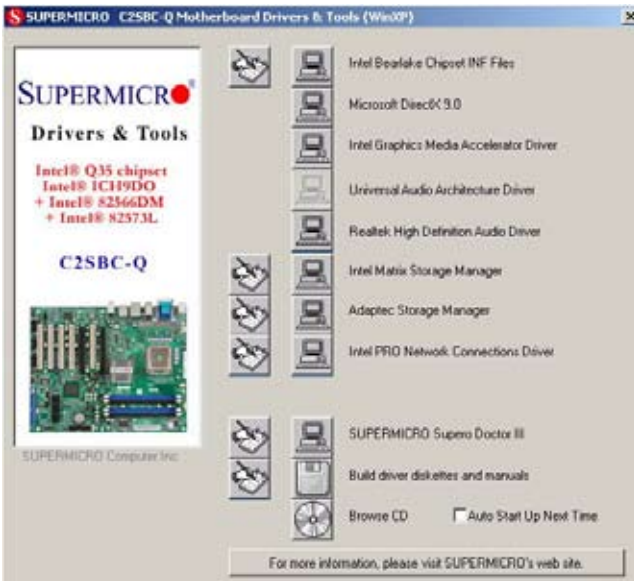

Driver/Tool Installation Display Screen



Note: Click the icons showing a hand writing on the paper to view the readme files for each item. Click a computer icon to the right of an item to install an item (from top to the bottom) one at a time. After installing each item, you must re-boot the system before proceeding with the next item on the list. The bottom icon with a CD on it allows you to view the entire contents of the CD.

C-2 Configuring Supero Doctor III

The Supero Doctor III program is a Web-base management tool that supports remote management capability. It includes Remote and Local Management tools. The local management is called the SD III Client. The Supero Doctor III program included on the CDROM that came with your motherboard allows you to monitor the environment and operations of your system. Supero Doctor III displays crucial system information such as CPU temperature, system voltages and fan status. See the Figure below for a display of the Supero Doctor III interface.



Note 1: Both default user name and password are ADMIN.

Note 2: In the Windows OS environment, the Supero Doctor III settings take precedence over the BIOS settings. When first installed, Supero Doctor III adopts the temperature threshold settings previously set in the BIOS. Any subsequent changes to these thresholds must be made within Supero Doctor, since the SD III settings override the BIOS settings. For the Windows OS to adopt the BIOS temperature threshold settings, please change the SDIII settings to be the same as those set in the BIOS.

Supero Doctor III Interface Display Screen-I (Health Information)



Supero Doctor III Interface Display Screen-II (Remote Control)



Note: SD III Software Revision 1.0 can be downloaded from our Web site at: ftp://ftp.supermicro.com/utility/Supero_Doctor_III/. You can also download SDIII User's Guide at: <http://www.supermicro.com/PRODUCT/Manuals/SDIII/UserGuide.pdf>. For Linux, we will still recommend that you use Supero Doctor II.

Notes

(Disclaimer Continued)

The products sold by Supermicro are not intended for and will not be used in life support systems, medical equipment, nuclear facilities or systems, aircraft, aircraft devices, aircraft/emergency communication devices or other critical systems whose failure to perform be reasonably expected to result in significant injury or loss of life or catastrophic property damage. Accordingly, Supermicro disclaims any and all liability, and should buyer use or sell such products for use in such ultra-hazardous applications, it does so entirely at its own risk. Furthermore, buyer agrees to fully indemnify, defend and hold Supermicro harmless for and against any and all claims, demands, actions, litigation, and proceedings of any kind arising out of or related to such ultra-hazardous use or sale.