

SUPER[®]●

SUPER[®]● X7DWT

SUPER[®]● X7DWT-INF

USER'S MANUAL

Revision 1.0

The information in this User's Manual has been carefully reviewed and is believed to be accurate. The vendor assumes no responsibility for any inaccuracies that may be contained in this document, makes no commitment to update or to keep current the information in this manual, or to notify any person or organization of the updates. **Please Note: For the most up-to-date version of this manual, please see our web site at www.supermicro.com.**

Super Micro Computer, Inc. ("Supermicro") reserves the right to make changes to the product described in this manual at any time and without notice. This product, including software, if any, and documentation may not, in whole or in part, be copied, photocopied, reproduced, translated or reduced to any medium or machine without prior written consent.

IN NO EVENT WILL SUPERMICRO BE LIABLE FOR DIRECT, INDIRECT, SPECIAL, INCIDENTAL, SPECULATIVE OR CONSEQUENTIAL DAMAGES ARISING FROM THE USE OR INABILITY TO USE THIS PRODUCT OR DOCUMENTATION, EVEN IF ADVISED OF THE POSSIBILITY OF SUCH DAMAGES. IN PARTICULAR, SUPERMICRO SHALL NOT HAVE LIABILITY FOR ANY HARDWARE, SOFTWARE, OR DATA STORED OR USED WITH THE PRODUCT, INCLUDING THE COSTS OF REPAIRING, REPLACING, INTEGRATING, INSTALLING OR RECOVERING SUCH HARDWARE, SOFTWARE, OR DATA.

Any disputes arising between manufacturer and customer shall be governed by the laws of Santa Clara County in the State of California, USA. The State of California, County of Santa Clara shall be the exclusive venue for the resolution of any such disputes. Supermicro's total liability for all claims will not exceed the price paid for the hardware product.

FCC Statement: This equipment has been tested and found to comply with the limits for a Class A digital device pursuant to Part 15 of the FCC Rules. These limits are designed to provide reasonable protection against harmful interference when the equipment is operated in a commercial environment. This equipment generates, uses, and can radiate radio frequency energy and, if not installed and used in accordance with the manufacturer's instruction manual, may cause harmful interference with radio communications. Operation of this equipment in a residential area is likely to cause harmful interference, in which case you will be required to correct the interference at your own expense.

California Best Management Practices Regulations for Perchlorate Materials: This Perchlorate warning applies only to products containing CR (Manganese Dioxide) Lithium coin cells. "Perchlorate Material-special handling may apply. See www.dtsc.ca.gov/hazardouswaste/perchlorate"

WARNING: Handling of lead solder materials used in this product may expose you to lead, a chemical known to the State of California to cause birth defects and other reproductive harm.

Manual Revision 1.0

Release Date: Nov. 27, 2007

Unless you request and receive written permission from SUPER MICRO COMPUTER, INC., you may not copy any part of this document.

Information in this document is subject to change without notice. Other products and companies referred to herein are trademarks or registered trademarks of their respective companies or mark holders.

Copyright © 2007 by SUPER MICRO COMPUTER, INC.

All rights reserved.

Printed in the United States of America

Preface

About This Manual

This manual is written for system integrators, PC technicians and knowledgeable PC users. It provides information for the installation and use of the X7DWT/X7DWT-INF motherboard. The **SUPER** X7DWT/X7DWT-INF supports dual Intel Xeon 64-bit Quad-Core/Dual-Core processors at a front side bus speed of up to 1.6 GHz With two Xeon 64-bit Quad-Core/Dual-Core processors, Intel 5400 Chipset, and eight DDR2 FBD (Fully Buffered) 800/667/533 memory modules built-in, the X7DWT/X7DWT-INF offers substantial functionality and performance enhancements to the motherboards based on the Core microarchitecture while remaining compatible with the 32-bit based software. Key features supported include Enhanced Intel SpeedStep technology, Virtualization Technology, PECL (Platform Environment Control Interface), Advanced Dynamic Execution, Advanced Transfer Cache, Streaming SIMD Extensions 4 (SSE4), and Thermal Monitor 2 (TM2) Technology. These features allow the motherboard to operate at much higher speeds with better power management in much safer environments than the traditional motherboards. This motherboard is ideal for high performance dual processor (DP) enterprise server environments. This product is intended to be professionally installed.

Manual Organization

Chapter 1 describes the features, specifications and performance of the mainboard and provides detailed information about the chipset.

Chapter 2 provides hardware installation instructions. Read this chapter when installing the processor, memory modules and other hardware components.

Chapter 3, which describes troubleshooting procedures for the video, the memory and the system setup stored in the CMOS.

Chapter 4 includes an introduction to BIOS and provides detailed information on running the CMOS Setup utility.

Appendix A and **Appendix B** provide BIOS POST Messages and POST Codes. **Appendix C**, **Appendix D** and **Appendix E** list HostRAID Setup Guidelines and Other Software Installation Instructions.

Conventions Used in the Manual:

Special attention should be given to the following symbols for proper installation and to prevent damage done to the components or injury to yourself:



Warning: Important information given to ensure proper system installation or to prevent damage to the components.

Note: Additional Information given to differentiate various models or to ensure correct system setup.

Table of Contents

Preface

About This Manual	iii
Manual Organization	iii
Conventions Used in the Manual.....	iii

Chapter 1: Introduction

1-1 Overview	1-1
Checklist	1-1
Contacting Supermicro	1-2
SUPER X7DWT/X7DWT-INF Image	1-3
SUPER X7DWT/X7DWT-INF Layout	1-4
Quick Reference	1-5
Motherboard Features.....	1-6
Intel 5400 Chipset: System Block Diagram	1-8
1-2 Chipset Overview	1-9
1-3 Special Features	1-10
1-4 PC Health Monitoring	1-10
1-5 ACPI Features	1-11
1-6 Power Supply	1-12
1-6 Super I/O	1-12

Chapter 2: Installation

2-1 Static-Sensitive Devices	2-1
Precautions.....	2-1
Unpacking	2-1
2-2 Processor and Heatsink Installation	2-2
2-3 Installing DIMMs	2-6
2-4 Control Panel Connectors and IO Ports	2-8
Back Panel Connectors/IO Ports	2-8
Front Control Panel.....	2-9
Front Control Panel Pin Definitions.....	2-10
NMI Button	2-10
Power LED	2-10
HDD LED	2-11
NIC1/NIC2 LEDs	2-11
Overheat/Fan Fail LED	2-12
Power Fail LED	2-12
Reset Button.....	2-13

Power Button	2-13
2-5 Connecting Cables	2-14
SMC Proprietary 20-pin Power Connectors	2-14
4-pin Auxiliary Power Connector	2-15
Universal Serial Bus	2-16
Chassis Intrusion	2-16
Fan Headers	2-17
Serial Port	2-17
VGA Connector	2-18
SMB Connector	2-18
Power SMB Connector	2-19
Wake-On-LAN	2-19
GLAN 1/2 (Ethernet) Ports	2-20
SGPIO Header	2-20
Speaker Header	2-21
2-6 Jumper Settings	2-22
Explanation of Jumpers	2-22
GLAN Enable/Disable	2-22
Clear CMOS	2-23
Watch Dog	2-23
VGA Enable/Disable	2-24
2-7 Onboard Indicators	2-25
GLAN LEDs	2-25
Onboard Standby Power LED	2-25
InfiniBand LEDs	2-26
2-8 SIMSO IPMI and InfiniBand Connections	2-27
SIMSO IPMI Slot	2-27
InfiniBand Connector	2-27

Chapter 3: Troubleshooting

3-1 Troubleshooting Procedures	3-1
Before Power On	3-1
No Power	3-1
No Video	3-1
Losing the System's Setup Configuration	3-1
Memory Errors	3-2
3-2 Technical Support Procedures	3-2
3-3 Frequently Asked Questions	3-3
3-4 Returning Merchandise for Service	3-4

Chapter 4: BIOS

4-1	Introduction	4-1
4-2	Running Setup	4-2
4-3	Main BIOS Setup	4-2
4-4	Advanced Setup	4-6
4-5	Security Setup	4-22
4-6	Boot Setup	4-23
4-7	Exit	4-24

Appendices:

Appendix A: BIOS POST Messages	A-1
Appendix B: BIOS POST Codes	B-1
Appendix C: Intel HostRAID Setup Guidelines	C-1
Appendix D: Adaptec HostRAID Setup Guidelines	D-1
Appendix E: Installing Other Software Programs and Drivers	E-1

Chapter 1

Introduction

1-1 Overview

Checklist

Congratulations on purchasing your computer motherboard from an acknowledged leader in the industry. Supermicro boards are designed with the utmost attention to detail to provide you with the highest standards in quality and performance. Check that the following items have all been included with your motherboard. If anything listed here is damaged or missing, contact your retailer.

All the following items are included in the retail box.

- One (1) Supermicro Mainboard
- Four (4) SATA cable for IDE devices (CBL-0044)
- One (1) Supermicro CD containing drivers and utilities
- One (1) User's/BIOS Manual

Contacting Supermicro

Headquarters

Address: Super Micro Computer, Inc.
980 Rock Ave.
San Jose, CA 95131 U.S.A.

Tel: +1 (408) 503-8000

Fax: +1 (408) 503-8008

Email: marketing@supermicro.com (General Information)
support@supermicro.com (Technical Support)

Web Site: www.supermicro.com

Europe

Address: Super Micro Computer B.V.
Het Sterrenbeeld 28, 5215 ML
's-Hertogenbosch, The Netherlands

Tel: +31 (0) 73-6400390

Fax: +31 (0) 73-6416525

Email: sales@supermicro.nl (General Information)
support@supermicro.nl (Technical Support)
rma@supermicro.nl (Customer Support)

Asia-Pacific

Address: Super Micro, Taiwan
4F, No. 232-1 Liancheng Road
Chung-Ho 235, Taipei Hsien, Taiwan, R.O.C.

Tel: +886-(2) 8226-3990

Fax: +886-(2) 8226-3991

Web Site: www.supermicro.com.tw

Technical Support:

Email: support@supermicro.com.tw

Tel: 886-2-8228-1366, ext.132 or 139

SUPER[®] X7DWT/X7DWT-INF Image

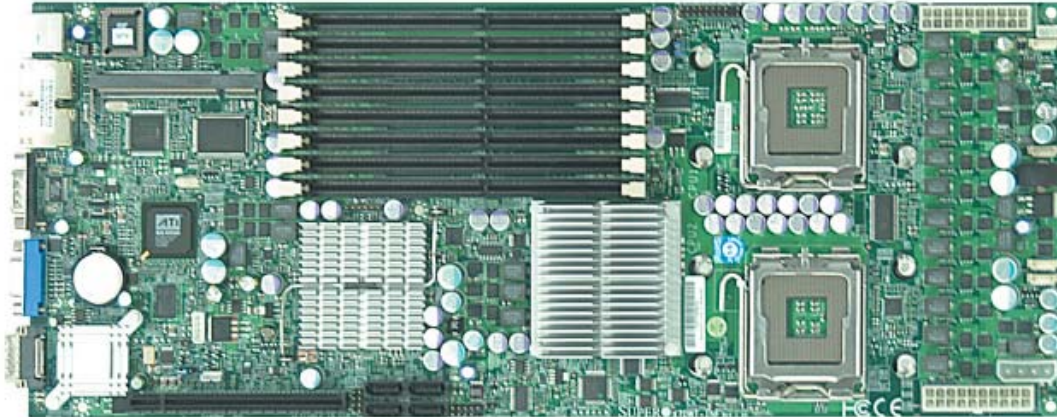

Note: The drawings and pictures shown in this manual were based on the latest PCB Revision available at the time of publishing of the manual. The motherboard you've received may or may not look exactly the same as the graphics shown in the manual.

SUPER[®] X7DWT/X7DWT-INF Motherboard Layout

(not drawn to scale)

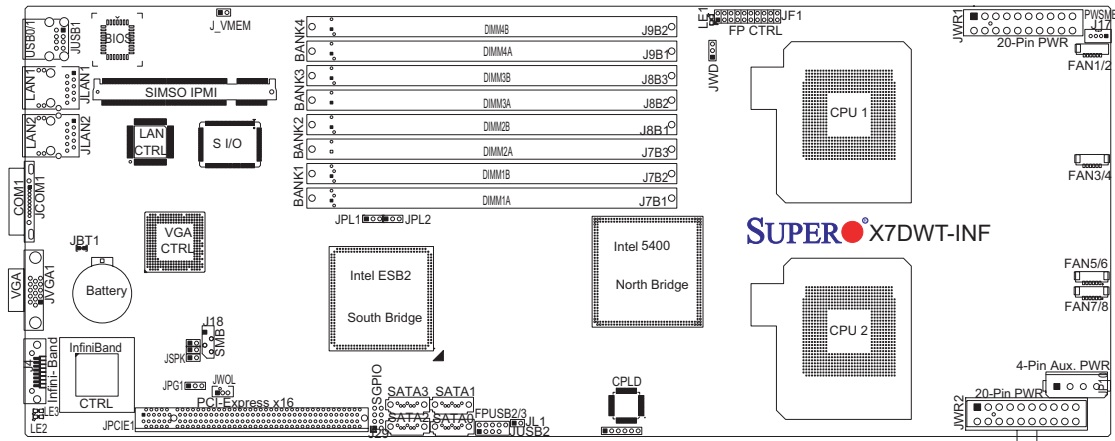

Notes:

1. Jumpers not indicated are for test purposes only.
2. See Chapter 2 for detailed information on jumpers, I/O ports and JF1 front panel connections.
3. "■" indicates the location of Pin 1.
4. The InfiniBand is available on the X7DWT-INF only.
5. You cannot use both 20-pin power connectors located at JWR1 (the right side connector) and JWR2 (the left side connector) as input power supply connectors at the same time. Only one connector can be used for input power supply to the motherboard at one time. For proper use of these proprietary PWR Connectors, please customize your PWR cables based on the Power Connector Pin-Out Definitions listed on Page 2-14.
6. The 4-pin Auxiliary Power Connector is used for power supply output to the HDDs only.
7. Refer to Pages 2-14, 2-15 for more information on power connectors.

Quick Reference(X7DWT/X7DWT-INF)

Jumper	Description	Default Setting
JBT1	CMOS Clear	See Chapter 2
JPG1	VGA Enable	Pins 1-2 (Enabled)
JPL1	GLAN1 Enable	Open (Enabled)
JPL2	GLAN2 Enable	Open (Enabled)
JWD	Watch Dog	Pins 1-2 (Reset)

Connector	Description
FAN 1-8	Fans 1-8 (CPU Fans/Chassis Fans)
J4	InfiniBand Connector (For X7DWT-INF only)
J17	Power System Management Bus (I ² C) Header
J18	System Management Bus Header
J29	Serial General Purpose Input/Output Header
COM1	COM1 (JCOM1) Serial Port
JF1	Front Control Panel Connector
JL1	Chassis Intrusion Header
LAN1/LAN2	G-bit Ethernet Ports
JP10	4-pin Aux. PWR (for output only) (for HDDs) (Note 2)
JWR1	Primary 20-Pin PWR Connector (Note1)
JWR2	External 20-Pin PWR Connector (Note1)
JSPK	Speaker Header
JWOL	Wake-on LAN Header
USB 0/1	Back Panel USB 0/1 for external use (JUSB1)
USB 2/3	Front Panel USB 2/3
VGA	VGA Connector (JVGA1)
SIMSO	SIMSO IPMI slot
SATA 0-3	Intel SATA 0-3 Connectors

LED Indicator	Description (See Chapter 2)
LE1	Onboard Power LED Indicator
LE2	InfiniBand Link LED (green)
LE3	InfiniBand Activity LED (yellow)

Note 1: You cannot use both 20-pin power connectors located at JWR1 (the right side connector) and JWR2 (the left side connector) as input power supply connectors at the same time. Only one connector can be used for input power supply to the motherboard at one time. For proper use of these proprietary PWR Connectors, please customize your PWR cables based on the Power Connector Pin-Out Definitions listed on Page 2-14.

Note 2: The 4-pin Auxiliary PWR Connector is used as a power output to the HDDs only. Refer to Pages 2-14, 2-15 for more information on power connectors.

Motherboard Features

CPU

- Dual Intel® 64-bit Xeon LGA 771 Quad-Core/Dual-Core processors at a front side bus speed of 1.600 GHz, 1.333 GHz or 1.066 GHz

Memory

- Eight 240-pin DIMM sockets with support up to 64 GB DDR2 FBD (Fully Buffered) ECC 800/667/533 Memory (See Section 2-3 in Chapter 2 for DIMM Slot Population.)

Chipset

- Intel 5400 chipset, including: the 5400 Memory Control Hub (MCH), and the Enterprise South Bridge 2 (ESB2)

Expansion Slots

- One PCI-Express (Gen. 2.0) slot (one PCI-E slot x16: JPCIE1)

BIOS

- 8 Mb Phoenix® Flash ROM
- DMI 2.3, PCI 2.2, ACPI 1.0/2.0, Plug and Play (PnP), USB Keyboard Support, SMBIOS 2.3

PC Health Monitoring

- Onboard voltage monitors for CPU cores, chipset voltage (+1.5V), memory voltage, +3.3V, +5V, +12V, -12V, +3.3V Standby, +5V standby, HT and VBAT
- Fan status monitor with firmware control
- CPU/chassis environment monitoring
- Platform Environment Control Interface (PECI) ready
- CPU fan auto-off in sleep mode
- CPU slow-down on temperature overheat
- CPU thermal trip support for processor protection, power LED
- Power-up mode control for recovery from AC power loss
- Auto-switching voltage regulator for CPU cores
- System overheat/Fan Fail LED Indicator and control
- Chassis intrusion detection
- System resource alert via Supero Doctor III
- I²C temperature sensing logic
- Thermal Monitor 2 (TM) support

ACPI Features

- Slow blinking LED for suspend state indicator
- Main switch override mechanism
- ACPI Power Management

Onboard I/O

- Four SATA2 ports (supporting RAID0, 1, 10 and 5 in the Windows OS environment)
- One SIMSO IPMI slot
- One Intel Gigabit Ethernet 82563EB controller supports two Giga-bit LAN ports
- One COM port
- Up to four USB 2.0 (Universal Serial Bus) (2 ports, 2 Headers)
- ATI ES1000 Graphic Controller with 32 MB Video Memory
- Super I/O: Winbond W83627HF
- Mellanox MT25204A0-FCC-D InfiniBand Controller supports one InfiniBand connector (X7DWT-INF only)

Other

- Wake-on-LAN
- Chassis Intrusion
- Console redirection
- Onboard Fan Speed Control by Thermal Management via BIOS

CD/Diskette Utilities

- BIOS flash upgrade utility and device drivers

Dimensions

- Proprietary 16.0" x 6.5" (406.4 mm x 165.1 mm)

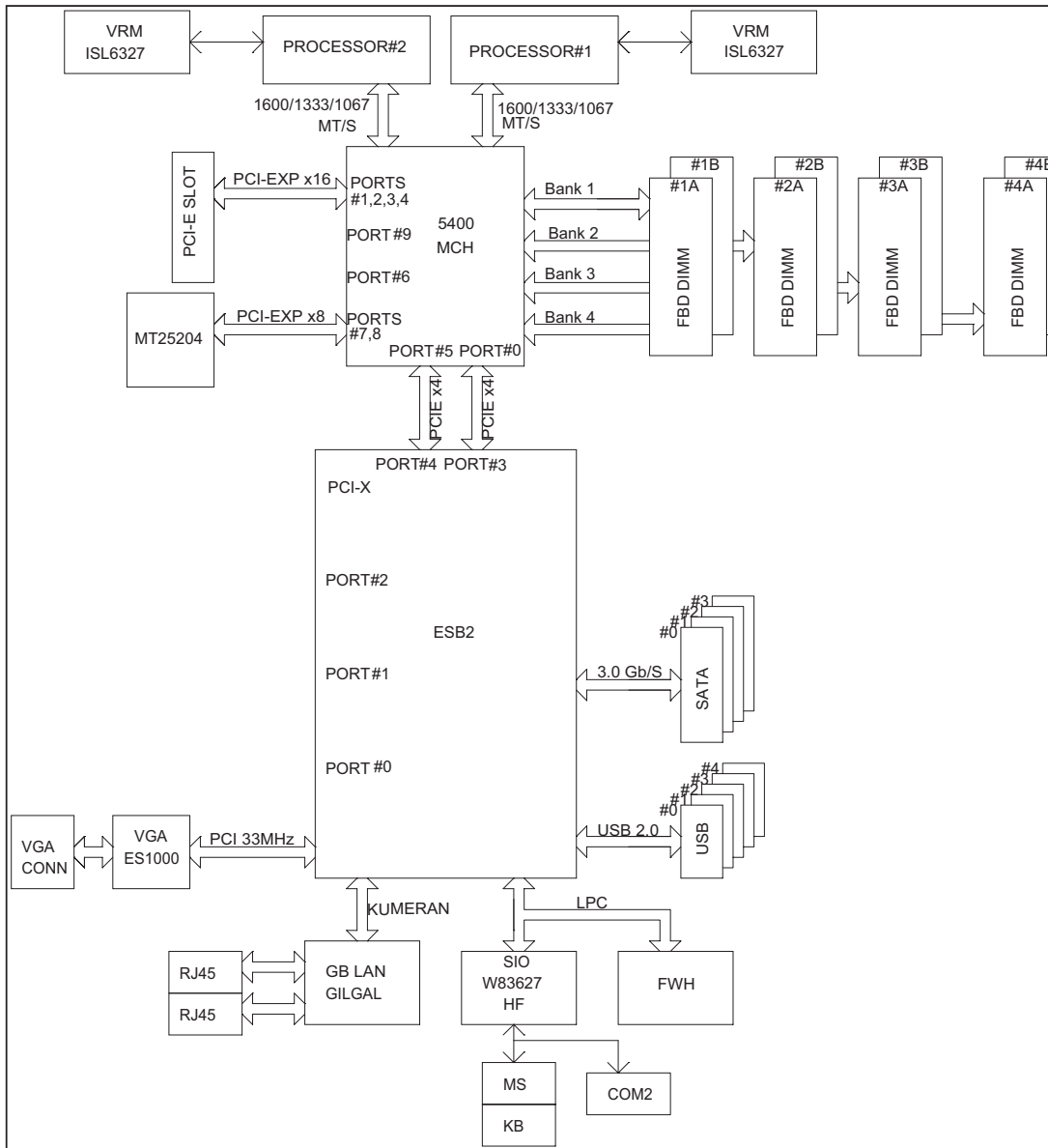

Block Diagram of the Motherboard

Note: This is a general block diagram. Please see the previous Motherboard Features pages for details on the features of the motherboard.

1-2 Chipset Overview

Built upon the functionality and the capability of the 5400 chipset, the X7DWT/X7DWT-INF motherboard provides the performance and feature set required for dual processor-based servers with configuration options optimized for communications, presentation, storage, computation or database applications. The 5400 chipset supports single or dual Xeon 64-bit Quad-Core/Dual-Core processor(s) with a front side bus speeds of up to 1.600 GHz. The chipset consists of the 5400 Memory Controller Hub (MCH) and the Enterprise South Bridge 2 (ESB2).

The 5400 MCH chipset is designed for symmetric multiprocessing across two independent front side bus interfaces. Each front side bus uses a 64-bit wide, 1600 MHz data bus to transfer data. The MCH chipset connects up to eight Fully Buffered DIMM modules, providing a total memory of up to 64 GB for DDR2 FBD 800/667/533 MHz. The MCH chipset also provides one x8 PCI-Express and one x4 ESI interfaces to the ESB2. In addition, the 5400 chipset offers a wide range of RAS features, including memory interface ECC, x4/x8 Single Device Data Correction, CRC, parity protection, memory mirroring and memory sparing.

Xeon Quad-Core/Dual-Core Processor Features

Designed to be used with conjunction of the 5400 chipset, the Xeon Quad-Core/Dual-Core Processor provides a feature set as follows:

Xeon Quad-Core/Dual-Core Processors

L1 Cache Size: Instruction Cache (32KB/16KB), Data Cache (32KB/24KB)

L2 Cache Size: 4MB/2MB (per core)

Data Bus Transfer Rate: 8.5 GB/s

Package: FC-LGA6/FC-LGA4, 771 Lands

1-3 Special Features

Recovery from AC Power Loss

The feature allows the user to set the power state after a power outage. You can select Power-Off for the system power to remain off after a power loss. Select Power-On for the system power to be turned on after a power loss. Select Last State to allow the system to resume its last state before the power loss. The default setting is **Last State**.

1-4 PC Health Monitoring

This section describes the PC health monitoring features of the X7DWT/X7DWT-INF. All models have an onboard System Hardware Monitor chip that supports PC health monitoring.

Onboard Voltage Monitors

An onboard voltage monitor will scan for CPU Cores, Memory Voltage, Chipset Voltage (+1.5V),+1.8V, +3.3V, +5V, +12V, -12V, +3.3V Standby, +5V standby, HT and VBAT continuously. Once a voltage becomes unstable, a warning is given or an error message is sent to the screen. Users can adjust the voltage thresholds to define the sensitivity of the voltage monitor.

Fan Status Monitor with Firmware Control

The PC health monitor can check the RPM status of the cooling fans. The onboard CPU and chassis fans are controlled by Thermal Management 2 (TM2) in the BIOS (under Hardware Monitoring in the Advanced Setting).

Environmental Temperature Control

The thermal control sensor monitors the CPU temperature in real time and will turn on the thermal control fan whenever the CPU temperature reaches a user-defined threshold. The overheat circuitry runs independently from the CPU. Once it detects that the CPU temperature is too high, it will automatically turn on the thermal fan control to prevent overheating. The onboard chassis thermal circuitry can monitor the overall system temperature and alert users when the chassis temperature is too high.

CPU Fan Auto-Off in Sleep Mode

The CPU fan is activated when the power is turned on. It continues to operate even when the system enters the standby mode. When in the sleep mode, the CPU will not run at full power, thereby generating less heat.

CPU Overheat LED and Control

This feature is available when the user enables the CPU overheat warning function in the BIOS. This allows the user to define an overheat temperature threshold.

When the temperature reaches a user pre-defined threshold, both overheat fan and warning LED are triggered.

System Resource Alert

This feature is available when used with Supero Doctor III in the Windows OS environment or used with Supero Doctor II in Linux. Supero Doctor is used to notify the user of certain system events. For example, if the system is running low on virtual memory and there is insufficient hard drive space for saving the data, you can be alerted of the potential problem. You can also configure Supero Doctor to provide you with warnings when the system temperature reaches a pre-defined range.

1-5 ACPI Features

ACPI stands for Advanced Configuration and Power Interface. The ACPI specification defines a flexible and abstract hardware interface that provides a standard way to integrate power management features throughout a PC system, including its hardware, operating system and application software. This enables the system to automatically turn on and off peripherals such as CD-ROMs, network cards, hard disk drives and printers. This also includes consumer devices connected to the PC such as VCRs, TVs, telephones and stereos.

In addition to enabling operating system-directed power management, ACPI provides a generic system event mechanism for Plug and Play and an operating system-independent interface for configuration control. ACPI leverages the Plug and Play BIOS data structures while providing a processor architecture-independent implementation that is compatible with Windows 2000, Windows 2003, and Windows Vista Operating Systems.

Slow Blinking LED for Suspend-State Indicator

When the CPU goes into a suspend state, the chassis power LED will start blinking to indicate that the CPU is in suspend mode. When the user presses any key, the CPU will wake up and the LED will automatically stop blinking and remain on.

Main Switch Override Mechanism

When a power supply is used, the power button can function as a system suspend button to make the system enter a SoftOff state. The monitor will be suspended and the hard drive will spin down. Pressing the power button again to wake up the whole system. During the SoftOff state, the power supply provides power to keep the required circuitry in the system "alive". In case the system malfunctions, and you want to turn off the power, just press and hold the power button for 4 seconds. This option can be set in the Boot Features Section under Advanced Setup in the BIOS.

Wake-On-LAN (WOL)

Wake-On-LAN is defined as the ability of a management application to remotely power up a computer that is powered off. Remote PC setup, up-dates and asset tracking can occur after hours and on weekends so that daily LAN traffic is kept to a minimum and users are not interrupted. The motherboard has a 3-pin header (WOL) to connect to the 3-pin header on a Network Interface Card (NIC) that has WOL capability. In addition, an onboard LAN controller can also support WOL without any connection to the WOL header. The 3-pin WOL header is to be used with a LAN add-on card only.

Note: Wake-On-LAN requires an ATX 2.01 (or above) compliant power supply.

1-6 Power Supply

Supermicro's proprietary power connectors are used in the X7DWT/X7DWT-INF. Please refer to [Section 2-5 Connecting Cables](#) on Page 2-14 for more information.

1-7 Super I/O

The disk drive adapter functions of the Super I/O chip include a floppy disk drive controller that is compatible with industry standard 82077/765, a data separator, write pre-compensation circuitry, decode logic, data rate selection, a clock generator, drive interface control logic and interrupt and DMA logic. The wide range of functions integrated onto the Super I/O greatly reduces the number of components required for interfacing with floppy disk drives. The Super I/O supports 360 K, 720 K, 1.2 M, 1.44 M or 2.88 M disk drives and data transfer rates of 250 Kb/s, 500 Kb/s or 1 Mb/s. It also provides two high-speed, 16550 compatible serial communication ports (UARTs). Both UARTs provide legacy speed with baud rate of up to 115.2 Kbps as well as an advanced speed with baud rates of 250 K, 500 K, or 1 Mb/s, which support higher speed modems.

The Super I/O supports one PC-compatible printer port (SPP), Bi-directional Printer Port (BPP), Enhanced Parallel Port (EPP) or Extended Capabilities Port (ECP).

The Super I/O provides functions that comply with ACPI (Advanced Configuration and Power Interface), which includes support of legacy and ACPI power management through an SMI or SCI function pin. It also features auto power management to reduce power consumption.

Chapter 2

Installation

2-1 Static-Sensitive Devices



Electrostatic-Discharge (ESD) can damage electronic components. To prevent damage to your system board, it is important to handle it very carefully. The following measures are generally sufficient to protect your equipment from ESD.

Precautions

- Use a grounded wrist strap designed to prevent static discharge.
- Touch a grounded metal object before removing the board from the antistatic bag.
- Handle the board by its edges only; do not touch its components, peripheral chips, memory modules or gold contacts.
- When handling chips or modules, avoid touching their pins.
- Put the motherboard and peripherals back into their antistatic bags when not in use.
- For grounding purposes, make sure your computer chassis provides excellent conductivity between the power supply, the case, the mounting fasteners and the motherboard.
- Use only the correct type of onboard CMOS battery as specified by the manufacturer. Do not install the onboard battery upside down to avoid possible explosion.

Unpacking

The motherboard is shipped in antistatic packaging to avoid static damage. When unpacking the board, make sure the person handling it is static protected.

2-2 Processor and Heatsink Installation



When handling the processor package, avoid placing direct pressure on the label area of the fan.

Notes:

1. Always connect the power cord last and always remove it before adding, removing or changing any hardware components. Make sure that you install the processor into the CPU socket before you install the CPU heatsink.
2. Intel's boxed Xeon CPU package contains the CPU fan and heatsink assembly. If you buy a CPU separately, make sure that you use only Intel-certified multi-directional heatsink and fan.
3. Make sure to install the motherboard into the chassis before you install the CPU heatsink and fan.)
4. When purchasing an LGA 771 CPU or when receiving a motherboard with an LGA 771 CPU pre-installed, make sure that the CPU plastic cap is in place and none of the CPU pins are bent; otherwise, contact the retailer immediately.
5. Refer to the MB Features Section for more details on CPU support.

Installation of the LGA771 Processor

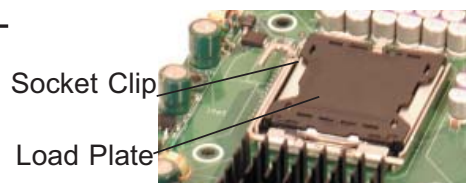

1. Press the socket clip to release the load plate, which covers the CPU socket, from its locking position.



2. Gently lift the socket clip to open the load plate.

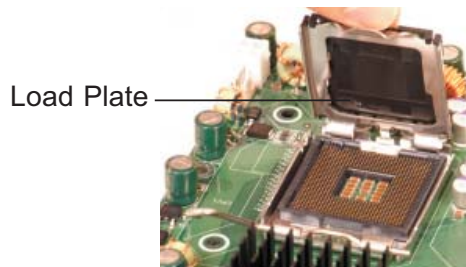

3. Use your thumb and your index finger to hold the CPU at the North Center Edge and the South Center Edge of the CPU.

4. Align CPU Pin1 (the CPU corner marked with a triangle) against the socket corner that is marked with a triangle cutout.

5. Align the CPU key that is the semi-circle cutout below a gold dot against the socket key, the notch on the same side of the triangle cutout on the socket.

6. Once aligned, carefully lower the CPU straight down to the socket. (Do not drop the CPU on the socket. Do not move the CPU horizontally or vertically. Do not rub the CPU against the surface or any pins of the socket to avoid damage to the CPU or the socket.)

7. With the CPU inside the socket, inspect the four corners of the CPU to make sure that the CPU is properly installed.

8. Use your thumb to gently push the socket clip down to the clip lock.

9. If the CPU is properly installed into the socket, the plastic cap will be automatically released from the load plate when the clip is pushed in the clip lock. Remove the plastic cap from the motherboard.

 **Warning:** Please save the plastic cap. The motherboard must be shipped with the plastic cap properly installed to protect the CPU. Shipment without the plastic cap properly installed will cause damage to the socket pins.

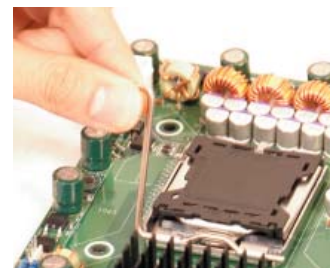
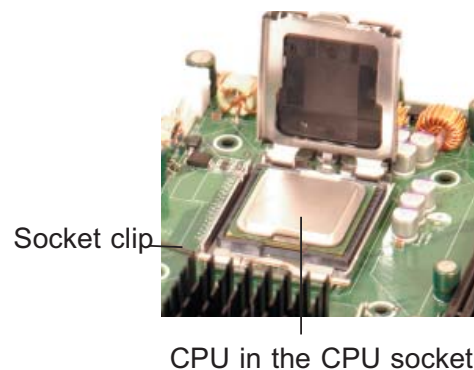
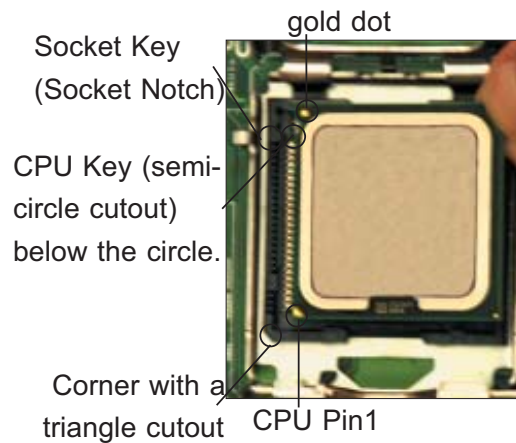
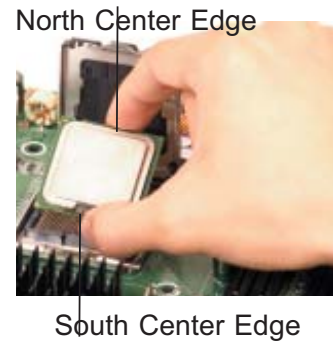

Plastic cap is released from the load plate if the CPU is properly installed.



Installation of the Heatsink

CEK Heatsink Installation

1. Do not apply any thermal grease to the heatsink or the CPU die-the required amount has already been applied.

2. Place the heatsink on top of the CPU so that the four mounting holes are aligned with those on the retention mechanism.

3. Screw in two diagonal screws (ie the #1 and the #2 screws) until just snug (-do not fully tighten the screws to avoid possible damage to the CPU.)

4. Finish the installation by fully tightening all four screws.

CEK Passive Heatsink

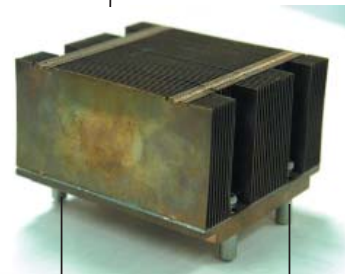

Screw#1

Screw#2

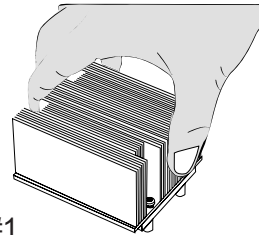

Screw#1

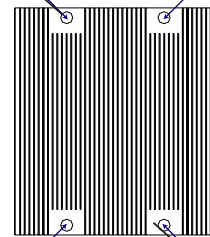

Screw#2

To Un-install the Heatsink



Warning: We do not recommend that the CPU or the heatsink be removed. However, if you do need to uninstall the heatsink, please follow the instructions below to uninstall the heatsink to prevent damage done to the CPU or the CPU socket.

1. Unscrew and remove the heatsink screws from the motherboard in the sequence as show in the picture on the right.

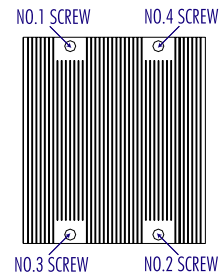

2. Hold the heatsink as shown in the picture on the right and gently wriggle the heatsink to loosen it from the CPU. (Do not use excessive force when wriggling the heatsink!!)

3. Once the CPU is loosened, remove the heatsink from the CPU socket.

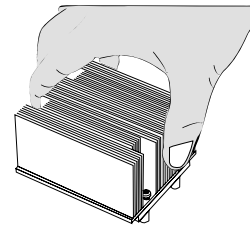

4. Clean the surface of the CPU and the heatsink to get rid of the old thermal grease. Reapply the proper amount of thermal grease on the surface before you re-install the CPU and the heatsink.

Mounting the Motherboard in the Chassis

All motherboards have standard mounting holes to fit different types of chassis. Make sure that the locations of all the mounting holes for both motherboard and chassis match. Make sure that the metal standoffs click in or are screwed in tightly. Then, use a screwdriver to secure the motherboard onto the motherboard tray. (**Note:** some components are very close to the mounting holes. Please take precautionary measures to prevent damage done to these components when you install the motherboard to the chassis.)

2-3 Installing DIMMs

Note: Check the Supermicro web site for recommended memory modules.

CAUTION



Exercise extreme care when installing or removing DIMM modules to prevent any possible damage. Also note that the memory is interleaved to improve performance (see step 1).

DIMM Installation (See Figure 2-2)

1. Insert the desired number of DIMMs into the memory slots, starting with DIMM #1A. The memory scheme is interleaved so you must install two modules at a time, beginning with DIMM #1A, then DIMM #2A and so on. For optimal performance, please install four modules of the same type and same speed in Branch 0 and Branch 1 at a time (up to 8 modules maximum). (See the Memory Installation Table Below.)
2. Insert each DIMM module vertically into its slot. Pay attention to the notch along the bottom of the module to prevent inserting the DIMM module incorrectly.
3. Gently press down on the DIMM module until it snaps into place in the slot. Repeat for all modules (see step 1 above).

Memory Support

The X7DWT/X7DWT-INF supports up to 64 GB ECC DDR2 FBD (Fully Buffered) 800/667/533 in 8 DIMMs. Populating DIMM modules with pairs of memory modules of the same size and same type **will result in Interleaved Memory which will increase memory performance.**

Note 1: Due to OS limitations, some operating systems may not show more than 4 GB of memory.

Optimized DIMM Population Configurations								
	Branch 0				Branch 1			
Number of DIMMs	Bank 1 (Channel 0)		Bank 2 (Channel 1)		Bank 3 (Channel 2)		Bank 4 (Channel 3)	
2 DIMMs	1A	---	2A	---	---	---	---	---
4 DIMMs	1A	---	2A	---	3A	---	4A	---
6 DIMMs	1A	1B	2A	2B	3A	---	4A	---
8 DIMMs	1A	1B	2A	2B	3A	3B	4A	4B
(* Notes: i. DIMM slot# specified: DIMM slot to be populated; "---": DIMM slot not to be populated. ii. Both FBD 533 MHz and 667MHz DIMMs are supported; however, you need to use the memory modules of the same speed and of the same type on a motherboard. iii. Interleaved memory is supported when pairs of DIMM modules are installed. To optimize memory performance, please populate pairs of memory modules in both Branch 0 and Branch 1. iv. For memory to work properly, you need to follow the restrictions listed above.)								

Note 2: Both 1.5V and 1.8V memory modules are supported. However, do not use different memory modules with different speeds, voltages, sizes or types on the same motherboard.

Note 3: Due to memory allocation to system devices, memory remaining avail-

able for operational use will be reduced when 4 GB of RAM is used. The reduction in memory availability is disproportional. (Refer to the Memory Availability Table below for details.)

Possible System Memory Allocation & Availability			
System Device	Size	Physical Memory Remaining (-Available) (3 GB Total System Memory)	Physical Memory Remaining (-Available) (4 GB Total System Memory)
Firmware Hub flash memory (System BIOS)	1 MB	3.00	3.99
Local APIC	4 KB	3.00	3.99
Area Reserved for the chipset	2 MB	3.00	3.99
I/O APIC (4 Kbytes)	4 KB	3.00	3.99
PCI Enumeration Area 1	256 MB	3.00	3.76
PCI Express (256 MB)	256 MB	3.00	3.51
PCI Enumeration Area 2 (if needed) -Aligned on 256-MB boundary-	512 MB	3.00	3.01
VGA Memory	16 MB	2.85	2.85
TSEG	1 MB	2.84	2.84
Memory available to OS & other applications		2.84	2.84

Installing and Removing DIMMs

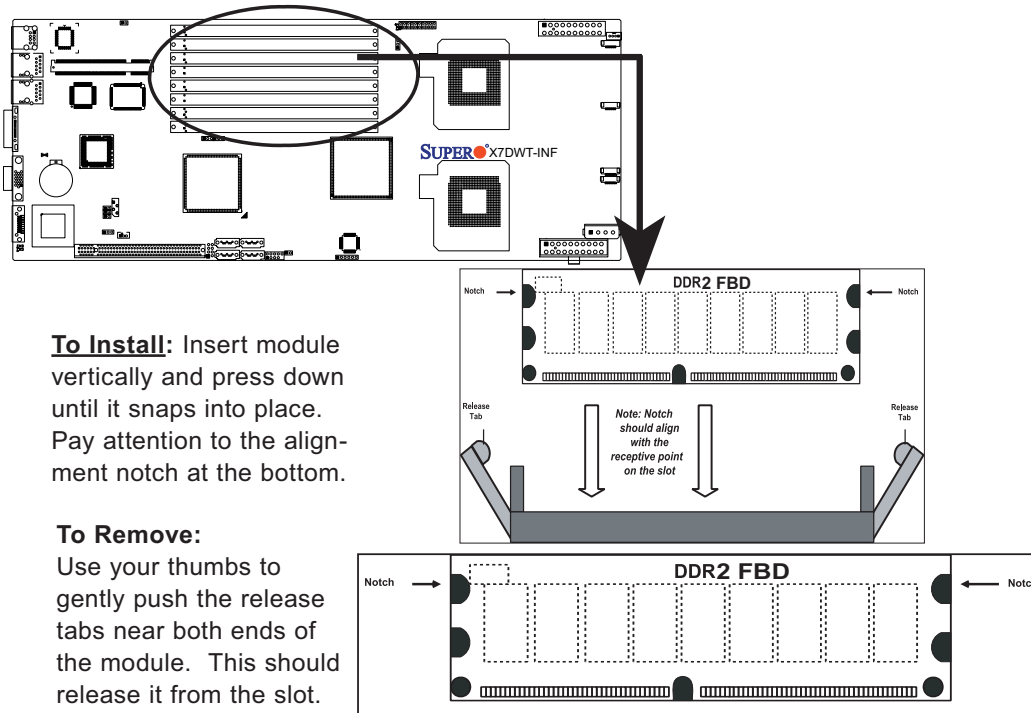

2-4 Control Panel Connectors/IO Ports

The I/O ports are color coded in conformance with the PC 99 specification. See Figure 2-3 below for the colors and locations of the various I/O ports.

Back Panel Connectors/IO Ports

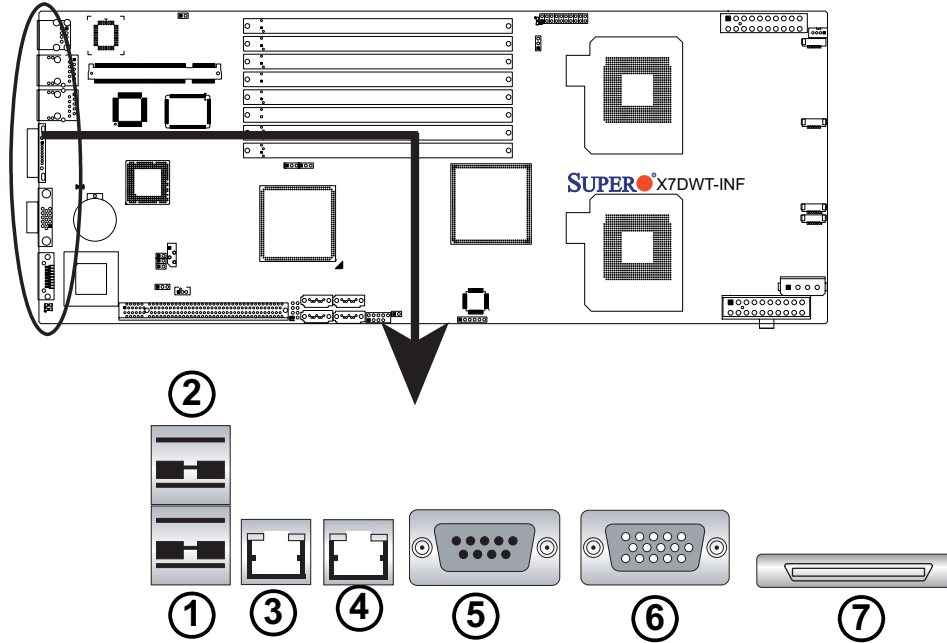

Back Panel I/O Port Locations and Definitions

Back Panel Connectors

1. Back Panel USB Port 0
 2. Back Panel USB Port 1
 3. Gigabit LAN 1
 4. Gigabit LAN 2
 5. COM Port 2
 6. VGA Port (Blue)
 7. InfiniBand Connector (for X7DWT-INF only)
- (See Section 2-5 for details.)

Front Control Panel

JF1 contains header pins for various buttons and indicators that are normally located on a control panel at the front of the chassis. These connectors are designed specifically for use with Supermicro server chassis. See Figure 2-4 for the descriptions of the various control panel buttons and LED indicators. Refer to the following section for descriptions and pin definitions.

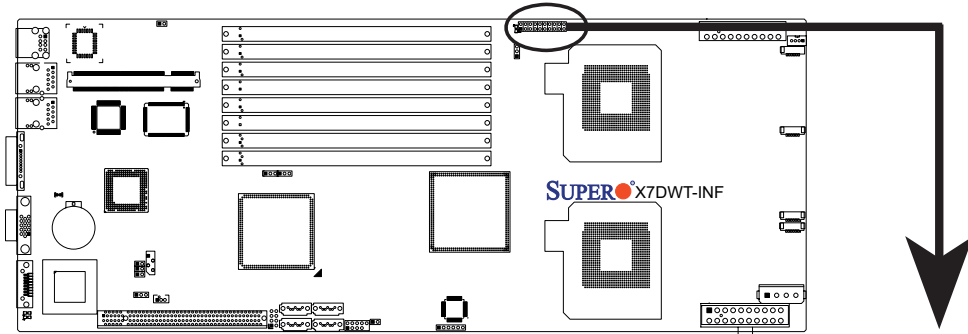

	20	19	
Ground	○	○	NMI
X	○	○	X
Power LED	○	○	Vcc
HDD LED	○	○	Vcc
NIC1 LED	○	○	Vcc
NIC2 LED	○	○	Vcc
OH/Fan Fail LED	○	○	Vcc
PWR Fail LED	○	○	Vcc
Ground	○	○	Reset
Ground	○	○	PWR
	2	1	Reset Button
			Power Button

JF1 Header Pins

Front Control Panel Pin Definitions

NMI Button

The non-maskable interrupt button header is located on pins 19 and 20 of JF1. Refer to the table on the right for pin definitions.

NMI Button Pin Definitions (JF1)	
Pin#	Definition
19	Control
20	Ground

Power LED

The Power LED connection is located on pins 15 and 16 of JF1. Refer to the table on the right for pin definitions.

Power LED Pin Definitions (JF1)	
Pin#	Definition
15	+5V
16	Ground

A. NMI

B. PWR LED

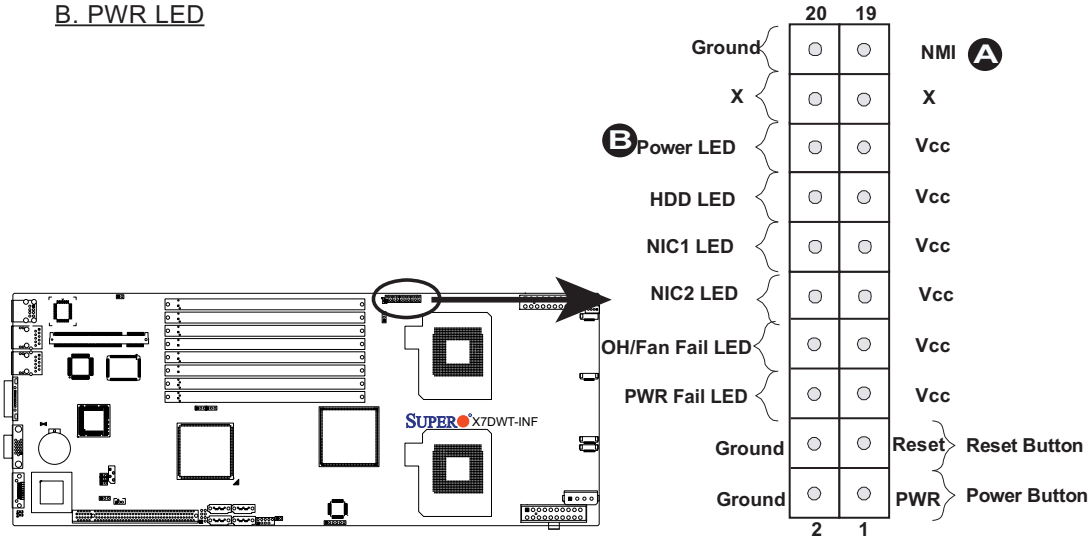

HDD LED

The HDD LED connection is located on pins 13 and 14 of JF1. Attach a hard drive LED cable here to display disk activity (for any hard drives on the system, including Serial ATA). See the table on the right for pin definitions.

HDD LED Pin Definitions (JF1)	
Pin#	Definition
13	+5V
14	HD Active

NIC1/NIC2 LED Indicators

The NIC (Network Interface Controller) LED connection for GLAN port1 is located on pins 11 and 12 of JF1 and the LED connection for GLAN Port2 is on Pins 9 and 10. Attach the NIC LED cables to display network activity. Refer to the table on the right for pin definitions.

GLAN1/2 LED Pin Definitions (JF1)	
Pin#	Definition
9/11	Vcc
10/12	Ground

- A. HDD LED
- B. NIC1 LED
- C. NIC2 LED

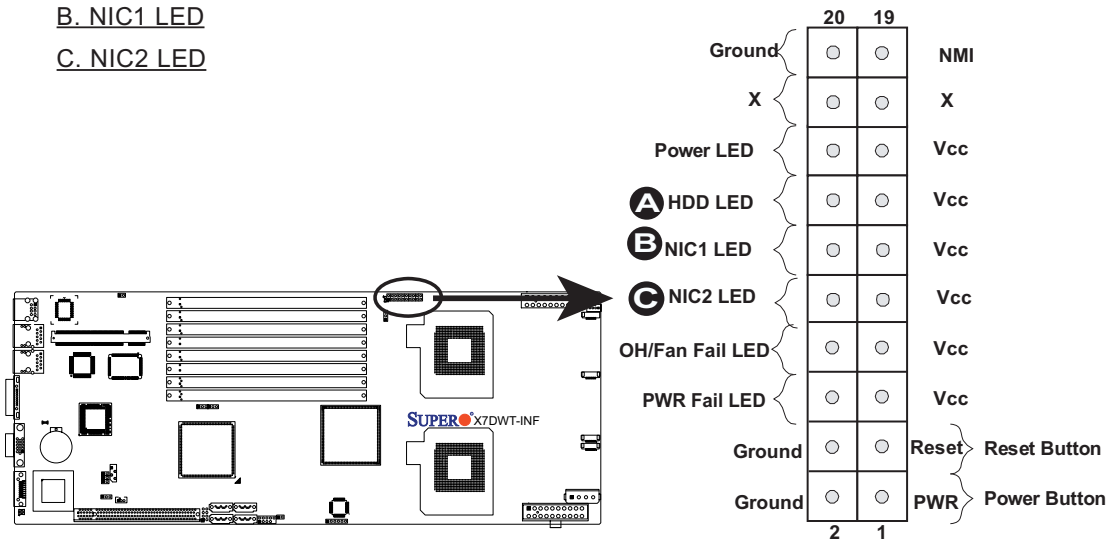

Overheat/Fan Fail LED (OH)

Connect an LED to the OH/Fan Fail connection on pins 7 and 8 of JF1 to provide advanced warnings of chassis overheating or fan failure. Refer to the table on the right for pin definitions.

OH/Fan Fail LED Pin Definitions (JF1)	
Pin#	Definition
7	Vcc
8	Ground

OH/Fan Fail Indicator Status	
State	Definition
Off	Normal
On	Overheat
Flash-ing	Fan Fail

Power Fail LED

The Power Fail LED connection is located on pins 5 and 6 of JF1. Refer to the table on the right for pin definitions.

PWR Fail LED Pin Definitions (JF1)	
Pin#	Definition
5	Vcc
6	Ground

A. OH/Fan Fail LED

B. PWR Supply Fail

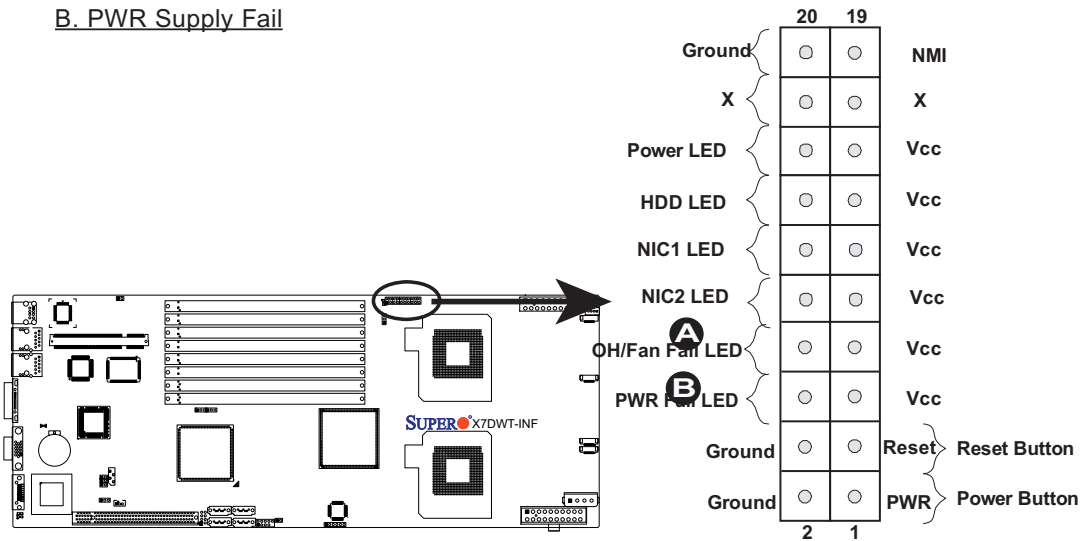

Reset Button

The Reset Button connection is located on pins 3 and 4 of JF1. Attach it to the hardware reset switch on the computer case. Refer to the table on the right for pin definitions.

Reset Button Pin Definitions (JF1)	
Pin#	Definition
3	Reset
4	Ground

Power Button

The Power Button connection is located on pins 1 and 2 of JF1. Momentarily contacting both pins will power on/off the system. This button can also be configured to function as a suspend button (with a setting in BIOS - see Chapter 4). To turn off the power when set to suspend mode, press the button for at least 4 seconds. Refer to the table on the right for pin definitions.

Power Button Pin Definitions (JF1)	
Pin#	Definition
1	Signal
2	+3V Standby

A. Reset Button

B. PWR Button

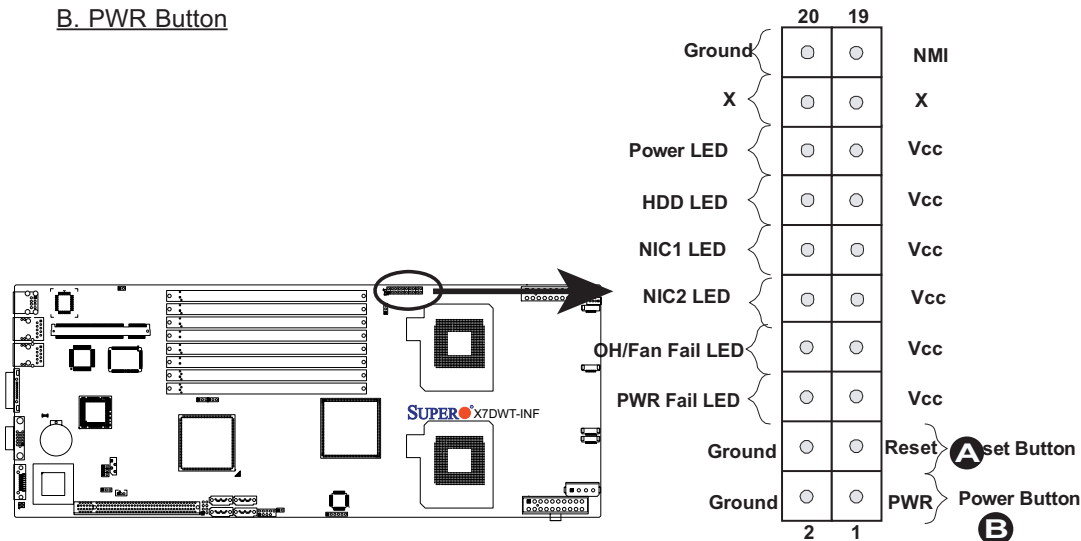

2-5 Connecting Cables

20-pin Proprietary Power Connectors

There are two 20-pin main power supply connectors (JWR1, JWR2) and a 4-pin auxiliary power connector (JP10) on the motherboard. These power connectors meet the SSI EPS 12V specification. For power supply to work properly, please follow the instructions given below. See the table on the right for pin definitions. Also refer to the layout below for the PWR connector locations.

ATX Power 20-pin Connector Pin Definitions			
Pin#	Definition	Pin #	Definition
11	PS On	1	Ground
12	5VSB	2	Ground
13	Ground	3	Ground
14	Ground	4	Ground
15	Ground	5	Ground
16	NC2	6	NC1
17	12V	7	12V
18	12V	8	12V
19	12V	9	12V
20	12V	10	12V

Note 1: You cannot use both 20-pin power connectors located at JWR1 (the right side connector) and JWR2 (the left side connector) as input power supply connectors at the same time. Only one connector can be used for input power supply to the motherboard at a time. For proper use of these proprietary PWR Connectors, please customize your PWR cables based on the SMC PWR Connector Pin-Out Definitions listed above.

Note 2: The black square (dot) on a power connector indicates the location of Pin 1. (See the pictures below for the power cable connections.)

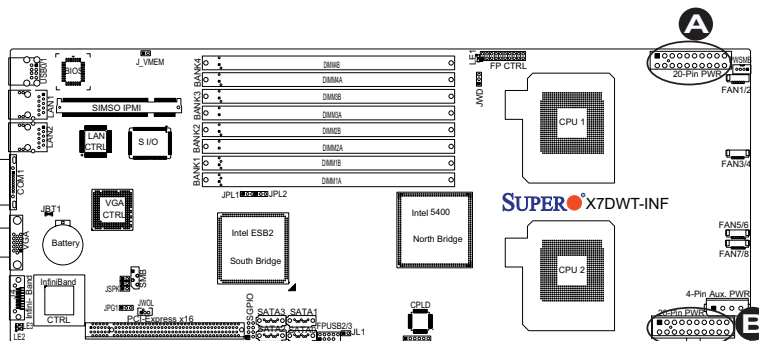
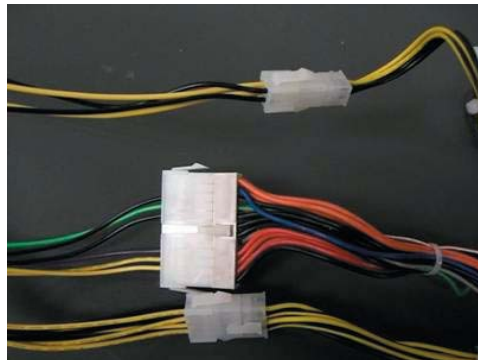
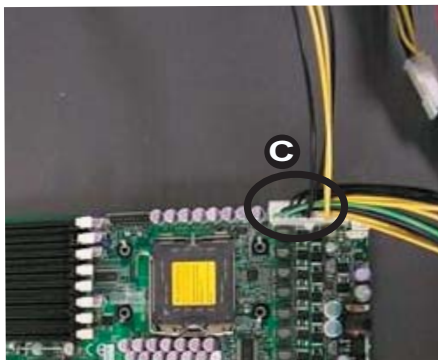

- A. The right side 20-pin PWR connector: (JWR1)
- B. The left side 20-pin PWR connector: (JWR2)
- C. 20-pin PWR Cable

4-pin Auxiliary Power Connector

In addition to two 20-pin power connectors, a 4-pin 12V PWR supply is located at JP10 on the motherboard. This power connector is used to provide power supply to hard drive disks. Refer to the layout below for the location.

Note1: The 4-pin Auxiliary Power Connector is used for power supply output to the HDDs only.

Note 2: The black square (dot) on the power connector indicates the location of Pin 1. (See the pictures below for the power cable connections.)

4-Pin Power Pin Definitions	
Pin #	Definition
1	+12V
2	Ground
3	Ground
5	+5V

Required Connection

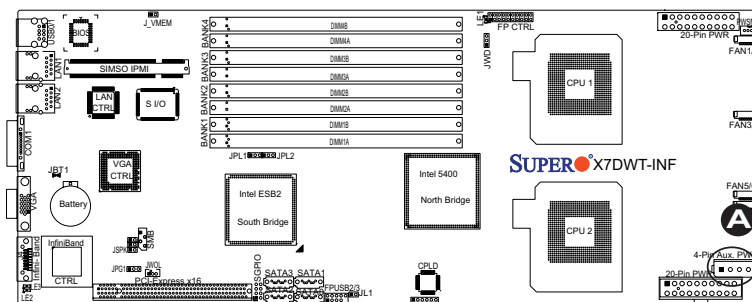
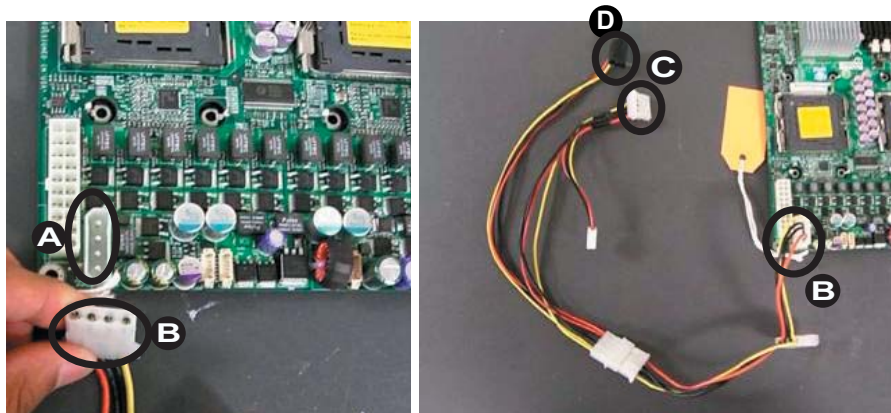

- A. 4-pin Aux. PWR
- B. One Male (Receptacle) PWR Connector
- C. & D. Two Female PWR Connectors

Universal Serial Bus (USB)

There are four USB 2.0 (Universal Serial Bus) ports on the motherboard. Two of them are Back Panel USB ports (JUSB1: USB#0/1), and the other two are front panel accessible USB headers (JUSB2: USB#2/3). See the tables on the right for pin definitions.

Back Panel USB (USB0/1)	
Pin#	Definitions
1	+5V
2	PO-
3	PO+
4	Ground
5	N/A

Front Panel USB (USB2/3)	
Pin#	Definition
1	Vcc
2	Data-
3	Data+
4	Ground
5	NA

Chassis Intrusion

A Chassis Intrusion header (JL1) is located on the motherboard. Attach an appropriate cable from the chassis to inform you of a chassis intrusion when the chassis is opened.

Chassis Intrusion Pin Definitions (JL1)	
Pin#	Definition
1	Intrusion Input
2	Ground

- A. Backpanel USB 0-1
- B. Front Panel USB 2-3
- C. Chassis Intrusion

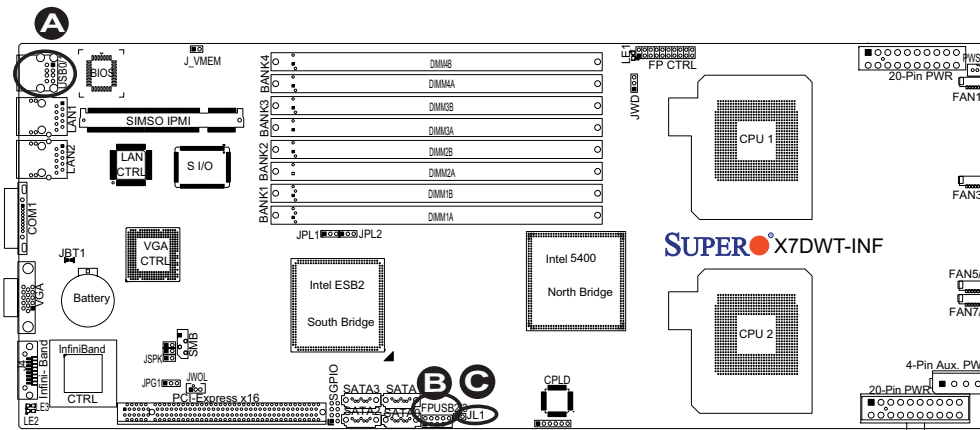

Fan Headers

The X7DWT/X7DWT-INF has four 6-pin proprietary fan headers. Each fan header supports two 3-pin fans. See the table on the right for pin definitions.

Note 1: The onboard fan speed is controlled by the CPU die temperature.

Note 2: The white dot on each fan header indicates the location of Pin 1.

Fan Header Pin Definitions			
Pin #	Definition	Pin #	Definition
1	PWR (DC Speed CTRL)	4	Ground
2	Tachometer for Fan 1,3 or 5	5	Tachometer for Fan 2,4 or 6
3	Ground	6	PWR (DC Speed CTRL)

Serial Port

A serial port connector (COM 1) is located on the Backpanel. See the table on the right for pin definitions.

Serial Port Pin Definitions			
Pin #	Definition	Pin #	Definition
1	CD	6	DSR
2	RD	7	RTS
3	TD	8	CTS
4	DTR	9	RI
5	Ground	10	NC

- A. Fans 12
- B. Fan 3/4
- C. Fan 5/6
- D. Fan 7/8
- E. COM 2 Port

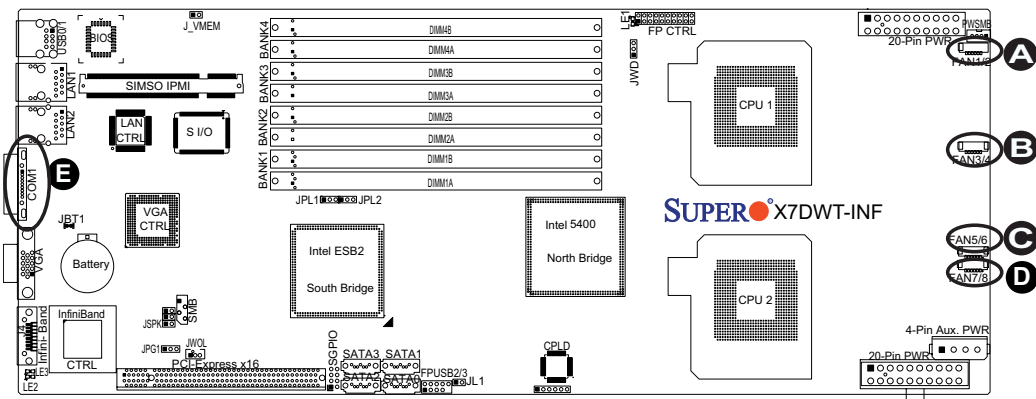

Power SMB (I²C) Connector

Power SMB (I²C) Connector (J17) monitors the status of the power supply, fan speed, and system temperature. See the table on the right for pin definitions.

PWR SMB Pin Definitions	
Pin#	Definition
1	Clock
2	Data
3	PWR Fail
4	Ground
5	+3.3V

Wake-On-LAN

The Wake-On-LAN header is located at JWOL on the motherboard. See the table on the right for pin definitions. (You must also have a LAN card with a Wake-On-LAN connector and cable to use this feature.)

Wake-On-LAN Pin Definitions	
Pin#	Definition
1	+5V Standby
2	Ground
3	Wake-up

A. PWR SMB

B. Wake-on-LAN

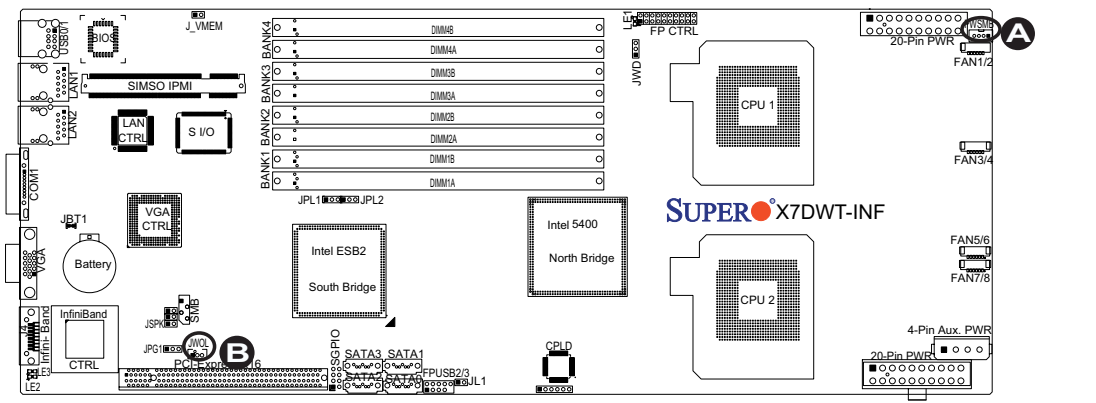

GLAN 1/2 (Giga-bit Ethernet) Ports

Two G-bit Ethernet ports are located on the IO backplane. These ports accept RJ45 type cables.



SGPIO Header

A SGPIO (Serial General Purpose Input/Output) header is located at J29 on the motherboard. This header supports serial link interfaces for the onboard SATA connectors. See the table on the right for pin definitions. Refer to the board layout below for the location.

SGPIO Pin Definitions			
Pin#	Definition	Pin	Definition
2	NC	1	NC
4	SATA_SB_SDATAOUT0	3	GND
6	GND	5	SATA_SB_SLOAD
8	NC	7	SATA_SB_Clock

Note: NC= No Connections

- A. GLAN 1
- B. GLAN 2
- C. SGPIO

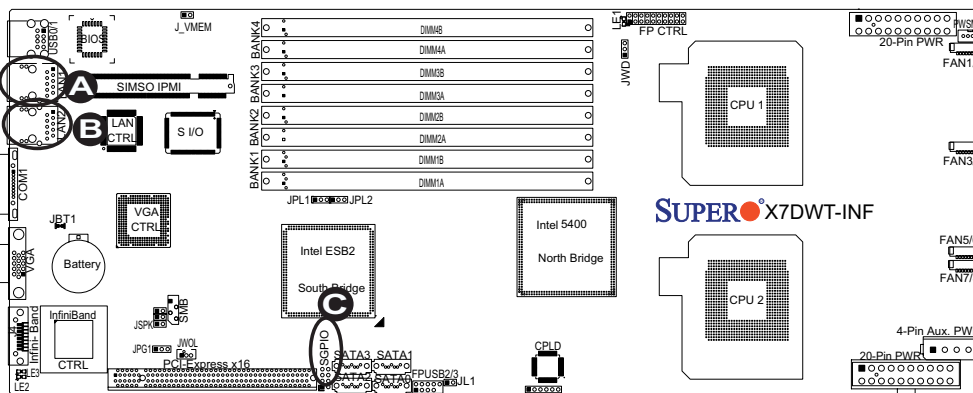

Speaker

The Speaker header is located at JSPK on the motherboard. See the table on the right for pin definitions.

Speaker Pin Definitions	
Pin#	Definition
1	-
2	+

A. Speaker

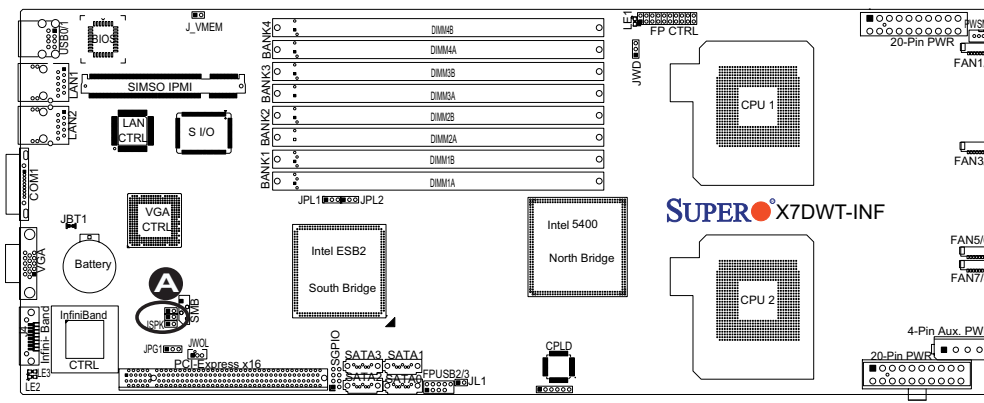

2-6 Jumper Settings

Explanation of Jumpers

To modify the operation of the motherboard, jumpers can be used to choose between optional settings. Jumpers create shorts between two pins to change the function of the connector. Pin 1 is identified with a square solder pad on the printed circuit board. See the motherboard layout pages for jumper locations.

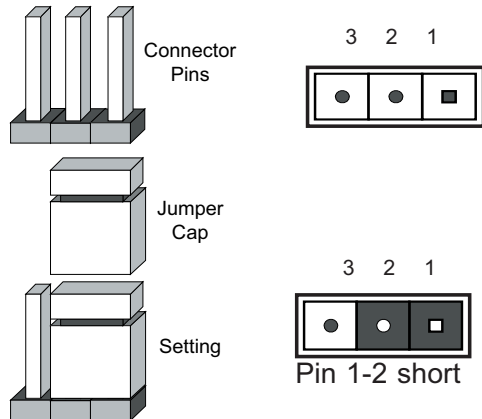

Note: On two pin jumpers, "Closed" means the jumper is on and "Open" means the jumper is off the pins.

GLAN Enable/Disable

JPL1/JPL2 enable or disable GLAN Port1/GLAN Port2 on the motherboard. See the table on the right for jumper settings. The default setting is **Enabled**.

GLAN Enable Jumper Settings	
Pin#	Definition
Open	Enabled (default)
2-3	Disabled

A. GLAN Port1 Enable

B. GLAN Port2 Enable

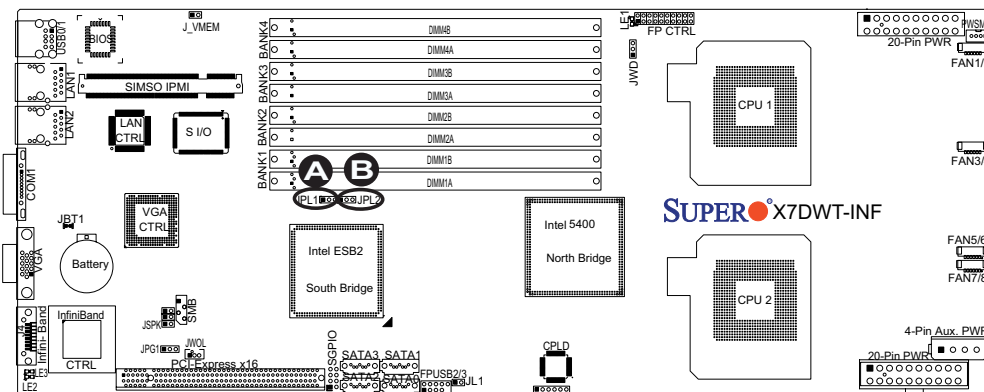

CMOS Clear

JBT1 is used to clear CMOS. Instead of pins, this "jumper" consists of contact pads to prevent the accidental clearing of CMOS. To clear CMOS, use a metal object such as a small screwdriver to touch both pads at the same time to short the connection. Always remove the AC power cord from the system before clearing CMOS. **Note:** You must completely shut down the system, remove the AC power cord and then short JBT1 to clear CMOS.



Watch Dog Enable/Disable

Watch Dog is a system monitor that can reboot the system when a software application hangs. Close pins 1-2 to reset the system if an application hangs. Close pins 2-3 to generate a non-maskable interrupt signal for the application that hangs. See the table on the right for jumper settings. Watch Dog must also be enabled in the BIOS.

Watch Dog Jumper Settings (JWD)	
Jumper Setting	Definition
Pins 1-2	Reset (default)
Pins 2-3	NMI
Open	Disabled

- A. Clear CMOS
- B. Watch Dog Enable

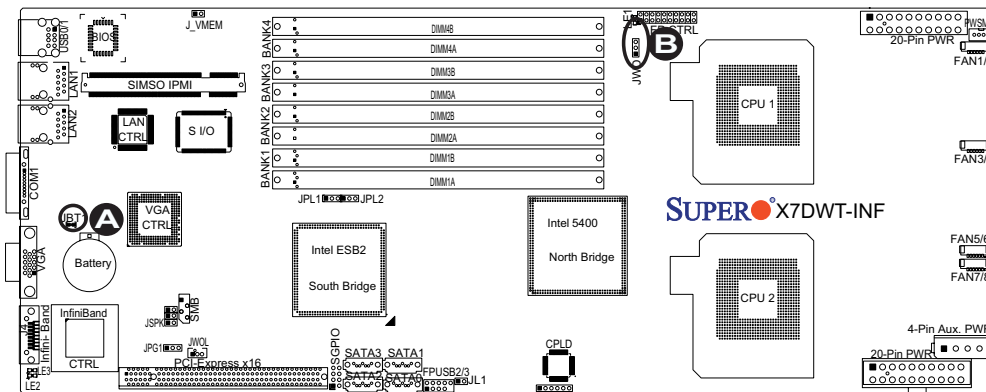

VGA Enable/Disable

JPG1 allows you to enable or disable the VGA port. The default position is on pins 1 and 2 to enable VGA. See the table on the right for jumper settings.

VGA Enable/Disable Jumper Settings	
Both Jumpers	Definition
Pins 1-2	Enabled
Pins 2-3	Disabled

A. VGA Enabled

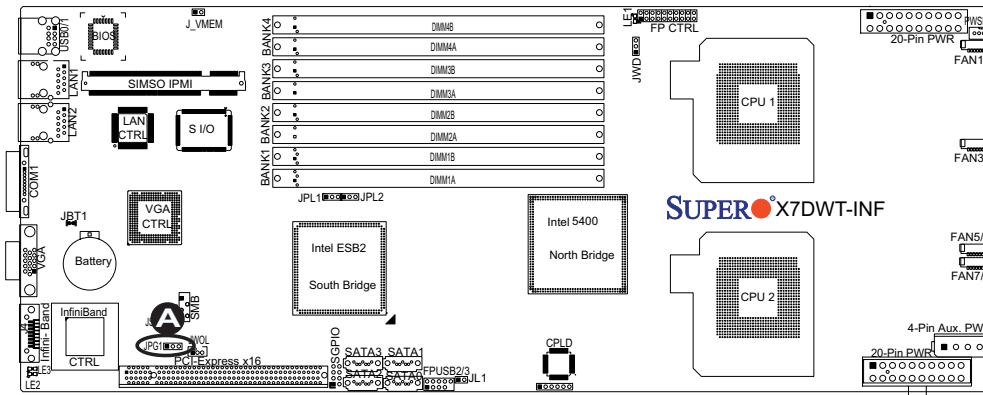

2-7 Onboard Indicators

GLAN LEDs

There are two GLAN ports on the motherboard. Each Gigabit Ethernet LAN port has two LEDs. The yellow LED indicates activity, while Link LED may be green, amber or off to indicate the speed of the connection. See the tables at right for more information.

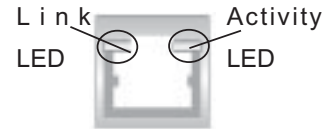

Rear View: (When viewing it from the rear side of the system)

GLAN Activity Indicator Settings		
Color	Status	Definition
Yellow	Flashing	Active

GLAN Link LED Indicator Settings	
LED Color	Definition
Off	No Connection or 10 Mbps
Green	100 Mbps
Amber	1 Gbps

Onboard Power LED (LE1)

There is an Onboard Power LED (LE1) located on the motherboard. When the green light is on or flashing, the power is connected. Unplug the power cable before removing and changing any components. See the layout below for the LED location.

Onboard PWR LED Indicator (LE1) Settings	
LED Color	Definition
Green (Solid)	Power On, System On
Green (Flashing)	Power Standby: power cable connected, System: Off
Off	Power: Off, power cable: not connected

- A. GLAN Port1 LEDs
- B. GLAN Port2 LEDs
- C. Onboard PWR LED

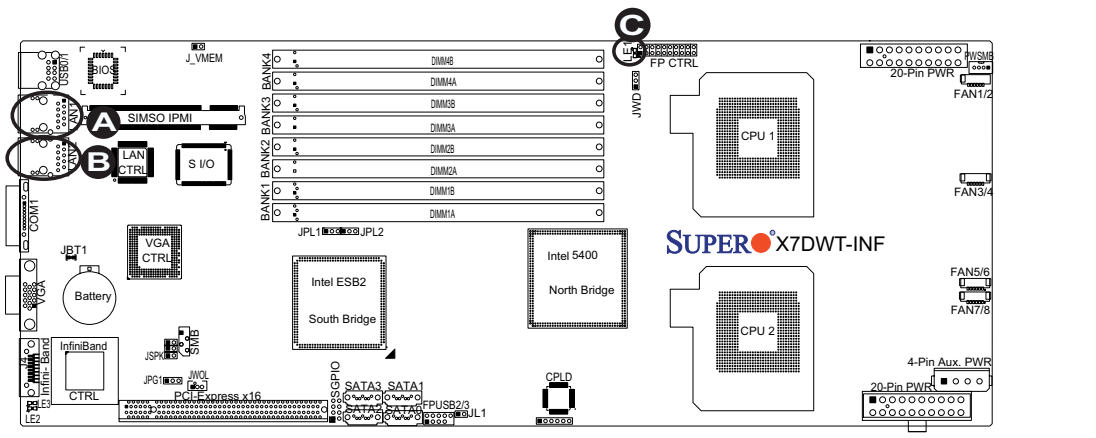

InfiniBand LED Indicators (LE2/LE3)

Two InfiniBand LED Indicators (LE2/LE3) are located on the motherboard. The green LED (LE2) is the InfiniBand Link LED; while the yellow LED (LE3) indicates activity. Refer to the table on the right for details. Also see the layout below for the LED locations.

InfiniBand Link LED (LE2) Settings		
Color	Status	Definition
Green	Solid	InfiniBand Connected
Off	Off	No connection

InfiniBand Activity LED (LE3) Settings		
Color	Status	Definition
Yellow	Solid	InfiniBand: Active
Yellow	Dim	InfiniBand: Connected, Activity: Idle
Off	Off	No connection

A. LE2 (IB Link LED)

B. LE3 (IB Activity LED)

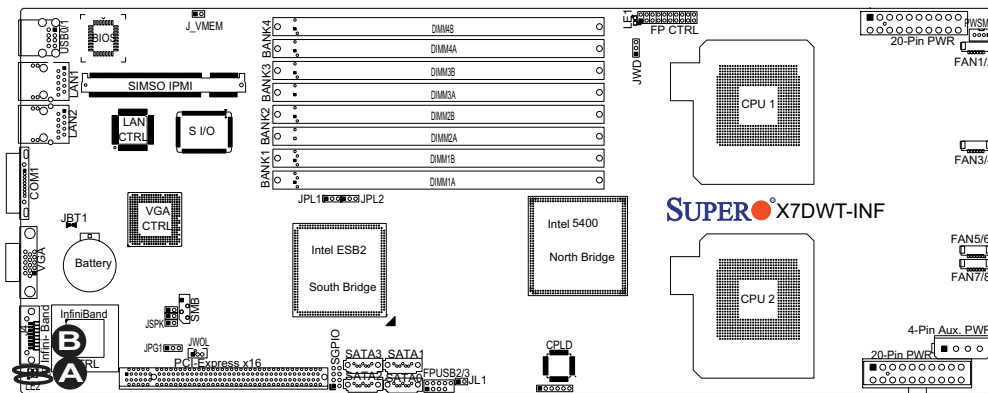

2-8 SIMSO IPMI and InfiniBand Connections

SIMSO IPMI Slot

There is a SIMSO IPMI (Intelligent Power Management Interfacing) Slot on the motherboard. Refer to the layout below for the IPMI Slot location.

InfiniBand Connector

An InfiniBand Connector is located at J4 on the motherboard. Refer to the layout below for the InfiniBand Connector location.

A. SIMSO IPMI

B. InfiniBand Connector

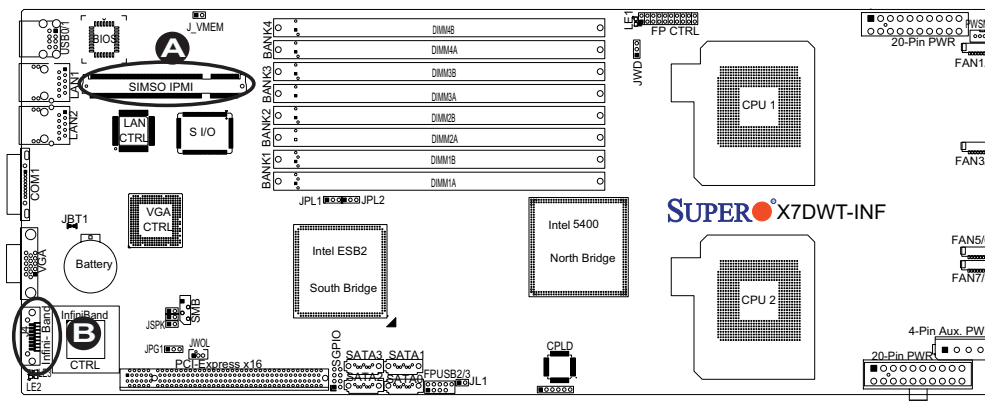

Notes

Chapter 3

Troubleshooting

3-1 Troubleshooting Procedures

Use the following procedures to troubleshoot your system. If you have followed all of the procedures below and still need assistance, refer to the 'Technical Support Procedures' and/or 'Returning Merchandise for Service' section(s) in this chapter.

Note: Always disconnect the power cord before adding, changing or installing any hardware components.

Before Power On

1. Make sure that there are no short circuits between the motherboard and chassis.
2. Disconnect all ribbon/wire cables from the motherboard, including those for the keyboard and mouse.
3. Remove all add-on cards.
4. Install one CPU at a time (making sure it is fully seated) and connect the chassis speaker and the power LED to the motherboard. (Check all jumper settings as well.)

No Power

1. Make sure that there are no short circuits between the motherboard and the chassis.
2. Make sure that all jumpers are set to their default positions.
3. Make sure that the 115V/230V switch on the power supply is properly set.
4. Turn the power switch on and off to test the system.
5. The battery on your motherboard may be old. Check to verify that it still supplies ~3VDC. If it does not, replace it with a new one.

No Video

1. If the power is on but you have no video, remove all the add-on cards and cables.
2. Use the speaker to determine if any beep codes exist. Refer to Appendix A and Appendix B for details on beep codes.

Losing the System's Setup Configuration

1. Make sure that you are using a high quality power supply. A poor quality power supply may cause the system to lose the CMOS setup information. Refer to Section 1-6 for details on recommended power supplies.

2. The battery on your motherboard may be old. Check to make sure that it still supplies ~3VDC. If it does not, replace it with a new one.
3. If the above steps do not fix the Setup Configuration problem, contact your vendor for repairs.

NOTE

If you are a system integrator, VAR or OEM, a POST diagnostics card is recommended. For I/O port 80h codes, refer to App. B.

Memory Errors

1. Make sure that the DIMM modules are properly and fully installed.
2. Check if different speeds of DIMMs have been installed and verify that the BIOS setup is configured for the fastest speed of RAM used. It is recommended to use the same RAM speed for all DIMMs in the system.
3. Make sure you are using the correct type of DDR2 FBD (Fully Buffered) ECC 800/667/533 SDRAM (recommended by the manufacturer.)
4. Check for bad DIMM modules or slots by swapping a single module between four slots and noting the results.
5. Make sure all memory modules are fully seated in their slots. As the interleaved memory scheme is used, you must install two modules at a time, beginning with Bank 1, then Bank 2, and so on (see Section 2-3).
6. Check the position of the 115V/230V switch on the power supply.

3-2 Technical Support Procedures

Before contacting Technical Support, please take the following steps. Also, please note that as a motherboard manufacturer, Super Micro does not sell directly to end-users, so it is best to first check with your distributor or reseller for troubleshooting services. They should know of any possible problem(s) with the specific system configuration that was sold to you.

1. Please go through the 'Troubleshooting Procedures' and 'Frequently Asked Question' (FAQ) sections in this chapter or see the FAQs on our web site (<http://www.supermicro.com/support/faqs/>) before contacting Technical Support.
2. BIOS upgrades can be downloaded from our web site at (<http://www.supermicro.com/support/bios/>).

Note: *Not all BIOS can be flashed; it depends on the modifications to the boot block code.*

3. If you still cannot resolve the problem, include the following information when contacting Supermicro for technical support:
- Motherboard model and PCB revision number
 - BIOS release date/version (this can be seen on the initial display when your system first boots up)
 - System configuration
- An example of a Technical Support form is on our web site at <http://www.supermicro.com/support/contact.cfm/>.
4. Distributors: For immediate assistance, please have your account number ready when placing a call to our technical support department. We can be reached by e-mail at support@supermicro.com or by fax at:(408)503-8000, option 2.

3-3 Frequently Asked Questions

Question: What are the various types of memory that my motherboard can support?

Answer: The X7DWT/X7DWT-INF has eight 240-pin DIMM slots that support DDR2 FBD ECC 800/667/533 SDRAM modules. Both 1.5V and 1.8V memory modules are supported. However, do not use different memory modules with different speeds, voltages, sizes or types on the same motherboard. (See Page 2-6 for detailed Information.)

Question: How do I update my BIOS?

Answer: It is recommended that you **do not** upgrade your BIOS if you are experiencing no problems with your system. Updated BIOS files are located in our web site at <http://www.supermicro.com/support/bios/>. Please check our BIOS warning message and the information on how to update your BIOS on our web site. Also, check the current BIOS revision and make sure it is newer than your BIOS before downloading. Select your motherboard model and download the BIOS file to your computer. Unzip the BIOS files onto a bootable floppy and reboot your system. Follow the Readme.txt to continue flashing the BIOS.



(Warning: Do not shut down or reset the system while updating BIOS to prevent possible system boot failure!)

Question: What's on the CD that came with my motherboard?

Answer: The supplied compact disc has quite a few drivers and programs that will greatly enhance your system. We recommend that you review the CD and install the applications you need. Applications on the CD include chipset drivers, security and audio drivers.

3-4 Returning Merchandise for Service

A receipt or copy of your invoice marked with the date of purchase is required before any warranty service will be rendered. You can obtain service by calling your vendor for a Returned Merchandise Authorization (RMA) number. When returning to the manufacturer, the RMA number should be prominently displayed on the outside of the shipping carton, and mailed prepaid or hand-carried. Shipping and handling charges will be applied for all orders that must be mailed when service is complete.

This warranty only covers normal consumer use and does not cover damages incurred in shipping or from failure due to the alternation, misuse, abuse or improper maintenance of products.

During the warranty period, contact your distributor first for any product problems.

Chapter 4

BIOS

4-1 Introduction

This chapter describes the Phoenix BIOS™ Setup utility for the X7DWT-INF. The Phoenix ROM BIOS is stored in a flash chip and can be easily upgraded using a floppy disk-based program.

Note: Due to periodic changes to the BIOS, some settings may have been added or deleted and might not yet be recorded in this manual. Please refer to the Manual Download area of the Supermicro web site <<http://www.supermicro.com>> for any changes to the BIOS that may not be reflected in this manual.

System BIOS

The BIOS is the Basic Input Output System used in all IBM® PC, XT™, AT®, and PS/2® compatible computers. The Phoenix BIOS stores the system parameters, types of disk drives, video displays, etc. in the CMOS. The CMOS memory requires very little electrical power. When the computer is turned off, a backup battery provides power to the CMOS Logic, enabling it to retain system parameters. When the computer is powered on, the computer is configured with the values stored in the CMOS Logic by the system BIOS, which gains control at boot up.

How To Change the Configuration Data

The CMOS information that determines the system parameters may be changed by entering the BIOS Setup utility. This Setup utility can be accessed by pressing the <Delete> key at the appropriate time during system boot.

Starting the Setup Utility

Normally, the only visible POST (Power On Self Test) routine is the memory test. As the memory is being tested, press the <Delete> key to enter the main menu of the BIOS Setup utility. From the main menu, you can access the other setup screens, such as the Security and Power menus. Beginning with Section 4-3, detailed descriptions are given for each parameter setting in the Setup utility.



Warning: Do not shut down or reset the system while updating BIOS to prevent possible boot failure.

4-2 Running Setup

Default settings are in bold text unless otherwise Noted.

The BIOS setup options described in this section are selected by choosing the appropriate text from the main BIOS Setup screen. All displayed text is described in this section, although the screen display is often all you need to understand how to set the options as shown on the following page.

When you first power on the computer, the Phoenix BIOS™ is immediately activated.

While the BIOS is in control, the Setup program can be activated in one of two ways:

1. By pressing <Delete> immediately after turning the system on, or
2. When the message shown below appears briefly at the bottom of the screen during the POST (Power On Self-Test), press the <Delete> key to activate the main Setup menu:

Press the <Delete> key to enter Setup

4-3 Main BIOS Setup

All main Setup options are described in this section. The main BIOS Setup screen is displayed below.

Use the Up/Down arrow keys to move among the different settings in each menu. Use the Left/Right arrow keys to change the options for each setting.

Press the <Esc> key to exit the CMOS Setup Menu. The next section describes in detail how to navigate through the menus.

Items that use submenus are indicated with the ► icon. With the item highlighted, press the <Enter> key to access the submenu.

Main BIOS Setup Menu

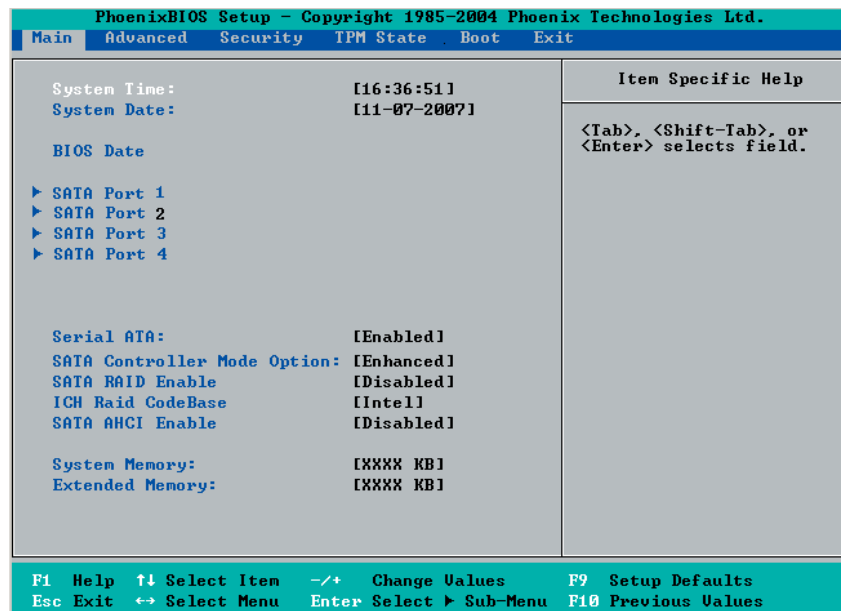

Main Setup Features

System Time

To set the system date and time, key in the correct information in the appropriate fields. Then press the <Enter> key to save the data.

System Date

Using the arrow keys, highlight the month, day and year fields, and enter the correct data. Press the <Enter> key to save the data.

BIOS Date

This field displays the date when this version of BIOS was built.

► SATA Port 1, SATA Port 2, SATA Port 3 and SATA Port 4

These settings allow the user to set the parameters of IDE Channel 0 Master/Slave, IDE Channel 1 Master/Slave, SATA Port 3, SATA Port 4 slots. Hit <Enter> to activate the following sub-menu screen for detailed options of these items. Set the correct configurations accordingly. The items included in the sub-menu are:

Type

This option allows the user to select the type of IDE hard drive. The option **Auto** will allow the BIOS to automatically configure the parameters of the HDD installed at the connection. Enter a number between 1 to 39 to select a predetermined HDD type. Select User to allow the user to enter the parameters of the HDD installed. Select CDROM if a CDROM drive is installed. Select ATAPI if a removable disk drive is installed.

Multi-Sector Transfers

This item allows the user to specify the number of sectors per block to be used in multi-sector transfer. The options are **Disabled**, 4 Sectors, 8 Sectors, and 16 Sectors.

LBA Mode Control

This item determines whether the Phoenix BIOS will access the IDE Channel 0 Master Device via the LBA mode. The options are Enabled and **Disabled**.

32 Bit I/O

This option allows the user to enable or disable the function of 32-bit data transfer. The options are Enabled and **Disabled**.

Transfer Mode

This option allows the user to set the transfer mode. The options are **Standard**, Fast PIO1, Fast PIO2, Fast PIO3, Fast PIO4, FPIO3/DMA1 and FPIO4/DMA2.

Ultra DMA Mode

This option allows the user to select Ultra DMA Mode. The options are **Disabled**, Mode 0, Mode 1, Mode 2, Mode 3, Mode 4, and Mode 5.

Serial ATA

This setting allows the user to enable or disable the function of Serial ATA. The options are Disabled and **Enabled**.

SATA Controller Mode Option

Select **Compatible** to allow the SATA and PATA drives to be automatically-detected and be placed in the Legacy Mode by the BIOS. Select Enhanced to allow the SATA and PATA drives to be to be automatically-detected and be placed in the Native IDE Mode. (**Note: The Enhanced mode is supported by the Windows 2000 OS or a later version.**)

When the SATA Controller Mode is set to "Enhanced", the following items will display:

Serial ATA (SATA) RAID Enable

Select Enable to enable Serial ATA RAID Functions. (For the Windows OS environment, use the RAID driver if this feature is set to Enabled. When this item is set to Enabled, the item: "ICH RAID Code Base" will be available for you to select either Intel or Adaptec Host RAID firmware to be activated. If SATA RAID is set to **Disabled**, the item-SATA AHCI Enable will be available.) The options are Enabled and **Disabled**.

ICH RAID Code Base

Select Intel to enable Intel's SATA RAID firmware. Select Adaptec to use Adaptec's HostRAID firmware. The options are **Intel** and Adaptec.

SATA AHCI Enable

Select Enable to enable the function of Serial ATA Advanced Host Interface. (Take caution when using this function. This feature is for advanced programmers only. The options are Enabled and **Disabled**.)

System Memory

This display informs you how much system memory is recognized as being present in the system.

Extended Memory

This display informs you how much extended memory is recognized as being present in the system.

4-4 Advanced Setup

Choose Advanced from the Phoenix BIOS Setup Utility main menu with the arrow keys. You should see the following display. The items with a triangle beside them have sub menus that can be accessed by highlighting the item and pressing <Enter>.

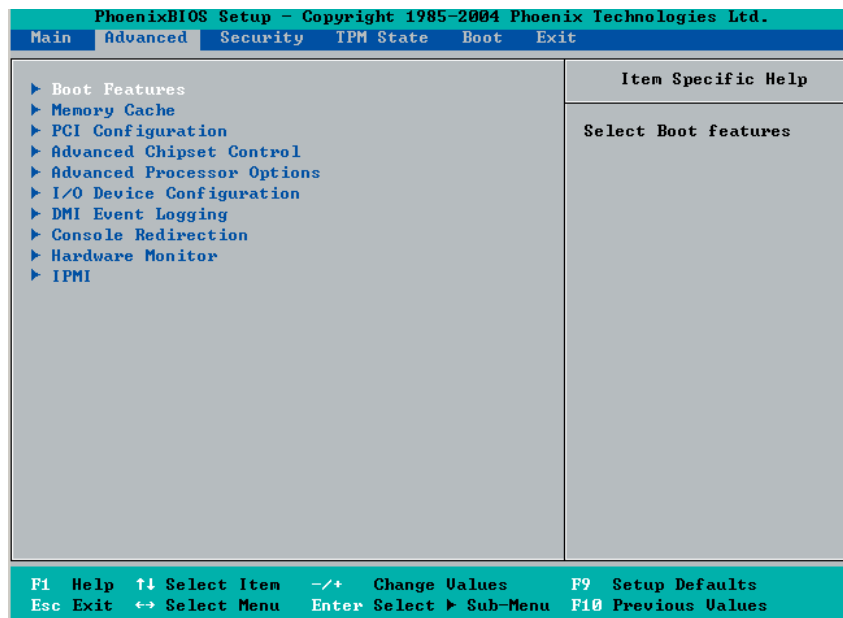

► Boot Features

Access the submenu to make changes to the following settings.

QuickBoot Mode

If enabled, this feature will speed up the POST (Power On Self Test) routine by skipping certain tests after the computer is turned on. The settings are **Enabled** and Disabled. If Disabled, the POST routine will run at normal speed.

QuietBoot Mode

This setting allows you to **Enable** or Disable the graphic logo screen during boot-up.

POST Errors

Set to **Enabled** to display POST Error Messages if an error occurs during bootup. If set to Disabled, the system will continue to boot without displaying any error message even when a boot error occurs.

ACPI Mode

Use the setting to determine if you want to employ ACPI (Advanced Configuration and Power Interface) power management on your system. The options are **Yes** and No.

Power Button Behavior

If set to **Instant-Off**, the system will power off immediately as soon as the user hits the power button. If set to 4-sec., the system will power off when the user presses the power button for 4 seconds or longer. The options are **instant-off** and 4-sec override.

Resume On Modem Ring

Select On to “wake your system up” when an incoming call is received by your modem. The options are On and **Off**.

EFI OS Boot

If enabled, this feature provides support for EFI OS booting. The options are Enabled and **Disabled**.

Keyboard On Now Function

This feature allows the user to determine how to use the keyboard to power on the system from S3~S5 States. Select Space to allow the user to power on the system by pressing the space bar. Select Password to allow the user to enter the password to power on the system. Select **Disabled** to disable this function.

Power Loss Control

This setting allows you to choose how the system will react when power returns after an unexpected loss of power. The options are Stay Off, Power On, and **Last State**.

Watch Dog

If enabled, this option will automatically reset the system if the system is not active for more than a predefined time period. The options are Enabled and **Disabled**.

Summary Screen

This setting allows you to **Enable** or Disable the summary screen which displays the system configuration during bootup.

► Memory Cache

Cache System BIOS Area

This setting allows you to designate a reserve area in the system memory to be used as a System BIOS buffer to allow the BIOS to write (cache) data into this reserved memory area. Select **Write Protect** to enable the function and reserve this area for the Video BIOS ROM access only. Select Uncached to disable this function and make this area available for other devices.

Cache Video BIOS Area

This setting allows you to designate a reserve area in the system memory to be used as a Video BIOS buffer to allow the BIOS to write (cache) data into this reserved memory area. Select **Write Protect** to enable the function and reserve this area for the Video BIOS ROM access only. Select Uncached to disable this function and make this area available for other devices.

Cache Base 0-512K

If enabled, this feature will allow the data stored in the base memory area: block 0-512K to be cached (written) into a buffer, a storage area in the Static DRAM (SDRAM) or to be written into L1, L2 cache inside the CPU to speed up CPU operations. Select Uncached to disable this function. Select Write Through to allow data to be cached into the buffer and written into the system memory at the same time. Select Write Protect to prevent data from being written into the base memory area of Block 0-512K. Select Write Back to allow the CPU to write data back directly from the buffer without writing data to the System Memory for fast CPU data processing and operation. The options are Uncached, Write Through, Write Protect, and **Write Back**.

Cache Base 512K-640K

If enabled, this feature will allow the data stored in the memory area: 512K-640K to be cached (written) into a buffer, a storage area in the Static DRAM (SDRAM) or written into L1, L2 or L3 cache inside the CPU to speed up CPU operations. Select Uncached to disable this function. Select Write Through to allow data to be cached into the buffer and written into the system memory at the same time. Select Write Protect to prevent data from being written into the base memory area of Block 512-640K. Select Write Back to allow the CPU to write data back directly from the buffer without writing data to the system memory to speed up CPU's operation. The options are Uncached, Write Through, Write Protect, and **Write Back**.

Cache Extended Memory

If enabled, this feature will allow the data stored in the extended memory area to be cached (written) into a buffer, a storage area in the Static DRAM (SDRAM) or written into L1, L2, L3 cache inside the CPU to speed up CPU operations. Select **Uncached** to disable this function. Select **Write Through** to allow data to be cached into the buffer and written into the system memory at the same time. Select **Write Protect** to prevent data from being written into the extended memory area above 1 MB. Select **Write Back** to allow the CPU to write data back directly from the buffer without writing data to the System Memory for fast CPU data processing and operation. The options are **Uncached**, **Write Through**, **Write Protect**, and **Write Back**.

Discrete MTRR Allocation

If enabled, MTRRs (-Memory Type Range Registers) are configured as distinct, separate units and cannot be overlapped. If enabled, the user can achieve better graphic effects when using a Linux graphic driver that requires the write-combining configuration with 4GB or more memory. The options are **Enabled** and **Disabled**.

► PCI Configuration

Access the submenu to make changes to the following settings for PCI devices.

Onboard GLAN1/Onboard GLAN2 (Gigabit- LAN) OPROM Configure

Select **Enabled** to allow the system to boot from the GLAN1 connection or the GLAN 2 connection. The options are **Enabled** and **Disabled**.

Onboard Storage OPROM Configure

Select **Enabled** to allow the system to boot from the IPMI 3rd-LAN connection. The options are **Disabled** and **Enabled**.

Default Primary Video Adapter

This feature allows the user to specify which video adapter to be used as the default primary video adapter--the onboard video adapter or others. The default setting is **Onboard**.

PCI Fast Delayed Transaction

Enable this function to improve the DMA data transfer rate for a PCI 32-bit multimedia card. The options are **Enable** and **Disabled**.

Reset Configuration Data

If set to **Yes**, this setting clears the Extended System Configuration Data- (ESCD) area. The options are **Yes** and **No**.

► Slot1 PCI-Exp x16

Access the submenu for each of the settings above to make changes to the following:

Option ROM Scan

When enabled, this setting will initialize the device expansion ROM. The options are **Enabled** and Disabled.

Enable Master

This setting allows you to enable the selected device as the PCI bus master. The options are **Enabled** and Disabled.

Latency Timer

This setting allows you to set the clock rate for Bus Master. A high-priority, high-throughput device may benefit from a greater clock rate. The options are **Default**, 0020h, 0040h, 0060h, 0080h, 00A0h, 00C0h, and 00E0h. For Unix, Novell and other Operating Systems, please select the option: other. If a drive fails after the installation of a new software, you might want to change this setting and try again. A different OS requires a different Bus Master clock rate.

Large Disk Access Mode

This setting determines how large hard drives are to be accessed. The options are **DOS** or Other (for Unix, Novelle NetWare and other operating systems).

► Advanced Chipset Control

Access the submenu to make changes to the following settings.



Warning: Take caution when changing the Advanced settings. An Incorrect value, a very high DRAM frequency or an incorrect DRAM timing may cause system to become unstable. When this occurs, reset the setting to the default setting.

SERR Signal Condition

This setting specifies the ECC Error conditions that an SERR# is to be asserted. The options are None, **Single Bit**, Multiple Bit, and Both.

Clock Spectrum Feature

If Enabled, the BIOS will monitor the level of Electromagnetic Interference caused by the components and will attempt to decrease the interference whenever needed. The options are Enabled and **Disabled**.

► Intel VT for Directed I/O <VT-d>

Select Enabled to bring up the following Intel VT for Directed I/O (VT-d) Configuration submenu. The options are Enabled and **Disabled**.

VT-d for Port 0 (ESI)/VT-d for Port 1/VT-d for Port 5/VT-d for Port 9/VT-d for DMI Port

Select Enabled to enable VT-d support for the port specified through DRHD Structures in the ACPI Tables. The options are Disabled and **Enabled**.

4GB PCI Hole Granularity

This feature allows you to select the granularity of PCI hole for PCI slots. If MTRRs are not enough, this option may be used to reduce MTRR occupation. The options are: **256 MB**, 512 MB, 1GB and 2GB.

Memory Branch Mode

This option determines how the two memory branches operate. System address space can either be interleaved between the two branches or Sequential from one branch to another. Mirror mode allows data correction by maintaining two copies of data in two branches. Single Channel 0 allows a single DIMM population during system manufacturing. The options are **Interleave**, Sequential, Mirroring, and Single Channel 0.

Branch 0 Rank Interleaving/Branch 1 Rank Interleaving

Select enable to enable Interleaved Memory for Memory Bus Branch 0 Rank or Branch 1 Rank. The options for Memory Interleaving are 1:1, 2:1 and **4:1**.

Branch 0 Rank Sparing/Branch 1 Rank Sparing

Select **Enable** to enable the function of memory sparing for Memory Bus Branch 0 or Branch 1. The options are Enabled and **Disabled**.

Enhanced x8 Detection

Select **Enabled** to enable Enhanced x8 DRAM UC Error Detection. The options are Disabled and **Enabled**.

Demand Scrub

Scrubbing is a process that allows the North Bridge to correct correctable memory errors found on an FBD memory module. When the CPU or I/O issues a demand-read command, and the read data from memory turns out to be a correctable ECC, it is corrected and sent to the original source. Memory is updated as well. Select Enabled to use Demand Scrubbing for ECC memory correction. The options are **Enabled** and Disabled.

High Temperature DRAM Operation

When set to Enabled, the BIOS will refer to the SPD table to set the maximum DRAM temperature. If disabled, the BIOS will set the maximum DRAM temperature based on a predefined value. The options are Enabled and **Disabled**.

AMB Thermal Sensor

Select Enabled to enable the thermal sensor embedded in the Advanced Memory Buffer on a fully buffered memory module for thermal monitoring. The options are **Disabled** and Enabled.

Thermal Throttle

Select Enabled to enable closed-loop thermal throttling on a fully buffered (FBD) memory module. In the closed-loop thermal environment, thermal throttling will be activated when the temperature of the FBD DIMM module exceeds a predefined threshold. The options are Enabled and **Disabled**.

Global Activation Throttle

Select Enabled to enable the function of open-loop global thermal throttling on the fully buffered (FBD) memory modules and allow global thermal throttling to become active when the number of activate control exceeds a predefined number. The options are Enabled and **Disabled**.

Force ITK Configuration Clocking

Select Enabled to configure FBD clock settings to support ITK testing. The options are **Disabled** and Enabled.

Reserved Branch for ITK Test

This feature allows the user to specify the memory branch number to be reserved for ITK testing. The default setting is **Branch 1**.

Snoop Filter

Select Enabled to eliminate snoop traffic to the graphics port to greatly improve system performance when running graphics intensive applications. The options are **Enabled** and Disabled.

Crystal Beach Features

Select **Enabled** to use the Intel I/O AT (Acceleration Technology) to accelerate the performance of TOE devices. (**Note:** A TOE device is a specialized, dedicated processor that is installed on an add-on card or a network card to handle some or all packet processing of this add-on card. For this motherboard, the TOE device is built inside the ESB 2 South Bridge chip.) The options are **Enabled** and Disabled.

Route Port 80h Cycles to

This feature allows the user to decide which bus to send debug information to. The options are Disabled, PCI and **LPC**.

High Precision Event Time

Select Yes to activate the High Precision Event Timer (HPET), which is capable of producing periodic interrupts at a much higher frequency than a Real-time Clock (RTC) can in synchronizing multimedia streams, providing smooth playback and reducing the dependency on other timestamp calculation devices, such as an x86 RDTSC Instruction embedded in a CPU. The High Precision Event Timer is used to replace the 8254 Programmable Interval Timer. The options for this feature are Yes and **No**.

USB Function

Select Enabled to enable the function of USB devices specified. The settings are **Enabled** and Disabled.

Legacy USB Support

This setting allows you to enable support for Legacy USB devices. The settings are **Enabled** and Disabled.

► Advanced Processor Options

Access the submenu to make changes to the following settings.

CPU Speed

This is a display that indicates the speed of the installed processor.

Frequency Ratio (Available when supported by the CPU)

The feature allows the user to set the internal frequency multiplier for the CPU. The options are: **Default**, x12, x13, x14, x15, x16, x17 and x18.

Core-Multi-Processing

Set to Enabled to use a processor's Second Core and beyond. (Please refer to Intel's web site for more information.) The options are Disabled and **Enabled**.

Machine Checking (Available when supported by the CPU)

Set to Enabled to activate the function of Machine Checking and allow the CPU to detect and report hardware (machine) errors via a set of model-specific registers (MSRs). The options are Disabled and **Enabled**.

Fast String Operations (Available when supported by the CPU)

Set to **Enabled** to enable the fast string operations for special CPU instructions. The options are Disabled and **Enabled**.

Thermal Management 2 (Available when supported by the CPU)

Set to **Enabled** to use Thermal Management 2 (TM2) which will lower CPU voltage and frequency when the CPU temperature reaches a predefined overheat threshold. Set to Disabled to use Thermal Manager 1 (TM1), allowing CPU clocking to be regulated via CPU Internal Clock modulation when the CPU temperature reaches the overheat threshold.

C1/C2 Enhanced Mode (Available when supported by the CPU)

Set to Enabled to enable Enhanced Halt State to lower CPU voltage/frequency to prevent overheat. The options are Enabled and **Disabled**. (**Note:** please refer to Intel's web site for detailed information.)

Execute Disable Bit (Available if supported by the CPU and the OS)

Set to Enabled to enable Execute Disable Bit and allow the processor to classify areas in memory where an application code can execute and where it cannot, and thus preventing a worm or a virus from inserting and creating a flood of codes to overwhelm the processor or damage the system during an attack. **Note:** this feature is available when your OS and your CPU support the function of Execute Disable Bit. The options are **Disabled** and Enabled. For more information, please refer to Intel's and Microsoft's web sites.

Adjacent Cache Line Prefetch (Available if supported by the CPU)

The CPU fetches the cache line for 64 bytes if this option is set to Disabled. The CPU fetches both cache lines for 128 bytes as comprised if Enabled. The options are Disabled and **Enabled**.

Hardware Prefetch (Available if supported by the CPU)

Set to this option to **Enabled** to enable the hardware components that are used in conjunction with software programs to prefetch data in order to speed up data processing. The options are Disabled and **Enabled**.

Set Maximum Ext. CPUID=3

When set to Enabled, the Maximum Extended CPUID will be set to 3. The options are **Disabled** and Enabled.

Direct Cache Access (Available if supported by the CPU)

Set to Enable to route inbound network IO traffic directly into processor caches to reduce memory latency and improve network performance. The options are **Disabled** and Enabled.

DCA Delay Clocks (Available when supported by the CPU)

This feature allows the user to set the clock delay setting from snoop to prefetch for Direct Cache Access. Select a setting from 8 (bus cycles) to 120 (bus cycles) (in 8-cycle increment). The default setting is **32 (bus cycles)**.

Intel <R> Virtualization Technology (Available when supported by the CPU)

Select Enabled to use the feature of Virtualization Technology to allow one platform to run multiple operating systems and applications in independent partitions, creating multiple "virtual" systems in one physical computer. The options are Enabled and **Disabled**. (Note: If there is any change to this setting, you will need to power off and restart the system for the change to take effect.) Please refer to Intel's web site for detailed information.

Intel EIST Support (Available when supported by the CPU)

Select Enabled to use the Enhanced Intel SpeedStep Technology and allows the system to automatically adjust processor voltage and core frequency in an effort to reduce power consumption and heat dissipation. The options are Enabled and **Disabled**. Please refer to Intel's web site for detailed information.

► I/O Device Configuration

Access the submenu to make changes to the following settings.

KBC Clock Input

This setting allows you to select clock frequency for KBC. The options are 6MHz, 8MHz, **12MHz**, and 16MHz.

Serial Port A

This setting allows you to assign control of serial port A. The options are **Enabled** (user defined), Disabled, and Auto (BIOS- or OS- controlled).

Base I/O Address

This setting allows you to select the base I/O address for serial port A. The options are **3F8**, 2F8, 3E8, and 2E8.

Interrupt

This setting allows you to select the IRQ (interrupt request) for serial port A. The options are IRQ3 and **IRQ4**.

Serial Port B

This setting allows you to assign control of serial port B. The options are Enabled (user defined), **Disabled**, Auto (BIOS- and OS- Controlled).

Mode

This setting allows you to set the type of device that will be connected to serial port B. The options are **Normal** and IR (for an infrared device).

Base I/O Address

This setting allows you to select the base I/O address for serial port B. The options are 3F8, **2F8**, 3E8 and 2E8.

Interrupt

This setting allows you to select the IRQ (interrupt request) for serial port B. The options are **IRQ3** and IRQ4.

► DMI Event Logging

Access the submenu to make changes to the following settings.

Event Log Validity

This is a display to inform you of the event log validity. It is not a setting.

Event Log Capacity

This is a display to inform you of the event log capacity. It is not a setting.

View DMI Event Log

Highlight this item and press <Enter> to view the contents of the event log.

Event Logging

This setting allows you to **Enable** or Disable event logging.

ECC Event Logging

This setting allows you to **Enable** or Disable ECC event logging.

Mark DMI Events as Read

Highlight this item and press <Enter> to mark the DMI events as read.

Clear All DMI Event Logs

Select Yes and press <Enter> to clear all DMI event logs. The options are Yes and **No**.

► Console Redirection

Access the submenu to make changes to the following settings.

COM Port Address

This item allows you to specify which COM port to direct the remote console to: Onboard COM A or Onboard COM B. This setting can also be **Disabled**.

BAUD Rate

This item allows you to set the BAUD rate for console redirection. The options are 300, 1200, 2400, 9600, **19.2K**, 38.4K, 57.6K, and 115.2K.

Console Type

This item allows you to set console redirection type. The options are VT100, VT100,8bit, PC-ANSI, 7bit, **PC ANSI**, VT100+, VT-UTF8 and ASCII.

Flow Control

This item allows you to select the flow control option for the console. The options are: None, XON/XOFF, and **CTS/RTS**.

Console Connection

This item allows you to decide how console redirection is to be connected: either **Direct** or Via Modem.

Continue CR after POST

Select on to continue with console redirection after the POST routine. The options are On and **Off**.

► Hardware Monitor Logic

CPU Temperature Threshold

This feature displays a predefined CPU overheating temperature threshold that will activate the alarm when the CPU temperature reaches this overheating threshold. The options are 70°C, **75°C**, 80°C and 85°C.

Highlight this and hit <Enter> to see monitor data for the following items:

CPU1 Temperature/CPU1 Second Core

CPU2 Temperature/CPU2 Second Core

System Temperature

Fan1-Fan8 Speeds: If the feature of Auto Fan Control is enabled, the BIOS will automatically display the status of the fans indicated in this item.

Fan Speed Control Modes

This feature allows the user to decide how the system controls the speeds of the onboard fans. The CPU temperature and the fan speed are correlative. When the CPU on-die temperature increases, the fan speed will also increase, and vice versa. Select Workstation if your system is used as a Workstation. Select Server if your system is used as a Server. Select 3-pin if your chassis uses 3-pin fans. Select 4-pin if your chassis uses 4-pin fans. Select "Disable" to disable the fan speed control function and allow the onboard fans to constantly run at the full speed (12V). The Options are: **1. Disable**, 2. Optimized Server w/3-pin, 3. Optimized Workstation w/3-pin, 4. Optimized Server w/4-pin, 5. Optimized Workstation w/4-pin, 6. 4-pin Quite Mode, and 7. 4-pin Super Quite Mode.

Voltage Monitoring

The following items will be monitored and displayed:

VcoreA/VcoreB

+12V/-12V

+5Vsb/+5VDD

+3.3V

P1V5/P_VTT/Vbat

Note: In the Windows OS environment, the Supero Doctor III settings take precedence over the BIOS settings. When first installed, Supero Doctor III adopts the temperature threshold settings previously set in the BIOS. Any subsequent changes to these thresholds must be made within Supero Doctor, since the SD III settings override the BIOS settings. For the Windows OS to adopt the BIOS temperature threshold settings, please change the SDIII settings to be the same as those set in the BIOS.

► **IPMI (The option is available only when an IPMI card is installed in the system.)**

PhoenixBIOS Setup Utility		Item Specific Help
Advanced		
IPMI		
IPMI Specification Version	2.0	Enable/Disable IPMI event logging. Disabling will still log events received via the system interface.
Firmware Version	2.1	
System Event Logging	[Enabled]	
Clear System Event Log	[Disabled]	
Existing Event Log number	282	
Event Log Control		
SYS Firmware Progress	[Disabled]	
BIOS POST Errors	[Enabled]	
BIOS POST Watchdog	[Disabled]	
OS boot Watchdog	[Disabled]	
Timer for loading OS (min)	[10]	
Time out action	[No Action]	

IPMI Specification Version: This item displays the current IPMI Version.

Firmware Version: This item displays the current Firmware Version.

System Event Logging

Select Enabled to enable IPMI Event Logging. When this function is set to Disabled, the system will continue to log events received via system interface. The options are **Enabled** and **Disabled**.

Clear System Event Logging

Enabling this function to force the BIOS to clear the system event logs during the next cold boot. The options are **Enabled** and **Disabled**.

Existing Event Log Number

This item displays the number of the existing event log.

Event Log Control

System Firmware Progress

Enabling this function to log POST progress. The options are **Enabled** and **Disabled**.

BIOS POST Errors

Enabling this function to log POST errors. The options are **Enabled** and **Disabled**.

BIOS POST Watch Dog

Set to **Enabled** to enable POST Watch Dog. The options are **Enabled** and **Disabled**.

OS Boot Watch Dog

Set to Enabled to enable OS Boot Watch Dog. The options are Enabled and Disabled.

Timer for Loading OS (Minutes)

This feature allows the user to set the time value (in minutes) for the previous item: OS Boot Watch Dog by keying-in a desired number in the blank. The default setting is 10 (minutes.) (Please ignore this option when OS Boot Watch Dog is set to "Disabled".)

Time Out Option

This feature allows the user to determine what action to take in an event of a system boot failure. The options are **No Action**, Reset, Power Off and Power Cycles.

► System Event Log/System Event Log (List Mode)

These options display the System Event (SEL) Log and System Event (SEL) Log in List Mode. Items include: SEL (System Event Log) Entry Number, SEL Record ID, SEL Record Type, Time Stamp, Generator ID, SEL Message Revision, Sensor Type, Sensor Number, SEL Event Type, Event Description, and SEL Event Data.

```

System Event Log

SEL Entry Number = 1
SEL Record ID = 0001
SEL Record Type = 02 - System Event Record
Timestamp = 02.10.2006 17:11:23
Generator Id = 20 00
SEL Message Rev = 04
Sensor Type = 02 - Voltage
Sensor Number = 0A - -12V
SEL Event Type = 01 - Threshold
Event Description = Lower Non-critical Going Low, Assertion
SEL Event Data = 50 06 0E

F1 Help ↑ Select Item -/+ Change Values F9 Setup Defaults
Esc Exit + Select Menu Enter Select ▶ Sub-Menu F10 Save and Exit
    
```

► Realtime Sensor Data

This feature displays information from motherboard sensors, such as temperatures, fan speeds and voltages of various components.

Realtime Sensor Data					
Sensor Type	Sensor Name	Sensor Data	Sensor Units	Lower Limit	Upper Limit
Temp					
	CPU1 CoreA	48.00	degrees C	0.00	75.00
	CPU1 CoreB	54.00	degrees C	0.00	75.00
	CPU2 CoreA	47.00	degrees C	0.00	75.00
	CPU2 CoreB	46.00	degrees C	0.00	75.00
	System	44.00	degrees C	0.00	75.00
Voltage					
	CPU1 Core	1.13	Volts	0.97	1.47
	CPU2 Core	1.16	Volts	0.97	1.47
	3.3V	3.30	Volts	2.95	3.62

F1	Help	↑	Select Item	-/+	Change Values	F9	Setup Defaults
Esc	Exit	+	Select Menu	Enter	Select ► Sub-Menu	F10	Save and Exit

4-5 Security

Choose Security from the Phoenix BIOS Setup Utility main menu with the arrow keys. You should see the following display. Security setting options are displayed by highlighting the setting using the arrow keys and pressing <Enter>. All Security BIOS settings are described in this section.

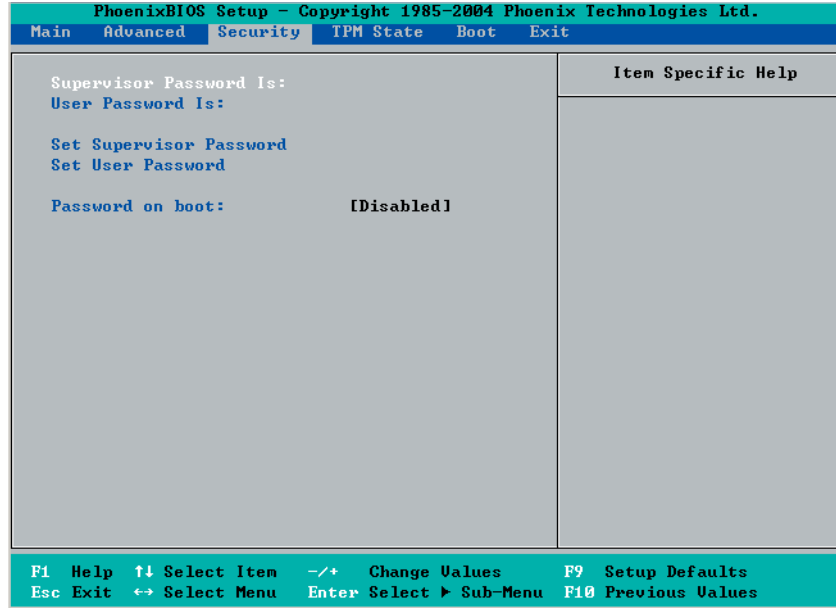

Supervisor Password Is:

This feature indicates if a supervisor password has been entered to the system. Clear means such a password has not been used, and Set means a supervisor password has been entered.

User Password Is:

This feature indicates if a user password has been entered to the system. Clear means such a password has not been used, and Set means a user password has been entered.

Set Supervisor Password

When the item Set "Supervisor Password" is highlighted, hit the <Enter> key. When prompted, type the Supervisor's password in the dialogue box to set or to change supervisor's password, which allows access to the BIOS.

Set User Password

When the item "Set User Password" is highlighted, hit the <Enter> key. When prompted, type the user's password in the dialogue box to set or to change the user's password, which allows access to the system at boot-up.

Password on Boot

If set to Enabled, the user will need to enter a password to enter the system at bootup. The options are **Enabled** and Disabled (password not required).

4-6 Boot

Choose Boot from the Phoenix BIOS Setup Utility main menu with the arrow keys. You should see the following display. See details on how to change the order and specs of boot devices in the Item Specific Help window. All Boot BIOS settings are described in this section.

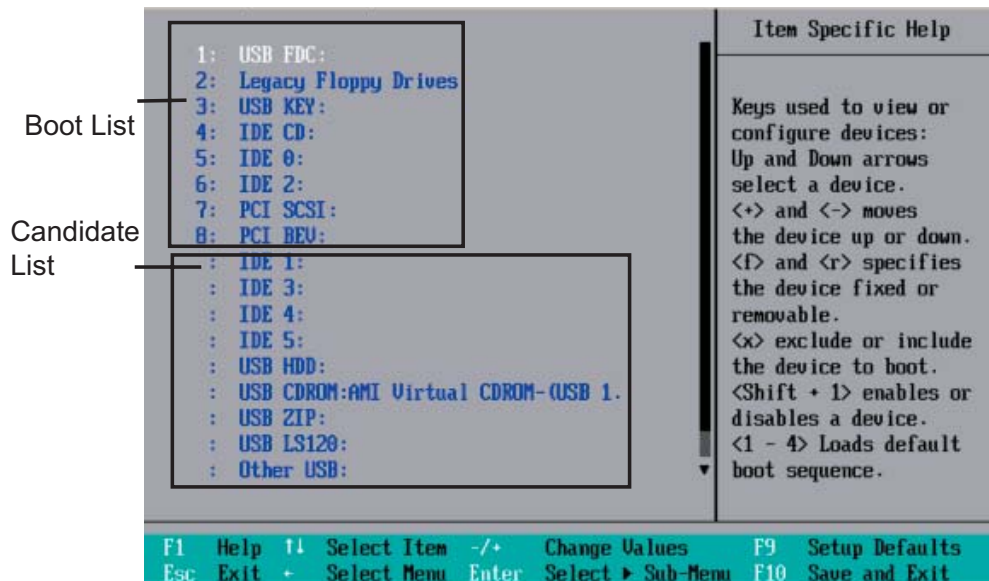

Boot Priority Order/Excluded from Boot Orders

The devices included in the boot list section (above) are bootable devices listed in the sequence of boot order as specified. The boot functions for the devices included in the candidate list (above) are currently disabled. Use a <+> key or a <-> key to move the device up or down. Use the <f> key or the <r> key to specify the type of an USB device, either fixed or removable. You can select one item from the boot list and hit the <x> key to remove it from the list of bootable devices (to make its resource available for other bootable devices). Subsequently, you can select an item from the candidate list and hit the <x> key to remove it from the candidate list and put it in the boot list. This item will then become a bootable device. See details on how to change the priority of boot order of devices in the "Item Specific Help" window.

4-7 Exit

Choose Exit from the Phoenix BIOS Setup Utility main menu with the arrow keys. You should see the following display. All Exit BIOS settings are described in this section.

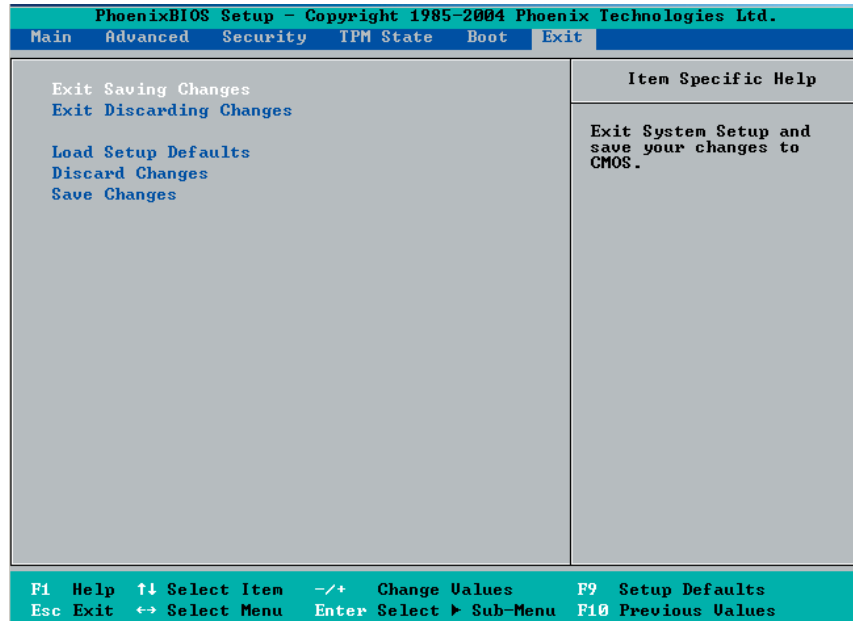

Exit Saving Changes

Highlight this item and hit <Enter> to save any changes you made and to exit the BIOS Setup utility.

Exit Discarding Changes

Highlight this item and hit <Enter> to exit the BIOS Setup utility without saving any changes you may have made.

Load Setup Defaults

Highlight this item and hit <Enter> to load the default settings for all items in the BIOS Setup. These are the safest settings to use.

Discard Changes

Highlight this item and hit <Enter> to discard (cancel) any changes you've made. You will remain in the Setup utility.

Save Changes

Highlight this item and hit <Enter> to save any changes you made. You will remain in the Setup utility.

Appendix A

BIOS POST Messages

During the Power-On Self-Test (POST), the BIOS will check for problems. If a problem is found, the BIOS will activate an alarm or display a message. The following is a list of such BIOS messages.

Failure Fixed Disk

Fixed disk is not working or not configured properly. Check to see if fixed disk is attached properly. Run Setup. Find out if the fixed-disk type is correctly identified.

Stuck key

Stuck key on keyboard.

Keyboard error

Keyboard not working.

Keyboard Controller Failed

Keyboard controller failed test. May require replacing keyboard controller.

Keyboard locked - Unlock key switch

Unlock the system to proceed.

Monitor type does not match CMOS - Run SETUP

Monitor type not correctly identified in Setup

Shadow Ram Failed at offset: nnnn

Shadow RAM failed at offset **nnnn** of the 64k block at which the error was detected.

System RAM Failed at offset: nnnn

System RAM failed at offset **nnnn** of in the 64k block at which the error was detected.

Extended RAM Failed at offset: nnnn Extended memory not working or not configured properly at offset **nnnn**.

System battery is dead - Replace and run SETUP

The CMOS clock battery indicator shows the battery is dead. Replace the battery and run Setup to reconfigure the system.

System CMOS checksum bad - Default configuration used

System CMOS has been corrupted or modified incorrectly, perhaps by an application program that changes data stored in CMOS. The BIOS installed Default Setup Values. If you do not want these values, enter Setup and enter your own values. If the error persists, check the system battery or contact your dealer.

System timer error

The timer test failed. Requires repair of system board.

Real time clock error

Real-Time Clock fails BIOS hardware test. May require board repair.

Check date and time settings

BIOS found date or time out of range and reset the Real-Time Clock. May require setting legal date (1991-2099).

Previous boot incomplete - Default configuration used

Previous POST did not complete successfully. POST loads default values and offers to run Setup. If the failure was caused by incorrect values and they are not corrected, the next boot will likely fail. On systems with control of **wait states**, improper Setup settings can also terminate POST and cause this error on the next boot. Run Setup and verify that the waitstate configuration is correct. This error is cleared the next time the system is booted.

Memory Size found by POST differed from CMOS

Memory size found by POST differed from CMOS.

Diskette drive A error

Diskette drive B error

Drive A: or B: is present but fails the BIOS POST diskette tests. Check to see that the drive is defined with the proper diskette type in Setup and that the diskette drive is attached correctly.

Incorrect Drive A type - run SETUP

Type of floppy drive A: not correctly identified in Setup.

Incorrect Drive B type - run SETUP

Type of floppy drive B: not correctly identified in Setup.

System cache error - Cache disabled

RAM cache failed and BIOS disabled the cache. On older boards, check the cache jumpers. You may have to replace the cache. See your dealer. A disabled cache slows system performance considerably.

CPU ID:

CPU socket number for Multi-Processor error.

EISA CMOS not writeable

ServerBIOS2 test error: Cannot write to EISA CMOS.

DMA Test Failed

ServerBIOS2 test error: Cannot write to extended **DMA** (Direct Memory Access) registers.

Software NMI Failed

ServerBIOS2 test error: Cannot generate software NMI (Non-Maskable Interrupt).

Fail-Safe Timer NMI Failed

ServerBIOS2 test error: Fail-Safe Timer takes too long.

device Address Conflict

Address conflict for specified **device**.

Allocation Error for: device

Run ISA or EISA Configuration Utility to resolve resource conflict for the specified **device**.

CD ROM Drive

CD ROM Drive identified.

Entering SETUP ...

Starting Setup program

Failing Bits: nnnn

The hex number **nnnn** is a map of the bits at the RAM address which failed the memory test. Each 1 (one) in the map indicates a failed bit. See errors 230, 231, or 232 above for offset address of the failure in System, Extended, or Shadow memory.

Fixed Disk n

Fixed disk **n** (0-3) identified.

Invalid System Configuration Data

Problem with NVRAM (CMOS) data.

I/O device IRQ conflict

I/O device IRQ conflict error.

PS/2 Mouse Boot Summary Screen:

PS/2 Mouse installed.

nnnn kB Extended RAM Passed

Where **nnnn** is the amount of RAM in kilobytes successfully tested.

nnnn Cache SRAM Passed

Where **nnnn** is the amount of system cache in kilobytes successfully tested.

nnnn kB Shadow RAM Passed

Where **nnnn** is the amount of shadow RAM in kilobytes successfully tested.

nnnn kB System RAM Passed

Where **nnnn** is the amount of system RAM in kilobytes successfully tested.

One or more I2O Block Storage Devices were excluded from the Setup Boot Menu

There was not enough room in the IPL table to display all installed I2O block-storage devices.

Operating system not found

Operating system cannot be located on either drive A: or drive C:. Enter Setup and see if fixed disk and drive A: are properly identified.

Parity Check 1 nnnn

Parity error found in the system bus. BIOS attempts to locate the address and display it on the screen. If it cannot locate the address, it displays **????**. Parity is a method for checking errors in binary data. A parity error indicates that some data has been corrupted.

Parity Check 2 nnnn

Parity error found in the I/O bus. BIOS attempts to locate the address and display it on the screen. If it cannot locate the address, it displays **????**.

Press <F1> to resume, <F2> to Setup, <F3> for previous

Displayed after any recoverable error message. Press <F1> to start the boot process or <F2> to enter Setup and change the settings. Press <F3> to display the previous screen (usually an initialization error of an **Option ROM**, i.e., an add-on card). Write down and follow the information shown on the screen.

Press <F2> to enter Setup

Optional message displayed during POST. Can be turned off in Setup.

PS/2 Mouse:

PS/2 mouse identified.

Run the I2O Configuration Utility

One or more unclaimed block storage devices have the Configuration Request bit set in the LCT. Run an I2O Configuration Utility (e.g. the SAC utility).

System BIOS shadowed

System BIOS copied to shadow RAM.

UMB upper limit segment address: *nnnn*

Displays the address *nnnn* of the upper limit of **Upper Memory Blocks**, indicating released segments of the BIOS which can be reclaimed by a virtual memory manager.

Video BIOS shadowed

Video BIOS successfully copied to shadow RAM.

Notes

Appendix B

BIOS POST Codes

This section lists the POST (Power On Self Test) codes for the PhoenixBIOS. POST codes are divided into two categories: recoverable and terminal.

Recoverable POST Errors

When a recoverable type of error occurs during POST, the BIOS will display an POST code that describes the problem. BIOS may also issue one of the following beep codes:

- 1 long and two short beeps - video configuration error
- 1 repetitive long beep - no memory detected

Terminal POST Errors

If a terminal type of error occurs, BIOS will shut down the system. Before doing so, BIOS will write the error to port 80h, attempt to initialize video and write the error in the top left corner of the screen. The following is a list of codes that may be written to port 80h.

POST Code Description

01h	IPMI Initialization
02h	Verify Real Mode
03h	Disable Non-Maskable Interrupt (NMI)
04h	Get CPU type
06h	Initialize system hardware
07h	Disable shadow and execute code from the ROM.
08h	Initialize chipset with initial POST values
09h	Set IN POST flag
0Ah	Initialize CPU registers
0Bh	Enable CPU cache
0Ch	Initialize caches to initial POST values
0Eh	Initialize I/O component
0Fh	Initialize the local bus IDE
10h	Initialize Power Management
11h	Load alternate registers with initial POST values
12h	Restore CPU control word during warm boot
13h	Reset PCI Bus Mastering devices
14h	Initialize keyboard controller
16h	1-2-2-3 BIOS ROM checksum
17h	Initialize cache before memory Auto size

POST Code	Description
18h	8254 timer initialization
1Ah	8237 DMA controller initialization
1Ch	Reset Programmable Interrupt Controller
20h	1-3-1-1 Test DRAM refresh
22h	1-3-1-3 Test 8742 Keyboard Controller
24h	Set ES segment register to 4 GB
28h	Auto size DRAM
29h	Initialize POST Memory Manager
2Ah	Clear 512 kB base RAM
2Ch	1-3-4-1 RAM failure on address line xxxx
2Eh	1-3-4-3 RAM failure on data bits xxxx of low byte of memory bus
2Fh	Enable cache before system BIOS shadow
32h	Test CPU bus-clock frequency
33h	Initialize Phoenix Dispatch Manager
36h	Warm start shut down
38h	Shadow system BIOS ROM
3Ah	Auto size cache
3Ch	Advanced configuration of chipset registers
3Dh	Load alternate registers with CMOS values
41h	Initialize extended memory for RomPilot (optional)
42h	Initialize interrupt vectors
45h	POST device initialization
46h	2-1-2-3 Check ROM copyright notice
48h	Check video configuration against CMOS
49h	Initialize PCI bus and devices
4Ah	Initialize all video adapters in system
4Bh	QuietBoot start (optional)
4Ch	Shadow video BIOS ROM
4Eh	Display BIOS copyright notice
4Fh	Initialize MultiBoot
50h	Display CPU type and speed
51h	Initialize EISA board (optional)
52h	Test keyboard
54h	Set key click if enabled
55h	Enable USB devices
58h	2-2-3-1 Test for unexpected interrupts
59h	Initialize POST display service
5Ah	Display prompt "Press <ESC> to enter SETUP"
5Bh	Disable CPU cache

POST Code	Description
5Ch	Test RAM between 512 and 640 kB
60h	Test extended memory
62h	Test extended memory address lines
64h	Jump to UserPatch1
66h	Configure advanced cache registers
67h	Initialize Multi Processor APIC
68h	Enable external and CPU caches
69h	Setup System Management Mode (SMM) area
6Ah	Display external L2 cache size
6Bh	Load custom defaults (optional)
6Ch	Display shadow-area message
70h	Display error messages
72h	Check for configuration errors
76h	Check for keyboard errors
7Ch	Set up hardware interrupt vectors
7Dh	Initialize Intelligent System Monitoring (optional)
7Eh	Initialize coprocessor if present
80h	Disable onboard Super I/O ports and IRQs (optional)
81h	Late POST device initialization
82h	Detect and install external RS232 ports
83h	Configure non-MCD IDE controllers
84h	Detect and install external parallel ports
85h	Initialize PC-compatible PnP ISA devices
86h	Re-initialize onboard I/O ports.
87h	Configure Motherboard Configurable Devices (optional)
88h	Initialize BIOS Data Area
89h	Enable Non-Maskable Interrupts (NMIs)
8Ah	Initialize Extended BIOS Data Area
8Bh	Test and initialize PS/2 mouse
8Ch	Initialize floppy controller
8Fh	Determine number of ATA drives (optional)
90h	Initialize hard-disk controllers
91h	Initialize local-bus hard-disk controllers
92h	Jump to UserPatch2
93h	Build MPTABLE for multi-processor boards
95h	Install CD ROM for boot
96h	Clear huge ES segment register
97h	Fix up Multi Processor table
98h	1-2 Search for option ROMs and shadow if successful. One long, two short beeps on checksum failure

POST Code	Description
99h	Check for SMART Drive (optional)
9Ch	Set up Power Management
9Dh	Initialize security engine (optional)
9Eh	Enable hardware interrupts
9Fh	Determine number of ATA and SCSI drives
A0h	Set time of day
A2h	Check key lock
A4h	Initialize typematic rate
A8h	Erase <ESC> prompt
AAh	Scan for <ESC> key stroke
ACh	Enter SETUP
AEh	Clear Boot flag
B0h	Check for errors
B1h	Inform RomPilot about the end of POST (optional)
B2h	POST done - prepare to boot operating system
B4h	1 One short beep before boot
B5h	Terminate QuietBoot (optional)
B6h	Check password (optional)
B7h	Initialize ACPI BIOS and PPM Structures
B9h	Prepare Boot
BAh	Initialize SMBIOS
BCh	Clear parity checkers
BDh	Display MultiBoot menu
BEh	Clear screen (optional)
BFh	Check virus and backup reminders
C0h	Try to boot with INT 19
C1h	Initialize POST Error Manager (PEM)
C2h	Initialize error logging
C3h	Initialize error display function
C4h	Initialize system error flags
C6h	Console redirection init.
C7h	Unhook INT 10h if console redirection enabled
C8h	Force check (optional)
C9h	Extended ROM checksum (optional)
CDh	Reclaim console redirection vector

POST Code Description

D2h	Unknown interrupt
D4h	Check Intel Branding string
D8h	Alert Standard Format initialization
D9h	Late init for IPMI
DEh	Log error if micro-code not updated properly

The following are for boot block in Flash ROM**POST Code Description**

E0h	Initialize the chipset
E1h	Initialize the bridge
E2h	Initialize the CPU
E3h	Initialize system timer
E4h	Initialize system I/O
E5h	Check force recovery boot
E6h	Checksum BIOS ROM
E7h	Go to BIOS
E8h	Set Huge Segment
E9h	Initialize Multi Processor
EAh	Initialize OEM special code
EBh	Initialize PIC and DMA
ECh	Initialize Memory type
EDh	Initialize Memory size
EEh	Shadow Boot Block
EFh	System memory test
F0h	Initialize interrupt vectors
F1h	Initialize Run Time Clock
F2h	Initialize video
F3h	Initialize System Management Manager
F4h	Output one beep
F5h	Clear Huge Segment
F6h	Boot to Mini DOS
F7h	Boot to Full DOS

If the BIOS detects errors on 2C, 2E, or 30 (base 512K RAM error), it displays an additional word-bitmap (xxxx) indicating the address line or bits that have failed. For example, "2C 0002" means address line 1 (bit one set) has failed. "2E 1020" means data bits 12 and 5 (bits 12 and 5 set) have failed in the lower 16 bits. The BIOS also sends the bitmap to the port-80 LED display. It first displays the checkpoint code, followed by a delay, the high-order byte, another delay, and then the low-order byte of the error. It repeats this sequence continuously.

Notes

Appendix C

Intel HostRAID Setup Guidelines

After all the hardware has been installed, you must first configure Intel's ESB2 SATA RAID before you install the Windows Operating System and other software drivers.

Important Notes to the User:

Note 1: If you do not wish to configure onboard SATA RAID functions, please go directly to Section C-3, Appendix D and Appendix E for OS and other software installation instructions.

Note 2: This chapter describes RAID Configuration Instructions for the Intel ESB2 RAID Controller designed for the Windows OS.

C-1 Introduction to Serial ATA and Parallel ATA

To configure the SATA RAID functions, you must first use the Intel ESB2 SATA RAID Utility program to configure the RAID Level that you desire before installing the Windows XP/2000/2003 operating system and other software drivers. (The necessary drivers are all included on the Supermicro CD that came packaged with your motherboard.) **Note:** the current version of the ESB2 SATA RAID Utility can only support Windows XP/2000/2003 Operating Systems.

Serial ATA (SATA)

Serial ATA (SATA) is a physical storage interface that uses a single cable with a minimum of four wires to create a point-to-point connection between devices. It is a serial link, which supports transfer rates up to 3.0 Gbps. Because the serial cables used in SATA are thinner than the traditional cables used in Parallel ATA (PATA), SATA systems have better airflow and can be installed in smaller chassis than Parallel ATA. In addition, the cables used in PATA are limited to a length of 40cm, while Serial ATA cables can be up to one meter in length. Overall, SATA provides better functionality than PATA.

Introduction to the Intel ESB2 Serial RAID

Located in the South Bridge of the 5400 chipset, the I/O Controller Hub (ESB2) provides the I/O subsystem with access to the rest of the system. It supports an 1-channel UltraATA/100 Bus Master IDE controller (PATA) and six Serial ATA (SATA) ports. The ESB2 supports the following PATA and SATA device configurations: Legacy mode and Native mode.

The Intel HostRAID Configurations

The following types of Intel's HostRAID configurations are supported:

RAID 0 (Data Striping): this writes data in parallel, interleaved ("striped") sections of two hard drives. Data transfer rate is doubled over using a single disk.

RAID1 (Data Mirroring): an identical data image from one drive is copied to another drive. The second drive must be the same size or larger than the first drive.

RAID 10 (Striping & Mirroring): RAID 0 and 1 schemes are combined (without parity information) to get the benefits of both.

RAID 5: both data and parity information are striped and mirrored across three or more hard drives.

The Intel Matrix Storage

The Intel Matrix Storage, supported by the ESB2, allows the user to create RAID 0, RAID 1, RAID 10 and RAID 5 sets by using only six identical hard disk drives. The Intel Matrix Storage Technology creates two partitions on each hard disk drive and generate a virtual RAID 0, RAID 1, RAID 10 and RAID 5 sets. It also allows you the change the HDD partition size without any data.

Configuring BIOS settings for SATA RAID Functions (Native Mode)

1. Press the key during system bootup to enter the BIOS Setup Utility.

Note: If it is the first time powering on the system, we recommend you load the Optimized Default Settings. If you have already done so, please skip to Step 3.

2. Use the arrow keys to select the "Exit" Settings. Once in the "Exit" settings, Scroll down to select "Load Optimized Default Settings" and press the <Enter> key. Select "OK" to confirm the selection. Press the <Enter> key to load the default settings for the BIOS.

3. Use the arrow keys to select the "Main" section in BIOS.

4. Scroll down to "SATA Controller Mode" and press the <Enter> key to select "Enhanced"

5. Scroll down to "SATA RAID Enabled" and press <Enter>. Then, select "Enabled."

6. Go to "Exit". Select "Exit Saving Changes" from the "Exit" menu. Press the <Enter> key to save the changes and exit the BIOS.

7. Once you've exited the BIOS Utility, the system will re-boot.

8. During the system boot-up, press the <Ctrl> and <I> keys simultaneously to run the Intel RAID Configuration Utility when prompted by the following message:
Press <Ctrl> <I> for the Intel RAID Configuration Utility.

Note: The Intel RAID Configuration Utility is only available for systems with two or more drives installed. The Intel RAID Utility screen will not display in systems with one drive installed.

Using the Intel ESB2 SATA RAID Utility Program

1. Creating, Deleting and Resetting RAID Volumes:

- a. After the system exits from the BIOS Setup Utility, the system will automatically reboot. The following screen appears after Power-On Self Test.

```

RAID Volumes:
None defined.

Physical Disks:
Port Drive Model      Serial #              Size   Type/Status(Vol ID)
0   WDC WD2500SD-01K  WD-HMAL72034971      232.9GB Non-RAID Disk
1   WDC WD2500SD-01K  WD-HMAL72034599      232.9GB Non-RAID Disk
2   WDC WD2500JD-00F  WD-HMAEH1376109      232.9GB Non-RAID Disk
3   WDC WD2500JD-00F  WD-HMAEH1449527      232.9GB Non-RAID Disk

Press <CTRL-I> to enter Configuration Utility...

Adaptec SCSI BIOS v4.30.0
Copyright 2003 Adaptec, Inc. All Rights Reserved.

<<< Press <Ctrl><A> for SCSISelect(TM) Utility! >>>

Slot Ch ID LUN  Vendor   Product              Size  Bus Status
-----
04  A  10  0

```

- b. When you see the above screen, press the <Ctrl> and the <I> keys simultaneously to have the main menu of the SATA RAID Utility appear:

Note: All graphics and screen shots shown in the manual are for reference only. The screen shots shown in the manual do not imply Supernicro's endorsement or non-endorsement on any 3rd party's product. Your screens may or many not look exactly the same as the graphics shown in this manual.

Creating a RAID 0 Volume:

- a. Select "Create RAID Volume" from the main menu and press the <Enter> key. The following screen will appear:

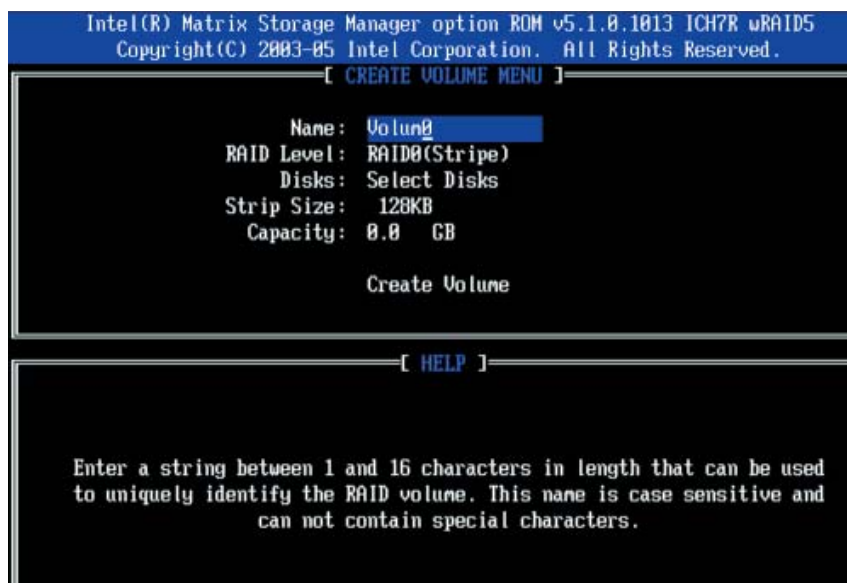

- b. Specify a name for the RAID 0 set and press the <Tab> key or the <Enter> key to go to the next field. (You can use the <Esc> key to select the previous menu.)
- c. When RAID Level item is highlighted, press the <Up Arrow>, <Down Arrow> keys to select RAID 0 (Stripe) and hit <Enter>.
- d. When the Disks item is highlighted, press <Enter> to select the HDD to configure as RAID. The following pop-up screen (See the note on Page C-3) displays:

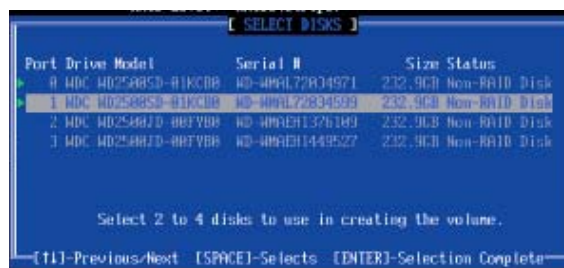

- e. Use the <Up Arrow>, <Down Arrow> keys to highlight a drive and press <Space> to select it. A triangle appears to confirm the selection of the drive.
- f. Use the <Up Arrow>, <Down Arrow> keys to select the stripe size, ranging from 4 KB to 128 KB for the RAID 0 array, and hit <Enter>. (**Note:** For a server, please use a lower stripe size, and for a multimedia system, use a higher stripe size. The default stripe size is 128 KB.)
- g. Press <Enter> when the Create Volume item is highlighted. A warning message displays.
- h. When asked "Are you sure you want to create this volume (Y/N), press "Y" to create the RAID volume, or type "N" to go back to the Create Volume menu.

Creating a RAID 1 Volume:

- a. Select "Create RAID Volume" from the main menu and press the <Enter> key. The following screen will appear:

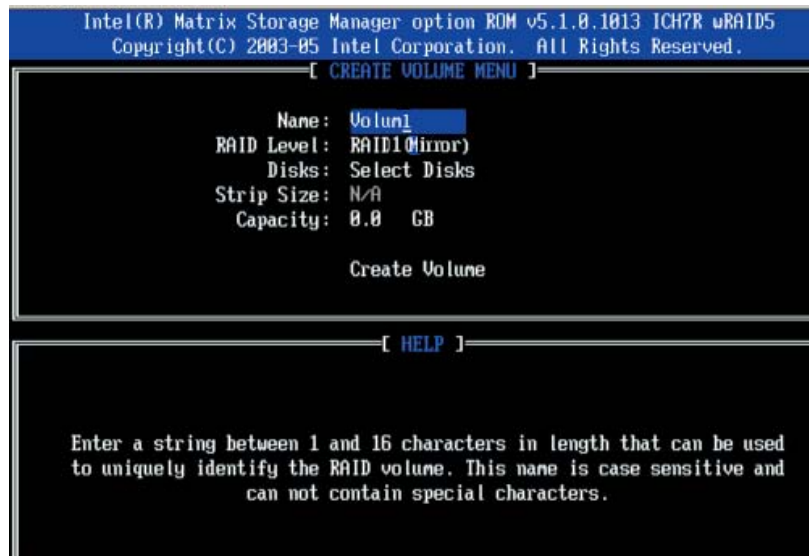

- b. Specify a name for the RAID 1 set and press the <Tab> key or the <Enter> key to go to the next field. (You can use the <Esc> key to select the previous menu.)
- c. When RAID Level item is highlighted, press the <Up Arrow>, <Down Arrow> keys to select RAID 1 (Mirror) and hit <Enter>.
- d. When the Capacity item is highlighted, enter your RAID volume capacity and hit <Enter>. The default setting is the maximum capacity allowed.
- e. Press <Enter> when the Create Volume item is highlighted. A warning message displays.
- f. When asked "Are you sure you want to create this volume (Y/N)", press "Y" to create the RAID volume, or type "N" to go back to the Create Volume menu.

Creating a RAID 10 (RAID 1+ RAID 0):

- a. Select "Create RAID Volume" from the main menu and press the <Enter> key. The following screen will appear:



- b. Specify a name for the RAID 10 set and press <Enter>.
- c. When RAID Level item is highlighted, use the <Up Arrow>, <Down Arrow> keys to select RAID 10 (RAID1 + RAID0) and hit <Enter>.
- d. When the Stripe Size is highlighted, use the <Up Arrow>, <Down Arrow> keys to select the stripe size from 4 KB to 128 KB for your RAID 10 and hit <Enter>. The default setting is 64 KB. (Note: For a server, please use a lower stripe size, and for a multimedia system, use a higher stripe size.)
- e. When the RAID Volume Capacity item is highlighted, enter your RAID volume capacity and hit <Enter>. The default setting is the maximum capacity allowed.
- f. Press <Enter> when the Create Volume item is highlighted. A warning message displays.
- g. When asked "Are you sure you want to create this volume (Y/N), press "Y" to create the RAID volume, or type "N" to go back to the Create Volume menu.

Creating a RAID 5 Set (Parity):

- a. Select "Create RAID Volume" from the main menu and press the <Enter> key. The following screen will appear:

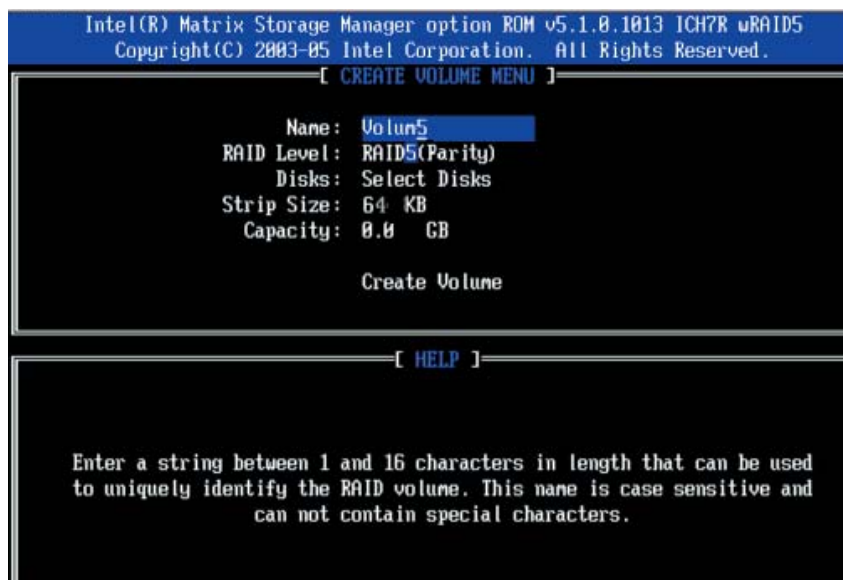

- b. Specify a name for the RAID 5 set and press <Enter>.
- c. When the Raid Level is highlighted, use the <Up Arrow>, <Down Arrow> keys to select RAID 5 (Parity) and hit <Enter>.
- d. When the Disk item is highlighted, press <Enter> to select the HDD to configure as RAID. The following pop-up screen (See the note on Page C-3) displays:

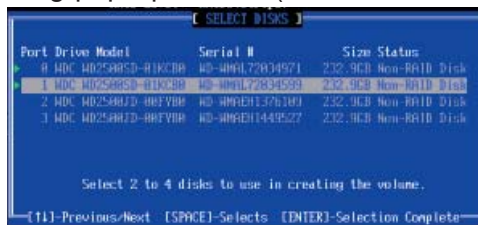

- e. Use the <Up Arrow>, <Down Arrow> keys to highlight a drive and press <Space> to select it. A triangle appears to confirm the selection of the drive.
- f. Use the <Up Arrow>, <Down Arrow> keys to select the stripe size, ranging from 4 KB to 128 KB for the RAID 5 array, and hit <Enter>. (**Note:** For a server, please use a lower stripe size, and for a multimedia system, use a higher stripe size. The default stripe size is 128 KB.)
- g. Enter your desired RAID volume capacity and press <Enter> when the capacity item is highlighted. The default setting is the maximum capacity allowed.
- h. Press Enter when the Create Volume item is highlighted. A warning message displays.
- i. When asked "Are you sure you want to create this volume (Y/N)", press "Y" to create the RAID volume, or type "N" to go back to the Create Volume menu.

Deleting RAID Volume:



Warning: Be sure to back up your data before deleting a RAID set. You will lose all data on the disk drives when deleting a RAID set.)

- a. From the main menu, select item2-Delete RAID Volume, and press <Enter>.
- b. Use the <Up Arrow>, <Down Arrow> keys to select the RAID set you want to delete and press . A Warning message displays.
- c. When asked "Are you sure you want to delete this volume (Y/N)", press "Y" to delete the RAID volume, or type "N" to go back to the Delete Volume menu.

Resetting to Non-RAID and Resetting a RAID HDD



Warning: Be cautious when you reset a RAID volume HDD to non-RAID or Resetting a RAID HDD. Resetting a RAID volume HDD or Resetting a RAID HDD will reformat the HDD and delete the internal RAID structure on the drive.

- a. From the main menu, select item3-Reset Disks to Non- RAID, and press <Enter>. The following screen will appear:



- b. Use the <Up Arrow>, <Down Arrow> keys to highlight the RAID set drive to reset and press <Space> to select.
- c. Press <Enter> to reset the RAID set drive. A Warning message displays.
- d. Press "Y" to reset the drive, or type "N" to go back to the main menu.

Exiting the Intel Matrix Storage Manager Utility:

- a. From the main menu, select item4-Exit, and press <Enter>. A warning message will appear.
- b. Press "Y" to reset the drive, or type "N" to go back to the main menu.

C-2 Installing the Windows XP/2000/2003 for systems with RAID Functions

Installing a New Operating System-the Windows XP/2000/2003 OS

- a. Insert the Microsoft Windows XP/2000/2003 Setup CD in the CD Driver, and the system will start booting up from CD.
- b. Press the <F6> key when the message-" Press F6 if you need to install a third party SCSI or RAID driver" displays.
- c. When the Windows XP/2000/2003 Setup screen appears, press "S" to specify additional device(s).
- d. Insert the driver diskette-"Intel AA RAID XP/2000/2003 Driver for ESB2 into Drive A: and press the <Enter> key.
- e. Choose the Intel(R) ESB2 *SATA RAID Controller* from the list indicated in the XP/2000/2003 Setup Screen, and press the <Enter> key.
- f. Press the <Enter> key to continue the installation process. (If you need to specify any additional devices to be installed, do it at this time.) Once all devices are specified, press the <Enter> key to continue with the installation.
- g. From the Windows XP/2000/2003 Setup screen, press the <Enter> key. The XP/2000/2003 Setup will automatically load all device files and then, continue the Windows XP/2000/2003 installation.
- h. After the Windows XP/2000/2003 Installation is completed, the system will automatically reboot.

Note: the current version of the ESB2 SATA RAID Utility can only support the Windows XP/2000/2003 Operating System.

Appendix D

Adaptec HostRAID Setup Guidelines

After all the hardware has been installed, you must first configure the Adaptec Embedded Serial ATA RAID before you install the Windows operating system. The necessary drivers are all included on the Supermicro bootable CDs that came packaged with your motherboard. (**Note:** The following section provides information on the Adaptec SATA RAID Driver based on the Intel Enterprise South Bridge 2 (ESB2) Controller.)

D-1 Introduction to the Adaptec Embedded Serial ATA RAID Controller Driver

Serial ATA (SATA)

Serial ATA(SATA) is a physical storage interface. It uses a single cable with a minimum of four wires to create a point-to-point connection between devices. It is a serial link which supports SATA Transfer rates up to 3.0 Gbps. Because the serial cables used in SATA are thinner than the traditional cables used in Parallel ATA(PATA), SATA systems have better airflow and can be installed in smaller chassis than Parallel ATA. In addition, the cables used in PATA can only extend to 40cm long, while Serial ATA cables can extend up to one meter. Overall, Serial ATA provides better functionality than Parallel ATA.

Introduction to the Intel ESB2 I/O Controller Hub

Located in the South Bridge of the Intel 5400 Chipset, the ESB2 I/O Controller Hub provides the I/O subsystem with access to the rest of the system. It supports 1-channel Ultra ATA/100 Bus Master IDE controller (PATA) and one Adaptec's Serial ATA (SATA) Host Controller, which support up to six Serial ATA drives, up to two RAID volumes and up to four drives in RAID Configurations. (See the table below for details.)

* Adaptec's SATA HostRAID Controller Firmware supports:	
Drives supported	Six
Number of RAID Volumes supported	Two
Total Drives in RAID Configurations	Four
Examples of Valid RAID Configurations:	
Two drives of RAID 1 + two drives of RAID 0	
Two drives of RAID 1 + two drives of RAID 1	
Three drives of RAID 0	
Four drives of RAID 0	
Examples of Invalid RAID Configurations:	
Three drives of RAID 0 + two drives of RAID 1	
(* Note: this table is applicable to Adaptec's HostRAID Controller Firmware only.)	

To configure the Adaptec SATA RAID for Operating Systems that support RAID functions(--Windows, Red Hat & SuSe, Linux)

1. Press the key during system bootup to enter the BIOS Setup Utility.

Note: If it is the first time powering on the system, we recommend you load the Optimized Default Settings. If you have already done so, please skip to Step 3.

2. Use the arrow keys to select the "Exit" Settings. Once in the "Exit" settings, Scroll down to select "Load Optimized Default Settings" and press the <Enter> key. Select "OK" to confirm the selection. Press the <Enter> key to load the default settings for the BIOS.

3. Use the arrow keys to select the "Main" section in BIOS.

4. Scroll down to "SATA Control Mode" and press the <Enter> key to select "Enhanced."

5. Scroll down to "SATA RAID Enabled" and press <Enter>. Then, select "Enabled."

6. Scroll down to "ICH RAID Codebase" and select "Adaptec". Then press <Enter>. (For ICH RAID Codebase: Change the setting from Intel to Adaptec.)

7. Go to "Exit". Select "Exit Saving Changes" from the "Exit" menu. Press the <Enter> key to save the changes and exit the BIOS.

8. Once you've exited the BIOS Utility, the system will re-boot.

9. During the system boot-up, press the <Ctrl> and <A> keys simultaneously to run the Intel RAID Configuration Utility when prompted by the following message: Press <Ctrl> <A> for Intel RAID Configuration Utility.

The Adaptec Embedded Serial ATA with HostRAID Controller Driver

The Adaptec Embedded Serial ATA RAID Controller adds SATA/RAID functionality and performance enhancements to a motherboard. RAID striping (RAID 0) allows data to be written across multiple drives, greatly improving hard disk I/O performance. RAID mirroring (RAID 1) allows data to be simultaneously written to two drives, improving data security even if a single hard disk fails. A Stripe of Mirrors (RAID 10) provides multiple RAID 1 mirrors and a RAID 0 stripe, maximizing data security and system efficiency. By incorporating the Adaptec Embedded Serial ATA into the motherboard design, Supermicro's X7DWT/X7DWT-INF offers the user the benefits of SATARAID without the high costs associated with hardware RAID applications.

Using the Adaptec RAID Configuration Utility (ARC)

The Adaptec RAID Configuration Utility, an embedded BIOS Utility, includes the following:

Array Configuration Utility: Use this utility to create, configure and manage arrays.

Disk Utilities: Use this option to format or verify disks.

To run the Adaptec RAID Configuration Utility, you will need to do the following:

1. Enable RAID functions in the system BIOS (refer to Chapter 4 for System BIOS Configurations).
2. Press the <Ctrl> and <A> keys simultaneously when prompted to do so during system boot. (Refer to the previous page for detailed instructions.)

A. Using the Array Configuration Utility (ACU)

When you press <Ctrl> and <A> keys simultaneously at the prompt during system bootup, the main menu will appear.

Note: To select an option, use the arrow keys to highlight the item and then press the <Enter> key to select it. To return to the previous menu, press the <ESC> key. Press the <Insert> key to select a drive. When a drive is highlighted (selected), press the <Delete> key to de-select it.

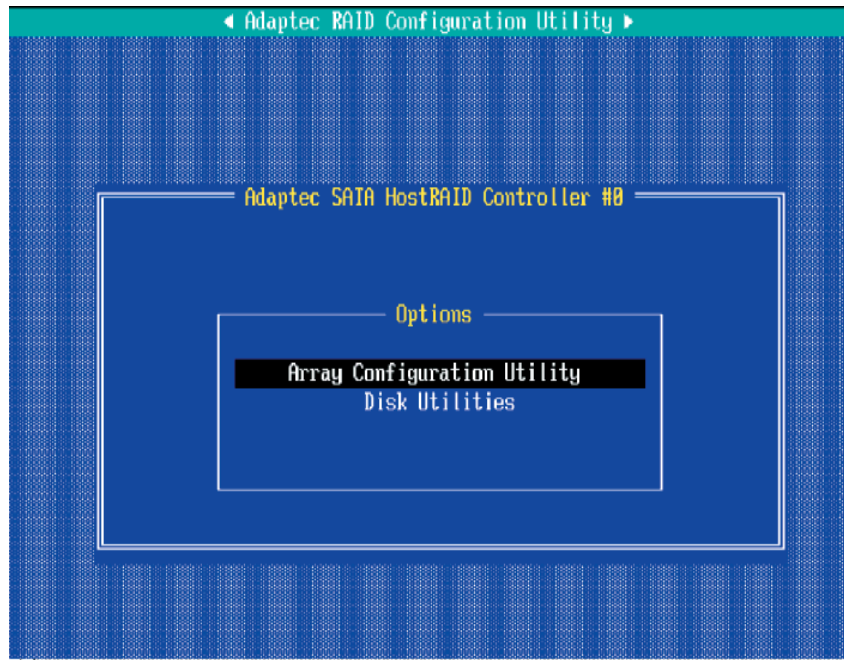

Managing Arrays

Select this option to view array properties, and configure array settings.

To select this option, using the arrow keys and the <enter> key, select "Managing Arrays" from the main menu as shown above.



Configuring Disk Drives

You may need to configure a disk drive before you can use it.

Caution: Configuring a disk may overwrite the partition table on the disk and may make any data on the disk inaccessible. If the drive is used in an array, you may not be able to use the array again.

Do not configure a disk that is part of a boot array. To determine which disks are associated with a particular array, please refer to [Viewing Array Properties](#).

To configure a disk drive:

1. From the main menu (shown on Page D-4), select Configure Drives and hit <Enter> (as shown below.)

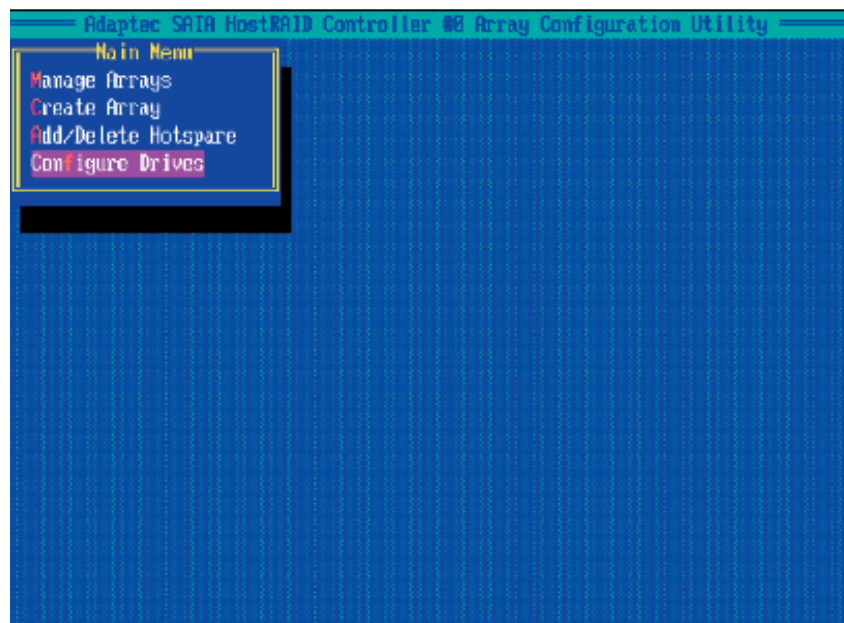

2. From the "Select Drives for Configuring" List (shown below,) select the drives you want to configure and press <Insert>.

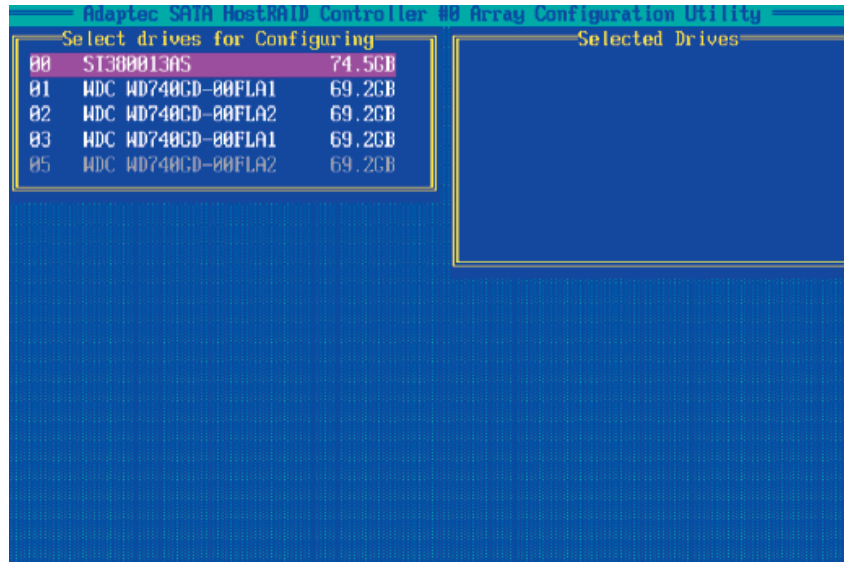

3. The drive you've selected will appear in the "Selected Drives Dialog Box" on the right (as shown below.) Repeat the same steps until all drives that you want to configure appear in the selected drives box.

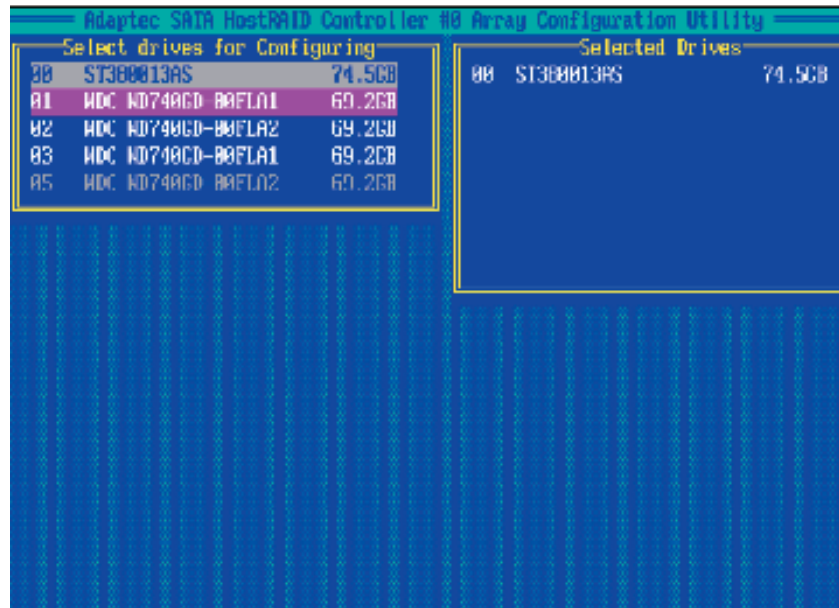

4. Once both drives display in the selected drive box, press <Enter>.

5. Read the warning message as shown in the screen below.

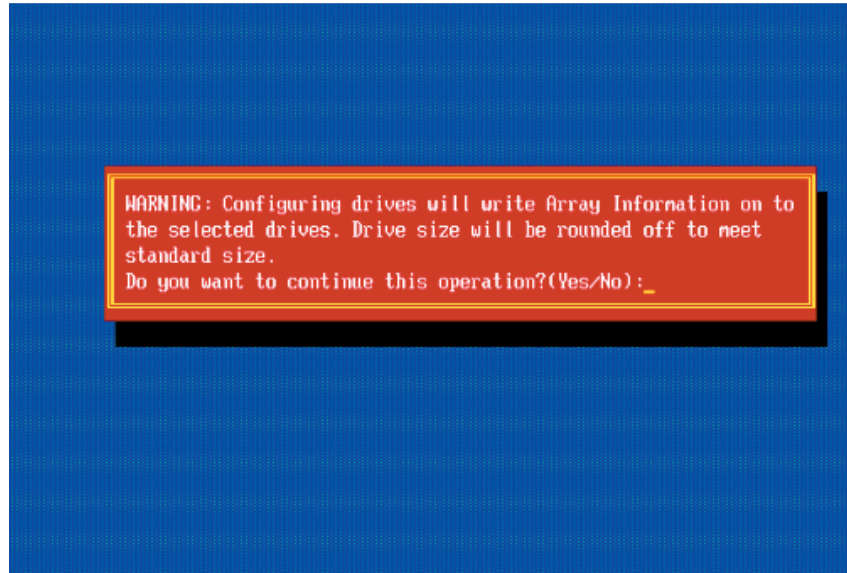

6. Make sure that you have selected the correct disk drives to configure. If correct, type Y to continue.

Creating Arrays

Before you create arrays, make sure that the disks for the array are connected and installed in your system. Note that disks with no usable space, or disks that are un-initialized or not formatted are shown in gray and cannot be used. (**Note:** It is recommended that you configure devices before you create arrays.)

To create an array:

1. From the main menu (shown on page D-4), select Create Array.
2. Select the disks for the new array and press Insert (as the screen shown below). (**Note:** To de-select any disk, highlight the disk and press Delete.)

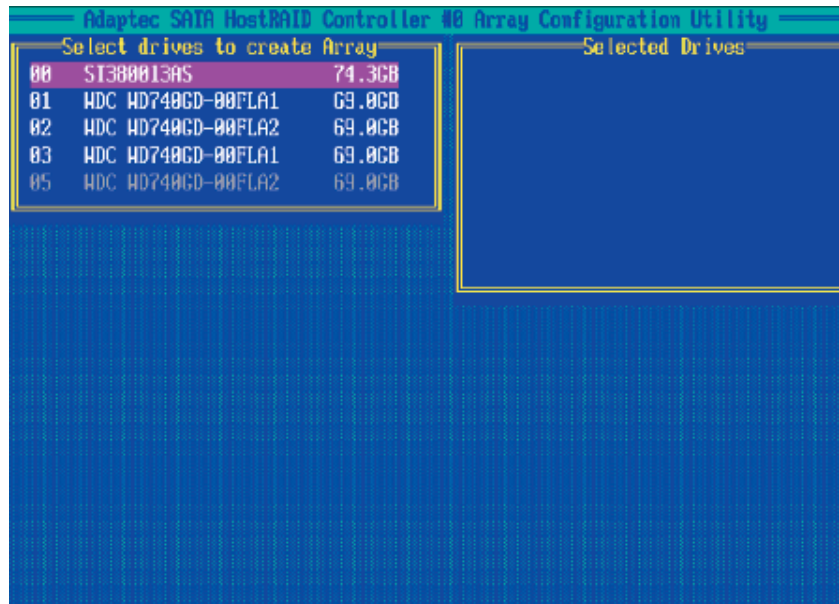

3. The arrays you have selected will appear on the Selected Drives dialog box on the right (as shown below.)
4. Press Enter when both disks for the new array are selected. The Array Properties menu displays.

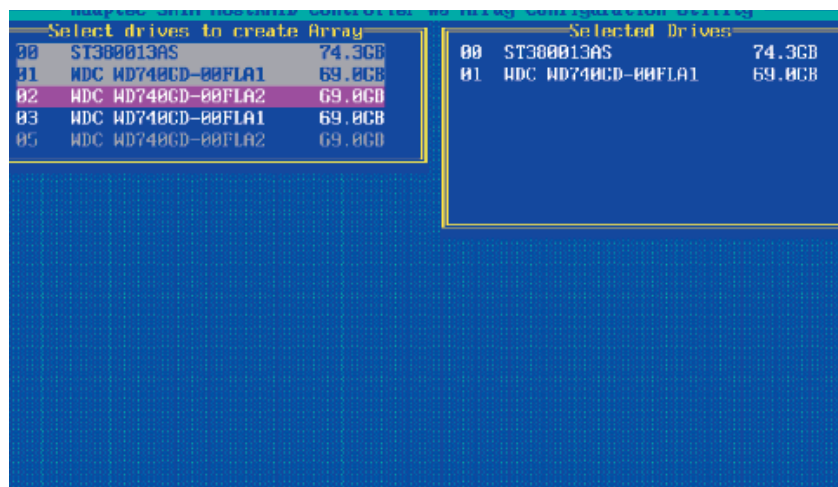

Assigning Array Properties

Once a new array is completed, you can assign properties to the array.

Caution: Once the array is created and its properties are assigned, and you cannot change the array properties using this utility.

To assign properties to the new array:

1. In the Array Properties menu (as shown in the screen below), select an array type and press Enter. Only the available array types will be displayed on the screen. (RAID 0 or RAID 1 requires two drives.)

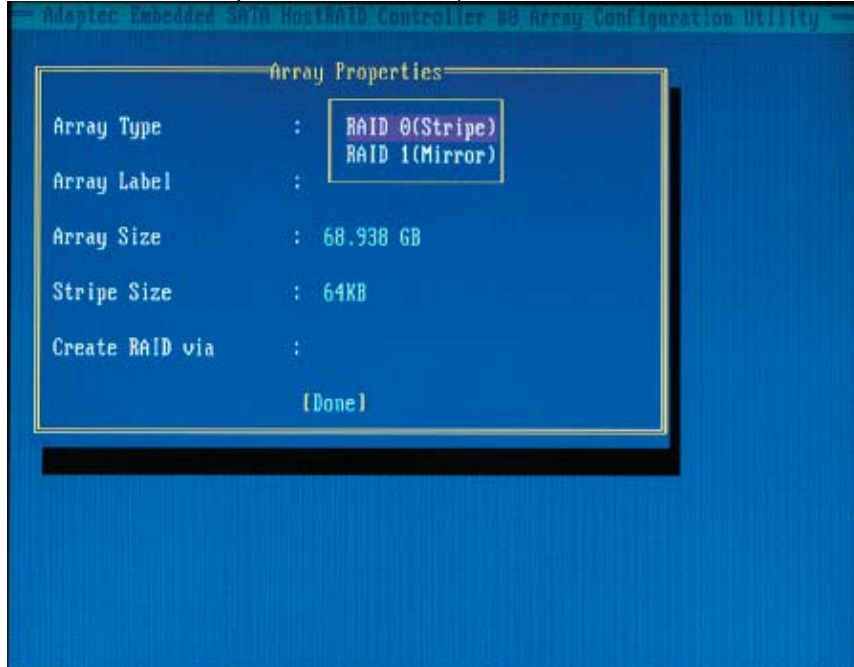

2. Under the item "Arrays Label", type in a label and press <Enter>. (Note: The label shall not be more than 15 characters.)
3. For RAID 0, select the desired stripe size. (Note: Available stripe sizes are 16, 32, and 64 KB. 64K is default. Please do not change the default setting.)
4. The item: "Create RAID via" allows you to select between the different ways of creating methods for RAID 0 and RAID 1.

The following table gives examples of when each is appropriate.

Raid Level	Create Via	When Appropriate
RAID 0	Quick Init	Creating a RAID 0 on new drives
RAID 0	Migrate*	Creating a RAID 0 from one new drive and one drive with data you wish to preserve
RAID 1	Build*	Any time you wish to create a RAID 1, but especially if you have data on one drive that you wish to preserve
RAID 1, RAID 10	Clear	Creating a RAID 1 or RAID 10 on new drives, or when you want to ensure that the array contains no data after creation.
RAID 1, RAID 10	Quick Init	Fastest way to create a RAID 1 or RAID 10 Appropriate when using new drives

(Note: If you select Migrate for RAID 0, or Build for RAID 1, you will be asked to select the source drive. The contents of the source drive will be preserved. However, the data on the new drive will be lost.)

5. When you are finished, press **<Done>** (as the screen shown below).

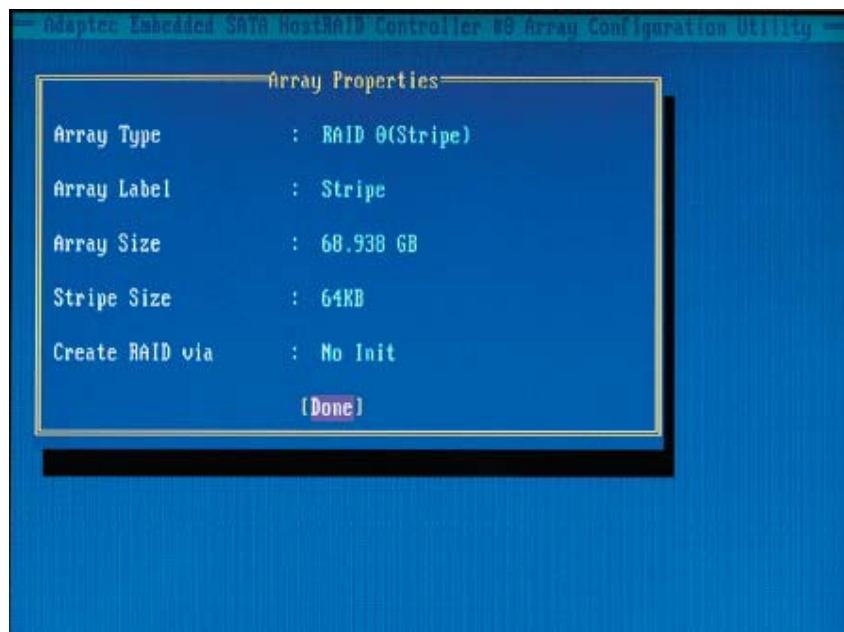
**Notes:**

1. Before adding a new drive to an array, be sure to back up any data stored on the new drive; otherwise, all data will be lost.
2. If you stop the Build or Clear process on a RAID 1, you can restart it by pressing **<Ctrl>** and **<R>**.
3. If you've used the Quick Init option to create a RAID1, it may return some data mis-comparison when you run a consistency check at a later time. This is normal.
4. The Adaptec Host RAID allows you to use drives of different sizes in a RAID. However, you can only select a smaller drive as the source or first drive during a build operation.
5. When migrating from single volume to RAID 0, migrating from a larger drive to a smaller drive is allowed. However, the destination drive must be at least half the capacity of the source drive.
6. It is not recommended that you migrate or build an array on Windows dynamic disks (volumes) because it will result in data loss.

Warning: Do not interrupt the process when you create a RAID 0 using the Migrate option. If you do, you will not be able to restart the system, or to recover the data that was on the source drive.

Adding a Bootable Array

To make an array bootable:

1. From the Main menu, select Manage Arrays.
2. From the List of Arrays, select the array you want to make bootable, and press <Ctrl> and .
3. Enter Y to create a bootable array when the following message is displayed: "This will make all other existing bootable array non-bootable. Do you want to make this array bootable? (Yes/No):" Then, a bootable array will be created. An asterisk (*) will appear next to the bootable array (as shown in the picture below:)

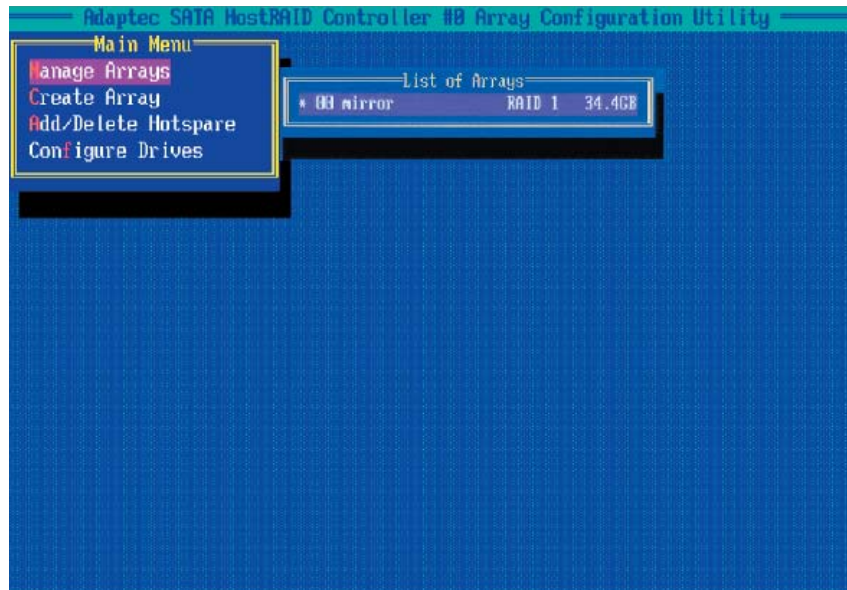

Deleting a Bootable Array

To delete a bootable array:

1. From the Main menu, select Manage Arrays.
2. From the List of Arrays, select the bootable array you want to delete, and press <Ctrl> and . Note: a bootable array is the array marked with an asterisk (as shown in the picture above.)
3. When the following message is displayed: "The array is already marked bootable. Do you want to make this array as not bootable? (Yes/No)," Enter Y to delete a bootable array. The bootable array will be deleted and the asterisk will disappear.

(Note: Do not use the delete key to delete the bootable array.)

Adding/Deleting Hotspares

To add a Hotspare:

(**Note:** In order to rebuild a RAID (RAID 0 or RAID 1), you would need to add a new HDD as a hotspare.)

1. From the main menu (shown on Page D-4), select Add/Delete Hotspares.
2. Use the up and down arrow keys to highlight and select the disk you want to designate as a hotspare, and press <Insert>, and then, press <Enter>.
3. Press Yes when the following prompt is displayed:

"Do you want to create spare?" (Yes/No?)

The spare you have selected will appear in the Selected drives Menu.

To delete a Hotspare:

1. From the main menu (shown on Page D-4), select Add/Delete Hotspares.
2. Use the up and down arrow keys to highlight and select the Hotspare you want to delete, and press <delete>, and then, press <Enter>.
3. When the following warning is displayed: "Do you want to delete the hot spare?" (Yes/No?), press Yes to delete the hotspare you have selected.



Viewing Array Properties

To view the properties of an existing array:

1. From the main menu, select Manage Arrays and hit <Enter> (as shown on the previous page.)
2. From the List of Arrays dialog box (shown below), select the array you want to view and press Enter.

The Array Properties dialog box appears (as shown below), showing detailed information on the array. The physical disks associated with the array are displayed here.

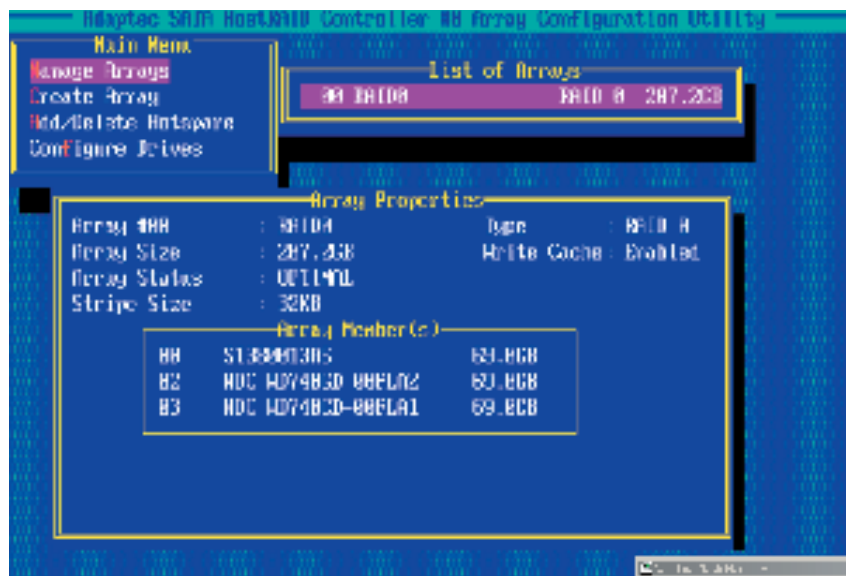

3. Press Esc to return to the previous menu.

Rebuilding Arrays

Note 1: Rebuilding applies to Fault Tolerant array (RAID 1) only.

If an array Build process is interrupted or when one critical member is missing, you must perform a Rebuild to restore its functionality. For a critical array rebuild operation, the optimal drive is the source drive.

Note 2: If no spare array exists and a hard disk drive fails, you need to create a spare before you can rebuild an array.

To Rebuild an array:

1. From the Main Menu, select Manage Arrays (as shown in the screen below). From the List of Arrays, select the array you want to Rebuild.
2. Press <Ctrl> and <R> to Rebuild.



Deleting Arrays

Warning!! Back up the data on an array before you delete it to prevent data loss
Deleted arrays cannot be restored.

To delete an existing array:

1. From the main menu (shown on Page D-4), select Manage Arrays.
2. Select the array you wish to delete and press <delete>.
3. In the Array Properties dialog box, select Delete and press <Enter>. The following prompt is displayed:

Warning!! Deleting the array will render array unusable. Do you want to delete the array? (Yes/No):

RAID 1 only—the following prompt is also displayed:

Deleting the partition will result in data loss! Do you also want to delete the partition? (Yes/No):

4. Press Yes to delete the array and partition or No to return to the previous menu.
5. Press Esc to return to the previous menu.

Using the Disk Utilities

The Disk Utilities enable you to format or verify the media of your Serial ATA hard disks.

To access the disk utilities:



1. From the Adaptec RAID Configuration Utility Menu, select Disk Utilities (as shown above) and press <Enter>. The following screen appears.

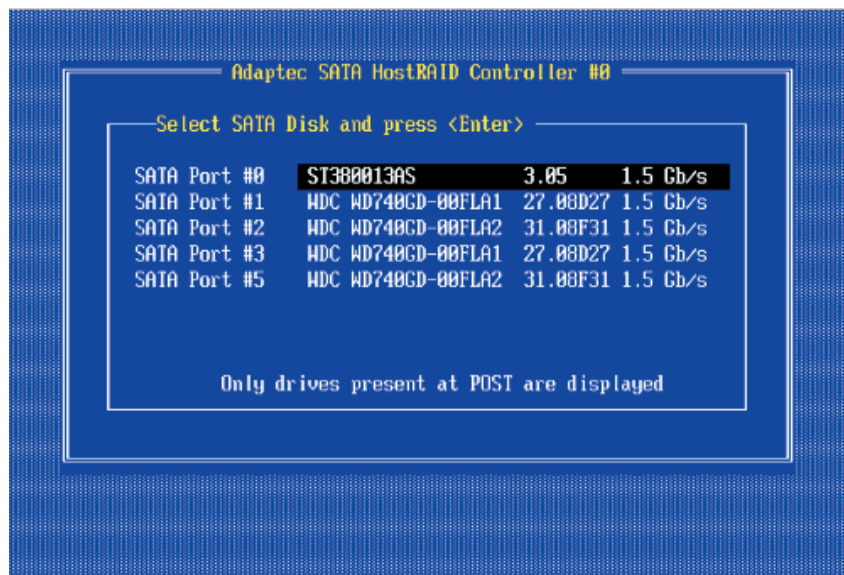

2. Select the desired disk and press <Enter>. The following screen appears:

To format a disk:

Note: The operation of Formatting Disk allows you to perform a low-level formatting of a hard drive by writing zeros to the entire disk. Serial ATA drives are low-level formatted at the factory and do not need to be low-level formatted again.

3. When the screen shown below displays, select Format Disk and press <Enter>. The following screen appears:

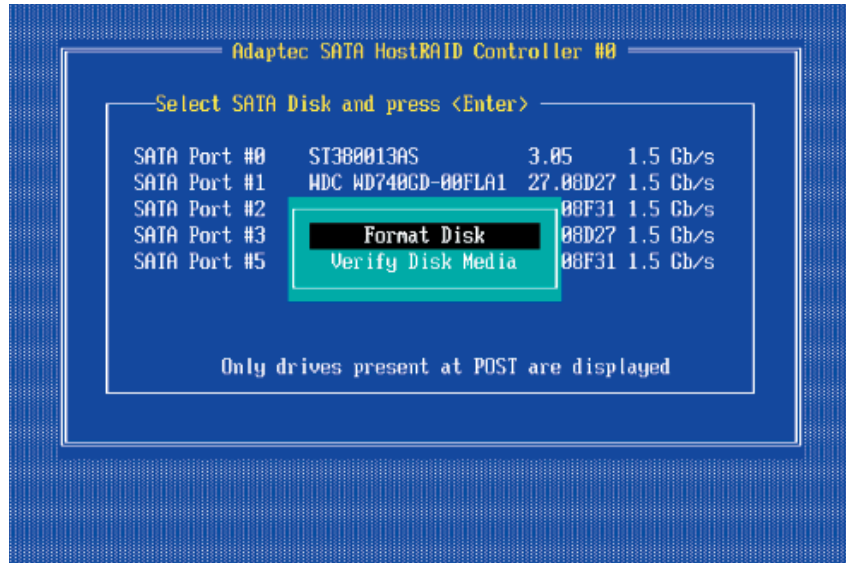

4. Read the warning message when it appears in the screen as shown below. To continue with disk formatting, select Yes and hit <Enter>. Otherwise, select No and press <Enter>.

(Caution: Formatting a disk destroys all data on the drive. Be sure to back up your data before formatting a disk.)

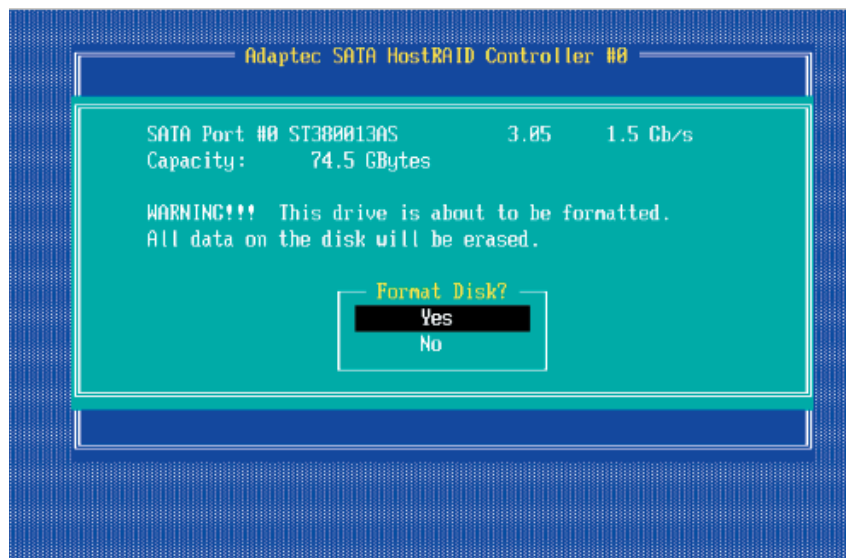

To verify disk media:

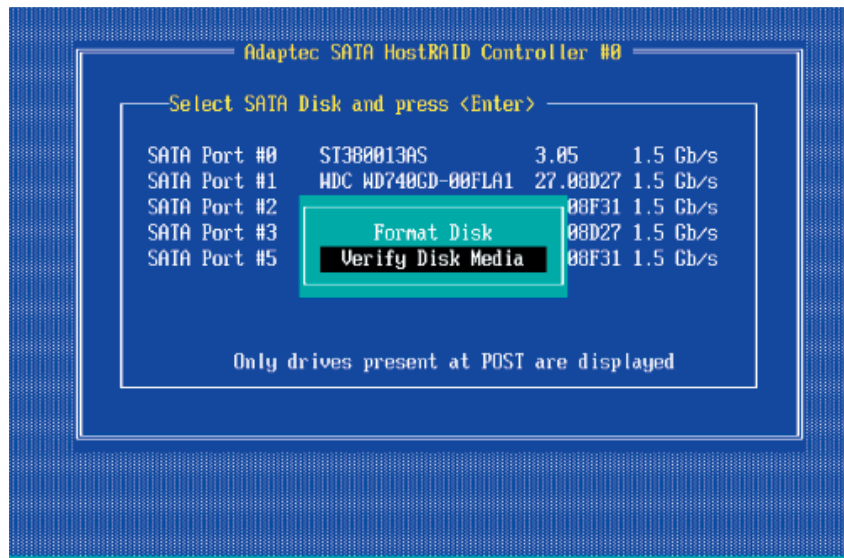

3. When the screen shown above displays, select Verify Disk Media and press <Enter>.

4. A message will display, indicating that the selected drive will be scanned for media defects. Select Yes and hit <Enter> to proceed with disk verifying; otherwise, select No and hit <Enter>.

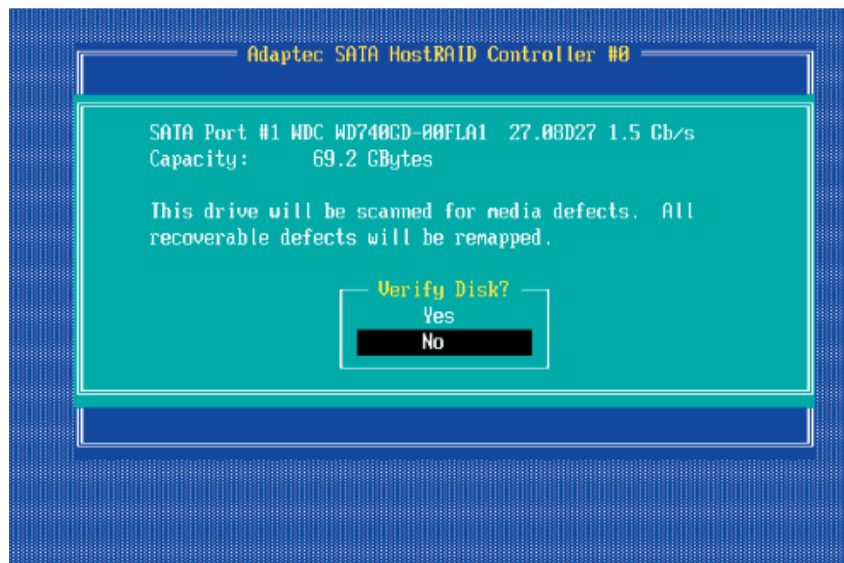

To Exit Adaptec RAID Configuration Utility

1. Once you have completed RAID array configurations, press ESC to exit. The following screen will appear.
2. Press Yes to exit the Utility.

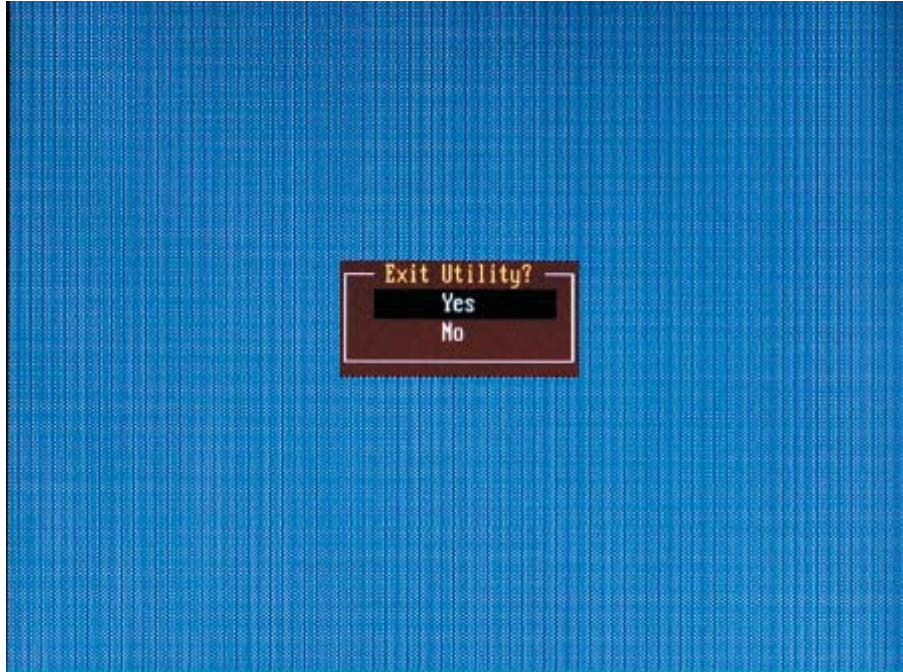

Notes

Appendix E

Installing Other Software Programs and Drivers

E-1 Installing Drivers other than the Adaptec Embedded Serial ATA RAID Controller Driver

After you've installed the Windows Operating System, a screen as shown below will appear. You are ready to install software programs and drivers that have not yet been installed. To install these software programs and drivers, click the icons to the right of these items.



Driver/Tool Installation Display Screen

Note: Click the icons showing a hand writing on the paper to view the readme files for each item. Click a computer icon to the right of an item (from top to the bottom) one at a time. **After installing each item, you must re-boot the system before proceeding with the next item on the list.** The bottom icon with a CD on it allows you to view the entire contents of the CD.

E-2 Configuring Supero Doctor III

The Supero Doctor III program is a Web-base management tool that supports remote management capability. It includes Remote and Local Management tools. The local management is called the SD III Client. The Supero Doctor III program included on the CDROM that came with your motherboard allows you to monitor the environment and operations of your system. Supero Doctor III displays crucial system information such as CPU temperature, system voltages and fan status. See the Figure below for a display of the Supero Doctor III interface.

Note 1: The default User Name and the Password are ADMIN.

Note 2: In the Windows OS environment, the Supero Doctor III settings take precedence over the BIOS settings. When first installed, Supero Doctor III adopts the temperature threshold settings previously set in the BIOS. Any subsequent changes to these thresholds must be made within Supero Doctor, since the SD III settings override the BIOS settings. For the Windows OS to adopt the BIOS temperature threshold settings, please change the SDIII settings to be the same as those set in the BIOS.

Supero Doctor III Interface Display Screen-I (Health Information)



Supero Doctor III Interface Display Screen-II (Remote Control)



Note: SD III Software Revision 1.0 can be downloaded from our Web site at: ftp://ftp.supermicro.com/utility/Supero_Doctor_III/. You can also download SDIII User's Guide at: <http://www.supermicro.com/PRODUCT/Manuals/SDIII/UserGuide.pdf>. For Linux, we will still recommend that you use Supero Doctor II.

Notes