

SUPER ®

SUPER ® X7SB4

SUPER ® X7SBE

USER'S MANUAL

Revision 1.1b

The information in this User's Manual has been carefully reviewed and is believed to be accurate. The vendor assumes no responsibility for any inaccuracies that may be contained in this document, makes no commitment to update or to keep current the information in this manual, or to notify any person or organization of the updates. **Please Note: For the most up-to-date version of this manual, please see our web site at www.supermicro.com.**

SUPER MICRO COMPUTER, INC. ("Supermicro") reserves the right to make changes to the product described in this manual at any time and without notice. This product, including software, if any, and documentation may not, in whole or in part, be copied, photocopied, reproduced, translated or reduced to any medium or machine without prior written consent.

IN NO EVENT WILL SUPER MICRO COMPUTER, INC. BE LIABLE FOR DIRECT, INDIRECT, SPECIAL, INCIDENTAL, SPECULATIVE OR CONSEQUENTIAL DAMAGES ARISING FROM THE USE OR INABILITY TO USE THIS PRODUCT OR DOCUMENTATION, EVEN IF ADVISED OF THE POSSIBILITY OF SUCH DAMAGES. IN PARTICULAR, SUPER MICRO COMPUTER, INC. SHALL NOT HAVE LIABILITY FOR ANY HARDWARE, SOFTWARE, OR DATA STORED OR USED WITH THE PRODUCT, INCLUDING THE COSTS OF REPAIRING, REPLACING, INTEGRATING, INSTALLING OR RECOVERING SUCH HARDWARE, SOFTWARE, OR DATA.

Any disputes arising between manufacturer and customer shall be governed by the laws of Santa Clara County in the State of California, USA. The State of California, County of Santa Clara shall be the exclusive venue for the resolution of any such disputes. Supermicro's total liability for all claims will not exceed the price paid for the hardware product.

FCC Statement: This equipment has been tested and found to comply with the limits for a Class A digital device pursuant to Part 15 of the FCC Rules. These limits are designed to provide reasonable protection against harmful interference when the equipment is operated in a commercial environment. This equipment generates, uses, and can radiate radio frequency energy and, if not installed and used in accordance with the manufacturer's instruction manual, may cause harmful interference with radio communications. Operation of this equipment in a residential area is likely to cause harmful interference, in which case you will be required to correct the interference at your own expense.

California Best Management Practices Regulations for Perchlorate Materials: This Perchlorate warning applies only to products containing CR (Manganese Dioxide) Lithium coin cells. "Perchlorate Material-special handling may apply. See www.dtsc.ca.gov/hazardouswaste/perchlorate"

WARNING: Handling of lead solder materials used in this product may expose you to lead, a chemical known to the State of California to cause birth defects and other reproductive harm.

Manual Revision 1.1b

Release Date: January 27, 2010

Unless you request and receive written permission from Super Micro Computer, Inc., you may not copy any part of this document.

Information in this document is subject to change without notice. Other products and companies referred to herein are trademarks or registered trademarks of their respective companies or mark holders.

Copyright © 2010 by Super Micro Computer, Inc.
All rights reserved.

Printed in the United States of America

Preface

About This Manual

This manual is written for system integrators, PC technicians and knowledgeable PC users. It provides information for the installation and use of the **SUPER**® X7SB4/X7SBE motherboard. The X7SB4/X7SBE supports a single Intel® Xeon 3000 Series processor at a system bus speed of 1333 MHz, 1066 MHz or 800 MHz. The Intel® Xeon 3000 Series processors are housed in the Flip-Chip Land Grid Array package that interfaces with the motherboard via an LGA775 socket. The X7SB4/X7SBE supports the Intel Virtualization Technology (VT), Execute Disable Bit, and Enhanced Intel SpeedStep Technology (EIST), providing the user with the ultimate performance in a slim package. Please refer to our web site (<http://www.supermicro.com/products>) for CPU updates or visit Intel's web site for processor support. This product is intended to be professionally installed and serviced by a technician.

Manual Organization

Chapter 1 describes the features, specifications and performance of the mainboard and provides detailed information about the chipset.

Chapter 2 provides hardware installation instructions. Read this chapter when installing the processor, memory modules and other components into the system.

If you encounter any problems, see **Chapter 3**, which describes troubleshooting procedures for the video, the memory and the system setup stored in the CMOS.

Chapter 4 includes an introduction to BIOS and provides detailed information on running the CMOS Setup utility.

Appendix A provides BIOS Error Beep Codes. **Appendix B** and **Appendix C** list the Windows OS Installation and Other Software Installation Instructions.

Conventions Used in the Manual

Special attention should be given to the following symbols for proper installation and to prevent damage done to the components or injury to yourself:



Danger/Caution: Instructions to be strictly followed to prevent catastrophic system failure or to avoid bodily injury.



Warning: Important information given to ensure proper system installation or to prevent damage to the components.

Note: Additional Information given to differentiate various models or to ensure correct system setup.

Table of Contents

Preface

About This Manual	iii
Manual Organization	iii
Conventions Used in the Manual	ii

Chapter 1: Introduction

1-1 Overview	1-1
Checklist	1-1
Contacting Supermicro	1-2
SUPER [®] X7SB4/X7SBE Image	1-3
SUPER [®] X7SB4/X7SBE Layout	1-4
SUPER [®] X7SB4/X7SBE Quick Reference	1-5
Motherboard Features	1-6
Intel 3210 Chipset: System Block Diagram	1-8
1-2 Chipset Overview	1-9
1-3 Special Features	1-10
Recovery from AC Power Loss	1-10
1-4 PC Health Monitoring	1-10
1-5 ACPI Features	1-11
1-6 Power Supply	1-12
1-7 Super I/O	1-13

Chapter 2: Installation

2-1 Static-Sensitive Devices	2-1
2-2 Processor and Heatsink Installation	2-2
2-3 Mounting the Motherboard in the Chassis	2-5
2-4 Installing DDR2 Memory	2-6
2-5 Control Panel Connectors and I/O Ports	2-8
2-6 Connecting Cables	2-8
A. Back Panel Connectors/I/O Ports	2-8
B. Front Control Panel	2-9
C. Front Control Panel Pin Definitions	2-10
NMI Button	2-10
Power LED	2-10
HDD LED	2-11
NIC1/NIC2 LED Indicators	2-11
OH/Fan Fail LED	2-12
Power Fail LED	2-12

Reset Button	2-13
Power Button	2-13
2-6 Connecting Cables	2-14
ATX Power Connector	2-14
Processor Power Connector	2-14
Universal Serial Bus (USB)	2-15
Chassis Intrusion	2-15
ATX PS/2 Keyboard and PS/2 Mouse Ports	2-16
Serial Ports	2-16
Power LED	2-17
External Speaker/Internal Buzzer Header	2-17
GLAN Ports	2-18
VGA Connector	2-18
Power Fault	2-18
Fan Headers	2-19
Wake-On-Ring	2-20
Wake-On-LAN	2-20
Power Fault	2-21
Power SMB	2-21
Serial_Link GPIO Headers	2-22
Alarm Reset	2-22
2-7 Jumper Settings	2-23
Explanation of Jumpers	2-23
GLAN Enable/Disable	2-23
CMOS Clear	2-24
Watch Dog Enable	2-24
SMBus to PCI/PCI-E Slots	2-25
VGA Enable	2-25
SCSI Enable/Disable	2-26
SCSI Termination Enable/Disable	2-26
USB Wake-Up	2-27
Force-Power-On Enable	2-28
2-8 Onboard Indicators	2-29
GLAN LED Indicators	2-29
Onboard Power LED	2-30
POST LED Indicators	2-30
System Status LED	2-31
2-9 Floppy, Hard Drive, SIM 1U IPMI and SCSI Connections	2-32
Floppy Connector	2-32

Ultra 320 SCSI Connector..... 2-33
SIM 1U IPMI..... 2-33

Chapter 3: Troubleshooting

3-1 Troubleshooting Procedures 3-1
 Before Power On 3-1
 No Power 3-1
 No Video 3-1
 Memory Errors..... 3-2
 Losing the System's Setup Configuration 3-2
3-2 Technical Support Procedures 3-2
3-3 Frequently Asked Questions 3-3
3-4 Returning Merchandise for Service..... 3-4

Chapter 4: BIOS

4-1 Introduction..... 4-1
4-2 Running Setup 4-2
4-3 Main BIOS Setup 4-2
4-4 Advanced Setup..... 4-6
4-5 Security Setup 4-22
4-6 Boot Setup..... 4-24
4-7 Exit..... 4-25

Appendices:

Appendix A: BIOS Error Beep Codes..... A-1
Appendix B: Installing the Windows OS B-1
Appendix C: Installing Other Software Programs and Drivers..... C-1

Chapter 1

Introduction

1-1 Overview

Checklist

Congratulations on purchasing your computer motherboard from an acknowledged leader in the industry. Supermicro boards are designed with the utmost attention to detail to provide you with the highest standards in quality and performance.

Please check that the following items have all been included with your motherboard. If anything listed here is damaged or missing, contact your retailer.

All the following items are included in the retail box only:

One (1) Supermicro Mainboard

One (1) floppy drive ribbon cable (CBL-0022L)

Six (6) SATA cables (CBL-044L) (X7SBE only)

Four (4) SATA cables (CBL-044L) (X7SB4 only)

One (1) SCSI cable (CBL-034L-U320) (X7SB4 only)

One (1) I/O shield (CSE-PT07L)

One (1) Supermicro CD containing drivers and utilities

One (1) User's/BIOS Manual

One (1) Ultra 320 SCSI User's Manual

Contacting Supermicro

Headquarters

Address: Super Micro Computer, Inc.
980 Rock Ave.
San Jose, CA 95131 U.S.A.

Tel: +1 (408) 503-8000

Fax: +1 (408) 503-8008

Email: marketing@supermicro.com (General Information)
support@supermicro.com (Technical Support)

Web Site: www.supermicro.com

Europe

Address: Super Micro Computer B.V.
Het Sterrenbeeld 28, 5215 ML
's-Hertogenbosch, The Netherlands

Tel: +31 (0) 73-6400390

Fax: +31 (0) 73-6416525

Email: sales@supermicro.nl (General Information)
support@supermicro.nl (Technical Support)
rma@supermicro.nl (Customer Support)

Asia-Pacific

Address: Super Micro Computer, Taiwan
4F, No. 232-1 Liancheng Road
Chung-Ho 235, Taipei Hsien, Taiwan, R.O.C.

Tel: +886-(2) 8226-3990

Fax: +886-(2) 8226-3991

Web Site: www.supermicro.com.tw

Technical Support:

Email: support@supermicro.com.tw

Tel: 886-2-8228-1366, ext.132 or 139

SUPER X7SB4/X7SBE Image



An Important Note to the User

- All images and layouts shown in this manual were based upon the latest PCB Revision available at the time of publishing. The motherboard you've received may or may not look exactly the same as the graphics shown in this manual.

Motherboard Layout
(not drawn to scale)

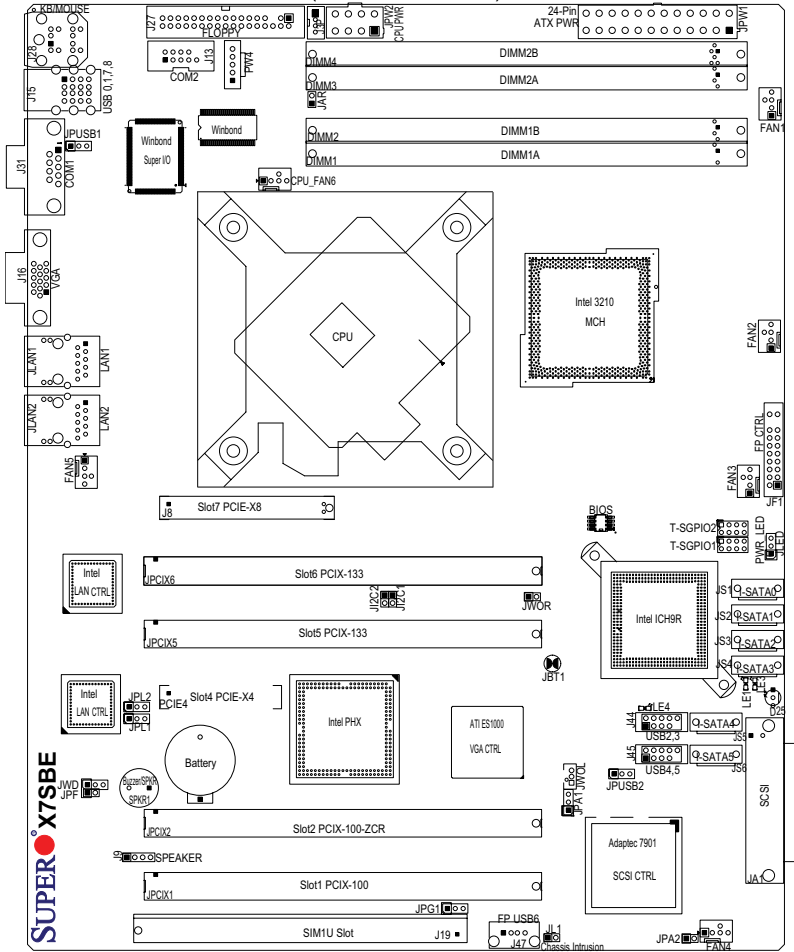

Important Notes to the User

- See Chapter 2 for detailed information on jumpers, I/O ports and JF1 front panel connections.
- "■" indicates the location of "Pin 1".
- Jumpers not indicated are for testing only.
- When the LE1 LED is on, the Standby Power is on. Make sure to remove the power cable before installing or removing components.
- SCSI and PCI-X 100MHz ZCR Slot are available for the X7SB4 only.
- Slot 4: A regular PCI-100 MHz slot for the X7SBE, and a PCI-100 MHz ZCR slot for the X7SB4.
- Back Panel USB Ports 7 & 8 are for OEM only.

X7SB4/X7SBE Quick Reference

Jumper	Description	Default Setting
JBT1	CMOS Clear	(See Chapter 2)
J ² C1/J ² C2	SMB to PCI Slots	Open/Open (Disabled)
JPA1 (X7SB4)	SCSI Channel Enable	Pins 1-2 (Enabled)
JPA2 (X7SB4)	SCSI Channel Termin.Enable	Open (Enabled)
JPF	Power Force-On	Open (Disabled)
JPG1	VGA Enable	Pins 1-2 (Enabled)
JPL1/JPL2	Giga-bit LAN 1/LAN 2 Enable	Pins 1-2 (Enabled)
JPUSB1	Backpanel USB Wake-Up	Pins 1-2 (Enabled)
JPUSB2	Front Panel USB Wake-Up	Pins 2-3 (Disabled)
JWD	Watch Dog Enable	Pins 1-2 (Reset)
Connector	Description	
COM1/COM2	COM Port 1 & COM 2 Header	J31/J13
Fans 1-6	Chassis/System Fan Headers (Fans 1-5) & CPU Fan6	
Floppy	Floppy Disk Connector (J27)	
J9	Speaker Header	
J3P	Power Fault Header (See Chapter 2)	
JAR	Alarm Reset Header	
JF1	Front Panel Control Header	
JL1	Chassis Intrusion Header	
JPW1	ATX 24-Pin Power Connector	
JPW2	12V 8-pin Power Connector (Required)	
JWOL	Wake On LAN Header	
JWOR	Wake On Ring Header	
KB/MS	PS/2 Keyboard/Mouse Connector (J28)	
LAN1/LAN2	Ethernet RJ45 (Gigabit LAN) Port1/Port2 Connectors	
I-SATA0~I-SATA5	6 Intel SATA Ports (JS1-JS6)	
PW4	Power SMBus Header (I ² C)	
SCSI (X7SB4)	SCSI Channel Connector (JA1)	
SPKR1	Internal Speaker/Buzzer	
T-SPGIO1/T-SPGIO2	Serial Link General_Purpose I/O Headers	
USB 0,1,7,8	Back Panel Universal Serial Bus Ports 0,1 & 7,8 (J15)	
USB 2/3, 4/5	Front Panel Accessible USB Headers 2,3,4,5(J44/J45)	
USB 6	Front Panel USB Port 6 (J47)	
VGA	VGA Connector (J16)	
LED Indicator	Description ((Refer to Section 2-8 in Chapter 2.))	
D25	System Status LED Indicator	
JLED	Power LED	
LE 1	Onboard +5V Standby Power warning LED Indicator	
LE3/LE4	BIOS POST Code Indicators	

Motherboard Features

CPU

- Single Intel® Xeon 3000 Series Processors at system bus speeds of 1333 MHz/1066 MHz/800 MHz.
- Intel Virtualization Technology (VT), Execute Disable Bit, Enhanced Intel SpeedStep (EIST) supported

Memory (Note: See Section 2-4 for details.)

- Four DIMM slots support Dual/Single Channel DDR2 800/667 MHz up to 8 GB of ECC/Non-ECC Unbuffered DDR2 SDRAM.

Chipset

- Intel 3210
- Intel ICH9R
- Intel PXH

Expansion Slots

- One (1) PCI-Express x4 slot (Slot 4)
- Two (2) PCI-X 64-Bit 133 MHz slots (Slot 5/Slot 6)
- Two (2) PCI-X 64-Bit 100 MHz slots (Slot 1/Slot 2) (X7SBE)
One (1) PCI-X 64-Bit 100 MHz slots (Slot 1)/One (1) PCI-X 64-Bit 100 MHz ZCR slot (Slot 2) (X7SB4: Green Slot-Slot 2 w/AOC-LPZCR1 support)
- One (1) PCI-Express x8 slot (Slot 7)
- One (1) SIM 1U IPMI slot (J19)

BIOS

- 16Mb SPI Phoenix BIOS
- DMI 2.3, PCI 2.2, PCI-X 1.0, ACPI 1.0, Plug and Play (PnP), SMBIOS 2.3, Hardware BIOS Virus Protection

PC Health Monitoring

- Onboard voltage monitors for CPU cores, Memory Voltage, +1.8V, +3.3V, +5V, +5V Standby, +12V, -12V, and VBAT
- CPU 4-phase-switching voltage regulator
- Status monitor for fan speed & System OH/Fan Fail LED/Control
- Pulse Width Modulation Fan Control & Low noise fan speed control
- Environmental temperature monitoring via BIOS
- Power-up mode control for recovery from AC power loss
- Supero Doctor III, NMI
- System Resource alert via Supero Doctor III
- Slow blinking LED for suspend state indicator
- BIOS support for USB keyboard
- Main switch override mechanism

Onboard I/O

- Adaptec Ultra 320 AIC-7901 SCSI Controller (X7SB4 only)
- Intel ICH9R SATA Controller, 6 connectors for 6 devices, supporting RAID functions 0, 1, 5 and 10 (RAID 5: supported by Intel's RAID Controller in the Windows OS environment only.)
- 1 floppy port interface (up to 2.88 MB)
- 1 Fast UART 16550 compatible serial port and 1 header
- Intel 82573V and 82573L Gigabit Ethernet Controllers
- PS/2 mouse and PS/2 keyboard ports
- Up to 7 USB ports (1 on-board connector and 2 headers) (Two additional USB: USB 7/8 are for OEM only)
- VGA Connector
- SIM 1U IPMI Slot
- Super I/O (Winbond 83627HG), Hardware Monitoring: W83793
- ES1000 w/32MB Video Memory

Temperature

- Monitoring CPU, chassis environment
- CPU Thermal Trip support
- Thermal Monitor 2 (TM2) (available if supported by the CPU)

Other

- Wake-on-LAN (WOL)
- Wake-on-Ring (WOR)
- Onboard +5vsb warning LED Indicator ("LE 1")
- External modem ring-on

CD Utilities

- Drivers and software for Intel 3210 chipset utilities

Dimensions

- 9.6" (W) x 12" (L) (243.84 mmx 304.8 mm)

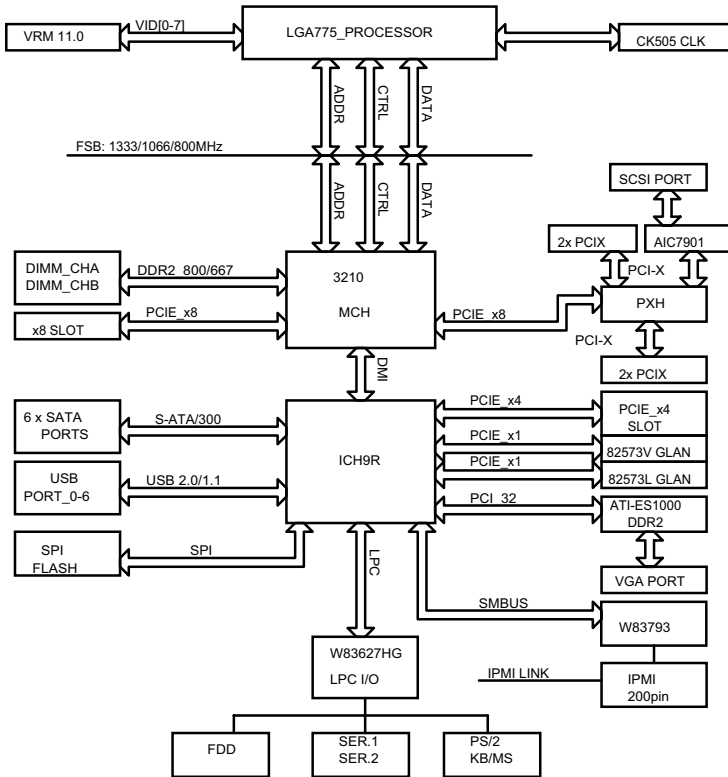

**The Intel 3210 Chipset:
System Block Diagram**

Note: This is a general block diagram and may not exactly represent the features on your motherboard. See the following pages for the actual specifications of each motherboard.

1-2 Chipset Overview

The Intel 3210 Chipset, designed for use with the Xeon 3000 Series Processor, is comprised of two primary components: the Memory Controller Hub (MCH) and the I/O Controller Hub (ICH9R). In addition, Intel's PCI-X (PXH) is used for added functionality. The X7SB4/X7SBE provides the performance and feature-set required for the cutting-edge, cost-effective server market.

Memory Controller Hub (MCH)

The function of the MCH is to manage the data flow between four interfaces: the CPU interface, the DDR2 System Memory Interface, the PCI Express Interface (Note Below), and the Direct Media Interface (DMI). The MCH is optimized for the Xeon Core™2 processor in the 45nm/65nm process in the LGA775 Land Grid Array Package. It supports one or two channels of DDR2 SDRAM.

The I/O Controller (ICH9R) provides the data buffering and interface arbitration required for the system to operate efficiently. It also provides the bandwidth needed for the system to maintain its peak performance. The Direct Media Interface (DMI) provides the connection between the MCH and the ICH9R. The ICH9R supports two PCI-Express devices, six Serial ATA ports, and up to seven USB 2.0 ports/headers. In addition, the ICH9R offers the Intel Matrix Storage Technology which provides various RAID options for data protection and rapid data access. It also supports the next generation of client management through the use of PROActive technology in conjunction with Intel's next generation Gigabit Ethernet controller.

Intel ICH9R System Features

The I/O Controller Hub provides the I/O subsystem with access to the rest of the system. Functions and capabilities include:

- Advanced Configuration and Power Interface, Version 2.0 (ACPI)
- Intel I/O External Design Specification (EDS)
- 3210 Memory Controller Hub (MCH) External Design Specification (EDS)
- Intel I/O Controller Hub 9 (ICH9R) Thermal Design Guideline
- Intel 82573 V/L Platform LAN Connect (PLC) PCI Design

Note: The Intel 3210 chipset does not support add-in graphics cards in the PCI-E interface provided by the Memory Controller Hub (MCH).

1-3 Special Features

Recovery from AC Power Loss

BIOS provides a setting for you to determine how the system will respond when AC Power is lost and then restored to the system. You can choose for the system to remain powered off (in which case you must hit the power switch to turn it back on) or for it to automatically return to a power- on state. See the Power Lost Control setting in the Advanced section to change this setting. (**Note:** Default: Last State.)

1-4 PC Health Monitoring

This section describes the PC health monitoring features of the X7SB4/X7SBE. All have an onboard System Hardware Monitor chip that supports PC health monitoring.

Onboard Voltage Monitors for the CPU Cores, Memory Voltage, +1.8V, +3.3V, +5V, +5V Standby, +12V, -12V and Vbatt.(via SuperO Doctor)

An onboard voltage monitor will scan these voltages continuously. Once a voltage becomes unstable, a warning is given or an error message is sent to the screen. Users can adjust the voltage thresholds to define the sensitivity of the voltage monitor.

Fan Status Monitor with Firmware Control

The PC health monitor can check the RPM status of the cooling fans. The onboard CPU and chassis fans are controlled by the Thermal Management via BIOS (under Hardware Monitoring in the Advanced Setting).

Environmental Temperature Control

The thermal control sensor monitors the CPU temperature in real time and will turn on the thermal control fan whenever the CPU temperature passes a user-defined overheating threshold. The overheat circuitry runs independently from the CPU. Once it detects that the CPU temperature is too high, it will automatically turn on the thermal fan control to prevent the CPU from overheating. The onboard chassis thermal circuitry can monitor the overall system temperature and alert users when the chassis temperature is too high.

CPU Overheat LED and Control

This feature is available when the user enables the CPU overheat warning function in the BIOS. This allows the user to define an overheat temperature. When the CPU temperature passes this temperature threshold, both the overheat fan and the warning LED are triggered.

System Resource Alert

This feature is available when used with Supero Doctor III in the Windows OS environment or used with Supero Doctor II in Linux. Supero Doctor is used to notify the user of certain system events. For example, if the system is running low on virtual memory and there is insufficient hard drive space for saving the data, you can be alerted of the potential problem. You can also configure Supero Doctor to provide you with warnings when the system temperature goes beyond a pre-defined range.

1-5 ACPI Features

ACPI stands for Advanced Configuration and Power Interface. The ACPI specification defines a flexible and abstract hardware interface that provides a standard way to integrate power management features throughout a PC system, including its hardware, operating system and application software. This enables the system to automatically turn on and off peripherals such as CD-ROMs, network cards, hard disk drives and printers. This also includes consumer devices connected to the PC such as VCRs, TVs, telephones and stereos.

In addition to enabling operating system-directed power management, ACPI provides a generic system event mechanism for Plug and Play and an operating system-independent interface for configuration control. ACPI leverages the Plug and Play BIOS data structures while providing a processor architecture-independent implementation that is compatible with Windows 2000, Windows XP and Windows 2003 Server Operating Systems.

Slow Blinking LED for Suspend-State Indicator

When the CPU goes into a suspend state, the chassis Power LED will start blinking to indicate that the CPU is in suspend mode. When the user presses any key, the CPU will wake-up and the LED will automatically stop blinking and remain on.

Main Switch Override Mechanism

When an ATX power supply is used, the power button can function as a system suspend button to make the system enter a SoftOff state. The monitor will be suspended and the hard drive will spin down. Pressing the power button again to "wake-up" the whole system. During the SoftOff state, the ATX power supply provides power to keep the required circuitry in the system alive. In case the system malfunctions and you want to turn off the power, just press and hold the power button for 4 seconds. This option can be set in the Power section of the BIOS Setup routine.

External Modem Ring-On

Wake-up events can be triggered by a device such as the external modem ringing when the system is in the SoftOff state. Note that external modem ring-on can only be used with an ATX 2.01 (or above) compliant power supply.

Wake-On-LAN (WOL)

Wake-On-LAN is defined as the ability of a management application to remotely power up a computer that is powered off. Remote PC setup, up-dates and asset tracking can occur after hours and on weekends so that daily LAN traffic is kept to a minimum and users are not interrupted. The motherboard has a 3-pin header (WOL) to connect to the 3-pin header on a Network Interface Card (NIC) that has WOL capability. In addition, an onboard LAN controller can also support WOL without any connection to the WOL header. The 3-pin WOL header is to be used with a LAN add-on card only.

Note: Wake-On-LAN requires an ATX 2.01 (or above) compliant power supply.

1-6 Power Supply

As with all computer products, a stable power source is necessary for proper and reliable operation. It is even more important for processors that have high CPU clock rates.

The X7SB4/X7SBE can only accommodate 24-pin ATX power supplies. Although most power supplies generally meet the specifications required by the CPU, some are inadequate. In addition, the 12V 8-pin power connection is also required to ensure adequate power supply to the system. Also your power supply must supply 1.5A for the Ethernet ports. It is strongly recommended that you use a high quality power supply that meets ATX power supply Specification 2.01 or above. It must also be SSI compliant (info at <http://www.ssiforum.org/>). Additionally, in areas where noisy power transmission is present, you may choose to install a line filter to shield the computer from noise. It is recommended that you also install a power surge protector to help avoid problems caused by power surges.

1-7 Super I/O

The disk drive adapter functions of the Super I/O chip include a floppy disk drive controller that is compatible with industry standard 82077/765, a data separator, write pre-compensation circuitry, decode logic, data rate selection, a clock generator, drive interface control logic and interrupt and DMA logic. The wide range of functions integrated onto the Super I/O greatly reduces the number of components required for interfacing with floppy disk drives. The Super I/O supports 360 K, 720 K, 1.2 M, 1.44 M or 2.88 M disk drives and data transfer rates of 250 Kb/s, 500 Kb/s or 1 Mb/s. It also provides two high-speed, 16550 compatible serial communication ports (UARTs). Each UART includes a 16-byte send/receive FIFO, a programmable baud rate generator, complete modem control capability and a processor interrupt system. Both UARTs provide legacy speed with baud rate of up to 115.2 Kbps as well as an advanced speed with baud rates of 250 K, 500 K, or 1 Mb/s, which support higher speed modems.

The Super I/O supports one PC-compatible printer port (SPP), Bidirectional Printer Port (BPP) , Enhanced Parallel Port (EPP) or Extended Capabilities Port (ECP).

The Super I/O provides functions that comply with ACPI (Advanced Configuration and Power Interface), which includes support of legacy and ACPI Power Management through an SMI or SCI function pin. It also features auto power management to reduce power consumption.

Notes

Chapter 2

Installation

2-1 Static-Sensitive Devices

Electrostatic Discharge (ESD) can damage electronic components. To prevent damage to your system board, it is important to handle it very carefully. The following measures are generally sufficient to protect your equipment from ESD.

Precautions

- Use a grounded wrist strap designed to prevent static discharge.
- Touch a grounded metal object before removing the board from the antistatic bag.
- Handle the board by its edges only; do not touch its components, peripheral chips, memory modules or gold contacts.
- When handling chips or modules, avoid touching their pins.
- Put the motherboard and peripherals back into their antistatic bags when not in use.
- For grounding purposes, make sure your computer chassis provides excellent conductivity between the power supply, the case, the mounting fasteners and the motherboard.
- Use only the correct type of onboard CMOS battery. Do not install the onboard upside down battery to avoid possible explosion.

Unpacking

The motherboard is shipped in antistatic packaging to avoid static damage. When unpacking the board, make sure the person handling it is static protected.

2-2 Processor and Heatsink Installation



When handling the processor package, avoid placing direct pressure on the label area of the fan.

Notes:

1. Always connect the power cord last and always remove it before adding, removing or changing any hardware components. Make sure that you install the processor into the CPU socket before you install the CPU heatsink.
2. The Intel boxed Xeon LGA 775 CPU package contains the CPU fan and heatsink assembly. If you buy a CPU separately, make sure that you use only Intel-certified multi-directional heatsink and fan.
3. The Intel® Xeon LGA 775 heatsink and fan comes with a push-pin design and no tool is needed for installation.
4. Make sure to install the motherboard into the chassis before you install the CPU heatsink and fan.)
5. When purchasing an LGA 775 CPU or when receiving a motherboard with an LGA 775 CPU pre-installed, make sure that the CPU plastic cap is in place and none of the CPU pins are bent; otherwise, contact the retailer immediately.
6. Refer to the MB Features Section for more details on CPU support.

Installing the LGA775 Processor

1. Press the socket lever to release the load plate, which covers the CPU socket, from its locking position.
2. Gently lift the socket lever to open the load plate.

Socket Lever

Load Plate

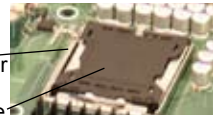

Load Plate

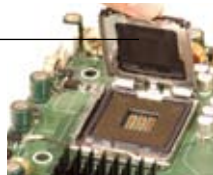

Loading the CPU into the Socket

1. Locate Pin 1 on the CPU socket. (Note: Pin 1 is the corner marked with a triangle). Please note that the North Key and the South Key are located vertically in the CPU housing.
2. Position the motherboard in such a way that Pin 1 of the CPU socket is located at the left bottom of the CPU housing.
3. Use your thumb and your index finger to hold the CPU at the North Center Edge and the South Center Edge of the CPU.
4. Align Pin 1 of the CPU with Pin 1 of the socket. Once aligned, carefully lower the CPU straight down to the socket. (Do not drop the CPU on the socket. Do not move the CPU horizontally or vertically. Do not rub the CPU against the surface or against any pins of the socket to avoid damage to the CPU or the socket.)
5. With the CPU inside the socket, inspect the four corners of the CPU to make sure that the CPU is properly installed.
6. Use your thumb to gently push the lever down and lock it in the hook
7. If the CPU is properly installed into the socket, the plastic cap will be automatically released from the load plate when the lever is pushed into the hook. Remove the plastic cap from the motherboard.

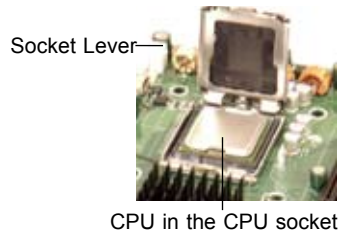
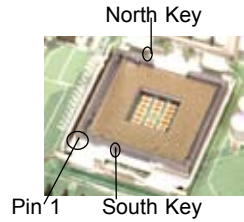

Warning: Please keep the plastic cap. The motherboard and the CPU must be shipped with the plastic cap properly installed to protect the CPU pins. Shipment without the CPU plastic cap properly installed will void the warranty.



Plastic cap is released from the load plate if CPU properly installed.

Installation of the Heatsink

1. Locate the CPU Fan on the motherboard. (Refer to the layout on the right for the CPU Fan location.)
2. Position the heatsink in such a way that the heatsink fan wires are closest to the CPU fan and are not interfered with other components.
3. Inspect the CPU Fan wires to make sure that the wires are routed through the bottom of the heatsink.
4. Remove the thin layer of the protective film from the copper core of the heatsink. **Warning:** CPU overheat may occur if the protective film is not removed from the heatsink.
5. Apply the proper amount of thermal grease on the CPU. **Note:** if your heatsink came with a thermal pad, please ignore this step.
6. If necessary, rearrange the wires to make sure that the wires are not pinched between the heatsink and the CPU. Also make sure to keep clearance between the fan wires and the fins of the heatsink.
7. Align the four heatsink fasteners with the mounting holes on the motherboard. Gently push the pairs of diagonal fasteners (#1 & #2, and #3 & #4) into the mounting holes until you hear a click. **Note:** Make sure to orient each fastener in a way that the narrow end of the groove is pointing outward.)
8. Repeat Step 6 to insert all four heatsink fasteners into the mounting holes.
9. Once all four fasteners are securely inserted into the mounting holes and the heatsink is properly installed on the motherboard, connect the heatsink fan wires to the CPU Fan connector.

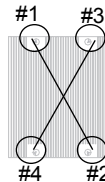
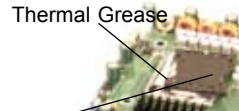
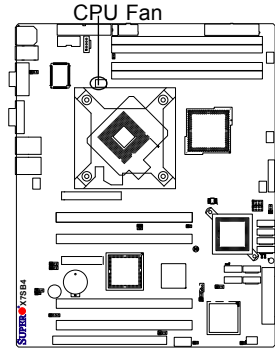

Narrow end of the groove points outward

Heatsink Removal

1. Unplug the power cord from the power supply.
2. Disconnect the heatsink fan wires from the CPU fan header.
3. Use your finger tips to gently press on the fastener cap and turn it counterclockwise to make a 1/4 (90°) turn, and then pull the fastener upward to loosen it.
4. Repeat Step 3 to loosen all fasteners from the mounting holes.
5. With all fasteners loosened, remove the heatsink from the CPU.



2-3 Mounting the Motherboard in the Chassis

All motherboards have standard mounting holes to fit different types of chassis. Make sure that the locations of all the mounting holes for both the motherboard and the chassis match. Although a chassis may have both plastic and metal mounting fasteners, metal ones are highly recommended because they ground the motherboard to the chassis. Make sure that the metal standoffs click in or are screwed in tightly. Then use a screwdriver to secure the motherboard onto the motherboard tray.

Note: some components are very close to the mounting holes. Please take all necessary precautionary measures to prevent damage done to these components when installing the motherboard into the chassis.



Caution: To avoid damaging the motherboard and its components, please do not use a force greater than 8 lb/inch on each mounting screw during motherboard installation.

2-4 Installing DDR2 Memory

Memory Module Installation



Exercise extreme care when installing or removing memory modules to prevent any possible damage.

1. Insert each DDR2 memory module vertically into its slot. Pay attention to the notch along the bottom of the module to prevent inserting the module incorrectly. (See support information below.)
2. Gently press down on the memory module until it snaps into place.

Support

The X7SB4/X7SBE supports dual or single channel, ECC/Non-ECC unbuffered DDR2 800/667 SDRAM. Both interleaved and non-interleaved memory are supported, so you may populate any number of DIMM slots. (Populating DIMM#1A, DIMM#2A, and/or DIMM#1B, DIMM#2B with memory modules of the same size and of the same type will result in two-way interleaved memory which is faster than the single channel, non-interleaved memory. When ECC memory is used, it may take 25-40 seconds for the VGA to display.)

Notes

- Due to chipset limitation, 8GB Memory can only be supported by the following operating systems:
32-Bit: Windows 2000 Advanced Server, Windows Server 2003 Enterprise Edition;
64-Bit: Windows Server 2003 Standard x64 Edition, Windows XP Professional x64 Edition, Windows Server 2003 Enterprise x64 Edition
- Some old-version of DDR2-667 may not match Intel's On-Die-Temperature requirement and will automatically be down-graded to run @ 533 MHz, If this occurs, contact your memory vendor to check the ODT value.
- Due to memory allocation to system devices, memory remaining available for operational use will be reduced when 4 GB of RAM is used. The reduction in memory availability is disproportional. (Refer to the Memory Availability Table below for details.) **Note to Microsoft users:** Microsoft implemented a design change in Windows XP with Service Pack 2 (SP2) and Windows Vista. This change is specific to the Physical Address Extension (PAE) mode behavior which improves driver compatibility. For more information, please read the following article at Microsoft's Knowledge Base website at: <http://support.microsoft.com/kb/888137>.

Possible System Memory Allocation & Availability		
System Device	Size	Physical Memory Remaining (-Available) (4 GB Total System Memory)
Firmware Hub flash memory (System BIOS)	1 MB	3.99
Local APIC	4 KB	3.99
Area Reserved for the chipset	2 MB	3.99
I/O APIC (4 Kbytes)	4 KB	3.99
PCI Enumeration Area 1	256 MB	3.76
PCI Express (256 MB)	256 MB	3.51
PCI Enumeration Area 2 (if needed) -Aligned on 256-MB boundary-	512 MB	3.01
VGA Memory	16 MB	2.85
TSEG	1 MB	2.84
Memory available to OS and other applications		2.84

DDR2 Installation

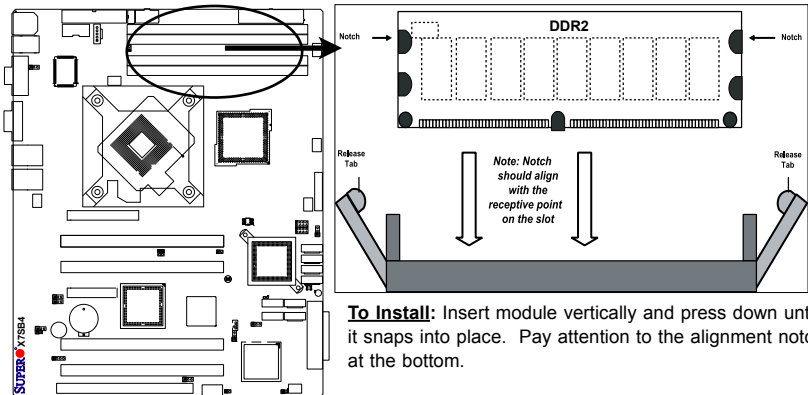

To Install: Insert module vertically and press down until it snaps into place. Pay attention to the alignment notch at the bottom.

To Remove:

Use your thumbs to gently push the release tabs near both ends of the module. This should release it from the slot.

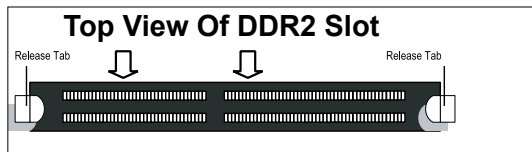

2-5 Control Panel Connectors/IO Ports

The I/O ports are color coded in conformance with the PC 99 specification. See Figure 2-3 below for the colors and locations of the various I/O ports.

A. Back Panel Connectors/IO Ports

Back Panel I/O Port Locations and Definitions

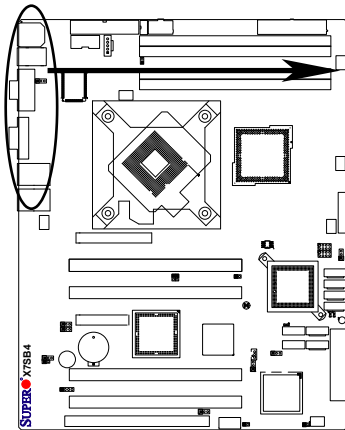
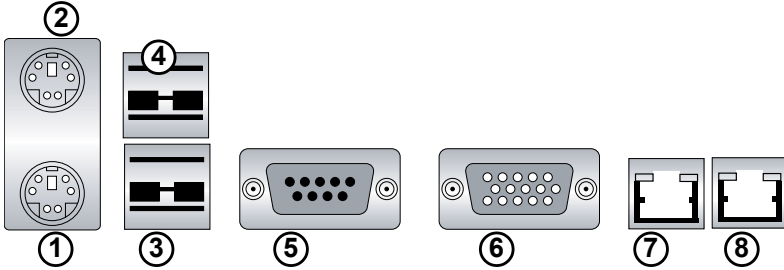

Back Panel Connectors

1. Keyboard (Purple)
2. PS/2 Mouse (Green)
3. Backpanel USB 0
4. Backpanel USB 1
5. COM Port 1 (Turquoise)
6. VGA Port (Blue)
7. Gigabit LAN 1
8. Gigabit LAN 2

See Section 2-5 for details.

Backpanel USB 7/8 are OEM only

B. Front Control Panel

JF1 contains header pins for various buttons and indicators that are normally located on a control panel at the front of the chassis. These connectors are designed specifically for use with Supermicro server chassis. See Figure 2-4 for the descriptions of the various control panel buttons and LED indicators. Refer to the following section for descriptions and pin definitions.

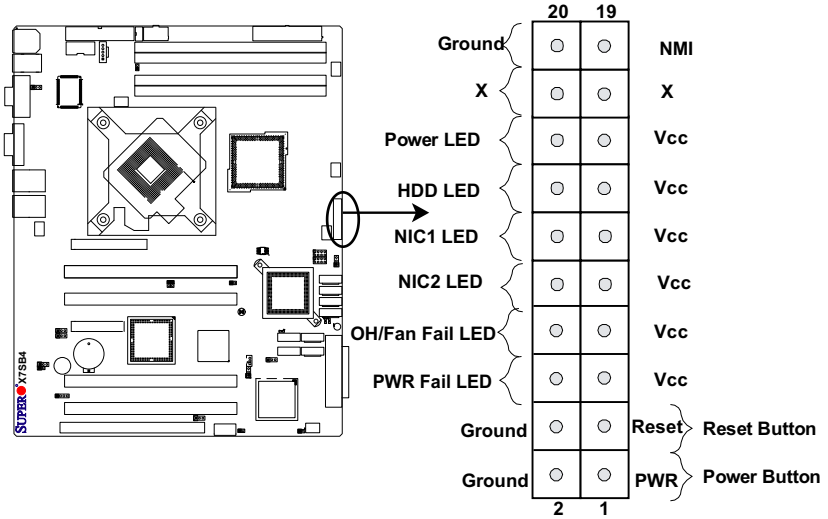

C. Front Control Panel Pin Definitions

NMI Button

The non-maskable interrupt button header is located on pins 19 and 20 of JF1. Refer to the table on the right for pin definitions.

NMI Button Pin Definitions (JF1)	
Pin#	Definition
19	Control
20	Ground

Power LED

The Power LED connection is located on pins 15 and 16 of JF1. Refer to the table on the right for pin definitions.

Power LED Pin Definitions (JF1)	
Pin#	Definition
15	+5V
16	Ground

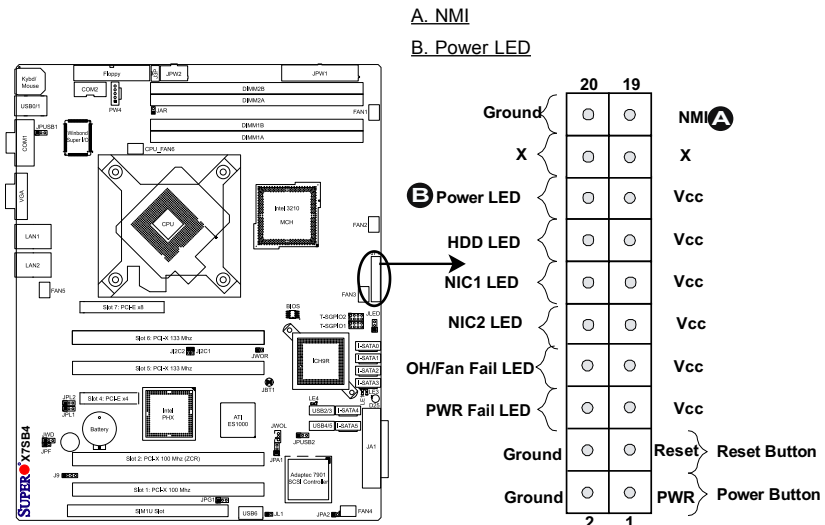

HDD LED

The HDD LED connection is located on pins 13 and 14 of JF1. Attach the hard drive LED cable here to display disk activity (for any hard drives on the system, including SAS, Serial ATA and IDE, if available). See the table on the right for pin definitions.

HDD LED Pin Definitions (JF1)	
Pin#	Definition
13	+5V
14	HD Active

NIC1/NIC2 LED Indicators

The NIC (Network Interface Controller) LED connection for GLAN port1 is located on pins 11 and 12 of JF1 and the LED connection for GLAN Port2 is on Pins 9 and 10. Attach the NIC LED cables to display network activity. Refer to the table on the right for pin definitions.

GLAN1/2 LED Pin Definitions (JF1)	
Pin#	Definition
9/11	Vcc
10/12	Ground

- A. HDD LED
- B. NIC1 LED
- C. NIC2 LED

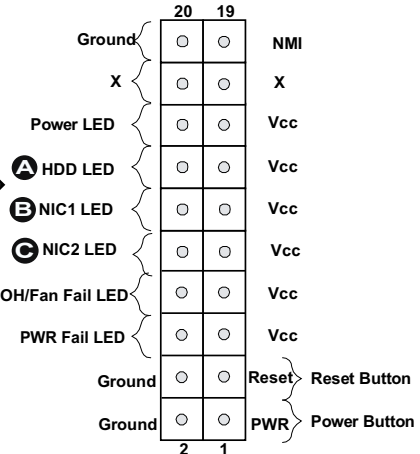
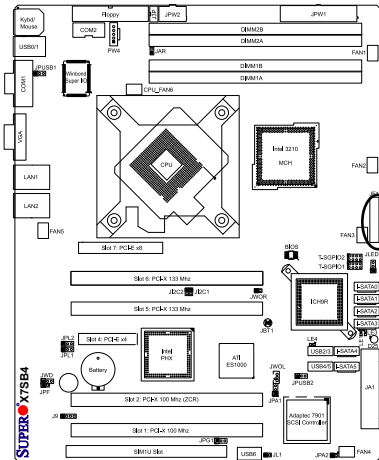

Overheat/Fan Fail LED (OH)

Connect an LED to the OH/Fan Fail connection on pins 7 and 8 of JF1 to provide advanced warnings of chassis overheating or fan failure. Refer to the table on the right for pin definitions.

OH/Fan Fail LED Pin Definitions (JF1)	
Pin#	Definition
7	Vcc
8	Ground

OH/Fan Fail Indicator Status	
State	Definition
Off	Normal
On	Overheat
Flashing	Fan Fail

Power Fail LED

The Power Fail LED connection is located on pins 5 and 6 of JF1. Refer to the table on the right for pin definitions.

Power Fail LED Pin Definitions (JF1)	
Pin#	Definition
5	Vcc
6	Ground

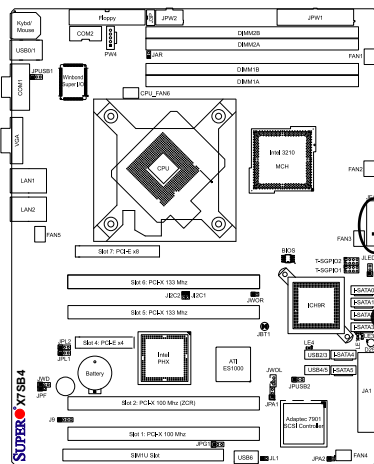

A. OH/Fan Fail LED

B. Power Supply Fail

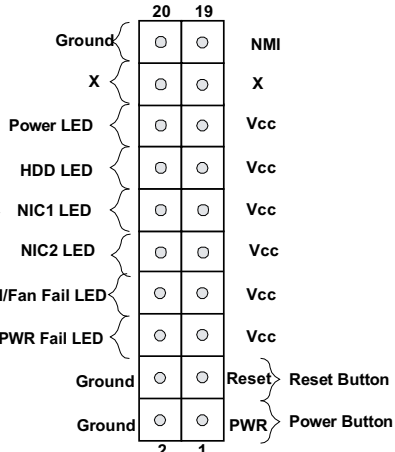

Reset Button

The Reset Button connection is located on pins 3 and 4 of JF1. Attach it to the hardware reset switch on the computer case. Refer to the table on the right for pin definitions.

Reset Button Pin Definitions (JF1)	
Pin#	Definition
3	Reset
4	Ground

Power Button

The Power Button connection is located on pins 1 and 2 of JF1. Momentarily contacting both pins will power on/off the system. This button can also be configured to function as a suspend button (with a setting in the BIOS - see Chapter 4). To turn off the power when set to suspend mode, press the button for at least 4 seconds. Refer to the table on the right for pin definitions.

Power Button Pin Definitions (JF1)	
Pin#	Definition
1	PWR Signal
2	Ground

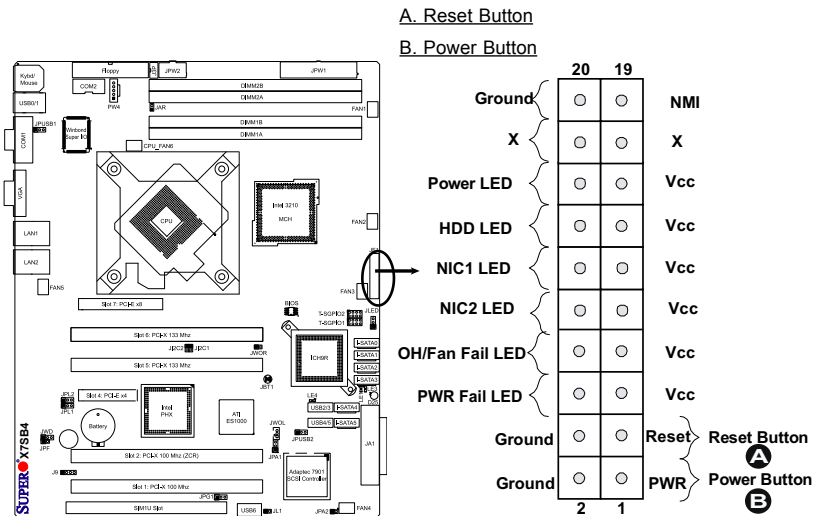

2-6 Connecting Cables

ATX Power Connector

A 24-pin main power supply connector is located at JPW1 and an 8-pin CPU Power connector is located at JPW2 on the motherboard. These power connectors meet the SSI EPS 12V specification. For the 8-pin Power (JPW2), please refer to the item listed below.

Processor Power Connector

In addition to the Primary ATX power connector (above), the 12V 8-pin CPU Power connector at JPW2 must also be connected to your power supply. See the table on the right for pin definitions.

ATX Power 24-pin Connector Pin Definitions			
Pin#	Definition	Pin #	Definition
13	+3.3V	1	+3.3V
14	-12V	2	+3.3V
15	COM	3	COM
16	PS_ON	4	+5V
17	COM	5	COM
18	COM	6	+5V
19	COM	7	COM
20	Res (NC)	8	PWR_OK
21	+5V	9	5VSB
22	+5V	10	+12V
23	+5V	11	+12V
24	COM	12	+3.3V

12V 8-pin Power CPU Connector Pin Definitions

Pins	Definition
1 through 4	Ground
5 through 8	+12V

Required Connection

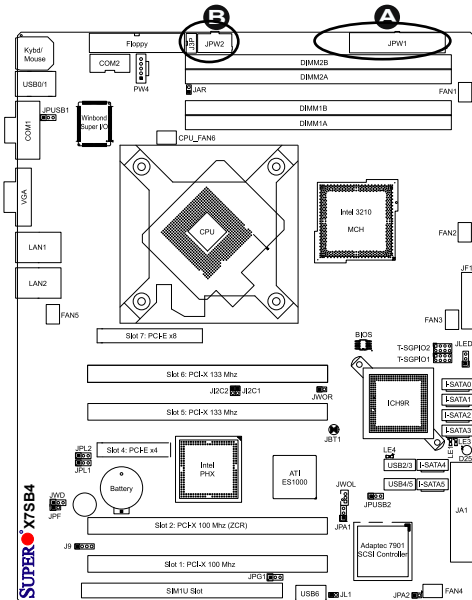

A. 24-pin ATX Power

B. 8-pin Processor Power

Universal Serial Bus (USB)

There are seven USB 2.0 (Universal Serial Bus) ports/headers on the motherboard. Two of them are Back Panel USB ports-USB 0/1 (J15). FP USB 6 (J47) is a front panel USB connector. Another two USB Headers-USB 2/3 (J44) and USB4/5 (J45) can provide front USB access. See the tables on the right for pin definitions.

Note: BP USB 7/8 are for OEM only.

Back Panel USB (J15)	
Pin#	Definitions
1	+5V
2	PO-
3	PO+
4	Ground
5	N/A

Front Panel & Front Accessible USB Pin Definitions (J44, J45, J47)			
USB2, USB4, USB6		USB3, USB5	
Pin #	Definition	Pin #	Definition
1	+5V	1	+5V
2	PO-	2	PO-
3	PO+	3	PO+
4	Ground	4	Ground
5	No connection	5	Key

Chassis Intrusion

A Chassis Intrusion header is located at JL1 on the motherboard. Attach an appropriate cable from the chassis to inform you of a chassis intrusion when the chassis is opened.

Chassis Intrusion Pin Definitions (JL1)	
Pin#	Definition
1	Intrusion Input
2	Ground

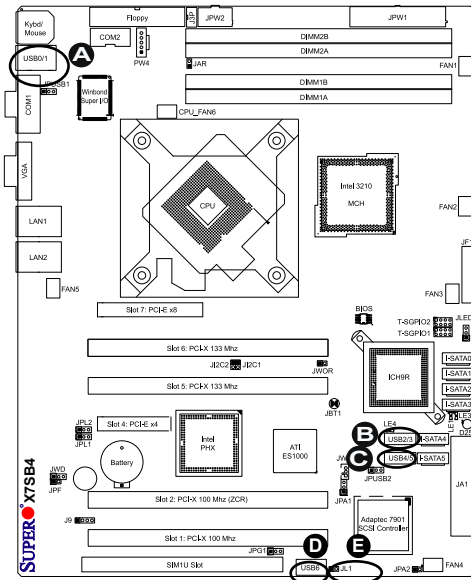

- A. Backpanel USB 0/1
- B. Front Accessible USB 2/3
- C. Front Accessible USB 4/5
- D. Front Panel USB 6
- E. Chassis Intrusion

ATX PS/2 Keyboard and PS/2 Mouse Ports

The ATX PS/2 keyboard and the PS/2 mouse are located at J28. See the table on the right for pin definitions. (The mouse port is above the keyboard port.) See the table on the right for pin definitions.

PS/2 Keyboard and Mouse Port Pin Definitions	
Pin#	Definition
1	Data
2	NC
3	Ground
4	VCC
5	Clock
6	NC

Serial Ports

COM1 (J31) is a connector located on the IO Backpanel and COM2 is a header located at J13. See the table on the right for pin definitions.

Serial Port Pin Definitions (COM1/COM2)			
Pin #	Definition	Pin #	Definition
1	CD	6	DSR
2	RD	7	RTS
3	TD	8	CTS
4	DTR	9	RI
5	Ground	10	NC

(Pin 10 is available on COM2 only.
NC: No Connection.)

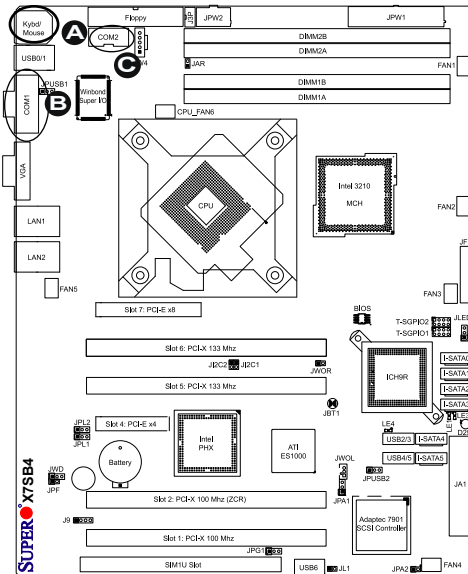

A. Power Button

B. COM1

C. COM2

Power LED

The Power LED connector is located at JLED. This connection provides LED Indication of power supplied to the system. See the table on the right for pin definitions.

Power LED Pin Definitions	
Pin#	Definition
1	+5V
2	Key
3	Ground

External Speaker/Internal Buzzer

On the J9 header, pins 1-4 are for an External Speaker and pins 3-4 are for the Internal Buzzer. See the table on the right for speaker pin definitions. Note: Connect a cable to pins 1-4 to use an external speaker. If you wish to use the onboard buzzer, you should close pins 3-4 with a cap.

Speaker Connector	
Pin Setting	Definition
Pins 3-4	Internal Speaker
Pins 1-4	External Speaker

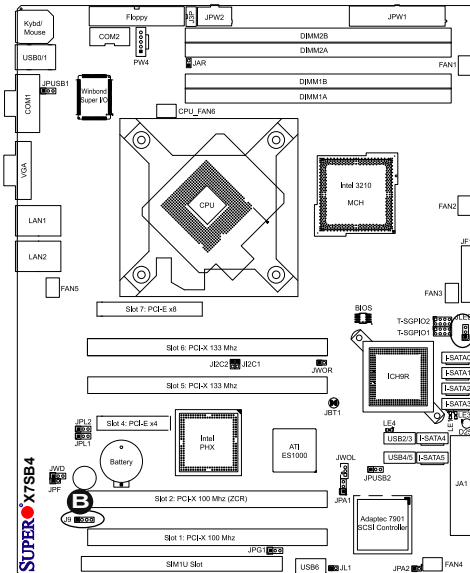

A. Power LED

B. Speaker

GLAN (Giga-bit Ethernet Ports)



Two G-bit Ethernet ports (GLAN1/GLAN2) are located next to the VGA Connector on the IO backplane. These ports accept RJ45 type cables.

VGA Connector

A VGA connector (J16) is located between COM1 and GLAN1 on the IO backplane. Refer to the board layout below for the location.

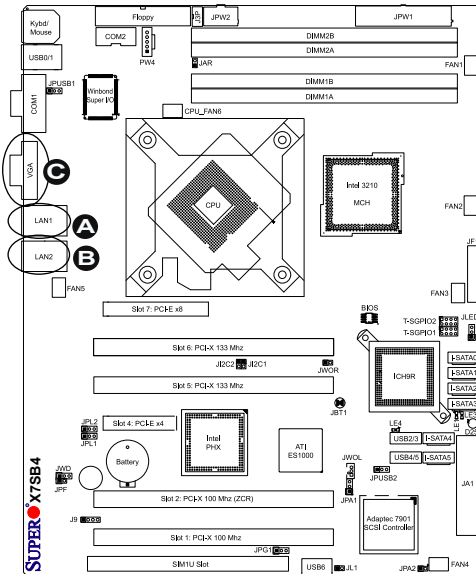

- A. GLAN1
- B. GLAN2
- C. VGA

Fan Headers

The X7SB4/X7SBE has five chassis/system fan headers (Fan1 to Fan5) and one CPU Fan (CPU Fan6). All these fans are 4-pin fans. However, Pins 1-3 of the fan headers are backward compatible with the traditional 3-pin fans. See the table on the right for pin definitions. The on-board fan speeds are controlled by Thermal Management via BIOS Hardware Monitoring in the Advanced Setting.

Notes: 1. The Default setting is Disabled. 2. Please use all 3-pin fans or all 4-pin fans on the motherboard. Please do not use 3-pin fans and 4-pin fans on the same board.)

4-pin Fan Header Pin Definitions	
Pin#	Definition
1	Ground
2	+12V
3	Tachometer
4	PWR Modulation

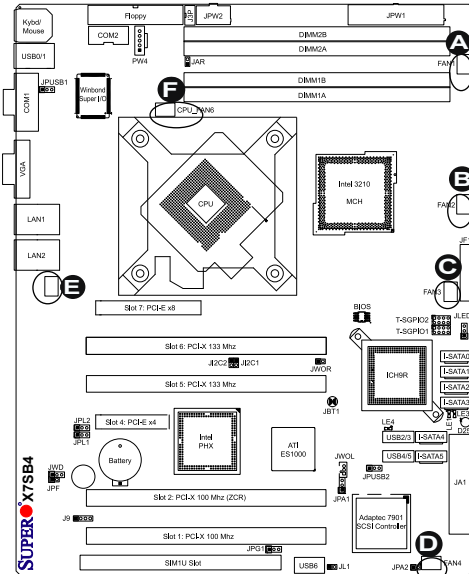

- A. Fan 1
- B. Fan 2
- C. Fan 3
- D. Fan 4
- E. Fan 5
- F. Fan 6 (CPU Fan)

Wake-On-Ring

The Wake-On-Ring header is located at JWOR. This feature allows your computer to be awakened by an incoming call to the modem when the system is in the suspend state. See the table on the right for pin definitions. You must have a Wake-On-Ring card and a cable to use this feature.

Wake-On-Ring Pin Definitions (JWOR)	
Pin#	Definition
1	Ground
2	Wake-up

Wake-On-LAN

The Wake-On-LAN header is located at JWOL on the motherboard. See the table on the right for pin definitions. (You must also have a LAN card with a Wake-On-LAN connector and cable to use this feature.)

Wake-On-LAN Pin Definitions (JWOL)	
Pin#	Definition
1	+5V Standby
2	Ground
3	Wake-up

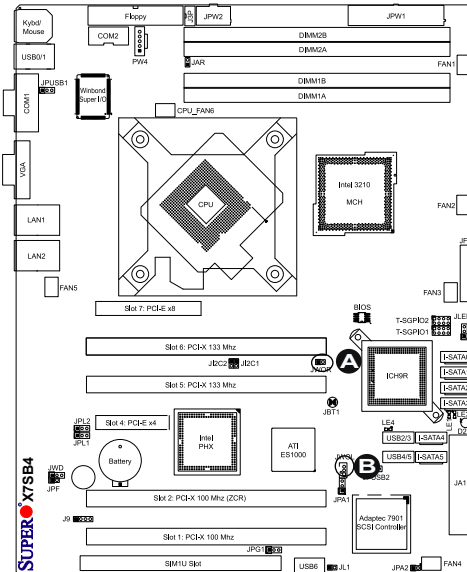

A. WOR

B. WOL

Power Fault (Power Supply Failure)

Connect a cable from your power supply to the Power Fail (J3P) header to provide a warning in the event of a power supply failure. This warning signal is passed through the PWR_LED pin to indicate of a power failure on the chassis. See the table on the right for pin definitions.

PWR Supply Fail Pin Definitions	
Pin#	Definition
1	PWR 1: Fail
2	PWR 2: Fail
3	PWR 3: Fail
4	Signal: Alarm Reset

Note: This feature is only available when using Supermicro redundant power supplies.

Power SMB (I²C) Connector

Power SMB (I²C) Connector (PW4) is used to monitor Power supply, fan and system temperature. See the table on the right for pin definitions.

PWR SMB Pin Definitions	
Pin#	Definition
1	Clock
2	Data
3	PWR Fail
4	Ground
5	+3.3V

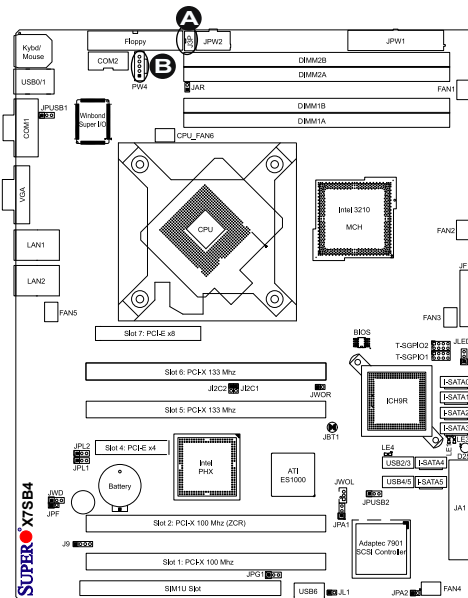

A. Power Fault

B. Power SMB

Serial_Link GPIO Headers

Two Serial_Link General Purpose Input/Output (GPIO) headers (T_SPIO1 & T_SPIO2) are located on the motherboard. These headers are used to communicate with the System Monitoring Chip on the backplane. See the table on the right for pin definitions. Refer to the board layout below for the locations of the headers.

SATA_GPIO Pin Definitions			
Pin#	Definition	Pin	Definition
1	NC	2	NC
3	Ground	4	DATA Out
5	Load	6	Ground
7	Clock	8	NC

Note: NC= No Connections

Alarm Reset

If three power supplies are installed, the system will notify you when any of the three power modules fails. Connect JPR1 to a micro-switch to enable you to turn off the alarm that is activated when a power module fails. See the table on the right for pin definitions.

Alarm Reset Pin Definitions	
Pin Setting	Definition
Pin 1	+5V
Pin 2	Ground

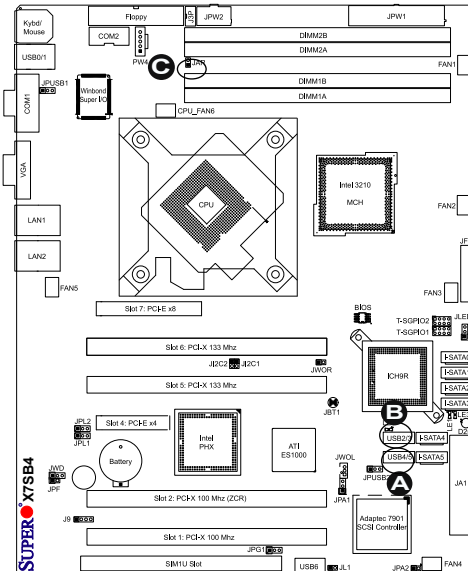

- A. T_SPIO1
- B. T_SPIO2
- C. Alarm Reset

2-7 Jumper Settings

Explanation of Jumpers

To modify the operation of the motherboard, jumpers can be used to choose between optional settings. Jumpers create shorts between two pins to change the function of the connector. Pin 1 is identified with a square solder pad on the printed circuit board. See the motherboard layout pages for jumper locations. **Note:** On two pin jumpers, "Closed" means the jumper is on and "Open" means the jumper is off the pins.

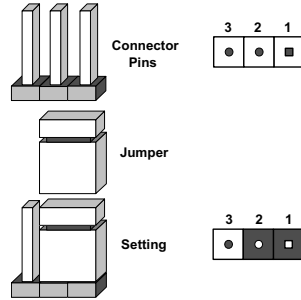

GLAN Enable/Disable

JPL1/JPL2 enable or disable the GLAN ports on the motherboard. See the table on the right for jumper settings. The default setting is enabled.

GLAN Enable Jumper Settings	
Pin#	Definition
1-2	Enabled (default)
2-3	Disabled

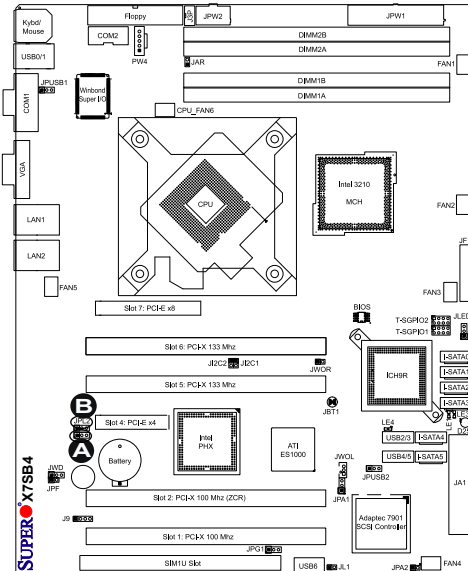

A. GLAN1 Enable

B. GLAN2 Enable

CMOS Clear

JBT1 is used to clear CMOS. Instead of pins, this "jumper" consists of contact pads to prevent the accidental clearing of CMOS. To clear CMOS, use a metal object such as a small screwdriver to touch both pads at the same time to short the connection. Always remove the AC power cord from the system before clearing CMOS. **Note:** For an ATX power supply, you must completely shut down the system, remove the AC power cord and then short JBT1 to clear CMOS. **Do not use the PW_ON connector to clear CMOS.**



Watch Dog Enable/Disable

JWD allows you to enable the Watch Dog timer. Watch Dog is used for system monitoring. It can cause the system to reboot when a software application hangs. Close Pins 1-2 to reset the system if an application hangs. Close Pins 2-3 to generate a non-maskable interrupt signal for the application that hangs. See the table on the right for jumper settings. Watch Dog must also be enabled in the BIOS.

Watch Dog Jumper Settings (JWD)	
Jumper Setting	Definition
Pins 1-2	Reset (default)
Pins 2-3	NMI
Open	Disabled

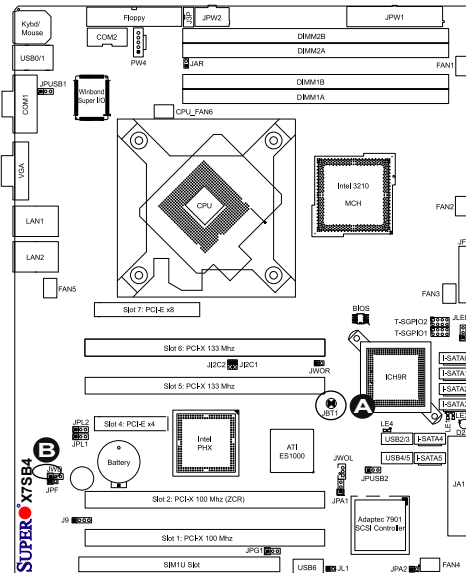

A. Clear CMOS

B. Watch Dog Enable

SMBus to PCI/PCI-Exp. Slots

Jumpers J1²C1, J1²C2 allow your PCI/PCI-E cards to be connected to the System Management Bus. The default setting is Open to disable the connection. See the table on the right for jumper settings.

SMB to PCI Enable Jumper Settings	
Pin#	Definition
Open	Disabled (default)
Closed	Enabled

VGA Enable/Disable

JPG1 enables or disables the VGA Connector on the motherboard. See the table on the right for jumper settings. The default setting is enabled.

VGA Enable Jumper Settings	
Pin#	Definition
Pins 1-2	Enabled (default)
Pins 2-3	Disabled

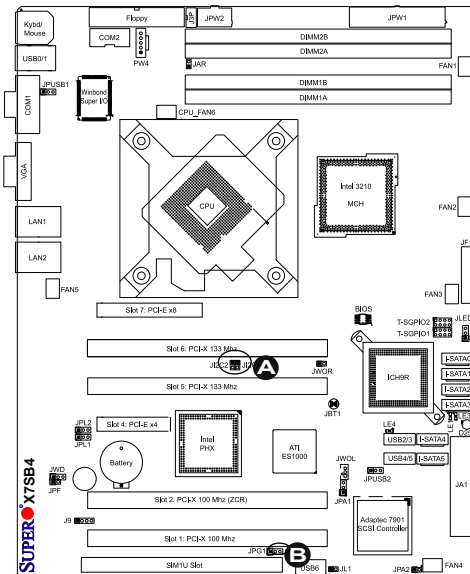

A. SMB to PCI

B. VGA Enable

SCSI Enable/Disable (X7SB4 Only)

Jumper JPA1 allows you to enable or disable the SCSI Controller. The default setting is to close Pins 1-2 to enable the SCSI connection. See the table on the right for jumper settings.

SCSI Enable Jumper Settings	
Pin#	Definition
Pins 1-2	Enabled (default)
Pins 2-3	Disabled

SCSI Termination Enable/Disable (X7SB4 Only)

Jumpers JPA2 allows you to enable or disable the termination of the SCSI connector. The default setting is open to enable (-to terminate-) the SCSI channel. (For SCSI to function properly, please do not change the default setting.) See the table on the right for jumper settings.

SCSI Termination Enable Jumper Settings	
Pin#	Definition
Open	Enabled (default)
Closed	Disabled

(Default: Open: Do not change the default setting!)

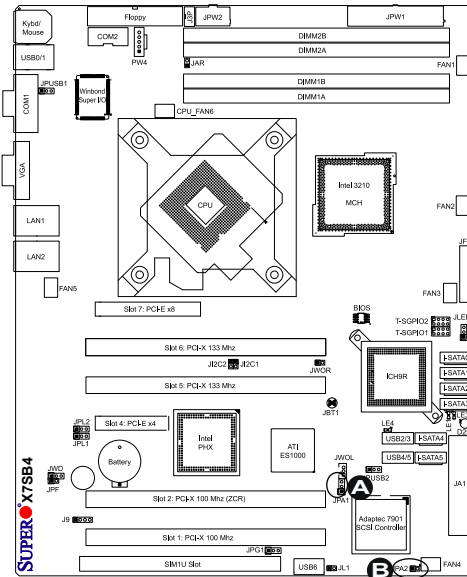

- A. SCSI Enable
- B. SCSI Termination Enable

USB Wake-Up

Use JPUSB jumpers to enable the function of "System Waking-Up via USB devices". These jumpers allow you to "wake up" the system by pressing a key on the USB keyboard or by clicking the USB mouse of your system. The JPUSB jumpers are used together with the USB Wake-Up function in the BIOS. Enable the jumper and the BIOS setting to use this feature. See the table on the right for jumper settings and jumper connections. **Note:** JPUSB1 is for Back Panel USB ports:0/1, 7/8, and JPUSB2 is for Front Panel USB ports:2/3,4/5/6.

USB Wake-Up Jumper Settings	
Jumper Setting	Definition
Pins 1-2	Enabled
Pins 2-3	Disabled

Note: JPUSB1 should be enabled by default to allow BP USB0 and BP USB1 to wake up from Standby Modes. However, the default jumper setting for the JPUSB2 is Disabled. When the USB Wake-Up feature is enabled in the BIOS, and the selected USB ports are also enabled via the JPUSB jumpers, please be sure to remove all other USB devices from the USB ports whose USB jumpers are set to Disabled before the system goes into the standby mode.

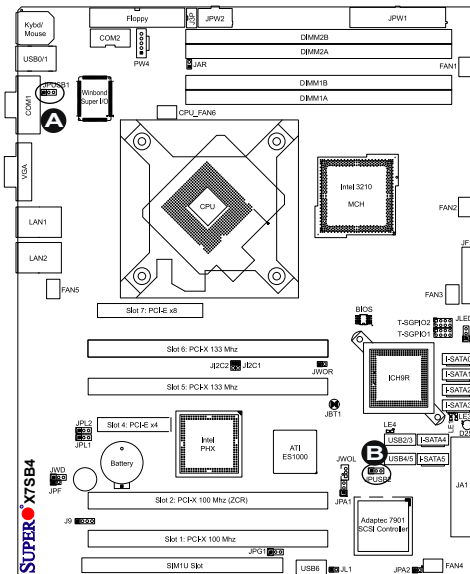

A. JPUSB1

B. JPUSB2

Force-Power-On Enable

Jumper JPF allows you to enable or disable the feature of Force-Power-On. If enabled, the power will always stay on automatically. If this function disabled, the user needs to press the power button to power on the system.

Power Force On Jumper Settings	
Pin#	Definition
Off	Normal
On	Force On

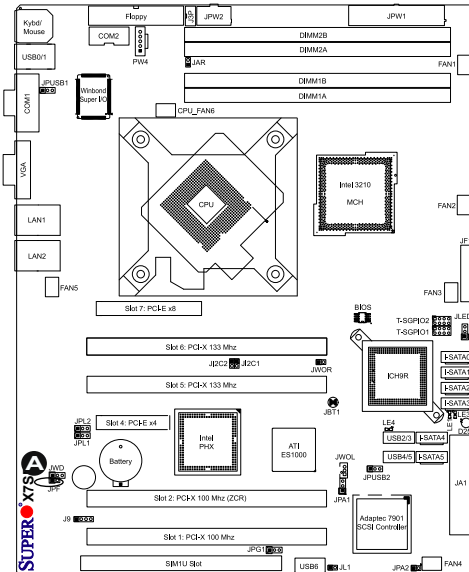

A. Power Force On

2-8 Onboard Indicators

GLAN LEDs

There are two Gigabit-LAN ports. A Gigabit Ethernet LAN port has two LEDs. The yellow GLAN Activity LED (right, see below) indicates activity, while the GLAN Link/Speed LED (left, see below) indicates the speed of the connection. See the tables at right for more information.

GLAN Link/Speed LED Indicator	
LED Color	Definition
Off	No Connection or 10 Mbps
Green (On)	100 Mbps
Amber (On)	1 Gbps

GLAN Activity LED Indicator	
Color	Definition
Yellow (Flashing)	ConnectionActive

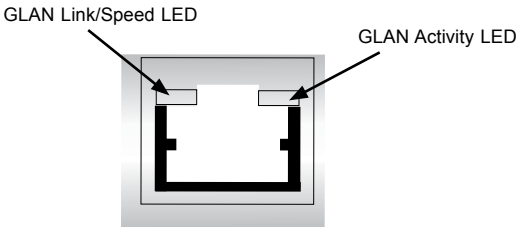

Rear View
(When viewing from the rear side of the chassis.)

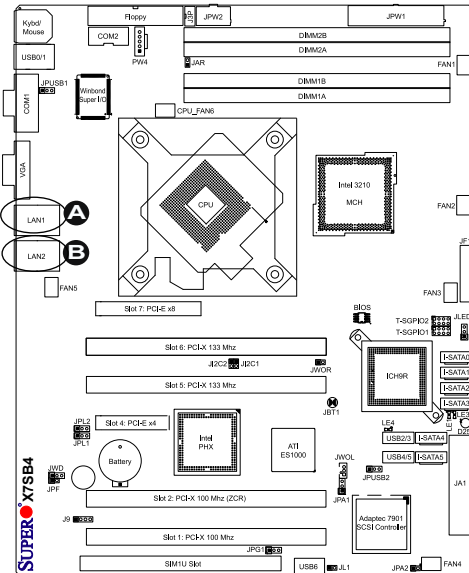

- A. GLAN1
- B. GLAN2

Onboard Power LED

An Onboard Power LED is located at LE1 on the motherboard. When LE1 is off, the system is off. When the green light is on, the system is on. Make sure to disconnect the power cable before removing or installing components. See the layout below for the LED location.

Onboard PWR LED Indicator (LE1) LED Settings	
LED Color	Definition
Off	System Off
Green	System on

POST LEDs

Two POST (Power-On Self Test) LEDs are located at LE3, LE4 on the motherboard. The green LED is LE3; while the yellow LED is LE4. These LEDs indicate POST activities during system bootup. Refer to the table on the right for details. Also see the layout below for the LED locations.

POST LED Indicators (LE3/LE4) LED Settings		
	LE3	LE4
	Green	Yellow
POST	On	On
Memory Initial.	Blinking	Blinking
PCI Initialization	On	Blinking
Video Initial.	Blinking	On
POST Completed	Off	Off

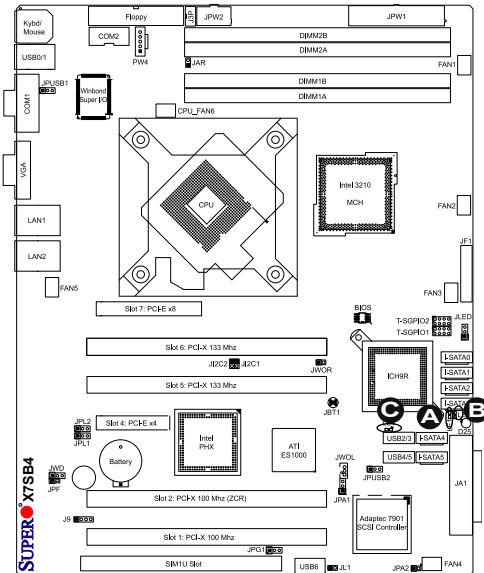

- A. LE1
- B. LE3
- C. LE4

System Status LED

A System Status LED is located at D25 on the motherboard. When the green light is on, the system is normal. When the orange light is on, the system is in a standby mode, but the AC power cable is still connected. When is red light is on, it indicates power errors. See the layout below for the LED location.

System Status LED Indicator LED Settings	
LED Color	Definition
Green	System: Normal
Orange	System: Standby, PWR Cable Connected
Red	Possible PWR Errors

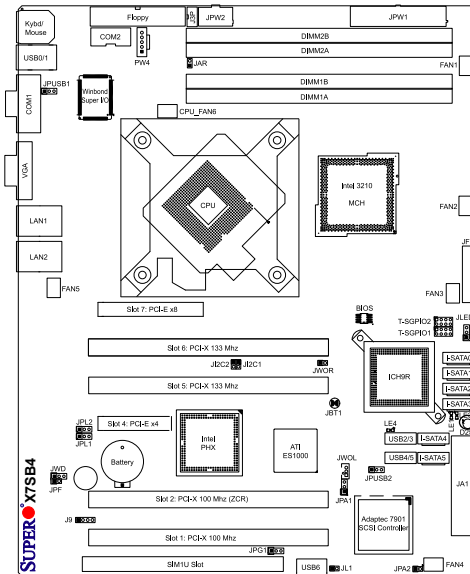

A. D25

2-9 Floppy, Hard Disk Drive, SIM 1U IPMI and SCSI Connections

Note the following when connecting the floppy and hard disk drive cables:

- The floppy disk drive cable has seven twisted wires.
- A red mark on a wire typically designates the location of pin 1.
- A single floppy disk drive ribbon cable has two connectors to provide for two floppy disk drives. The connector with twisted wires always connects to drive A, and the connector that does not have twisted wires always connects to drive B.

Floppy Connector

The floppy connector is located at J27. See the table below for pin definitions.

Floppy Drive Connector Pin Definitions (Floppy)			
Pin#	Definition	Pin #	Definition
1	Ground	2	FDHDIN
3	Ground	4	Reserved
5	Key	6	FDEDIN
7	Ground	8	Index
9	Ground	10	Motor Enable
11	Ground	12	Drive Select B
13	Ground	14	Drive Select B
15	Ground	16	Motor Enable
17	Ground	18	DIR
19	Ground	20	STEP
21	Ground	22	Write Data
23	Ground	24	Write Gate
25	Ground	26	Track 00
27	Ground	28	Write Protect
29	Ground	30	Read Data
31	Ground	32	Side 1 Select
33	Ground	34	Diskette

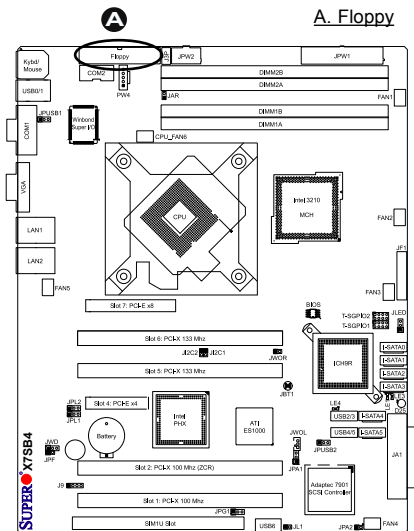

Ultra 320 SCSI Connector (X7SB4 only)

An Ultra 320 SCSI connector is located at JA1 on the motherboard. Refer to the table below for the pin definitions.

SIM IU IPMI

A SIM IU IPMI Socket is located at J19 on the motherboard. This connection provides IPMI (Intelligent Power Management Interface) connection to the motherboard. Refer to the layout below for the SIM IU IPMI location.

Ultra320 SCSI Drive Connector Pin Definitions			
Pin#	Definition	Pin #	Definition
1	+DB (12)	35	-DB (12)
2	+DB (13)	36	-DB (13)
3	+DB (14)	37	-DB (14)
4	+DB (15)	38	-DB (15)
5	+DB (P1)	39	-DB (P1)
6	+DB (0)	40	-DB (0)
7	+DB (1)	41	-DB (1)
8	+DB (2)	42	-DB (2)
9	+DB (3)	43	-DB (3)
10	+DB (4)	44	-DB (4)
11	+DB (5)	45	-DB (5)
12	+DB (6)	46	-DB (6)
13	+DB (7)	47	-DB (7)
14	+DB (P)	48	-DB (P)
15	Ground	49	Ground
16	DIFFSENS	50	Ground
17	TERMPWR	51	TERMPWR
18	TERMPWR	52	TERMPWR
19	Reserved	53	Reserved
20	Ground	54	Ground
21	+ATN	55	-ATN
22	Ground	56	Ground
23	+BSY	57	-BSY
24	+ACK	58	-ACK
25	+RST	59	-RST
26	+MSG	60	-MSG
27	+SEL	61	-SEL
28	+C/D	62	-C/D
29	+REQ	63	-REQ
30	+I/O	64	-I/O
31	+DB (8)	65	-DB (8)
32	+DB (9)	66	-DB (9)
33	+DB (10)	67	-DB (10)
34	+DB (11)	68	-DB (11)

A. Ultra 320 SCSI

B. SIM IU IPMI

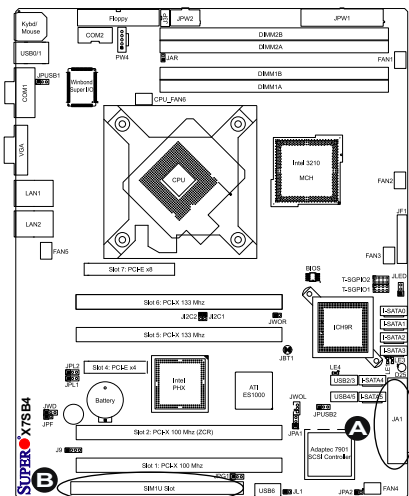

Notes

Chapter 3

Troubleshooting

3-1 Troubleshooting Procedures

Use the following procedures to troubleshoot your system. If you have followed all of the procedures below and still need assistance, refer to the 'Technical Support Procedures' and/or 'Returning Merchandise for Service' section(s) in this chapter. Always disconnect the AC power cord before adding, changing or installing any hardware components.

Before Power On

1. Make sure that the 8-pin 12v power connector is connected.
2. Make sure that there are no short circuits between the motherboard and chassis.
3. Disconnect all ribbon/wire cables from the motherboard, including those for the keyboard and mouse.
4. Remove all add-on cards. Install a CPU and heatsink (making sure that it is fully seated) and then, connect the chassis speaker and the power LED to the motherboard.

No Power

1. Make sure that there are no short circuits between the motherboard and the chassis.
2. Make sure that all jumpers are set to their default positions.
3. Check if the 115V/230V switch on the power supply is properly set. Turn the power switch on and off to test the system.
4. The battery on your motherboard may be old. Check to verify that it still supplies ~3VDC. If it does not, replace it with a new one.

No Video

1. If the power is on, but you have no video--in this case, you will need to remove all the add-on cards and cables first.
2. Use the speaker to determine if any beep codes exist. (Refer to Appendix A for details on beep codes.)
3. Remove all memory modules and turn on the system. (If the alarm is on, check the specifications of memory modules, reset the memory or try different modules.)

NOTE

If you are a system integrator, VAR or OEM, a POST diagnostics card is recommended. For I/O port 80h codes, refer to App. B.

Memory Errors

1. Make sure that the DIMM modules are properly installed and fully seated in the slots.
2. You should be using unbuffered, ECC/Non-ECC DDR2-800/677 memory (See the next page). Also, it is recommended that you use the same memory speed for all DIMMs in the system. See Section 2-4 for memory limitations.

Check for bad DIMM modules or slots by swapping modules between slots and noting the results. Check the power supply voltage 115V/230V switch.

Losing the System's Setup Configuration

1. Please be sure to use a high quality power supply. A poor quality power supply may cause the system to lose the CMOS setup information. Refer to Section 1-6 for details on recommended power supplies.
2. The battery on your motherboard may be old. Check to verify that it still supplies ~3VDC. If it does not, replace it with a new one.
3. If the above steps do not fix the Setup Configuration problem, contact your vendor for repairs.

3-2 Technical Support Procedures

Before contacting Technical Support, please make sure that you have followed all the steps listed below. Also, note that as a motherboard manufacturer, Supermicro does not sell directly to end-users, so it is best to first check with your distributor or reseller for troubleshooting services. They should know of any possible problem(s) with the specific system configuration that was sold to you.

1. Please go through the 'Troubleshooting Procedures' and 'Frequently Asked Question' (FAQ) sections in this chapter or see the FAQs on our web site (<http://www.supermicro.com/support/faqs/>) before contacting Technical Support.
2. BIOS upgrades can be downloaded from our web site at (<http://www.supermicro.com/support/bios/>). **Note: Not all BIOS can be flashed. Some cannot be flashed; it depends on the modifications to the boot block code.**

3. *If you've followed the instructions above to troubleshoot your system, and still cannot resolve the problem, then please contact Supermicro's technical support and provide them with the following information:*
 - Motherboard model and PCB revision number
 - BIOS release date/version (this can be seen on the initial display when your system first boots up)
 - System configuration
 - An example of a Technical Support form is on our web site at (<http://www.supermicro.com/support/contact.cfm>).
 - Distributors: For immediate assistance, please have your account number ready when placing a call to our technical support department.

We can be reached by e-mail at support@supermicro.com, by phone at: (408) 503-8000, option 2, or by fax at (408)503-8019.

3-3 Frequently Asked Questions

Question: What type of memory does my motherboard support?

Answer: The X7SB4/X7SBE supports up to 8 GB of **unbuffered**, ECC/Non-ECC, DDR2-800/677, two-way interleaved or non-interleaved SDRAM. See Section 2-4 for details on installing memory.

Question: Why does Microsoft Windows XP (SP2) and Windows Vista show less memory than what is physically installed?

Answer: Microsoft implemented a design change in Windows XP with Service Pack 2 (SP2) and Windows Vista. This change is specific to the Physical Address Extension (PAE) mode behavior which improves driver compatibility. For more information, please read the following article at Microsoft's Knowledge Base website at: <http://support.microsoft.com/kb/888137>.

Question: How do I update my BIOS?

Answer: It is recommended that you **do not** upgrade your BIOS if you are not experiencing any problems with your system. Updated BIOS files are located on our web site at <http://www.supermicro.com/support/bios/>. Please check our BIOS warning message and the information on how to update your BIOS on our web site. Select your motherboard model and download the BIOS (.rom) file to your computer. Also, check the current BIOS revision and make sure that it is newer than your BIOS before downloading. You may choose the zip file or the .exe file. If you choose the zipped BIOS file, please unzip the BIOS file onto a bootable device or a USB pen/thumb drive. To flash the BIOS, run the batch file named "flash.bat" with the new BIOS .rom file from your bootable device or USB pen/thumb drive. Use the following format:

F:\> flash xxxxxxxx.rom <Enter>

Note: Be sure to insert a space immediately after "flash" and use only the file named "flash.bat" to update the BIOS.

When completed, your system will automatically reboot. If you choose the .exe file, please run the .exe file under Windows to create the BIOS flash floppy disk. Insert the floppy disk into the system you wish to flash the BIOS. Then, boot the system to the floppy disk. The BIOS utility will automatically flash the BIOS without any prompts. Please note that this process may take a few minutes to complete. Do not be concerned if the screen is paused for a few minutes.



Warning: Do not shut down or reset the system while updating the BIOS to prevent possible system boot failure!

When the BIOS flashing screen is completed, the system will reboot and will show "Press F1 or F2". At this point, you will need to load the BIOS defaults. Press <F1> to go to the BIOS setup screen, and press <F9> to load the default settings. Next, press <F10> to save and exit. The system will then reboot.

Note: The SPI BIOS chip installed on this motherboard is not removable. To repair or replace a damaged BIOS chip, please send your motherboard to RMA at Supermicro for service.

3-4 Returning Merchandise for Service

A receipt or copy of your invoice marked with the date of purchase is required before any warranty service will be rendered. You can obtain service by calling your vendor for a Returned Merchandise Authorization (RMA) number. When returning to the manufacturer, the RMA number should be prominently displayed on the outside of the shipping carton, and mailed prepaid or hand-carried. Shipping and handling charges will be applied for all orders that must be mailed when service is complete.

This warranty only covers normal consumer use and does not cover damages incurred in shipping or from failure due to the alteration, misuse, abuse or improper maintenance of products.

During the warranty period, contact your distributor first for any product problems.

For faster service, RMA authorizations may be requested online (<http://www.supermicro.com/support/rma/>).

Chapter 4

BIOS

4-1 Introduction

This chapter describes the Phoenix BIOS™ Setup utility for the X7SB4/X7SBE. The Phoenix ROM BIOS is stored in a flash chip and can be easily upgraded using a floppy disk-based program.

Note: Due to periodic changes to the BIOS, some settings may have been added or deleted and might not yet be recorded in this manual. Please refer to the Manual Download area of the Supermicro web site <<http://www.supermicro.com>> for any changes to the BIOS that may not be reflected in this manual.

System BIOS

BIOS is the Basic Input Output System used in all IBM® PC, XT™, AT®, and PS/2® compatible computers. The Phoenix BIOS stores the system parameters, types of disk drives, video displays, etc. in the CMOS. The CMOS memory requires very little electrical power. When the computer is turned off, a backup battery provides power to the CMOS logic, enabling it to retain system parameters. Each time the computer is powered on the computer is configured with the values stored in the CMOS logic by the system BIOS, which gains control at boot up.

How To Change the Configuration Data

The CMOS information that determines the system parameters may be changed by entering the BIOS Setup utility. This Setup utility can be accessed by pressing the <Delete> key at the appropriate time during system boot. (See below.)

Starting the Setup Utility

Normally, the only visible POST (Power On Self Test) routine is the memory test. As the memory is being tested, press the <Delete> key to enter the main menu of the BIOS Setup utility. From the main menu, you can access the other setup screens, such as the Security and Power menus. Beginning with Section 4-3, detailed descriptions are given for each parameter setting in the Setup utility.



Warning: Do not shut down or reset the system while updating BIOS to prevent possible boot failure.

Note: The SPI BIOS chip used in the X7SB4/X7SBE is not removable. To replace a damaged SPI BIOS chip, please send the motherboard to Supermicro for repair.

4-2 Running Setup

Default settings are in bold text unless otherwise noted.

The BIOS setup options described in this section are selected by choosing the appropriate text from the main BIOS Setup screen. All displayed text is described in this section, although the screen display is often all you need to understand how to set the options (See the next page).

When you first power on the computer, the Phoenix BIOS™ is immediately activated.

While the BIOS is in control, the Setup program can be activated in one of two ways:

1. By pressing <Delete> immediately after turning the system on, or
2. When the message shown below appears briefly at the bottom of the screen during the POST (Power On Self-Test), press the <Delete> key to activate the main Setup menu:

Press the <Delete> key to enter Setup

4-3 Main BIOS Setup

All main Setup options are described in this section. The main BIOS Setup screen is displayed below.

Use the Up/Down arrow keys to move among the different settings in each menu. Use the +/- arrow keys to change the options for each setting.

Press the <Esc> key to exit the CMOS Setup Menu. The next section describes in detail how to navigate through the menus.

Items that use submenus are indicated with the ► icon. With the item highlighted, press the <Enter> key to access the submenu.

Main BIOS Setup Menu

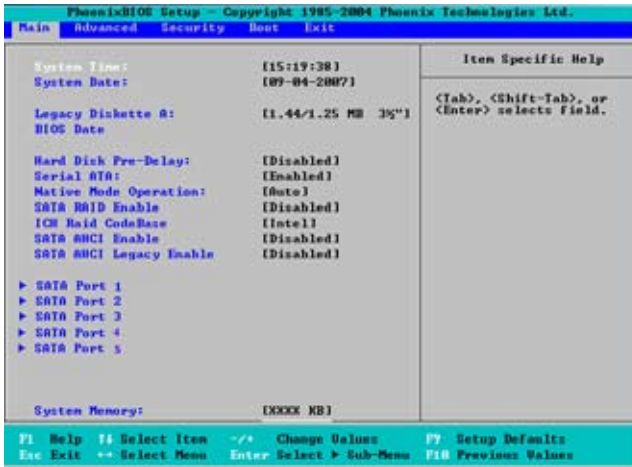

Main Setup Features

System Time

To set the system date and time, key in the correct information in the appropriate fields. Then press the <Enter> key to save the data.

System Date

Using the arrow keys, highlight the month, day and year fields, and enter the correct data. Press the <Enter> key to save the data.

Legacy Diskette A

This setting allows the user to set the type of floppy disk drive installed as diskette A. The options are Disabled, 360Kb 5.25 in, 1.2MB 5.25 in, 720Kb 3.5 in, **1.44/1.25MB**, 3.5 in and 2.88MB 3.5 in.

BIOS Date

The item displays the date that the BIOS was built.

BIOS Revision

This item displays the BIOS revision number.

Hard Disk Pre-Delay

When Enabled, this feature will add a delay to provide time need for HDD self-initialization before the HDD is accessed by the BIOS for the first time. Some HDDs will hang if accessed by the BIOS without proper initialization. The options are 3, 6, 9, 12, 15, 21, 30 (seconds), and **Disabled**.

Serial ATA

This setting allows the user to enable or disable the function of Serial ATA. The options are Disabled and **Enabled**.

Native Mode Operation

Select Serial ATA to use the SATA mode, or select Auto to use the Native Mode for ATA. The options are: Serial ATA and **Auto**.

Serial ATA (SATA) RAID Enable

Select Enable to enable Serial ATA RAID Functions. (For the Windows OS environment, use the RAID driver if this feature is set to Enabled. When this item is set to Enabled, the item: ICH RAID Code Base will be available for you to select either Intel or Adaptec Host RAID firmware to be activated. If this item is set to **Disabled**, the item-SATA AHCI Enable will be available.) The options are Enabled and **Disabled**.

ICH RAID Code Base

Select Intel to enable the Intel SATA RAID firmware. Select Adaptec to use the Adaptec HostRAID firmware. The options are **Intel** and Adaptec.

SATA AHCI

Select Enable to enable the function of Serial ATA Advanced Host Interface. (Take caution when using this function. This feature is for advanced programmers only. The Enhanced AHCI mode is available when the Windows XP-SP1 OS and the IAA Driver is used.) The options are Enabled and **Disabled**.

SATA AHCI Legacy

Select Enable to use Legacy Mode for SATA Advanced Host Interfacing. When this feature is set to Enabled, SATA Port 5 and SATA Port 6 are disabled. (Take caution when using this function. This feature is for advanced programmers only.) The options are Enabled and **Disabled**.

►SATA Port0/SATA Port1/SATA Port2/SATA Port3/SATA Port4/SATA Port5

These settings allow the user to set the parameters of SATA0~SATA 5 connections. Hit <Enter> to activate the following sub-menu screen for detailed options of these items. Set the correct configurations accordingly. The items included in the sub-menu are:

Type

This option allows the user to select the type of a SATA device. Select **Auto** to allow the BIOS to automatically configure the parameters of a SATA device installed on a slot. Select User to allow the user to enter the parameters of the

SATA device installed. Select CDROM if a CDROM drive is installed. Select ATAPI or IDE Removable if a removable disk drive is installed.

CHS Format

The following items will be displayed by the BIOS:

TYPE: This item displays the type of a SATA drive.

Cylinders: This item indicates the number of cylinders detected by the BIOS.

Headers: This item indicates the number of headers.

Sectors: This item displays the number of sectors.

Maximum Capacity: This item displays the maximum storage capacity in the CHS Format.

LBA Format

The following items will be displayed by the BIOS:

Total Sectors: This item displays the number of total sectors available in the LBA Format.

Maximum Capacity: This item displays the maximum capacity in the LBA Format.

Multi-Sector Transfers

This item allows the user to specify the number of sectors per block to be used in multi-sector transfer. The options are Disabled, 2 Sectors, 4 Sectors, 8 Sectors, and **16 Sectors**.

LBA Mode Control

This item determines whether the Phoenix BIOS will access a SATA device via the LBA mode. The options are **Enabled** and Disabled.

32 Bit I/O

This option allows the user to enable or disable the function of 32-bit data transfer. The options are Enabled and **Disabled**.

Transfer Mode

This option allows the user to set the transfer mode. The options are Standard, Fast PIO1, Fast PIO2, Fast PIO3, Fast PIO4, FPIO3/DMA1 and **FPIO4/DMA2**.

Ultra DMA Mode

This option allows the user to configure the Ultra DMA Mode setting. The options are Disabled, Mode 0, Mode 1, Mode 2, Mode 3, Mode 4, and **Mode 5**.

Installed Memory

This display informs you how much total memory is detected by the BIOS.

Post Errors

Select **Enabled** to temporarily halt system boot and display POST (Power-On-Self Testing) error messages when errors occur during bootup. Select Disable to continue with system boot even when an error occurs. The options are **Enabled** and Disabled.

System Memory

This display informs you how much system memory is available in the system.

4-4 Advanced Setup

Choose Advanced from the Phoenix BIOS Setup Utility main menu with the arrow keys. You should see the following display. The items with a triangle beside them have sub menus that can be accessed by highlighting the item and pressing <Enter>.



► Boot Features

Access the submenu to make changes to the following settings.

Quiet Mode

This setting allows you to **Enable** or Disable the graphic logo screen during boot-up.

QuickBoot Mode

If enabled, this feature will speed up the POST (Power On Self Test) routine by

skipping certain tests after the computer is turned on. The settings are **Enabled** and **Disabled**. If **Disabled**, the POST routine will run at normal speed.

ACPI Mode

Select **Yes** to **use** the ACPI (Advanced Configuration and Power Interface) power management feature on your system. The options are **Yes** and **No**.

Power Button Behavior

If set to **Instant-Off**, the system will power on or power off immediately as soon as the user hits the power button. The options are **Instant-Off** and **4-Second Override**.

Resume On Modem Ring

Select **On** to “wake your system up” when an incoming call is received by your modem. The options are **On** and **Off**.

Resume On PME#

Select **On** to “wake your system up” from the PME# of PCI slots. The options are **On** and **Off**.

PS2 Keyboard (KB)/Mouse Wake Up

Select **Enable** to “wake your system up” from the S1, S4 or S5 state. If this feature is set to **Enabled**, you will also need to enable the JPWAKE jumper by closing pins 1-2. (Please refer to Pg. 1-5 and Chapter 2 for more details). The default setting is **Disabled**.

USB Wake Up

This setting allows you to wake up the system from S4 state. Make sure to set the proper jumper first for USB wake up. The options are **Enabled** and **Disabled**.

Power Loss Control

This setting allows you to choose how the system will react when power returns after an unexpected loss of power. The options are **Stay Off**, **Power On**, and **Last State**.

Watch Dog

If enabled, this option will automatically reset the system if the system is not active for more than 5 minutes. The options are **Enabled** and **Disabled**.

Summary Screen

This setting allows you to **Enable** or **Disable** the summary screen which displays the system configuration during bootup.

► Advanced Processor Options

Access the submenu to make changes to the following settings.

CPU Speed

This is a display that indicates the speed of the installed processor.

Frequency Ratio (Available when supported by the CPU)

The feature allows the user to set the internal frequency multiplier for the CPU. The default setting is **Default**.

Frequency High Ratio (Available when supported by the CPU)

The feature allows the user to set high ratio internal frequency multiplier for Intel SpeedStep CPUs. The default setting is **x12**.

Note: If a wrong ratio that is not supported by the CPU is selected, the system may hang. If this happens, clear CMOS to recover the system.)

Hyper-threading (Available when supported by the CPU)

Set to Enabled to use the Hyper-Threading Technology, which will result in increased CPU performance. The options are Disabled and **Enabled**.

Core-Multi-Processing (Available when supported by the CPU)

Set to Enabled to use a processor's Second Core and beyond. (Please refer to Intel's web site for more information.) The options are Disabled and **Enabled**.

Machine Checking (Available when supported by the CPU)

Set to Enabled to activate the function of Machine Checking and allow the CPU to detect and report hardware (machine) errors via a set of model-specific registers (MSRs). The options are **Enabled** and Disabled.

Compatible FPU Code (Available when supported by the CPU)

Set to Enabled to keep the content of the last instruction Operating Code (OP Code) in the floating point (FP) state. The options are **Disabled** and Enabled.

Thermal Management 2 (Available when supported by the CPU)

Set to **Enabled** to use Thermal Management 2 (TM2) which will lower CPU voltage and frequency when the CPU temperature reaches a predefined overheat threshold. Set to Disabled to use Thermal Manager 1 (TM1), allowing CPU clocking to be regulated via CPU Internal Clock modulation when the CPU temperature reaches the overheat threshold.

Adjacent Cache Line Prefetch (Available when supported by the CPU)

The CPU fetches the cache line for 64 bytes if this option is set to Disabled. The

CPU fetches both cache lines for 128 bytes as comprised if Enabled. The options are Disabled and **Enabled**.

Set Maximum Ext. CPUID=3

When set to Enabled, the Maximum Extended CPUID will be set to 3. The options are **Disabled** and Enabled.

Echo TPR

Set to **Enabled** to prevent xTPR messages from being sent to the system. The options are Disabled and **Enabled**.

C1 Enhanced Mode (Available when supported by the CPU)

Set to Enabled to enable Enhanced Halt State to lower CPU voltage/frequency to prevent overheat. The options are Enabled and **Disabled**. **Note:** please refer to Intel's web site for detailed information.

Intel® Virtualization Technology (Available when supported by the CPU)

Select Enabled to use the feature of Virtualization Technology to allow one platform to run multiple operating systems and applications in independent partitions, creating multiple "virtual" systems in one physical computer. The options are Enabled and **Disabled**. **Note:** If there is any change to this setting, you will need to power off and restart the system for the change to take effect. Please refer to Intel's web site for detailed information.

No Execute Mode Memory Protection (Available when supported by the CPU and the OS.)

Set to **Enabled** to enable Execute Disable Bit and allow the processor to classify areas in memory where an application code can execute and where it cannot, and thus preventing a worm or a virus from inserting and creating a flood of codes to overwhelm the processor or damage the system during an attack.

Note: this feature is available when your OS and your CPU support the function of Execute Disable Bit. The options are Disabled and **Enabled**. **Note:** For more information regarding hardware/software support for this function, please refer to Intel's and Microsoft's web sites.

Enhanced Intel Speed Step Support (Available when supported by the CPU)

Select Enabled use the Enhanced Intel SpeedStep Technology and allows the system to automatically adjust processor voltage and core frequency in an effort to reduce power consumption and heat dissipation. The options are Disabled, **GV1/GV3 Only** and Enabled. Please refer to Intel's web site for detailed information.

► Advanced Chipset Control

Access the submenu to make changes to the following settings.



Warning: Take Caution when changing the Advanced settings. An incorrect value, a very high DRAM frequency, or an incorrect DRAM timing may cause the system to become unstable. When this occurs, reset the setting to the default setting.

Clock Spectrum Feature

If Enabled, BIOS will monitor the level of Electromagnetic Interference caused by the components and will attempt to decrease the interference whenever needed. The options are **Disabled** and Enabled.

Memory Remapping

Select Enable to enable the functionality of Memory Remapping above 4GB. The settings are **Enabled** and Disabled.

Enable VT-d

Select Enable to enable the functionality of the Intel Virtualization Technology for Direct I/O support, which offers fully-protected I/O resource-sharing across the Intel platforms, providing the user with greater reliability, security and availability in networking and data-sharing. The settings are Enabled and **Disabled**.

High Precision Event Time

Select Yes to activate the High Precision Event Timer (HPET), which is capable of producing periodic interrupts at a much higher frequency than a Real-time Clock (RTC) can in synchronizing multimedia streams, providing smooth playback and reducing the dependency on other timestamp calculation devices, such as an x86 RDTSC Instruction embedded in a CPU. The High Precision Event Timer is used to replace the 8254 Programmable Interval Timer. The options for this feature are Yes and **No**.

Route Port 80h Cycles to

This feature allows the user to decide which bus to send debug information to. The options are PCI and **LPC**.

USB Host Controller

This feature allows the user to configure the USB Host Controller setting for USB Device #29 Functions 0, 1, 2, 3, 7. The options are **Enabled** and Disabled.

EHCI Controller

This feature enables the onboard Enhanced Host Controller Interface. The options **Enabled** and Disabled.

Legacy USB Support

This setting allows you to enable support for Legacy USB devices. The settings are **Enabled** and Disabled.

► Memory Cache

Cache System BIOS Area

This setting allows you to designate a reserve area in the system memory to be used as a System BIOS buffer to allow the BIOS to write (cache) data into this reserved memory area. Select **Write Protect** to enable this function, and this area will be reserved for BIOS ROM access only. Select Uncached to disable this function and make this area available for other devices.

Cache Video BIOS Area

This setting allows you to designate a reserve area in the system memory to be used as a Video BIOS buffer to allow the BIOS to write (cache) data into this reserved memory area. Select **Write Protect** to enable the function and this area will be reserved for Video BIOS ROM access only. Select Uncached to disable this function and make this area available for other devices.

Cache Base 0-512K

If enabled, this feature will allow the data stored in the base memory area: block 0-512K to be cached (written) into a buffer, a storage area in the Static DROM (SDROM) or to be written into the L1, L2 cache inside the CPU to speed up CPU operations. Select Uncached to disable this function. Select Write Through to allow data to be cached into the buffer and written into the system memory at the same time. Select Write Protect to prevent data from being written into the base memory area of Block 0-512K. Select Write Back to allow the CPU to write data back directly from the buffer without writing data to the System Memory for fast CPU data processing and operation. The options are Uncached, Write Through, Write Protect, and **Write Back**.

Cache Base 512K-640K

If enabled, this feature will allow the data stored in the memory area: 512K-640K to be cached (written) into a buffer, a storage area in the Static DROM (SDROM) or written into the L1, L2, L3 cache inside the CPU to speed up CPU operations. Select Uncached to disable this function. Select Write Through to allow data to be cached into the buffer and written into the system memory at the same time. Select Write Protect to prevent data from being written into the base memory area of Block 512K-640K. Select Write Back to allow the CPU to write data back directly from the buffer without writing data to the System Memory for fast CPU data processing and operation. The options are Uncached, Write Through, Write Protect, and **Write Back**.

Cache Extended Memory

If enabled, this feature will allow the data stored in the extended memory area to be cached (written) into a buffer, a storage area in the Static DROM (SDROM) or written into the L1, L2, L3 cache inside the CPU to speed up CPU operations. Select **Uncached** to disable this function. Select **Write Through** to allow data to be cached into the buffer and written into the system memory at the same time. Select **Write Protect** to prevent data from being written into the extended memory area above 1 MB. Select **Write Back** to allow the CPU to write data back directly from the buffer without writing data to the System Memory for fast CPU data processing and operation. The options are **Uncached**, **Write Through**, **Write Protect**, and **Write Back**.

► PnP Configuration

Access the submenu to make changes to the following settings for PCI devices.

PCI-X(s) Frequency

When set to **Enabled**, this feature allows the user to set the bus frequency for a PCI-X slot for it to work properly. The default setting is **Auto**.

► Slot 1 PCI-X 100 MHz/Slot 2 PCI-X 100 MHz ZCR

Access the submenu for each of the settings above to make changes to the following:

Option ROM Scan

When enabled, this setting will initialize the device expansion ROM. The options are **Enabled** and **Disabled**.

Enable Master

This setting allows you to enable the selected device as the PCI bus master. The options are **Enabled** and **Disabled**.

Latency Timer

This setting allows you to set the clock rate for Bus Master. A high-priority, high-throughput device may benefit from a greater clock rate. The options are **Default**, 0020h, 0040h, 0060h, 0080h, 00A0h, 00C0h, and 00E0h. For Unix, Novelle and other Operating Systems, please select the option: other. If a drive fails after the installation of a new software, you might want to change this setting and try again. A different OS requires a different Bus Master clock rate.

(ZCR slot is available on the X7SB4 only.)

► Slot 4 PCI-Exp. X4 / Slot 7 PCI-Exp. X8

Access the submenu for each of the settings above to make changes to the following:

Option ROM Scan

When enabled, this setting will initialize the device expansion ROM. The options are **Enabled** and Disabled.

Enable Master

This setting allows you to enable the selected device as the PCI bus master. The options are **Enabled** and Disabled.

Latency Timer

This setting allows you to set the clock rate for Bus Master. A high-priority, high-throughout device may benefit from a greater clock rate. The options are **Default**, 0020h, 0040h, 0060h, 0080h, 00A0h, 00C0h, and 00E0h. For Unix, Novelle and other Operating Systems, please select the option: other. If a drive fails after the installation of a new software, you might want to change this setting and try again. A different OS requires a different Bus Master clock rate.

► Slot 5 PCI-X 133 MHz/Slot 6 PCI-X 133 MHz

Access the submenu for each of the settings above to make changes to the following:

Option ROM Scan

When enabled, this setting will initialize the device expansion ROM. The options are **Enabled** and Disabled.

Enable Master

This setting allows you to enable the selected device as the PCI bus master. The options are **Enabled** and Disabled.

Latency Timer

This setting allows you to set the clock rate for Bus Master. A high-priority, high-throughout device may benefit from a greater clock rate. The options are **Default**, 0020h, 0040h, 0060h, 0080h, 00A0h, 00C0h, and 00E0h. For Unix, Novelle and other Operating Systems, please select the option: other. If a drive fails after the installation of a new software, you might want to change this setting and try again. A different OS requires a different Bus Master clock rate.

► Onboard LAN 1/Onboard LAN 2

Access the submenu for each of the settings above to make changes to the following:

Option ROM Scan

When enabled, this setting will initialize the device expansion ROM. The options are Enabled and **Disabled**.

Enable Master

This setting allows you to enable the selected device as the PCI bus master. The options are Enabled and **Disabled**.

Latency Timer

This setting allows you to set the clock rate for Bus Master. A high-priority, high-throughput device may benefit from a greater clock rate. The options are **Default**, 0020h, 0040h, 0060h, 0080h, 00A0h, 00C0h, and 00E0h. For Unix, Novelle and other Operating Systems, please select the option: other. If a drive fails after the installation of a new software, you might want to change this setting and try again. A different OS requires a different Bus Master clock rate.

► I/O Device Configuration

Access the submenu to make changes to the following settings.

KBC Clock Input

This setting allows you to select clock frequency for the keyboard clock. The options are 6MHz, 8MHz, **12MHz**, and 16MHz.

Serial Port A

This setting allows you to assign control of Serial Port A. The options are **Enabled** (user defined) and Disabled.

Base I/O Address

This setting allows you to select the base I/O address for Serial Port A. The options are **3F8**, 2F8, 3E8, and 2E8.

Interrupt

This setting allows you to select the IRQ (interrupt request) for Serial Port A. The options are IRQ3 and **IRQ4**.

Serial Port B

This setting allows you to assign control of Serial Port B. The options are **Enabled** (user defined) and Disabled.

Mode

This setting allows you to set the type of device that will be connected to Serial Port B. The options are **Normal**, IR and ASK-IR (Infra-Red Devices).

Base I/O Address

This setting allows you to select the base I/O address for Serial Port B. The options are 3F8, **2F8**, 3E8 and 2E8.

Interrupt

This setting allows you to select the IRQ (interrupt request) for Serial Port B. The options are **IRQ3** and IRQ4.

Floppy Disk Controller

This setting allows you to assign control of the floppy disk controller. The options are **Enabled** (user defined), Disabled, and Auto (BIOS- and OS- controlled).

► **DMI Event Logging**

Access the submenu to make changes to the following settings.

Event Log Validity

This is a display to inform you of the event log validity. It is not a setting.

Event Log Capacity

This is a display to inform you of the event log capacity. It is not a setting.

View DMI Event Log

Highlight this item and press <Enter> to view the contents of the event log.

Event Logging

This setting allows you to **Enable** or Disable event logging.

Mark DMI Events as Read

Highlight this item and press <Enter> to mark the DMI events as read.

Clear All DMI Event Logs

Select Yes and press <Enter> to clear all DMI event logs. The options are Yes and **No**.

► Console Redirection

Access the submenu to make changes to the following settings.

COM Port Address

This item allows you to specify which COM port to direct the remote console to: Onboard COM A or Onboard COM B. This setting can also be **Disabled**.

BAUD Rate

This item allows you to set the BAUD rate for the console redirection. The options are 300, 1200, 2400, 9600, **19.2K**, 38.4K, 57.6K, and 115.2K.

Console Type

This item allows you to set the console redirection type. The options are VT100, VT100,8bit, PC-ANSI, 7bit, **PC ANSI**, VT100+, VT-UTF8 and ASCII.

Flow Control

This item allows you to select the flow control option for the console. The options are: None, XON/XOFF, and **CTS/RTS**.

Console Connection

This item allows you to decide how console redirection is to be connected: either **Direct** or Via Modem.

Continue CR after POST

This feature allows you to decide if you want to continue with console redirection after the POST routine. The options are On and **Off**.

► Hardware Monitoring

CPU Overheat Alarm

This option allows the user to select the CPU Overheat Alarm setting which determines when the CPU OH alarm will be activated to provide warning of possible CPU overheat. Refer to the the next item, **CPU Temperature** for more information regarding PECI, DTS and other thermal features of this motherboard.



Warning: Any temperature that exceeds the CPU threshold temperature predefined by the CPU manufacturer may result in CPU overheat or system instability. When the CPU temperature reaches this predefined threshold, the CPU and system cooling fans will run at full speed.

The options are:

The Default Alarm Setting: Select this setting if you want the CPU overheat alarm (including the LED and the buzzer) to be triggered when the CPU temperature reaches about +5 PECI counts above the threshold temperature as predefined by the CPU manufacturer to give the CPU and system fans additional time needed for CPU and system cooling.

The Early Alarm Setting: Select this setting if you want the CPU overheat alarm (including the LED and the buzzer) to be triggered as soon as the CPU temperature reaches the CPU overheat threshold as predefined by the CPU manufacturer.

CPU Temperature

The CPU Temperature feature will display the CPU temperature status as detected by the BIOS:

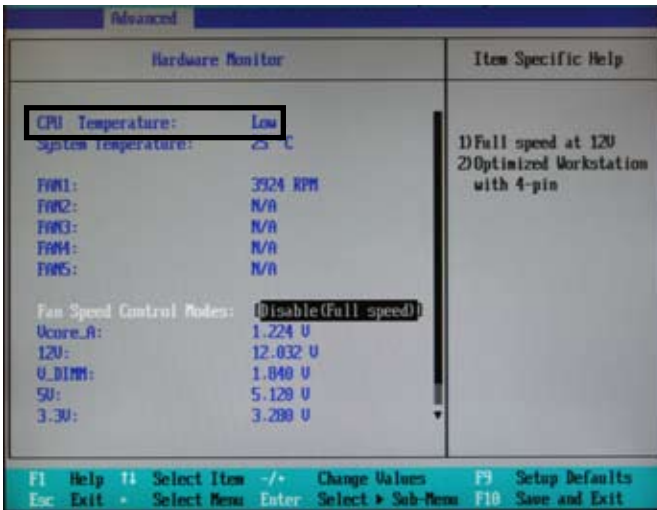

Low – This level is considered as the 'normal' operating state. The CPU temperature is well below the CPU 'Temperature Tolerance'. The motherboard fans and CPU will run normally as configured in the BIOS (Fan Speed Control).

User intervention: No action required.

Medium – The processor is running warmer. This is a 'precautionary' level and generally means that there may be factors contributing to this condition, but the CPU is still within its normal operating state and below the CPU 'Temperature Tolerance'. The motherboard fans and CPU will run normally as configured in the BIOS. The fans may adjust to a faster speed depending on the Fan Speed Control settings.

User intervention: No action is required. However, consider checking the CPU fans and the chassis ventilation for blockage.

High – The processor is running hot. This is a 'caution' level since the CPU's 'Temperature Tolerance' has been reached (or has been exceeded) and may activate an overheat alarm:

The Default Alarm – the Overheat LED and system buzzer will activate if the High condition continues for some time after it is reached. The CPU fan will run at full speed to bring the CPU temperature down. If the CPU temperature still increases even with the CPU fan running at full speed, the system buzzer will activate and the Overheat LED will turn on.

The Early Alarm – the Overheat LED and system buzzer will be activated exactly when the High level is reached. The CPU fan will run at full speed to bring the CPU temperature down.

Note: In both the alarms above, please take immediate action as shown below. See CPU Overheat Alarm to modify the above alarm settings.

User intervention: If the system buzzer and Overheat LED has activated, take action immediately by checking the system fans, chassis ventilation and room temperature to correct any problems. The system may shut down if it continues for a long period to prevent damage to the CPU.



Notes: The CPU thermal technology that reports absolute temperatures (Celsius/Fahrenheit) has been upgraded to a more advanced feature by Intel in its newer processors. The basic concept is that each CPU is embedded by a unique temperature information that the motherboard can read. This 'Temperature Threshold' or 'Temperature Tolerance' has been assigned at the factory and is the baseline by which the motherboard takes action during different CPU temperature conditions (i.e., by increasing CPU Fan speed, triggering the Overheat Alarm, etc). Since CPUs can have different 'Temperature Tolerances', the installed CPU can now send its 'Temperature Tolerance' to the motherboard resulting in better CPU thermal management.

Supermicro has leveraged this feature by assigning a temperature status to certain thermal conditions in the processor (Low, Medium and High). This makes it easier for the user to understand the CPU's temperature status, rather than by just simply seeing a temperature reading (i.e., 25°C).

The information provided above is for your reference only. For more information on thermal management, please refer to Intel's Web site at www.Intel.com.

System Temperature

This item displays the absolute system temperature as detected by the BIOS (i.e., 34°C).

CPU Fan/Fan 1 to Fan 5

If the feature of Auto Fan Control is enabled, the BIOS will automatically display the status of each fan as specified.

Fan Speed Control Modes

This feature allows you to decide how the system controls the speeds of the onboard fans. The CPU temperature and the fan speed are correlative. When the CPU on-die temperature increases, the fan speed will also increase, and vice versa. If the option is set to "4-pin", the fan speed will be controlled by Pulse Width Modulation (PWM). Select "Workstation" or "Server" if your system is used as a Workstation or Server respectively. Select "Disable" to disable the fan speed control function to allow the

onboard fans to constantly run at full speed (12V). The Options are: **1. Disable** and **2. 3-pin (server) 3-pin (workstation), 4-pin (server) and 4-pin (workstation)**. Do not select 4-pin settings if you have a mix of 3-pin and 4-pin fans.

Voltage Monitoring

The following items will be monitored and displayed:

Vcore A, MCH Core, -12V, VDIMM, +3.3V, +12V, +5Vsb, +5VDD, P_VTT, Vbat

Note: In the Windows OS environment, the Supero Doctor III settings take precedence over the BIOS settings. When first installed, Supero Doctor III adopts the temperature threshold settings previously set in the BIOS. Any subsequent changes to these thresholds must be made within Supero Doctor, since the SD III settings override the BIOS settings. For the Windows OS to adopt the BIOS temperature threshold settings, please change the SDIII settings to be the same as those set in the BIOS.

►IPMI (The option is available only when an IPMI card is installed in the system.)

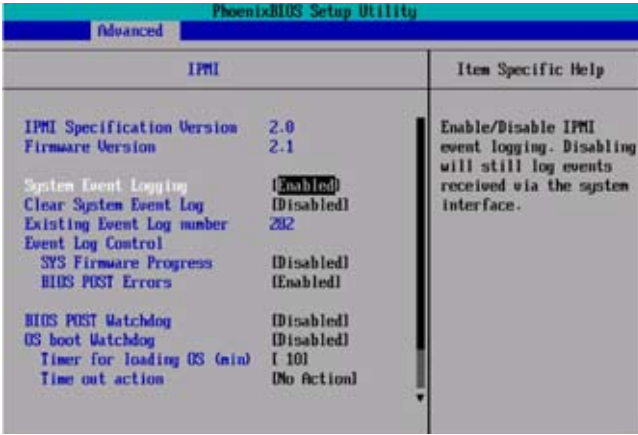

Firmware Version: This item displays the current Firmware Version.

System Event Logging

Select Enabled to enable IPMI Event Logging. When this function is set to Disabled, the system will continue to log events received via system interface. The options are **Enabled** and Disabled.

Clear System Event Logging

Enabling this function to force the BIOS to clear the system event logs during the next cold boot. The options are Enabled and **Disabled**.

Existing Event Log Number

This item displays the number of the existing event log.

Event Log Control

System Firmware Progress

Enabling this function to log POST progress. The options are Enabled and **Disabled**.

BIOS POST Errors

Enabling this function to log POST errors. The options are **Enabled** and Disabled.

Timer for Loading OS (Minutes)

This feature allows the user to set the time value (in minutes) for the previous item: OS Boot Watch Dog by keying-in a desired number in the blank. The default

setting is **10** (minutes.) (Please ignore this option when OS Boot Watch Dog is set to "Disabled".)

Time Out Option

This feature allows the user to determine what action to take in an event of a system boot failure. The options are **No Action**, Reset, Power Off and Power Cycles.

► System Event Log/System Event Log (List Mode)

These options display the System Event (SEL) Log and System Event (SEL) Log in List Mode. Items include: SEL (System Event Log) Entry Number, SEL Record ID, SEL Record Type, Time Stamp, Generator ID, SEL Message Revision, Sensor Type, Sensor Number, SEL Event Type, Event Description, and SEL Event Data.

```

System Event Log

SEL Entry Number = 1
SEL Record ID = 0001
SEL Record Type = 02 - System Event Record
Timestamp = 02.10.2006 17:11:23
Generator Id = 20 00
SEL Message Rev = 04
Sensor Type = 02 - Voltage
Sensor Number = 00 - -12V
SEL Event Type = 01 - Threshold
Event Description = Lower Non-critical Going Low. Assertion
SEL Event Data = 50 06 0E

F1 Help F11 Select Item +/- Change Values F9 Setup Defaults
Esc Exit * Select Menu Enter Select > Sub-Menu F10 Save and Exit
  
```

► IPMI LAN Configuration

VLAN Tagging

Select Enabled to enable Virtual LAN(s) for IPMI connections and allow the user to configure VLAN settings. The options are Enabled and **Disabled**.

VLAN ID

This item allows the user to change the VLAN ID. The default setting is **1h**.

IP Address Source

This item allows the user to select the IP address source for the connection. The options are **DHCP** and Static.

Update LAN Settings

Select Yes to allow BIOS update LAN setting. The options are Yes and **No**.

► Realtime Sensor Data

This feature display information from motherboard sensors, such as temperatures, fan speeds and voltages of various components.

Realtime Sensor Data					
Sensor Type	Sensor Name	Sensor Data	Sensor Units	Lower Limit	Upper Limit
Temp	CPU1 Core#	48.00	degrees C	0.00	75.00
	CPU1 Core#	54.00	degrees C	0.00	75.00
	CPU2 Core#	47.00	degrees C	0.00	75.00
	CPU2 Core#	46.00	degrees C	0.00	75.00
	System	44.00	degrees C	0.00	75.00
Voltage	CPU1 Core	1.13	Volts	0.97	1.47
	CPU2 Core	1.16	Volts	0.97	1.47
	3.3V	3.30	Volts	2.95	3.62

F1	Help	T1	Select Item	~/*	Change Values	F9	Setup Defaults
Esc	Exit	+	Select Menu	Enter	Select > Sub-Menu	F10	Save and Exit

4-5 Security Settings

Choose Security from the Phoenix BIOS Setup Utility main menu with the arrow keys. You should see the following display. Security setting options are displayed by highlighting the setting using the arrow keys and pressing <Enter>. All Security BIOS settings are described in this section.

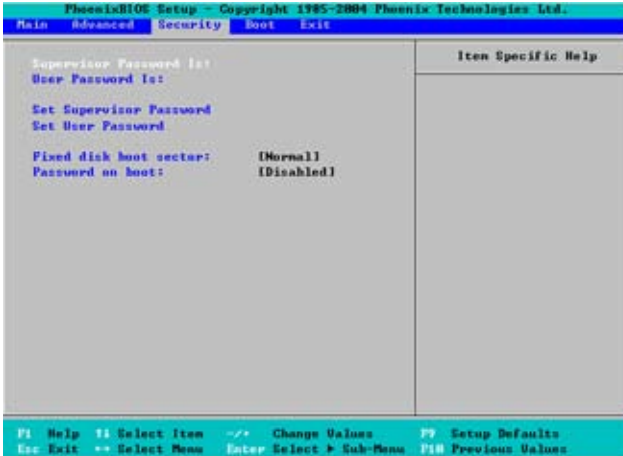

Supervisor Password Is:

This item indicates if a supervisor password has been entered for the system. Clear means such a password has not been used and Set means a supervisor password has been entered for the system.

User Password Is:

This item indicates if a user password has been entered for the system. Clear means such a password has not been used and Set means a user password has been entered for the system.

Set Supervisor Password

When the item "Set Supervisor Password" is highlighted, hit the <Enter> key. When prompted, type the Supervisor's password in the dialogue box to set or to change supervisor's password, which allows access to the BIOS.

Set User Password

When the item "Set User Password" is highlighted, hit the <Enter> key. When prompted, type the user's password in the dialogue box to set or to change the user's password, which allows access to the system at boot-up.

Fixed Disk Boot Sector

Select Write-Protect to protect the boot sector on the hard drives from virus intrusion. The options are **Normal** and Write Protect.

Password on Boot

When set to Enabled, a user will need to key-in a password to enter the system at system boot. The options are Enabled (password required) and **Disabled** (password not required).

4-6 Boot Settings

Choose Boot from the Phoenix BIOS Setup Utility main menu with the arrow keys. You should see the following display. See details on how to change the order and specs of boot devices in the Item Specific Help window. All Boot BIOS settings are described in this section.

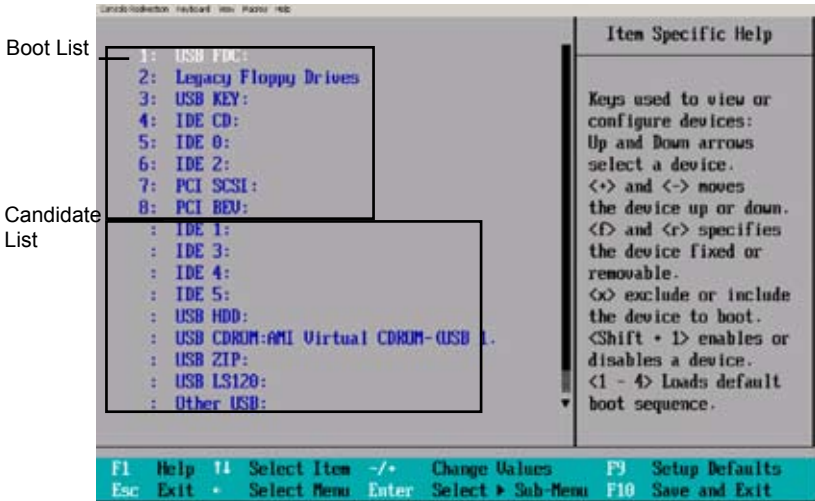

Boot Priority Order/Excluded from Boot Orders

The devices included in the boot list section (above) are bootable devices listed in the sequence of boot order as specified. The boot functions for the devices included in the candidate list (above) are currently disabled. Use a <+> key or a <-> key to move the device up or down. Use the <f> key or the <r> key to specify the type of an USB device, either fixed or removable. You can select one item from the boot list and hit the <x> key to remove it from the list of bootable devices (to make its resource available for other bootable devices). Subsequently, you can select an item from the candidate list and hit the <x> key to remove it from the candidate list and put it in the boot list. This item will then become a bootable device. See details on how to change the priority of boot order of devices in the "Item Specific Help" window.

4-7 Exit

Choose Exit from the Phoenix BIOS Setup Utility main menu with the arrow keys. You should see the following display. All Exit BIOS settings are described in this section.

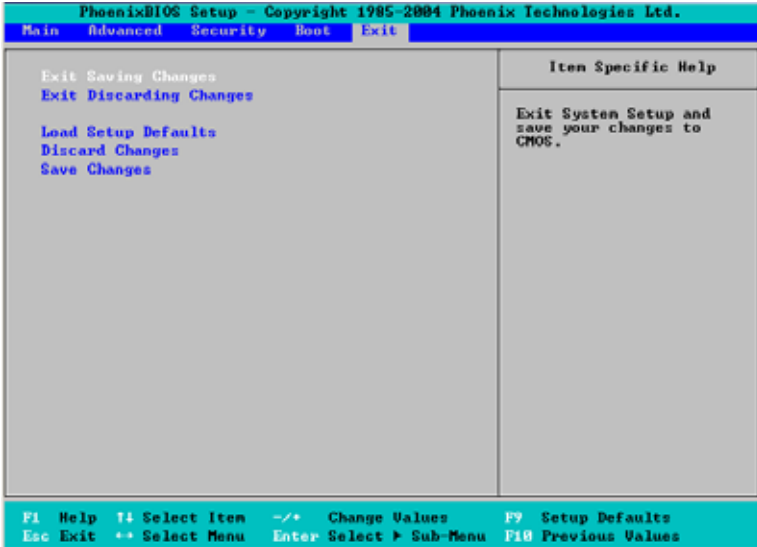

Exit Saving Changes

Highlight this item and hit <Enter> to save any changes you made and to exit the BIOS Setup utility.

Exit Discarding Changes

Highlight this item and hit <Enter> to exit the BIOS Setup utility without saving any changes you may have made.

Load Setup Defaults

Highlight this item and hit <Enter> to load the default settings for all items in the BIOS Setup. These are the safest settings to use.

Discard Changes

Highlight this item and hit <Enter> to discard (cancel) any changes you made. You will remain in the Setup utility.

Save Changes

Highlight this item and hit <Enter> to save any changes you made. You will remain in the Setup utility.

Appendix A

POST Error Beep Codes

This section lists POST (Power On Self Test) error beep codes for the Phoenix BIOS. POST error beep codes are divided into two categories: recoverable and terminal. This section lists Beep Codes for recoverable POST errors.

Recoverable POST Error Beep Codes

When a recoverable type of error occurs during POST, BIOS will display a POST code that describes the problem. BIOS may also issue one of the following beep codes:

- 1 long and two short beeps - video configuration error
- 1 repetitive long beep - no memory detected
- 1 continuous beep with the front panel Overheat LED on - system overheat

Notes

Appendix B

Installing the Windows OS

After all hardware components have been installed, you must first configure Intel South Bridge RAID Settings before you install the Windows OS and other software drivers. To configure RAID settings, please refer to RAID Configuration User Guides posted on our website at www.supermicro.com/support/manuals.

B-1 Installing the Windows XP/2003 OS for Systems with RAID Functions

1. Insert Microsoft's Windows XP/2003 Setup CD in the CD Drive, and the system will start booting up from CD.
2. Press the <F6> key when the message-" Press F6 if you need to install a third party SCSI or RAID driver" displays.
3. When the Windows XP/2003 Setup screen appears, press "S" to specify additional device(s).
4. Insert the driver diskette-"Intel AA RAID XP/2003 Driver for ICH9R" into Drive A: and press the <Enter> key.
5. Choose the Intel(R) ICH9R *SATA RAID Controller* from the list indicated in the XP/2003 Setup Screen, and press the <Enter> key.
6. Press the <Enter> key to continue the installation process. (If you need to specify any additional devices to be installed, do it at this time.) Once all devices are specified, press the <Enter> key to continue with the installation.
7. From the Windows XP/2003 Setup screen, press the <Enter> key. The XP/2003 Setup will automatically load all device files and then, continue the Windows XP/2003 installation.
8. After the Windows XP/2003 OS Installation is completed, the system will automatically reboot.

B-2 Installing the Windows XP/2000/2003 OS for Systems without RAID Functions

1. Insert Microsoft's Windows XP/2000/2003 Setup CD in the CD Drive, and the system will start booting up from CD.
2. Continue with the OS installation. The Windows OS Setup screen will display.
3. From the Windows XP/2000/2003 Setup screen, press the <Enter> key. The XP/2000/2003 Setup will automatically load all device files and then continue with the Windows XP/2000/2003 installation.
4. After the Windows XP/2000/2003 OS Installation is completed, the system will automatically reboot.
5. Insert the Supermicro Setup CD that came with your motherboard into the CD Drive during system boot, and the main screen as shown on Page C-1 will display. Follow the instructions given in Appendix C to complete other software/driver installation.

Appendix C

Installing Other Software Programs and Drivers

C-1 Installing Drivers other than the Serial ATA RAID Controller Driver

After you've installed the Windows Operating System, a screen as shown below will appear. You are ready to install software programs and drivers that have not yet been installed. To install these software programs and drivers, click the icons to the right of these items.

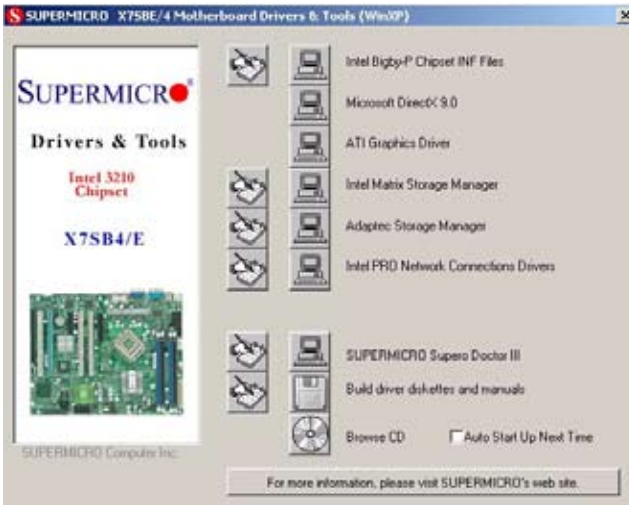

Driver/Tool Installation Display Screen



Note: Click the icons showing a hand writing on the paper to view the readme files for each item. Click a computer icon to the right of an item (from top to the bottom) one at a time. **After installing each item, you must re-boot the system before proceeding with the next item on the list.** The bottom icon with a CD on it allows you to view the entire contents of the CD.

C-2 Configuring Supero Doctor III

The Supero Doctor III program is a Web-base management tool that supports remote management capability. It includes Remote and Local Management tools. The local management is called the SD III Client. The Supero Doctor III program included on the CDROM that came with your motherboard allows you to monitor the environment and operations of your system. Supero Doctor III displays crucial system information such as CPU temperature, system voltages and fan status. See the Figure below for a display of the Supero Doctor III interface.

Note 1: The default user name and password are ADMIN.

Note 2: In the Windows OS environment, the Supero Doctor III settings take precedence over the BIOS settings. When first installed, Supero Doctor III adopts the temperature threshold settings previously set in the BIOS. Any subsequent changes to these thresholds must be made within Supero Doctor, since the SD III settings override the BIOS settings. For the Windows OS to adopt the BIOS temperature threshold settings, please change the SDIII settings to be the same as those set in the BIOS.

Supero Doctor III Interface Display Screen-I (Health Information)



Supero Doctor III Interface Display Screen-II (Remote Control)



Note: SD III Software Revision 1.0 can be downloaded from our Web site at: ftp://ftp.supermicro.com/utility/Supero_Doctor_III/. You can also download SDIII User's Guide at: <http://www.supermicro.com/PRODUCT/Manuals/SDIII/User-Guide.pdf>. For Linux, we will still recommend that you use Supero Doctor II.

Notes

(Disclaimer continued)

The products sold by Supermicro are not intended for and will not be used in life support systems, medical equipment, nuclear facilities or systems, aircraft, aircraft devices, aircraft/emergency communication devices or other critical systems whose failure to perform be reasonably expected to result in significant injury or loss of life or catastrophic property damage. Accordingly, Supermicro disclaims any and all liability, and should buyer use or sell such products for use in such ultra-hazardous applications, it does so entirely at its own risk. Furthermore, buyer agrees to fully indemnify, defend and hold Supermicro harmless for and against any and all claims, demands, actions, litigation, and proceedings of any kind arising out of or related to such ultra-hazardous use or sale.