

# SUPER<sup>®</sup>●

SUPER<sup>®</sup>● X7DCL-3  
SUPER<sup>®</sup>● X7DCL-i

## USER'S MANUAL

Revision 1.0c

---

The information in this User's Manual has been carefully reviewed and is believed to be accurate. The vendor assumes no responsibility for any inaccuracies that may be contained in this document, makes no commitment to update or to keep current the information in this manual, or to notify any person or organization of the updates. **Please Note: For the most up-to-date version of this manual, please see our web site at [www.supermicro.com](http://www.supermicro.com).**

Super Micro Computer Inc. ("Supermicro") reserves the right to make changes to the product described in this manual at any time and without notice. This product, including software, if any, and documentation may not, in whole or in part, be copied, photocopied, reproduced, translated or reduced to any medium or machine without prior written consent.

IN NO EVENT WILL SUPER MICRO COMPUTER BE LIABLE FOR DIRECT, INDIRECT, SPECIAL, INCIDENTAL, SPECULATIVE OR CONSEQUENTIAL DAMAGES ARISING FROM THE USE OR INABILITY TO USE THIS PRODUCT OR DOCUMENTATION, EVEN IF ADVISED OF THE POSSIBILITY OF SUCH DAMAGES. IN PARTICULAR, SUPER MICRO COMPUTER SHALL NOT HAVE LIABILITY FOR ANY HARDWARE, SOFTWARE, OR DATA STORED OR USED WITH THE PRODUCT, INCLUDING THE COSTS OF REPAIRING, REPLACING, INTEGRATING, INSTALLING OR RECOVERING SUCH HARDWARE, SOFTWARE, OR DATA.

---

Any disputes arising between manufacturer and customer shall be governed by the laws of Santa Clara County in the State of California, USA. The State of California, County of Santa Clara shall be the exclusive venue for the resolution of any such disputes. Supermicro's total liability for all claims will not exceed the price paid for the hardware product.

FCC Statement: This equipment has been tested and found to comply with the limits for a Class A digital device pursuant to Part 15 of the FCC Rules. These limits are designed to provide reasonable protection against harmful interference when the equipment is operated in a commercial environment. This equipment generates, uses, and can radiate radio frequency energy and, if not installed and used in accordance with the manufacturer's instruction manual, may cause harmful interference with radio communications. Operation of this equipment in a residential area is likely to cause harmful interference, in which case you will be required to correct the interference at your own expense.

California Best Management Practices Regulations for Perchlorate Materials: This Perchlorate warning applies only to products containing CR (Manganese Dioxide) Lithium coin cells. "Perchlorate Material-special handling may apply. See [www.dtsc.ca.gov/hazardouswaste/perchlorate](http://www.dtsc.ca.gov/hazardouswaste/perchlorate)"

---

**WARNING:** Handling of lead solder materials used in this product may expose you to lead, a chemical known to the State of California to cause birth defects and other reproductive harm.

---

Manual Revision 1.0c

Release Date: March 11, 2009

Unless you request and receive written permission from Super Micro Computer, Inc., you may not copy any part of this document.

Information in this document is subject to change without notice. Other products and companies referred to herein are trademarks or registered trademarks of their respective companies or mark holders.

Copyright © 2009 by Super Micro Computer, Inc.  
All rights reserved.

**Printed in the United States of America**

---

---

## Preface

### About This Manual

This manual is written for system integrators, PC technicians and knowledgeable PC users. It provides information for the installation and use of the **SUPER**® X7DCL-3/X7DCL-i motherboard. The **SUPER**® X7DCL-3/X7DCL-i supports dual Intel Xeon Quad Core/Dual Core 5400/5300/5200/5100 Series processors (w/771 LGA) with a front side bus speed of up to 1.333 GHz. With dual 64-bit Xeon Quad Core/Dual Core 5400/5300/5200/5100 Series processors built-in, the X7DCL-3/X7DCL-i offers substantial functionality enhancements to the motherboards based on the Intel Core microarchitecture while remaining compatible with the IA-32 software. The features supported by this motherboard include Intel Virtualization Technology, Enhanced Intel SpeedStep technology, Extended Memory 64 Technology (EM64T) and Native DDR 2 DIMM modules. These features allow the motherboard to operate at much higher speeds with lower power consumption in much safer thermal environments than the traditional motherboards. The X7DCL-3/X7DCL-i is ideal for complex business applications and servers. Please refer to the motherboard specifications pages on our web site (<http://www.supermicro.com/products/motherboard/>) for updates. This product is intended to be installed and serviced by professional technicians.

### Manual Organization

**Chapter 1** describes the features, specifications and performance of the mainboard and provides detailed information about the chipset.

**Chapter 2** provides hardware installation instructions. Read this chapter when installing the processor, memory modules and other hardware components into the system. If you encounter any problems, see **Chapter 3**, which describes troubleshooting procedures for video, memory and system setup stored in the CMOS.

**Chapter 4** includes an introduction to the BIOS, and provides detailed information on running the CMOS Setup utility.

**Appendix A** lists BIOS POST Error Codes. **Appendix B** and **Appendix C** provide the Windows OS and other Software Installation Instructions.

### Conventions Used in the Manual:

Special attention should be given to the following symbols for proper installation and to prevent damage done to the components or injury to yourself.



**Danger/ Caution:** Instructions to be strictly followed to prevent catastrophic system failure or to avoid bodily injury.



**Warning:** Important information given to ensure proper system installation or to prevent damage to the components.

**Note:** Additional Information given to ensure correct system setup.

# Table of Contents

## Preface

About This Manual .....	iii
Manual Organization .....	iii
Conventions Used in the Manual.....	iii

## Chapter 1: Introduction

1-1 Overview .....	1-1
Checklist .....	1-1
Contacting Supermicro .....	1-2
SUPER <sup>®</sup> X7DCL-3/i Image .....	1-3
SUPER <sup>®</sup> X7DCL-3/i Layout .....	1-4
Quick Reference .....	1-5
Motherboard Features.....	1-6
Intel 5100 Chipset: System Block Diagram .....	1-8
1-2 Chipset Overview .....	1-9
1-3 Special Features .....	1-10
1-4 PC Health Monitoring .....	1-10
1-5 ACPI Features .....	1-11
1-6 Power Supply .....	1-12
1-7 Super I/O .....	1-12

## Chapter 2: Installation

2-1 Static-Sensitive Devices .....	2-1
Precautions.....	2-1
Unpacking .....	2-1
2-2 Processor and Heatsink Installation .....	2-2
2-3 Installing DIMMs .....	2-6
2-4 Control Panel Connectors and IO Ports .....	2-8
Back Panel Connectors/IO Ports.....	2-8
Front Control Panel .....	2-9
Front Control Panel Pin Definitions.....	2-10
NMI Button .....	2-10
Power LED .....	2-10
HDD LED .....	2-11
NIC1/NIC2 LED Indicators .....	2-11
Overheat/Fan Fail LED .....	2-12
Power Fail LED .....	2-12
Reset Button .....	2-13

	Power Button .....	2-13
2-5	Connecting Cables .....	2-14
	ATX Power Connector .....	2-14
	Processor Power Connector .....	2-14
	Universal Serial Bus (USB).....	2-15
	Fan Headers .....	2-16
	Chassis Intrusion .....	2-16
	ATX PS/2 Keyboard and Mouse Ports.....	2-17
	Serial Ports.....	2-17
	Wake-On-Ring.....	2-18
	Wake-On-LAN .....	2-18
	GLAN 1/2 (Ethernet) Ports.....	2-19
	Speaker/Power LED Header .....	2-19
	Alarm Reset.....	2-20
	Power Supply Failure/Power Fault.....	2-20
	VGA Connector .....	2-21
	SGPIO Headers .....	2-21
	Power SMB (I <sup>2</sup> C).....	2-22
	BP Power SMB (I <sup>2</sup> C).....	2-22
	Keylock.....	2-23
2-6	Jumper Settings.....	2-24
	Explanation of Jumpers .....	2-24
	GLAN Enable/Disable .....	2-24
	CMOS Clear .....	2-25
	Watch Dog.....	2-25
	VGA Enable/Disable.....	2-26
	I <sup>2</sup> C Bus to PCI Slots.....	2-26
	SAS Enable .....	2-27
	Software RAID Enable .....	2-27
2-7	Onboard LED Indicators.....	2-28
	GLAN LEDs.....	2-28
	Onboard Power LED .....	2-28
	System Status LED.....	2-29
	CPU_VRM Overheat LEDs .....	2-29
	System Status LED .....	2-30
2-8	Floppy, SIMLC, IPMI and Hard Disk	
	Floppy Connector.....	2-31
	IDE Connector.....	2-32
	SIMLC IPMI Slot.....	2-32

### Chapter 3: Troubleshooting

3-1	Troubleshooting Procedures .....	3-1
	Before Power On.....	3-1
	No Power.....	3-1
	No Video .....	3-1
	Losing the System's Setup Configuration .....	3-1
	Memory Errors.....	3-2
3-2	Technical Support Procedures .....	3-2
3-3	Frequently Asked Questions .....	3-3
3-4	Returning Merchandise for Service .....	3-3

### Chapter 4: BIOS

4-1	Introduction .....	4-1
4-2	Running Setup .....	4-2
4-3	Main BIOS Setup .....	4-2
4-4	Advanced Setup .....	4-7
4-5	Security Setup .....	4-20
4-6	Boot Setup .....	4-21
4-7	Exit.....	4-22

### Appendices:

Appendix A:	BIOS POST Error Beep Codes .....	A-1
Appendix B:	Installing the Windows OS .....	B-1
Appendix C:	Installing Other Software Programs and Drivers.....	C-1

# Chapter 1

## Introduction

### 1-1 Overview

#### Checklist

Congratulations on purchasing your computer motherboard from an acknowledged leader in the industry. Supermicro boards are designed with the utmost attention to detail to provide you with the highest standards in quality and performance. Check that the following items have all been included with your motherboard. If anything listed here is damaged or missing, contact your retailer.

All the following items are included in the Retail Box only.

One (1) Super Micro Mainboard

One (1) ribbon cable for IDE devices (CBL-0036L-2)

One (1) floppy ribbon cable (CBL-0022L)

Eight (8) SATA cables (CBL-0044L) (X7DCL-3)

Six (6) SATA cables (CBL-0044L) (X7DCL-i)

One (1) I/O backpanel shield (CSE-PT07L)

One (1) CPU Retention Module (SKT-0159)

One (1) Supermicro CD containing drivers, software and utilities (CDR-X7)

One (1) User's/BIOS Manual (MNL-0957)

#### Optional

(For SAS HostRAID 5)

One (1) I-Button (AOC-iBUTTON 68) (X7DCL-3)

## Contacting Supermicro

### Headquarters

Address: Super Micro Computer, Inc.  
980 Rock Ave.  
San Jose, CA 95131 U.S.A.

Tel: +1 (408) 503-8000

Fax: +1 (408) 503-8008

Email: [marketing@supermicro.com](mailto:marketing@supermicro.com) (General Information)  
[support@supermicro.com](mailto:support@supermicro.com) (Technical Support)

Web Site: [www.supermicro.com](http://www.supermicro.com)

### Europe

Address: Super Micro Computer B.V.  
Het Sterrenbeeld 28, 5215 ML  
's-Hertogenbosch, The Netherlands

Tel: +31 (0) 73-6400390

Fax: +31 (0) 73-6416525

Email: [sales@supermicro.nl](mailto:sales@supermicro.nl) (General Information)  
[support@supermicro.nl](mailto:support@supermicro.nl) (Technical Support)  
[rma@supermicro.nl](mailto:rma@supermicro.nl) (Customer Support)

### Asia-Pacific

Address: Super Micro, Taiwan  
4F, No. 232-1, Liancheng Rd.  
Chung-Ho 235, Taipei County  
Taiwan, R.O.C.

Tel: +886-(2) 8226-3990

Fax: +886-(2) 8226-3991

Web Site: [www.supermicro.com.tw](http://www.supermicro.com.tw)

Technical Support:

Email: [support@supermicro.com.tw](mailto:support@supermicro.com.tw)

Tel: 886-2-8228-1366, ext.132 or 139



## SUPER® X7DCL-3/X7DCL-i Image

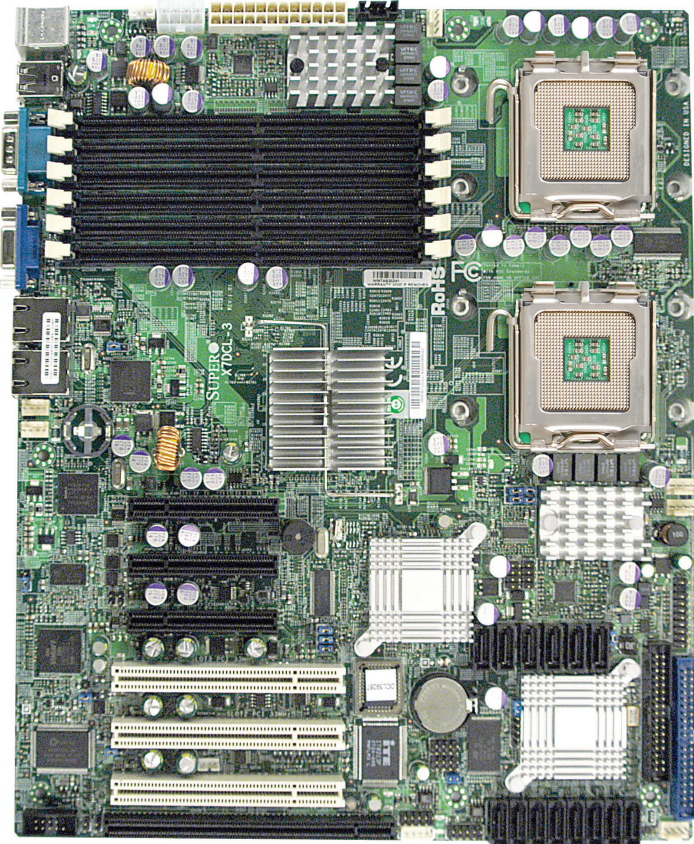

**Note:** The drawings and pictures shown in this manual were based on the latest PCB Revision available at the time of publishing of the manual. The motherboard you've received may or may not look exactly the same as the graphics shown in the manual.

SUPER X7DCL-3/X7DCL-i Motherboard Layout

(not drawn to scale)

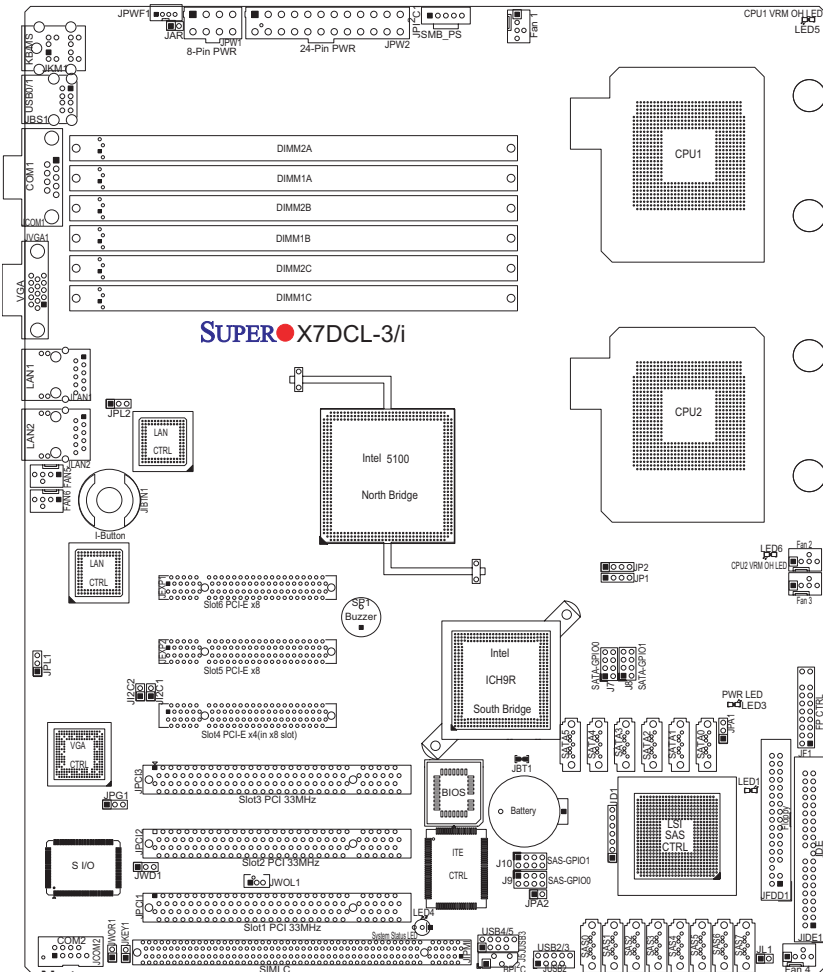

**Notes:**

1. Jumpers not indicated are for test purposes only.
2. See Chapter 2 for detailed information on jumpers, I/O ports and JF1 front panel connections.
3. "■" indicates the location of Pin 1.
4. When LED3 is on, make sure to unplug the power cable before removing or installing components.
5. All features and components related to SAS are available on the X7DCL-3 only, including SAS Connectors, the LSI SAS HostRAID Controller, and the I-Button socket. I-Button is used to support RAID 5 (optional.)

## Quick Reference (X7DCL-3/X7DCL-i)

<b>Jumper</b>	<b>Description</b>	<b>Default Setting</b>
JBT1	CMOS Clear	See Chapter 2
J1 <sup>2</sup> C1/J1 <sup>2</sup> C2	SMB to PCI/PCI-Exp Slots	Open (Disabled)
JPG1	VGA Enable	Pins 1-2 (Enabled)
JPA1 ( <b>Note</b> )	SAS Enable	Pins 1-2 (Enabled)
JPA2 ( <b>Note</b> )	Software RAID/IT RAID Mode	Closed (Software RAID)
JPL1/JPL2	GLAN1/GLAN2 Enable	Pins 1-2 (Enabled)
JWD	Watch Dog	Pins 1-2 (Reset)
<b>Connector</b>	<b>Description</b>	
BP1 <sup>2</sup> C	Back Panel Power System Management (I <sup>2</sup> C) Header	
COM1/COM2	COM1/COM2 Serial Port and Header	
FAN 1-6	Fans 1-2: CPU Fans, Fans 3-6: System cooling fans	
Floppy	Floppy Disk Drive Connector (JFDD1)	
FP Control	Front Control Panel Connector (JF1)	
IDE	IDE Hard Drive	
J7/J8/9/10	Serial-Links General Purpose Input/Output Headers (J7/J8: SATA T-SGPIO 0/1, J9/J10: SAS T-SGPIO 0/1)	
JAR1	Alarm Reset Header	
JD1	Power LED(pins1-3)/SpeakerHeader (pins 4-7)	
JIBTN1	I-Button Socket	
JL1	Chassis Intrusion Header	
JPW1	+12V 8-pin PWR	
JPW2	Primary 24-Pin ATX PWR Connector	
JPWF1	Power Supply Failure (See Chapter 2)	
JUSB1/JUSB2/3	BP USB0/1 (JUSB1), FP USB2/3/4/5 (JUSB2/3)	
JWOL	Wake-on-LAN Header	
JWOR	Wake-on-Ring Header	
Keylock	Keylock Header (JKEY1)	
LAN1/2	G-bit Ethernet Ports 1/2	
PWR I <sup>2</sup> C	Power System Management (I <sup>2</sup> C) Header (JPI <sup>2</sup> C1)	
SAS0-SAS7 ( <b>Note</b> )	Serial Attached SCSI Connectors (#0-#7) (X7DCL-3)	
SATA0-SATA5	SATA 0-5 Connectors	
SIMLC	IPMI SIMLC Slot (JIPMI)	
VGA	VGA Port	
<b>LED Indicator</b>	<b>Description</b>	
LED1	SAS LED	
LED3/LED4	Power LED (LED3)/System Status LED (LED4)	
LED5/LED6	CPU1/CPU2 VRM Overheat (respectively)	

**Note:** SAS is available on the X7DCL-3 only.

## **Motherboard Features**

### **CPU**

- Dual Intel® 64-bit Xeon LGA 771 Quad Core/Dual Core 5400/5300/5200/5100 Series processors at a front side bus speed of 1333 MHz/1066 MHz

### **Memory**

- Six 240-pin DIMM sockets with support up to 32 GB Single-Rank, Registered/ECC DDR2 667/533 Memory.

**Note:** PCB revision 1.1a and later will now support up to 48 GBs of Single-Rank, Registered/ECC DDR2 667/533 Memory (See Section 2-3 in Chapter 2 for DIMM Slot Population.)

### **Chipset**

- Intel 5100 chipset, including: the 5100 Memory Control Hub (MCH) and the ICH9R South Bridge

### **Expansion Slots**

- Two PCI-E x8 slot (Slot 5/Slot 6), and one in PCI-E x4 (in x8) slot (Slot 4)
- Three 32-bit PCI 33 MHz slot (Slot 1/Slot 2/Slot 3)
- One SIMLC IPMI Slot (Slot 0)

### **BIOS**

- 8 Mb Phoenix® Flash ROM
- DMI 2.3, PCI 2.2, ACPI 1.0, Plug and Play (PnP), USB Keyboard support, Hardware BIOS Virus Protection and SMBIOS 2.3

### **PC Health Monitoring**

- Onboard voltage monitors for CPU core voltage, Memory voltage, +1.8V, +3.3V, +5V, +12V, -12V, +3.3V standby, +5V standby and VBAT)
- Fan status monitor with firmware control
- CPU/chassis temperature monitors
- Low noise fan speed control
- Platform Environment Control Interface (PECI) ready
- CPU fan auto-off in sleep mode
- Pulse Width Modulation (PWM) fan control
- I<sup>2</sup>C temperature sensing logic
- Thermal Monitor 2 (TM2) support
- CPU slow-down on temperature overheat
- CPU thermal trip support for processor protection
- Power-up mode control for recovery from AC power loss

- Chassis intrusion detection
- System resource alert via Supero Doctor III

### **ACPI Features**

- Slow blinking LED for suspend state indicator
- Main switch override mechanism
- ACPI Power Management
- Power-on mode for power recovery

### **Onboard I/O**

- Six SATA ports support RAID 0, 1, 10 and 5 (in the Windows OS environment)
- Eight SAS ports supports RAID 0, 1, 10 and 5. (For X7DCL-3 only)
- One SIMLC IPMI 2.0 socket
- Intel 82573V and 82573L LAN chips support two Giga-bit LAN ports
- One EIDE Ultra DMA/100 bus master interface
- One floppy port interface
- Two COM ports(1 header, 1 port)
- Up to six USB 2.0 (Universal Serial Bus) (2 ports, 4 Headers)
- XGI Volari Z9s 32 MB Graphic Controller
- Super I/O: Winbond W83627HG

### **Other**

- External modem ring-on
- Wake-on-LAN (WOL)
- Wake-on-Ring (WOR)
- Console redirection
- Onboard Fan Speed Control by Thermal Management via BIOS

### **CD/Diskette Utilities**

- Device drivers and Software

### **Dimensions**

- ATX 12.05" x 10" (306.1mm x 254 mm)

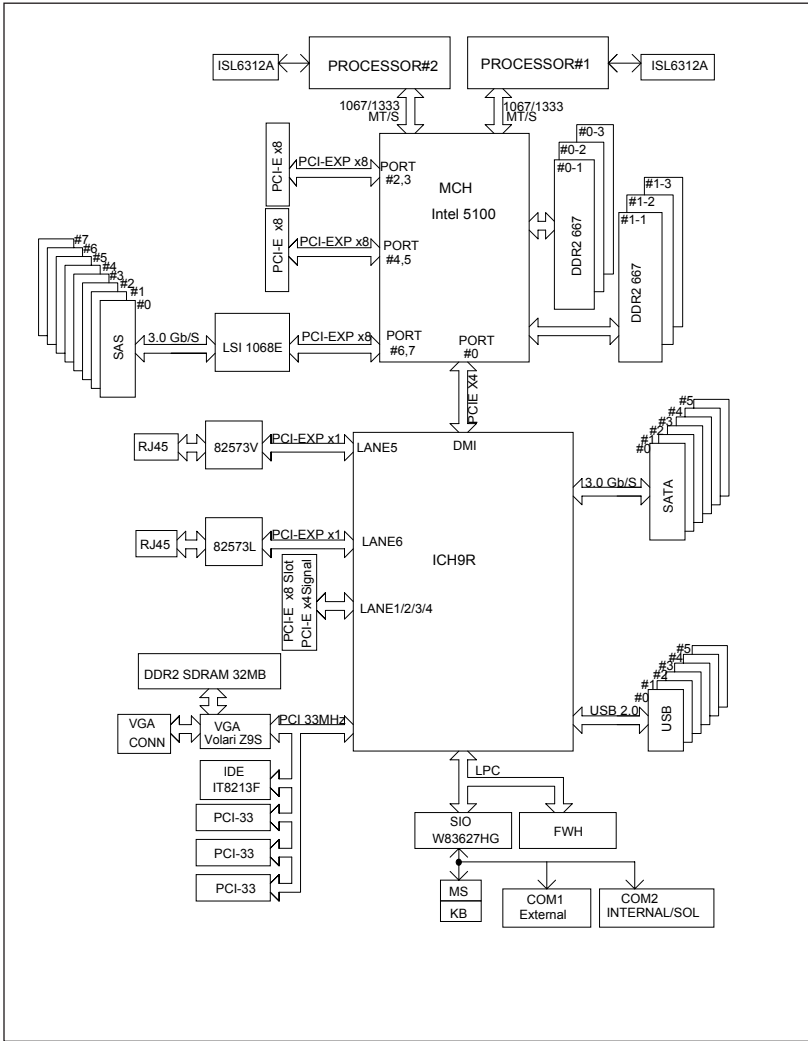

**Block Diagram of the Intel 5100 Chipset**

**Note:** This is a general block diagram. Please see the previous Motherboard Features pages for details on the features of each motherboard.

## 1-2 Chipset and Processor Features Overview

Built upon the functionality and the capability of the Intel 5100 chipset, the X7DCL-3/X7DCL-i motherboard provides the performance and feature set required for dual processor-based high-end servers with configuration options optimized for intensive computing, high energy-efficiency and complex business applications. The 5100 chipset supports single or dual Intel Xeon 64-bit Quad Core/Dual Core 5400/5300/5200/5100 Series processors with front side bus speeds of up to 1.333 GHz. The chipset consists of the 5100 Memory Controller Hub (MCH), Intel I/O Controller Hub (ICH9R) and the I/O subsystem.

### **The 5100 Memory Controller Hub (MCH)**

The Intel 5100 MCH chip is designed for symmetric multiprocessing across two independent front side bus interfaces. Each front side bus uses a 64-bit wide, 1066/1333 MTS data bus capable of transferring data at 8.5/10.6 GB/s for a total bandwidth of 17/21.3 GB/s. The MCH supports a 36-bit wide address bus and up to six DDR2 667 MHz/533 MHz DIMM modules, providing a total memory capacity of up to 32 GB.

The 5100 MCH also provides six x4 PCI-Express interfaces and one x4 DMI Interface to the ICH9R. Each PCI Express port on the MCH provides 4 GB/s bi-directional bandwidth if configured as a x8 port, or 2 GB/s bi-directional bandwidth if configured as a x4 port.

### **The Ninth Generation I/O Controller Hub (ICH9)**

The I/O Controller ICH9R provides the data buffering and interface arbitration required for the system to operate efficiently. It also provides the bandwidth needed for the system to maintain its peak performance. The Direct Media Interface (DMI) provides the connection between the MCH and the ICH9R. The ICH9R supports up to six PCI-Express x1 slots, six Serial ATA ports and twelve USB 2.0 ports. In addition, the ICH9R offers the Intel Matrix Storage Technology which provides various RAID options for data protection and rapid data access. It also supports the next generation of client management through the use of PROActive technology in conjunction with Intel's next generation Gigabit Ethernet controllers.

## 1-3 Special Features

### Recovery from AC Power Loss

BIOS provides a setting for you to determine how the system will respond when AC power is lost and then restored to the system. You can choose for the system to remain powered off (in which case you must hit the power switch to turn it back on) or for it to automatically return to a power-on state. See the Power Lost Control setting in the Advanced BIOS Setup section to change this setting. The default setting is **Last State**.

## 1-4 PC Health Monitoring

This section describes the PC health monitoring features of the X7DCL-3/X7DCL-i. All have an onboard System Hardware Monitor chip that supports PC health monitoring.

### Onboard Voltage Monitors

An onboard voltage monitor will scan for the CPU Cores, Chipset Voltage, +1.8V, +3.3V, +5V, +12V, -12V, +3.3V Standby, +5V Standby and VBAT continuously. Once a voltage becomes unstable, a warning is given or an error message is sent to the screen. Users can adjust the voltage thresholds to define the sensitivity of the voltage monitor.

### Fan Status Monitor with Firmware Control

The PC health monitor can check the RPM status of the cooling fans. The onboard CPU and chassis fans are controlled by Thermal Management via BIOS (under Hardware Monitoring in the Advanced Setting).

### Environmental Temperature Control

The thermal control sensor monitors the CPU temperature in real time and will turn on the thermal control fan whenever the CPU temperature exceeds a user-defined threshold. The overheat circuitry runs independently from the CPU. Once it detects that the CPU temperature is too high, it will automatically turn on the thermal fan control to prevent any overheat damage to the CPU. The onboard chassis thermal circuitry can monitor the overall system temperature and alert users when the chassis temperature is too high.

### System Resource Alert

This feature is available when used with Supero Doctor III in the Windows OS environment or used with Supero Doctor II in Linux. Supero Doctor is used to notify the user of certain system events. For example, if the system is running low on virtual memory and there is insufficient hard drive space for saving the data,



you can be alerted of the potential problem. You can also configure Supero Doctor to provide you with warnings when the system temperature goes beyond a pre-defined range.

## 1-5 ACPI Features

ACPI stands for Advanced Configuration and Power Interface. The ACPI specification defines a flexible and abstract hardware interface that provides a standard way to integrate power management features throughout a PC system, including its hardware, operating system and application software. This enables the system to automatically turn on and off peripherals such as CD-ROMs, network cards, hard disk drives and printers. This also includes consumer devices connected to the PC such as VCRs, TVs, telephones and stereos.

In addition to enabling operating system-directed power management, ACPI provides a generic system event mechanism for Plug and Play and an operating system-independent interface for configuration control. ACPI leverages the Plug and Play BIOS data structures while providing a processor architecture-independent implementation that is compatible with Windows 2000, Windows XP and Windows 2003 Servers.

### **Slow Blinking LED for Suspend-State Indicator**

When the CPU goes into a suspend state, the chassis power LED will start blinking to indicate that the CPU is in suspend mode. When the user presses any key, the CPU will wake-up and the LED will automatically stop blinking and remain on.

### **Main Switch Override Mechanism**

When an ATX power supply is used, the power button can function as a system suspend button to make the system enter a SoftOff state. The monitor will be suspended and the hard drive will spin down. Pressing the power button again will cause the whole system to wake-up. During the SoftOff state, the ATX power supply provides power to keep the required circuitry in the system "alive". In case the system malfunctions and you want to turn off the power, just press and hold the power button for 4 seconds. This option can be set in the Power section of the BIOS Setup routine.

### **External Modem Ring-On**

Wake-up events can be triggered by a device such as the external modem ringing when the system is in the Standby or Off state. Note that external modem ring-on can only be used with an ATX 2.01 (or above) compliant power supply.

Wake-On-LAN is defined as the ability of a management application to remotely power up a computer that is powered off. Remote PC setup, up-dates and asset tracking can occur after hours and on weekends so that daily LAN traffic is kept

to a minimum and users are not interrupted. The motherboard has a 3-pin header (WOL) to connect to the 3-pin header on a Network Interface Card (NIC) that has WOL capability. In addition, an onboard LAN controller can also support WOL without any connection to the WOL header. The 3-pin WOL header is to be used with a LAN add-on card only.

**Note:** Wake-On-LAN requires an ATX 2.01 (or above) compliant power supply.

## 1-6 Power Supply

As with all computer products, a stable power source is necessary for proper and reliable operation. It is even more important for processors that have high CPU clock rates.

The X7DCL-3/X7DCL-i can only accommodate 24-pin ATX power supply. Although most power supplies generally meet the specifications required by the motherboard, some are inadequate. You should use one that will supply at least 400W of power. In addition, the 12V 8-pin is also required for adequate power supply to the CPU. Also your power supply must supply 1.5A for the Ethernet ports.

It is strongly recommended that you use a high quality power supply that meets ATX power supply Specification 2.02 or above. It must also be SSI compliant (info at <http://www.ssiforum.org/>). Additionally, in areas where noisy power transmission is present, you may choose to install a line filter to shield the computer from noise. It is recommended that you also install a power surge protector to help avoid problems caused by power surges.

## 1-7 Super I/O

The disk drive adapter functions of the Super I/O chip include a floppy disk drive controller that is compatible with industry standard 82077/765, a data separator, write pre-compensation circuitry, decode logic, data rate selection, a clock generator, drive interface control logic and interrupt and DMA logic. The wide range of functions integrated onto the Super I/O greatly reduces the number of components required for interfacing with floppy disk drives. The Super I/O supports 360 K, 720 K, 1.2 M, 1.44 M or 2.88 M disk drives and data transfer rates of 250 Kb/s, 500 Kb/s or 1 Mb/s. It also provides two high-speed, 16550 compatible serial communication ports (UARTs). Both UARTs provide legacy speed with baud rate of up to 115.2 Kbps as well as an advanced speed with baud rates of 250 K, 500 K, or 1 Mb/s, which support higher speed modems.

The Super I/O supports one PC-compatible printer port (SPP), Bi-directional Printer Port (BPP), Enhanced Parallel Port (EPP) or Extended Capabilities Port (ECP).

The Super I/O provides functions that comply with ACPI (Advanced Configuration and Power Interface), which includes support of legacy and ACPI power management through an SMI or SCI function pin. It also features auto power management to reduce power consumption.

## Notes

## Chapter 2

# Installation

### 2-1 Static-Sensitive Devices

Electro-Static Discharge (ESD) can damage electronic components. To prevent damage to your system board, it is important to handle it very carefully. The following measures are generally sufficient to protect your equipment from ESD.

#### Precautions

- Use a grounded wrist strap designed to prevent static discharge.
- Touch a grounded metal object before removing the board from the antistatic bag.
- Handle the board by its edges only; do not touch its components, peripheral chips, memory modules or gold contacts.
- When handling chips or modules, avoid touching their pins.
- Put the motherboard and peripherals back into their antistatic bags when not in use.
- For grounding purposes, make sure your computer chassis provides excellent conductivity between the power supply, the case, the mounting fasteners and the motherboard.
- Use only the correct type of onboard CMOS battery as specified by the manufacturer. Do not install the onboard battery upside down to avoid possible explosion.

#### Unpacking

The motherboard is shipped in antistatic packaging to avoid static damage. When unpacking the board, make sure the person handling it is static protected.

## 2-2 Processor and Heatsink Fan Installation



*When handling the processor package, avoid placing direct pressure on the label area of the fan.*

### Notes:

- Always connect the power cord last and always remove it before adding, removing or changing any components. Make sure that you install the processor into the CPU socket before you install the CPU heatsink.
- Intel's boxed Xeon CPU package contains the CPU fan and heatsink assembly. If you buy a CPU separately, make sure that you use only Intel-certified multi-directional heatsink and fan.
- Make sure to install the motherboard into the chassis before you install the CPU heatsink and fan.
- When purchasing a motherboard with an LGA 771 CPU Socket, make sure that the CPU plastic cap is in place, and none of the CPU Socket pins are bent; otherwise, contact the retailer immediately.
- Refer to the Chipset/MB Features Section for more details on CPU support.

### Installing the LGA771 Processor

1. Press the load lever to release the load plate, which covers the CPU socket, from its locking position.
2. Gently lift the load lever to open the load plate.

Load Lever  
PnP Cap on  
top of the  
Load Plate

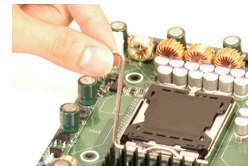
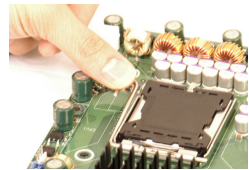
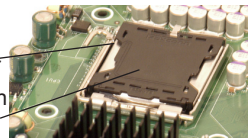

Load Plate  
(with PnP Cap  
attached)

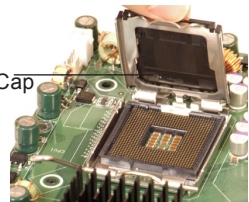

## **Loading the Processor into the Socket**

1. Use your thumb and your index finger to hold the CPU at the North Center Edge and the South Center Edge of the CPU.
2. Align CPU Pin1 (the CPU corner marked with a triangle) against the socket corner that is marked with a triangle cutout.
3. Align the CPU key that is the semi-circle cutout below a gold dot against the socket key, the notch on the same side of the triangle cutout on the socket.
4. Once aligned, carefully lower the CPU straight down to the socket. (Do not drop the CPU on the socket. Do not move the CPU horizontally or vertically. Do not rub the CPU against the surface or against any pins of the socket to avoid damage to the CPU or the socket.)
5. With the CPU installed in the socket, inspect the four corners of the CPU to make sure that the CPU is properly installed. Then, close the load plate.
6. Use your thumb to gently push the load lever down to lock it.
7. If the CPU is properly installed into the socket, the plastic cap will be automatically released from the load plate when the clip is pushed in the clip lock. Remove the plastic cap from the motherboard.

 **Warning:** Please save the plastic PnP cap. The motherboard must be shipped with the PnP cap properly installed to protect socket pins. Shipment without the PnP cap properly installed will cause damage to the socket pins.

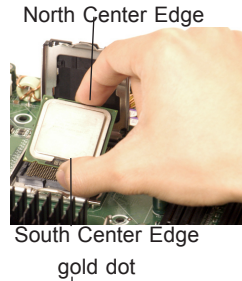

Socket Key  
(Socket Notch)

CPU Key (semi-circle cutout)  
below the circle

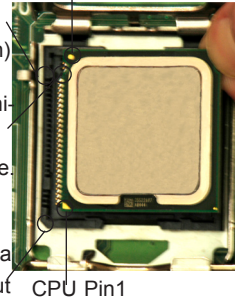

Load Lever

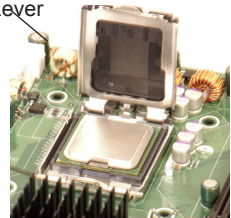

CPU in the CPU socket

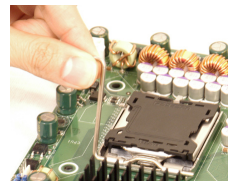

Plastic cap is released from the load plate if the CPU properly installed.

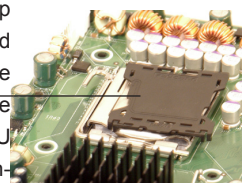

### Installing the Heatsink

1. Do not apply any thermal grease to the heatsink or the CPU die; the required amount has already been applied.
2. Place the heatsink on top of the CPU so that the four mounting holes are aligned with those on the retention mechanism.
3. Screw in two diagonal screws (ie the #1 and the #2 screws) until just snug (- do not fully tighten the screws to avoid possible damage to the CPU.)
4. Finish the installation by fully tightening all four screws.

CEK Passive Heatsink

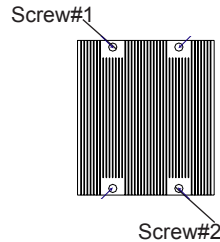
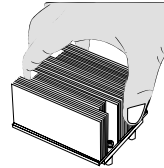
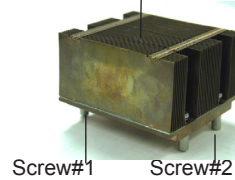

### To Remove the Heatsink



**Warning:** We do not recommend that the CPU or the heatsink be removed. However, if you do need to uninstall the heatsink, please follow the instructions on the next page to uninstall the heatsink to prevent damage done to the CPU or the CPU socket.

1. Unscrew and remove the heatsink screws from the motherboard in the sequence as shown in the picture on the right.
2. Hold the heatsink as shown in the picture on the right and gently wriggle the heatsink to loosen it from the CPU. (Do not use excessive force when wriggling the heatsink!!)
3. Once the heatsink is loosened, remove the it from the CPU socket.

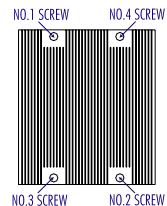



- Clean the surface of the CPU and the heatsink to get rid of the old thermal grease. Reapply the proper amount of thermal grease on the surface before you re-install the CPU and the heatsink.

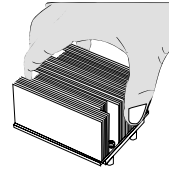

### Mounting the Motherboard in the Chassis

All motherboards have standard mounting holes to fit different types of chassis. Make sure that the locations of all the mounting holes for both motherboard and chassis match. Make sure that the metal standoffs click in or are screwed in tightly. Then, use a screwdriver to secure the motherboard onto the motherboard tray. (**Note:** some components are very close to the mounting holes. Please take precautionary measures to prevent damage done to these components when you install the motherboard into the chassis.)



**Caution:** To avoid damaging the motherboard and its components, please do not use a force greater than 8 lb/inch on each mounting screw during motherboard installation.

## 2-3 Installing DIMMs

**Note:** Check the SuperMicro web site for recommended memory modules.

### CAUTION



Exercise extreme care when installing or removing DIMM modules to prevent any possible damage. Also note that the memory is interleaved to improve performance.

### DIMM Installation

- Insert the desired number of DIMMs into the memory slots, starting with DIMM #1A. The memory scheme is interleaved, so you must install two modules at a time, beginning with DIMM 1A, DIMM 2A, then DIMM 1B, DIMM 2B, and DIMM 1C, DIMM 2C. (See the Memory Installation Table Below.)
- Insert each DIMM module vertically into its slot. Pay attention to the notch along the bottom of the module to prevent inserting the DIMM module incorrectly.
- Gently press down on the DIMM module until it snaps into place in the slot. Repeat for all modules (See step 1 above.)

## Memory Support

The X7DCL-3/X7DCL-i supports up to 48 GB Single-Rank/Dual Rank, Registered ECC DDR2 667/533 in 6 DIMMs (The amount and type of memory supported is dependent on the PCB revision. See Note 1 Below). Populating DIMM slots with pairs of memory modules of the same size and same type **will result in Interleaved Memory** which will improve memory performance.

**Note 1:** For the PCB Rev. 1.1 motherboard, Slots 1A and 2A support Dual-Rank modules; however, Slots 1B, 2B, 1C and 2C support Single-Rank memory only (Maximum of 32 GB). The PCB Rev. 1.1a board supports 6 Dual-Rank or 6 Single-Rank modules (Maximum of 48 GB).

Optimized DIMM Population Configurations						
No. of DIMMs	Channel 0			Channel 1		
	2DIMMs	DIMM 1A	-----	-----	DIMM 2A	-----
4DIMMs	DIMM 1A	DIMM 1B	-----	DIMM 2A	DIMM 2B	-----
6DIMMs	DIMM 1A	DIMM 1B	DIMM 1C	DIMM 2A	DIMM 2B	DIMM 2C
<b>(Notes:</b> i. DIMM slot# specified: DIMM slot to be populated; "----": DIMM slot not to be populated. ii. Both Registered ECC DDR2 667MHz and 533 MHz DIMMs are supported; however, you need to use the memory modules of the same speed and of the same type on a motherboard. iii. For memory to work properly, you need to follow the restrictions listed above.)						

**Note 2:** Due to OS limitations, some operating systems may not show more than 4 GB of memory.

**Note 3:** Due to memory allocation to system devices, memory remaining available for operational use will be reduced when 4 GB of RAM is used. The reduction in memory availability is disproportional. (Refer to the following Memory Availability Table for details. For Microsoft Windows users: Microsoft implemented a design change in Windows XP with Service Pack 2 (SP2) and Windows Vista. This change is specific to the Physical Address Extension (PAE) mode behavior which improves driver compatibility. For more information, please read the following article at Microsoft's Knowledge Base website at: <http://support.microsoft.com/kb/888137>.)

Possible System Memory Allocation & Availability		
System Device	Size	Physical Memory Remaining (-Available) (4 GB Total System Memory)
Firmware Hub flash memory (System BIOS)	1 MB	3.99
Local APIC	4 KB	3.99
Area Reserved for the chipset	2 MB	3.99
I/O APIC (4 Kbytes)	4 KB	3.99
PCI Enumeration Area 1	256 MB	3.76
PCI Express (256 MB)	256 MB	3.51
PCI Enumeration Area 2 (if needed) -Aligned on 256-MB boundary-	512 MB	3.01
VGA Memory	16 MB	2.85
TSEG	1 MB	2.84
Memory available to OS and other applications		2.84

### Installing and Removing DIMMs

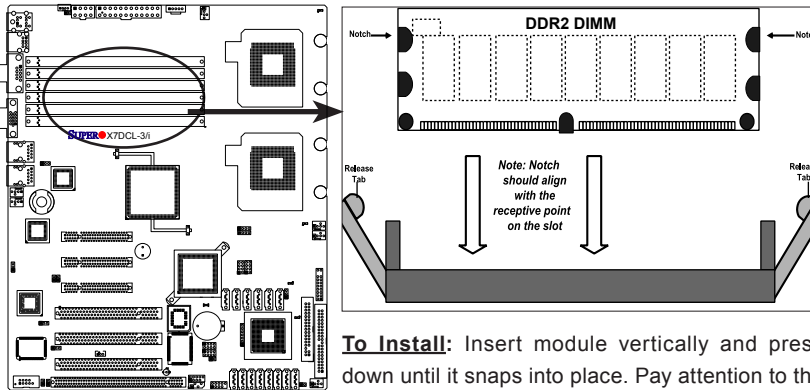

**To Install:** Insert module vertically and press down until it snaps into place. Pay attention to the alignment notch at the bottom.

#### **To Remove:**

Use your thumbs to gently push the release tabs near both ends of the module to release it from the slot.

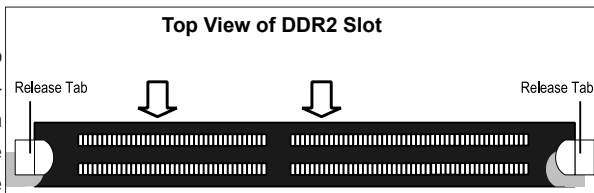

## 2-4 Control Panel Connectors/IO Ports

The I/O ports are color coded in conformance with the PC 99 specification. See the figure below for the colors and locations of the various I/O ports.

### Back Panel Connectors/IO Ports

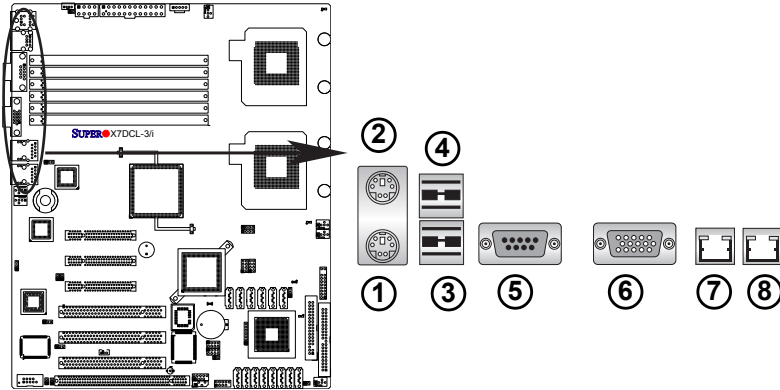

**Back Panel I/O Port Locations and Definitions**

#### **Back Panel Connectors**

1. Keyboard (Purple)
2. PS/2 Mouse (Green)
3. Back Panel USB Port 0
4. Back Panel USB Port 1
5. COM Port 1 (Turquoise)
6. VGA Port (Blue)
7. Gigabit LAN 1
8. Gigabit LAN 2

(See Section 2-5 for details.)

## Front Control Panel

JF1 contains header pins for various buttons and indicators that are normally located on a control panel at the front of the chassis. These connectors are designed specifically for use with Super Micro server chassis. See the figure below for the descriptions of the various control panel buttons and LED indicators. Refer to the following section for descriptions and pin definitions.

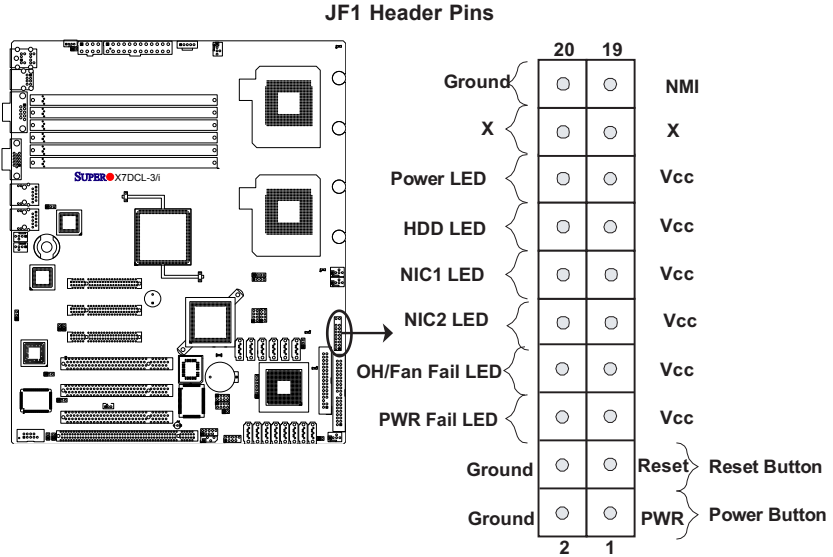

## Front Control Panel Pin Definitions

### NMI Button

The non-maskable interrupt button header is located on pins 19 and 20 of JF1. Refer to the table on the right for pin definitions.

NMI Button Pin Definitions (JF1)	
Pin#	Definition
19	Control
20	Ground

### Power LED

The Power LED connection is located on pins 15 and 16 of JF1. Refer to the table on the right for pin definitions.

Power LED Pin Definitions (JF1)	
Pin#	Definition
15	+5V
16	Ground

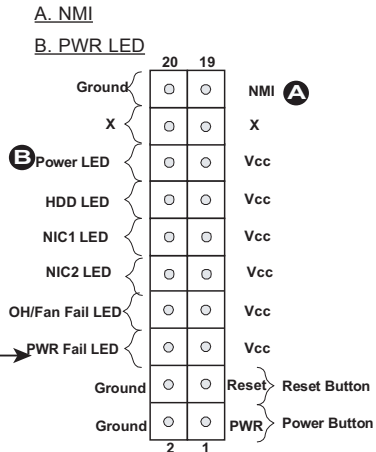
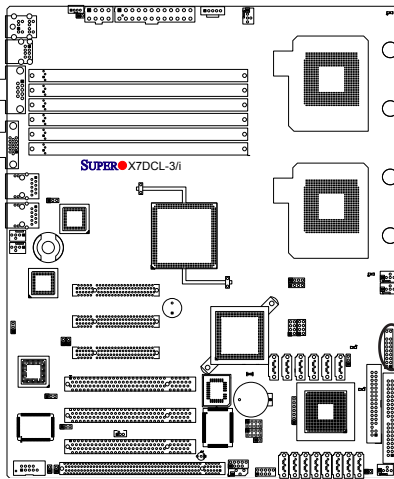

### HDD LED

The HDD LED connection is located on pins 13 and 14 of JF1. Attach a hard drive LED cable here to display disk activity (for any hard drives on the system, including SAS, Serial ATA and IDE). See the table on the right for pin definitions.

HDD LED Pin Definitions (JF1)	
Pin#	Definition
13	+5V
14	HD Active

### NIC1/NIC2 LED Indicators

The NIC (Network Interface Controller) LED connection for GLAN port1 is located on pins 11 and 12 of JF1 and the LED connection for GLAN Port2 is on Pins 9 and 10. Attach the NIC LED cables to display network activity. Refer to the table on the right for pin definitions.

GLAN1/2 LED Pin Definitions (JF1)	
Pin#	Definition
9/11	Vcc
10/12	Ground

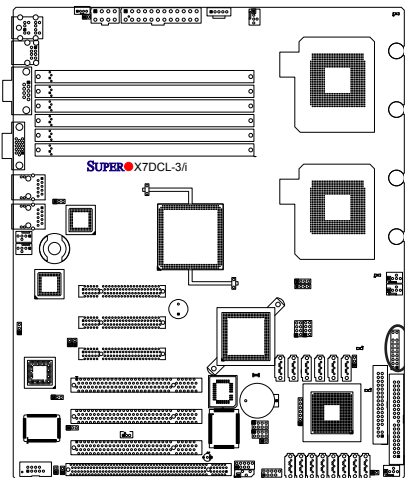

A. HDD LED

B. NIC1 LED

C. NIC2 LED

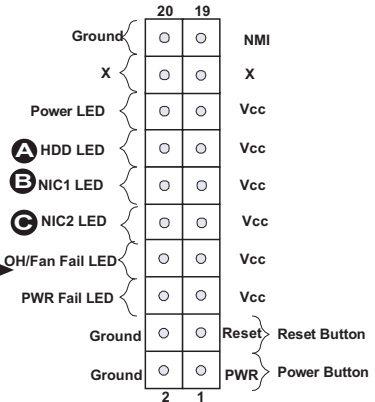

### Overheat/Fan Fail LED (OH)

Connect an LED to the OH/Fan Fail connection on pins 7 and 8 of JF1 to provide advanced warnings of chassis overheating or fan failure. Refer to the table on the right for pin definitions.

OH/Fan Fail LED Pin Definitions (JF1)	
Pin#	Definition
7	Vcc
8	Ground

OH/Fan Fail Indicator Status	
State	Definition
Off	Normal
On	Overheat
Flashing	Fan Fail

### Power Fail LED

The Power Fail LED connection is located on pins 5 and 6 of JF1. Refer to the table on the right for pin definitions.

PWR Fail LED Pin Definitions (JF1)	
Pin#	Definition
5	Vcc
6	Ground

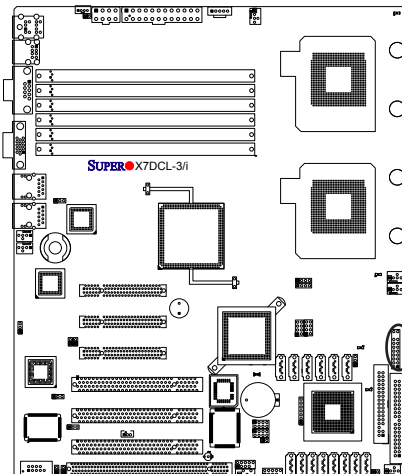

#### A. OH/Fan Fail LED

#### B. PWR Supply Fail

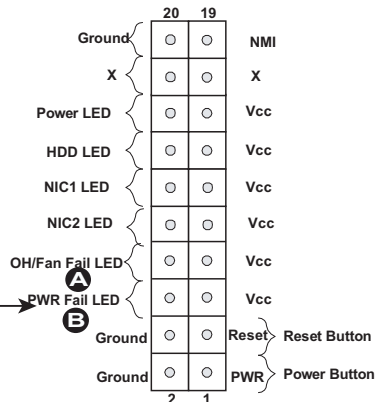



### Reset Button

The Reset Button connection is located on pins 3 and 4 of JF1. Attach it to the hardware reset switch on the computer case. Refer to the table on the right for pin definitions.

Reset Button Pin Definitions (JF1)	
Pin#	Definition
3	Reset
4	Ground

### Power Button

The Power Button connection is located on pins 1 and 2 of JF1. Momentarily contacting both pins will power on/off the system. This button can also be configured to function as a suspend button (with a setting in the BIOS - see Chapter 4). To turn off the power when set to suspend mode, press the button for at least 4 seconds. Refer to the table on the right for pin definitions.

Power Button Pin Definitions (JF1)	
Pin#	Definition
1	Signal
2	+3V Standby

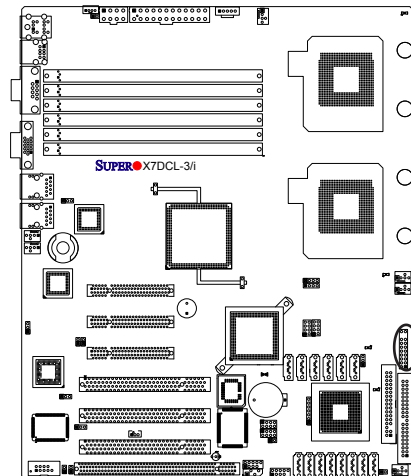

A. Reset Button

B. PWR Button

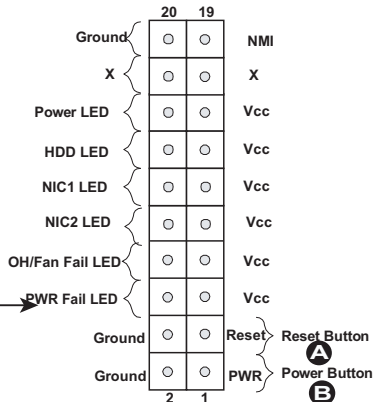

## 2-5 Connecting Cables

### ATX Power Connector

A 24-pin main power supply connector is located at JPW2, and an 8-pin CPU PWR connector is located at JPW1 on the motherboard. These power connectors meet the SSI EPS 12V specification. See the table on the right for pin definitions. For the 8-pin PWR (JPW1), refer to the item below.

### Processor Power Connector

In addition to the Primary ATX power connector, the 12V 8-pin CPU PWR connector at JPW1 must also be connected to provide adequate power to your processors. See the table on the right for pin definitions.

Pin#	Definition	Pin #	Definition
13	+3.3V	1	+3.3V
14	-12V	2	+3.3V
15	COM	3	COM
16	PS_ON	4	+5V
17	COM	5	COM
18	COM	6	+5V
19	COM	7	COM
20	Res (NC)	8	PWR_OK
21	+5V	9	5VSB
22	+5V	10	+12V
23	+5V	11	+12V
24	COM	12	+3.3V

Pins	Definition
1 through 4	Ground
5 through 8	+12V

#### Required Connection

A. 24-pin ATX PWR

B. 8-pin Processor PWR

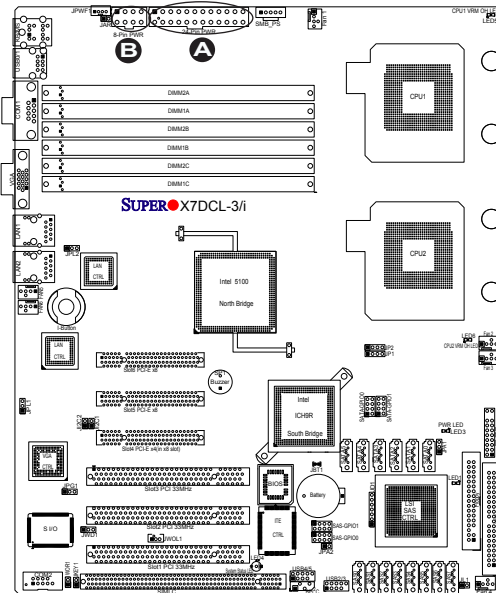

## Universal Serial Bus (USB)

There are six USB 2.0 (Universal Serial Bus) ports/headers on the motherboard. Two of them are Back Panel USB ports (USB#0/1: JUSB1), and the other four are Front Panel USB connectors (USB#2/3: JUSB2), or Front-Accessible USB headers (USB#4/#5: JUSB3). See the tables on the right for pin definitions.

Back Panel USB (0/1) Pin Definitions	
Pin#	Definitions
1	+5V
2	PO-
3	PO+
4	Ground
5	N/A

Front Panel USB Pin Definitions (USB2/3/4/5)			
USB2/3		USB4/5	
Pin #	Definition	Pin #	Definition
1	+5V	1	+5V
2	PO-	2	PO-
3	PO+	3	PO+
4	Ground	4	Ground
5	Key	5	No connection

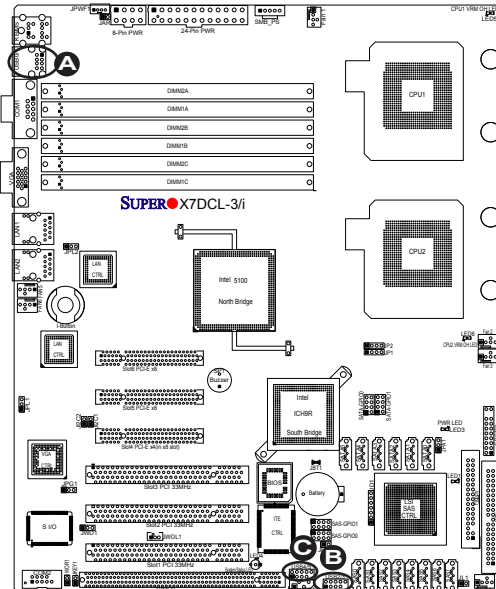

- A. Backpanel USB 0/1
- B. Front Panel USB 2/3
- C. Front Panel USB 4/5

## Fan Headers

The X7DCL-3/X7DCL-i has four chassis/system fan headers (Fan3 to Fan6), and two CPU Fans (Fans 1/2). All these fans are 4-pin fans. However, Pins 1-3 of the fan headers are backward compatible with the traditional 3-pin fans. See the table on the right for pin definitions. **Note:** The onboard fan speeds are controlled by Thermal Management via BIOS Hardware Monitoring in the Advanced Setting. (The default setting is **Disabled**.) Please use all 3-pin fans or all 4-pin fans on the motherboard.

Fan Header Pin Definitions (Fan1-6)	
Pin#	Definition
1	Ground
2	+12V
3	Tachometer
4	PWR Modulation

## Chassis Intrusion

A Chassis Intrusion header is located at JL1 on the motherboard. Attach an appropriate cable from the chassis to inform you of a chassis intrusion when the chassis is opened.

Chassis Intrusion Pin Definitions (JL1)	
Pin#	Definition
1	Intrusion Input
2	Ground

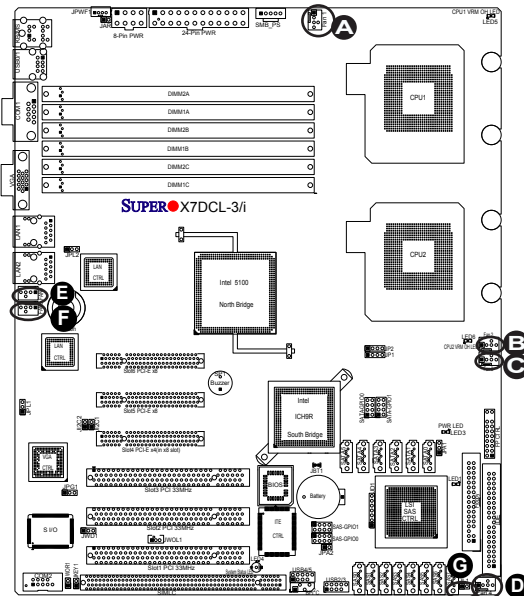

- A. Fan 1
- B. Fan 2
- C. Fan 3
- D. Fan 4
- E. Fan 5
- F. Fan 6
- G. Chassis Intrusion

## ATX PS/2 Keyboard and PS/2 Mouse Ports

The ATX PS/2 keyboard and the PS/2 mouse are located at JKM1. See the table on the right for pin definitions. (The mouse port is above the keyboard port.) See the table on the right for pin definitions.

PS/2 Keyboard and Mouse Port Pin Definitions	
Pin#	Definition
1	Data
2	NC
3	Ground
4	VCC
5	Clock
6	NC

## Serial Ports

COM1 is a connector located on the IO Backpanel, and COM2 is a header located at JCOM2. See the table on the right for pin definitions.

Serial Port Pin Definitions (COM1/COM2)			
Pin #	Definition	Pin #	Definition
1	CD	6	DSR
2	RD	7	RTS
3	TD	8	CTS
4	DTR	9	RI
5	Ground	10	NC

(Pin 10 is available on COM2 only. NC: No Connection.)

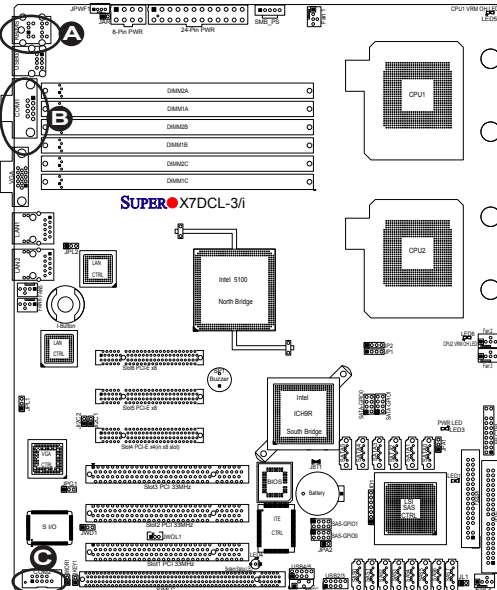

- A. Keyboard/Mouse
- B. COM1
- C. COM2

## Wake-On-Ring

The Wake-On-Ring header is located at JWOR1. This feature allows your computer to receive and be "awakened" by an incoming call to the modem when the system is in the suspend state. See the table on the right for pin definitions. You must have a Wake-On-Ring card and cable to use this feature.

Wake-On-Ring Pin Definitions	
Pin#	Definition
1	Ground
2	Wake-up

## Wake-On-LAN

The Wake-On-LAN header is located at JWOL1 on the motherboard. See the table on the right for pin definitions. (You must have a LAN card with a Wake-On-LAN connector, and cable to use this feature.)

Wake-On-LAN Pin Definitions	
Pin#	Definition
1	+5V Standby
2	Ground
3	Wake-up

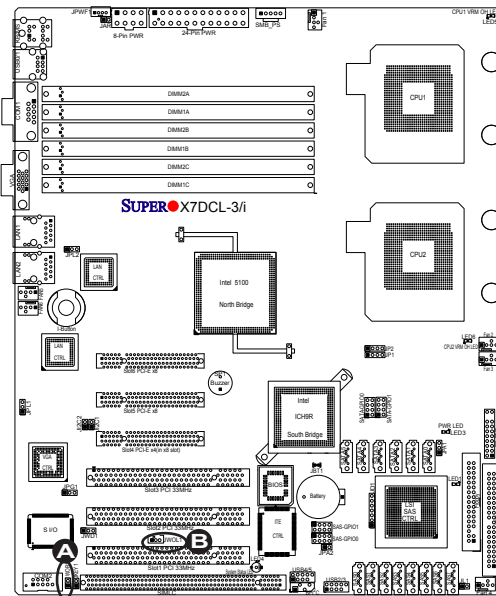

A. WOR

B. WOL

## GLAN 1/2 (Giga-bit Ethernet Ports)

Two G-bit Ethernet ports are located at JLAN1 and JLAN2 on the I/O backplane. These ports accept RJ45 type cables.



## Power LED/Speaker

On the JD1 header, pins 1-3 are for a power LED, and pins 4-7 are for the speaker. See the table on the right for speaker pin definitions. **Note:** The speaker connector pins are for use with an external speaker. If you wish to use the onboard speaker, you should close pins 6-7 with a jumper.

Speaker Connector	
Pin Setting	Definition
Pins 6-7	Internal Speaker
Pins 4-7	External Speaker

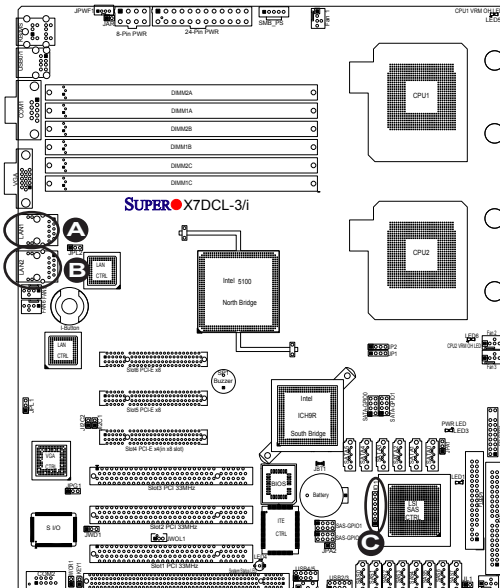

A. GLAN1

B. GLAN2

C. PWR LED/Speaker

## Alarm Reset

If three power supplies are installed, the system will notify you when any of the three power modules fails. Connect JAR1 to a micro-switch to turn off the alarm that is activated when a power module fails. See the table on the right for pin definitions.

Alarm Reset Pin Definitions	
Pin Setting	Definition
Pin 1	Ground
Pin 2	+5V

## PWR Supply Failure/PWR Fault Detect

The system can notify you in the event of a power supply failure. This feature is available when three power supply units are installed in the chassis with one acting as a backup. If you only have one or two power supply units installed, you should disable this (the default setting) with JPWF1 to prevent false alarms.

PWR Supply PWR Fault Connector	
Jumper Setting	Definition
On	Enabled
Off	Disabled (Default)

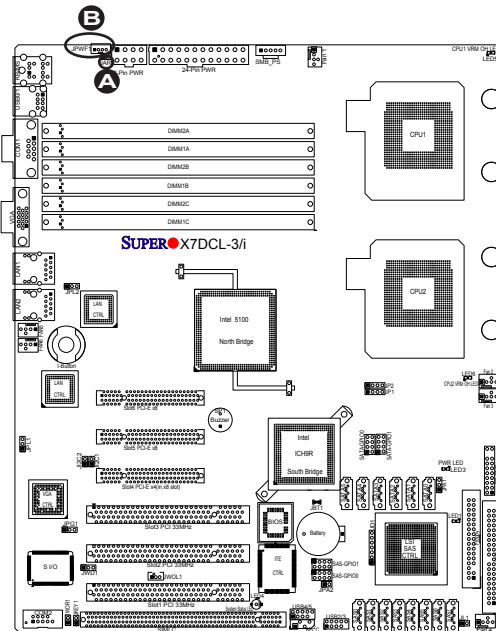

A. Alarm Reset

B. PWR Fault



## VGA Connector

A VGA connector (JVGA) is located next to the COM1 port on the IO backplane. Refer to the board layout below for the location.

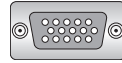

## GPIO Headers

Four GPIO (Serial Links General Purpose Input/Output) headers are located at J7, J8, J9, J10 on the motherboard. These headers are used to communicate with the Serial-Links System Monitoring chip on the backplane. J7 and J8 are used to monitor SATA activities, J9 and J10 are used to monitor SAS connections. See the table on the right for pin definitions. Refer to the board layout below for the locations of the headers.

Serial-Links GPIO Pin Definitions			
Pin#	Definition	Pin	Definition
1	NC	2	NC
3	Ground	4	DATA Out
5	Load	6	Ground
7	Clock	8	NC

**Note:** NC= No Connections

(J9, J10: X7DCL-3 Only.)

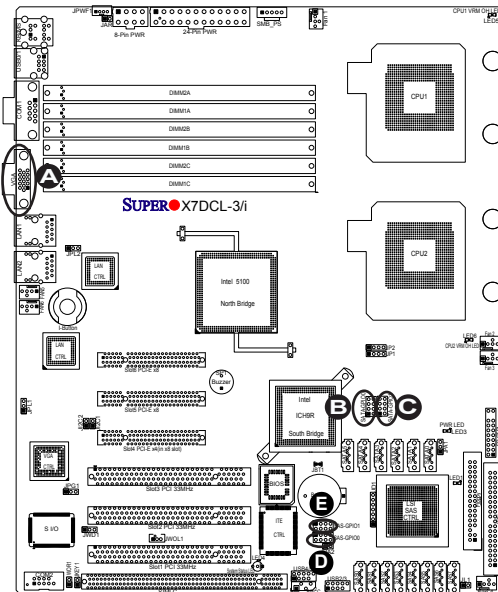

### A. VGA

B. J7: SATA\_GPIO#0

C. J8: SATA\_GPIO#1

D. J9: SAS\_GPIO#0

E. J10: SAS\_GPIO#1

### Power SMB (I<sup>2</sup>C) Connector

Power SMB (I<sup>2</sup>C) Connector (JPIC1) monitors the status of the power supply, fan and system temperature. See the table on the right for pin definitions.

PWR SMB Pin Definitions	
Pin#	Definition
1	Clock
2	Data
3	PWR Fail
4	Ground
5	+3.3V

### BP PWR SMB (I<sup>2</sup>C) Connector

Backplane Power SMB (I<sup>2</sup>C) Connector (J5) monitors power supply of backplane IO connectors. See the table on the right for pin definitions.

BP PWR SMB Pin Definitions	
Pin#	Definition
1	SMB_DAT_ICH_EXT
2	Ground
3	SMB_CLK_ICH_EXT
5	No Connection

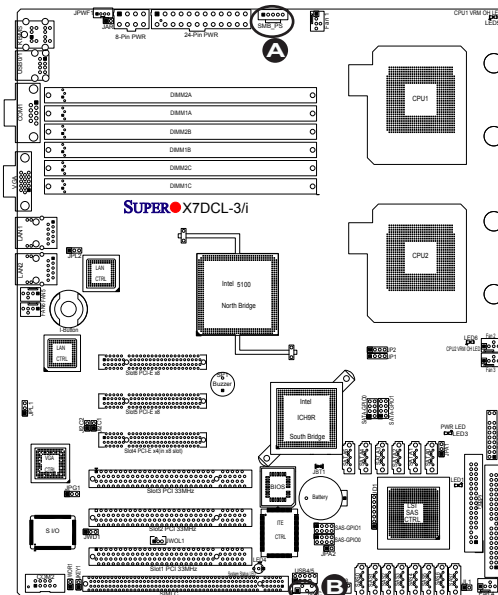

A. PWR SMB

B. Backplane PWR SMB

## Keylock

The keyboard lock connection is designated JKEY1. Utilizing this header allows you to inhibit any actions made on the keyboard, effectively "locking" it.

Keylock Pin Definitions	
Pin#	Definition
1	Ground
2	Keylock R-N

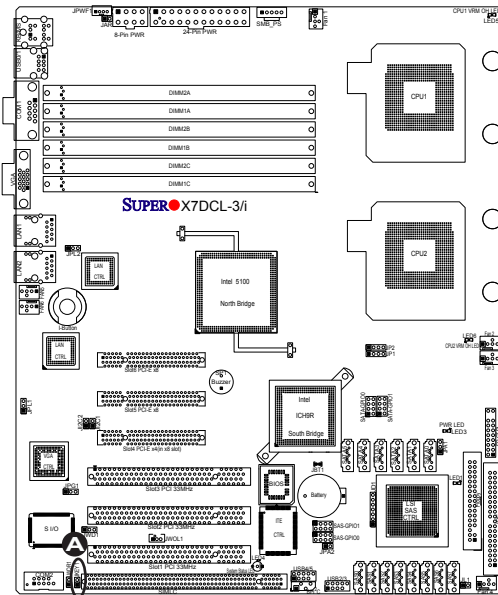

A. Keylock

## 2-6 Jumper Settings

### Explanation of Jumpers

To modify the operation of the motherboard, jumpers can be used to choose between optional settings. Jumpers create shorts between two pins to change the function of the connector. Pin 1 is identified with a square solder pad on the printed circuit board. See the motherboard layout pages for jumper locations.

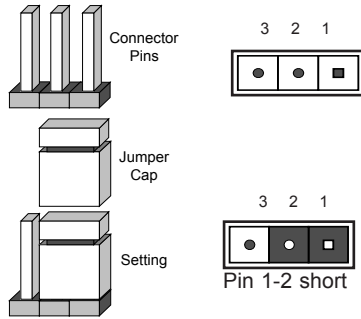

**Note:** On two pin jumpers, "Closed" means the jumper is on and "Open" means the jumper is off the pins.

### GLAN Enable/Disable

JPL1/JPL2 enable or disable GLAN Port1/GLAN Port2 on the motherboard. See the table on the right for jumper settings. The default setting is **Enabled**.

GLAN Enable Jumper Settings	
Pin#	Definition
1-2	Enabled (default)
2-3	Disabled

- A. GLAN Port1 Enable
- B. GLAN Port2 Enable

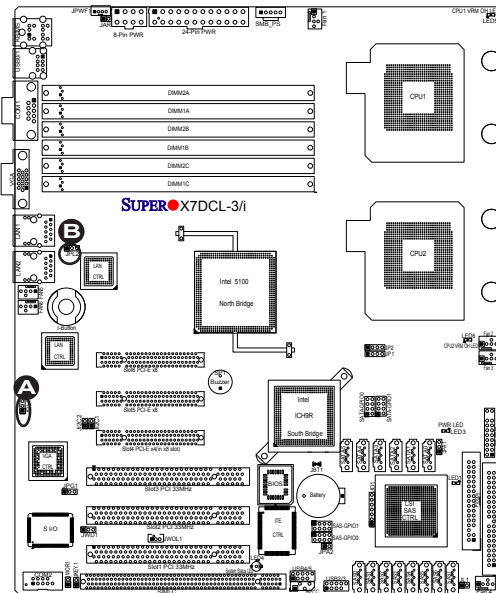

### CMOS Clear

JBT1 is used to clear CMOS. Instead of pins, this "jumper" consists of contact pads to prevent the accidental clearing of CMOS. To clear CMOS, use a metal object such as a small screwdriver to touch both pads at the same time to short the connection. Always remove the AC power cord from the system before clearing CMOS.

**Note:** For an ATX power supply, you must completely shut down the system, remove the AC power cord and then short JBT1 to clear CMOS.



### Watch Dog Enable/Disable

Watch Dog is a system monitor that can reboot the system when a software application hangs. Close pins 1-2 to reset the system if an application hangs. Close pins 2-3 to generate a non-maskable interrupt signal for the application that hangs. See the table on the right for jumper settings. Watch Dog must also be enabled in the BIOS.

Watch Dog Jumper Settings	
Jumper Setting	Definition
Pins 1-2	Reset (default)
Pins 2-3	NMI
Open	Disabled

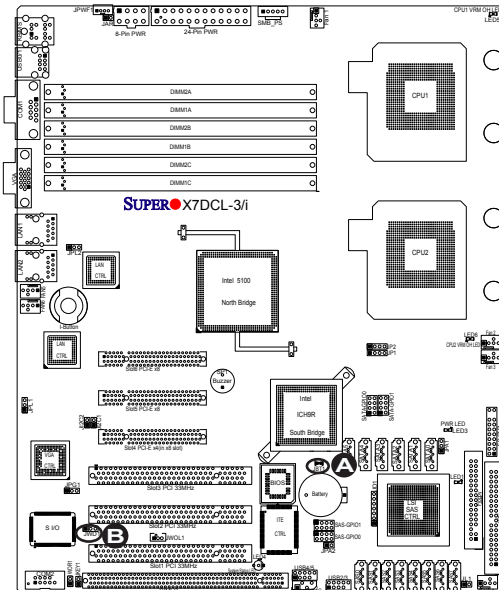

A. Clear CMOS

B. Watch Dog Enable

### VGA Enable/Disable

JPG1 allows you to enable or disable the VGA port. The default position is on pins 1 and 2 to enable VGA. See the table on the right for jumper settings.

VGA Enable/Disable Jumper Settings	
Both Jumpers	Definition
Pins 1-2	Enabled (Default)
Pins 2-3	Disabled

### I<sup>2</sup>C Bus to PCI/PCI-Exp. Slots

Jumpers JPI<sup>2</sup>C1/JPI<sup>2</sup>C2 allow you to connect the System Management Bus (I<sup>2</sup>C) to PCI/PCI-Exp. slots. The default setting is Open to disable the connection. See the table on the right for jumper settings.

I <sup>2</sup> C to PCI/PCI-Exp. Slots Jumper Settings	
Jumper Setting	Definition
Closed	Enabled
Open	Disabled (Default)

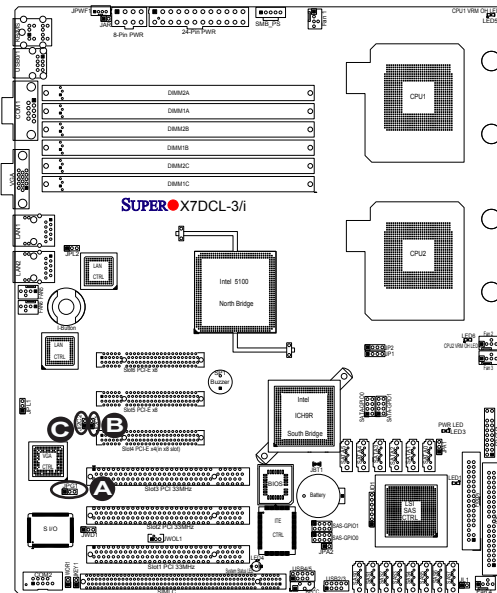

- A. VGA Enabled
- B. JPI<sup>2</sup>C1
- C. JPI<sup>2</sup>C2

### SAS Enable/Disable

JPA1 allows you to enable or disable SAS Connectors. The default position is on pins 1 and 2 to enable SAS. See the table on the right for jumper settings.

(**Note:** This feature is available on the X7DCL-3 only.)

SAS Enable/Disable Jumper Settings	
Jumper Settings	Definition
Pins 1-2	Enabled (Default)
Pins 2-3	Disabled

### Software RAID Enable

JPA2 allows you to select the SAS RAID mode. You can use either Software RAID or IT RAID. Close this jumper to use Software RAID (Default). Set this jumper to open to use the IT RAID mode. Contact Tech. Support at Supermicro for more information. See the table on the right for jumper settings.

(**Note:** This feature is available on the X7DCL-3 only.)

Software RAID Jumper Settings	
Jumper Settings	Definition
Close (Default)	Software RAID Enabled
Open ( <b>Note</b> )	IT Mode Enabled

(**Note:** Also contact tech support at Super Micro for further instructions.)

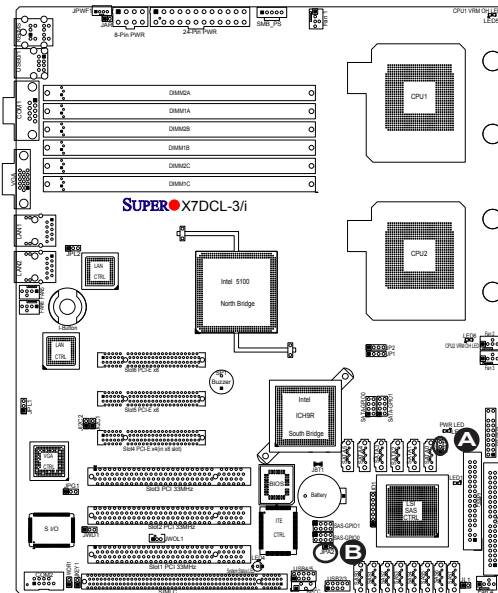

A. SAS Enabled

B. Software RAID Enable

## 2-7 Onboard LED Indicators

### GLAN LEDs

There are two GLAN ports on the motherboard. Each Gigabit Ethernet LAN port has two LEDs. The yellow LED indicates activity, while the power LED may be green, orange or off to indicate the speed of the connection. See the tables at right for more information.

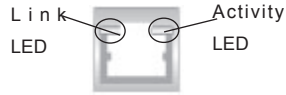

**Rear View**  
(when viewing from the back of the chassis.)

GLAN Activity Indicator Settings		
Color	Status	Definition
Yellow	Flashing	LAN Active

GLAN Link Indicator Settings	
LED Color	Definition
Off	No Connection or 10 Mbps
Green	100 Mbps
Amber	1 Gbps

### Onboard Power LED (LED3)

An Onboard Power LED is located at LED3 on the motherboard. When this LED is lit, the system is on. Be sure to turn off the system and unplug the power cord before removing or installing components. See the layout below for the LED location.

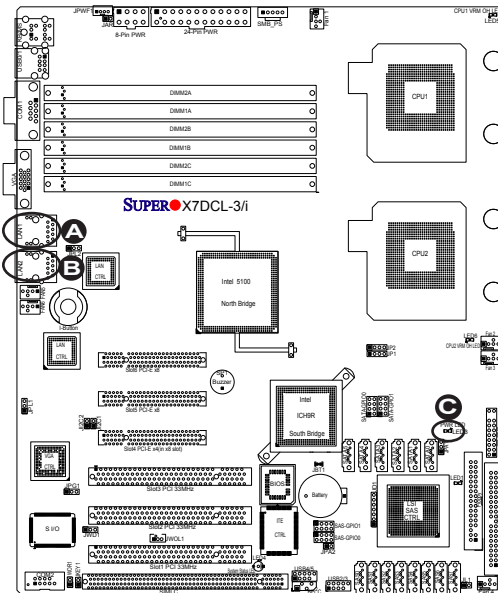

- A. GLAN Port1 LEDs
- B. GLAN Port2 LEDs
- C. Onboard PWR LED



### System Status LED (LED4)

A Status LED Indicator is located at LED4 on the motherboard. This LED displays different colors to show the status of the system. Refer to the table on the right for system status. See the layout below for the LED location.

Status LED Indicator Settings	
LED Color	Definition
Green	Power On, system: normal
Red	PWR on, PWR problem(s) occur(s) or the 3rd PWR not properly installed
Yellow	System Off, AC PWR: connected

### CPU\_VRM Overheating LED Indicators (LED5/LED6)

Two CPU\_VRM Overheat LEDs are located at LED5 and LED6 on the motherboard. These LEDs provide indications for CPU\_VRM Overheating. Refer to the table on the right for LED5 and LED6 settings. See the layout below for the LED locations.

CPU_VRM Overheat LED Indicator Settings	
LED#	Description
LED5: On	CPU1_VRM Overheating
LED6: On	CPU2_VRM Overheating

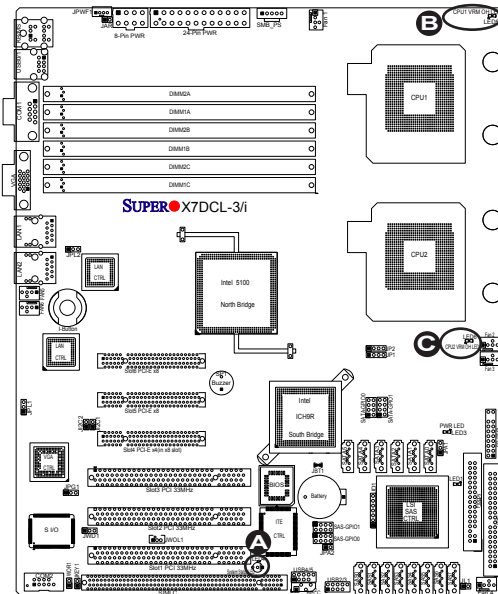

- A. LED4: System Status LED
- B. LED5: CPU1\_VRM OH LED
- C. LED6: CPU2\_VRM OH LED

## SAS LED Indicator (LED1)

A SAS LED is located at LED1 on the motherboard. This LED indicates the status of SAS connections. Refer to the table on the right for LED1 settings. See the layout below for the LED location.

SAS LED Indicator Settings	
LED#	Description
LED1: On	SAS: Active
LED1: Off	SAS: Not Active

(Available on the X7DCL-3 only)

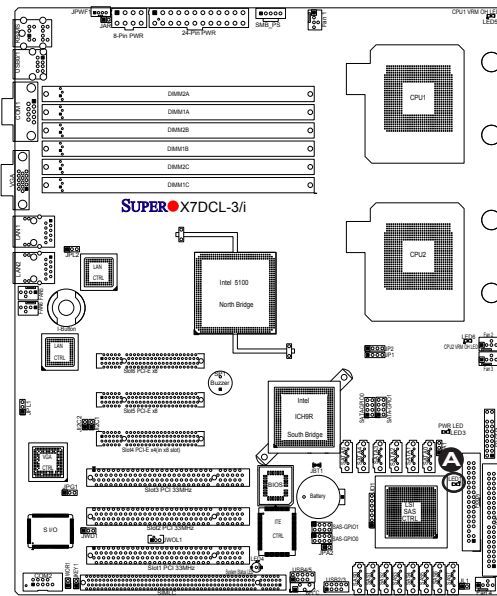

A. LED1: SAS LED

## 2-8 Floppy Drive, SIMLC IPMI and Hard Disk Drive Connections

Note the following when connecting the floppy and hard disk drive cables:

- The floppy disk drive cable has seven twisted wires.
- A red mark on a wire typically designates the location of pin 1.

### Floppy Connector

The floppy connector is located at JFDD1. See the table below for pin definitions.

Floppy Drive Connector Pin Definitions (Floppy)			
Pin#	Definition	Pin #	Definition
1	Ground	2	FDHDIN
3	Ground	4	Reserved
5	Key	6	FDEDIN
7	Ground	8	Index
9	Ground	10	Motor Enable
11	Ground	12	Drive Select B
13	Ground	14	Drive Select B
15	Ground	16	Motor Enable
17	Ground	18	DIR
19	Ground	20	STEP
21	Ground	22	Write Data
23	Ground	24	Write Gate
25	Ground	26	Track 00
27	Ground	28	Write Protect
29	Ground	30	Read Data
31	Ground	32	Side 1 Select
33	Ground	34	Diskette

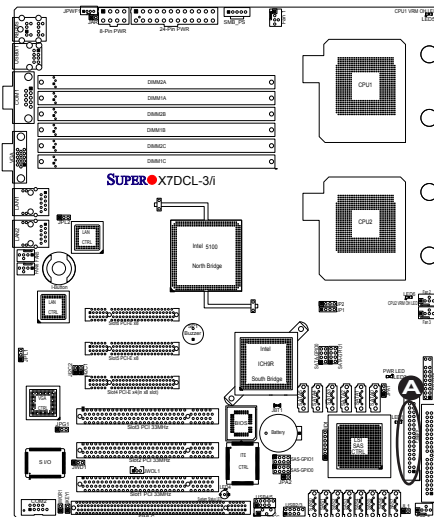

A. Floppy Disk Drive

### IDE Connector

An IDE Connector is located at JIDE1 on the motherboard. This motherboard uses the ITE IT8213F Controller. An IDE Driver is required for the IDE drive to function properly. See the table on the right for pin definitions.

IDE Drive Connector Pin Definitions			
Pin#	Definition	Pin #	Definition
1	Reset IDE	2	Ground
3	Host Data 7	4	Host Data 8
5	Host Data 6	6	Host Data 9
7	Host Data 5	8	Host Data 10
9	Host Data 4	10	Host Data 11
11	Host Data 3	12	Host Data 12
13	Host Data 2	14	Host Data 13
15	Host Data 1	16	Host Data 14
17	Host Data 0	18	Host Data 15
19	Ground	20	Key
21	DRQ3	22	Ground
23	I/O Write	24	Ground
25	I/O Read	26	Ground
27	IOCHRDY	28	BALE
29	DACK3	30	Ground
31	IRQ14	32	IOCS16
33	Addr1	34	Ground
35	Addr0	36	Addr2
37	Chip Select 0	38	Chip Select 1
39	Activity	40	Ground

### SIMLC IPMI Slot

A Low Profile SIMLC IPMI Slot is located on the motherboard. Refer to the layout below for the IPMI Slot location.

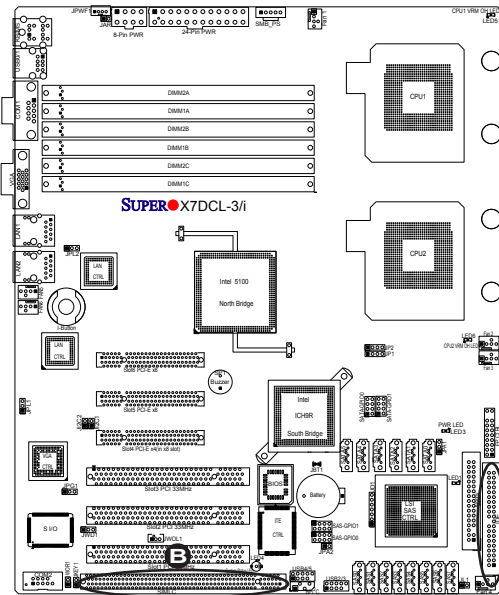

- A. IDE
- B. SIMLC

## Chapter 3

# Troubleshooting

### 3-1 Troubleshooting Procedures

Use the following procedures to troubleshoot your system. If you have followed all of the procedures below and still need assistance, refer to the 'Technical Support Procedures' and/or 'Returning Merchandise for Service' section(s) in this chapter.

**Note: Always disconnect the power cord before adding, changing or installing any hardware components.**

#### Before Power On

1. Make sure that there are no short circuits between the motherboard and the chassis.
2. Disconnect all ribbon/wire cables from the motherboard, including those for the keyboard and mouse. Remove all add-on cards.
3. Install a CPU in CPU Socket and connect the chassis speaker and the power LED to the motherboard. (Make sure that the CPU is properly seated. Be sure to check all jumper settings as well.)

#### No Power

1. Make sure that there are no short circuits between the motherboard and the chassis.
2. Make sure that all jumpers are set to their default positions.
3. Make sure that the 115V/230V switch on the power supply is properly set.
4. Turn the power switch on and off to test the system. The battery on your motherboard may be old. Check to verify that it still supplies ~3VDC. If it does not, replace it with a new one.

#### No Video

1. If the power is on but you have no video, remove all the add-on cards and cables.
2. Use the speaker to determine if any beep codes exist. Refer to the Appendix for details on beep codes.

#### Losing the System's Setup Configuration

1. Make sure that you are using a high quality power supply. A poor quality power supply may cause the system to lose the CMOS setup information. Refer to Section 1-6 for details on recommended power supplies.
2. The battery on your motherboard may be old. Check to verify that it still

supplies ~3VDC. If it does not, replace it with a new one.

3. If the above steps do not fix the Setup Configuration problem, contact your vendor for repairs.

---

### **NOTE**

If you are a system integrator, VAR or OEM, a POST diagnostics card is recommended. For I/O port 80h codes, refer to App. B.

---

### **Memory Errors**

1. Make sure the DIMM modules are properly and fully installed. Check if DIMMs of different speeds or types have been installed. Also make sure that the BIOS setup is configured for the fastest speed of RAM used.
2. It is recommended to use the same RAM speed for all DIMMs in the system. Make sure you are using the correct type of Single-Rank, Registered ECC DDR2 667/533 SDRAM (recommended by the manufacturer.)
3. Check for bad DIMM modules or slots by swapping a single module between four slots and noting the results. Make sure all memory modules are fully seated in their slots. As an interleaved memory scheme is used, you must install two modules at a time, beginning with DIMM 1A, then DIMM 2A, and so on (see Section 2-3). Check the position of the 115V/230V switch on the power supply.

## **3-2 Technical Support Procedures**

Before contacting Technical Support, please take the following steps. Also, note that as a motherboard manufacturer, Super Micro does not sell directly to end-users, so it is best to first check with your distributor or reseller for troubleshooting services. They should know of any possible problem(s) with the specific system configuration that was sold to you.

1. Please go through the 'Troubleshooting Procedures' and 'Frequently Asked Question' (FAQ) sections in this chapter or see the FAQs on our web site (<http://www.supermicro.com/support/faqs/>) before contacting Technical Support.
2. BIOS upgrades can be downloaded from our web site at <http://www.supermicro.com/support/bios/>.
3. If you still cannot resolve the problem, include the following information when contacting Super Micro for technical support:
  - Motherboard model and PCB revision number
  - BIOS release date/version (this can be seen on the initial display when your system first boots up)

- System configuration
- An example of a Technical Support form is on our web site at <http://www.supermicro.com/support/contact.cfm/>.
- Distributors: For immediate assistance, please have your account number ready when placing a call to our technical support department. We can be reached by e-mail at [support@supermicro.com](mailto:support@supermicro.com) or by fax at: (408) 503-8000, option 2.

### 3-3 Frequently Asked Questions

**Question: What are the various types of memory that my motherboard can support?**

**Answer:** The X7DCL-3/X7DCL-i has six 240-pin DIMM slots that support Single-Rank, Registered ECC DDR2 667/533 SDRAM modules. It is strongly recommended that you do not mix memory modules of different speeds and sizes. (See Chapter 2 for detailed Information.)

**Question: Why does Microsoft Windows XP (SP2) and Windows Vista show less memory than what is physically installed?**

**Answer:** Microsoft implemented a design change in Windows XP with Service Pack 2 (SP2) and Windows Vista. This change is specific to the Physical Address Extension (PAE) mode behavior which improves driver compatibility. For more information, please read the following article at Microsoft's Knowledge Base website at: <http://support.microsoft.com/kb/888137>.

**Question: How do I update my BIOS?**

**Answer:** It is recommended that you **do not** upgrade your BIOS if you are not experiencing any problems with your system. Updated BIOS files are located on our web site at <http://www.supermicro.com/support/bios/>. Please check our BIOS warning message and the information on how to update your BIOS on our web site. Select your motherboard model and download the BIOS file to your computer. Also, check the current BIOS revision and make sure that it is newer than your BIOS before downloading. You can choose from the zip file and the .exe file. If you choose the zip BIOS file, please unzip the BIOS file onto a bootable device or a USB pen. Run the batch file using the format flash.bat filename.rom from your bootable device or USB pen to flash the BIOS. Then, your system will automatically reboot. If you choose the .exe file, please run the .exe file under Windows to create the BIOS flash floppy disk. Insert the floppy disk into the system you wish to flash the BIOS. Then, bootup the system to the floppy disk. The BIOS utility will automatically flash the BIOS without any prompts. Please note that this process may take a few minutes to complete. Do not be concerned if the screen is paused for a few minutes.



**(Warning:** Do not shut down or reset the system while updating BIOS to prevent possible system boot failure!)

**Question: What's on the CD that came with my motherboard?**

**Answer:** The supplied compact disc has quite a few drivers and programs that will greatly enhance your system. We recommend that you review the CD and install the applications you need. Applications on the CD include chipset drivers for the Windows OS, and security and audio drivers.

### 3-4 Returning Merchandise for Service

A receipt or copy of your invoice marked with the date of purchase is required before any warranty service will be rendered. You can obtain service by calling your vendor for a Returned Merchandise Authorization (RMA) number. When returning to the manufacturer, the RMA number should be prominently displayed on the outside of the shipping carton, and mailed prepaid or hand-carried. Shipping and handling charges will be applied for all orders that must be mailed when service is complete.

This warranty only covers normal consumer use and does not cover damage incurred in shipping or from failure due to the alternation, misuse, abuse or improper maintenance of products.

During the warranty period, contact your distributor first for any product problems.

**Note:** For faster service, RMA authorizations may be requested online (<http://www.supermicro.com/support/rma/>).



# Chapter 4

## BIOS

### 4-1 Introduction

This chapter describes the Phoenix BIOS™ Setup utility for the X7DCL-3/X7DCL-i. Phoenix ROM BIOS is stored in a flash chip and can be easily upgraded using a floppy disk-based program.

**Note:** Due to periodic changes to the BIOS, some settings may have been added or deleted and might not yet be recorded in this manual. Please refer to the Manual Download area of the Super Micro web site <<http://www.supermicro.com>> for any changes to the BIOS that may not be reflected in this manual.

#### System BIOS

BIOS is the Basic Input Output System used in all IBM® PC, XT™, AT®, and PS/2® compatible computers. Phoenix BIOS stores the system parameters, types of disk drives, video displays, etc. in the CMOS. CMOS memory requires very little electrical power. When the computer is turned off, a backup battery provides power to the CMOS Logic, enabling it to retain system parameters. Each time the computer is powered on, the computer is configured with the values stored in the CMOS Logic by the system BIOS, which gains control at boot up.

#### How To Change the Configuration Data

The CMOS information that determines the system parameters may be changed by entering the BIOS Setup utility. This Setup utility can be accessed by pressing the <Delete> key at the appropriate time during system boot. (See below.)

#### Starting the Setup Utility

Normally, the only visible POST (Power On Self Test) routine is the memory test. As the memory is being tested, press the <Delete> key to enter the main menu of the BIOS Setup utility. From the main menu, you can access the other setup screens, such as the Security and Power menus. Beginning with Section 4-3, detailed descriptions are given for each parameter setting in the Setup utility.



**Warning:** Do not shut down or reset the system while updating BIOS to prevent possible boot failure.

## 4-2 Running Setup

*Default settings are in bold text unless otherwise noted.*

The BIOS setup options described in this section are selected by choosing the appropriate text from the main BIOS Setup screen. All displayed text is described in this section, although the screen display is often all you need to understand how to set the options.

When you first power on the computer, Phoenix BIOS™ is immediately activated.

While the BIOS is in control, the Setup program can be activated in one of two ways:

1. By pressing <Delete> immediately after turning the system on, or
2. When the message shown below appears briefly at the bottom of the screen during the POST (Power On Self-Test), press the <Delete> key to activate the main Setup menu:

**Press the <Delete> key to enter Setup**

## 4-3 Main BIOS Setup

All main Setup options are described in this section. The main BIOS Setup screen is displayed below.

Use the Up/Down arrow keys to move among the different settings in each menu. Use the Left/Right arrow keys to change the options for each setting.

Press the <Esc> key to exit the CMOS Setup Menu. The next section describes in detail how to navigate through the menus.

Items that use submenus are indicated with the ► icon. With the item highlighted, press the <Enter> key to access the submenu.

## Main BIOS Setup Menu

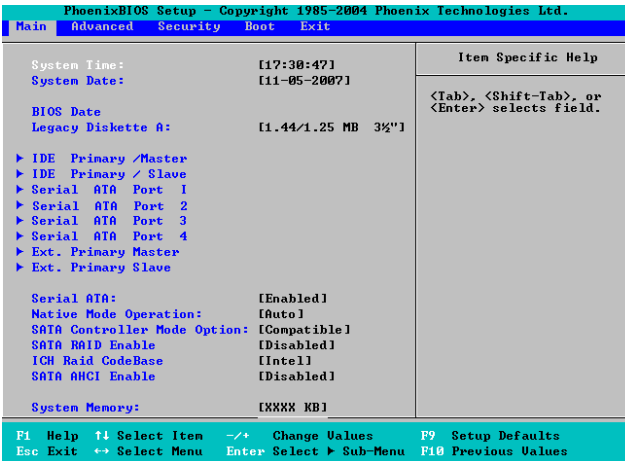

## Main Setup Features

### System Time

To set the system date and time, key in the correct information in the appropriate fields. Then press the <Enter> key to save the data.

### System Date

Using the arrow keys, highlight the month, day and year fields, and enter the correct data. Press the <Enter> key to save the data.

### BIOS Date

This item displays the date when this version of BIOS was built.

### Legacy Diskette A

This setting allows the user to set the type of floppy disk drive installed as diskette A. The options are Disabled, 360Kb 5.25 in, 1.2MB 5.25 in, 720Kb 3.5 in, **1.44/1.25MB**, 3.5 in and 2.88MB 3.5 in.

## ► SATA Port 1 ~ SATA Port 6, Ext. Primary Master/Slave

These settings allow the user to set the parameters of the slots indicated above. Press <Enter> to activate the following submenu screen for detailed options of these items. Set the correct configurations accordingly. The items included in the submenu are:

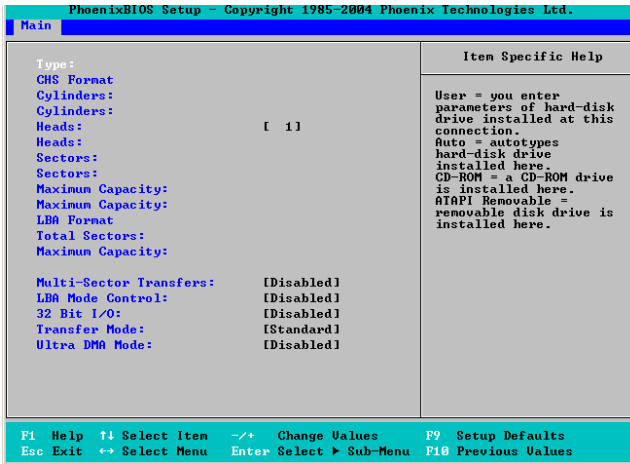

### Type

This option allows the user to select the type of IDE hard drive. The option **Auto** allows the BIOS to automatically configure the parameters of the HDD installed at the connection. Enter a number between 1 to 39 to select a predetermined HDD type. Select User to allow the user to enter the parameters of the HDD installed. Select CDROM if a CDROM drive is installed. Select ATAPI if a removable disk drive is installed.

### Multi-Sector Transfers

This item allows the user to specify the number of sectors per block to be used in multi-sector transfer. The options are **Disabled**, 4 Sectors, 8 Sectors, and 16 Sectors.

### LBA Mode Control

This item determines whether the Phoenix BIOS will access the IDE Channel 0 Master Device via the LBA mode. The options are Enabled and **Disabled**.

### 32 Bit I/O

This option allows the user to enable or disable the function of 32-bit data transfer. The options are Enabled and **Disabled**.

### Transfer Mode

This option allows the user to set the transfer mode. The options are **Standard**, Fast PIO1, Fast PIO2, Fast PIO3, Fast PIO4, FPIO3/DMA1 and FPIO4/DMA2.

### Ultra DMA Mode

This option allows the user to select Ultra DMA Mode. The options are **Disabled**, Mode 0, Mode 1, Mode 2, Mode 3, Mode 4, and Mode 5.

## Serial ATA

This setting allows the user to enable or disable the function of the Serial ATA. The options are Disabled and **Enabled**.

### Native Mode Operation

Select the native mode for ATA. The options are: Serial ATA and **Auto**.

### SATA Controller Mode

Select **Compatible** to allow the SATA and PATA drives to be automatically-detected and be placed in the Legacy Mode by the BIOS. Select Enhanced to allow the SATA and PATA drives to be to be automatically-detected and be placed in the Native IDE Mode. (**Note: The Enhanced mode is supported by the Windows 2000 OS or a later version.**)

When the SATA Controller Mode is set to "Enhanced", the following items will display:

### Serial ATA (SATA) RAID Enable

Select Enable to enable Serial ATA RAID Functions. (For the Windows OS environment, use the RAID driver if this feature is set to Enabled. If this item is set to **Disabled**, the item-SATA AHCI Enable will be available.) The options are Enabled and **Disabled**.

### ICH RAID Code Base

Select **Intel** to enable Intel's SATA RAID firmware to configure Intel's SATA RAID settings. The options are **Intel** and Adaptec.

### **SATA AHCI Enable**

Select Enable to enable the function of Serial ATA Advanced Host Interface. (Take caution when using this function. This feature is for advanced programmers only. The options are Enabled and **Disabled**.)

### **System Memory**

This display informs you how much system memory is detected by the BIOS.

### **Extended Memory**

This display informs you how much extended memory is detected by the BIOS.

## 4-4 Advanced Setup

Choose Advanced from the Phoenix BIOS Setup Utility main menu with the arrow keys. You should see the following display. The items with a triangle beside them have sub menus that can be accessed by highlighting the item and pressing <Enter>.

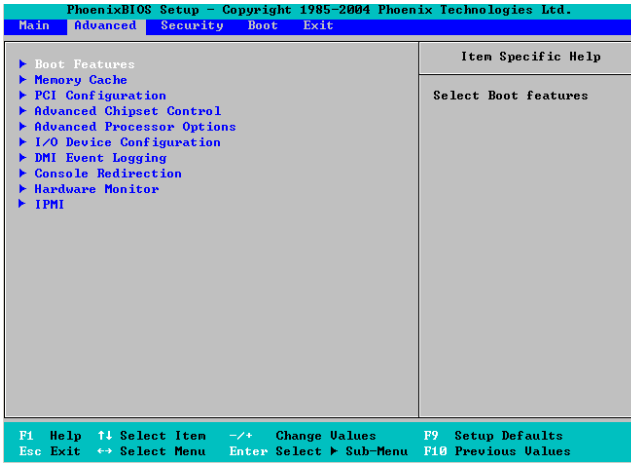

### ► Boot Features

Access the submenu to make changes to the following settings.

#### QuickBoot Mode

If enabled, this feature will speed up the POST (Power On Self Test) routine by skipping certain tests after the computer is turned on. The settings are **Enabled** and Disabled. If Disabled, the POST routine will run at normal speed.

#### QuietBoot Mode

This setting allows you to **Enable** or Disable the graphic logo screen during boot-up.

#### POST Errors

Set to **Enabled** to display POST Error Messages if an error occurs during bootup. If set to Disabled, the system will continue to boot without displaying any error message even when a boot error occurs.

#### ACPI Mode

Use the setting to determine if you want to employ ACPI (Advanced Configuration and Power Interface) power management on your system. The options are **Yes** and No.

## Power Button Behavior

If set to **Instant-Off**, the system will power off immediately as soon as the user hits the power button. If set to 4-sec., the system will power off when the user presses the power button for 4 seconds or longer. The options are instant-off and 4-sec override.

## Resume On Modem Ring

Select On to “wake your system up” when an incoming call is received by your modem. The options are On and **Off**.

## Power Loss Control

This setting allows you to choose how the system will react when power returns after an unexpected loss of power. The options are Stay Off, Power On, and **Last State**.

## Watch Dog

If enabled, this option will automatically reset the system if the system is not active for more than 5 minutes. The options are Enabled and **Disabled**.

## Summary Screen

This setting allows you to **Enable** or Disable the summary screen which displays the system configuration during bootup.

## ►Memory Cache

### Cache System BIOS Area

This setting allows you to designate a reserve area in the system memory to be used as a System BIOS buffer to allow the BIOS to write (cache) data into this reserved memory area. Select **Write Protect** to enable this function, and this area will be reserved for BIOS ROM access only. Select Uncached to disable this function and make this area available for other devices.

### Cache Video BIOS Area

This setting allows you to designate a reserve area in the system memory to be used as a Video BIOS buffer to allow the BIOS to write (cache) data into this reserved memory area. Select **Write Protect** to enable the function and this area will be reserved for Video BIOS ROM access only. Select Uncached to disable this function and make this area available for other devices.



### **Cache Base 0-512K**

If enabled, this feature will allow the data stored in the base memory area: block 0-512K to be cached (written) into a buffer, a storage area in the Static DROM (SDROM) or to be written into L1, L2 cache inside the CPU to speed up CPU operations. Select Uncached to disable this function. Select Write Through to allow data to be cached into the buffer and written into the system memory at the same time. Select Write Protect to prevent data from being written into the base memory area of Block 0-512K. Select Write Back to allow the CPU to write data back directly from the buffer without writing data to the System Memory for fast CPU data processing and operation. The options are Uncached, Write Through, Write Protect, and **Write Back**.

### **Cache Base 512K-640K**

If enabled, this feature will allow the data stored in the memory area: 512K-640K to be cached (written) into a buffer, a storage area in the Static DROM (SDROM) or written into L1, L2, L3 cache inside the CPU to speed up CPU operations. Select Uncached to disable this function. Select Write Through to allow data to be cached into the buffer and written into the system memory at the same time. Select Write Protect to prevent data from being written into the base memory area of Block 512-640K. Select Write Back to allow the CPU to write data back directly from the buffer without writing data to the System Memory for fast CPU data processing and operation. The options are Uncached, Write Through, Write Protect, and **Write Back**.

### **Cache Extended Memory**

If enabled, this feature will allow the data stored in the extended memory area to be cached (written) into a buffer, a storage area in the Static DROM (SDROM) or written into L1, L2, L3 cache inside the CPU to speed up CPU operations. Select Uncached to disable this function. Select Write Through to allow data to be cached into the buffer and written into the system memory at the same time. Select Write Protect to prevent data from being written into the extended memory area above 1MB. Select Write Back to allow the CPU to write data back directly from the buffer without writing data to the System Memory for fast CPU data processing and operation. The options are Uncached, Write Through, Write Protect, and **Write Back**.

### **Discrete MTRR Allocation**

If enabled, MTRRs (-Memory Type Range Registers) are configured as distinct, separate units and cannot be overlapped. If enabled, the user can achieve better graphic effects when using a Linux graphic driver that requires the write-combining configuration with 4GB or more memory. The options are Enabled and **Disabled**.

## ► PCI Configuration

Access the submenu to make changes to the following settings for PCI devices.

### **Onboard GLAN-1/Onboard GLAN-2 (Gigabit- LAN) OPROM Configure**

Select Enabled to allow the system to boot from the GLAN-1 connection or the GLAN-2 connection. The options are **Disabled** and Enabled.

### **Onboard Storage OPROM Configure**

Select Enabled to allow the system to boot from the onboard storage device. The options are Disabled and **Enabled**.

### **Reset Configuration Data**

If set to Yes, this setting clears the Extended System Configuration Data- (ESCD) area. The options are Yes and **No**.

### **► Slot1 PCI 33MHz, Slot2 PCI 33MHz, Slot3 PCI 33MHz, Slot4 PCI-Exp. x4, Slot5 PCI-Exp. x8, and Slot6 PCI-Exp. x8**

Access the submenu for each of the settings above to make changes to the following:

#### **Option ROM Scan**

When enabled, this setting will initialize the device expansion ROM. The options are **Enabled** and Disabled.

#### **Enable Master**

This setting allows you to enable the selected device as the PCI bus master. The options are Enabled and **Disabled**.

#### **Latency Timer**

This setting allows you to set the clock rate for Bus Master. A high-priority, high-throughput device may benefit from a greater clock rate. The options are **Default**, 0020h, 0040h, 0060h, 0080h, 00A0h, 00C0h, and 00E0h. For Unix, Novell and other Operating Systems, please select the option: other. If a drive fails after the installation of a new software, you might want to change this setting and try again. A different OS requires a different Bus Master clock rate.

### **Large Disk Access Mode**

This setting determines the size of hard drive disk to be accessed by the system. The options are **DOS** or Other (for Unix, Novelle NetWare and other operating systems).

---

## ► Advanced Chipset Control

Access the submenu to make changes to the following settings.



**Warning:** Take Caution when changing the Advanced settings. An incorrect setup, a very high DRAM frequency or an incorrect DRAM timing may cause the system become unstable. When this occurs, reset the setting to the default setting.

### Accelerate MRC

If Enabled, the BIOS will skip MRC calculation if there aren't any changes in DIMM population. The options are Enabled and **Disabled**.

### Clock Spectrum Feature

If Enabled, the BIOS will monitor the level of Electromagnetic Interference caused by the components and will attempt to decrease the interference whenever needed. The options are Enabled and **Disabled**.

### Crystal Beach Configure Enable

This feature cooperates with the Intel I/O AT (Acceleration Technology) to accelerate the performance of TOE devices. (**Note:** A TOE device is a specialized, dedicated processor that is installed on an add-on card or a network card to handle some or all packet processing of this add-on card. For this motherboard, the TOE device is built inside the ICH9R South Bridge chip.) The options are **Enabled** and Disabled.

### SERR Signal Condition

This setting specifies the ECC Error conditions that an SERR# is to be asserted. The options are None, **Single Bit**, Multiple Bit, and Both.

### 4GB PCI Hole Granularity

This feature allows you to select the granularity of PCI hole for PCI slots. If MTRRs are not enough, this option may be used to reduce MTRR occupation. The options are: **256 MB**, 512 MB, 1GB and 2GB.

### Channel 0 Rank Sparing/Channel 1 Rank Sparing

Select Enable to enable the function of memory sparing for Memory Bus Branch 0 or Branch 1. The options are Enabled and **Disabled**.

### Enhanced x8 Detection

Select **Enabled** to enable Enhanced x8 DRAM UC Error Detection. The options are Disabled and **Enabled**.

### Demand Scrubbing

Scrubbing is a process that allows the North Bridge to correct correctable memory errors found on a memory module. When the CPU or I/O issues a demand- read command, and the read data from memory turns out to be a correctable error, the error is corrected and sent to the requestor (the original source). Memory is updated as well. Select **Enabled** to use Demand Scrubbing for ECC memory correction.

### Patrol Scrubbing

Scrubbing is a process that allows the North Bridge to correct correctable memory errors detected on a memory module, and send the correction to the requestor (the original source). When this item is set to **Enabled**, the North Bridge will read and write back one cache line every 16K cycles, if there is no delay caused by internal processing. By using this method, roughly 64 GB of memory behind the North Bridge will be scrubbed every day. The options are **Enabled** and Disabled.

### Route Port 80h Cycles to

This feature allows the user to decide which bus to send debug information to. The options are Disabled, **PCI** and LPC.

### Enable Multi-Media Timer

Select Yes to activate a set of timers that are alternative to the traditional 8254 timers for the OS use. The options are Yes and **No**.

### USB Host Controller

Select Enabled to enable USB Host Controller 1. The options are **Enabled** and Disabled.

### Legacy USB Support

This setting allows you to enable support for Legacy USB devices. The settings are **Enabled** and Disabled.

### ►Advanced Processor Options

Access the submenu to make changes to the following settings.

#### CPU Speed

This is a display that indicates the speed of the installed processor.

#### Frequency Ratio (Available if supported by the CPU.)

The feature allows the user to set the internal frequency multiplier for the CPU. The options are: **Default**, x12, x13, x14, x15, x16, x17 and x18. **Note:** the options will vary depending on the type of CPU installed.

**Core-Multi-Processing (Available if supported by the CPU.)**

Set to Enabled to use a processor's Second Core and beyond. (Please refer to Intel's web site for more information.) The options are Disabled and **Enabled**.

**Machine Checking (Available when supported by the CPU.)**

Set to Enabled to activate the function of Machine Checking and allow the CPU to detect and report hardware (machine) errors via a set of model-specific registers (MSRs). The options are Disabled and **Enabled**.

**Thermal Management 2 (Available if supported by the CPU.)**

Set to **Enabled** to use Thermal Management 2 (TM2) which will lower CPU voltage and frequency when the CPU temperature reaches a predefined overheat threshold. Set to Disabled to use Thermal Manager 1 (TM1), allowing CPU clocking to be regulated via CPU Internal Clock modulation when the CPU temperature reaches the overheat threshold.

**C1 Enhanced Mode (Available if supported by the CPU.)**

Set to Enabled to enable Enhanced Halt State to lower CPU voltage/frequency to prevent overheat. The options are Enabled and **Disabled**. (**Note:** please refer to [Intel's web site for detailed information.](#))

**Execute Disable Bit (Available if supported by the CPU and the OS.)**

Set to **Enabled** to enable Execute Disable Bit and allow the processor to classify areas in memory where an application code can execute and where it cannot, and thus preventing a worm or a virus from inserting and creating a flood of codes to overwhelm the processor or damage the system during an attack. This feature is available when your OS and your CPU support the function of Execute Disable Bit. The options are Disabled and **Enabled**. **Note:** For more information regarding hardware/software support for this function, please refer to Intel's and Microsoft's web sites.

**Adjacent Cache Line Prefetch (Available when supported by the CPU.)**

The CPU fetches the cache line for 64 bytes if this option is set to Disabled. The CPU fetches both cache lines for 128 bytes as comprised if Enabled. The options are **Disabled** and Enabled.

**Hardware Prefetcher (Available when supported by the CPU.)**

Set to this option to **enabled** to enable the hardware components that are used in conjunction with software programs to prefetch data in order to shorten execution cycles and maximize data processing efficiency. The options are Disabled and **Enabled**.

### **Intel® Virtualization Technology (Available if supported by the CPU.)**

Select Enabled to use the feature of Virtualization Technology to allow one platform to run multiple operating systems and applications in independent partitions, creating multiple "virtual" systems in one physical computer. The options are Enabled and **Disabled**. **Note:** If there is any change to this setting, you will need to power off and restart the system for the change to take effect. Please refer to Intel's web site for detailed information.

### **Intel EIST Support (Available if supported by the CPU.)**

Select Enabled to use the Enhanced Intel SpeedStep Technology and allows the system to automatically adjust processor voltage and core frequency in an effort to reduce power consumption and heat dissipation. The options are Enabled and **Disabled**. Please refer to Intel's web site for detailed information.

## **► CPU Cache Control**

### **DCU Prefetch (Available when supported by the CPU.)**

The CPU fetches the cache line for 64 bytes if this option is set to Disabled. The CPU fetches both cache lines for 128 bytes as comprised if Enabled. The options are **Disabled** and Enabled.

### **IP Prefetch (Available when supported by the CPU.)**

Select Enabled to use CPU Cache Line IP Prefetch. The options are Disabled and **Enabled**.

### **Direct Cache Access (Available when supported by the CPU.)**

Set to Enable to route inbound network IO traffic directly into processor caches to reduce memory latency and improve network performance. The options are **Disabled** and Enabled.

## **► I/O Device Configuration**

Access the submenu to make changes to the following settings.

### **KBC Clock Input**

This setting allows you to select clock frequency for the keyboard clock. The options are 6MHz, 8MHz, **12MHz**, and 16MHz.

### **Serial Port A**

This setting allows you to decide how Serial Port A is controlled. The options are **Enabled** (user defined), Disabled, and Auto (BIOS- or OS- controlled).

### **Base I/O Address**

This setting allows you to select the base I/O address for Serial Port A. The options are **3F8**, 2F8, 3E8, and 2E8.

### **Interrupt**

This setting allows you to select the IRQ (interrupt request) for Serial Port A. The options are IRQ3 and **IRQ4**.

### **Serial Port B**

This setting allows you to decide how Serial Port B is controlled. The options are **Enabled** (user defined), Disabled, Auto (BIOS controlled) and OS Controlled.

### **Mode**

This setting allows you to set the type of devices to be connected to Serial Port B. The options are **Normal** and IR (for an infrared device) and ASK-IR.

### **Base I/O Address**

This setting allows you to select the base I/O address for Serial Port B. The options are 3F8, **2F8**, 3E8 and 2E8.

### **Interrupt**

This setting allows you to select the IRQ (interrupt request) for Serial Port B. The options are **IRQ3** and IRQ4.

### **Floppy Disk Controller**

This setting allows you to decide how Floppy Disk Controller is controlled. The options are **Enabled** (user defined), Disabled, and Auto (BIOS- and OS- controlled).

### **Base I/O Address**

This setting allows you to select the base I/O address for the Floppy disk drive. The options are **Primary** and Secondary.

### **► DMI Event Logging**

Access the submenu to make changes to the following settings.

#### **Event Log Validity**

This is a display to inform you of the event log validity. It is not a setting.

#### **Event Log Capacity**

This is a display to inform you of the event log capacity. It is not a setting.

#### **View DMI Event Log**

Highlight this item and press <Enter> to view the contents of the event log.

---

## Event Logging

This setting allows you to **Enable** or Disable event logging.

## ECC Event Logging

This setting allows you to **Enable** or Disable ECC event logging.

## Mark DMI Events as Read

Highlight this item and press <Enter> to mark the DMI events as read.

## Clear All DMI Event Logs

Select Yes and press <Enter> to clear all DMI event logs. The options are Yes and **No**.

## ► Console Redirection

Access the submenu to make changes to the following settings.

### COM Port Address

This item allows you to specify which COM port to direct the remote console to: On-board COM A or On-board COM B. This setting can also be **Disabled**. Note: The default is On-board COM B if IPMI is enabled.

### BAUD Rate

This item allows you to set the BAUD rate for the remote console. The options are 300, 1200, 2400, 9600, 19.2K, 38.4K, 57.6K, and **115.2K**.

### Console Type

This item allows you to choose Console Redirection type. The options are VT100, VT100/8bit, PC-ANSI/7bit, **PC ANSI**, VT100+, VT-UTF8 and ASCII.

### Flow Control

This item allows you to set the flow control for Console Redirection. The options are: None, XON/XOFF, and **CTS/RTS**.

### Console Connection

This item allows you to decide how Console Redirection is to be connected: either **Direct** or Via Modem.

### Continue CR after POST

This item allows you to decide whether you want to continue with Console Redirection after POST routines. The options are On and **Off**.



---

## ► Hardware Monitor

Highlight an item and hit <Enter> to see the status of each of the following items:

### CPU Overheat Alarm

This option allows the user to select the CPU Overheat Alarm setting which determines when the CPU OH alarm will be activated to provide warning of possible CPU overheat. Refer to the the next item, CPU Temperature for more information regarding PECI, DTS and other thermal features of this motherboard.

**Warning:** Any temperature that exceeds the CPU threshold temperature predefined by the CPU manufacturer may result in CPU overheat or system instability. When the CPU temperature reaches this predefined threshold, the CPU and system cooling fans will run at full speed.

The options are:

**The Default Alarm Setting:** Select this setting if you want the CPU overheat alarm (including the LED and the buzzer) to be triggered when the CPU temperature reaches about +5 PECI counts above the threshold temperature as predefined by the CPU manufacturer to give the CPU and system fans additional time needed for CPU and system cooling.

**The Early Alarm Setting:** Select this setting if you want the CPU overheat alarm (including the LED and the buzzer) to be triggered as soon as the CPU temperature reaches the CPU overheat threshold as predefined by the CPU manufacturer.

### CPU1 Temperature/CPU2 Temperature

The CPU Temperature feature will display the CPU temperature status as detected by the BIOS:

**Low** – This level is considered as the 'normal' operating state. The CPU temperature is well below the CPU 'Temperature Tolerance'. The motherboard fans and CPU will run normally as configured in the BIOS (Fan Speed Control).

User intervention: No action required.

**Medium** – The processor is running warmer. This is a 'precautionary' level and generally means that there may be factors contributing to this condition, but the CPU is still within its normal operating state and below the CPU 'Temperature Tolerance'. The motherboard fans and CPU will run normally as configured in the BIOS. The fans may adjust to a faster speed depending on the Fan Speed Control settings.

User intervention: No action is required. However, consider checking the CPU fans and the chassis ventilation for blockage.

High – The processor is running hot. This is a 'caution' level since the CPU's 'Temperature Tolerance' has been reached (or has been exceeded) and may activate an overheat alarm:

The Default Alarm – the Overheat LED and system buzzer will activate if the High condition continues for some time after it is reached. The CPU fan will run at full speed to bring the CPU temperature down. If the CPU temperature still increases even with the CPU fan running at full speed, the system buzzer will activate and the Overheat LED will turn on.

The Early Alarm – the Overheat LED and system buzzer will be activated exactly when the High level is reached. The CPU fan will run at full speed to bring the CPU temperature down.

Note: In both the alarms above, please take immediate action as shown below. See CPU Overheat Alarm to modify the above alarm settings.

User intervention: If the system buzzer and Overheat LED has activated, take action immediately by checking the system fans, chassis ventilation and room temperature to correct any problems. Note: the system may shut down if it continues for a long period to prevent damage to the CPU.

**Notes:** The CPU thermal technology that reports absolute temperatures (Celsius/Fahrenheit) has been upgraded to a more advanced feature by Intel in its newer processors. The basic concept is each CPU is embedded by unique temperature information that the motherboard can read. This 'Temperature Threshold' or 'Temperature Tolerance' has been assigned at the factory and is the baseline on which the motherboard takes action during different CPU temperature conditions (i.e., by increasing CPU Fan speed, triggering the Overheat Alarm, etc). Since CPUs can have different 'Temperature Tolerances', the installed CPU can now send information to the motherboard what its 'Temperature Tolerance' is, and not the other way around. This results in better CPU thermal management.

Supermicro has leveraged this feature by assigning a temperature status to certain thermal conditions in the processor (Low, Medium and High). This makes it easier for the user to understand the CPU's temperature status, rather than by just simply seeing a temperature reading (i.e., 25°C).

The information provided above is for your reference only. For more information on thermal management, please refer to Intel's Web site at [www.Intel.com](http://www.Intel.com).

## System Temperature

This feature displays the system's absolute temperature reading (i.e., 34°C).

## Fan1-Fan6 Speeds

If the feature of Auto Fan Control is enabled, the BIOS will automatically display the status of the fans indicated in this item.

## Fan Speed Control Modes

This feature allows the user to decide how the system controls the speeds of the onboard fans. The CPU temperature and the fan speed are correlative. When the CPU on-die temperature increases, the fan speed will also increase, and vice versa. If the option is set to 3-pin fan, the fan speed is controlled by voltage. If the option is set to 4-pin, the fan speed will be controlled by Pulse Width Modulation (PWM). Select 3-pin if your chassis came with 3-pin fan headers. Select 4-pin if your chassis came with 4-pin fan headers. Select Workstation if your system is used as a Workstation. Select Server if your system is used as a Server. Select Disable to disable the fan speed control function to allow the onboard fans to run at full speed (12V) at all times. The Options are: **1. Disable (Full Speed)**, 2. 3-pin (Server), 3. 3-pin (Workstation), 4. 4-pin (Server) and 5. 4-pin (Workstation).

## Voltage Monitoring

The following items will be monitored and displayed:

Vcore A, Vcore B, -12V, P1V5, +3.3V, 5Vsb, 5VDD, P\_VTT, Vbat

**Note:** In the Windows OS environment, the Supero Doctor III settings take precedence over the BIOS settings. When first installed, Supero Doctor III adopts the temperature threshold settings previously set in the BIOS. Any subsequent changes to these thresholds must be made within Supero Doctor, since the SD III settings override the BIOS settings. For the Windows OS to adopt the BIOS temperature threshold settings, please change the SDIII settings to be the same as those set in the BIOS.

► **IPMI (The option is available only when an IPMI card is installed in the system.)**

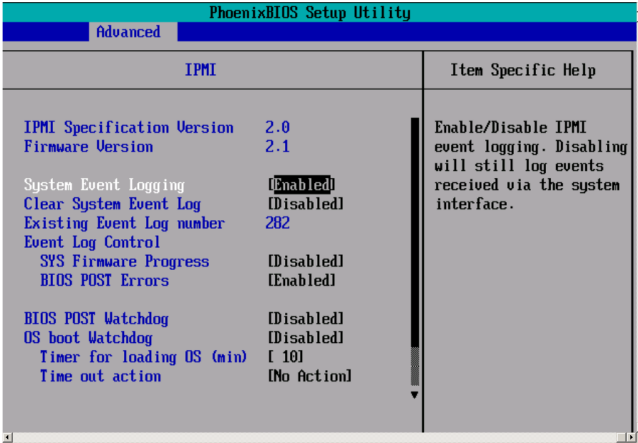

**IPMI Specification Version:** This item displays the current IPMI Version.

**BMC Hardware/Firmware Version:** This item displays the current Firmware Version.

**System Event Logging**

Select Enabled to enable IPMI Event Logging. When this function is set to Disabled, the system will continue to log events received via system interface. The options are **Enabled** and Disabled.

**Clear System Event Logging**

Enabling this function to force the BIOS to clear the system event logs during the next cold boot. The options are Enabled and **Disabled**.

**Existing Event Log Number**

This item displays the number of the existing event log.

**Event Log Control**

**System Firmware Progress**

Enabling this function to log POST progress. The options are Enabled and **Disabled**.

**BIOS POST Errors**

Enabling this function to log POST errors. The options are **Enabled** and Disabled.

## BIOS POST Watch Dog

Set to Enabled to enable POST Watch Dog. The options are Enabled and **Disabled**.

## OS Boot Watch Dog

Set to Enabled to enable OS Boot Watch Dog. The options are Enabled and **Disabled**.

## Timer for Loading OS (Minutes)

This feature allows the user to set the time value (in minutes) for the previous item: OS Boot Watch Dog by keying-in a desired number in the blank. The default setting is 10 (minutes.) (Please ignore this option when OS Boot Watch Dog is set to "Disabled".)

## Time Out Action

This feature allows the user to determine what action to take in an event of a system boot failure. The options are **No Action**, Reset, Power Off and Power Cycles.

## ► System Event Log/System Event Log (List Mode)

These options display the System Event (SEL) Log and System Event (SEL) Log in List Mode. Items include: SEL (System Event Log) Entry Number, SEL Record ID, SEL Record Type, Time Stamp, Generator ID, SEL Message Revision, Sensor Type, Sensor Number, SEL Event Type, Event Description, and SEL Event Data.

```

Console Redirection Keyboard View Macros Help
System Event Log

SEL Entry Number = 1
SEL Record ID = 0001
SEL Record Type = 02 - System Event Record
Timestamp = 02.10.2006 17:11:23
Generator Id = 20 00
SEL Message Rev = 04
Sensor Type = 02 - Voltage
Sensor Number = 0A - -12V
SEL Event Type = 01 - Threshold
Event Description = Lower Non-critical Going Low, Assertion
SEL Event Data = 50 06 0E

F1 Help ↑ Select Item ~/+ Change Values F9 Setup Defaults
Esc Exit ← Select Menu Enter Select ► Sub-Menu F10 Save and Exit

```

## ► Realtime Sensor Data

This feature display information from motherboard sensors, such as temperatures, fan speeds and voltages of various components.

Realtime Sensor Data					
Sensor Type	Sensor Name	Sensor Data	Sensor Units	Lower Limit	Upper Limit
Temp	CPU1 CoreA	48.00	degrees C	0.00	75.00
	CPU1 CoreB	54.00	degrees C	0.00	75.00
	CPU2 CoreA	47.00	degrees C	0.00	75.00
	CPU2 CoreB	46.00	degrees C	0.00	75.00
	System	44.00	degrees C	0.00	75.00
Voltage	CPU1 Core	1.13	Volts	0.97	1.47
	CPU2 Core	1.16	Volts	0.97	1.47
	3.3V	3.30	Volts	2.95	3.62

F1	Help	↑	Select Item	-/+	Change Values	F9	Setup Defaults
Esc	Exit	←	Select Menu	Enter	Select ▶ Sub-Menu	F10	Save and Exit

## ► IPMI LAN Configuration

### VLAN Tagging

Select Enabled to enable Virtual LAN(s) for IPMI connections and allow the user to configure VLAN settings. The options are Enabled and **Disabled**.

### VLAN ID

This item allows the user to change the VLAN ID. The default setting is **1h**.

### IP Address Source

This item allows the user to select the IP address source for the connection. The options are **DHCP** and Static. If Static is selected, the following items need to be set manually. Selecting DHCP will allow the network's DHCP server (if your network has one) to assign values to these items automatically:

IP Address, IP Subnet Mask, Default Gateway

### MAC Address

This is the system's hardware address. This do not need to be set or changed in most cases.

### Update LAN Settings

Select Yes to allow BIOS update LAN setting. The options are Yes and **No**.

## 4-5 Security

Choose Security from the Phoenix BIOS Setup Utility main menu with the arrow keys. You should see the following display. Security setting options are displayed by highlighting the setting using the arrow keys and pressing <Enter>. All Security BIOS settings are described in this section.

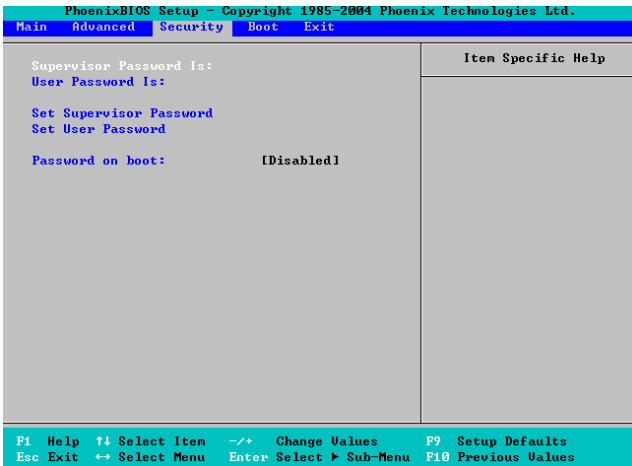

### Supervisor Password Is:

This indicates if a supervisor password has been entered for the system. Clear means such a password has not been used and Set means a supervisor password has been entered for the system.

### User Password Is:

This indicates if a user password has been entered for the system. Clear means such a password has not been used and Set means a user password has been entered for the system.

### Set Supervisor Password

When the item Set Supervisor Password is highlighted, hit the <Enter> key. When prompted, enter the Supervisor's password in the dialogue box to set or to change supervisor's password, which allows access to the BIOS.

### Set User Password

When the item Set User Password is highlighted, hit the <Enter> key. When prompted, enter the user's password in the dialogue box to set or to change the user's password, which allows access to the system at boot-up.

## Password on Boot

This setting allows you to determine if a password is required for a user to enter the system at bootup. The options are Enabled (password required) and **Disabled** (a password not required).

## 4-6 Boot

Choose Boot from the Phoenix BIOS Setup Utility main menu with the arrow keys. You should see the following display. See details on how to change the order and specs of boot devices in the Item Specific Help window. All Boot BIOS settings are described in this section.

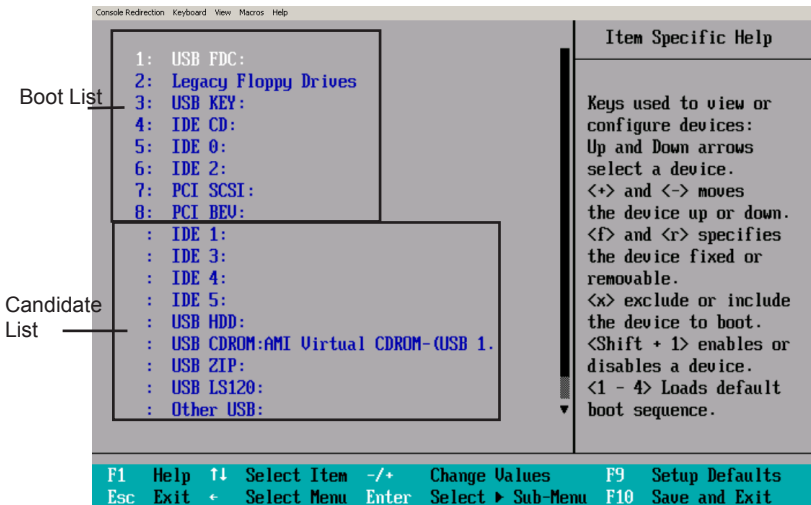

### Boot Priority Order/Excluded from Boot Orders

The devices included in the boot list section (above) are bootable devices listed in the sequence of boot order as specified. The boot functions for the devices included in the candidate list (above) are currently disabled. Use a <+> key or a <-> key to move the device up or down. Use the <f> key or the <r> key to specify the type of an USB device, either fixed or removable. You can select one item from the boot list and hit the <x> key to remove it from the list of bootable devices (to make its resource available for other bootable devices). Subsequently, you can select an item from the candidate list and hit the <x> key to remove it from the candidate list and put it in the boot list. This item will then become a bootable device. See details on how to change the priority of boot order of devices in the "Item Specific Help" window.



## 4-7 Exit

Choose Exit from the Phoenix BIOS Setup Utility main menu with the arrow keys. You should see the following display. All Exit BIOS settings are described in this section.

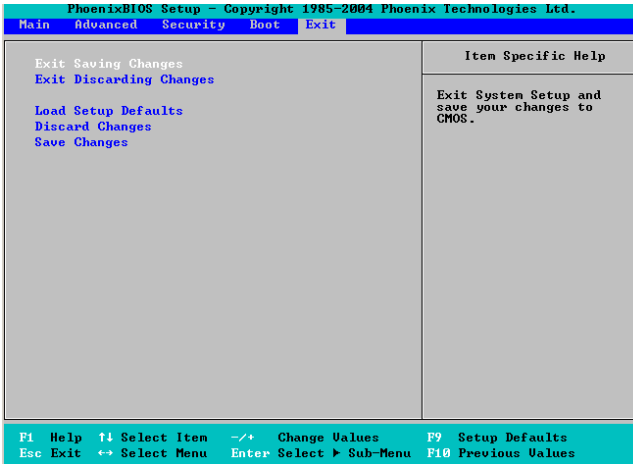

### Exit Saving Changes

Highlight this item and press <Enter> to save any changes you have made and to exit the BIOS Setup utility.

### Exit Discarding Changes

Highlight this item and press <Enter> to exit the BIOS Setup utility without saving any changes you may have made.

### Load Setup Defaults

Highlight this item and press <Enter> to load the default settings for all items in the BIOS Setup. These are the safest settings to use.

### Discard Changes

Highlight this item and press <Enter> to discard (cancel) any changes you have made. You will remain in the Setup utility.

### Save Changes

Highlight this item and press <Enter> to save any changes you made. You will remain in the Setup utility.

## Appendix A

### POST Error Beep Codes

This section lists POST (Power On Self Test) error beep codes for the Phoenix BIOS. POST error beep codes are divided into two categories: recoverable and terminal. This section lists Beep Codes for recoverable POST errors.

#### Recoverable POST Error Beep Codes

When a recoverable type of error occurs during POST, BIOS will display a POST code that describes the problem. BIOS may also issue one of the following beep codes:

- 1 long and two short beeps - video configuration error
- 1 repetitive long beep - no memory detected
- 1 continuous beep with the front panel Overheat LED on - system overheat

## Notes

## Appendix B

### Installing the Windows OS

After all hardware components have been installed, you must first configure Intel South Bridge RAID Settings before you install the Windows OS and other software drivers. To configure RAID settings, please refer to RAID Configuration User Guides posted on our website at [www.supermicro.com/support/manuals](http://www.supermicro.com/support/manuals).

#### **B-1 Installing the Windows XP/2000/2003 OS for Systems with RAID Functions**

1. Insert Microsoft's Windows XP/2000/2003 Setup CD in the CD Driver, and the system will start booting up from CD.
2. Press the <F6> key when the message-" Press F6 if you need to install a third party SCSI or RAID driver" displays.
3. When the Windows XP/2000/2003 Setup screen appears, press "S" to specify additional device(s).
4. Insert the driver diskette-"Intel AA RAID XP/2000/2003 Driver for ICH9R" into Drive A: and press the <Enter> key.
5. Choose the Intel(R) ICH9R *SATA RAID Controller* from the list indicated in the XP/2000/2003 Setup Screen, and press the <Enter> key.
6. Press the <Enter> key to continue the installation process. (If you need to specify any additional devices to be installed, do it at this time.) Once all devices are specified, press the <Enter> key to continue with the installation.
7. From the Windows XP/2000/2003 Setup screen, press the <Enter> key. The XP/2000/2003 Setup will automatically load all device files and then, continue the Windows XP/2000/2003 installation.
8. After the Windows XP/2000/2003 OS Installation is completed, the system will automatically reboot.

## **B-2 Installing the Windows XP/2000/2003 OS for Systems without RAID Functions**

1. Insert Microsoft's Windows XP/2000/2003 Setup CD in the CD Driver, and the system will start booting up from CD.
2. Continue with the OS installation. The Windows OS Setup screen will display.
3. From the Windows XP/2000/2003 Setup screen, press the <Enter> key. The XP/2000/2003 Setup will automatically load all device files and then continue with the Windows XP/2000/2003 installation.
4. After the Windows XP/2000/2003 OS Installation is completed, the system will automatically reboot.
5. Insert the Supermicro Setup CD that came with your motherboard into the CD Drive during system boot, and the main screen will display.

## Appendix C Software Installation

### C-1 Installing other Drivers and the OS

After you've installed the Windows Operating System, a screen as shown below will appear. You are ready to install software programs and drivers that have not yet been installed. To install these software programs and drivers, click the icons to the right of these items.

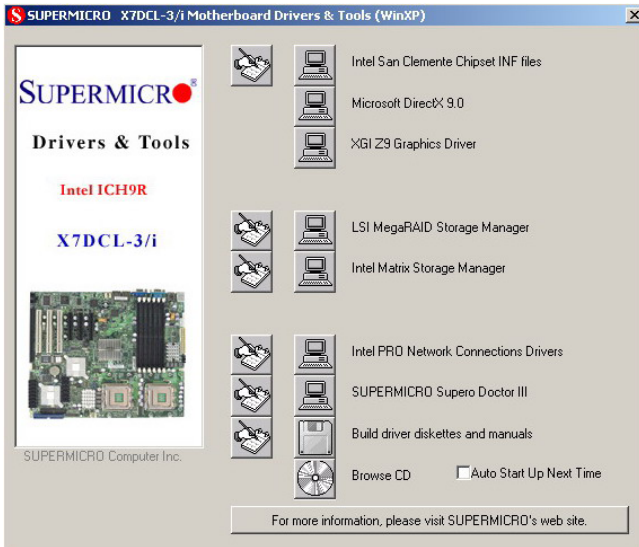

#### Driver/Tool Installation Display Screen

##### Notes:

1. Click the icons showing a hand writing on the paper to view the readme files for each item. Click a computer icon on the right of an item (from top to the bottom) one at a time. **After installing each item, you must reboot the system before proceeding with the next item on the list.**
2. The X7DCL-3 supports SAS RAID features. To configure the LSI SAS HostRAID, please refer to the LSI folder for the LSI SAS HostRAID Utility and documentation. The LSI folder is included in the CD-ROM that came with your motherboard.

## C-2 Configuring Supero Doctor III

The Supero Doctor III program is a Web-based management tool that supports remote management capability. It includes Remote and Local Management tools. The local management is called the SD III Client. The Supero Doctor III program included on the CDROM that came with your motherboard allows you to monitor the environment and operations of your system. Supero Doctor III displays crucial system information such as CPU temperatures, system voltages and fan status. See the Figure below for a display of the Supero Doctor III interface.

**Note 1:** Both default username and password are **ADMIN**.

**Note 2:** In the Windows OS environment, the Supero Doctor III settings take precedence over the BIOS settings. When first installed, Supero Doctor III adopts the temperature threshold settings previously set in the BIOS. Any subsequent changes to these thresholds must be made within Supero Doctor, since the SD III settings override the BIOS settings. For the Windows OS to adopt the BIOS temperature threshold settings, please change the SDIII settings to be the same as those set in the BIOS.

### Supero Doctor III Interface Display Screen-I (Health Information)



**Supero Doctor III Interface Display Screen-II (Remote Control)**

**Note:** SD III Software can be downloaded from our Web site at: [ftp://ftp.supermicro.com/utility/Supero\\_Doctor\\_III/](ftp://ftp.supermicro.com/utility/Supero_Doctor_III/). You can also download SDIII User's Guide at: <http://www.supermicro.com/PRODUCT/Manuals/SDIII/UserGuide.pdf>. For the Linux OS, we will still recommend that you use Supero Doctor II.



## Notes

(Disclaimer Continued)

The products sold by Supermicro are not intended for and will not be used in life support systems, medical equipment, nuclear facilities or systems, aircraft, aircraft devices, aircraft/emergency communication devices or other critical systems whose failure to perform be reasonably expected to result in significant injury or loss of life or catastrophic property damage. Accordingly, Supermicro disclaims any and all liability, and should buyer use or sell such products for use in such ultra-hazardous applications, it does so entirely at its own risk. Furthermore, buyer agrees to fully indemnify, defend and hold Supermicro harmless for and against any and all claims, demands, actions, litigation, and proceedings of any kind arising out of or related to such ultra-hazardous use or sale.