

SUPER[®]●

SUPER[®]● X7DBU
SUPER[®]● X7DGU

USER'S MANUAL

Revision 1.0c

The information in this User's Manual has been carefully reviewed and is believed to be accurate. The vendor assumes no responsibility for any inaccuracies that may be contained in this document, makes no commitment to update or to keep current the information in this manual, or to notify any person or organization of the updates. **Please Note: For the most up-to-date version of this manual, please see our web site at www.supermicro.com.**

Super Micro Computer, Inc. ("Supermicro") reserves the right to make changes to the product described in this manual at any time and without notice. This product, including software, if any, and documentation may not, in whole or in part, be copied, photocopied, reproduced, translated or reduced to any medium or machine without prior written consent.

IN NO EVENT WILL SUPER MICRO COMPUTER, INC. BE LIABLE FOR DIRECT, INDIRECT, SPECIAL, INCIDENTAL, SPECULATIVE OR CONSEQUENTIAL DAMAGES ARISING FROM THE USE OR INABILITY TO USE THIS PRODUCT OR DOCUMENTATION, EVEN IF ADVISED OF THE POSSIBILITY OF SUCH DAMAGES. IN PARTICULAR, SUPER MICRO COMPUTER, INC. SHALL NOT HAVE LIABILITY FOR ANY HARDWARE, SOFTWARE, OR DATA STORED OR USED WITH THE PRODUCT, INCLUDING THE COSTS OF REPAIRING, REPLACING, INTEGRATING, INSTALLING OR RECOVERING SUCH HARDWARE, SOFTWARE, OR DATA.

Any disputes arising between manufacturer and customer shall be governed by the laws of Santa Clara County in the State of California, USA. The State of California, County of Santa Clara shall be the exclusive venue for the resolution of any such disputes. Super Micro's total liability for all claims will not exceed the price paid for the hardware product.

FCC Statement: This equipment has been tested and found to comply with the limits for a Class A digital device pursuant to Part 15 of the FCC Rules. These limits are designed to provide reasonable protection against harmful interference when the equipment is operated in a commercial environment. This equipment generates, uses, and can radiate radio frequency energy and, if not installed and used in accordance with the manufacturer's instruction manual, may cause harmful interference with radio communications. Operation of this equipment in a residential area is likely to cause harmful interference, in which case you will be required to correct the interference at your own expense.

California Best Management Practices Regulations for Perchlorate Materials: This Perchlorate warning applies only to products containing CR (Manganese Dioxide) Lithium coin cells. "Perchlorate Material-special handling may apply. See www.dtsc.ca.gov/hazardouswaste/perchlorate"

WARNING: Handling of lead solder materials used in this product may expose you to lead, a chemical known to the State of California to cause birth defects and other reproductive harm.

Manual Revision 1.0c

Release Date: June 16, 2009

Unless you request and receive written permission from Super Micro Computer, Inc., you may not copy any part of this document.

Information in this document is subject to change without notice. Other products and companies referred to herein are trademarks or registered trademarks of their respective companies or mark holders.

Copyright © 2009 by Super Micro Computer, Inc.
All rights reserved.

Printed in the United States of America

Preface

About This Manual

This manual is written for system integrators, PC technicians and knowledgeable PC users. It provides information for the installation and use of the **SUPER** X7DBU/X7DGU motherboard. The **SUPER** X7DBU/X7DGU supports dual Intel XEON 64-bit Quad-core/Dual-core processors at a front side bus speed of 1.333 GHz/1.066 GHz/667 MHz. With dual 64-bit Xeon Quad-core/Dual-core processors, the 5000 chipset, and 8 DDR2 FBD 667/533 memory modules built-in, the X7DBU/X7DGU offers substantial functionality and performance enhancements to the motherboards based on the Core microarchitecture while remaining compatible with the 32-bit based software. The features include Virtualization Technology, Execution Trace Cache, Thermal Monitor 2 (TM2), Enhanced Intel SpeedStep technology, Advanced Dynamic Execution, Advanced Transfer Cache, Streaming SIMD Extensions 3 (SSE3) and Extended Memory 64 Technology (EM64T). These features allow the motherboard to operate at much higher speeds with better power management in much safer environments than the traditional motherboards. The X7DBU/X7DGU is ideal for high performance dual processor (DP) enterprise server environments. This product is intended to be professionally installed.

Manual Organization

Chapter 1 describes the features, specifications and performance of the mainboard and provides detailed information about the chipset.

Chapter 2 provides hardware installation instructions. Read this chapter when installing the processor, memory modules and other hardware components into the system. If you encounter any problems, see **Chapter 3**, which describes troubleshooting procedures for video, memory and system setup stored in the CMOS.

Chapter 4 includes an introduction to the BIOS and provides detailed information on the CMOS Setup utility.

Appendix A provides BIOS POST Error Beep Codes. **Appendix B**, and **Appendix C** list OS and Software Installation Instructions.

Conventions Used in the Manual:

Special attention should be given to the following symbols for proper installation and to prevent damage done to the components or injury to yourself:



Warning: Important information given to ensure proper system installation or to prevent damage to the components.

Note: Additional Information given to differentiate various models or to ensure correct system setup.

Table of Contents

Preface

About This Manual	iii
Manual Organization	iii
Conventions Used in the Manual.....	iii

Chapter 1: Introduction

1-1 Overview	1-1
Checklist	1-1
Contacting Supermicro	1-2
SUPER [®] X7DBU/X7DGU Image	1-3
SUPER [®] X7DBU/X7DGU Layout	1-4
Quick Reference	1-5
Motherboard Features.....	1-6
Intel 5000 Chipset: System Block Diagram	1-8
1-2 Chipset Overview	1-9
1-3 Special Features	1-10
1-4 PC Health Monitoring	1-10
1-5 ACPI Features	1-11
1-6 Power Supply	1-12
1-7 Super I/O	1-13

Chapter 2: Installation

2-1 Static-Sensitive Devices	2-1
Precautions.....	2-1
Unpacking	2-1
2-2 Processor and Heatsink Installation	2-2
2-3 Installing DIMMs	2-6
2-4 Control Panel Connectors and IO Ports	2-8
A. Back Panel Connectors/IO Ports.....	2-8
B. Front Control Panel.....	2-9
C. Front Control Panel Pin Definitions	2-10
NMI Button	2-10
Power LED	2-10
HDD LED/FP UID Switch.....	2-11
NIC1/NIC2 LEDs	2-11
Overheat/Fan Fail LED/PWR Fail/FP UID LED	2-12
Power Fail LED	2-12
Reset Button	2-13

Power Button	2-13
2-5 Connecting Cables	2-14
ATX Power Connector	2-14
Processor Power Connector	2-14
Universal Serial Bus	2-15
Chassis Intrusion	2-15
Fan Headers	2-16
Keylock	2-16
ATX PS/2 Keyboard and Mouse Ports	2-17
Serial Ports	2-17
Wake-On-Ring	2-18
Wake-On-LAN	2-18
GLAN 1/2 (Ethernet Ports)	2-19
Speaker/Power LED Header	2-19
Overheat LED/Fan Fail	2-20
SMB Connector	2-20
SMB Power Connector	2-21
VGA Connector	2-21
Unit Identification Switches	2-22
SGPIO Headers	2-22
2-6 Jumper Settings	2-23
Explanation of Jumpers	2-23
GLAN Enable/Disable	2-23
Clear CMOS	2-24
Watch Dog	2-24
VGA Enable/Disable	2-25
I ² C Bus to PCI Slots	2-26
2-7 Onboard Indicators	2-27
GLAN LEDs	2-27
Onboard Power LED	2-28
2-8 Floppy, Hard Disk Drive, SIMSO-DIMM IPMI and SCSI Connections	2-29
Floppy Connector	2-29
SIMSO Slot	2-30
IDE Connectors	2-31
SXB1/SXB2 Slots	2-32
 Chapter 3: Troubleshooting	
3-1 Troubleshooting Procedures	3-1
Before Power On	3-1

No Power.....	3-1
No Video	3-1
Losing the System's Setup Configuration	3-1
Memory Errors.....	3-2
3-2 Technical Support Procedures	3-2
3-3 Frequently Asked Questions	3-3
3-4 Returning Merchandise for Service	3-4

Chapter 4: BIOS

4-1 Introduction	4-1
4-2 Running Setup	4-2
4-3 Main BIOS Setup	4-3
4-4 Advanced Setup	4-6
4-5 Security Setup	4-23
4-6 Boot Setup.....	4-24
4-7 Exit.....	4-25

Appendices:

Appendix A: BIOS POST Beep Codes	A-1
Appendix B: Installing the Windows OS	B-1
Appendix C: Installing Other Software Programs and Drivers.....	C-1

Chapter 1

Introduction

1-1 Overview

Checklist

Congratulations on purchasing your computer motherboard from an acknowledged leader in the industry. Supermicro boards are designed with the utmost attention to detail to provide you with the highest standards in quality and performance. Check that the following items have all been included with your motherboard. If anything listed here is damaged or missing, contact your retailer.

All the following items are included in the Retail Box.

One (1) Supermicro Mainboard

One (1) ribbon cable for IDE devices (CBL-036L-02)

One (1) floppy ribbon cable (CBL-022)

One (1) Supermicro CD containing drivers and utilities

One (1) User's/BIOS Manual

Contacting Supermicro

Headquarters

Address: Super Micro Computer, Inc.
980 Rock Ave.
San Jose, CA 95131 U.S.A.

Tel: +1 (408) 503-8000

Fax: +1 (408) 503-8008

Email: marketing@supermicro.com (General Information)
support@supermicro.com (Technical Support)

Web Site: www.supermicro.com

Europe

Address: Super Micro Computer B.V.
Het Sterrenbeeld 28, 5215 ML
's-Hertogenbosch, The Netherlands

Tel: +31 (0) 73-6400390

Fax: +31 (0) 73-6416525

Email: sales@supermicro.nl (General Information)
support@supermicro.nl (Technical Support)
rma@supermicro.nl (Customer Support)

Asia-Pacific

Address: Super Micro Computer, Taiwan
4F, No. 232-1 Liancheng Road
Chung-Ho 235, Taipei Hsien, Taiwan, R.O.C.

Tel: +886-(2) 8226-3990

Fax: +886-(2) 8226-3991

Web Site: www.supermicro.com.tw

Technical Support:

Email: support@supermicro.com.tw

Tel: 886-2-8228-1366, ext.132 or 139

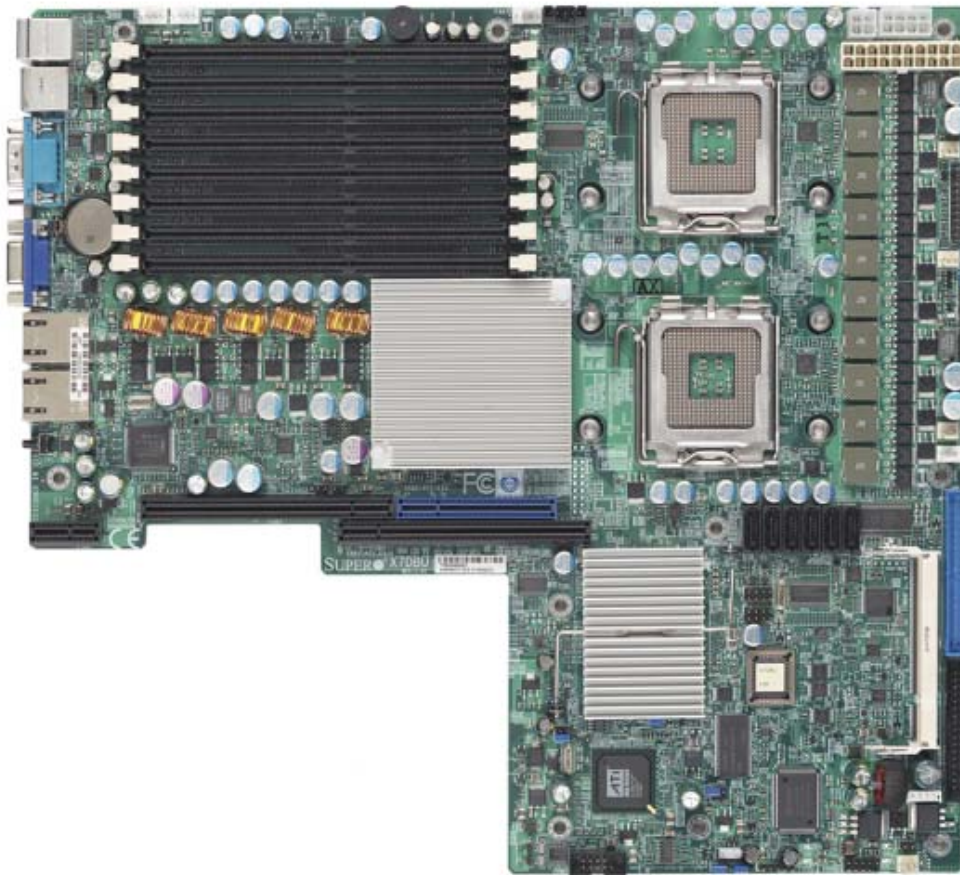
SUPER X7DBU/X7DGU Image

Note 1: The drawings and pictures shown in this manual were based on PCB Revision 1.02, the latest revision available at the time of publishing of the manual. The motherboard you've received may or may not look exactly the same as the graphics shown in the manual.

Note 2: X7DGU is for OEM only.

SUPER X7DBU/X7DGU Motherboard Layout

(not drawn to scale)

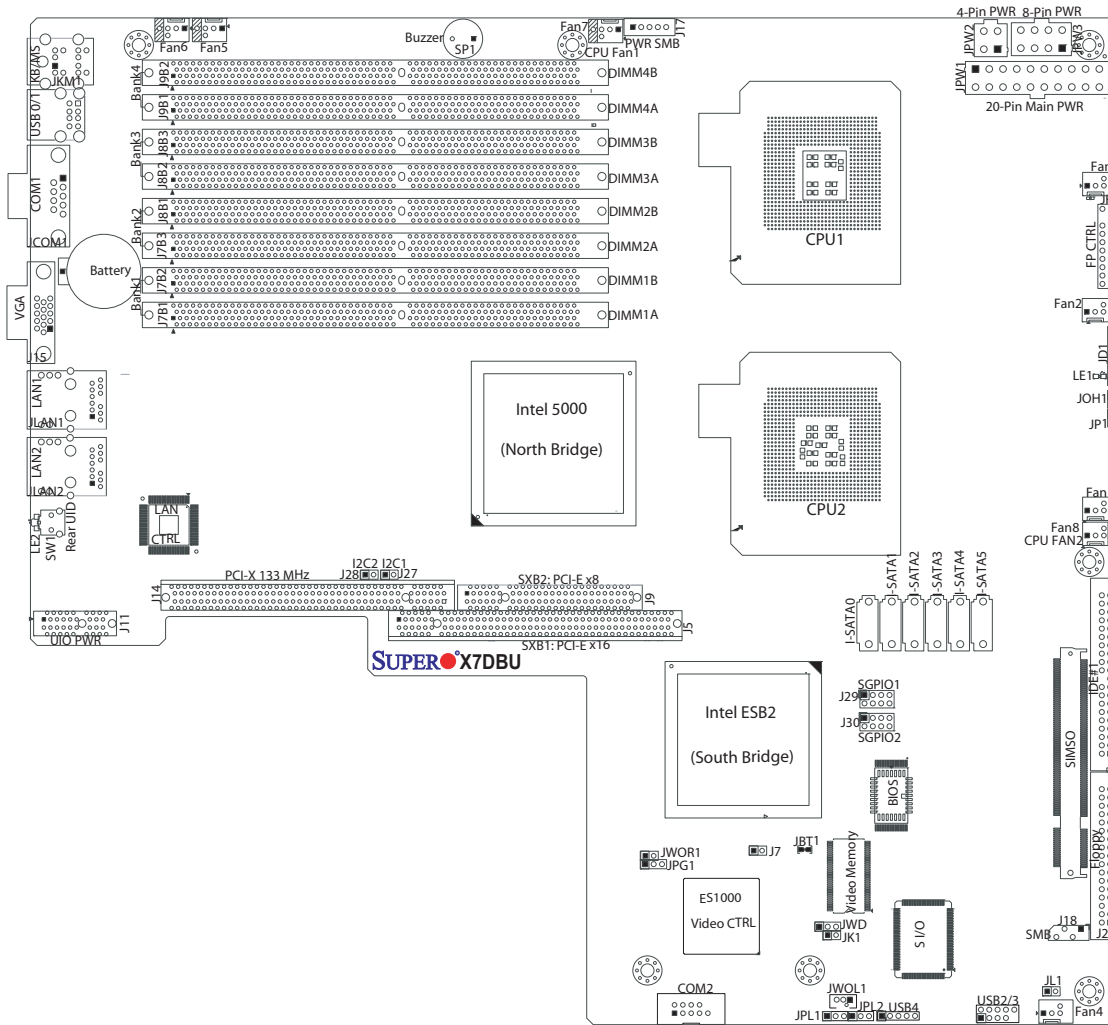

Notes:

1. Jumpers not indicated are for test purposes only.
2. See Chapter 2 for detailed information on jumpers, I/O ports and JF1 front panel connections.
3. "■", "▲" and "▼" indicate Pin 1 locations.
4. The X7DBU uses the Intel 5000P chip and the X7DGU uses the Intel 5000X chip.
5. The X7DGU model is for OEM only.
6. When LE1 is on, make sure to remove the power cable before removing or installing components.
7. All SXB1 (J5), SXB2 (J9) and PCI-X 133 MHz (J14) slots are designed to be used with riser cards. When used with riser cards, the left IO slot (SXB1) supports one PCI-E x8 and one UIO devices, while the right IO slots (SXB2, PC1-X: J14) can support a PCI-E x8 or a PCI-X 133 MHz device.

Quick Reference (X7DBU/X7DGU)		
Jumper	Description	Default Setting
JBT1	CMOS Clear	See Chapter 2
JI ² C1 (J27)	SMBBus to PCI-X/PCI-E Slots	Off (Disabled)
JI ² C2 (J28)	SMBBus to PCI-X/PCI-E Slots	Off (Disabled)
JPG1	VGA Enable	Pins 1-2 (Enabled)
JPL1/JPL2	GLAN1/GLAN2 Enable	Pins 1-2 (Enabled)
JWD	Watch Dog	Pins 1-2 (Reset)
Connector	Description	
ATX PWR (JPW1)	Primary 20-Pin ATX PWR Connector	
Aux. PWR/CPU PWR	+12V 4-pin PWR (JWP2)/+12V 8-pin PWR(JPW3)	
UIO PWR (J11)	Power Connector for the Universal IO slots	
Buzzer (SP1)	Internal Speaker	
Chassis Intrusion (JL1)	Chassis Intrusion Header	
COM1/COM2	COM1(JCOM1)/COM2(JCOM2) Serial Port Connectors	
DIMM#1A-DIMM#4B	Memory DDR2 Fully Buffered (FBD) Slots	
FAN 1-8	Fans 1-6 (System Fans), Fans 7-8: CPU Fans (Fans 1-4: 3-pin Fans, Fans 5-8: 4-pin Fans)	
Floppy (J22)	Floppy Disk Drive Connector	
FP CTRL (JF1)	Front Control Panel Connector	
GLAN 1/2 (JLAN1/2)	G-bit Ethernet Ports	
IDE#1 (JIDE1)	IDE#1 Hard Drive	
Keylock (JK1)	Keylock Header	
OH LED (JOH1)	Overheat LED Indicator	
PCI-X (J14)	PCI-X 133MHz Slot (*See Note 7 on Page 1-4)	
PWR LED/SPKR (JD1)	PWR LED(pins1-3)/Speaker Header (pins 4-7)	
PWR SMB (J17)	Power System Management (I ² C) Header	
SATA0-SATA5	Intel SATA 0-5 Connectors	
SGPIO1/2 (J29, J30)	Serial General Purpose Input/Output Headers	
SIMSO	SIM SO-DIMM IPMI Slot	
SMB (J18)	System Management Bus Header	
SXB1 (J5)	PCI-Exp x16 slot (*See Note 7 on Page 1-4)	
SXB2 (J9)	PCI-Exp x8 slot (*See Note 7 on Page 1-4)	
UID (SW1)	Rear Unit Identification Switch	
USB 0/1	Back Panel USB Ports 0/1	
USB 2/3,USB4	Front Panel USB Connectors 2/3, FP USB Connector 4	
VGA (J15) (Note)	VGA Connector	
WOL (JWOL1)	Wake-on-LAN Header	
WOR (JWOR1)	Wake-on-Ring Header	
LE Indicators	Description	
LE1	Onboard Power LED Indicator	
LE2	Unit Identification (UID) LED Indicator	
Note: The X7DGU model is for OEM only.		

Motherboard Features

CPU

- Dual Intel® 64-bit Xeon LGA 771 Quad-core/Dual-core processors at a front side bus speed of 1.333 GHz/1.066 GHz/667 MHz

Memory

- 8 240-pin DIMM sockets with support up to 32 GB DDR2 Fully Buffered (FBD) ECC 667/533 Memory (*See Section 2-3 in Chapter 2 for DIMM Slot Population.)

Chipset

***X7DBU:**

- Intel 5000P chipset, including: the 5000P Memory Control Hub (MCH) and the Enterprise South Bridge 2 (ESB2).

***X7DGU:**

- Intel 5000X chipset, including: the 5000X Memory Control Hub (MCH) and the Enterprise South Bridge 2 (ESB2).

Expansion Slots

***X7DBU:**

- Two PCI-Express slots (SXB1: PCI-E x8 + x8 Single Slot, SXB2: PCI-E x8)
- One 64-bit PCI-X 133 MHz slot (J14)

***X7DGU (for OEM only):**

- Two PCI-Express slots (SXB1: PCI-E x16, SXB2: PCI-E x8)
- One 64-bit PCI-X 133 MHz slot (J14)

BIOS

- 8 Mb Phoenix® Flash ROM
- DMI 2.3, PCI 2.2, ACPI 1.0/2.0, Plug and Play (PnP), SMBIOS 2.3 and USB Keyboard support

PC Health Monitoring

- Onboard voltage monitors for CPU cores, chipset voltage, memory voltage, HT voltage, +1.8V, +3.3V, +5V, +12V, -12V, +3.3V Standby, +5V standby and VBAT
- Fan status monitor with firmware control
- CPU/chassis temperature monitors
- Low noise fan speed control

- Platform Environment Control Interface (PECI) ready
- I²C temperature sensing logic
- Thermal Monitor 2 (TM2) support
- CPU slow-down on temperature overheat
- CPU thermal trip support for processor protection
- Power-up mode control for recovery from AC power loss
- Pulse Width Modulation Fan Control (Fans 5-8)
- Auto-switching voltage regulator for CPU cores
- System overheat/Fan Fail LED Indicator and control
- Chassis intrusion detection
- System resource alert via Supero Doctor III

ACPI Features

- Slow blinking LED for suspend state indicator
- Main switch override mechanism
- ACPI Power Management
- Power-on mode for power recovery

Onboard I/O

- Six SATA ports (supporting RAID0, RAID1, RAID10 and RAID5)
- One SIMSO IPMI socket (AOC-SIMSO)
- Two Giga-bit LAN ports with IOAT Technology
- One IDE w/two devices supported
- One floppy port interface
- Two COM ports(1 header, 1 port)
- Up to five USB 2.0 (Universal Serial Bus) (2 ports, 2 Headers)
- ATI ES1000 16MB Graphic Controller
- Super I/O: Winbond W83627HG w/Hardware Monitor support: W83793G

Other

- External modem ring-on
- Wake-on-LAN (WOL)
- Wake-on-Ring (WOR)
- Console redirection
- Onboard Fan Speed Control by Thermal Management via BIOS
- SDDC support

CD/Diskette Utilities

- BIOS flash upgrade utility and device drivers

Dimensions

- Proprietary 13.035" (L) x 12.075" (W) (331.09mm x 306.71mm)

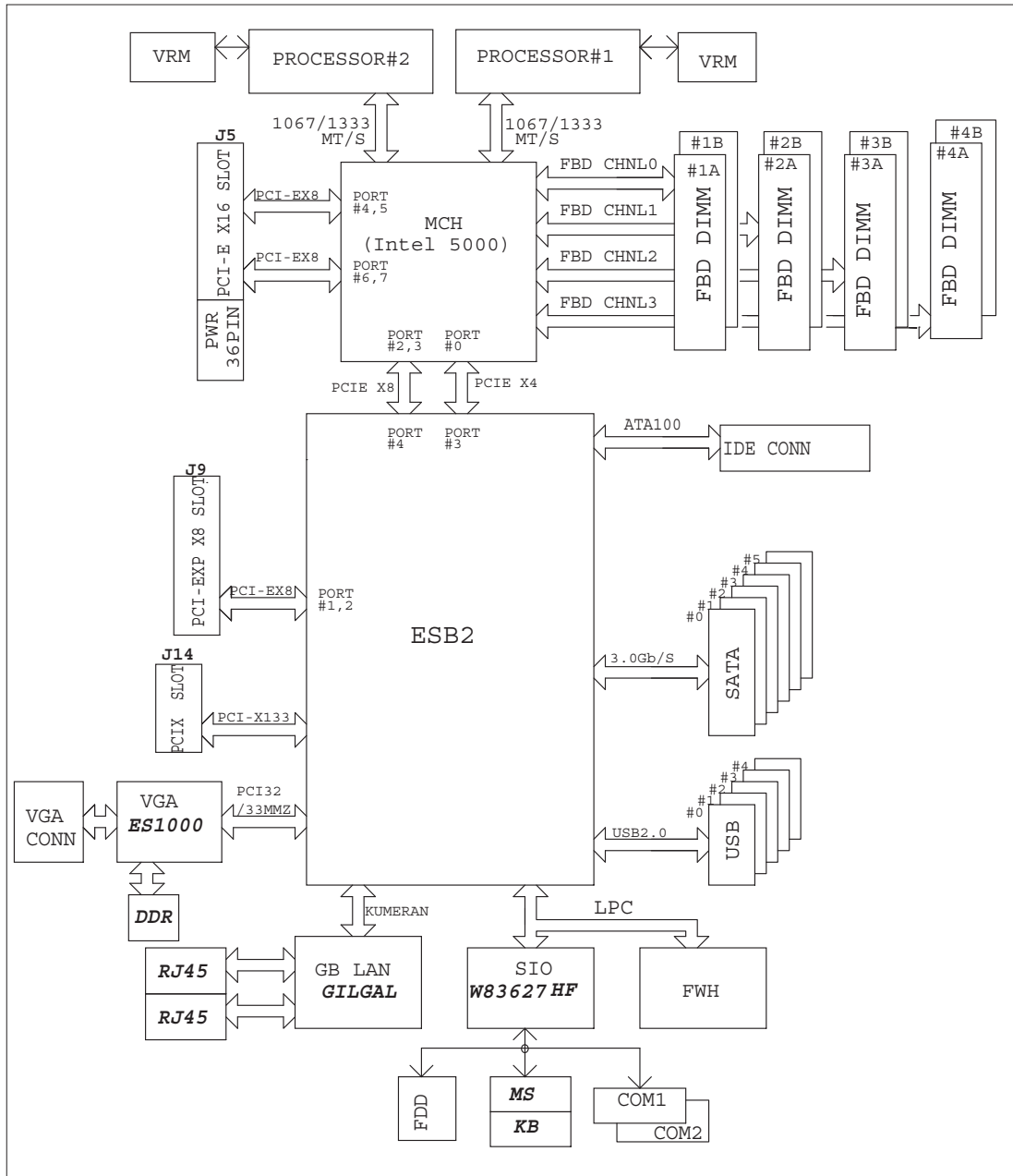

System Block Diagram for the X7DBU

Note: This is a general chipset block diagram. Please see the previous Motherboard Features pages for details on the features of each motherboard.

1-2 Chipset Overview

Built upon the functionality and the capability of the 5000P/5000X chipset, the X7DBU/X7DGU motherboard provides the performance and feature set required for dual processor-based servers with configuration options optimized for communications, presentation, storage, computation or database applications. The 5000P/5000X chipset supports a single or dual Intel 64-bit Quad-core/Dual-core processor(s) with front side bus speeds of up to 1.333 GHz. The chipset consists of the 5000P/5000X Memory Controller Hub (MCH) and the Enterprise South Bridge 2 (ESB2),

The 5000P/5000X MCH chipset is designed for symmetric multiprocessing across two independent front side bus interfaces. Each front side bus uses a 64-bit wide, 1333 MHz data bus that transfers data at 10.7 GB/sec. The MCH chipset connects up to 8 Fully Buffered DIMM modules, providing up to 32 GB of DDR2 FBD ECC memory. The MCH chipset also provides three x8 PCI-Express interface to the ESB2. In addition, the 5000P/5000X chipset offers a wide range of RAS features, including memory interface ECC, x4/x8 Single Device Data Correction, CRC, parity protection, memory mirroring and memory sparing.

Xeon Quad-core/Dual-core Processor Features

Designed to be used with conjunction of the 5000P/5000X chipset, the Xeon Quad-core/Dual-core Processor provides a feature set as follows:

The Xeon Quad-core/Dual-core Processor

*L1 Cache Size: Instruction Cache (32KB/16KB), Data Cache (32KB/24KB)

*L2 Cache Size: 4MB/2MB (per core)

*Data Bus Transfer Rate: 8.5 GB/s

*Package: FC-LGA6/FC-LGA4, 771 Lands

1-3 Special Features

Recovery from AC Power Loss

BIOS provides a setting for you to determine how the system will respond when AC power is lost and then restored to the system. You can choose for the system to remain powered off (in which case you must hit the power switch to turn it back on) or for it to automatically return to a power-on state. See the Power Lost Control setting in the Advanced section (Boot Features) to change this setting. (**Note:** Default: Last State).

1-4 PC Health Monitoring

This section describes the PC health monitoring features of the X7DBU/X7DGU. All have an onboard System Hardware Monitor chip that supports PC health monitoring.

Onboard Voltage Monitors for CPU Cores, Memory, Chipset, HT, +1.8V, +3.3V, +5V, +12V, -12V, +3.3V Standby, +5V standby and VBAT

An onboard voltage monitor will scan these voltages continuously. Once a voltage becomes unstable, a warning is given or an error message is sent to the screen. Users can adjust the voltage thresholds to define the sensitivity of the voltage monitor.

Fan Status Monitor with Firmware Control

The PC health monitor can check the RPM status of the cooling fans. The onboard CPU and chassis fans are controlled by Thermal Management via BIOS (under Hardware Monitoring in the Advanced Setting).

Environmental Temperature Control

The thermal control sensor monitors the CPU temperature in real time and will turn on the thermal control fan whenever the CPU temperature exceeds a user-defined threshold. The overheat circuitry runs independently from the CPU. Once it detects that the CPU temperature is too high, it will automatically turn on the thermal fan control to prevent any overheat damage to the CPU. The onboard chassis thermal circuitry can monitor the overall system temperature and alert users when the chassis temperature is too high.

System Resource Alert

This feature is available when used with Supero Doctor III in the Windows OS environment or used with Supero Doctor II in Linux. Supero Doctor is used to notify the user of certain system events. For example, if the system is running low on virtual memory and there is insufficient hard drive space for saving the data, you can be alerted of the potential problem. You can also configure Supero Doctor to provide you with warnings when the system temperature goes beyond a pre-defined range.

1-5 ACPI Features

ACPI stands for Advanced Configuration and Power Interface. The ACPI specification defines a flexible and abstract hardware interface that provides a standard way to integrate power management features throughout a PC system, including its hardware, operating system and application software. This enables the system to automatically turn on and off peripherals such as CD-ROMs, network cards, hard disk drives and printers. This also includes consumer devices connected to the PC such as VCRs, TVs, telephones and stereos.

In addition to enabling operating system-directed power management, ACPI provides a generic system event mechanism for Plug and Play and an operating system-independent interface for configuration control. ACPI leverages the Plug and Play BIOS data structures while providing a processor architecture-independent implementation that is compatible with Windows 2000, Windows XP and Windows 2003 Server Operating Systems.

Slow Blinking LED for Suspend-State Indicator

When the CPU goes into a suspend state, the chassis power LED will start blinking to indicate that the CPU is in suspend mode. When the user presses any key, the CPU will wake-up and the LED will automatically stop blinking and remain on.

Main Switch Override Mechanism

When an ATX power supply is used, the power button can function as a system suspend button to make the system enter a SoftOff state. The monitor will be suspended and the hard drive will spin down. Pressing the power button again to "wake-up" the whole system. During the SoftOff state, the ATX power supply provides power to keep the required circuitry in the system "alive." In case the system malfunctions and you want to turn off the power, just press and hold the power button for 4 seconds. This option can be set in the Power section of the BIOS Setup routine.

External Modem Ring-On

Wake-up events can be triggered by a device such as the external modem ringing when the system is in the SoftOff state. Note that external modem ring-on can only be used with an ATX 2.01 (or above) compliant power supply.

Wake-On-LAN (WOL)

Wake-On-LAN is defined as the ability of a management application to remotely power up a computer that is powered off. Remote PC setup, up-dates and asset tracking can occur after hours and on weekends so that daily LAN traffic is kept to a minimum and users are not interrupted. The motherboard has a 3-pin header (WOL) to connect to the 3-pin header on a Network Interface Card (NIC) that has WOL capability. In addition, an onboard LAN controller can also support WOL without any connection to the WOL header. The 3-pin WOL header is to be used with a LAN add-on card only.

Note: Wake-On-LAN requires an ATX 2.01 (or above) compliant power supply.

1-6 Power Supply

As with all computer products, a stable power source is necessary for proper and reliable operation. It is even more important for processors that have high CPU clock rates.

The X7DBU/X7DGU can only accommodate 20-pin ATX power supplies. Although most power supplies generally meet the specifications required by the CPU, some are inadequate. The 12V 4-pin and the 12V 8-pin power connections are also required to ensure adequate power supply to the system. In addition, the UIO power connector, located at J11, is required to supply power to Universal IO slots. Also your power supply must supply 1.5A for the Ethernet ports.

It is strongly recommended that you use a high quality power supply that meets ATX power supply Specification 2.01 or above. It must also be SSI compliant (info at <http://www.ssiforum.org/>). Additionally, in areas where noisy power transmission is present, you may choose to install a line filter to shield the computer from noise. It is recommended that you also install a power surge protector to help avoid problems caused by power surges.

1-7 Super I/O

The disk drive adapter functions of the Super I/O chip include a floppy disk drive controller that is compatible with industry standard 82077/765, a data separator, write pre-compensation circuitry, decode logic, data rate selection, a clock generator, drive interface control logic and interrupt and DMA logic. The wide range of functions integrated onto the Super I/O greatly reduces the number of components required for interfacing with floppy disk drives. The Super I/O supports 360 K, 720 K, 1.2 M, 1.44 M or 2.88 M disk drives and data transfer rates of 250 Kb/s, 500 Kb/s or 1 Mb/s. It also provides two high-speed, 16550 compatible serial communication ports (UARTs). Each UART includes a 16-byte send/receive FIFO, a programmable baud rate generator, complete modem control capability and a processor interrupt system. Both UARTs provide legacy speed with baud rate of up to 115.2 Kbps as well as an advanced speed with baud rates of 250 K, 500 K, or 1 Mb/s, which support higher speed modems.

The Super I/O provides functions that comply with ACPI (Advanced Configuration and Power Interface), which includes support of legacy and ACPI power management through an SMI or SCI function pin. It also features auto power management to reduce power consumption.

The IRQs, DMAs and I/O space resources of the Super I/O can flexibly adjust to meet ISA PnP requirements, which support ACPI and APM (Advanced Power Management).

Notes

Chapter 2

Installation

2-1 Static-Sensitive Devices

Electro-Static-Discharge (ESD) can damage electronic components. To prevent damage to your system board, it is important to handle it very carefully. The following measures are generally sufficient to protect your equipment from ESD.

Precautions

- Use a grounded wrist strap designed to prevent static discharge.
- Touch a grounded metal object before removing the board from the antistatic bag.
- Handle the board by its edges only; do not touch its components, peripheral chips, memory modules or gold contacts.
- When handling chips or modules, avoid touching their pins.
- Put the motherboard and peripherals back into their antistatic bags when not in use.
- For grounding purposes, make sure your computer chassis provides excellent conductivity between the power supply, the case, the mounting fasteners and the motherboard.
- Use only the correct type of onboard CMOS battery as specified by the manufacturer. Do not install the onboard battery upside down to avoid possible explosion.

Unpacking

The motherboard is shipped in antistatic packaging to avoid static damage. When unpacking the board, make sure the person handling it is static protected.

2-2 Processor and Heatsink Installation



When handling the processor package, avoid placing direct pressure on the label area of the fan.

- (Notes:** 1. Always connect the power cord last and always remove it before adding, removing or changing any components. Make sure that you install the processor into the CPU socket before you install the CPU heatsink.
2. Intel's boxed Xeon CPU package contains the CPU fan and heatsink assembly. If you buy a CPU separately, make sure that you use only Intel-certified multi-directional heatsink and fan.
3. Make sure to install the motherboard into the chassis before you install the CPU heatsink and fan.
4. When purchasing an LGA 771 CPU or when receiving a motherboard with an LGA 771 CPU pre-installed, make sure that the CPU plastic cap is in place and none of the CPU pins are bent; otherwise, contact the retailer immediately.
5. Refer to the MB Features Section for more details on CPU support.

Installation of the LGA771 Processor

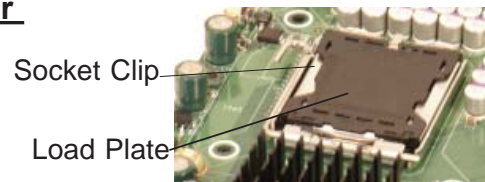

1. Press the socket clip to release the load plate, which covers the CPU socket, from its locking position.



2. Gently lift the socket clip to open the load plate.

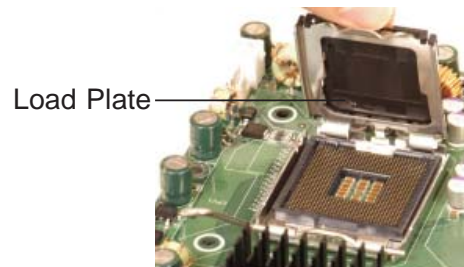

3. Use your thumb and your index finger to hold the CPU at the North Center Edge and the South Center Edge of the CPU.

4. Align CPU Pin1 (the CPU corner marked with a triangle) against the socket corner that is marked with a triangle cutout.

5. Align the CPU key that is the semi-circle cutout below a gold dot against the socket key, the notch on the same side of the triangle cutout on the socket.

6. Once aligned, carefully lower the CPU straight down to the socket. (**Do not drop the CPU on the socket. Do not move the CPU horizontally or vertically. Do not rub the CPU against the surface or against any pins of the socket to avoid damage to the CPU or the socket.)

7. With the CPU inside the socket, inspect the four corners of the CPU to make sure that the CPU is properly installed.

8. Use your thumb to gently push the socket clip down to the clip lock.

9. If the CPU is properly installed into the socket, the plastic cap will be automatically released from the load plate when the clip is pushed into the clip lock. Remove the plastic cap from the motherboard.

 **(Warning:** Please keep the plastic cap. The motherboard and the CPU must be shipped with the plastic cap properly installed to protect the CPU pins. Shipment without the CPU plastic cap properly installed will void the warranty.)

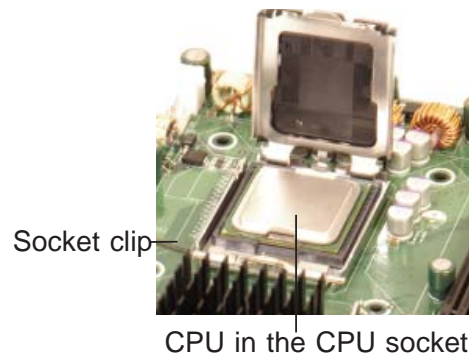
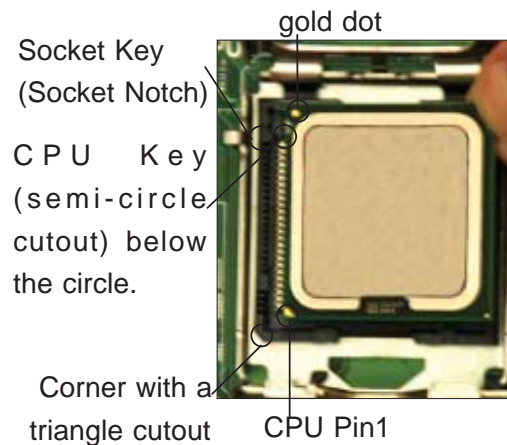

Plastic cap is released from the load plate if the CPU is properly installed.



Installation of the Heatsink

CEK Heatsink Installation

1. Do not apply any thermal grease to the heatsink or the CPU die-the required amount has already been applied.
2. Place the heatsink on top of the CPU so that the four mounting holes are aligned with those on the retention mechanism.
3. Screw in two diagonal screws (ie the #1 and the #2 screws) until just snug. Do not fully tighten the screws to avoid possible damage to the CPU.
4. Finish the installation by fully tightening all four screws.

CEK Passive Heatsink

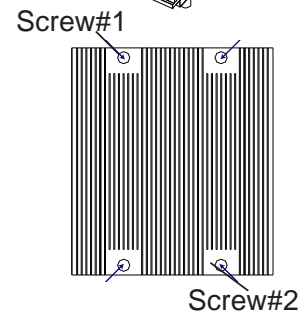
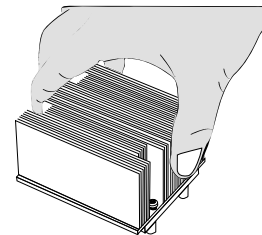

To Un-install the Heatsink



(Warning: We do not recommend that the CPU or the heatsink be removed. However, if you do need to uninstall the heatsink, please follow the instructions below to uninstall the heatsink to avoid damage done to the CPU or the CPU socket.)

1. Unscrew and remove the heatsink screws from the motherboard in the sequence as show in the picture on the right.

2. Hold the heatsink as shown in the picture on the right and gently wiggle the heatsink to loosen it from the CPU. (Do not use excessive force when wiggling the heatsink!!)

3. Once the heatsink is loosened, remove the heatsink from the CPU socket.

4. Clean the surface of the CPU and the heatsink to get rid of the old thermal grease. Reapply the proper amount of thermal grease on the surface before you re-install the CPU and the heatsink.

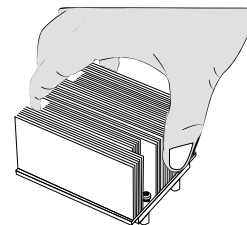
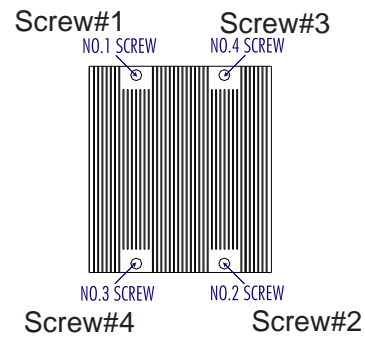

Mounting the Motherboard in the Chassis

All motherboards have standard mounting holes to fit different types of chassis. Make sure that the locations of all the mounting holes for both motherboard and chassis match. Make sure that the metal standoffs click in or are screwed in tightly. Then, use a screwdriver to secure the motherboard onto the motherboard tray. (**Note:** some components are very close to the mounting holes. Please take precautionary measures to prevent damage done to these components when you install the motherboard to the chassis.)

2-3 Installing DIMMs

Note: Check the Supermicro web site for recommended memory modules.



CAUTION

Exercise extreme care when installing or removing DIMM modules to prevent any possible damage. Also note that the memory is interleaved to improve performance (see step 1).

DIMM Installation

1. Insert the desired number of DIMMs into the memory slots, starting with DIMM #1A. The memory scheme is interleaved so you must install two modules at a time, beginning with DIMM #1A, then DIMM #2A and so on. (*See the Memory Installation Table Below.)
2. Insert each DIMM module vertically into its slot. Pay attention to the notch along the bottom of the module to prevent inserting the DIMM module incorrectly.
3. Gently press down on the DIMM module until it snaps into place in the slot. Repeat for all modules (see step 1 above).

Memory Support

The X7DBU/X7DGPU supports up to 32 GB fully buffered (FBD) ECC DDR2 667/533 in 8 DIMMs. Populating DIMM modules with pairs of memory modules of the same size and same type **will result in Interleaved Memory which will increase memory performance.**

Optimized DIMM Population Configurations								
	Branch 0				Branch 1			
Number of DIMMs	Bank 1 (Channel 0)		Bank 2 (Channel 1)		Bank 3 (Channel 2)		Bank 4 (Channel 3)	
2 DIMMs	1A	---	2A	---	---	---	---	---
4 DIMMs	1A	---	2A	---	3A	---	4A	---
6 DIMMs	1A	1B	2A	2B	3A	---	4A	---
8 DIMMs	1A	1B	2A	2B	3A	3B	4A	4B

(*Notes: i. DIMM slot# specified: DIMM slot to be populated; "--": DIMM slot not to be populated. ii. Both FBD 533 MHz and 667MHz DIMMs are supported; however, you need to use the memory modules of the same speed and of the same type on a motherboard. iii. Interleaved memory is supported when pairs of DIMM modules are installed. For best performance, please install memory modules in both Branch 0 and Branch 1. iv. For memory to work properly, you need to follow the restrictions listed above.)

Note 1: Due to OS limitations, some operating systems may not show more than 4 GB of memory.

Note 2: Due to memory allocation to system devices, memory remaining available for operational use will be reduced when 4 GB of RAM is used. The reduction in memory availability is disproportional. (Refer to the Memory Availability Table on the next page for details.)

Possible System Memory Allocation & Availability		
System Device	Size	Physical Memory Remaining (-Available) (4 GB Total System Memory)
Firmware Hub flash memory (System BIOS)	1 MB	3.99
Local APIC	4 KB	3.99
Area Reserved for the chipset	2 MB	3.99
I/O APIC (4 Kbytes)	4 KB	3.99
PCI Enumeration Area 1	256 MB	3.76
PCI Express (256 MB)	256 MB	3.51
PCI Enumeration Area 2 (if needed) -Aligned on 256-MB boundary-	512 MB	3.01
VGA Memory	16 MB	2.85
TSEG	1 MB	2.84
Memory available to System BIOS & OS applications		2.84

Installing and Removing DIMMs

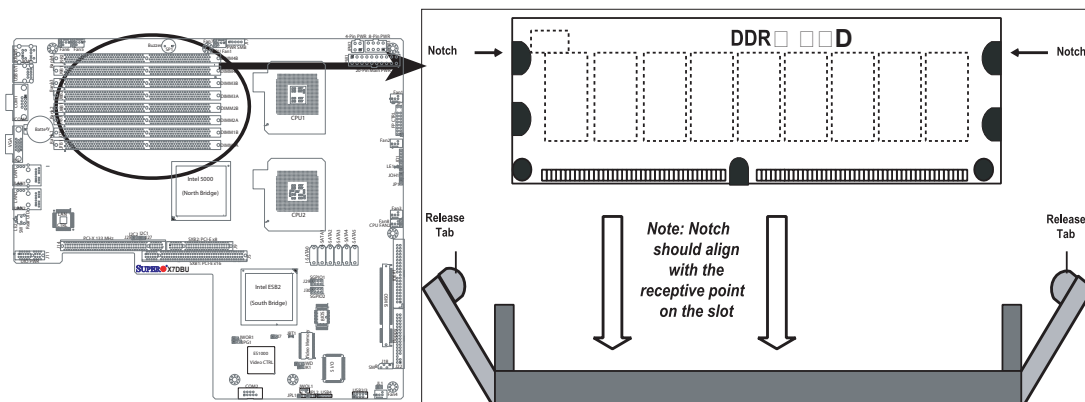

To Install: Insert module vertically and press down until it snaps into place. Pay attention to the alignment notch at the bottom.

To Remove:

Use your thumbs to gently push the release tabs near both ends of the module. This should release it from the slot.

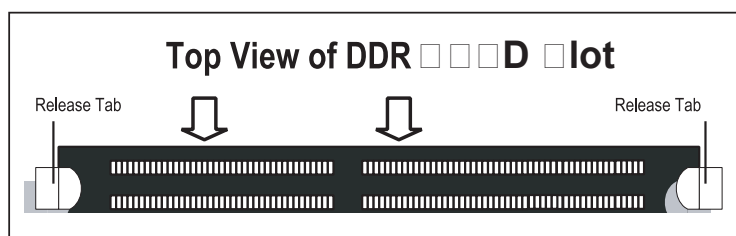

2-4 Control Panel Connectors/IO Ports

The I/O ports are color coded in conformance with the PC 99 specification. See the figure below for the colors and locations of the various I/O ports.

A. Back Panel Connectors/IO Ports

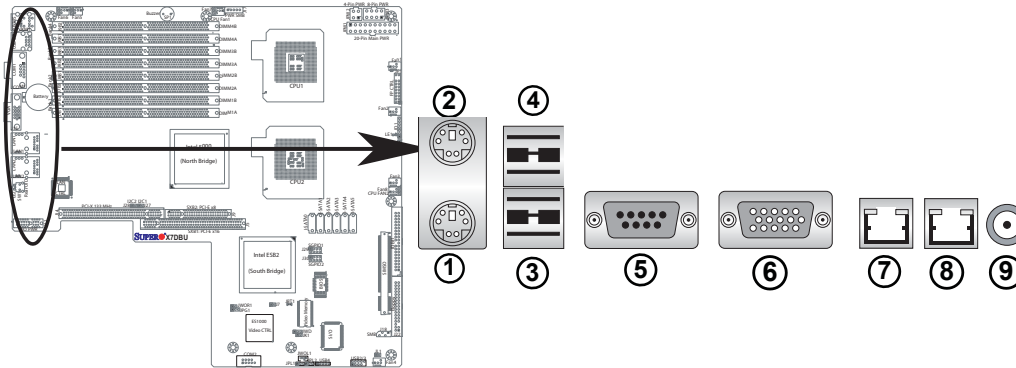

Back Panel I/O Port Locations and Definitions

Back Panel Connectors

1. Keyboard (Purple)
2. PS/2 Mouse (Green)
3. Back Panel USB Port 0
4. Back Panel USB Port 1
5. COM Port 1 (Turquoise)
6. VGA Port (Blue) 7. Gigabit LAN 1
8. Gigabit LAN 2
9. Rear UID Switch

(See Section 2-5 for details.)

B. Front Control Panel

JF1 contains header pins for various buttons and indicators that are normally located on a control panel at the front of the chassis. These connectors are designed specifically for use with Supermicro server chassis. See the figure for the descriptions of the various control panel buttons and LED indicators. Refer to the following section for descriptions and pin definitions.

JF1 Header Pins

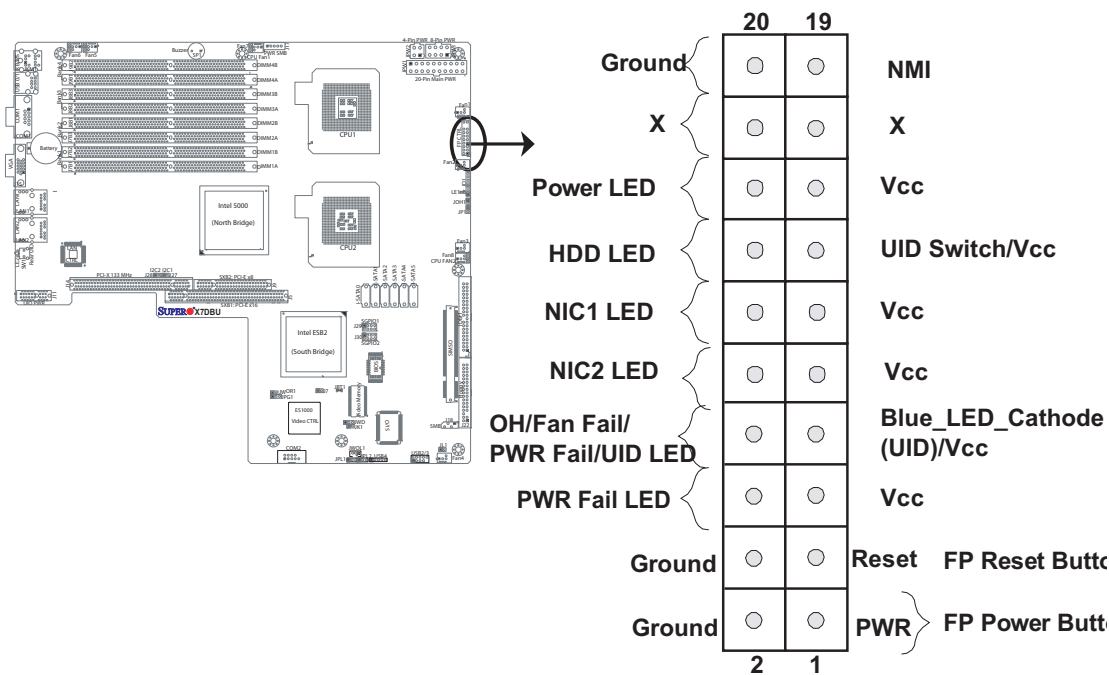

C. Front Control Panel Pin Definitions

NMI Button

The non-maskable interrupt button header is located on pins 19 and 20 of JF1. Refer to the table on the right for pin definitions.

NMI Button Pin Definitions (JF1)	
Pin#	Definition
19	Control
20	Ground

Power LED

The Power LED connection is located on pins 15 and 16 of JF1. Refer to the table on the right for pin definitions.

Power LED Pin Definitions (JF1)	
Pin#	Definition
15	+5V
16	Ground

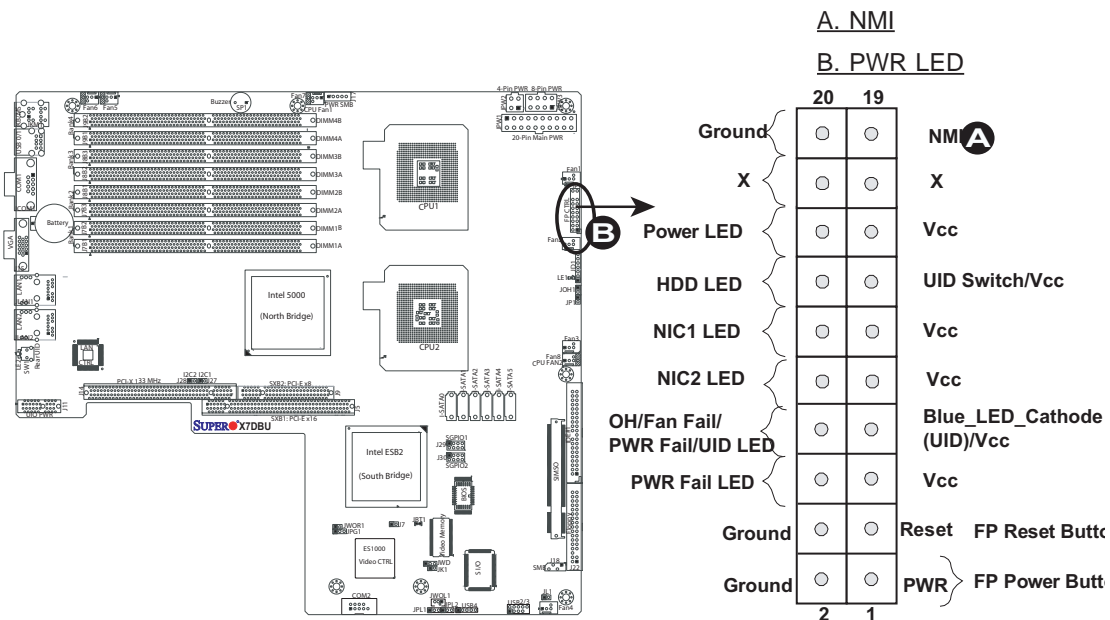

HDD LED/FP UID Switch

The Front Panel UID Switch connection is located on pin 13 of JF1. Connect a cable with a switch attached to pin 13 of JF1 to provide Unit Identification to your system. (*For more information on the UID Switches, please refer to UID Switches on Page 2-22.) The HDD LED connection is located on pins 13 (Vcc) and 14 of JF1. Attach the hard drive LED cable here to display disk activity (for any hard drives on the system, including Serial ATA and IDE). See the table on the right for pin definitions.

HDD LED Pin Definitions (JF1)	
Pin#	Definition
13	UID Switch/+5V (for HDD Act)
14	HD Active

NIC1/NIC2 LED Indicators

The NIC (Network Interface Controller) LED connection for GLAN port1 is located on pins 11 and 12 of JF1 and the LED connection for GLAN Port2 is on Pins 9 and 10. Attach the NIC LED cables to display network activity. Refer to the table on the right for pin definitions.

GLAN1/2 LED Pin Definitions (JF1)	
Pin#	Definition
9/11	Vcc
10/12	PWR Fail

- A. FP UID Switch
- B. HDD LED
- C. NIC1 LED
- D. NIC2 LED

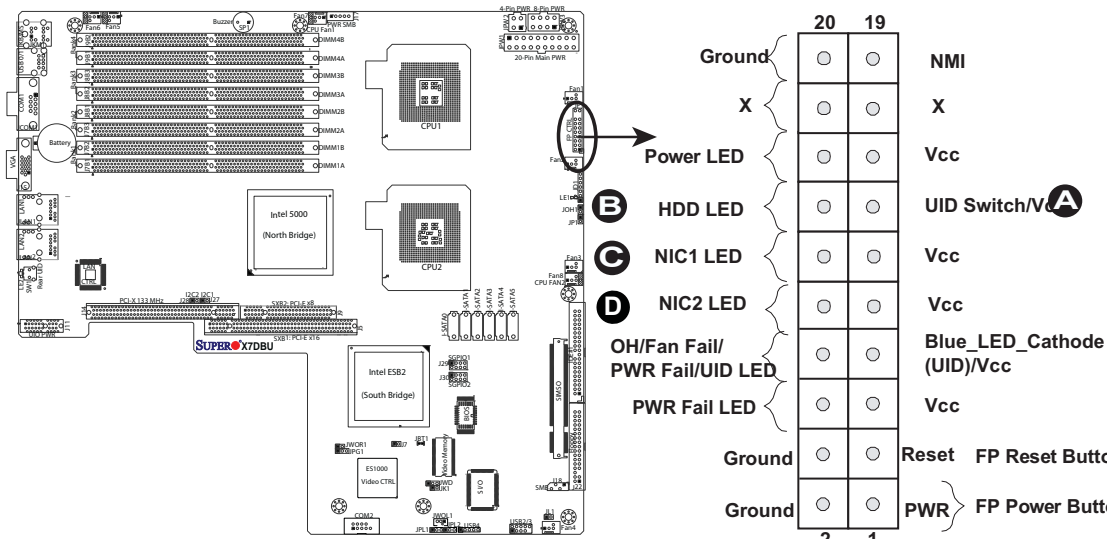

Overheat (OH)/Fan Fail/PWR Fail/FP UID LED

Connect an LED to the Overheat/Fan Fail/PWR Fail/UID (Unit ID) LED connection on pins 7 and 8 of JF1 to provide advanced warnings of chassis overheating, power failure or fan failure in addition to providing unit identification for your system. (*For more information on UID Switches, please refer to Pages 2-11 and 2-22.) Refer to the table on the right for pin definitions.

OH/Fan Fail/PWR Fail/FP UID LED Pin Definitions (JF1)	
Pin#	Definition
7	Blue_LED_Cathode (UID)
8	OH_Fan Fail_PWR Fail_UID

OH/Fan Fail/PWR Fail/FP UID Indicator Status	
State	Definition
Off	System Normal
Red On	Overheat
Red Flashing	Fan Fail/PWR Fail
Blue On	FP UID

Power Fail LED

The Power Fail LED connection is located on pins 5 and 6 of JF1. Refer to the table on the right for pin definitions.

PWR Fail LED Pin Definitions (JF1)	
Pin#	Definition
5	Vcc
6	Ground

A. OH/Fan Fail/PWR Fail/UID LED

B. PWR Supply Fail

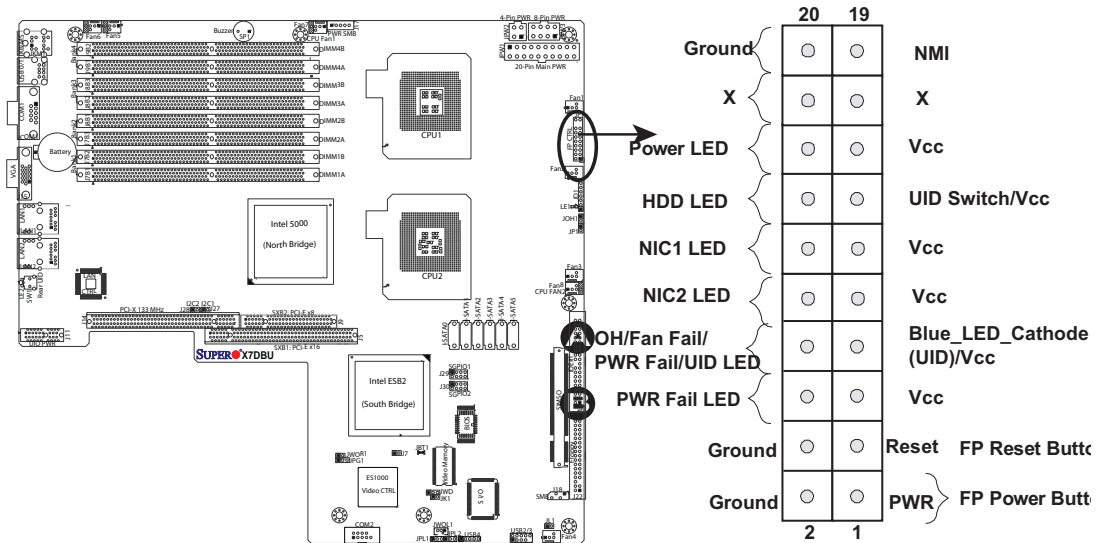

Reset Button

The Reset Button connection is located on pins 3 and 4 of JF1. Attach it to the hardware reset switch on the computer case. Refer to the table on the right for pin definitions.

Reset Button Pin Definitions (JF1)	
Pin#	Definition
3	Reset
4	Ground

Power Button

The Power Button connection is located on pins 1 and 2 of JF1. Momentarily contacting both pins will power on/off the system. This button can also be configured to function as a suspend button (with a setting in BIOS - see Chapter 4). To turn off the power when set to suspend mode, press the button for at least 4 seconds. Refer to the table on the right for pin definitions.

Power Button Pin Definitions (JF1)	
Pin#	Definition
1	Signal
2	+3V Standby

A. Reset Button

B. PWR Button

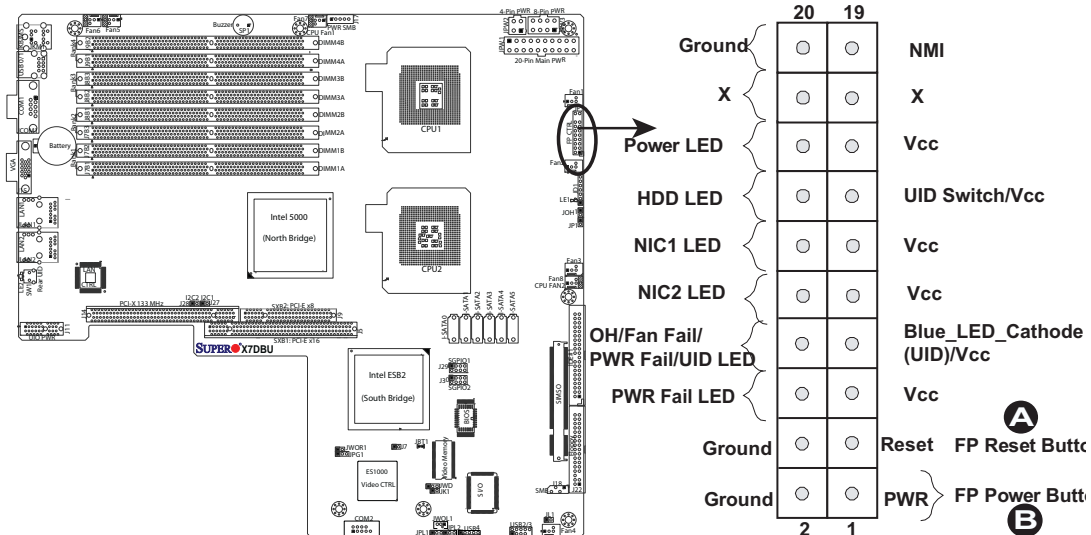

2-5 Connecting Cables

ATX Power Connector

There are a 20-pin main power supply connector(JPW1) and an 8-pin CPU PWR connector (JPW3) on the motherboard. These power connectors meet the SSI EPS 12V specification. The 4-pin 12V PWR supply is required to provide adequate power to the system. The UIO PWR, located at J11, is also required for the UIO slots. For the 8-pin PWR (JPW3), please refer to the item listed below. See the table on the right for pin definitions.

Pin#	Definition	Pin #	Definition
11	+3.3V	1	+3.3V
12	-12V	2	+3.3V
13	COM	3	COM
14	PS_ON	4	+5V
15	COM	5	COM
16	COM	6	+5V
17	COM	7	COM
18	Res (NC)	8	PWR_OK
19	+5V	9	5VSB
20	+5V	10	+12V

Processor Power Connector

In addition to the Primary ATX power connector (above), the 12V 8-pin CPU PWR connector at JPW3 must also be connected to your power supply. See the table on the right for pin definitions.

Pins	Definition
1 and 2	Ground
3 and 4	+12V

Required Connection

Pins	Definition
1 through 4	Ground
5 through 8	+12V

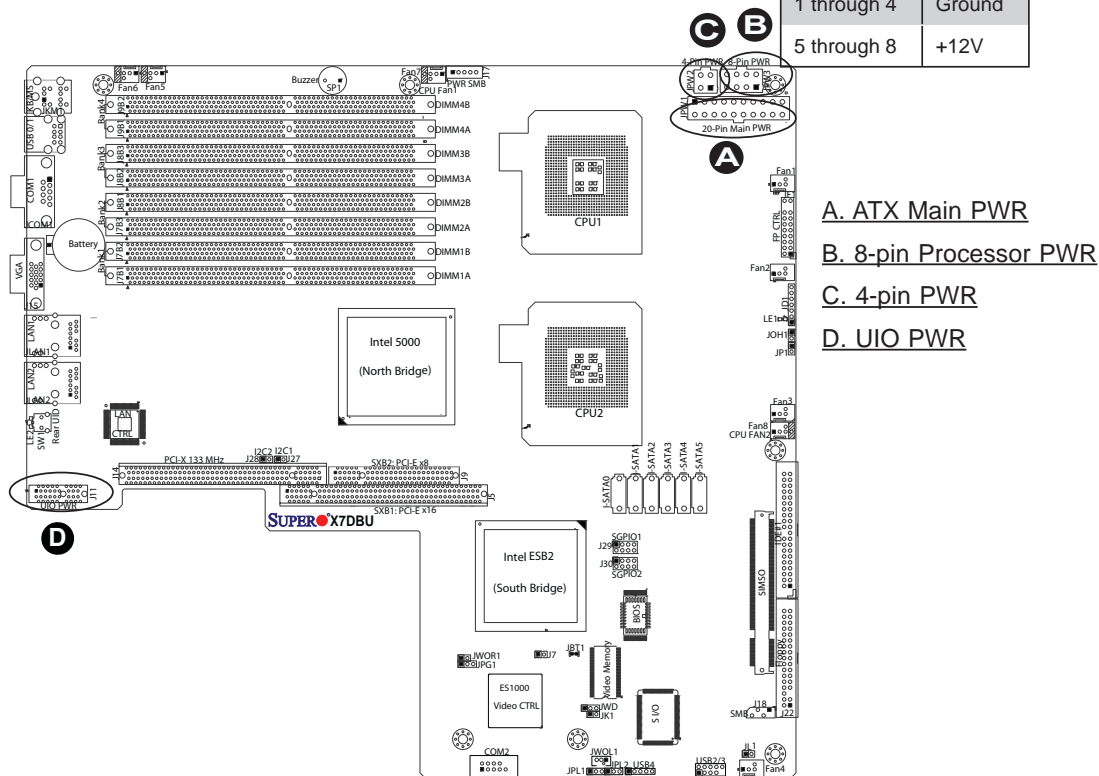

- A. ATX Main PWR
- B. 8-pin Processor PWR
- C. 4-pin PWR
- D. UIO PWR

Universal Serial Bus (USB)

There are five USB 2.0 (Universal Serial Bus) ports/headers on the motherboard. Two of them are Back Panel USB ports (USB#0/1), and the other are Front Panel USB headers (USB#2/3, USB#4). See the tables on the right for pin definitions.

Back Panel USB (USB 0/1)	
Pin#	Definitions
1	+5V
2	PO-
3	PO+
4	Ground
5	N/A

Front Panel USB Pin Definitions (USB 2/3/4)			
USB2/4		USB3	
Pin #	Definition	Pin #	Definition
1	+5V	1	+5V
2	PO-	2	PO-
3	PO+	3	PO+
4	Ground	4	Ground
5	Key	5	No connection

Chassis Intrusion

A Chassis Intrusion header is located at JL1. Attach the appropriate cable from the chassis to inform you of a chassis intrusion when the chassis is opened.

Chassis Intrusion Pin Definitions (JL1)	
Pin#	Definition
1	Intrusion Input
2	Ground

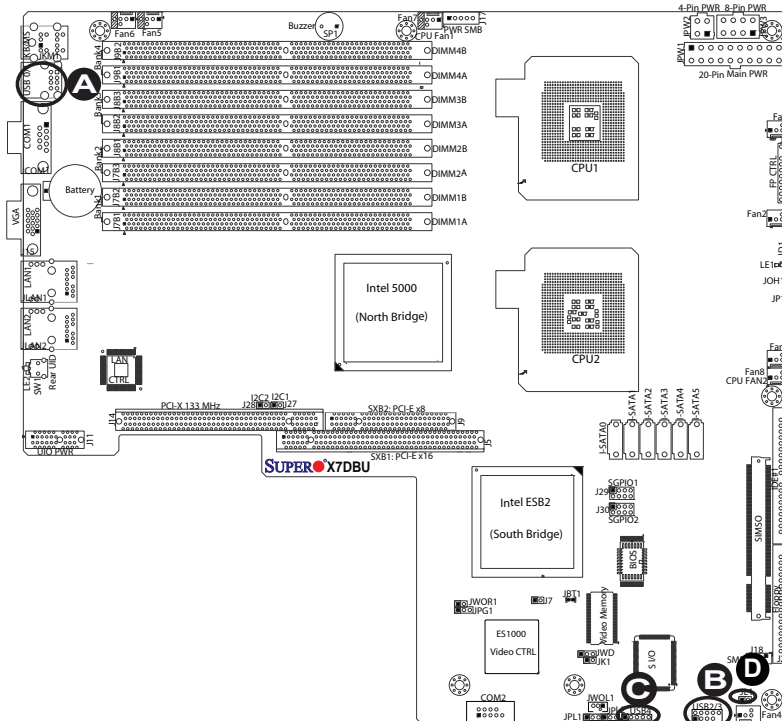

- A. Backpanel USB 0/1
- B. Front Panel USB 2/3
- C. Front Panel USB 4
- D. Chassis Intrusion

Fan Headers

The X7DBU/X7DGPU has eight chassis/system fan headers (Fan1 to Fan8.) Fan1-Fan6 are chassis/system fans, while Fan7 and Fan8 are CPU fans. Fan5-Fan8 are 4-pin fan headers. Pins 1-3 of the 4-pin fan headers are backward compatible with the traditional 3-pin fans. The fan speeds for the 4-pin fans are controlled by Thermal Management via BIOS Hardware Monitor in the Advanced Setting. The default setting is Disabled. See the table on the right for pin definitions. (***Note:** all these fans are 4-pin fan connectors. However, Pins 1-3 of the fan headers are backward compatible with the traditional 3-pin fans.)

3-Pin Fan Header Pin Definitions	
Pin#	Definition
1	Ground
2	+12V
3	Tachometer

4-Pin Fan Header Pin Definitions	
Pin#	Definition
1	Ground
2	+12V
3	Tachometer
4	PWM Signals

Keylock

The keyboard lock connection is designated JK1. Utilizing this header allows you to inhibit any actions made on the keyboard, effectively "locking" it.

Keylock Pin Definitions	
Pin#	Definition
1	Ground
2	Keylock R-N

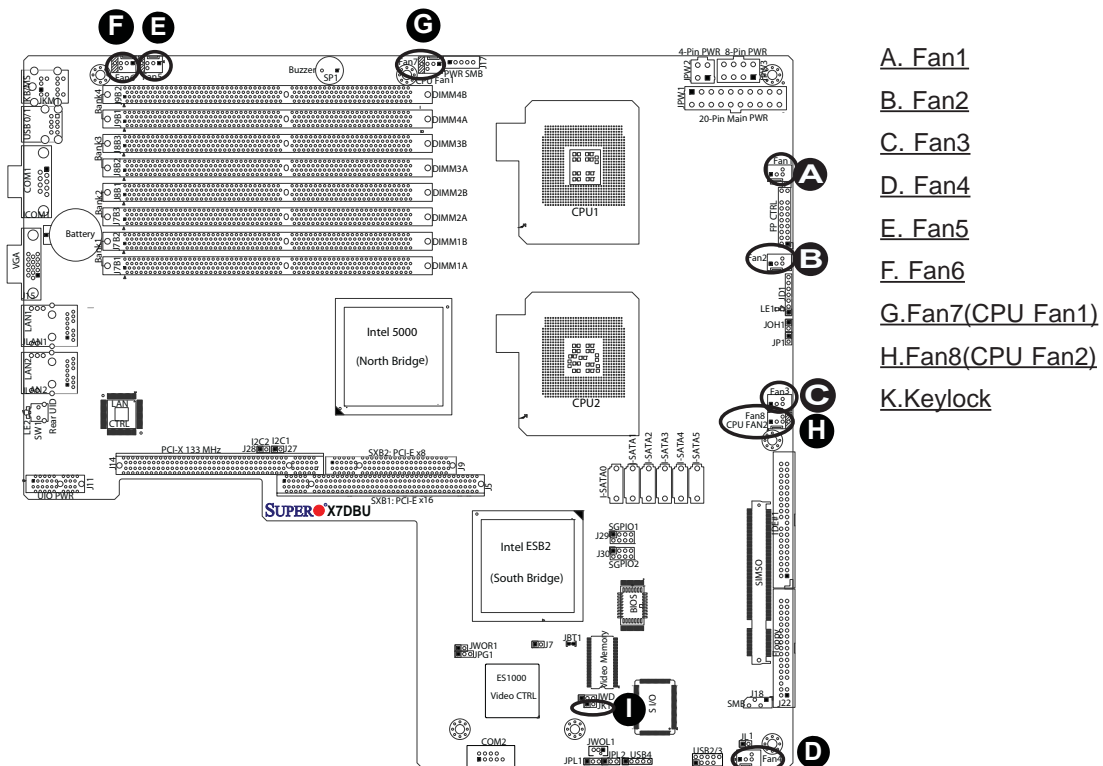

ATX PS/2 Keyboard and PS/2 Mouse Ports

The ATX PS/2 keyboard and the PS/2 mouse ports are located at JKM1. See the table on the right for pin definitions. See the table on the right for pin definitions.

PS/2 Keyboard and Mouse Port Pin Definitions	
Pin#	Definition
1	Data
2	NC
3	Ground
4	VCC
5	Clock
6	NC

Serial Ports

COM1 (JCOM1) is a connector located on the IO Backpanel and COM2 is a header located at JCOM2 to provide front access. See the table on the right for pin definitions.

Serial Port Pin Definitions (COM1/COM2)			
Pin #	Definition	Pin #	Definition
1	CD	6	DSR
2	RD	7	RTS
3	TD	8	CTS
4	DTR	9	RI
5	Ground	10	NC

(Pin 10 is available on COM2 only. NC: No Connection.)

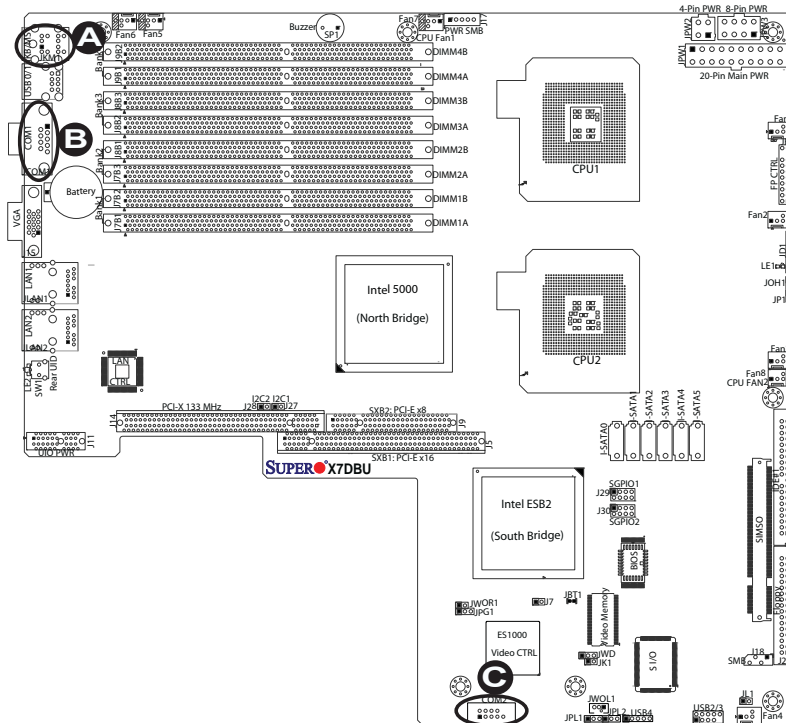

- A. KB/Mouse
- B. COM1
- C. COM2

Wake-On-Ring

The Wake-On-Ring header is designated JWOR1. This function allows your computer to receive and be "awakened" by an incoming call to the modem when the system is in the suspend state. See the table on the right for pin definitions. You must have a Wake-On-Ring card and cable to use this feature. Please make sure to enable this function in the BIOS.

Wake-On-Ring Pin Definitions	
Pin#	Definition
1	Ground
2	Wake-up

Wake-On-LAN

The Wake-On-LAN header is located at JWOL1 on the motherboard. See the table on the right for pin definitions. (You must also have a LAN card with a Wake-On-LAN connector and cable to use this feature.)

Wake-On-LAN Pin Definitions	
Pin#	Definition
1	+5V Standby
2	Ground
3	Wake-up

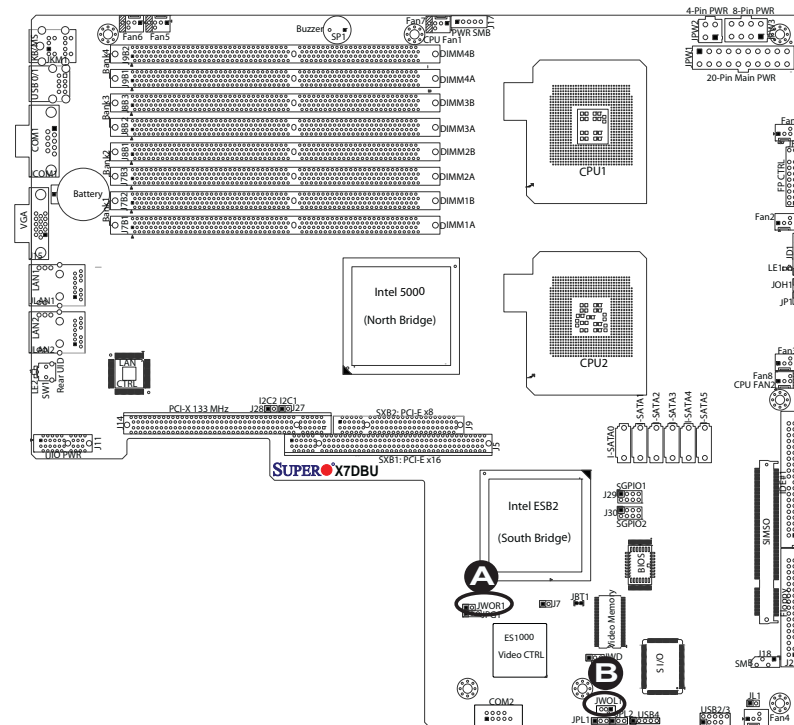

- A. WOR
- B. WOL

GLAN 1/2 (Giga-bit Ethernet Ports)

Two G-bit Ethernet ports are designated JLAN1 and JLAN2 on the IO backplane. This port accepts RJ45 type cables.



Power LED/Speaker

On the JD1 header, pins 1-3 are for a power LED, and pins 4-7 are for the speaker. See the table on the right for speaker pin definitions. ***Note:** The speaker connector pins are for use with an external speaker. If you wish to use the onboard speaker, you should close pins 6-7 with a jumper.

Speaker Connector Pin Definitions	
Pin Setting	Definition
Pins 6-7	Internal Speaker
Pins 4-7	External Speaker

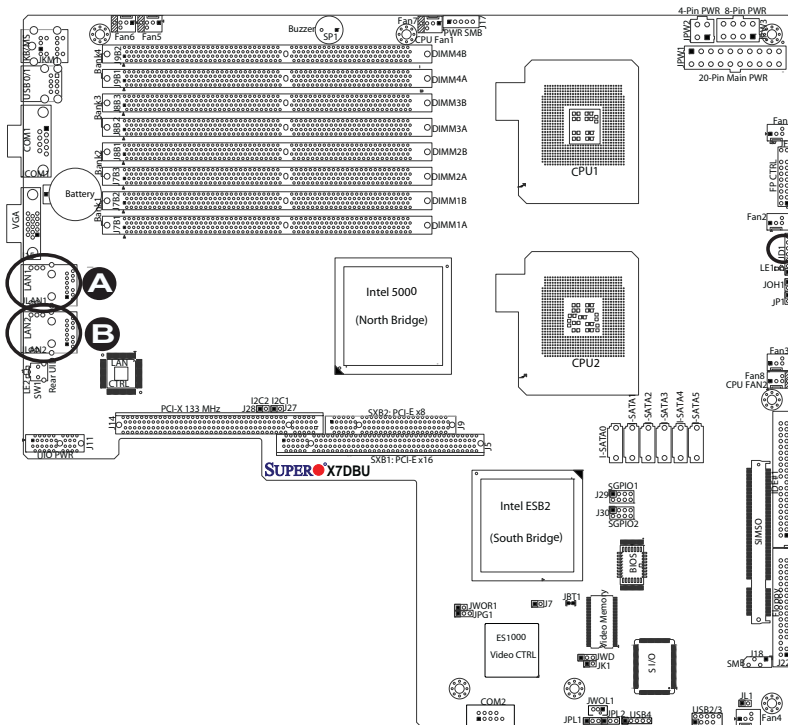

- A. GLAN1
- B. GLAN2
- C. PWR LED/Speaker

Overheat LED/Fan Fail (JOH1)

The JOH1 header is used to connect an LED to provide warnings of chassis overheating. This LED will blink to indicate a fan failure. Refer to the table on right for pin definitions.

Overheat LED Pin Definitions	
Pin#	Definition
1	5vDC
2	OH Active

OH/Fan Fail LED Pin Definitions	
State	Message
Solid	Overheat
Blinking	Fan Fail

SMB

A System Management Bus header is located at J18. Connect the appropriate cable here to utilize SMB on your system.

SMB Header Pin Definitions	
Pin#	Definition
1	Data
2	Ground
3	Clock
4	No Connection

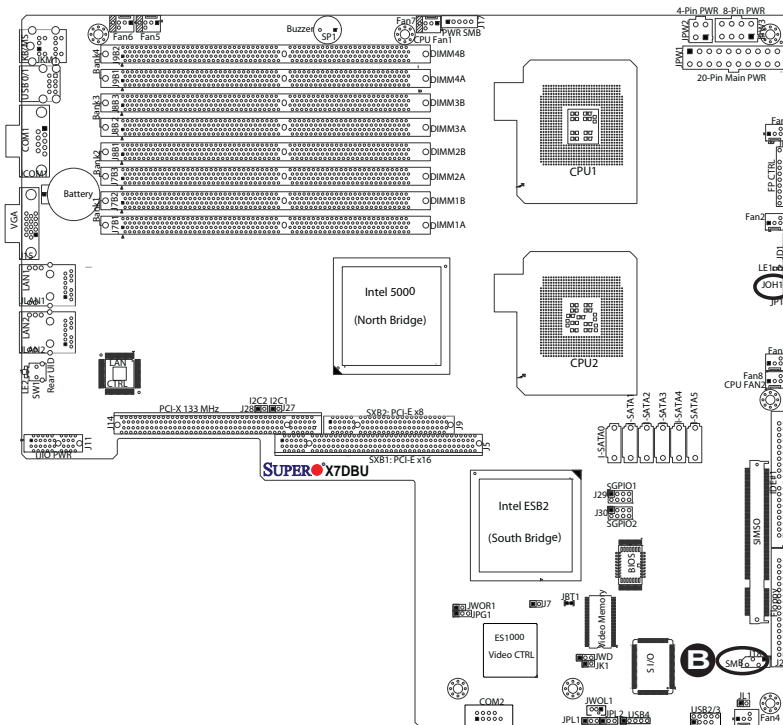

- A. OH/Fan Fail LED
- B. SMB Header

Power SMB (I² C) Connector

Power SMB (I² C) Connector (J17) monitors onboard power supply, fan speeds and system temperatures. See the table on the right for pin definitions.

PWR SMB Pin Definitions	
Pin#	Definition
1	Clock
2	Data
3	PWR Fail
4	Ground
5	+3.3V

VGA Connector

A VGA connector (J15) is located next to the GLAN2 port on the IO backplane. Refer to the board layout below for the location.

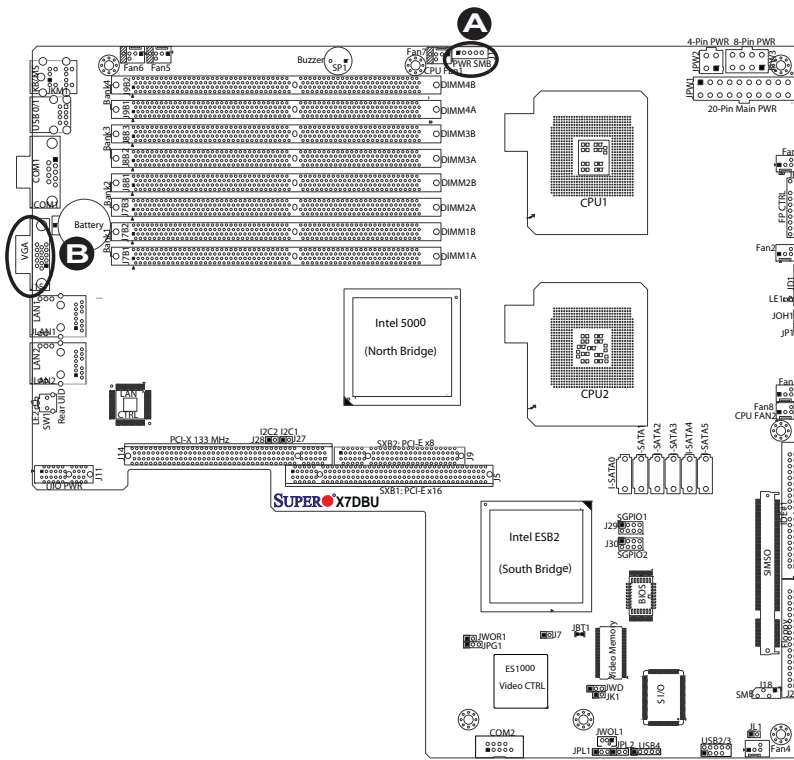

A. PWR SMB

B. VGA

Unit Identification Switches

There are two Unit Identification (UID) Switches on the motherboard. The Front Panel UID Switch is connected to Pin 13 of the Front Control Panel. The Rear UID Switch (SW1) is located next to LAN Port2. When you push the UID Switch on the Front Control Panel, both Rear UID and FP UID Indicators will turn on. Push the FP UID Switch (or the Rear UID Switch-SW1) again to turn off both Indicators. These UID Indicators provide easy identification of a system unit that may be in need of service. (*For more information on the FP UID Switch, please refer to FP UID Switch on Page 2-11.)

SGPIO Headers

There are two SGPIO (Serial General Purpose Input/Output) headers (J29, J30) located on the motherboard. These headers are used to "talk to" the AMI Chip on the backplane. See the table on the right for pin definitions. Refer to the board layout below for the locations of the headers.

SGPIO Pin Definitions			
Pin#	Definition	Pin	Definition
1	*NC	2	*NC
3	Ground	4	Data
5	Load	6	Ground
7	*NC	8	*NC

Note: NC= No Connections

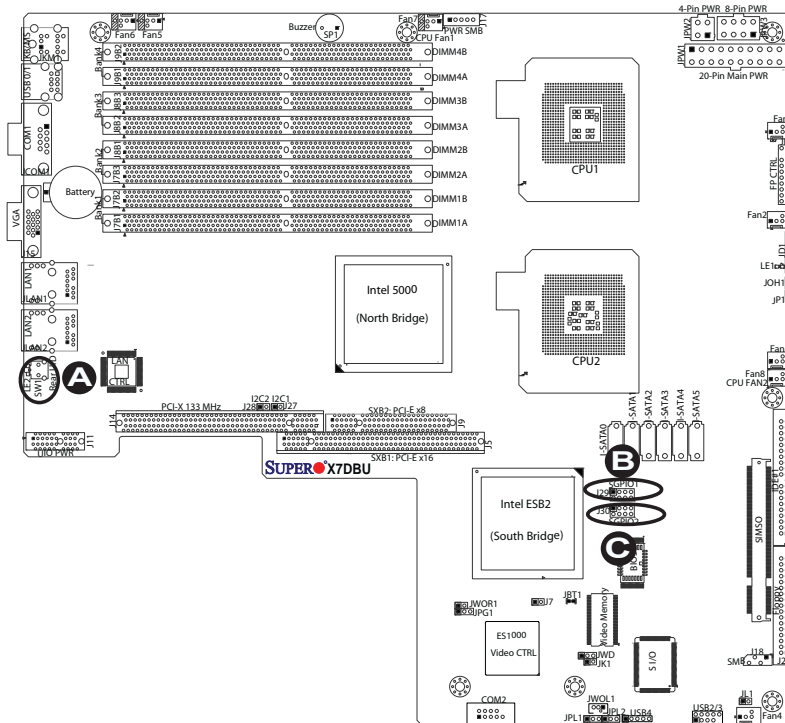

- A. UID Switch
- B. SGPIO1
- C. SGPIO2

2-6 Jumper Settings

Explanation of Jumpers

To modify the operation of the motherboard, jumpers can be used to choose between optional settings. Jumpers create shorts between two pins to change the function of the connector. Pin 1 is identified with a square solder pad on the printed circuit board. See the motherboard layout pages for jumper locations.

Note: On two pin jumpers, "Closed" means the jumper is on and "Open" means the jumper is off the pins.

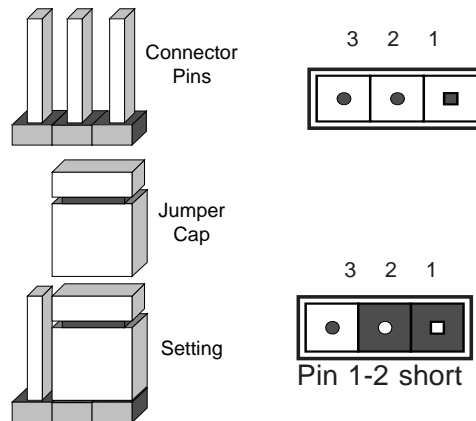

GLAN Enable/Disable

JPL1/JPL2 enable or disable the GLAN Port1/GLAN Port2 on the motherboard. See the table on the right for jumper settings. The default setting is enabled.

GLAN Enable Jumper Settings	
Pin#	Definition
1-2	Enabled (*default)
2-3	Disabled

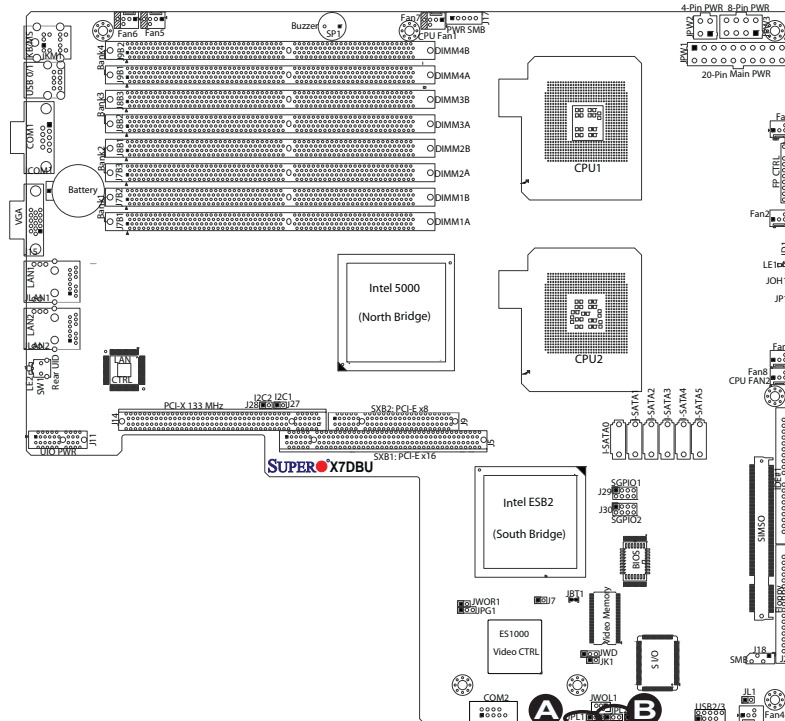

A. GLAN Port1 Enable

B. GLAN Port2 Enable

CMOS Clear

JBT1 is used to clear CMOS. Instead of pins, this "jumper" consists of contact pads to prevent the accidental clearing of CMOS. To clear CMOS, use a metal object such as a small screwdriver to touch both pads at the same time to short the connection. Always remove the AC power cord from the system before clearing CMOS. **Note:** For an ATX power supply, you must completely shut down the system, remove the AC power cord and then short JBT1 to clear CMOS.



Watch Dog Enable/Disable

Watch Dog is a system monitor that can reboot the system when a software application hangs. Close Pins 1-2 to reset the system if an application hangs. Close Pins 2-3 to generate a non-maskable interrupt signal for the application that hangs. See the table on the right for jumper settings. Watch Dog must also be enabled in the BIOS.

Watch Dog Jumper Settings (JWD)	
Jumper Setting	Definition
Pins 1-2	Reset (*default)
Pins 2-3	NMI
Open	Disabled

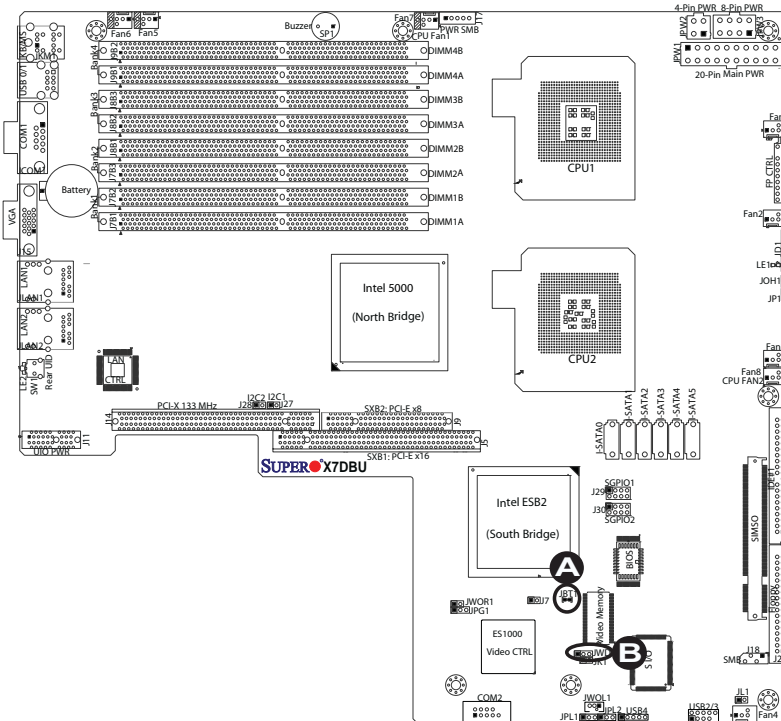

A. Clear CMOS

B. Watch Dog Enable

VGA Enable/Disable

JPG1 allows you to enable or disable the VGA port. The default position is on pins 1 and 2 to enable VGA. See the table on the right for jumper settings.

VGA Enable/Disable Jumper Settings (JPG1)	
Both Jumpers	Definition
*Pins 1-2	Enabled
Pins 2-3	Disabled

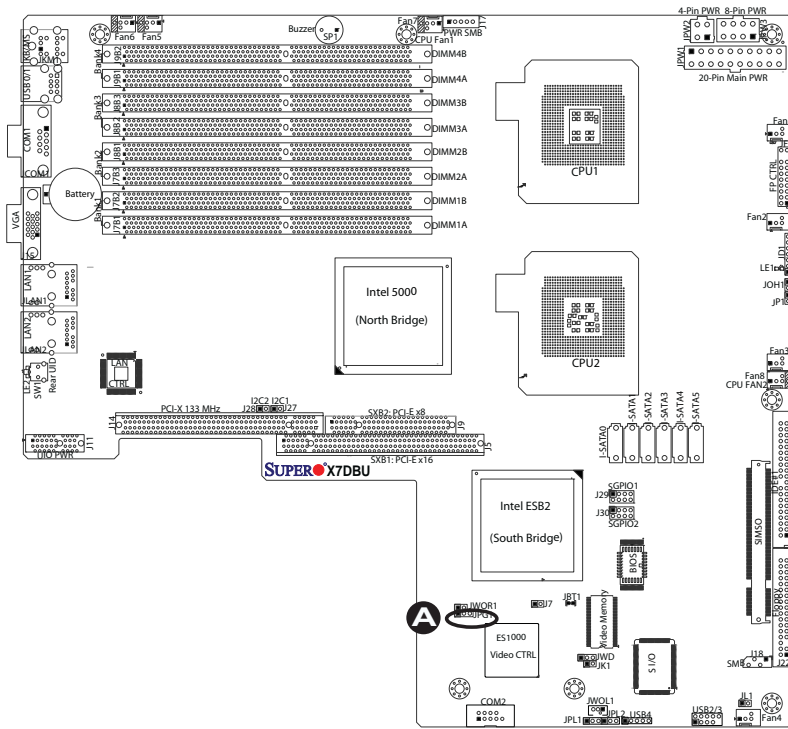

A. VGA Enabled

I²C Bus to PCI Slots 1/2

JI²C1 (J27)/JI²C2 (J28) allow you to enable I²C Bus to PCI-X/PCI-E slots. See the table on the right for jumper settings. The default setting is Disabled.

I ² C Bus to PCI Slots Jumper Settings	
Jumper	Definition
1-2	Enabled
Off	Disabled (Default)

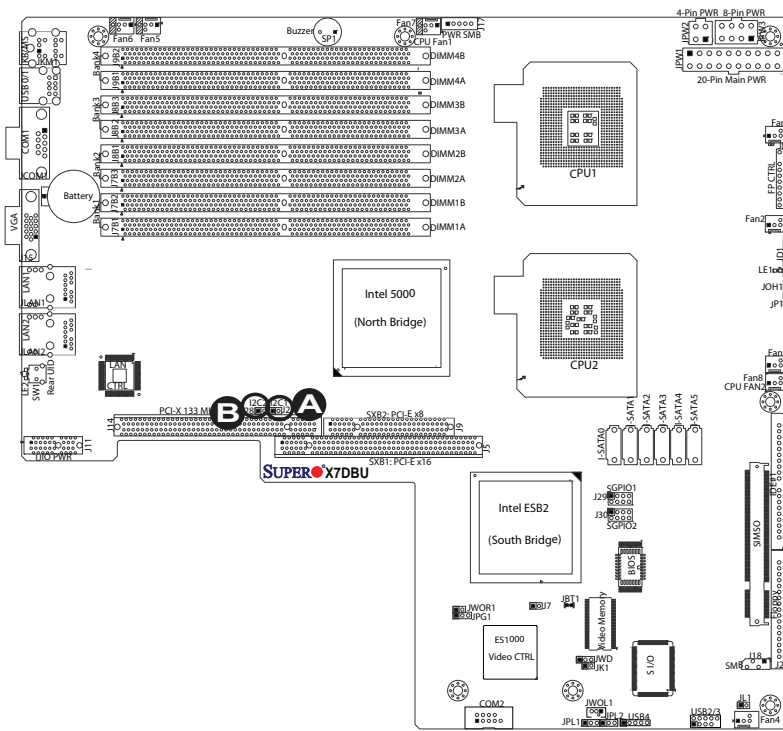

- A. JI²C1
- B. JI²C2

2-7 Onboard Indicators

GLAN LEDs

There are two GLAN ports on the motherboard. Each Gigabit Ethernet LAN port has two LEDs. The yellow LED indicates activity, while the Link LED may be green, amber or off to indicate the speed of the connection. See the tables at right for more information.

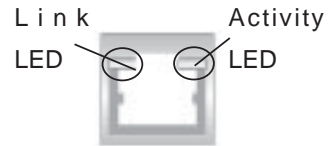

(Rear View: When viewing from the rear side of the system)

GLAN Activity Indicator Jumper Settings	
LED Color	Definition
Off	Not Active
Yellow	Blinking: Active

GLAN Link Indicator Jumper Settings	
LED Color	Definition
Off	No Connection or 10 Mbps
Green	100 Mbps
Amber	1 Gbps

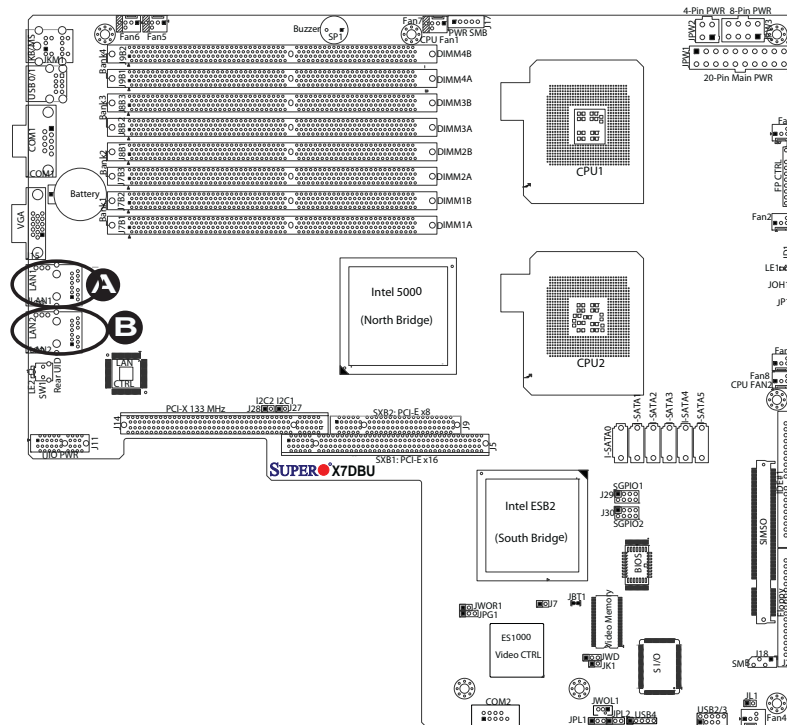

A. GLAN Port1 LEDs

B. GLAN Port2 LEDs

Onboard Power LED (LE1)

There is an Onboard Power LED (LE1) located on the motherboard. When LE1 is off, the system is off. When the green light is on, the system is on. See the layout below for the LED location.

Onboard PWR LED Indicator (LE1)	
LED Color	Definition
Off	System Off (*PWR cable not connected)
Green	System On
Green: Flashing Quickly	ACPI S1 State
Green: Flashing Slowly	ACPI S3 (STR) State

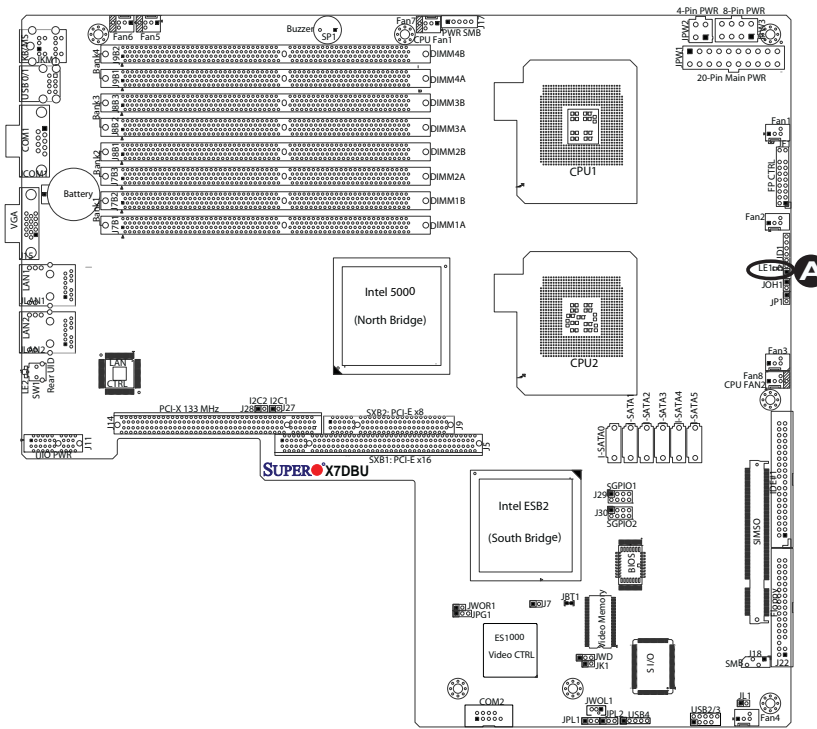

A. PWR LED

2-8 Floppy Drive, Hard Disk Drive, SIMSO-DIMM IPMI and SCSI Connections

Note the following when connecting the floppy and hard disk drive cables:

- The floppy disk drive cable has seven twisted wires.
- A red mark on a wire typically designates the location of pin 1.
- A single floppy disk drive ribbon cable has two connectors to provide for two floppy disk drives. The connector with twisted wires always connects to drive A, and the connector that does not have twisted wires always connects to drive B.

Floppy Connector

The floppy connector is located at J22. See the table below for pin definitions.

Floppy Drive Connector Pin Definitions (Floppy)			
Pin#	Definition	Pin #	Definition
1	Ground	2	FDHDIN
3	Ground	4	Reserved
5	Key	6	FDEDIN
7	Ground	8	Index
9	Ground	10	Motor Enable
11	Ground	12	Drive Select B
13	Ground	14	Drive Select B
15	Ground	16	Motor Enable
17	Ground	18	DIR
19	Ground	20	STEP
21	Ground	22	Write Data
23	Ground	24	Write Gate
25	Ground	26	Track 00
27	Ground	28	Write Protect
29	Ground	30	Read Data
31	Ground	32	Side 1 Select
33	Ground	34	Diskette

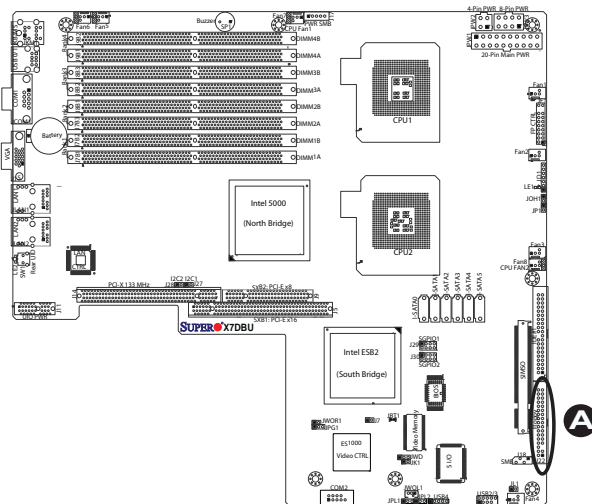

A. Floppy Port

SIMSO IPMI Slot

There is a SIM SO-DIMM IPMI (Intelligent Platform Management Interface) Slot on the motherboard. Refer to the layout below for the location of SIMSO slot.

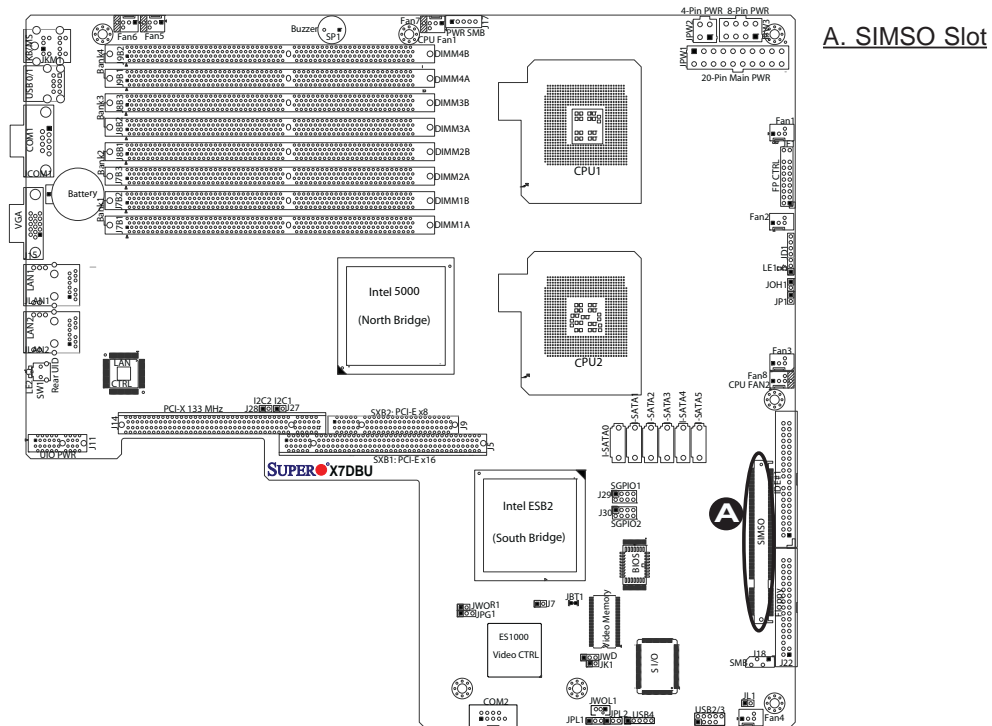

IDE Connector

An IDE Connector is located at JIDE1 on the motherboard. See the table on the right for pin definitions.

IDE Drive Connectors Pin Definitions			
Pin#	Definition	Pin #	Definition
1	Reset IDE	2	Ground
3	Host Data 7	4	Host Data 8
5	Host Data 6	6	Host Data 9
7	Host Data 5	8	Host Data 10
9	Host Data 4	10	Host Data 11
11	Host Data 3	12	Host Data 12
13	Host Data 2	14	Host Data 13
15	Host Data 1	16	Host Data 14
17	Host Data 0	18	Host Data 15
19	Ground	20	Key
21	DRQ3	22	Ground
23	I/O Write	24	Ground
25	I/O Read	26	Ground
27	IOCHRDY	28	BALE
29	DACK3	30	Ground
31	IRQ14	32	IOCS16
33	Addr1	34	Ground
35	Addr0	36	Addr2
37	Chip Select 0	38	Chip Select 1
39	Activity	40	Ground

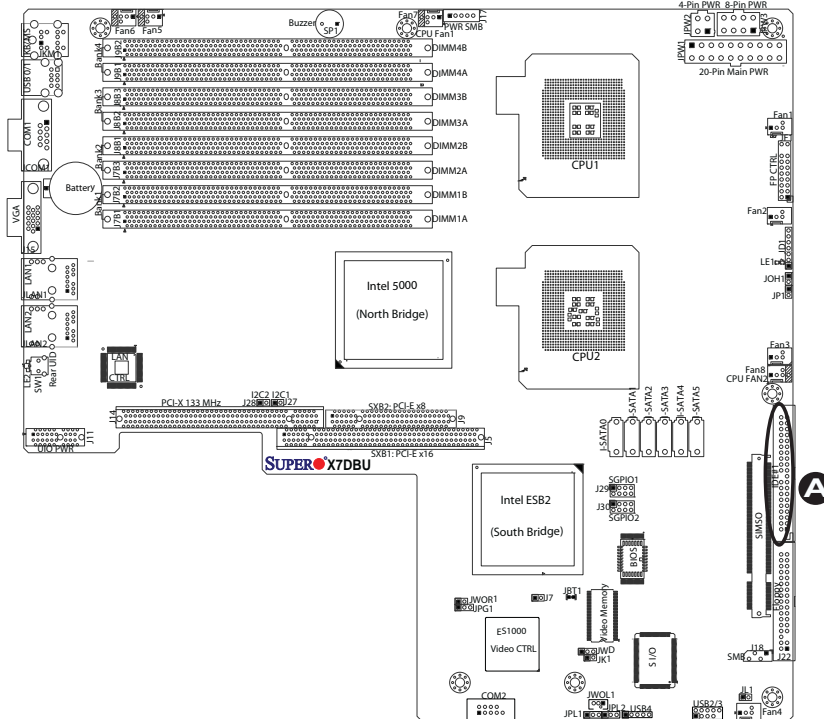

A. IDE#1

SXB1/SXB2 Slots

SXB1(J5) and SXB2 (J9) are specially designed for Supermicro's riser cards. These two slots are to be used with riser cards. When used with riser cards, the left IO slot (SXB1) supports one PCI-E x8 and one UIO devices; while the right IO slots (PCI-X: J14 and SXB2) can support a PCI-E x8 **or** a PCI-X 133MHz device. Refer to the layout below for the location.

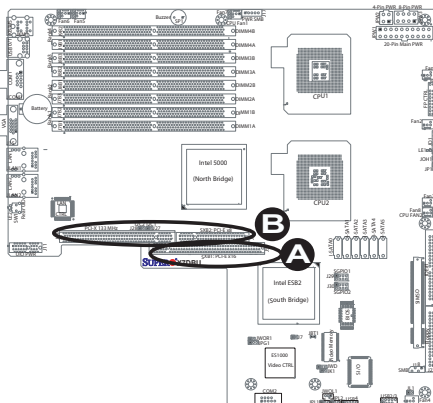

A. SXB1 (the left slot)

B. SXB2 (the right slots)

Chapter 3

Troubleshooting

3-1 Troubleshooting Procedures

Use the following procedures to troubleshoot your system. If you have followed all of the procedures below and still need assistance, refer to the 'Technical Support Procedures' and/or 'Returning Merchandise for Service' section(s) in this chapter.

Note: Always disconnect the power cord before adding, changing or installing any hardware components.

Before Power On

1. Make sure that there are no short circuits between the motherboard and chassis.
2. Disconnect all ribbon/wire cables from the motherboard, including those for the keyboard and mouse.
3. Remove all add-on cards.
4. Install one CPU (making sure it is fully seated) and connect the chassis speaker and the power LED to the motherboard. (Check all jumper settings as well.)
5. Use only the correct type of CMOS onboard battery as recommended by the Manufacturer. Do not install the onboard battery upside down to avoid possible explosion.

No Power

1. Make sure that there are no short circuits between the motherboard and chassis.
2. Verify that all jumpers are set to their default positions.
3. Check that the 115V/230V switch on the power supply is properly set.
4. Turn the power switch on and off to test the system.
5. The battery on your motherboard may be old. Check to verify that it still supplies ~3VDC. If it does not, replace it with a new one.

No Video

1. If the power is on but you have no video, remove all the add-on cards and memory modules.
2. Use the speaker to determine if any beep codes exist. Refer to Appendix A and Appendix B for details on beep codes.

Losing the System's Setup Configuration

1. Make sure that you are using a high quality power supply. A poor quality power supply may cause the system to lose the CMOS setup information. Refer to Section 1-6 for details on recommended power supplies.
-

2. The battery on your motherboard may be old. Check to verify that it still supplies ~3VDC. If it does not, replace it with a new one.
3. If the above steps do not fix the Setup Configuration problem, contact your vendor for repairs.

NOTE

If you are a system integrator, VAR or OEM, a POST diagnostics card is recommended. For I/O port 80h codes, refer to App. B.

Memory Errors

1. Make sure that the DIMM modules are properly and fully installed.
2. Determine if different speeds of DIMMs have been installed and verify that the BIOS setup is configured for the fastest speed of RAM used. It is recommended that you use the same RAM speed for all DIMMs in the system.
3. Make sure that you are using the correct type of DDR2 FBD (Fully Buffered) ECC 667/533 SDRAM (*recommended by the manufacturer.)
4. Check for bad DIMM modules or slots by swapping a single module between four slots and noting the results.
5. Make sure that all memory modules are fully seated in their slots. To install memory modules, begin with Branch 1, then Branch 2, and so on (see Page 2-6).

3-2 Technical Support Procedures

Before contacting Technical Support, please take the following steps. Also, note that as a motherboard manufacturer, Super Micro does not sell directly to end-users, so it is best to first check with your distributor or reseller for troubleshooting services. They should know of any possible problem(s) with the specific system configuration that was sold to you.

1. Please go through the 'Troubleshooting Procedures' and 'Frequently Asked Question' (FAQ) sections in this chapter or see the FAQs on our web site (<http://www.supermicro.com/support/faqs/>) before contacting Technical Support.
2. BIOS upgrades can be downloaded from our web site at (<http://www.supermicro.com/support/bios/>)

Note: Not all BIOS can be flashed; it depends on the modifications to the boot block code.

3. If you still cannot resolve the problem, include the following information when

contacting Super Micro for technical support:

- Motherboard model and PCB revision number
- BIOS release date/version (this can be seen on the initial display when your system first boots up)
- System configuration

An example of a Technical Support form is on our web site at (<http://www.supermicro.com/support/contact.cfm>).

4. Distributors: For immediate assistance, please have your account number ready when placing a call to our technical support department. We can be reached by e-mail at support@supermicro.com or by fax at: (408) 503-8000, option 2.

3-3 Frequently Asked Questions

Question: What are the various types of memory that my motherboard can support?

Answer: The X7DBU/X7DGU has eight 240-pin DIMM slots that support DDR2 FBD ECC 667/533 SDRAM modules. It is strongly recommended that you do not mix memory modules of different speeds and sizes.

Question: How do I update my BIOS?

Answer: It is recommended that you do not upgrade your BIOS if you are not experiencing any problems with your system. Updated BIOS files are located on our web site at <http://www.supermicro.com/support/bios/>. Please check our BIOS warning message and the information on how to update your BIOS on our web site. Select your motherboard model and download the BIOS file to your computer. Also, check the current BIOS revision and make sure that it is newer than your BIOS before downloading. You can choose from the zip file and the .exe file. If you choose the zip BIOS file, please unzip the BIOS file onto a bootable device or a USB  Run the batch file using the format flash.bat filename.rom from your bootable device or USB pen to flash the BIOS. Then, your system will automatically reboot. If you choose the .exe file, please run the .exe file under Windows to create the BIOS flash floppy disk. Insert the floppy disk into the system you wish to flash the BIOS. Then, bootup the system to the floppy disk. The BIOS utility will automatically flash the BIOS without any prompts. Please note that this process may take a few minutes to complete. Do not be concerned if the screen is paused for a few minutes.

(***Warning:** Do not shut down or reset the system while updating BIOS to prevent possible system boot failure!)

Question: What's on the CD that came with my motherboard?

Answer: The supplied compact disc has quite a few drivers and programs that will greatly enhance your system. We recommend that you review the CD and install the applications you need. Applications on the CD include chipset drivers for the Windows OS, security and audio drivers.

3-4 Returning Merchandise for Service

A receipt or copy of your invoice marked with the date of purchase is required before any warranty service will be rendered. You can obtain service by calling your vendor for a Returned Merchandise Authorization (RMA) number. When returning to the manufacturer, the RMA number should be prominently displayed on the outside of the shipping carton, and mailed prepaid or hand-carried. Shipping and handling charges will be applied for all orders that must be mailed when service is complete. For faster service, RMA authorizations may be requested online (<http://www.supermicro.com/support/rma>).

This warranty only covers normal consumer use and does not cover damages incurred in shipping or from failure due to the alternation, misuse, abuse or improper maintenance of products.

During the warranty period, contact your distributor first for any product problems.

Chapter 4

BIOS

4-1 Introduction

This chapter describes the Phoenix BIOS™ Setup utility for the X7DBU/X7DGU. The Phoenix ROM BIOS is stored in a flash chip and can be easily upgraded using a floppy disk-based program.

Note: Due to periodic changes to the BIOS, some settings may have been added or deleted and might not yet be recorded in this manual. Please refer to the Manual Download area of the Supermicro web site <<http://www.supermicro.com>> for any changes to the BIOS that may not be reflected in this manual.

System BIOS

The BIOS is the Basic Input Output System used in all IBM® PC, XT™, AT®, and PS/2® compatible computers. The Phoenix BIOS stores the system parameters, types of disk drives, video displays, etc. in the CMOS. The CMOS memory requires very little electrical power. When the computer is turned off, a backup battery provides power to the CMOS Logic, enabling it to retain system parameters. Each time the computer is powered on the computer is configured with the values stored in the CMOS Logic by the system BIOS, which gains control at boot up.

How To Change the Configuration Data

The CMOS information that determines the system parameters may be changed by entering the BIOS Setup utility. This Setup utility can be accessed by pressing the <Delete> key at the appropriate time during system boot. (See below.)

Starting the Setup Utility

Normally, the only visible POST (Power On Self Test) routine is the memory test. As the memory is being tested, press the <Delete> key to enter the main menu of the BIOS Setup utility. From the main menu, you can access the other setup screens, such as the Security and Power menus. Beginning with Section 4-3, detailed descriptions are given for each parameter setting in the Setup utility.



Warning: Do not shut down or reset the system while updating BIOS to prevent possible boot failure.

4-2 Running Setup

**Default settings are in bold text unless otherwise noted.*

The BIOS setup options described in this section are selected by choosing the appropriate text from the main BIOS Setup screen. All displayed text is described in this section, although the screen display is often all you need to understand how to set the options (See the next page).

When you first power on the computer, the Phoenix BIOS™ is immediately activated.

While the BIOS is in control, the Setup program can be activated in one of two ways:

1. By pressing <Delete> immediately after turning the system on, or
2. When the message shown below appears briefly at the bottom of the screen during the POST (Power On Self-Test), press the <Delete> key to activate the main Setup menu:

Press the <Delete> key to enter Setup

4-3 Main BIOS Setup

All main Setup options are described in this section. The main BIOS Setup screen is displayed below.

Use the Up/Down arrow keys to move among the different settings in each menu. Use the Left/Right arrow keys to change the options for each setting.

Press the <Esc> key to exit the CMOS Setup Menu. The next section describes in detail how to navigate through the menus.

Items that use submenus are indicated with the ► icon. With the item highlighted, press the <Enter> key to access the submenu.

Main BIOS Setup Menu

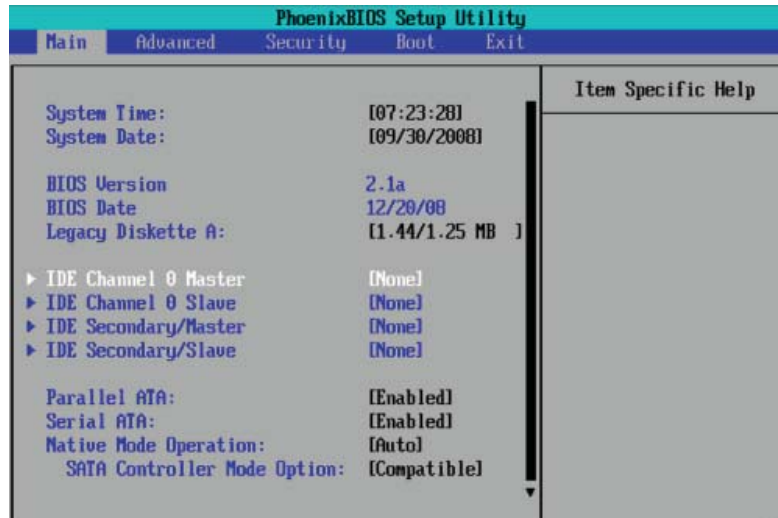

Main Setup Features

System Time

To set the system date and time, key in the correct information in the appropriate fields. Then press the <Enter> key to save the data.

System Date

Using the arrow keys, highlight the month, day and year fields, and enter the correct data. Press the <Enter> key to save the data.

BIOS Version

This field displays the version number of current BIOS.

BIOS Date

This field displays the date when this version of BIOS was built.

Legacy Diskette A

This setting allows the user to set the type of floppy disk drive installed as diskette A. The options are Disabled, 360Kb 5.25 in, 1.2MB 5.25 in, 720Kb 3.5 in, **1.44/1.25MB**, 3.5 in and 2.88MB 3.5 in.

► IDE Channel 0 Master/Slave and Secondary IDE Master/Slave

These settings allow the user to set the parameters of IDE Channel 0 Master/Slave and Secondary IDE Master/Slave slots. Press <Enter> to activate the following submenu items for detailed options. Set the correct configurations accordingly. The items included in the submenu are:

Type

Selects the type of IDE hard drive. The option **Auto** will allow the BIOS to automatically configure the parameters of the HDD installed at the connection. Enter a number between 1 to 39 to select a predetermined HDD type. Select **User** to allow the user to enter the parameters of the HDD installed. Select **CDROM** if a CDROM drive is installed. Select **ATAPI** if a removable disk drive is installed.

Multi-Sector Transfers

This item allows the user to specify the number of sectors per block to be used in multi-sector transfer. The options are **Disabled**, 4 Sectors, 8 Sectors, and 16 Sectors.

LBA Mode Control

This item determines whether the Phoenix BIOS will access the IDE Channel 0 Master Device via the LBA mode. The options are **Enabled** and **Disabled**.

32 Bit I/O

This option allows the user to enable or disable the function of 32-bit data transfer. The options are **Enabled** and **Disabled**.

Transfer Mode

This option allows the user to set the transfer mode. The options are **Standard**, **Fast PIO1**, **Fast PIO2**, **Fast PIO3**, **Fast PIO4**, **FPIO3/DMA1** and **FPIO4/DMA2**.

Ultra DMA Mode

This option allows the user to select Ultra DMA Mode. The options are **Disabled**, **Mode 0**, **Mode 1**, **Mode 2**, **Mode 3**, **Mode 4**, and **Mode 5**.

Parallel ATA

This setting allows the user to enable or disable the function of Parallel ATA. The options are **Enabled** and **Disabled**.

Serial ATA

This setting allows the user to enable or disable the function of Serial ATA. The options are **Disabled** and **Enabled**.

Native Mode Operation (Available when the item-SATA Controller Mode Operation indicated is set to Compatible.)

Select the native mode for the HDD drives. The options are: **Serial ATA**, and **Auto**.

SATA Controller Mode

Select **Compatible** to allow the SATA and PATA drives to be automatically-detected

and be placed in the Legacy Mode by the BIOS. Select Enhanced to allow the SATA and PATA drives to be automatically-detected and be placed in the Native IDE Mode. (**Note: The Enhanced mode is supported by the Windows 2000 OS or a later version.**)

When the SATA Controller Mode is set to Enhanced, the following items will display:

SATA RAID Enable (Available when the item-SATA Controller Mode Operation indicated is set to Enhanced.)

Select Enable to enable Serial ATA RAID Functions. (*For the Windows OS environment, use the RAID driver if this feature is set to Enabled. When this item is set to Enabled, the item: "ICH RAID Code Base" will be available for you to select either Intel or Adaptec Host RAID firmware. If this item is set to **Disabled**, the item-SATA AHCI Enable will be available.) The options are Enabled and **Disabled**.

ICH RAID Code Base (Available when SATA RAID is Enabled.)

Select Intel to enable Intel's SATA RAID firmware. Select Adaptec to use Adaptec's HostRAID firmware. The options are **Intel** and Adaptec.

SATA AHCI (Available when SATA RAID is Disabled.)

Select Enable to enable the function of Serial ATA Advanced Host Interface. (*Take caution when using this function. This feature is for advanced programmers only. The options are Enabled and **Disabled**.)

System Memory

This display informs you how much system memory is detected by the BIOS.

Extended Memory

This display informs you how much extended memory is detected by the BIOS.

4-4 Advanced Setup

Choose Advanced from the Phoenix BIOS Setup Utility main menu with the arrow keys. You should see the following display. The items with a triangle beside them have submenus that can be accessed by highlighting the item and pressing <Enter>.

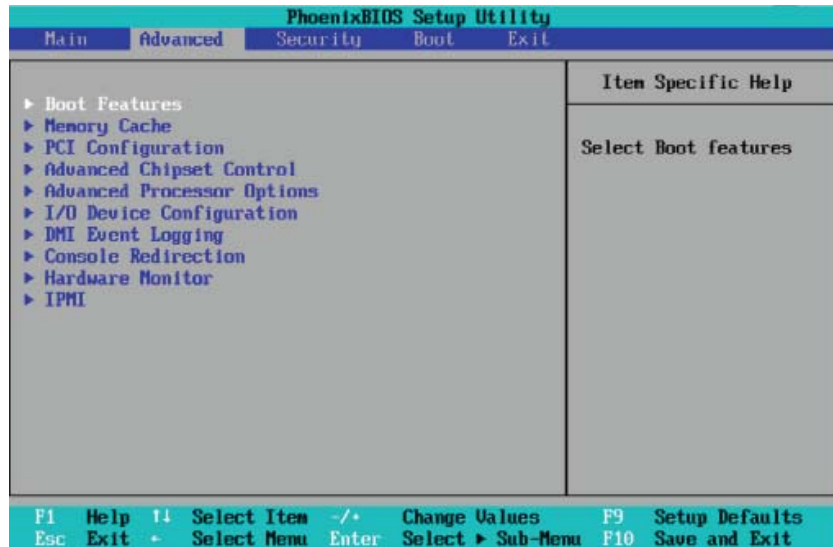

► Boot Features

Access the submenu to make changes to the following settings.

QuickBoot Mode

If enabled, this feature will speed up the POST (Power On Self Test) routine by skipping certain tests after the computer is turned on. The settings are **Enabled** and Disabled. If Disabled, the POST routine will run at normal speed.

QuietBoot Mode

This setting allows you to **Enable** or Disable the graphic logo screen during boot-up.

POST Errors

Set to **Enabled** to display POST Error Messages if an error occurs during bootup. If set to Disabled, the system will continue to boot without displaying any error messages even when a boot error occurs.

ACPI Mode

Use the setting to determine if you want to employ ACPI (Advanced Configuration and Power Interface) power management on your system. The options are **Yes** and No.

Power Button Behavior

If set to **Instant-Off**, the system will power off immediately as soon as the user hits the power button. If set to 4-sec., the system will power off when the user

presses the power button for 4 seconds or longer. The options are **instant-off** and 4-sec override.

Resume On Modem Ring

Select On to “wake your system up” when an incoming call is received by your modem. The options are On and **Off**.

Power Loss Control

This setting allows you to choose how the system will react when power returns after an unexpected loss of power. The options are Stay Off, Power On, and **Last State**.

Watch Dog

If enabled, this option will automatically reset the system if the system is not active for more than 5 minutes. The options are Enabled and **Disabled**.

Summary Screen

This setting allows you to **Enable** or Disable the summary screen which displays the system configuration during bootup.

► Memory Cache

Cache System BIOS Area

This setting allows you to designate a reserve area in the system memory to be used as a System BIOS buffer to allow the BIOS to write (cache) data into this reserved memory area. Select **Write Protect** to enable this function, and this area will be reserved for BIOS ROM access only. Select Uncached to disable this function and make this area available for other devices.

Cache Video BIOS Area

This setting allows you to designate a reserve area in the system memory to be used as a Video BIOS buffer to allow the BIOS to write (cache) data into this reserved memory area. Select **Write Protect** to enable the function and this area will be reserved for Video BIOS ROM access only. Select Uncached to disable this function and make this area available for other devices.

Cache Base 0-512K

If enabled, this feature will allow the data stored in the base memory area: block 0-512K to be cached (written) into a buffer, a storage area in Static DROM (SDROM) or to be written into L1, L2 cache inside the CPU to speed up CPU operations. Select Uncached to disable this function. Select Write Through to allow data to be cached into the buffer and written into the system memory at the same time.

Select Write Protect to prevent data from being written into the base memory area of Block 0-512K. Select Write Back to allow CPU to write data back directly from the buffer without writing data to the System Memory for fast CPU data processing and operation. The options are Uncached, Write Through, Write Protect, and **Write Back**.

Cache Base 512K-640K

If enabled, this feature will allow the data stored in the memory area: 512K-640K to be cached (written) into a buffer, a storage area in the Static DROM (SDROM) or written into L1, L2, L3 cache inside the CPU to speed up CPU operations. Select Uncached to disable this function. Select Write Through to allow data to be cached into the buffer and written into the system memory at the same time. Select Write Protect to prevent data from being written into the base memory area of Block 512-640K. Select Write Back to allow CPU to write data back directly from the buffer without writing data to the System Memory for fast CPU data processing and operation. The options are Uncached, Write Through, Write Protect, and **Write Back**.

Cache Extended Memory

If enabled, this feature will allow the data stored in the extended memory area to be cached (written) into a buffer, a storage area in Static DROM (SDROM) or written into L1, L2, L3 cache inside the CPU to speed up CPU operations. Select Uncached to disable this function. Select Write Through to allow data to be cached into the buffer and written into the system memory at the same time. Select Write Protect to prevent data from being written into the system memory area above 1MB. Select Write Back to allow CPU to write data back directly from the buffer without writing data to the System Memory for fast CPU data processing and operation. The options are Uncached, Write Through, Write Protect, and **Write Back**.

Discrete MTRR Allocation

If enabled, MTRRs (-Memory Type Range Registers) are configured as distinct, separate units and cannot be overlapped. Set to Enabled to enhance graphic performance when using a Linux graphic driver that requires write-combining configuration with 4GB or more memory. The options are Enabled and **Disabled**.

► PCI Configuration

Access the submenu to make changes to the following settings for PCI devices.

Onboard GLAN1/Onboard GLAN2 (Gigabit- LAN) OPROM Configure

Enabling this option provides the capability to boot from the GLAN port specified. The options are **Disabled** and Enabled.

Default Primary Video Adapter

This feature allows the user to specify which video adapter to be used as the default primary video adapter--the onboard video adapter or others. The options are Other and **Onboard Video**.

Emulated IRQ Solutions

When this item is set to Enabled, Emulated IRQ Scheme allows PCI devices to run on legacy operating systems that use the MSI mechanism to generate INTX compatible interrupts. The options are **Disabled** and Enabled.

PCI-Exp. I/O Performance

Some add-on cards perform faster with the coalesce feature, which limits the payload size to 128 Bytes; while others perform faster with a payload size of 256 Bytes which inhibits coalesce features. Please refer to your add-on card user guide for the desired setting. The options are Payload (256 Bytes) and **Coalesce Enabled (128 Bytes)**.

PCI Parity Error Forwarding

The feature allows SERR and PERR errors detected in PCI slots to be sent (forwarded) to the BIOS DMI Event Log for the user to review. The options are Enabled and **Disabled**.

ROM Scan Ordering

This feature allows the user to decide which Option ROM to be activated first. The options are **Onboard first** and Add-On first.

PCI Fast Delayed Transaction

Enable this function to improve DMA data transfer rate for a PCI 32-bit multimedia card. The options are Enable and **Disabled**.

Reset Configuration Data

If set to Yes, this setting clears the Extended System Configuration Data- (ESCD) area. The options are Yes and **No**.

Frequency for PCI-X#2

This option allows the user to change the bus frequency for the devices installed in the slot indicated. The options are **Auto**, PCI 33 MHz, PCI 66 MHz, PCI-X 66 MHz, PCI-X 100 MHz and PCI-X 133 MHz.

►L1 Blue Slot PCI-Exp. x8, L2 Slot PCI-Exp. x8, R1 Slot PCI-X 133 MHz, R2 Slot PCI-Exp. x8/x4 and R3 Slot PCI-Exp. x4

Access the submenu for each of the settings above to make changes to the following:

Option ROM Scan

When enabled, this setting will initialize the device expansion ROM. The options are **Enabled** and Disabled.

Enable Master

This setting allows you to enable the selected device as the PCI bus master. The options are **Enabled** and Disabled.

Latency Timer

This setting allows you to set the clock rate for Bus Master. A high-priority, high-throughput device may benefit from a greater clock rate. The options are **Default**, 0020h, 0040h, 0060h, 0080h, 00A0h, 00C0h, and 00E0h. For Unix, Novell and other Operating Systems, please select the option: other. If a drive fails after the installation of a new software, you might want to change this setting and try again. A different OS requires a different Bus Master clock rate.

Large Disk Access Mode

This setting determines how large hard drives are to be accessed. The options are **DOS** or Other (for Unix, Novelle NetWare and other operating systems).

►Advanced Chipset Control

Access the submenu to make changes to the following settings.



Warning: Take caution when changing the Advanced settings. An incorrect setting, a very high DRAM frequency or an incorrect DRAM timing may cause the system to become unstable. When this occurs, reset the setting to the default setting.

SERR Signal Condition

This setting specifies the ECC Error conditions that an SERR# is to be asserted. The options are None, **Single Bit**, Multiple Bit, and Both.

J5 Slot Link Width

Use this feature to configure Link Width settings for the devices connected to PCI-E Slot J5. After changing the Link Width setting, please reboot the system for the new Link Width setting to take effect. The options are One (Connection) in x 16 and **Two in x 8**.

4GB PCI Hole Granularity

This feature allows you to select the granularity of PCI hole for PCI slots. If MTRRs are not enough, this option may be used to reduce MTRR occupation. The options are: **256 MB**, 512 MB, 1GB and 2GB.

Memory Branch Mode

This option determines how the two memory branches operate. System address space can either be interleaved between the two branches or Sequential from one branch to another. Mirror mode allows data correction by maintaining two copies of data in two branches. Single Channel 0 allows a single DIMM population during system manufacturing. The options are **Interleave**, Sequential, Mirroring, and Single Channel 0.

Branch 0/1 Rank Interleaving & Sparing

Select enable to enable the functions of Memory Interleaving and Memory Sparing for Branch 0/1 Rank. The options for Memory Interleaving are 1:1, 2:1 and **4:1**. The options for Sparing are Enabled and **Disabled**.

Enhanced x8 Detection

Select **Enabled** to enable Enhanced x8 DRAM UC Error Detection. The options are Disabled and **Enabled**.

High Temperature DRAM Operation

When set to Enabled, the BIOS will refer to the SPD table to set the maximum DRAM temperature. If disabled, the BIOS will set the maximum DRAM temperature based on a predefined value. The options are Enabled and **Disabled**.

AMB Thermal Sensor

Select Enabled to activate the thermal sensor embedded in the Advanced Memory Buffer on a fully buffered memory module for thermal monitoring. The options are **Disabled** and Enabled.

Thermal Throttle

Select Enabled to enable closed-loop thermal throttling on a fully buffered (FBD) memory module. In the closed-loop thermal environment, thermal throttling will be activated when the temperature of the FBD DIMM module exceeds a predefined threshold. The options are Enabled and **Disabled**.

Global Activation Throttle

Select Enabled to enable open-loop global thermal throttling on a fully buffered (FBD) memory module to make it active whenever the number of activate control exceeds a predefined number. The options are Enabled and **Disabled**.

Crystal Beach Features

This feature was designed to implement Intel's I/O AT (Acceleration Technology) to accelerate the performance of TOE devices. (**Note:** A TOE device is a specialized, dedicated processor that is installed on an add-on card or a network card to handle some or all packet processing of the add-on card. For this motherboard, the TOE device is built inside the ESB 2 South Bridge chip.) The options are **Enabled** and Disabled.

Route Port 80h Cycles to

This feature allows the user to decide which bus to send debug information to. The options are PCI and **LPC**.

Clock Spectrum Feature

If Enabled, the BIOS will monitor the level of Electromagnetic Interference caused by the components and will attempt to decrease the interference whenever needed. The options are Enabled and **Disabled**.

High Precision Event Time

Select Yes to activate the High Precision Event Timer (HPET), which is capable of producing periodic interrupts at a much higher frequency than a Real-time Clock (RTC) can in synchronizing multimedia streams, providing smooth playback and reducing the dependency on other timestamp calculation devices, such as an x86 RDTSC Instruction embedded in a CPU. The High Precision Event Timer is used to replace the 8254 Programmable Interval Timer. The options are Yes and **No**.

USB Function

Select Enabled to enable the function of USB devices specified. The settings are **Enabled** and Disabled.

Legacy USB Support

This setting allows you to enable support for Legacy USB devices. The settings are **Enabled** and Disabled.

► Advanced Processor Options

Access the submenu to make changes to the following settings.

CPU Speed

This is a display that indicates the speed of the installed processor.

Frequency Ratio (Available when supported by the CPU.)

The feature allows the user to set the internal frequency multiplier for the CPU. The options are: **Default** and x12.

Core-Multi-Processing (Available when supported by the CPU.)

Set to Enabled to use a processor's Second Core and beyond. (Please refer to Intel's website for more information.) The options are Disabled and **Enabled**.

Machine Checking (Available when supported by the CPU.)

Set to Enabled to use this function which will allow the CPU to detect and report hardware (machine) errors via a set of model-specific registers (MSRs). The options are Disabled and **Enabled**.

Thermal Management 2 (Available if supported by the CPU.)

Set to **Enabled** to use Thermal Management 2 (TM2) which will lower CPU voltage and frequency when the CPU temperature reaches a predefined overheat threshold. Set to Disabled to use Thermal Manager 1 (TM1), allowing CPU clocking to be regulated via CPU Internal Clock modulation when the CPU temperature reaches the overheat threshold. The options are Disabled and **Enabled**.

C1 Enhanced Mode (Available when supported by the CPU.)

Set to Enabled to enable Enhanced Halt State to lower CPU voltage/frequency to prevent overheat. The options are Enabled and **Disabled**. (**Note:** please refer to Intel's web site for detailed information.)

Execute Disable Bit (Available when supported by the CPU.)

Set to Enabled to allow the processor to classify areas in memory where an application code can execute and where it cannot, and thus preventing a worm or a virus from inserting and creating a flood of codes to overwhelm the processor or damage the system during an attack. (**Note:** this feature is available when your OS and your CPU support the function of Execute Disable Bit.) The options are **Disabled** and Enabled. (**Note:** For more information regarding hardware/software support for this function, please refer to Intel's and Microsoft's web sites.)

Adjacent Cache Line Prefetch (Available when supported by the CPU.)

The CPU fetches the cache line for 64 bytes if this option is set to Disabled. The CPU fetches both cache lines for 128 bytes as comprised if Enabled. The default settings are **Disabled** for the Intel 5100 Series Processors and Enable for the 5000 Series Processors.

Hardware Prefetcher (Available when supported by the CPU.)

Set to **Enabled** to activate the hardware components that are used in conjunction with software programs to prefetch data in order to shorten execution cycles and maximize data processing efficiency. The options are Disabled and **Enabled**.

Direct Cache Access (Available when supported by the CPU.)

Set to Enable to route inbound network IO traffic directly into processor caches to reduce memory latency and improve network performance. The options are Enabled and **Disabled**. If this item is set to Enabled, the following item will display.

DCA Delay Clocks (Available if supported by the CPU.)

This feature allows the user to set the clock delay setting from snoop to prefetch for Direct Cache Access. Select a setting from 8 (bus cycles) to 120 (bus cycles) (in 8-cycle increment). The default setting is **32** (bus cycles).

Intel <R> Virtualization Technology (Available when supported by the CPU.)

Select Enabled to use the feature of Virtualization Technology to allow one platform to run multiple operating systems and applications in independent partitions, creating multiple "virtual" systems in one physical computer. The options are Enabled and **Disabled**. (**Note:** If there is any change to this setting, you will need to power off and restart the system for the change to take effect.) Please refer to Intel's web site for detailed information.

Intel EIST Support (Available when supported by the CPU.)

Select Enabled to use the Enhanced Intel SpeedStep Technology and allow the system to automatically adjust processor voltage and core frequency in an effort to reduce power consumption and heat dissipation. The options are Enabled and **Disabled**. Please refer to Intel's web site for detailed information.

► I/O Device Configuration

Access the submenu to make changes to the following settings.

KBC Clock Input

This setting allows you to select clock frequency for the Keyboard Controller. The options are 6MHz, 8MHz, **12MHz**, and 16MHz.

Serial Port A

This setting allows you to decide how Serial Port A is controlled by the system. The options are **Enabled** (user defined), Disabled, and Auto (BIOS- or OS-controlled).

Base I/O Address

This setting allows you to select the base I/O address for Serial Port A. The options are **3F8**, 2F8, 3E8, and 2E8.

Interrupt

This setting allows you to select the IRQ (interrupt request) for Serial Port A. The options are IRQ3 and **IRQ4**.

Serial Port B

This setting allows you to decide how Serial Port B is controlled by the system. The options are **Enabled** (user defined), Disabled, Auto (BIOS controlled) and OS Controlled.

Mode

This setting allows you to set the type of device that will be connected to Serial Port B. The options are **Normal** and IR (for an infrared device).

Base I/O Address

This setting allows you to select the base I/O address for Serial Port B. The options are 3F8, **2F8**, 3E8 and 2E8.

Interrupt

This setting allows you to select the IRQ (interrupt request) for Serial Port B. The options are **IRQ3** and IRQ4.

Floppy Disk Controller

This setting allows you to decide how Floppy Disk Controller is managed by the system. The options are **Enabled** (user defined), Disabled, and Auto (BIOS and OS controlled).

Base I/O Address

This setting allows you to select the base I/O address for the Floppy port. The options are **Primary** and Secondary.

► DMI Event Logging

Access the submenu to make changes to the following settings.

Event Log Validity

This is a display to inform you of the event log validity. It is not a setting.

Event Log Capacity

This is a display to inform you of the event log capacity. It is not a setting.

View DMI Event Log

Highlight this item and press <Enter> to view the contents of the event log.

Event Logging

This setting allows you to **Enable** or Disable event logging.

ECC Event Logging

This setting allows you to **Enable** or Disable ECC event logging.

Mark DMI Events as Read

Highlight this item and press <Enter> to mark the DMI events as read.

Clear All DMI Event Logs

Select Yes and press <Enter> to clear all DMI event logs. The options are Yes and **No**.

► Console Redirection

Access the submenu to make changes to the following settings.

COM Port Address

This item allows you to specify which COM port to direct the remote console to: Onboard COM A or Onboard COM B. This setting can also be **Disabled**.

BAUD Rate

This item allows you to set the BAUD rate for console redirection. The options are 300, 1200, 2400, 9600, **19.2K**, 38.4K, 57.6K, and 115.2K.

Console Type

This item allows you to set console redirection type. The options are VT100, VT100,8bit, PC-ANSI, 7bit, **PC ANSI**, VT100+, VT-UTF8 and ASCII.

Flow Control

This item allows you to select the flow control option for console redirection. The options are: None, XON/XOFF, and **CTS/RTS**.

Console Connection

This item allows you to decide how console redirection is to be connected: either **Direct** or Via Modem.

Continue CR after POST

This item allows you to decide if you want to continue with console redirection after the POST routine. The options are On and **Off**.

► Hardware Monitor

This feature allows the user to monitor system health and review the status of each item as displayed.

Overheat Alarm

This option allows the user to select the CPU Overheat Alarm setting which determines when the CPU OH alarm will be activated to provide warning of possible CPU overheat.



Warning! 1. Any temperature that exceeds the CPU threshold temperature predefined by the CPU manufacturer may result in CPU overheat or system instability. When the CPU temperature reaches this predefined threshold, the CPU and system cooling fans will run at full speed.

2. To avoid possible system overheating, please be sure to provide adequate airflow to your system.

The options are:

- **Early Alarm:** Select this setting if you want the CPU overheat alarm (including the LED and the buzzer) to be triggered as soon as the CPU temperature reaches the CPU overheat threshold as predefined by the CPU manufacturer.
- **Default Alarm:** Select this setting if you want the CPU overheat alarm (including the LED and the buzzer) to be triggered when the CPU temperature reaches about 5°C above the threshold temperature as predefined by the CPU manufacturer to give the CPU and system fans additional time needed for CPU and system cooling. In both the alarms above, please take immediate action as shown below.

PECI Agent 1/2 (Temperatures)/System Temperature



Note: The following item display temperature readings for the PEFI Agents and the system. These items are displayed for your reference only.

PECI (Platform Environment Control Interface) Agent 1/PECI Agent 2

These features will display the temperature readings for PEFI Agent 1 and PEFI Agent 2 as detected by the BIOS:

Low – This level is considered as the ‘normal’ operating state. The PEFI Agent temperature is well below its ‘Temperature Tolerance’. The cooling fans and PEFI Agent will run normally as configured in the BIOS (Fan Speed Control). User intervention: No action required.

Medium – The PEFI Agent is running warmer. This is a ‘precautionary’ level and generally means that there may be factors contributing to this condition, but

the PECI Agent is still within its normal operating state and below its 'Temperature Tolerance'. The cooling fans will run normally as configured in the BIOS. The fans may adjust to a faster speed depending on the Fan Speed Control settings.

User intervention: No action is required. However, consider checking the cooling fans and the chassis ventilation for blockage.

High – The PECI Agent is running hot. This is a 'caution' level since the PECI Agent's 'Temperature Tolerance' has been reached (or has been exceeded) and may activate an overheat alarm. The system may shut down if it continues for a long period to prevent damage to the PECI Agent.

User intervention: If the system buzzer and Overheat LED has activated, take action immediately by checking the system fans, chassis ventilation and room temperature to correct any problems.

System Temperature

This item displays the absolute system temperature status as detected by the BIOS:

Fan1-Fan8 Speeds

If the feature of Auto Fan Control is enabled, the BIOS will automatically display the status of the fans indicated in this item.

Fan Speed Control Modes

This feature allows the user to decide how the system controls the speeds of the onboard fans. The CPU temperature and the fan speed are correlative. When the CPU on-die temperature increases, the fan speed will also increase, and vice versa. If the option is set to 3-pin fan, the fan speed is controlled by voltage. If the option is set to 4-pin, the fan speed will be controlled by Pulse Width Modulation (PWM). Select 3-pin if your chassis came with 3-pin fan headers. Select 4-pin if your chassis came with 4-pin fan headers. Select Workstation if your system is used as a Workstation. Select Server if your system is used as a Server. Select Disable to disable fan speed control and allow the onboard fans to constantly run at full speed (12V). The Options are: 1. **Disable (running@Full Speed)**, 2. 3-pin (Server), 3. 3-pin (Workstation), 4. 4-pin (Server) and 5. 4-pin (Workstation).

Voltage Monitoring

The following items will be monitored and displayed:

Vcore A/Vcore B, -12V/+12V, P1V5/CPU_VTT/Vbat, +3.3V, 5Vsb/5VDD

► **IPMI** (The option is available only when an IPMI card is installed in the system.)

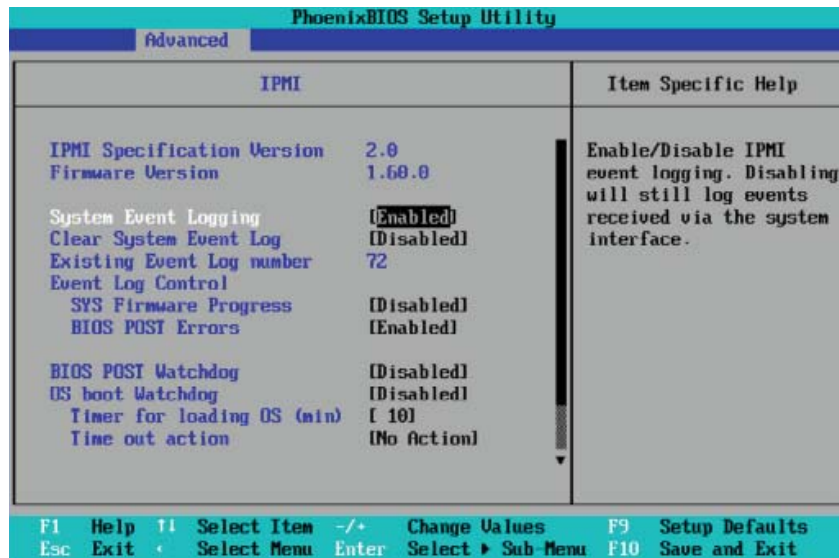

IPMI Specification Version: This item displays the current IPMI Version.

Firmware Version: This item displays the current Firmware Version.

System Event Logging

Select Enabled to enable IPMI Event Logging. When this function is set to Disabled, the system will continue to log events received via system interface. The options are **Enabled** and Disabled.

Clear System Event Logging

Enabling this function to force the BIOS to clear the system event logs during the next cold boot. The options are Enabled and **Disabled**.

Existing Event Log Number

This item displays the number of the existing event log.

Event Log Control

System Firmware Progress

Enabling this function to log POST progress. The options are Enabled and **Disabled**.

BIOS POST Errors

Enabling this function to log POST errors. The options are **Enabled** and Disabled.

BIOS POST Watch Dog

Set to Enabled to use the POST Watch Dog timer. The options are Enabled and **Disabled**.

OS Boot Watch Dog

Set to Enabled to enable OS Boot Watch Dog support. The options are Enabled and Disabled.

Timer for Loading OS (Minutes)

This feature allows the user to set the time value (in minutes) for the previous item: OS Boot Watch Dog by keying-in a desired number in the blank. The default setting is **10 (minutes.)** (Please ignore this option when OS Boot Watch Dog is set to Disabled.)

Time Out Option

This feature allows the user to determine what action to take in an event of a system boot failure. The options are **No Action**, Reset, Power Off and Power Cycles.

► System Event Log/System Event Log (List Mode)

These options display the System Event (SEL) Log and System Event (SEL) Log in List Mode. Items include: SEL (System Event Log) Entry Number, SEL Record ID, SEL Record Type, Time Stamp, Generator ID, SEL Message Revision, Sensor Type, Sensor Number, SEL Event Type, Event Description, and SEL Event Data.

PhoenixBIOS Setup Utility			
Advanced			
System Event Log (List mode)			
Event ID	Sensor Name	Sensor Type	Date/Time Stamp
▶ 0201	Fan4	Fan	000E13FF
	Lower Non-critical Going Low, Assertion		
▶ 0202	Fan4	Fan	000E13FF
	Lower Critical Going Low, Assertion		
▶ 0203	Fan4	Fan	000E13FF
	Lower Non-recoverable Going Low, Assertion		
▶ 0204	Fan5	Fan	000E13FF
	Lower Non-critical Going Low, Assertion		
▶ 0205	Fan5	Fan	000E13FF
	Lower Critical Going Low, Assertion		
▶ 0206	Fan5	Fan	000E13FF
	Lower Non-recoverable Going Low, Assertion		

F1	Help	↑	Select Item	-/*	Change Values	F9	Setup Defaults
Esc	Exit	*	Select Menu	Enter	Select ▶ Sub-Menu	F10	Save and Exit

► Realtime Sensor Data

This feature displays information from motherboard sensors, such as temperatures, fan speeds and voltages of various components.

PhoenixBIOS Setup Utility					
Advanced					
Realtime Sensor Data					
Sensor Type	Sensor Name	Sensor Data	Sensor Units	Lower Limit	Upper Limit
Temp	Sys Temp	29.00	degrees C	0.00	75.00
Voltage	CPU1 Ucore	1.20	Volts	0.91	1.61
	CPU2 Ucore	0.00	Volts	0.91	1.61
	3.3V	3.26	Volts	2.96	3.63
	5V	4.89	Volts	4.48	5.49
	12V	11.90	Volts	10.75	13.24
	-12V	-12.10	Volts	-13.19	-10.00
	1.5V	1.48	Volts	1.34	1.64

F1 Help F1 Select Item +/- Change Values F9 Setup Defaults
Esc Exit * Select Menu Enter Select ▶ Sub-Menu F10 Save and Exit

► IPMI LAN Configuration

The following features allow the user to configure and monitor IPMI LAN settings.

PhoenixBIOS Setup Utility	
Advanced	
IPMI Lan Configuration	Item Specific Help
ULAN Tagging	[Disabled]
ULAN ID	[1h]
IP Address Source	[DHCP]
IP Address	[192.168.001.030]
IP Subnet Mask	[255.255.255.000]
Default Gateway	[192.168.001.001]
MAC Address	[00h:30h:48h:5Fh:C3h:54h]
Update Lan Settings	[No]

F1 Help F1 Select Item +/- Change Values F9 Setup Defaults
Esc Exit * Select Menu Enter Select ▶ Sub-Menu F10 Save and Exit

VLAN Tagging

Select Enabled to enable Virtual LAN(s) for IPMI connections and allow the user to configure VLAN settings. The options are Enabled and **Disabled**.

VLAN ID

If VLAN Tagging above is set to Enabled, this item allows the user to change the VLAN ID. If VLAN Tagging is disabled, this item will be ignored by the firmware.

IP Address Source

Select the source of this machine's IP address. If Static is selected, you will need to know and enter manually the IP address of this machine below. If DHCP is selected, the BIOS will search for a DHCP (Dynamic Host Configuration Protocol) server in the network it is attached to, and request the next available IP address. The options are **DHCP** and Static.

IP Address

This item displays the IP address for the IPMI connection detected.

IP Subnet Mask

This item displays the IP Subnet Mask for the IPMI connection detected.

Default Gateway

This item displays the Default Gateway for the IPMI connection detected.

MAC Address

This item displays the MAC Address for the IPMI connection detected.

Update LAN Settings

This item saves the IPMI Lan Configuration settings into memory. If you wish to change any of the settings, select Yes and press F10 to save your settings. Otherwise, leave this setting to its default setting of **No**.

4-5 Security

Choose Security from the Phoenix BIOS Setup Utility main menu with the arrow keys. You should see the following display. Security setting options are displayed by highlighting the setting using the arrow keys and pressing <Enter>. All Security BIOS settings are described in this section.

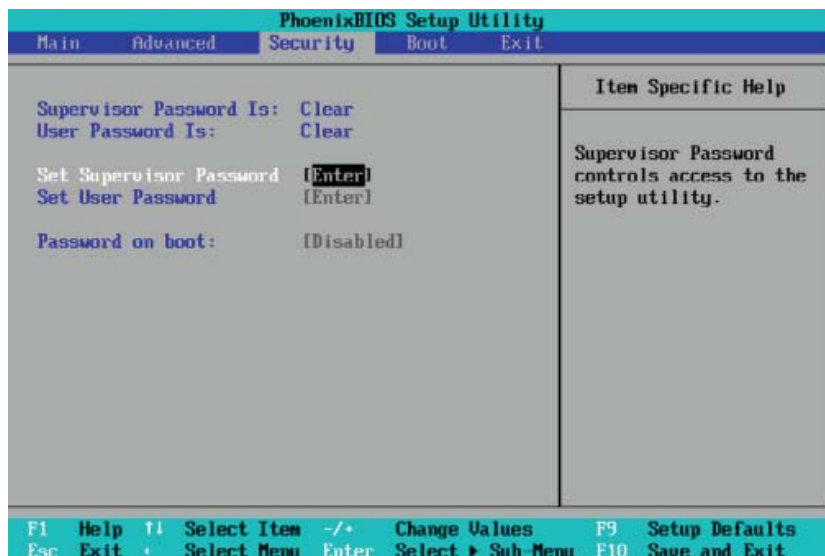

Supervisor Password Is:

This feature indicates if a supervisor password has been entered to the system. Clear means such a password has not been used, and Set means a supervisor password has been entered.

User Password Is:

This feature indicates if a user password has been entered to the system. Clear means such a password has not been used, and Set means a user password has been entered.

Set Supervisor Password

When the item Set "Supervisor Password" is highlighted, hit the <Enter> key. When prompted, type the Supervisor's password in the dialogue box to set or to change supervisor's password, which allows access to the BIOS.

Set User Password

When the item "Set User Password" is highlighted, hit the <Enter> key. When prompted, type the user's password in the dialogue box to set or to change the user's password, which allows access to the system at boot-up.

Password on Boot

This setting allows you to determine if a password is required for a user to enter the system at system boot. The options are Enabled (password required) and **Disabled** (password not required).

4-6 Boot

Choose Boot from the Phoenix BIOS Setup Utility main menu with the arrow keys. You should see the following display. See details on how to change the order and specs of boot devices in the Item Specific Help window. All Boot BIOS settings are described in this section.

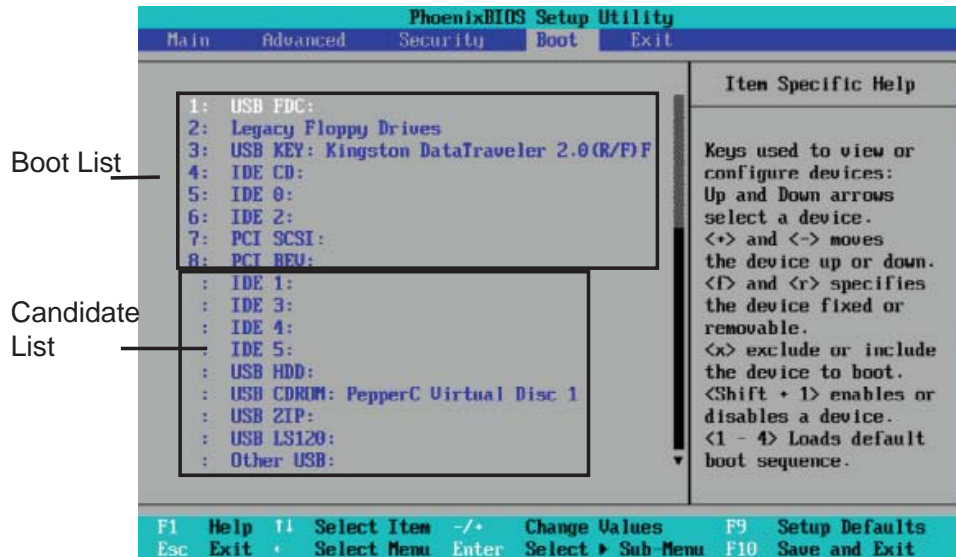

Boot Priority Order/Excluded from Boot Orders

The devices included in the boot list section (above) are bootable devices listed in the sequence of boot order as specified. The boot functions for the devices included in the candidate list (above) are currently disabled. Use a <+> key or a <-> key to move the device up or down. Use the <f> key or the <r> key to specify the type of an USB device, either fixed or removable. You can select one item from the boot list and hit the <x> key to remove it from the list of bootable devices (to make its resource available for other bootable devices). Subsequently, you can select an item from the candidate list and hit the <x> key to remove it from the candidate list and put it in the boot list. This item will then become a bootable device. See details on changing the boot priority order of a device in the "Item Specific Help" window.

4-7 Exit

Choose Exit from the Phoenix BIOS Setup Utility main menu with the arrow keys. You should see the following display. All Exit BIOS settings are described in this section.

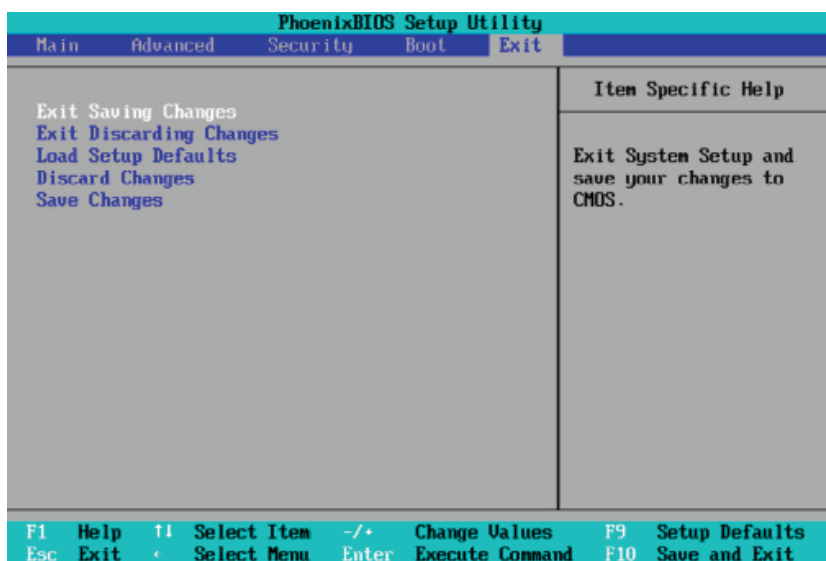

Exit Saving Changes

Highlight this item and hit <Enter> to save any changes you've made and to exit the BIOS Setup utility.

Exit Discarding Changes

Highlight this item and hit <Enter> to exit the BIOS Setup utility without saving any changes you may have made.

Load Setup Defaults

Highlight this item and hit <Enter> to load the default settings for all items in the BIOS Setup. These are the safest settings to use.

Discard Changes

Highlight this item and hit <Enter> to discard (cancel) any changes you've made. You will remain in the Setup utility.

Save Changes

Highlight this item and hit <Enter> to save any changes you've made. You will remain in the Setup utility.

Notes

Appendix A

POST Error Beep Codes

This section lists POST (Power On Self Test) error beep codes for the Phoenix BIOS. POST error beep codes are divided into two categories: recoverable and terminal. This section lists Beep Codes for recoverable POST errors.

Recoverable POST Error Beep Codes

When a recoverable type of error occurs during POST, BIOS will display a POST code that describes the problem. BIOS may also issue one of the following beep codes:

1 long and two short beeps - video configuration error

1 repetitive long beep - no memory detected

1 continuous beep with Front Panel Overheat LED on - system overheat

Notes

Appendix B

Installing the Windows OS

After all hardware components have been installed, you must first configure Intel South Bridge RAID Settings before you install the Windows OS and other software drivers. To configure Intel or Adaptec HostRAID settings, please refer to RAID Configuration User Guides posted on our website at www.supermicro.com/support/manuals.

B-1 Installing the Windows XP/2000/2003 OS for Systems with RAID Functions

1. Insert Microsoft's Windows XP/2000/2003 Setup CD in the CD Driver, and the system will start booting up from CD.
2. Press the <F6> key when the message-" Press F6 if you need to install a third party SCSI or RAID driver" displays.
3. When the Windows XP/2000/2003 Setup screen appears, press "S" to specify additional device(s).
4. Insert the driver diskette-"Intel AA RAID XP/2000/2003 Driver for ESB2" into Drive A: and press the <Enter> key.
5. Choose the Intel(R) ESB2 *SATA RAID Controller* from the list indicated in the XP/2000/2003 Setup Screen, and press the <Enter> key.
6. Press the <Enter> key to continue the installation process. (If you need to specify any additional devices to be installed, do it at this time.) Once all devices are specified, press the <Enter> key to continue with the installation.
7. From the Windows XP/2000/2003 Setup screen, press the <Enter> key. The XP/2000/2003 Setup will automatically load all device files and then, continue the Windows XP/2000/2003 installation.
8. After the Windows XP/2000/2003 OS Installation is completed, the system will automatically reboot.
9. Insert the Supermicro Setup CD that came with your motherboard into the CD Drive during system boot, and the main screen as shown on Page C-1 will display. Follow the instructions given in Appendix C to complete other driver/software installation.

B-2 Installing the Windows XP/2000/2003 OS for Systems without RAID Functions

1. Insert Microsoft's Windows XP/2000/2003 Setup CD in the CD Drive, and the system will start booting up from CD.
2. Continue with the OS installation. The Windows OS Setup screen will display.
3. From the Windows XP/2000/2003 Setup screen, press the <Enter> key. The XP/2000/2003 Setup will automatically load all device files and then continue with the Windows XP/2000/2003 installation.
4. After the Windows XP/2000/2003 OS Installation is completed, the system will automatically reboot.
5. Insert the Supermicro Setup CD that came with your motherboard into the CD Drive during system boot, and the main screen as shown on Page C-1 will display. Follow the instructions given in Appendix C to complete other driver/software installation.

Appendix C

Installing Other Software Programs and Drivers

C-1 Installing other Software Programs and Drivers

After you've installed the Windows Operating System, a screen as shown below will appear. You are ready to install software programs and drivers that have not yet been installed. To install these software programs and drivers, click the icons to the right of these items.

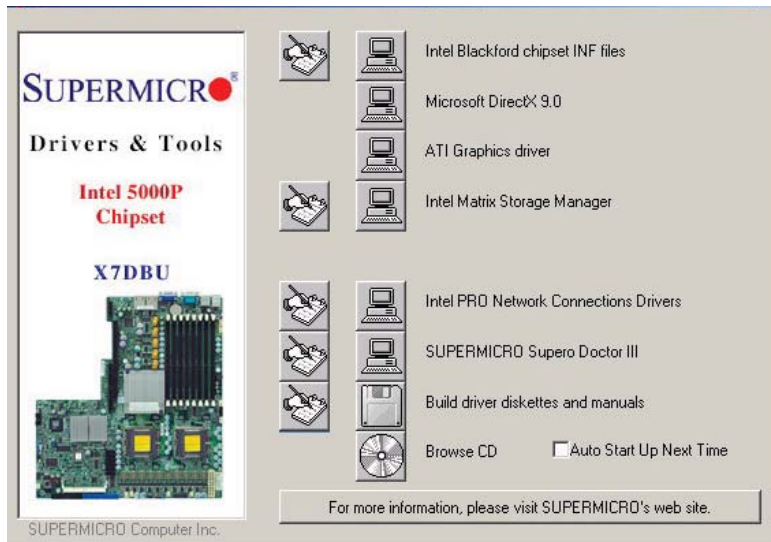

Driver/Tool Installation Display Screen

Notes:

1. Click the icons showing a hand writing on the paper to view the readme files for each item. Click on a computer icon to the right of an item to install an item (from top to the bottom) one at a time. After installing each item, you must reboot the system before proceeding with the next item on the list. The bottom icon with a CD on it allows you to view the entire contents of the CD.

2. When making a SATA storage driver disk by booting into a Driver CD, please set the SATA Configuration to "Compatible Mode" and configure SATA as IDE in the BIOS Setup. After making the driver diskette, be sure to change the SATA settings back to your original settings.

C-2 Configuring Supero Doctor III

The Supero Doctor III program is a web-base management tool that supports remote management capability. It includes Remote and Local Management tools. The local management is called the SD III Client. The Supero Doctor III program included on the CDROM that came with your motherboard allows you to monitor the environment and operations of your system. Supero Doctor III displays crucial system information such as CPU temperature, system voltages and fan status. See the Figure below for a display of the Supero Doctor III interface.

Note 1: The default user name and password are ADMIN.

Note 2: In the Windows OS environment, the Supero Doctor III settings take precedence over the BIOS settings. When first installed, Supero Doctor III adopts the temperature threshold settings previously set in the BIOS. Any subsequent changes to these thresholds must be made within Supero Doctor, since the SD III settings override the BIOS settings. For the Windows OS to adopt the BIOS temperature threshold settings, please change the SDIII settings to be the same as those set in the BIOS.

Supero Doctor III Interface Display Screen-I (Health Information)



Supero Doctor III Interface Display Screen-II (Remote Control)



Note: SD III Software Revision 1.0 can be downloaded from our Web site at: ftp://ftp.supermicro.com/utility/Supero_Doctor_III/. You can also download SDIII User's Guide at: <http://www.supermicro.com/PRODUCT/Manuals/SDIII/UserGuide.pdf>. For Linux, we will still recommend that you use Supero Doctor II.

Notes

(Disclaimer Continued)

The products sold by Supermicro are not intended for and will not be used in life support systems, medical equipment, nuclear facilities or systems, aircraft, aircraft devices, aircraft/emergency communication devices or other critical systems whose failure to perform be reasonably expected to result in significant injury or loss of life or catastrophic property damage. Accordingly, Supermicro disclaims any and all liability, and should buyer use or sell such products for use in such ultra-hazardous applications, it does so entirely at its own risk. Furthermore, buyer agrees to fully indemnify, defend and hold Supermicro harmless for and against any and all claims, demands, actions, litigation, and proceedings of any kind arising out of or related to such ultra-hazardous use or sale.