

# SUPER<sup>®</sup>

SUPER<sup>®</sup>  PDSML-LN1+

SUPER<sup>®</sup>  PDSML-LN2+

SUPER<sup>®</sup>  PDSML-E+

## USER'S MANUAL

Revision 1.1b

---

The information in this User's Manual has been carefully reviewed and is believed to be accurate. The vendor assumes no responsibility for any inaccuracies that may be contained in this document, makes no commitment to update or to keep current the information in this manual, or to notify any person or organization of the updates. **Please Note: For the most up-to-date version of this manual, please see our web site at [www.supermicro.com](http://www.supermicro.com).**

Super Micro Computer, Inc. ("Supermicro") reserves the right to make changes to the product described in this manual at any time and without notice. This product, including software, if any, and documentation may not, in whole or in part, be copied, photocopied, reproduced, translated or reduced to any medium or machine without prior written consent.

IN NO EVENT WILL SUPER MICRO COMPUTER, INC. BE LIABLE FOR DIRECT, INDIRECT, SPECIAL, INCIDENTAL, SPECULATIVE OR CONSEQUENTIAL DAMAGES ARISING FROM THE USE OR INABILITY TO USE THIS PRODUCT OR DOCUMENTATION, EVEN IF ADVISED OF THE POSSIBILITY OF SUCH DAMAGES. IN PARTICULAR, SUPER MICRO COMPUTER, INC. SHALL NOT HAVE LIABILITY FOR ANY HARDWARE, SOFTWARE, OR DATA STORED OR USED WITH THE PRODUCT, INCLUDING THE COSTS OF REPAIRING, REPLACING, INTEGRATING, INSTALLING OR RECOVERING SUCH HARDWARE, SOFTWARE, OR DATA.

Any disputes arising between manufacturer and customer shall be governed by the laws of Santa Clara County in the State of California, USA. The State of California, County of Santa Clara shall be the exclusive venue for the resolution of any such disputes. Super Micro's total liability for all claims will not exceed the price paid for the hardware product.

FCC Statement: This equipment has been tested and found to comply with the limits for a Class A digital device pursuant to Part 15 of the FCC Rules. These limits are designed to provide reasonable protection against harmful interference when the equipment is operated in a commercial environment. This equipment generates, uses, and can radiate radio frequency energy and, if not installed and used in accordance with the manufacturer's instruction manual, may cause harmful interference with radio communications. Operation of this equipment in a residential area is likely to cause harmful interference, in which case you will be required to correct the interference at your own expense.

California Best mnia Best Management Practices Regulations for Perchlorate Materials: This Perchlorate warning applies only to products containing CR (Manganese Dioxide) Lithium coin cells. "Perchlorate Material-special handling may apply. See [www.dtsc.ca.gov/hazardouswaste/perchlorate](http://www.dtsc.ca.gov/hazardouswaste/perchlorate)"

**WARNING: Handling of lead solder materials used in this product may expose you to lead, a chemical known to the State of California to cause birth defects and other reproductive harm.**

Manual Revision: Rev. 1.1b

Release Date: June 9, 2009

Unless you request and receive written permission from SUPER MICRO COMPUTER, INC., you may not copy any part of this document.

Information in this document is subject to change without notice. Other products and companies referred to herein are trademarks or registered trademarks of their respective companies or mark holders.

Copyright © 2009 by Super Micro Computer, Inc.  
All rights reserved.

**Printed in the United States of America**

---

## Preface

### About This Manual

This manual is written for system integrators, PC technicians and knowledgeable PC users. It provides information for the installation and use of the SUPER ● PDSML-LN1+/PDSML-LN2+/PDSML-E+ motherboard. It supports single Intel® Xeon® 3200/3000, Core™ 2 Duo Series, Pentium® D (Dual-Core), Pentium 4, and Celeron® D LGA (Land Grid Array) 775 Processors at system bus speeds of 1066/800/533 MHz. The processor is housed in a Flip-Chip Land Grid Array (FC-LGA4) package that interfaces with the motherboard via an LGA775 socket. The PDSML-LN1+/PDSML-LN2+/PDSML-E+ also supports Intel Hyper-Threading (HT) technology, EM64T technology, Enhanced Intel SpeedStep® Technology (EIST) and Matrix Storage Technology. Please refer to the motherboard specifications pages on our web site (<http://www.supermicro.com/products/motherboard/>) for updates or visit Intel's web site for processor support. This product is intended to be installed and serviced by a professional technician.

### Manual Organization

**Chapter 1** describes features, specifications and detailed information about the motherboard and the chipset.

**Chapter 2** provides hardware installation instructions. Read this chapter when installing the processor, memory modules and other hardware components into the system.

**Chapter 3** describes troubleshooting procedures for the video, the memory and the system setup stored in CMOS if you encounter problems.

**Chapter 4** includes an introduction to BIOS and provides detailed information on running the CMOS Setup utility.

**Appendix A** and **Appendix B** list BIOS POST Error Codes and Messages. **Appendix C** provides Software Installation Instructions.

### Conventions Used in the Manual

Special attention should be given to the following symbols for proper installation of the components and to prevent damage done to the components or injury to yourself:



**Danger/Caution:** Instructions to be strictly followed to prevent catastrophic system failure or to avoid bodily injury.



**Warning:** Important information given to ensure proper system installation or to prevent damage to the components.

**Note:** Additional Information given to differentiate various models or to ensure correct system setup.

# Table of Contents

## Preface

About This Manual .....	iii
Manual Organization .....	iii
Conventions Used in the Manual.....	iii

## Chapter 1: Introduction

1-1 Overview .....	1-1
Checklist .....	1-1
Contacting Supermicro .....	1-2
SUPER ● PDSML-LN1+/PDSML-LN2+/PDSML-E+ Image .....	1-3
SUPER ● PDSML-LN1+/PDSML-LN2+/PDSML-E+ Layout .....	1-4
SUPER ● PDSML-LN1+/PDSML-LN2+/PDSML-E+ Quick Reference .....	1-5
Motherboard Features.....	1-6
Intel 3000/3010 Chipset: System Block Diagram .....	1-8
1-2 Chipset Overview .....	1-9
1-3 Special Features .....	1-10
1-4 PC Health Monitoring .....	1-10
1-5 ACPI Features .....	1-11
1-6 Power Supply.....	1-12
1-7 Super I/O .....	1-13
1-8 Intelligent Platform Management Interface (IPMI).....	1-13

## Chapter 2: Installation

2-1 Electro-Static Sensitive Devices .....	2-1
2-2 Processor and Heatsink Installation .....	2-2
2-3 Mounting the Motherboard in the Chassis .....	2-5
2-4 Installing DDR 2 Memory .....	2-6
2-5 Control Panel Connectors/IO Ports .....	2-8
A. Back Panel Connectors/IO Ports .....	2-8
B. Front Control Panel.....	2-8
C. Front Control Panel Pin Definitions .....	2-9
NMI Button .....	2-9
Power LED .....	2-9
HDD LED.....	2-10
NIC1/NIC2 LED Indicators .....	2-10
Overheat/Fan Fail LED .....	2-11
Power Fail LED .....	2-11

	Reset Button.....	2-12
	Power Button.....	2-12
2-6	Connecting Cables .....	2-13
	ATX Power Connector .....	2-13
	Processor Power Connector .....	2-13
	Serial Ports.....	2-14
	Chassis Intrusion.....	2-14
	Universal Serial Bus (USB).....	2-15
	GLAN (Ethernet Ports).....	2-15
	ATX PS/2 Keyboard and Mouse Ports.....	2-16
	Speaker Connector .....	2-16
	Fan Headers .....	2-17
	Wake-On-Ring.....	2-18
	Wake-On-LAN .....	2-18
	VGA Connector .....	2-19
	Power LED .....	2-19
	Power Fault .....	2-20
	Power SMB Connector.....	2-20
	Power Alarm Reset .....	2-21
2-7	Jumper Settings .....	2-22
	Explanation of Jumpers .....	2-22
	GLAN Enable/Disable .....	2-22
	CMOS Clear .....	2-23
	VGA Enable.....	2-23
	Power Force On Enable.....	2-24
	I <sup>2</sup> C Bus to PCI/PCI-E Slots.....	2-24
2-8	Onboard Indicators .....	2-25
	GLAN LEDs.....	2-25
2-9	Floppy, Hard Disk Drive, and IPMI 2.0 Connections .....	2-26
	Floppy Connector.....	2-26
	IDE Connectors.....	2-27
	IPMI 2.0 Slot.....	2-27

## Chapter 3: Troubleshooting

3-1	Troubleshooting Procedures .....	3-1
	Before Power On.....	3-1
	No Power.....	3-1
	No Video .....	3-1

Memory Errors.....	3-2
Losing the System's Setup Configuration .....	3-2
3-2 Technical Support Procedures .....	3-2
3-3 Frequently Asked Questions .....	3-3
3-4 Returning Merchandise for Service .....	3-4

## **Chapter 4: BIOS**

4-1 Introduction .....	4-1
4-2 Running Setup .....	4-2
4-3 Main BIOS Setup .....	4-3
4-4 Advanced Setup .....	4-7
4-5 Security Setup .....	4-18
4-6 Boot Setup .....	4-19
4-7 Exit .....	4-20

## **Appendices:**

Appendix A: BIOS POST Error Messages.....	A-1
Appendix B: BIOS POST Codes.....	B-1
Appendix C: Installing Software Drivers and the Operating System .....	C-1

# Chapter 1

## Introduction

### 1-1 Overview

#### Checklist

Congratulations on purchasing your computer motherboard from an acknowledged leader in the industry. Supermicro motherboards are designed with the utmost attention to detail to provide you with the highest standards in quality and performance.

Please check that the following items have all been included with your motherboard. If anything listed here is damaged or missing, contact your retailer.

All the items below are included in the retail box only

One (1) Supermicro Mainboard

One (1) IDE cable (CBL-0036L-02)

One (1) floppy drive ribbon cable (CBL-0022L)\*

Four (4) SATA cables (CBL-0044L)\*

One (1) IO Shield (CSE-PT07L)\*

One (1) IO Shield (CSE-PT2)\*\*

One (1) Supermicro CD containing drivers and utilities

One (1) User's/BIOS Manual

\*For the PDSML-LN2+ and PDSML-E+ only

\*\*For the PDSML-LN1+ only

## Contacting Super Micro

### Headquarters

Address: Super Micro Computer, Inc.  
980 Rock Ave.  
San Jose, CA 95131 U.S.A.

Tel: +1 (408) 503-8000

Fax: +1 (408) 503-8008

Email: [marketing@supermicro.com](mailto:marketing@supermicro.com) (General Information)  
[support@supermicro.com](mailto:support@supermicro.com) (Technical Support)

Web Site: [www.supermicro.com](http://www.supermicro.com)

### Europe

Address: Super Micro Computer B.V.  
Het Sterrenbeeld 28, 5215 ML  
's-Hertogenbosch, The Netherlands

Tel: +31 (0) 73-6400390

Fax: +31 (0) 73-6416525

Email: [sales@supermicro.nl](mailto:sales@supermicro.nl) (General Information)  
[support@supermicro.nl](mailto:support@supermicro.nl) (Technical Support)  
[rma@supermicro.nl](mailto:rma@supermicro.nl) (Customer Support)

### Asia-Pacific

Address: Super Micro, Taiwan  
4F, No. 232-1 Liancheng Road  
Chung-Ho 235, Taipei Hsien, Taiwan, R.O.C.

Tel: +886-(2) 8226-3990

Fax: +886-(2) 8226-3991

Web Site: [www.supermicro.com.tw](http://www.supermicro.com.tw)

Technical Support:

Email: [support@supermicro.com.tw](mailto:support@supermicro.com.tw)

Tel: 886-2-8228-1366, ext.132 or 139



**SUPER** PDSML-LN1+/PDSML-LN2+/PDSML-E+ Image

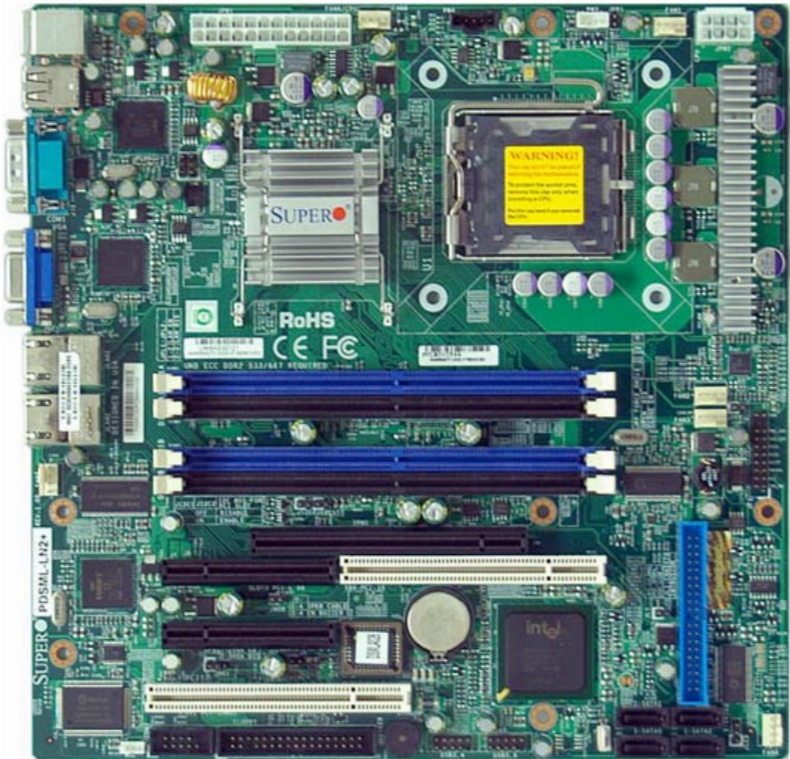

**An Important Note to the User**

- All images and layouts shown in this manual were based upon the latest PCB Revision available at the time of publishing of this manual. The motherboard you've received may or may not look exactly the same as the graphics shown in this manual.
- Please see Note 5 on Page 1-4.



---



---

## PDSML-LN1+/PDSML-LN2+/PDSML-E+ Quick Reference

<b>Jumpers</b>	<b>Description</b>	<b>Default Setting</b>
JBT1	CMOS Clear	See Section 2-7
J1 <sup>2</sup> C1/J1 <sup>2</sup> C2	I <sup>2</sup> C Bus to PCI Slots 1/2	Open (Disabled)
JPF	Power Force-On	Open (Disabled)
JPG1	VGA Enable	Pins 1-2 (Enabled)
JPL1/JPL2 (Note)	Giga-bit LAN 1/2 Enable	Pins 1-2 (Enabled)

<b>Connectors</b>	<b>Description</b>
24-Pin ATX (JPW1)	ATX 24-pin Power Connector
8-Pin PWR (JPW2)	12V 8-pin PWR Connector
Alarm Reset (JPR1)	Redundant Power Alarm Reset
Chassis Intrusion (JL1)	Chassis Intrusion Header
COM1 (J31), COM2	COM Port 1 & COM 2 Header
DIMM#1A,#2A,#1B,#2B	Memory (DIMM) Slots (DIMM 1-DIMM 4)
Fans 1-6	System Fan Headers (Fans 1-5), Fan6: CPU Fan
FP Control (JF1)	Front Panel Control Header
Floppy Connector (J27)	Floppy Disk Connector
IDE (J3)	IDE#1 Slot
IPMI (Note)	IPMI 2.0 Slot
KB/MS (J28)	PS/2 Keyboard/Mouse Connectors
LAN1-LAN2 (JLAN1/2)(Note)	Ethernet RJ45 (Gigabit LAN) Port1/Port2 Connections
Power Fault (PW3)	Power Fault Header
Power LED (JLED)	PWR LED Header
Power SMB (I <sup>2</sup> C) (PW4)	Power SMB (System Management Bus) Connector
SATA 0-3	Intel SATA Ports (#1-#4)
Slot 4	PCI 32-bit 33MHz slot
Slot 5	PCI-Express x4 slot
Slot 6 + SBX	PCI-Express x8 slot + SBX: PCI 32-bit 33MHz slot
Speaker (J9)	Speaker Connector (Pins 3-4:Internal,Pins 1-4:External)
USB1/2 (J15)	Back Panel Universal Serial Bus Ports 1,2
USB3/4 (J46),USB5/6 (J45)	Front Panel Accessible USB Ports 3,4,5,6
VGA (JG1)	VGA Connector
WOL (WOL)	Wake On LAN header
WOR (JWOR)	Wake On Ring header

<b>LED Indicator</b>	<b>Description (*(Refer to Addendum A))</b>
LE 1	Onboard PWR warning LED Indicator
LE3/LE4	BIOS POST Code Indicators

**Note:** JPL2, IPMI and LAN2 are available on the PDSML-LN2+ and PDSML-E+only. Please refer to Note 5 on the previous page.

## Motherboard Features

### Processor

- Single Intel Xeon 3200/3000/Core 2 Duo Series//Pentium D dual-core/Pentium 4/Celeron D processors at system bus speeds of 1066/800/533 MHz.
- Hyper-Threading (HT), EM64T, Enhanced Intel SpeedStep (EIST) supported

#### The EM64T Feature is supported when:

- 64-bit OS (Windows XP Professional x64 Ed, Server 2003x64 Ed.) and
- 64-bit drivers for all MB components, devices and add-on cards are installed on the motherboard.

#### Hyper-Threading (HT) Technology is supported when:

- A CPU that supports Hyper-Threading Technology is used,
- An OS that supports HT is installed onboard, including Windows XP/2003 Server and Linux 2.4x. (Under Linux, use the HT compiler to compile the code. For other operating systems, be sure to disable the HT feature in the BIOS.)
- HT features are enabled in the BIOS (under the "Advanced" Setting) before a supported OS is installed. (**Note:** visit [www.Intel.com](http://www.Intel.com) for CPU support and driver updates.)

### Memory

- Four DIMM slots support dual Channel DDR2 667/533 MHz up to 8 GB of Unbuffered ECC/Non-ECC SDRAM.

### Chipset

- Intel 3000 (PDSML-LN1+ and PDSML-LN2+)
- Intel 3010 (PDSML-E+)
- Intel ICH7R

### Expansion Slots

- Two (2) PCI 32-Bit/33 MHz slots (Slot 4 & SBX)
- Two (2) PCI-Express slots: x4 (Slot 5) & x8 (Slot 6)

### BIOS

- 8Mb Firmware Hub, Phoenix® BIOS
- DMI 2.3, PCI 2.2, ACPI 1.0, Plug and Play (PnP), SMBIOS 2.3, Hardware BIOS Virus Protection

### PC Health Monitoring

- Onboard voltage monitors for CPU core, Memory, +1.5V, +1.8V, +3.3V, +5V, +5V Standby, +12V, -12V, Vbatt and VTT.
- Status monitor for fan speed & System Overheat/Fan Fail LED/Control
- Pulse Width Modulation Fan Control & Low noise fan speed control
- SuperDoctor III, NMI
- System Resource alert via SuperDoctor III

### **ACPI Features**

- Slow blinking LED for suspend state indicator
- BIOS support for USB keyboard/Mouse
- Main switch override mechanism
- External modem ring-on

### **Onboard I/O**

- One ATA/100 EIDE Channel
- Intel ICH7R SATA Controller, 4 connectors for 4 devices with support of RAID 0, 1, 5 and 10 (Note)
- One floppy port interface (up to 2.88 MB)
- One Fast UART 16550 compatible serial port
- Two Intel single-port 82573 V/L PCI-E Gigabit Ethernet Controllers with two GLAN ports (82573L for LN1) (See Note on the following page)
- PS/2 mouse and PS/2 keyboard ports
- Up to 6 USB (Universal Serial Bus) 2.0 ports
- VGA Connector
- One IPMI 2.0 Slot (Note)
- Super I/O (Winbond® 83627 HG) with hardware monitoring
- XGI® Volari® Graphics with 16MB DDR memory

### **Temperature**

- Monitoring CPU, chassis environment
- CPU Thermal Trip support
- Thermal Monitor 2 (TM2) (available if supported by the CPU)

### **Other**

- Wake-on-LAN (WOL)
- Wake-on-Ring (WOR)
- Onboard Standby PWR warning LED Indicator ("LE 1")

### **CD Utilities**

- Drivers and software for Intel 3000 chipset utilities

### **Dimensions**

- 9.6" (W) x 9.6" (L) (243.84 mm x 243.84 mm)

**Note:** IPMI and LAN2 options are available on the PDSML-LN2+ and PDSML-E+ only.

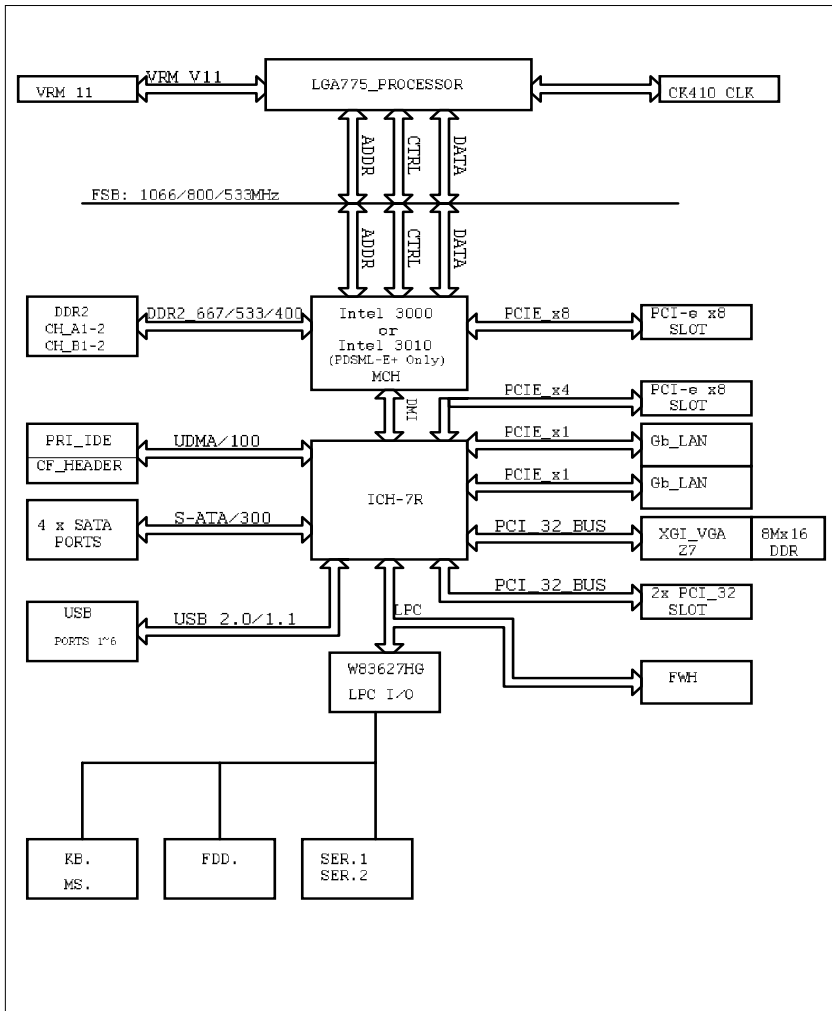

**The Intel 3000/3010 Chipset:  
System Block Diagram**

**Note:** This is a general block diagram and may not exactly represent the features on your motherboard. See the following pages for the actual specifications of the motherboard.

## 1-2 Chipset Overview

The Intel 3000/3010 chipset is comprised of two primary components: the Memory Controller Hub (MCH) and the I/O Controller Hub (ICH7R). With the capabilities provided by the Intel 3000/3010 chipset, the PDSML-LN1+/PDSML-LN2+/PDSML-E+ provides the performance and feature-set required for cost-effective UP servers.

### Memory Controller Hub (MCH)

The function of the MCH is to manage the data flow between four interfaces: the processor interface (FSB), the System Memory Interface (DRAM Controller), the Direct Media Interface (DMI) and the PCI Express Interface.

Using a scalable FSB Vcc\_CPU, the MCH supports FSB speed up to 1066 MT/s (266 MHz). Hyper-Threading Technology (HT) and FSB Dynamic Bus Inversion (DBI) are among the Host Interface features supported. It integrates a system memory DDR2 controller with two 64-bit interfaces and supports one or two channels of DDR2 SDRAM.

The I/O Controller (ICH7R) provides the data buffering and interface arbitration required for the system to operate efficiently. It also provides the bandwidth needed for the system to maintain its peak performance. The Direct Media Interface (DMI) provides the chip-to-chip connection between the MCH and the ICH7R.

The ICH7R supports up to four Serial ATA ports, six USB 2.0 ports and two IDE devices. In addition, the ICH7R offers the Intel Matrix Storage Technology which provides various RAID options for data protection and rapid data access. It also supports the next generation of client management through the use of PROActive technology in conjunction with Intel's next generation Gigabit Ethernet controller.

### Intel ICH7 (ICH7R) System Features

The I/O Controller Hub provides the I/O subsystem with access to the rest of the system. Functions and capabilities include:

- \*Advanced Configuration and Power Interface, Version 2.0 (ACPI)
- \*Intel I/O External Design Specification (EDS)
- \* The Intel 3000 or Intel 3010 Memory Controller Hub (MCH) External Design Specification (EDS)
- \*Intel I/O Controller Hub 7 (ICH7R) Thermal Design Guideline

## 1-3 Special Features

### Recovery from AC Power Loss

BIOS provides a setting for you to determine how the system will respond when AC power is lost and then restored to the system. You can choose for the system to remain powered off (in which case you must hit the power switch to turn it back on) or for it to automatically return to a power-on state. See the Power Lost Control setting in the Advanced BIOS Setup section to change this setting. The default setting is Last State.

## 1-4 PC Health Monitoring

This section describes the PC health monitoring features of the PDSML-LN1+/LN2+. The motherboard has an onboard System Hardware Monitor chip that supports PC health monitoring.

### Onboard Voltage Monitors for the CPU Cores, memory, +1.5V, +1.8V, +3.3V, +5V, +12V, -12V, +5V Standby, VTT and Vbat

An onboard voltage monitor will scan these voltages continuously. Once a voltage becomes unstable, a warning is given or an error message is sent to the screen. The user can adjust the voltage thresholds to define the sensitivity of the voltage monitor.

### Fan Status Monitor with Firmware Control

The PC health monitor can check the RPM status of the cooling fans. The onboard CPU and chassis fans are controlled by Thermal Management via BIOS (under Hardware Monitoring in the Advanced Setting).

### Environmental Temperature Control

The thermal control sensor monitors the CPU temperature in real time and will turn on the thermal control fan whenever the CPU temperature exceeds a user-defined threshold. The overheat circuitry runs independently from the CPU. Once it detects that the CPU temperature is too high, it will automatically turn on the thermal fan control to prevent any possible CPU overheat. The onboard chassis thermal circuitry can monitor the overall system temperature and alert the user when the chassis temperature is too high.

### CPU Fan Auto-Off in Sleep Mode

The CPU fan activates when the power is turned on. It continues to operate when the system enters Standby mode. When in sleep mode, the CPU will not run at full power, thereby generating less heat.



## **CPU Overheat LED and Control**

This feature is available when the user enables the CPU overheat warning function in the BIOS. This allows the user to define an overheat temperature. When this temperature exceeds the predefined temperature threshold, both overheat fan and the warning LED will be activated.

## **System Resource Alert**

This feature is available when used with Supero Doctor III in the Windows OS environment or used with Supero Doctor II in Linux. Supero Doctor is used to notify the user of certain system events. For example, if the system is running low on virtual memory and there is insufficient hard drive space for saving the data, you can be alerted of the potential problem. You can also configure Supero Doctor to provide you with warnings when the system temperature goes beyond a pre-defined range.

## **1-5 ACPI Features**

ACPI stands for Advanced Configuration and Power Interface. The ACPI specification defines a flexible and abstract hardware interface that provides a standard way to integrate power management features throughout a PC system, including its hardware, operating system and application software. This enables the system to automatically turn on and off peripherals such as CD-ROMs, network cards, hard disk drives and printers. This also includes consumer devices connected to the PC such as VCRs, TVs, telephones and stereos.

In addition to enabling operating system-directed power management, ACPI provides a generic system event mechanism for Plug and Play and an operating system-independent interface for configuration control. ACPI leverages the Plug and Play BIOS data structures while providing a processor architecture-independent implementation that is compatible with Windows 2000, Windows XP and Windows 2003 Server.

### **Slow Blinking LED for Suspend-State Indicator**

When the CPU goes into a suspend state, the chassis power LED will start blinking to indicate that the CPU is in suspend mode. When the user presses any key, the CPU will wake-up and the LED will automatically stop blinking and remain on.

### **Main Switch Override Mechanism**

When an ATX power supply is used, the power button can function as a system suspend button to make the system enter a SoftOff state. The monitor will be suspended and the hard drive will spin down. Pressing the power button again will cause the whole system to wake-up. During the SoftOff state, the ATX power

supply provides power to keep the required circuitry in the system alive. In case the system malfunctions and you want to turn off the power, just press and hold the power button for 4 seconds. This option can be set in the Power section of the BIOS Setup routine.

### **External Modem Ring-On**

Wake-up events can be triggered by a device such as the external modem ringing when the system is in the Standby or Off state. Note that external modem ring-on can only be used with an ATX 2.01 (or above) compliant power supply.

### **Wake-On-LAN**

Wake-On-LAN is defined as the ability of a management application to remotely power up a computer that is powered off. Remote PC setup, up-dates and asset tracking can occur after hours and on weekends so that daily LAN traffic is kept to a minimum and users are not interrupted. The motherboard has a 3-pin header (WOL) to connect to the 3-pin header on a Network Interface Card (NIC) that has WOL capability. In addition, an onboard LAN controller can also support WOL without any connection to the WOL header. The 3-pin WOL header is to be used with a LAN add-on card only.

**Note:** Wake-On-LAN requires an ATX 2.01 (or above) compliant power supply.

## **1-6 Power Supply**

As with all computer products, a stable power source is necessary for proper and reliable operation. It is even more important for processors that have high CPU clock rates.

The PDSML-LN1+/PDSML-LN2+/PDSML-E+ can only accommodate a 24-pin ATX power supply. Although most power supplies generally meet the specifications required by the motherboard, some are inadequate. You should use one that will supply at least 400W of power. In addition, the 12V 8-pin power connector is also required for adequate power supply to the system. Also your power supply must supply 1.5A of current for the Ethernet ports.

It is strongly recommended that you use a high quality power supply that meets ATX power supply Specification 2.01 or above. It must also be SSI compliant (info at <http://www.ssiforum.org/>). Additionally, in areas where noisy power transmission is present, you may choose to install a line filter to shield the computer from noise. It is recommended that you also install a power surge protector to help avoid problems caused by power surges.

## 1-7 Super I/O

The disk drive adapter functions of the Super I/O chip include a floppy disk drive controller that is compatible with industry standard 82077/765, a data separator, write pre-compensation circuitry, decode logic, data rate selection, a clock generator, drive interface control logic and interrupt and DMA logic. The wide range of functions integrated onto the Super I/O greatly reduces the number of components required for interfacing with floppy disk drives. The Super I/O supports 360 K, 720 K, 1.2 M, 1.44 M or 2.88 M disk drives and data transfer rates of 250 Kb/s, 500 Kb/s or 1 Mb/s. It also provides two high-speed, 16550 compatible serial communication ports (UARTs). Each UART includes a 16-byte send/receive FIFO, a programmable baud rate generator, complete modem control capability and a processor interrupt system. Both UARTs provide legacy speed with baud rate of up to 115.2 Kbps as well as an advanced speed with baud rates of 250 K, 500 K, or 1 Mb/s, which support higher speed modems.

The Super I/O supports one PC-compatible printer port (SPP), Bi-directional Printer Port (BPP) , Enhanced Parallel Port (EPP) or Extended Capabilities Port (ECP).

The Super I/O provides functions that comply with ACPI (Advanced Configuration and Power Interface), which includes support of legacy and ACPI power management through an SMI or SCI function pin. It also features auto power management to reduce power consumption.

## 1-8 Intelligent Platform Management Interface (IPMI)

IPMI is a management interface that enables a user or administrator to remotely access, monitor, diagnose and manage servers and networks. To use the IPMI 2.0 slot on this motherboard, use Supermicro's AOC-SIM1U, AOC-SIM1U+ or the AOC-SIMLC Intelligent Management module, and the IPMIView software utility that is included in the package.

With the Raritan® KIRA™ 100 Baseboard Management Controller (BMC) built-in, the AOC-SIM1U/SIM1U+ and the AOC-SIMLC supports the 2D/VGA-compatible Graphics Core with the PCI interface, Virtual Media, and Keyboard/Video/Mouse (KVM) Redirection modules.

The KIRA 100 BMC interfaces with the host system via a PCI interface to communicate with the graphics core. It supports USB 2.0 and 1.1 for remote keyboard/mouse/virtual media emulation. It also provides LPC interface to control Super IO functions. The KIRA 100 is connected to the network via an external Ethernet PHY module to provide network interfacing and management.

For more information on IPMI configuration, please refer to the AOC-SIM1U/SIM1U+ and AOC-SIMLC User's Guide posted on our website at <http://www.supermicro.com/products/accessories/addon/SIM.cfm>.

## Chapter 2

# Installation

### 2-1 Electro-Static Sensitive Devices



Electro-Static Discharge (ESD) can damage electronic components. To prevent damage to your system board, it is important to handle it very carefully. The following measures are generally sufficient to protect your equipment from ESD.

#### Precautions

- Use a grounded wrist strap designed to prevent electro-static build up.
- Touch a grounded metal object before removing the board from the anti-static bag to discharge any electro-static build up.
- Handle the board by its edges only; do not touch its components, peripheral chips, memory modules or gold contacts.
- When handling chips or modules, avoid touching their pins.
- Put the motherboard and peripherals back into their anti-static bags when not in use.
- For grounding purposes, make sure your computer chassis provides excellent conductivity between the power supply, the case, the mounting fasteners and the motherboard.
- Use only the correct type of onboard CMOS battery. Do not install the onboard battery upside down to avoid possible explosion.

#### Unpacking

The motherboard is shipped in anti-static packaging to avoid ESD damage. When unpacking the board, make sure the person handling it is ESD protected.

**Note:** Be sure to mount the motherboard into the chassis before you install the CPU onto the motherboard. All motherboards have standard mounting holes to fit different types of chassis. Make sure that the locations of all the mounting holes for both motherboard and chassis match and the metal standoffs click in or are screwed in tightly. Use a screwdriver to secure the motherboard.

**Caution:** 1. Please do not use a force greater than 8 lb/inch on each mounting screw during motherboard installation. 2. Some components are very close to the mounting holes. Please take precautionary measures to prevent damage to these components when installing the motherboard to the chassis.

## 2-2 Processor, Heatsink and Fan Installation



**When handling the processor package, avoid placing direct pressure on the label area of the fan.**

**Notes:** 1. Always connect the power cord last and always remove it before adding, removing or changing any components. Make sure that you install the processor into the CPU socket before you install the CPU heatsink.

2. Intel's boxed processor package contains the CPU fan and heatsink assembly. If you buy a CPU separately, make sure that you use an Intel-certified multi-directional heatsink and fan.

3. The LGA 775 heatsink and fan comes with a push-pin design and no tool is needed for installation.

4. When purchasing an LGA 775 CPU or when receiving a motherboard with an LGA 775 CPU pre-installed, make sure that the CPU plastic cap is in place and none of the CPU pins are bent; otherwise, contact the retailer immediately.

5. Refer to the MB Features Section for more details on CPU support.

### Installation of the LGA775 Processor

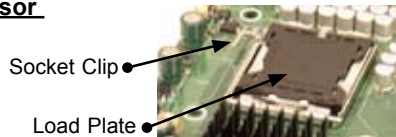

1. Press the socket clip to release the load plate, which covers the CPU socket, from its locking position.



2. Gently lift the socket clip to open the load plate.

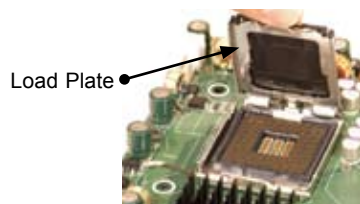

3. Locate Pin 1 on the CPU socket. **Note:** Pin 1 is the corner marked with a triangle. Please note that the North Key and the South Key are located vertically in the CPU housing.

4. Position the motherboard in such a way that Pin 1 of the CPU socket is located at the left bottom of the CPU housing.

5. Use your thumb and your index finger to hold the CPU at the North Center Edge and the South Center Edge of the CPU.

6. Align Pin 1 of the CPU with Pin 1 of the socket. Once aligned, carefully lower the CPU straight down to the socket. (\*\*Do not drop the CPU on the socket. Do not move the CPU horizontally or vertically. Do not rub the CPU against the surface or against any pins of the socket to avoid damage to the CPU or the socket.)

7. With the CPU inside the socket, inspect the four corners of the CPU to make sure that the CPU is properly installed.

8. Use your thumb to gently push the socket clip down to the clip lock.

9. If the CPU is properly installed into the socket, the plastic cap will be automatically released from the load plate when the Clip is pushed in the clip lock. Remove the plastic cap from the motherboard.

 **Warning:** Please keep the plastic cap. The motherboard and the CPU must be shipped with the plastic cap properly installed to protect the CPU pins. Shipment without the CPU plastic cap properly installed will void the warranty.

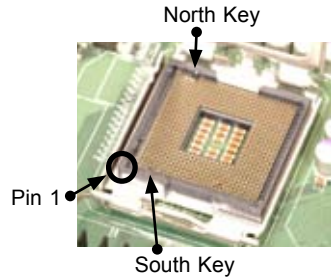

North Center Edge



South Center Edge

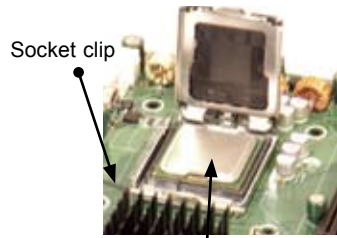

CPU in the CPU socket



Plastic cap is released from the load plate if CPU properly installed.

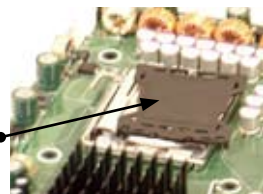

## Installation of the Heatsink

1. Locate the CPU Fan on the motherboard. (Refer to the layout on the right for the CPU Fan location.)
2. Position the heatsink so that the heatsink fan wires are closest to the CPU fan and are not interfered with other components.
3. Inspect the CPU Fan wires to make sure that the wires are routed through the bottom of the heatsink.

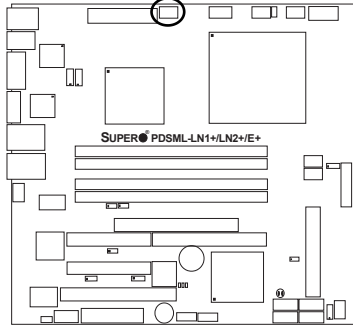

4. Remove the thin layer of the protective film from the copper core of the heatsink.

**Warning:** CPU may overheat if the protective film is not removed from the heatsink.

5. Apply the proper amount of thermal grease on the CPU. **Note:** if your heatsink came with a thermal pad, please ignore this step.

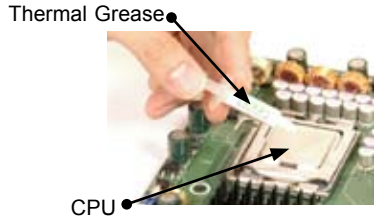

6. If necessary, rearrange the wires to make sure that the wires are not pinched between the heatsink and the CPU. Also make sure to keep clearance between the fan wires and the fins of the heatsink.

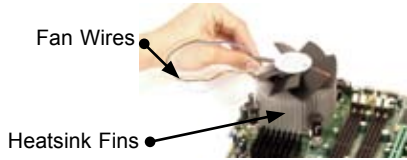

7. Align the four heatsink fasteners with the mounting holes on the motherboard. Gently push the pairs of diagonal fasteners (#1 & #2, and #3 & #4) into the mounting holes until you hear a click. **Note:** Make sure to orient each fastener so that the narrow end of the groove points outward.

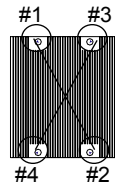

Narrow end of the groove points outward



8. Repeat Step 6 to insert all four heatsink fasteners into the mounting holes.
9. Once all four fasteners are securely inserted into the mounting holes and the heatsink is properly installed on the motherboard, connect the heatsink fan wires to the CPU Fan connector.

### Heatsink Removal

1. Unplug the power cord from the power supply.
2. Disconnect the heatsink fan wires from the CPU fan header.
3. Use your finger tips to gently press on the fastener cap and turn it counterclockwise to make a 1/4 (90°) turn, and then pull the fastener upward to loosen it.
4. Repeat Step 3 to loosen all fasteners from the mounting holes.
5. With all fasteners loosened, remove the heatsink from the CPU.



## 2-3 Mounting the Motherboard in the Chassis

All motherboards have standard mounting holes to fit different types of chassis. Make sure the locations of all the mounting holes for both the motherboard and the chassis match. Make sure the metal standoffs click in or are screwed in tightly. Then use a screwdriver to secure the motherboard onto the motherboard tray.

**Note:** Some components are very close to the mounting holes. Please take all necessary precautionary measures to prevent damage done to these components when installing the motherboard into the chassis. Please do not use a force greater than 8 lb/inch on each mounting screw during installation to prevent damage to the motherboard.

## 2-4 Installing DDR2 Memory

### Memory Module Installation

---



Exercise extreme care when installing or removing memory modules to prevent any possible damage.

---

1. Insert each DDR2 memory module vertically into its slot. Pay attention to the notch along the bottom of the module to prevent inserting the module incorrectly. (See support information below.)
2. Gently press down on the memory module until it snaps into place.

#### Support

The PDSML-LN1+/PDSML-LN2+/PDSML-E+ supports up to 8GB of dual channel, ECC/Non-ECC, unbuffered DDR2 667/533 MHz SDRAM. Both interleaved and non-interleaved memory are supported, so you may populate any number of DIMM slots. Populating DIMM#1A, DIMM#1B, and/or DIMM#2A, DIMM#2B with memory modules of the same size and of the same type will result in dual channel, two-way interleaved memory which is faster than the single channel, non-interleaved memory. Note that when ECC memory is used, it may take 25-40 seconds for the VGA to display.

#### Notes:

1. Due to chipset limitation, 8GB Memory can only be supported by the following operating systems:  
**32-Bit:** Windows 2000 Advanced Server, Windows Server 2003 Enterprise Edition; **64-Bit:** Windows Server 2003 Standard x64 Edition, Windows XP Professional x64 Edition, Windows Server 2003 Enterprise x64 Edition.
2. DIMM sizes of 256MB, 512MB, 1GB and 2GB are supported (240-pin, 1.8V only).
3. Due to memory allocation to system devices, memory remaining available for operational use will be reduced when 4 GB of RAM is used. The reduction in memory availability is disproportional. Refer to the Memory Availability Table on the following page for details.

Possible System Memory Allocation & Availability			
System Device	Size	Physical Memory Remaining (-Available) (3 GB Total System Memory)	Physical Memory Remaining (-Available) (4 GB Total System Memory)
Firmware Hub flash memory (System BIOS)	1 MB	3.00	3.99
Local APIC	4 KB	3.00	3.99
Area Reserved for the chipset	2 MB	3.00	3.99
I/O APIC (4 Kbytes)	4 KB	3.00	3.99
PCI Enumeration Area 1	256 MB	3.00	3.76
PCI Express (256 MB)	256 MB	3.00	3.51
PCI Enumeration Area 2 (if needed) -Aligned on 256-MB boundary-	512 MB	3.00	3.01
VGA Memory	16 MB	2.85	2.85
TSEG	1 MB	2.84	2.84
Memory available to BIOS, OS, applications		2.84	2.84

### Installing a DIMM Module into a Slot

#### To Install:

Insert module vertically and press down until it snaps into place. Pay attention to the notch.

#### To Remove:

Use your thumbs to gently push each release tab outward to release the DIMM from the slot.

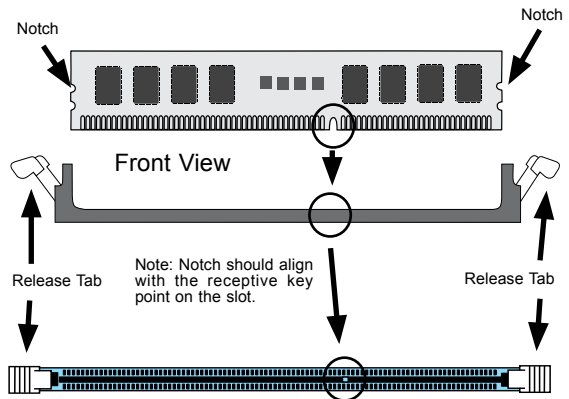

### Note To Microsoft Windows Users



Microsoft implemented a design change in Windows XP with Service Pack 2 (SP2) and Windows Vista. This change improves driver compatibility, but however reduces the available memory compared to what is physically installed. For more information, please read the following article at Microsoft's Knowledge Base website at: <http://support.microsoft.com/kb/888137>.

## 2-5 Control Panel Connectors/IO Ports

The I/O ports are color coded in conformance with the PC 99 specification. See below for the colors and locations of the various I/O ports.

### A. Back Panel Connectors/IO Ports

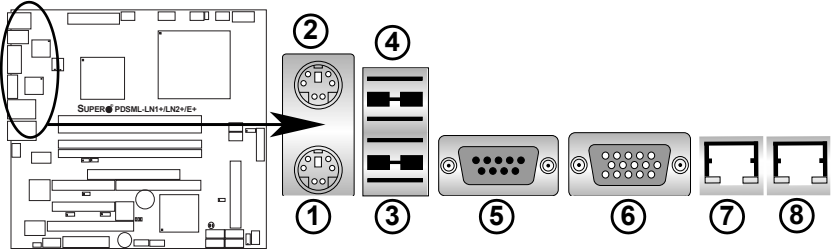

**Back Panel I/O Port Locations and Definitions**

### Back Panel Connectors

- |                           |   |
|---------------------------|---|
| 1. Keyboard (Purple)      | 5. COM Port 1 (Turquoise)                               |
| 2. PS/2 Mouse (Green)     | 6. VGA Port (Blue)                                      |
| 3. Back Panel USB Port 1  | 7. Gigabit LAN 1  |
| 4. Back Panel USB Port 2. | 8. Gigabit LAN 2 (*For PDSMML-LN2+ and PDSMML-E+ only.) |
- (\*See Section 2-6 for details.)

### B. Front Control Panel

JF1 contains header pins for various buttons and indicators that are normally located on a control panel at the front of the chassis. These connectors are designed specifically for use with Supermicro server chassis. Refer to the following section for descriptions and pin definitions.

#### JF1 Header Pins

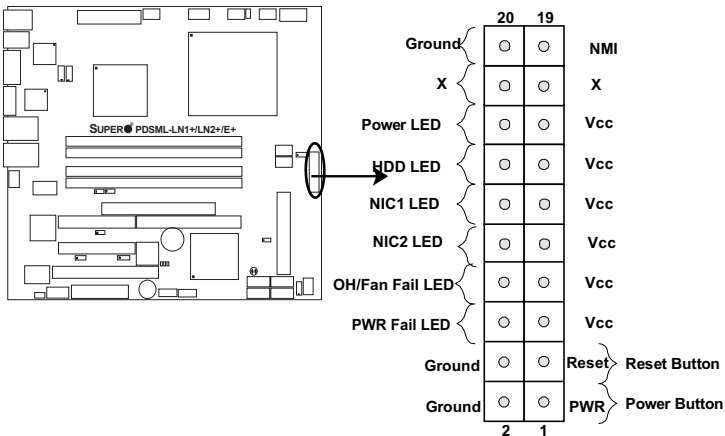

## C. Front Control Panel Pin Definitions

### NMI Button

The non-maskable interrupt button header is located on pins 19 and 20 of JF1. Refer to the table on the right for pin definitions.

NMI Button Pin Definitions (JF1)	
Pin#	Definition
19	Control
20	Ground

### Power LED

The Power LED connection is located on pins 15 and 16 of JF1. Refer to the table on the right for pin definitions. For 3-pin power LED applications, please see Power LED on page 2-19.

Power LED Pin Definitions (JF1)	
Pin#	Definition
15	+5V
16	Ground

#### A. NMI

#### B. PWR LED

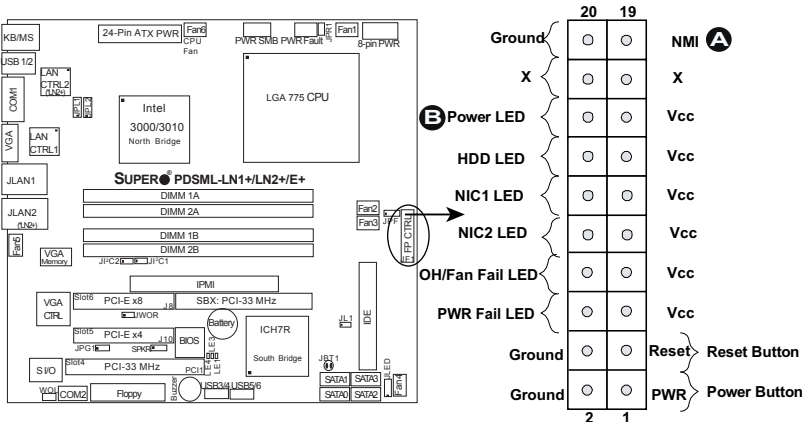

### HDD LED

The HDD LED connection is located on pins 13 and 14 of JF1. Attach the hard drive LED cable here to display disk activity (for any hard drives on the system, including Serial ATA and IDE if available). See the table on the right for pin definitions.

HDD LED Pin Definitions (JF1)	
Pin#	Definition
13	+5V
14	HD Active

### NIC1/NIC2 LED Indicators

The NIC (Network Interface Controller) LED connection for GLAN port1 is located on pins 11 and 12 of JF1, for GLAN port2 is on Pins 9 and 10 of JF1. Attach the NIC LED cables to display network activity. Refer to the table on the right for pin definitions.

GLAN1/2 LED Pin Definitions (JF1)	
Pin#	Definition
9/11	Vcc
10/12	Ground

- A. HDD LED
- B. GLAN1 LED
- C. GLAN2 LED

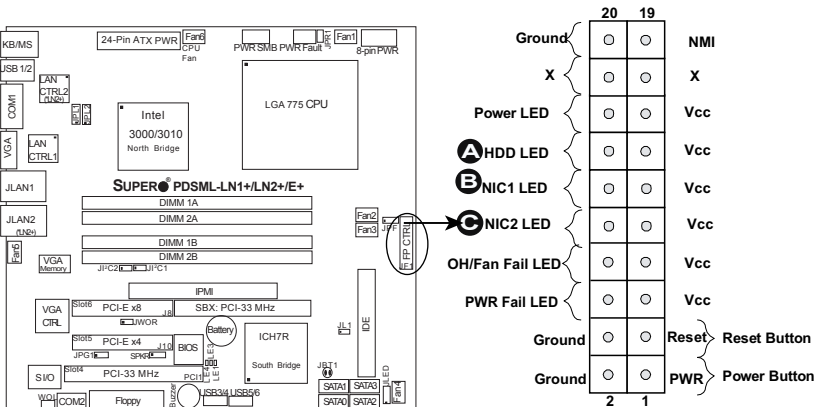

### Overheat/FanFail LED

Connect an LED cable to the OH/Fan Fail connection on pins 7 and 8 of JF1 to provide advanced warning of chassis overheating or system fan failure. Refer to the table on the right for pin definitions.

OH/Fan Fail Indicator Status	
State	Definition
Off	Normal
On	Overheat
Flashing	Fan Fail

OH/Fan Fail LED Pin Definitions (JF1)	
Pin#	Definition
7	Vcc
8	Ground

### PWR Fail LED

The Power Fail LED connection is located on pins 5 and 6 of JF1. Refer to the tables on the right for pin definitions and color messages.

PWR Fail Indicator Status	
State	Definition
Green	PWR On, System Normal
Amber	Redundant PWR Failure

PWR Fail LED Pin Definitions (JF1)	
Pin#	Definition
5	Vcc
6	Ground

A. OH/Fan Fail LED

B. PWR Fail LED

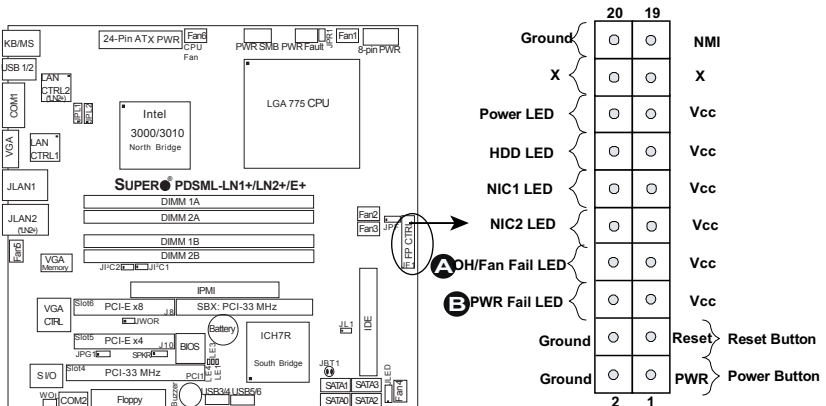

### Reset Button

The Reset Button connection is located on pins 3 and 4 of JF1. Attach it to the hardware reset switch on the computer case. Refer to the table on the right for pin definitions.

Reset Button Pin Definitions (JF1)	
Pin#	Definition
3	Reset
4	Ground

### Power Button

The Power Button connection is located on pins 1 and 2 of JF1. Momentarily contacting both pins will power on/off the system. This button can also be configured to function as a suspend button (with a setting in BIOS - see Chapter 4). To turn off the power when set to suspend mode, press the button for at least 4 seconds. Refer to the table on the right for pin definitions.

Power Button Pin Definitions (JF1)	
Pin#	Definition
1	Signal
2	+3V Standby

A. Reset Button

B. PWR Button

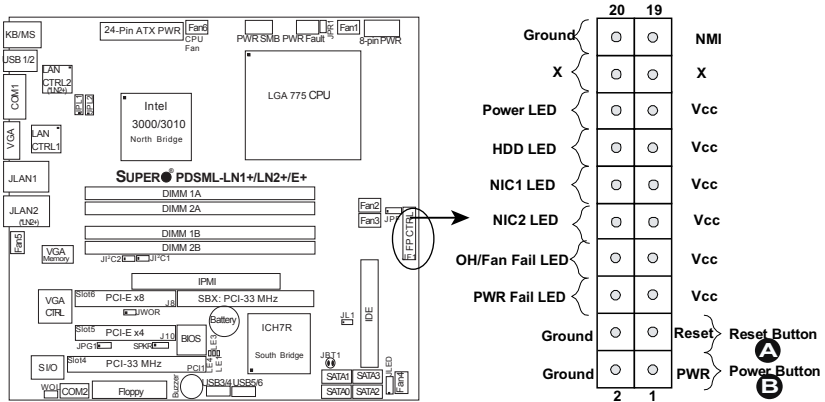



## 2-6 Connectors and Headers

### ATX Power Connector

The main power supply connector (JPW1) on the PDSML-LN1+/PDSML-LN2+/PDSML-E+ meets the Server System Infrastructure (SSI) specification. You can only use a 24-pin power supply cable on the motherboard. Make sure that the orientation of the connector is correct. You must also use the 8-pin (JPW2) processor power connector for adequate power supply to the system (See below). See the table on the right for pin definitions.

ATX Power 24-pin Connector Pin Definitions			
Pin#	Definition	Pin #	Definition
13	+3.3V	1	+3.3V
14	-12V	2	+3.3V
15	COM	3	COM
16	PS_ON	4	+5V
17	COM	5	COM
18	COM	6	+5V
19	COM	7	COM
20	Res (NC)	8	PWR_OK
21	+5V	9	5VSB
22	+5V	10	+12V
23	+5V	11	+12V
24	COM	12	+3.3V

### Processor Power Connector

In addition to the Primary ATX power connector (above), the 12V 8-pin Processor connector at JPW2 must also be connected to your power supply to provide adequate power supply to the system.

8-pin Processor Power Pin Definitions	
Pins	Definition
1 through 4	Ground
5 through 8	+12V

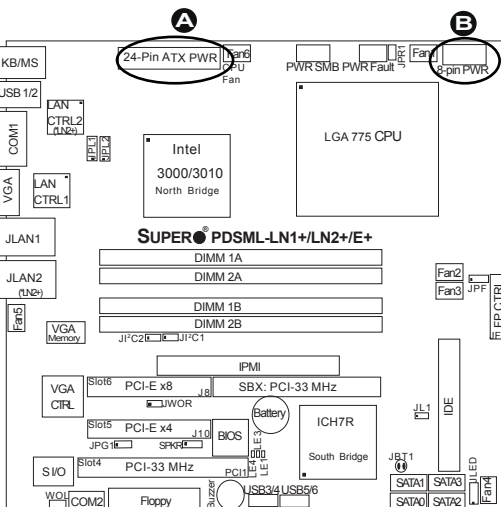

A. 24-pin ATX PWR

B.

### Serial Ports

Two serial headers: COM1 (J31), COM2 are included on the motherboard. COM1 (J31) is a port located next to VGA port. See the table on the right for pin definitions.

Serial Port Pin Definitions (COM1/COM2)			
Pin #	Definition	Pin #	Definition
1	CD	6	DSR
2	RD	7	RTS
3	TD	8	CTS
4	DTR	9	RI
5	Ground	10	NC

**Note:** Pin 10 is included on the header but not on the port. NC indicates no connection.

### Chassis Intrusion

A Chassis Intrusion header is located at JL1. Attach the appropriate cable to inform you of a chassis intrusion (via the Supero Doctor Software).

Chassis Intrusion Pin Definitions (JL1)	
Pin#	Definition
1	Intrusion Input
2	Ground

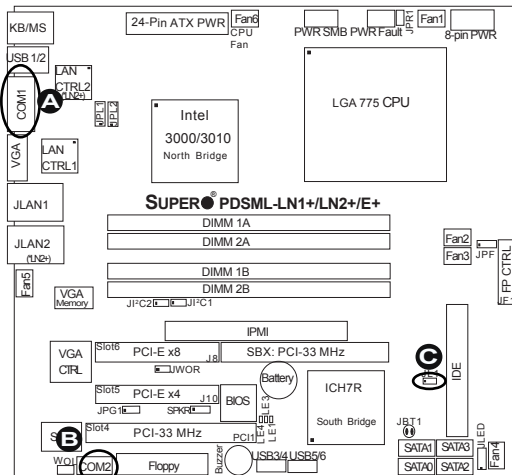

- A. COM1
- B. COM2
- C. Chassis Intrusion

## Universal Serial Bus (USB)

There are two Universal Serial Bus ports (BP USB 1/2) (J15) located on the I/O back panel and additional four USB ports located at J46 (FP USB 3/4) and J45 (FP USB 5/6) on the motherboard. These ports (FP USB3 /4, FPUSB 5/6) can be used to provide front side chassis access. **Note:** cables are not included. See the table on the right for pin definitions.

Universal Serial Bus Pin Definitions			
Back Panel USB Pin #	Definition	Front Panel USB Pin #	Definition
1	+5V	1	+5V
2	PO-	2	PO-
3	PO+	3	PO+
4	Ground	4	Ground
5	N/A	5	Key

## GLAN (Giga-bit Ethernet Ports)

There is a Giga-bit (GLAN) Ethernet port on the PDSML-LN1+ and two GLAN ports on the PDSML-LN2+ and PDSML-E+. The GLAN ports are located next to the VGA port on the IO backplane. The GLAN port accepts RJ45 type cables.

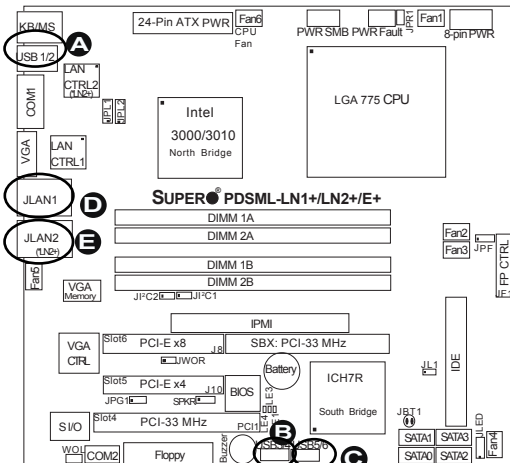

**A.** BP USB 1/2

**B.** FP USB 3/4

**C.** FP USB 5/6

**D.** GLAN1

**E.** GLAN2 (\*PDSML-LN2+ and PDSML-E+ only.)

### ATX PS/2 Keyboard and PS/2 Mouse Ports

The ATX PS/2 keyboard and PS/2 mouse are located next to the Back Panel USB ports on the motherboard. See the table at right for pin definitions. (Note: NC=No connection.)

PS/2 Keyboard and Mouse Port Pin Definitions	
Pin#	Definition
1	Data
2	NC
3	Ground
4	VCC
5	Clock
6	NC

### Speaker Connector

The speaker connector, located at J9, allows you to choose between using the internal or an external speaker. For the internal speaker, short pins 3 and 4. To use an external speaker, place the speaker cable header on all four pins. See the table on the right.

Speaker Connector (J9)	
Pin Setting	Definition
Pins 3-4	Internal Speaker
Pins 1-4	External Speaker

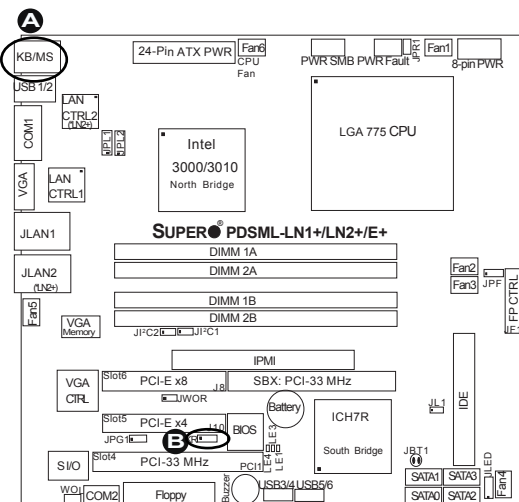

- A. Keyboard/Mouse
- B. Speaker

## Fan Headers

The PDSML-LN1+/PDSML-LN2+/PDSML-E+ has six fan connections (Fan1 to Fan6). Fan6 is designated as the CPU Cooling Fan. **Note:** all fans are 4-pin fans. However, Pins 1-3 of the fan headers are backward compatible with the traditional 3-pin fans. See the table on the right for pin definitions. The onboard fan speeds are controlled by Thermal Management in the BIOS Hardware Monitoring Setting. When using Thermal Management setting, please use all 3-pin fans or all 4-pin fans on the motherboard. Please do not use both 3-pin fans and 4-pin fans on the same board. The default setting is "Disabled" which will allow the onboard fans to run at the full speed.

Fan Header Pin Definitions (Fan1-5)	
Pin#	Definition
1	Ground (Black)
2	+12V (Red)
3	Tachometer
4	PWM_Control

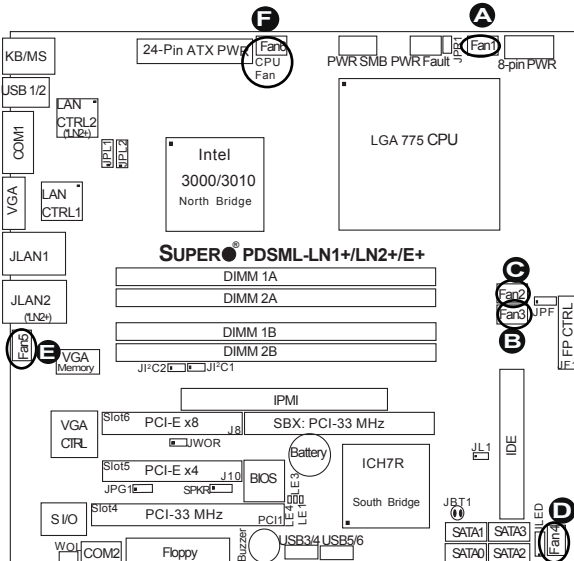

- A. Fan1
- B. Fan2
- C. Fan3
- D. Fan4
- E. Fan5
- F. Fan6 (CPU Fan)

### Wake-On-Ring

The Wake-On-Ring header is located at JWOR. This function allows an incoming call to the modem to "wake up" your system when in the suspend state. See the table on the right for pin definitions. You must have a Wake-On-Ring card and cable to use this feature.

Wake-On-Ring Pin Definitions (JWOR)	
Pin#	Definition
1	Ground (Black)
2	Wake-up

### Wake-On-LAN

The Wake-On-LAN header is located at JWOL. See the table on the right for pin definitions. You must enable the Wake-On-LAN function in the BIOS and also have a LAN card with a Wake-on-LAN connector and cable to use this feature.

Wake-On-LAN Pin Definitions (JWOL)	
Pin#	Definition
1	+5V Standby
2	Ground
3	Wake-up

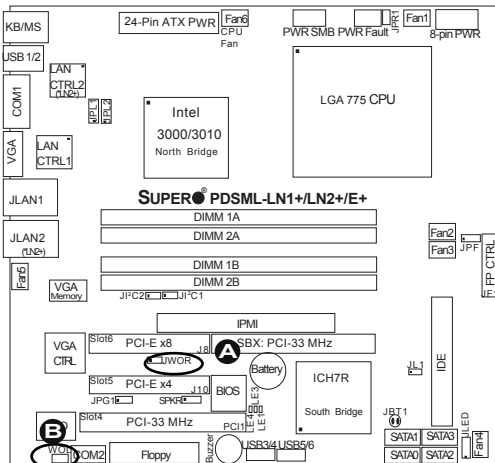

A. WOR

B. WOL

## VGA Connector

A VGA connector (JG1) is located next to the COM1 port on the IO backplane. Refer to the board layout below for the location.

## Power LED

The Power LED connector is designated JLED. This connection is used for 3-pin LED applications. It is used to indicate that power has been supplied to the system. See the table on the right for pin definitions. For 2-pin power LED, please see Power LED on page 2-9.

PWR LED Pin Definitions	
Pin#	Definition
1	+5V
2	Key
3	Ground

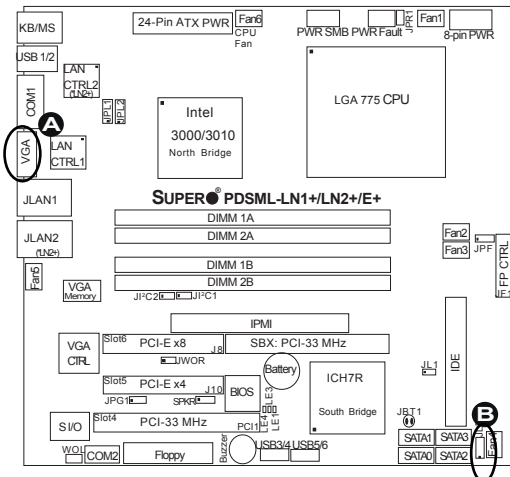

A. VGA

B. PWR LED

### Power Fault

Connect a cable from your power supply to the Power Fault header (PW3) to provide warning of power supply failure. This warning signal is passed through the PWR\_LED pin to indicate of a power failure on the chassis. See the table on the right for pin definitions.

PWR Fault Pin Definitions	
Pin#	Definition
1	Pin 1 Fail Signal
2	Pin 2 Fail Signal
3	Pin 3 Fail Signal
4	Pin 4 Fail Signal

**Note:** This feature is only available when using redundant Supermicro power supplies.

### Power SMB (I<sup>2</sup>C) Connector

Power SMB (I<sup>2</sup>C) Connector (PW4) monitors onboard power supply, fan and system temperature. See the table on the right for pin definitions.

PWR SMB Pin Definitions	
Pin#	Definition
1	Clock
2	Data
3	PWR Fail
4	Ground
5	+3.3V

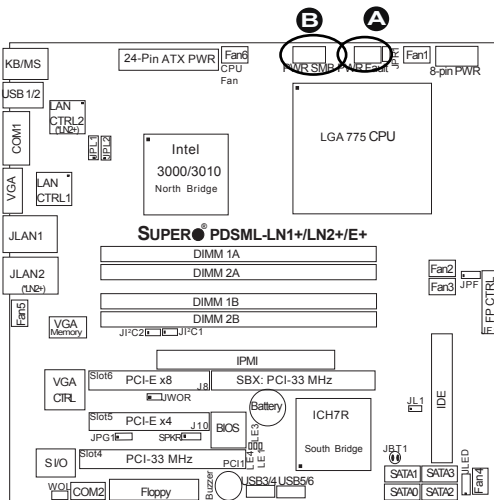

A. Power Fault

B. Power SMB



## Redundant PWR Alarm Reset Connector

A Redundant Power Supply Fail Alarm Reset is located at JPR1. Refer to the board layout below for the location.

Redundant PWR Supply Alarm Reset	
Jumper	Definition
On	Enabled
Off	Disabled

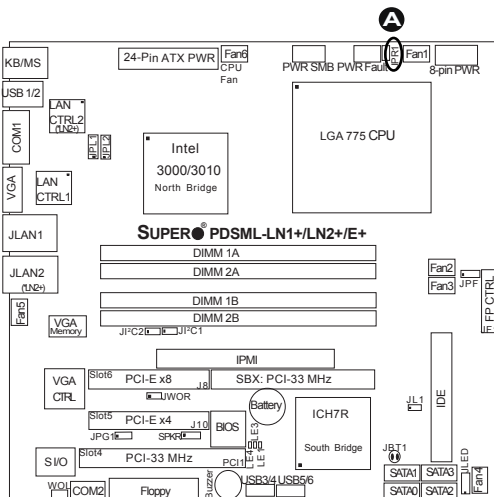

A. PWR Alarm Reset

## 2-7 Jumper Settings

### Explanation of Jumpers

To modify the operation of the motherboard, jumpers can be used to choose between optional settings. Jumpers create shorts between two pins to change the function of the connector. Pin 1 is identified with a square solder pad on the printed circuit board. See the motherboard layout pages for jumper locations.

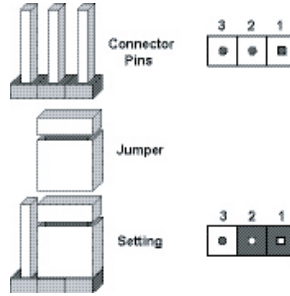

**Note:** On two pin jumpers, "Closed" means the jumper is on and "Open" means the jumper is off the pins.

### GLAN Enable/Disable

JPL1/JPL2 enable or disable GLAN Ports 1/2 on the motherboard. See the table on the right for jumper settings. The default setting is enabled. (\*JPL2 is available on the PDSMML-LN2+ and PDSMML-E+ only.)

GLAN Enable Jumper Settings	
Jumper Setting	Definition
Pins 1-2	Enabled
Pins 2-3	Disabled

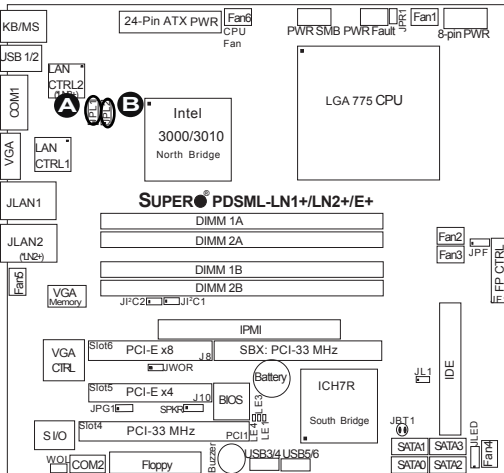

- A. GLAN1 Enable
  - B. GLAN2 Enable
- (\*PDSMML-LN2+ and PDSMML-E+ only)

## CMOS Clear

JBT1 is used to clear CMOS. Instead of pins, this "jumper" consists of contact pads to prevent the accidental clearing of CMOS. To clear CMOS, use a metal object such as a small screwdriver to touch both pads at the same time to short the connection. Always remove the AC power cord from the system before clearing CMOS.



**Note:** For an ATX power supply, you must completely shut down the system, remove the AC power cord and then short JBT1 to clear CMOS. **Do not use the PW ON connector to clear CMOS.**

## VGA Enable/Disable

JPG1 enables or disables the VGA Connector on the motherboard. See the table on the right for jumper settings. The default setting is enabled.

VGA Enable/Disable Jumper Settings	
Jumper Setting	Definition
Pins 1-2	Enabled
Pins 2-3	Disabled

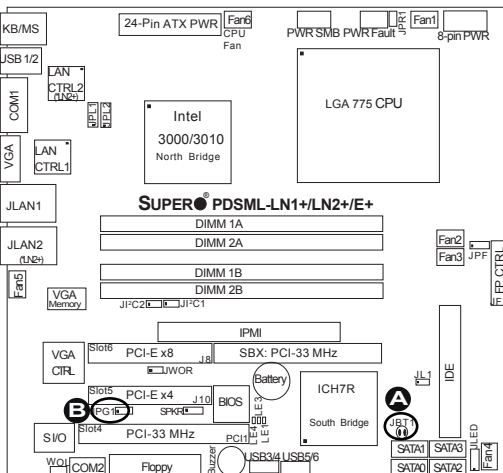

A. CMOS Clear

B. VGA Enable

### Power Force On Enable/Disable

Jumper JPF allows you to enable or disable the Power Force On function. If enabled, the power will always stay on automatically. If this function is disabled (the normal setting), the user needs to press the power button to power on the system.

Power Force On Enable/Disable Jumper Settings (JPF)	
Jumper Setting	Definition
Open	Normal
Closed	Force On

### I<sup>2</sup>C Bus to PCI/PCI-E Slots

J1<sup>2</sup>C1/J1<sup>2</sup>C2 allows you to enable the I<sup>2</sup>C Bus to communicate with all PCI and PCI-Express slots. For the jumpers to work properly, please set both jumpers to the same setting. If enabled, both jumpers must be enabled. If disabled, both jumpers must be disabled. See the table on the right for jumper settings. (The default setting is enabled.)

I <sup>2</sup> C Bus to PCI Slots 1/2 Jumper Settings	
Jumper Setting	Definition
Open	Disabled
Closed	Enabled

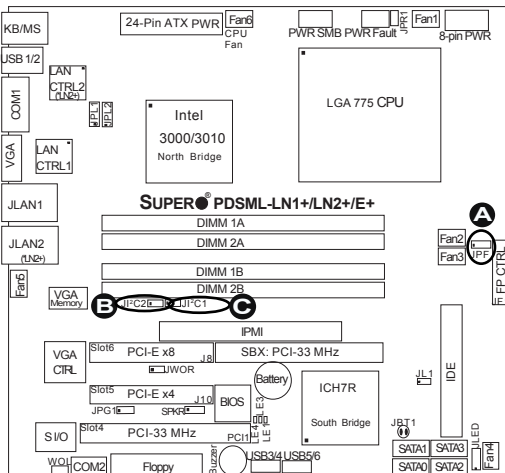

- A. PWR Force On
- B. I<sup>2</sup>C Bus to PCI/PCI-E Slots
- C. I<sup>2</sup>C Bus to PCI/PCI-E Slots

## 2-8 Onboard LED Indicators

### GLAN LEDs

There are two GLAN ports on the PDSML-LN2+/PDSML-E+ and one GLAN port on the PDSML-LN1+. Each Gigabit Ethernet LAN port has two LEDs. The yellow LED indicates activity while the other LED may be green, orange or off to indicate the speed of the connection. See the table at right for the functions associated with the second LED.

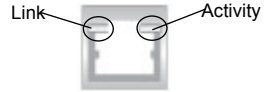

(\*Rear View: When facing the rear side of the system)

#### GLAN Activity LED Indicator

LED Color	Definition
Yellow	Flashing: 10Mbps/ 100Mbps/1 Gbps

#### GLAN LED Link Indicator

LED Color	Definition
Off	10Mbps or No Connection
Green	100 Mbps
Amber	1 Gbps

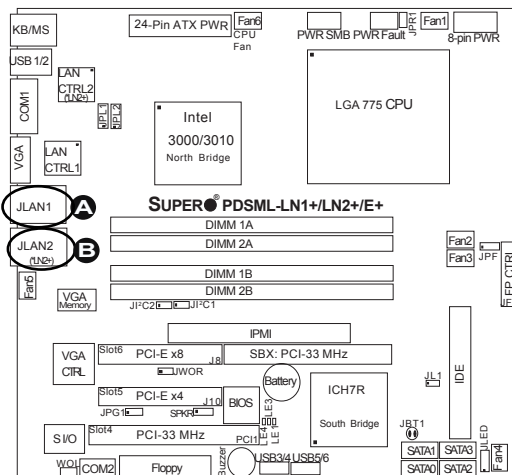

A. JLAN 1

B. JLAN 2

## 2-9 Floppy, Hard Disk Drive and IPMI 2.0 Connections

Note the following when connecting the floppy and hard disk drive cables:

- The floppy disk drive cable has seven twisted wires.
- A red mark on a wire typically designates the location of pin 1.
- A single floppy disk drive ribbon cable has two connectors to provide for two floppy disk drives. The connector with twisted wires always connects to drive A, and the connector that does not have twisted wires always connects to drive B.

### Floppy Connector

The floppy connector is located at J27. See the table below for pin definitions.

Floppy Drive Connector Pin Definitions			
Pin#	Definition	Pin #	Definition
1	Ground	2	FDHDIN
3	Ground	4	Reserved
5	Key	6	FDEDIN
7	Ground	8	Index
9	Ground	10	Motor Enable
11	Ground	12	Drive Select B
13	Ground	14	Drive Select B
15	Ground	16	Motor Enable
17	Ground	18	DIR
19	Ground	20	STEP
21	Ground	22	Write Data
23	Ground	24	Write Gate
25	Ground	26	Track 00
27	Ground	28	Write Protect
29	Ground	30	Read Data
31	Ground	32	Side 1 Select
33	Ground	34	Diskette

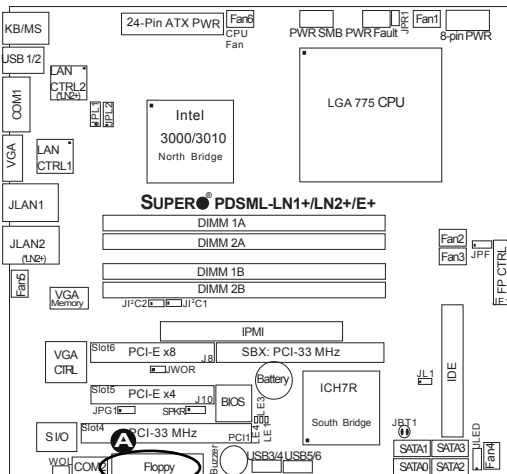

A. Floppy

## IDE Connector

There is one IDE Connector (J3) on the motherboard. See the table on the right for pin definitions.

IDE Drive Connectors Pin Definitions (IDE)			
Pin#	Definition	Pin #	Definition
1	Reset IDE	2	Ground
3	Host Data 7	4	Host Data 8
5	Host Data 6	6	Host Data 9
7	Host Data 5	8	Host Data 10
9	Host Data 4	10	Host Data 11
11	Host Data 3	12	Host Data 12
13	Host Data 2	14	Host Data 13
15	Host Data 1	16	Host Data 14
17	Host Data 0	18	Host Data 15
19	Ground	20	Key
21	DRQ3	22	Ground
23	I/O Write	24	Ground
25	I/O Read	26	Ground
27	IOCHRDY	28	BALE
29	DACK3	30	Ground
31	IRQ14	32	IOCS16
33	Addr1	34	Ground
35	Addr0	36	Addr2
37	Chip Select 0	38	Chip Select 1
39	Activity	40	Ground

## IPMI 2.0 Slot (For PDSML-LN2+ and PDSML-E+ only)

There is an IPMI 2.0 Slot on the PDSML-LN2+ and PDSML-E+. Refer to the layout below for the location. Please refer to Section 1-8 for more information on how to use this feature.

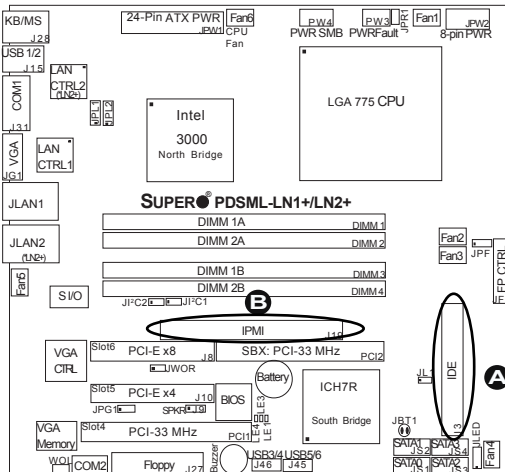

A. IDE#1 Drive

B. 1U IPMI

## **Notes**



## Chapter 3

# Troubleshooting

### 3-1 Troubleshooting Procedures

Use the following procedures to troubleshoot your system. If you have followed all of the procedures below and still need assistance, refer to the 'Technical Support Procedures' and/or 'Returning Merchandise for Service' section(s) in this chapter. Always disconnect the AC power cord before adding, changing or installing any hardware components.

#### Before Power On

1. Check that the Standby PWR LED (LE1) is not lit. **Note:** If LE1 is on, it indicates that Standby PWR is on. Be sure to turn off the power supply before installing or removing the components.
2. Make sure the 8-pin 12v power connector at JPW2 is connected.
3. Make sure no short circuits between the motherboard and chassis.
4. Disconnect all ribbon/wire cables from the motherboard, including those for the keyboard and mouse.
5. Remove all add-on cards.
6. Install a CPU and heatsink (Be sure that it is fully seated,) and then, connect the chassis speaker and the power LED to the motherboard. Check all jumper settings as well.
7. Make sure to use the correct type of CMOS battery as specified by the Manufacturer. Do not install the CMOS battery upside down to avoid possible explosion.

#### No Power

1. Make sure no short circuits between the motherboard and the chassis.
2. Make sure that all jumpers are set to their default positions.
3. Check if the 115V/230V switch on the power supply is properly set.
4. Turn the power switch on and off to test the system.
5. The battery on your motherboard may be old. Check to verify that it still supplies ~3VDC. If it does not, replace it with a new one.

#### No Video

1. If the power is on, but you have no video—in this case, you will need to remove all the add-on cards and cables first.
2. Use the speaker to determine if any beep codes exist. (Refer to Appendix A for details on beep codes.)
3. Remove all memory modules and turn on the system. (If the alarm is on, check the specs of the memory, reset the memory or try a different one.)

---

### **NOTE**

If you are a system integrator, VAR or OEM, a POST diagnostics card is recommended. For I/O port 80h codes, refer to App. B.

---

### **Memory Errors**

1. Make sure that the DIMM modules are properly installed and fully seated in the slots.
2. You should be using unbuffered, ECC/Non ECC DDR2-677/533 memory (see the next page). Also, it is recommended that you use the same memory speed for all DIMMs in the system. See Section 2-4 for memory limitations.
3. Check for bad DIMM modules or slots by swapping modules between slots and noting the results.
4. Check the power supply voltage 115V/230V switch.

### **Losing the System's Setup Configuration**

1. Please be sure to use a high quality power supply. A poor quality power supply may cause the system to lose the CMOS setup information. Refer to Section 1-6 for details on recommended power supplies.
2. The battery on your motherboard may be old. Check to verify that it still supplies ~3VDC. If it does not, replace it with a new one.
3. If the above steps do not fix the Setup Configuration problem, contact your vendor for repairs.

## **3-2 Technical Support Procedures**

Before contacting Technical Support, please make sure that you have followed all the steps listed below. Also, note that as a motherboard manufacturer, Supermicro does not sell directly to end-users, so it is best to first check with your distributor or reseller for troubleshooting services. They should know of any possible problem(s) with the specific system configuration that was sold to you.

1. Please go through the 'Troubleshooting Procedures' and 'Frequently Asked Question' (FAQ) sections in this chapter or see the FAQs on our web site (<http://www.supermicro.com/support/faqs/>) before contacting Technical Support.
2. BIOS upgrades can be downloaded from our web site at (<http://www.supermicro.com/support/bios/>).

**Note: Not all BIOS can be flashed, some can be flashed, depending on the modifications to the boot block code.**

**3. If you've followed the instructions above to troubleshoot your system, and still cannot resolve the problem, then please contact Supermicro's technical support and provide them with the following information:**

- Motherboard model and PCB revision number
- BIOS release date/version (this can be seen on the initial display when your system first boots up)
- System configuration

An example of a Technical Support form is on our web site at

<http://www.supermicro.com/support/contact.cfm>.

4. Distributors: For immediate assistance, please have your account number ready when placing a call to our technical support department. We can be reached by e-mail at support@supermicro.com, by phone at: (408) 503-8000, option 2, or by fax at (408)503-8019.

### 3-3 Frequently Asked Questions

**Question: What type of memory does my motherboard support?**

**Answer:** The PDSML-LN1+/PDSML-LN2+/PDSML-E+ supports up to 8 GB of **unbuffered**, ECC/Non ECC, DDR2-677/533, two-way interleaved or non-interleaved SDRAM. See Section 2-4 for details on installing memory.

**Question: Why does Microsoft Windows XP (SP2) and Windows Vista show less memory than what is physically installed?**

**Answer:** Microsoft implemented a design change in Windows XP with Service Pack 2 (SP2) and Windows Vista. This change is specific to the Physical Address Extension (PAE) mode behavior which improves driver compatibility. For more information, please read the following article at Microsoft's Knowledge Base website at: <http://support.microsoft.com/kb/888137>.

**Question: How do I update my BIOS?**

**Answer:** It is recommended that you **do not** upgrade your BIOS if you are not experiencing any problems with your system. Updated BIOS files are located on our web site at <http://www.supermicro.com/support/bios/>. Please check our BIOS warning message and the information on how to update your BIOS on our web site. Select your motherboard model and download the BIOS (.rom) file to your computer. Also, check the current BIOS revision and make sure that it is newer than your BIOS before downloading. You may choose the zip file or the .exe file. If you choose the zipped BIOS file, please unzip the BIOS file onto a bootable device or a USB pen/thumb drive. To flash the BIOS, run the batch

file named "flash.bat" with the new BIOS .rom file from your bootable device or USB pen/thumb drive. Use the following format:

```
F:\> flash xxxxxxxx.rom <Enter>
```

**Note:** Be sure to insert a space immediately after "flash" and use only the file named "flash.bat" to update the BIOS.

When completed, your system will automatically reboot. If you choose the .exe file, please run the .exe file under Windows to create the BIOS flash floppy disk. Insert the floppy disk into the system you wish to flash the BIOS. Then, boot the system to the floppy disk. The BIOS utility will automatically flash the BIOS without any prompts. Please note that this process may take a few minutes to complete. Do not be concerned if the screen is paused for a few minutes.



**Warning:** Do not shut down or reset the system while updating the BIOS to prevent possible system boot failure!

When the BIOS flashing screen is completed, the system will reboot and will show "Press F1 or F2". At this point, you will need to load the BIOS defaults. Press <F1> to go to the BIOS setup screen, and press <F9> to load the default settings. Next, press <F10> to save and exit. The system will then reboot.

**Note:** The SPI BIOS chip installed on this motherboard is not removable. To repair or replace a damaged BIOS chip, please send your motherboard to RMA at Supermicro for service.

**Question: What's on the CD that came with my motherboard?**

**Answer:** The supplied compact disc has quite a few drivers and programs that will greatly enhance your system. We recommend that you review the CD and install the applications you need. Applications on the CD include chipset drivers for Windows, security and audio drivers.

**Question: How do I connect the ATA100/66 cable to my IDE device(s)?**

**Answer:** The 80-wire/40-pin high-density ATA100/66 IDE cable that came with your system has two connectors to support two drives. This special cable must be used to take advantage of the speed the ATA100/66 technology offers.

**Connect the blue connector to the onboard IDE header and the other connector(s) to your hard drive(s).** Consult the documentation that came with your disk drive for details on actual jumper locations and settings.

### **3-4 Returning Merchandise for Service**

A receipt or copy of your invoice marked with the date of purchase is required before any warranty service will be rendered. You can obtain service by calling your vendor for a Returned Merchandise Authorization (RMA) number. When returning to the manufacturer, the RMA number should be prominently displayed on the outside of the shipping carton, and mailed prepaid or hand-carried. Shipping and handling charges will be applied for all orders that must be mailed when service is complete.

This warranty only covers normal consumer use and does not cover damages incurred in shipping or from failure due to the alteration, misuse, abuse or improper maintenance of products.

During the warranty period, contact your distributor first for any product problems.



# Chapter 4

## BIOS

### 4-1 Introduction

This chapter describes the Phoenix BIOS™ Setup utility for the PDSML-LN1+/PDSML-LN2+/PDSML-E+. The Phoenix ROM BIOS is stored in a flash chip and can be easily upgraded using a floppy disk-based program.

**Note:** Due to periodic changes to the BIOS, some settings may have been added or deleted and might not yet be recorded in this manual. Please refer to the Manual Download area of the Supermicro web site <<http://www.supermicro.com>> for any changes to the BIOS that may not be reflected in this manual.



**Warning:** Do not shut down or reset the system while updating the BIOS to prevent possible boot failure.

### System BIOS

The BIOS is the Basic Input Output System used in all IBM® PC, XT™, AT®, and PS/2® compatible computers. The Phoenix BIOS flash chip stores the system parameters, types of disk drives, video displays, etc. in the CMOS. The CMOS memory requires very little electrical power. When the computer is turned off, a backup battery provides power to the BIOS flash chip, enabling it to retain system parameters. Each time the computer is powered on, the computer is configured with the values stored in the BIOS ROM by the system BIOS, which gains control at boot-up.

### How To Change the Configuration Data

The CMOS information that determines the system parameters may be changed by entering the BIOS Setup utility. This Setup utility can be accessed by pressing the <Delete> key at the appropriate time during system boot. (See below.)

### Starting the Setup Utility

Normally, the only visible POST (Power On Self Test) routine is the memory test. As the memory is being tested, press the <Delete> key to enter the main menu of the BIOS Setup utility. From the main menu, you can access the other setup screens, such as the Security and Power menus. Beginning with Section 4-3, detailed descriptions are given for each parameter setting in the Setup utility.

## 4-2 Running Setup

*\*Default settings are in bold text unless otherwise noted.*

The BIOS setup options described in this section are selected by choosing the appropriate text from the main BIOS Setup screen. All displayed text is described in this section, although the screen display is often all you need to understand how to set the options (Refer to the next page).

When you first power on the computer, the Phoenix BIOS™ is immediately activated.

While the BIOS is in control, the Setup program can be activated in one of two ways:

1. By pressing <Delete> immediately after turning the system on, or
2. When the message shown below appears briefly at the bottom of the screen during the POST (Power On Self-Test), press the <Delete> key to activate the main Setup menu:

**Press the <Delete> key to enter Setup**

**Note: Please load "System Setup Default" when using the system the first time.**

## 4-3 Main BIOS Setup

All main Setup options are described in this section. The main BIOS Setup screen is displayed below.

Press the <Esc> key to exit the CMOS Setup Menu. The next section describes in detail how to navigate through the menus.

Items that use submenus are indicated with the ► icon. With the item highlighted, press the <Enter> key to access the submenu.

After entering the submenu, use the Up/Down arrow keys to move among the different settings in each menu. Use the Left/Right arrow keys to change the options for each setting. Press <Tab>, <Shift-Tab>, or <Enter> to select a field.



## Main BIOS Setup Menu

PhoenixBIOS Setup - Copyright 1985-2004 Phoenix Technologies Ltd.		
Main Advanced Security Boot Exit		
System Time:	[10:29:55]	Item Specific Help  <Tab>, <Shift-Tab>, or <Enter> selects field.
System Date:	[01-26-2006]	
BIOS Date	[10-24-2006]	
Legacy Diskette A:	[1.44/1.25 MB 3½"]	
Parallel ATA:	[Disabled]	
Serial ATA:	[Enabled]	
Native Mode Operation:	[Auto]	
SATA Controller Mode:	[Compatible]	
SATA RAID	[Disabled]	
SATA AHCI	[Disabled]	
ICH Raid CodeBase	[Intel]	
▶IDE Primary/Master		
▶IDE Primary/Slave		
▶SATA Port 1		
▶SATA Port 2		
▶SATA Port 3		
▶SATA Port 4		
System Memory:	[XXXX KB]	
Extended Memory:	[XXXX KB]	
F1 Help    F4 Select Item    ~/* Change Values    F9 Setup Defaults Esc Exit    ++ Select Menu    Enter Select ▶ Sub-Menu    F10 Previous Values		

### Main Setup Features

#### System Time

To set the system date and time, key in the correct information in the appropriate fields. Then press the <Enter> key to save the data.

#### System Date

Using the arrow keys, highlight the month, day and year fields, and enter the correct data. Press the <Enter> key to save the data.

#### BIOS Date

This feature allows the BIOS to display the date when this version of BIOS was built.

#### Legacy Diskette A

This setting allows the user to set the type of floppy disk drive installed as diskette A. The options are Disabled, 360Kb 5.25 in, 1.2MB 5.25 in, 720Kb 3.5 in, **1.44/1.25MB, 3.5 in** and 2.88MB 3.5 in.

### Parallel ATA

This setting allows the user to enable or disable the function of Parallel ATA and configure Parallel ATA settings. The options are Disabled and **Enabled** (Parallel ATA).

### Serial ATA

This setting allows the user to enable or disable Serial ATA. The options are Disabled and **Enabled**.

### Native Mode Operation

The feature allows the user to set the Native Mode for ATA. The options are: Serial ATA and **Auto**.

### SATA Controller Mode

Select **Compatible** to allow the SATA and PATA drives to be detected automatically and then placed in the Legacy Mode. Select **Enhanced** to allow the SATA and PATA drives to be detected automatically and placed in the Native IDE Mode. **Note: The Enhanced mode is supported by the Windows 2000 OS or a later version.**

When the SATA Controller Mode is set to "Enhanced", the following items will display:

### Serial ATA (SATA) RAID

Select **Enable** to enable the function of Serial ATA RAID. The options are **Enabled** and **Disabled** (\*Default). (\*For the Windows OS environment, if this feature is set to **Enabled**, be sure to use the RAID driver. If set to **Disabled**, use the Non-RAID driver.) Note: If this item-SATA RAID is set to **Enabled**, the next item-"SATA AHCI Enable" will not be available. If this feature is set to "Enhanced", the following feature will be available:

### SATA AHCI

Select **Enable** to enable the function of Serial ATA Advanced Host Interface.



(\***Warning:** Exercise extreme caution when using this function. This feature is for advanced programmers only.) The options are **Enabled** and **Disabled**.

### ICH RAID CodeBase

Select **Intel** to enable Intel's ICH RAID Controller for the Windows OS. Select **Adaptec** to enable Adaptec's RAID Controller for the Linux OS. The options are **Intel** and **Adaptec**.

## ► Primary IDE Master/Slave, Secondary IDE Master/Slave, or Primary IDE Master/Slave, SATA Port 1, SATA Port 2, SATA Port 3, SATA Port 4

These settings allow the user to set the parameters of Primary IDE Master/Slave and Secondary IDE Master/Slave slots. Hit <Enter> to activate the following sub-menu screen for detailed options of these items. Set the correct configurations accordingly. The items included in the sub-menu are:

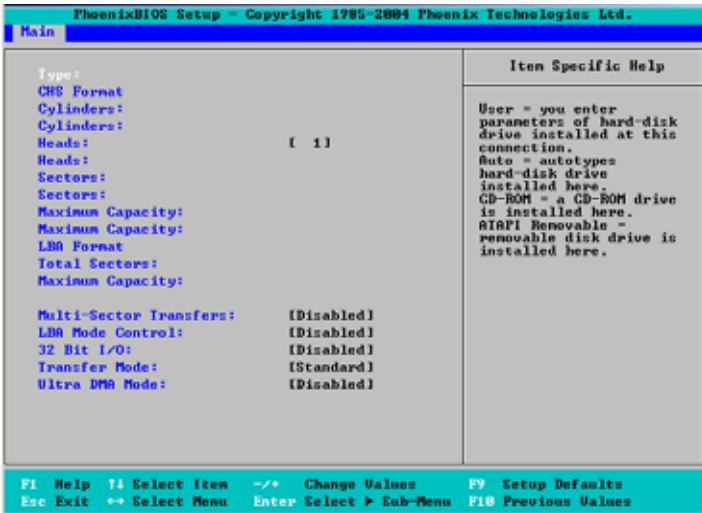

### Type

This feature allows the user to select the IDE hard drive type. The option: "Auto" allows the BIOS to automatically determine the hard drive's capacity, number of heads, etc.). The option "User" will allow the user to enter the parameters of the HDD installed at this connection. Choose the option 1-39 to select a predetermined HDD type. Select CDROM if a CDROM drive is installed. Select ATAPI if a removable disk drive is installed.

### CHS Format

The following items will be displayed by the BIOS:

**TYPE:** This item displays the type of CPU.

**Cylinders:** This item indicates the status of Cylinders.

**Headers:** This item indicates the number of headers.

**Sectors:** This item displays the number of sectors.

**Maximum Capacity:** This item displays the maximum storage capacity of the system.

### **LBA Format**

The following items will be displayed by the BIOS:

**Total Sectors:** This item displays the number of total sectors available in the LBA Format.

**Maximum Capacity:** This item displays the maximum capacity in the LBA Format.

### **Multi-Sector Transfer**

This item allows the user to specify the number of sectors per block to be used in a multi-sector transferring. The options are **Disabled**, 4 Sectors, 8 Sectors, and 16 Sectors.

### **LBA Mode Control**

This item determines if the BIOS will access the Primary IDE Master Device via the LBA mode. The options are Enabled and **Disabled**.

### **32 Bit I/O**

This feature allows the user to enable or disable the function of 32-bit data transferring. The options are Enabled and **Disabled**.

### **Transfer Mode**

This feature allows the user to select the transfer mode. The options are **Standard**, Fast PIO1, Fast PIO2, Fast PIO3, Fast PIO4, FPIO3/DMA1, and FPIO4/DMA2.

### **Ultra DMA Mode**

This feature allows the user to select the Ultra DMA Mode. The options are **Disabled**, Mode 0, Mode 1, Mode 2, Mode 3, Mode 4, and Mode 5.

## **System Memory**

This display informs you how much system memory is detected in the system.

## **Extended Memory**

This display informs you how much extended memory is detected in the system.

## 4-4 Advanced Setup

Choose Advanced from the Phoenix BIOS Setup Utility main menu with the arrow keys. You should see the following display. The items with a triangle beside them have sub menus that can be accessed by highlighting the item and pressing <Enter>. Options for PIR settings are displayed by highlighting the setting option using the arrow keys and pressing <Enter>. All Advanced BIOS Setup options are described in this section.



### ► Boot Features

Access the submenu to make changes to the following settings.

#### QuickBoot Mode

If enabled, this feature will speed up the POST (Power On Self Test) routine by skipping certain tests after the computer is turned on. The settings are **Enabled** and Disabled. If Disabled, the POST routine will run at normal speed.

#### Quiet Boot

Set to Enabled to display full screen during POST. The settings are **Enabled** and Disabled.

#### POST Errors

Enable this feature to force the system to pause and display an error message during POST when an error is detected. The settings are **Enabled** and Disabled.

### **ACPI Mode**

Use the setting to determine if you want to employ ACPI (Advanced Configuration and Power Interface) power management on your system. The options are **Yes** and **No**.

### **Enable Multimedia Timer**

Set this to **Yes** support the High Performance Event timer for Windows XP/2003 and later. The settings are **Yes** and **No**.

### **Power Button Behavior**

If set to **Instant-Off**, the system will power off immediately as soon as the user hits the power button. If set to **4-sec.**, the system will power off when the user presses the power button for 4 seconds or longer. The options are **instant-off** and **4-sec override**.

### **Resume On Modem Ring**

Select **On** to "wake your system up" when an incoming call is received by your modem. The options are **On** and **Off**.

### **Resume On PME#**

Select **On** to control the System "Wake-Up" features from the PME# of a PCI slot. The options are **On** and **Off**.

### **Power Loss Control**

This setting allows the user to choose how the system will react when power returns after an unexpected loss of power. The options are **Last State**, **Stay off**, and **Power On**.

### **Watch Dog**

If enabled, this option will automatically reset the system if the system is not active for more than 5 minutes. The options are **Enabled** and **Disabled**.

### **Summary Screen**

This setting allows you to **Enable** or **Disable** the summary screen which displays the system configuration during bootup.

## **►Memory Cache**

### **Memory Cache**

Choose **Enabled** to set the state of Cache Memory. The options are **Enabled** and **Disabled**.

**Cache System BIOS Area**

This setting allows you to designate a reserve area in the system memory to be used as a System BIOS buffer to allow the BIOS to write (cache) its data into this reserved memory area. Select **"Write Protect"** to enable this function, and this area will be reserved for the BIOS ROM access only. Select "Uncached" to disable this function and make this area available for other devices.

**Cache Video BIOS Area**

This setting allows you to designate a reserve area in the system memory to be used as a Video BIOS buffer to allow the BIOS to write (cache) its data into this reserved memory area. Select **Write Protect** to enable the function and this area will be reserved for Video BIOS ROM access only. Select Uncached to disable this function and make this area available for other devices.

**Cache Base 0-512K**

If enabled, this feature will allow the data stored in the base memory area: block 0-512K to be cached (written) into a buffer, a storage area in the Static DRAM (SDROM) or to be written into L1, L2 cache inside the CPU to speed up CPU operations. Select Uncached to disable this function. Select Write Through to allow data to be cached into the buffer and written into the system memory at the same time. Select Write Protect to prevent data from being written into the base memory area of Block 0-512K. Select Write Back to allow the CPU to write data directly back from the buffer without writing data to the System Memory for fast CPU data processing and operation. The options are Uncached, Write Through, Write Protect, and **Write Back**.

**Cache Base 512K-640K**

If enabled, this feature will allow the data stored in the base memory area: block 512K-640K to be cached (written) into a buffer, a storage area in the Static DRAM (SDROM) or to be written into L1, L2 cache inside the CPU to speed up CPU operations. Select Uncached to disable this function. Select Write Through to allow data to be cached into the buffer and written into the system memory at the same time. Select Write Protect to prevent data from being written into the base memory area of Block 512K-640K. Select Write Back to allow the CPU to write data directly back from the buffer without writing data to the System Memory for fast CPU data processing and operation. The options are Uncached, Write Through, Write Protect, and **Write Back**.

**Cache Extended Memory**

If enabled, this feature will allow the data stored in the extended memory area to be cached (written) into a buffer, a storage area in the L1, L2, L3 cache inside the CPU to speed up CPU operations. Select Uncached to disable this function. Select Write Through to allow data to be cached into the buffer and written into

the system memory at the same time. Select Write Protect to prevent data from being written into the extended memory area. Select Write Back to allow the CPU to write data back directly from the buffer without writing data to the System Memory for fast CPU data processing and operation. The options are Uncached, Write Through, Write Protect, and **Write Back**.

#### **Discrete MTRR Allocation**

If enabled, MTRRs (-Memory Type Range Registers) are configured as distinct, separate units and cannot be overlapped. If enabled, the user can achieve better graphic effects when using a Linux graphic driver that requires write-combining with 4GB (or more) of memory. The options are Enabled and **Disabled**.

### **►PCI Configuration**

Access the submenu to make changes to the following settings for PCI devices.

#### **Onboard G-LAN1/G-LAN2 (Gigabit- LAN) OPROM Configuration**

Enabling this option provides the capability to boot from GLAN. The options are Disabled and **Enabled**. Note: G-LAN2 is available on the PDSML-LN2+/PDSML-E+ only.

#### **Reset Configuration Data**

If set to Yes, this setting clears the Extended System Configuration Data- (ESCD) area. The options are Yes and **No**.

#### **►Slot 4 PCI 32(32-bit)/Slot 5 PCI-Exp. x4/Slot 6 PCI 32(32-bit)/Slot 6 PCI-Exp. x8 MHz**

Access the submenu for each of the settings above to make changes to the following:

##### **Option ROM Scan**

When enabled, this setting will initialize the device expansion ROM. The options are **Enabled** and Disabled.

##### **Enable Master**

This setting allows you to enable the selected device as the PCI bus master. The options are **Enabled** and Disabled.

##### **Latency Timer**

This setting allows you to set the clock rate for Bus Master. A high-priority, high-throughput device may benefit from a greater clock rate. The options are **Default**, 0020h, 0040h, 0060h, 0080h, 00A0h, 00C0h, and 00E0h. For Unix, Novell and other Operating Systems, please select the option: other. If a drive fails after the



---

installation of a new software, you might want to change this setting and try again. A different OS requires a different Bus Master clock rate.

### Large Disk Access Mode

This setting determines how large hard drives are accessed. The options are **DOS** or Other (for Unix, Novelle NetWare and other operating systems).

### ► Advanced Chipset Control

Access the submenu to make changes to the following settings.



**\*Warning:** Take Caution when changing the Advanced settings. An incorrect setting, a very high DRAM frequency, or an incorrect DRAM timing may cause the system to become unstable. When this occurs, reset the setting to the default setting.

### Clock Spectrum Feature

If Enabled, the BIOS will monitor the level of Electromagnetic Interference caused by the components and will attempt to decrease the interference whenever needed. The options are Enabled and **Disabled**.

### ECC Condition

Error Checking and Correction (ECC) is a feature that enables the system to detect memory errors. You can specify what type of memory error to watch for, either Single Bit, Multiple Bit or Both. The options are None, Single Bit, **Multiple Bit** and Both. This feature is available only if supported by the memory.

### ECC Error Handler

When a memory error occurs, it generates a system interrupt. Use this feature to specify what type interrupt (or handler) to use. The options are None, NMI (Non-Maskable Interrupt), **SMI (System Management Interrupt)** and SCI (System Control Interrupt). This feature is available only if supported by the memory.

### Route Port 80h Cycles to

This feature allows the user to decide which bus to send the debug information to. The options are **PCI** and LPC.

### USB Function

Set to Enabled to enable the USB function to allow the user to key in a value to a USB item. The options are **Enabled** and Disabled.

### Legacy USB Support

This setting allows you to enable support for the Legacy USB devices. The settings are **Enabled** and Disabled.

## ► Advanced Processor Options

Access the submenu to make changes to the following settings:

### CPU Speed

The feature allows the BIOS to display the CPU Speed.

### Frequency Ratio

This feature allows the user to select the ration for the internal frequency multiplier of the CPU. The options are **Default**, X14, X15, and X16.

### Hyper-threading (\*Available when supported by the CPU.)

This setting allows you to **Enable** or Disable the function of hyper-threading. Enabling hyper-threading results in increased CPU performance. (Applicable for XP systems.)

### Core-Multi-Processing (\*Available when supported by the CPU.)

Set to **Enabled** to use a processor's second core and beyond. (Please refer to Intel's web site for more information.) The options are Disabled and **Enabled**.

### Machine Checking (\*Available when supported by the CPU.)

Set to Enabled to activate the function of Machine Checking and allow the CPU to detect and report hardware (machine) errors via a set of model-specific registers (MSRs). The options are **Disabled** or Enabled.

### Enhanced Intel Speed Step (\*Available when supported by the CPU.)

Select Enabled to use the Enhanced Intel SpeedStep Technology and allows the system to automatically adjust processor voltage and core frequency in an effort to reduce power consumption and heat dissipation. The options are Enabled and **Disabled**. Please refer to Intel's web site for detailed information.

### Thermal Management 2 (\*Available when supported by the CPU.)

Set to **Enabled** to use Thermal Management 2 (TM2) which will lower CPU voltage and frequency when the CPU temperature reaches a pre-defined overheat threshold. Set to Disabled to use Thermal Manager 1 (TM1), allowing CPU clocking to be regulated via CPU Internal Clock modulation when the CPU temperature reaches the overheat threshold.

### Adjacent Cache Line Prefetch

The CPU fetches the cache line for 64 bytes if this option is set to Disabled. The CPU fetches both cache lines for 128 bytes as comprised if Enabled. The options are Disabled and **Enabled**.

**Set Max. Extended CPU CPU ID=3**

Set to Enabled to allow the user set the CPU Maximum Extended ID to 3. The options are **Disabled** and Enabled.

**Echo TPR**

Set to Disabled to allow sending of xTPR messages on the system bus. The options are Enabled and **Disabled**.

**C1 Enhanced Mode (\*Available when supported by the CPU.)**

Set to Enabled to enable the function of Enhanced Halt State to lower CPU voltage/frequency to prevent overheat. The options are **Enabled** and Disabled. **Note:** please refer to Intel's web site for detailed information.

**Intel® Virtualization Technology (\*Available when supported by the CPU.)**

Set to Enabled to utilize enhanced virtualization capabilities provided by the Intel Vanderpool Technology which allows one platform to run multiple operating systems and applications in independent partitions, creating multiple "virtual" systems in one physical computer. The options are Enabled and **Disabled**. **Note:** If there is any change to this setting, you will need to power off and restart the system for the change to take effect. Please refer to Intel's web site for detailed information.

**No Execute Mode Memory Protection**

Set to **Enabled** to enable Execute Disable Bit and allow the processor to classify areas in memory where an application code can execute and where it cannot, and thus preventing a worm or a virus from inserting and creating a flood of codes to overwhelm the processor or damage the system during an attack.

Note: this feature is available when your OS and your CPU support the function of Execute Disable Bit. The options are Disabled and **Enabled**. For more information regarding hardware/software support for this function, please refer to Intel's and Microsoft's web sites.

## ► I/O Device Configuration

Access the submenu to make changes to the following settings.

### KBC Clock input

This setting allows you to set the clock frequency for the Keyboard Clock. The options are 6MHz, 8MHz, **12 MHz**, and 16MHz.

### Serial Port A

This setting allows you to decide how Serial Port A is controlled. The options are **Enabled** (user defined) and Disabled.

#### Base I/O Address

This setting allows you to select the base I/O address for Serial Port A. The options are **3F8**, 2F8, 3E8, and 2E8.

#### Interrupt

This setting allows you to set the Interrupt for Serial Port A. The options are IRQ3 and **IRQ4**.

### Serial Port B

This setting allows you to decide how Serial Port B is controlled. The options are **Enabled** (user defined) and Disabled.

#### Mode

This feature allows the user to set the mode for Serial Port B. The options are **Normal**, IR and ASK-IR.

#### Base I/O Address

This setting allows you to select the base I/O address for Serial Port B. The options are 3F8, **2F8**, 3E8 and 2E8.

#### Interrupt

This setting allows you to set the Interrupt for Serial Port B. The options are **IRQ3** and IRQ4.

### Floppy Disk Controller

This setting allows you to assign control of the floppy disk controller. The options are **Enabled** (user defined), Disabled, and Auto (BIOS and OS controlled).

#### Base I/O Address

This setting allows you to select the base I/O address for the Floppy port. The options are **Primary** and Secondary.

**► DMI Event Logging**

Access the submenu to make changes to the following settings.

**Event Log Validity**

This is a display to inform you of the event log validity. It is not a setting.

**Event Log Capacity**

This is a display to inform you of the event log capacity. It is not a setting.

**View DMI Event Log**

Highlight this item and press <Enter> to view the contents of the event log.

**Event Logging**

This setting allows you to **Enable** or Disable event logging.

**ECC Event Logging**

This setting allows you to **Enable** or Disable ECC event logging.

**Mark DMI Events as Read**

Highlight this item and press <Enter> to mark the DMI events as read.

**Clear All DMI Event Logs**

Select Yes and press <Enter> to clear all DMI event logs. The options are Yes and **No**.

► **Console Redirection**

Access the submenu to make changes to the following settings.

**COM Port Address**

This item allows you to specify if you want to redirect the console to Onboard COM A or to Onboard COM B. This setting can also be **Disabled**.

**BAUD Rate**

This item allows you to select the BAUD rate for console redirection. The options are 300, 1200, 2400, 9600, **19.2K**, 38.4K, 57.6K, and 115.2K.

**Console Type**

This item allows the user to choose from the available options the desired console type for console redirection. The options are VT100, VT100,8bit, PC-ANSI, 7bit, **PC ANSI**, VT100+, VT-UTF8 and ASCII.

**Flow Control**

This item allows you to choose from the available options the flow control for console redirection. The options are: None, XON/XOFF, and **CTS/RTS**.

**Console Connection**

This item allows you to decide how Console Redirection is to be connected: either **Direct** or Via Modem.

**Continue CR after POST**

This item allows you to decide if you want to continue with console redirection after the POST routine. The options are On and **Off**.

► **Hardware Monitoring**

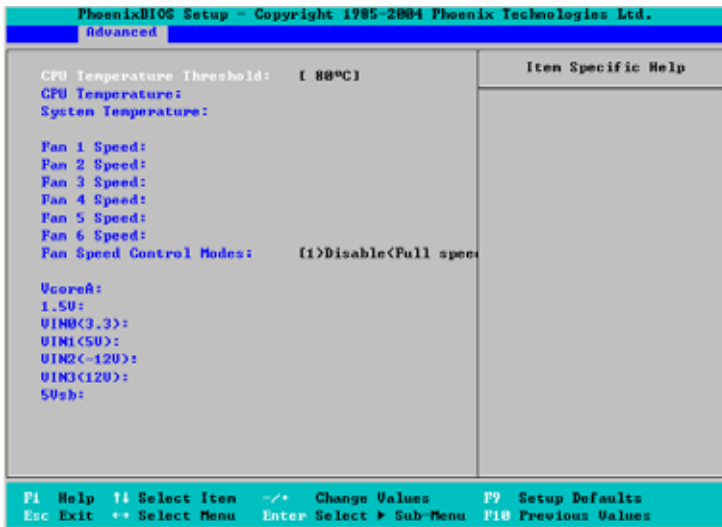

---

## CPU Temperature Threshold

This option allows the user to set a CPU temperature threshold that will activate the alarm system when the CPU temperature reaches this pre-set temperature threshold. The options depend on what type of processor is installed. For Intel Core™ 2 Duo processors ("Conroe"), the values are 55°C, **60°C**, 65°C and 70°C. For Intel Pentium® D processors ("Presler and "Smithfield"), they are 75°C, **80°C**, 85°C and 90°C. (\*See the note below for other information regarding this feature.)

Highlight and hit <Enter> to see the data for the following items:

### CPU Temperature, System Temperature

**Fan 1 Speed - FAN 6 Speed:** If the feature of Auto Fan Control is enabled, the BIOS will automatically display the status of the fans indicated in this item.

### Fan Speed Control Modes

This feature allows the user to decide how the system controls the speeds of the onboard fans. The CPU temperature and the fan speed are correlative. When the CPU on-die temperature increases, the fan speed will also increase, and vice versa. If the option is set to 3-pin fan, the fan speed is controlled by voltage. If the option is set to 4-pin, the fan speed will be controlled by Pulse Width Modulation (PWM). Select 3-pin if your chassis came with 3-pin fan headers. Select 4-pin if your chassis came with 4-pin fan headers. Select Workstation if your system is used as a Workstation. Select Server if your system is used as a Server. Select Disable to disable the fan speed control function and allow the onboard fans to constantly run at full speed (12V). The Options are: **Disabled (Full Speed)**, 3-Pin (Server), 3-pin (Quiet), 4-pin (Server) and 4-pin (Quiet).

### The Voltage status of the following items will be displayed:

VcoreA, +1.5V, -12V, Vdimm, +3.3V, +12V, 5V Standby, 5VDD, P\_VTT, Vbat

**Note:** In the Windows OS environment, the Supero Doctor III settings take precedence over the BIOS settings. When first installed, Supero Doctor III adopts the temperature threshold settings previously set in the BIOS. Any subsequent changes to these thresholds must be made within Supero Doctor, since the SD III settings override the BIOS settings. For the Windows OS to adopt the BIOS temperature threshold settings, please change the SDIII settings to be the same as those set in the BIOS.

## 4-5 Security

Choose Security from the Phoenix BIOS Setup Utility main menu with the arrow keys. You should see the following display. Security setting options are displayed by highlighting the setting using the arrow keys and pressing <Enter>. All Security BIOS settings are described in this section.

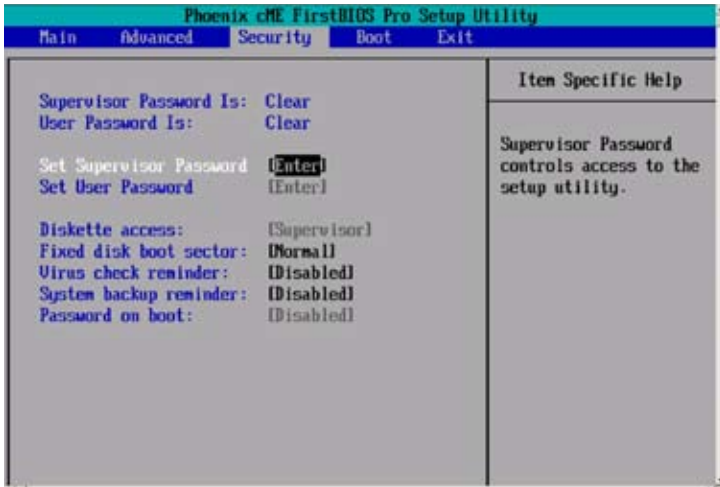

### Supervisor Password Is:

This item indicates if a supervisor password has been entered for the system. Clear means such a password has not been used and Set means a supervisor password has been entered.

### User Password Is:

This item indicates if a user password has been entered for the system. Clear means such a password has not been used and Set means a user password has been entered for the system.

### Set Supervisor Password

When the item Set Supervisor Password is highlighted, hit the <Enter> key. When prompted, type the Supervisor's password in the dialog box to set or to change supervisor's password.

### Set User Password

When the item Set User Password is highlighted, hit the <Enter> key. When prompted, type the user's password in the dialog box to set or to change the user's password.



**Fixed Disk Boot Sector:**

This setting may offer some protection against viruses. Set to Write Protect prevent viruses from writing data codes to the boot sector on the hard drive. The other option is **Normal**.

**Password on Boot:**

When enabled, a password is required when the system boots up. The options are Enabled (password required) and **Disabled** (password not required).

**4-6 Boot**

Choose Boot from the Phoenix BIOS Setup Utility main menu with the arrow keys. You should see the following display. Highlighting a setting with a + or - will expand or collapse that entry. See details on how to change the order and specs of boot devices in the Item Specific Help window. All Boot BIOS settings are described in this section.

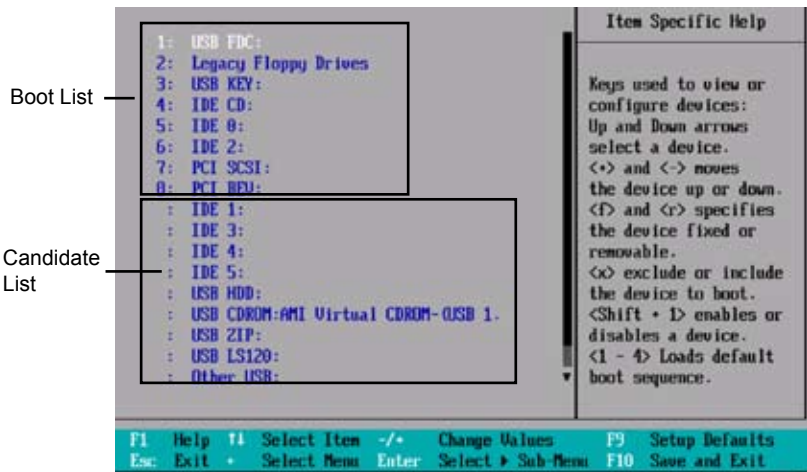
**Boot Priority Order/Excluded from Boot Order.**

Use the Up and Down Arrow Keys to select a device. Use <+> and <-> keys to move the device up or down. Use the <f> key or the <r> key to specify the devices. You can also use the keys indicated above to specify the priority of the boot order for a device or move a item from the category of "Excluded from Boot Order" to the category of "Boot Priority Order" and vice versa. Please refer to the window of "Item Specific Help" for details.

## 4-7 Exit

Choose Exit from the Phoenix BIOS Setup Utility main menu with the arrow keys. You should see the following display. All Exit BIOS settings are described in this section.

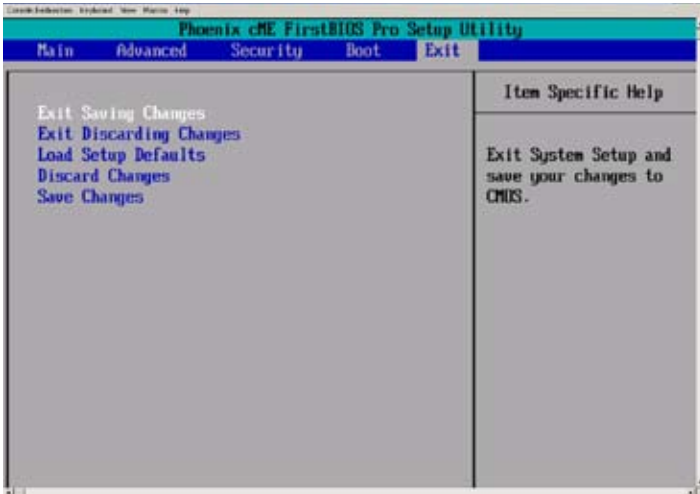

### Exit Saving Changes

Highlight this item and hit <Enter> to save any changes you've made and to exit the BIOS Setup utility.

### Exit Discarding Changes

Highlight this item and hit <Enter> to exit the BIOS Setup utility without saving any changes you may have made.

### Load Setup Defaults

Highlight this item and hit <Enter> to load the default settings for all items in the BIOS Setup. These are the safest settings to use.

### Discard Changes

Highlight this item and hit <Enter> to discard (cancel) any changes you've made. You will remain in the Setup utility.

### Save Changes

Highlight this item and hit <Enter> to save any changes you made. You will remain in the Setup utility.

# Appendix A

## BIOS POST Messages and LED Indicators

During the Power-On Self-Test (POST), the BIOS will check for problems. If a problem is found, the BIOS will activate an alarm, turn on LED indicators, or display a message.

### A-1 BIOS POST Beep Codes

Beeps	Error Messages
1 long beep-pause-1 long beep	Memory Module Errors
1 long beep + 2 short beeps	VGA Errors
1 long continuous beep (OH LED on)	System Overheat

### A-2 LE1: Standby PWR LED

LE1: 5V Standby PWR LED	Action
On Standby PWR On	Turn off the PWR supply before removing or installing components

### A-3 LE3/LE4 System Debug Indicators

State	LE3 Indicator		LE4 Indicator	
<b>PWR-ON to POST</b>	Green	On	Yellow	On
<b>ECC Memory Testing</b>	Green	Flash	Yellow	Flash
<b>PCI Bus Initializing</b>	Green	On	Yellow	Flash
<b>VGA Initializing</b>	Green	Flash	Yellow	On
<b>System Normal (After POST)</b>	Off	N/A	Off	N/A

### A-4 LED Locations

- A. LE1
- B. LE3
- C. LE4

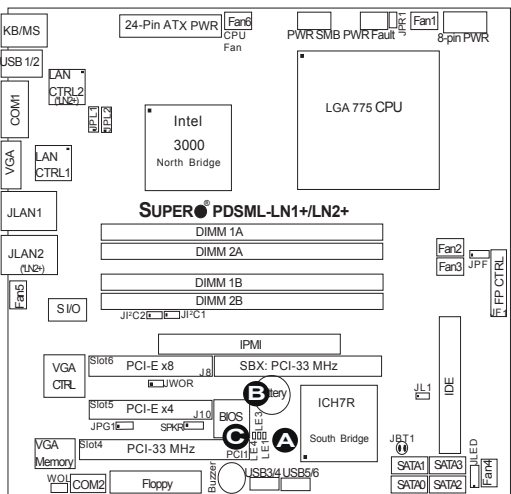

## **A-5 BIOS Messages**

### **Failure Fixed Disk**

Fixed disk is not working or not configured properly. Check to see if fixed disk is attached properly. Run Setup. Find out if the fixed-disk type is correctly identified.

### **Stuck key**

Stuck key on keyboard.

### **Keyboard error**

Keyboard not working.

### **Keyboard Controller Failed**

Keyboard controller failed test. May require replacing keyboard controller.

### **Keyboard locked - Unlock key switch**

Unlock the system to proceed.

### **Monitor type does not match CMOS - Run SETUP**

Monitor type not correctly identified in Setup

### **Shadow Ram Failed at offset: nnnn**

Shadow RAM failed at offset **nnnn** of the 64k block at which the error was detected.

### **System RAM Failed at offset: nnnn**

System RAM failed at offset **nnnn** of in the 64k block at which the error was detected.

### **Extended RAM Failed at offset: nnnn**

Extended memory not working or not configured properly at offset **nnnn**.

### **System battery is dead - Replace and run SETUP**

The CMOS clock battery indicator shows the battery is dead. Replace the battery and run Setup to reconfigure the system.

**System CMOS checksum bad - Default configuration used**

System CMOS has been corrupted or modified incorrectly, perhaps by an application program that changes data stored in CMOS. The BIOS installed Default Setup Values. If you do not want these values, enter Setup and enter your own values. If the error persists, check the system battery or contact your dealer.

**System timer error**

The timer test failed. Requires repair of system board.

**Real time clock error**

Real-Time Clock fails BIOS hardware test. May require board repair.

**Check date and time settings**

BIOS found date or time out of range and reset the Real-Time Clock. May require setting legal date (1991-2099).

**Previous boot incomplete - Default configuration used**

Previous POST did not complete successfully. POST loads default values and offers to run Setup. If the failure was caused by incorrect values and they are not corrected, the next boot will likely fail. On systems with control of **wait states**, improper Setup settings can also terminate POST and cause this error on the next boot. Run Setup and verify that the waitstate configuration is correct. This error is cleared the next time the system is booted.

**Memory Size found by POST differed from CMOS**

Memory size found by POST differed from CMOS.

**Diskette drive A error**

**Diskette drive B error**

Drive A: or B: is present but fails the BIOS POST diskette tests. Check to see that the drive is defined with the proper diskette type in Setup and that the diskette drive is attached correctly.

**Incorrect Drive A type - run SETUP**

Type of floppy drive A: not correctly identified in Setup.

**Incorrect Drive B type - run SETUP**

Type of floppy drive B: not correctly identified in Setup.

**System cache error - Cache disabled**

RAM cache failed and BIOS disabled the cache. On older boards, check the cache jumpers. You may have to replace the cache. See your dealer. A disabled cache slows system performance considerably.

**CPU ID:**

CPU socket number for Multi-Processor error.

**EISA CMOS not writeable**

ServerBIOS2 test error: Cannot write to EISA CMOS.

**DMA Test Failed**

ServerBIOS2 test error: Cannot write to extended **DMA** (Direct Memory Access) registers.

**Software NMI Failed**

ServerBIOS2 test error: Cannot generate software NMI (Non-Maskable Interrupt).

**Fail-Safe Timer NMI Failed**

ServerBIOS2 test error: Fail-Safe Timer takes too long.

**Device Address Conflict**

Address conflict for specified **device**.

**Allocation Error for: device**

Run ISA or EISA Configuration Utility to resolve resource conflict for the specified **device**.

**CD ROM Drive**

CD ROM Drive identified.

**Entering SETUP ...**

Starting Setup program

**Failing Bits: nnnn**

The hex number **nnnn** is a map of the bits at the RAM address which failed the memory test. Each 1 (one) in the map indicates a failed bit. See errors 230, 231, or 232 above for offset address of the failure in System, Extended, or Shadow memory.

**Fixed Disk n**

Fixed disk n (0-3) identified.

**Invalid System Configuration Data**

Problem with NVRAM (CMOS) data.

**I/O device IRQ conflict**

I/O device IRQ conflict error.

**PS/2 Mouse Boot Summary Screen:**

PS/2 Mouse installed.

**nnnn kB Extended RAM Passed**

Where nnnn is the amount of RAM in kilobytes successfully tested.

**nnnn Cache SRAM Passed**

Where nnnn is the amount of system cache in kilobytes successfully tested.

**nnnn kB Shadow RAM Passed**

Where nnnn is the amount of shadow RAM in kilobytes successfully tested.

**nnnn kB System RAM Passed**

Where nnnn is the amount of system RAM in kilobytes successfully tested.

**One or more I2O Block Storage Devices were excluded from the Setup Boot Menu**

There was not enough room in the IPL table to display all installed I2O block-storage devices.

**Operating system not found**

Operating system cannot be located on either drive A: or drive C:. Enter Setup and see if fixed disk and drive A: are properly identified.

**Parity Check 1 nnnn**

Parity error found in the system bus. BIOS attempts to locate the address and display it on the screen. If it cannot locate the address, it displays ????. Parity is a method for checking errors in binary data. A parity error indicates that some data has been corrupted.

**Parity Check 2 nnnn**

Parity error found in the I/O bus. BIOS attempts to locate the address and display it on the screen. If it cannot locate the address, it displays ?????.

**Press <F1> to resume, <F2> to Setup, <F3> for previous**

Displayed after any recoverable error message. Press <F1> to start the boot process or <F2> to enter Setup and change the settings. Press <F3> to display the previous screen (usually an initialization error of an **Option ROM**, i.e., an add-on card). Write down and follow the information shown on the screen.

**Press <F2> to enter Setup**

Optional message displayed during POST. Can be turned off in Setup.

**PS/2 Mouse:**

PS/2 mouse identified.

**Run the I2O Configuration Utility**

One or more unclaimed block storage devices have the Configuration Request bit set in the LCT. Run an I2O Configuration Utility (e.g. the SAC utility).

**System BIOS shadowed**

System BIOS copied to shadow RAM.

**UMB upper limit segment address: nnnn**

Displays the address *nnnn* of the upper limit of **Upper Memory Blocks**, indicating released segments of the BIOS which can be reclaimed by a virtual memory manager.

**Video BIOS shadowed**

Video BIOS successfully copied to shadow RAM.



## Appendix B

### BIOS POST Codes

This section lists the POST (Power On Self Test) codes for the Phoenix BIOS. POST codes are divided into two categories: recoverable and terminal.

#### Recoverable POST Errors

When a recoverable type of error occurs during POST, the BIOS will display an POST code that describes the problem. BIOS may also issue one of the following beep codes:

- 1 long and two short beeps - video configuration error
- 1 continuous long beep - overheat (Overheat LED will be on)
- 1 long beep and 1 short pause - memory not detected

#### Terminal POST Errors

If a terminal type of error occurs, BIOS will shut down the system. Before doing so, BIOS will write the error to port 80h, attempt to initialize video and write the error in the top left corner of the screen.

The following is a list of codes that may be written to port 80h.

POST Code	Description
02h	Verify Real Mode
03h	Disable Non-Maskable Interrupt (NMI)
04h	Get CPU type
06h	Initialize system hardware
07h	Disable shadow and execute code from the ROM.
08h	Initialize chipset with initial POST values
09h	Set IN POST flag
0Ah	Initialize CPU registers
0Bh	Enable CPU cache
0Ch	Initialize caches to initial POST values
0Eh	Initialize I/O component
0Fh	Initialize the local bus IDE
10h	Initialize Power Management
11h	Load alternate registers with initial POST values
12h	Restore CPU control word during warm boot
13h	Initialize PCI Bus Mastering devices
14h	Initialize keyboard controller
16h	1-2-2-3 BIOS ROM checksum
17h	Initialize cache before memory Auto size

<b>POST Code</b>	<b>Description</b>
18h	8254 timer initialization
1Ah	8237 DMA controller initialization
1Ch	Reset Programmable Interrupt Controller
20h	1-3-1-1 Test DRAM refresh
22h	1-3-1-3 Test 8742 Keyboard Controller
24h	Set ES segment register to 4 GB
28h	Auto size DRAM
29h	Initialize POST Memory Manager
2Ah	Clear 512 kB base RAM
2Ch	1-3-4-1 RAM failure on address line <b>xxxx*</b>
2Eh	1-3-4-3 RAM failure on data bits <b>xxxx*</b> of low byte of memory bus
2Fh	Enable cache before system BIOS shadow
32h	Test CPU bus-clock frequency
33h	Initialize Phoenix Dispatch Manager
36h	Warm start shut down
38h	Shadow system BIOS ROM
3Ah	Auto size cache
3Ch	Advanced configuration of chipset registers
3Dh	Load alternate registers with CMOS values
41h	Initialize extended memory for RomPilot
42h	Initialize interrupt vectors
45h	POST device initialization
46h	2-1-2-3 Check ROM copyright notice
47h	Initialize I20 support
48h	Check video configuration against CMOS
49h	Initialize PCI bus and devices
4Ah	Initialize all video adapters in system
4Bh	QuietBoot start (optional)
4Ch	Shadow video BIOS ROM
4Eh	Display BIOS copyright notice
4Fh	Initialize MultiBoot
50h	Display CPU type and speed
51h	Initialize EISA board
52h	Test keyboard
54h	Set key click if enabled
55h	Enable USB devices
58h	2-2-3-1 Test for unexpected interrupts
59h	Initialize POST display service
5Ah	Display prompt "Press F2 to enter SETUP"
5Bh	Disable CPU cache

---

<b>POST Code</b>	<b>Description</b>
5Ch	Test RAM between 512 and 640 kB
60h	Test extended memory
62h	Test extended memory address lines
64h	Jump to UserPatch1
66h	Configure advanced cache registers
67h	Initialize Multi Processor APIC
68h	Enable external and CPU caches
69h	Setup System Management Mode (SMM) area
6Ah	Display external L2 cache size
6Bh	Load custom defaults (optional)
6Ch	Display shadow-area message
6Eh	Display possible high address for UMB recovery
70h	Display error messages
72h	Check for configuration errors
76h	Check for keyboard errors
7Ch	Set up hardware interrupt vectors
7Dh	Initialize Intelligent System Monitoring
7Eh	Initialize coprocessor if present
80h	Disable onboard Super I/O ports and IRQs
81h	Late POST device initialization
82h	Detect and install external RS232 ports
83h	Configure non-MCD IDE controllers
84h	Detect and install external parallel ports
85h	Initialize PC-compatible PnP ISA devices
86h	Re-initialize onboard I/O ports.
87h	Configure Motherboard Configurable Devices (optional)
88h	Initialize BIOS Data Area
89h	Enable Non-Maskable Interrupts (NMIs)
8Ah	Initialize Extended BIOS Data Area
8Bh	Test and initialize PS/2 mouse
8Ch	Initialize floppy controller
8Fh	Determine number of ATA drives (optional)
90h	Initialize hard-disk controllers
91h	Initialize local-bus hard-disk controllers
92h	Jump to UserPatch2
93h	Build MPTABLE for multi-processor boards
95h	Install CD ROM for boot
96h	Clear huge ES segment register
97h	Fix up Multi Processor table
98h	1-2 Search for option ROMs. One long, two short beeps on checksum failure

---

<b>POST Code</b>	<b>Description</b>
99h	Check for SMART Drive (optional)
9Ah	Shadow option ROMs
9Ch	Set up Power Management
9Dh	Initialize security engine (optional)
9Eh	Enable hardware interrupts
9Fh	Determine number of ATA and SCSI drives
A0h	Set time of day
A2h	Check key lock
A4h	Initialize typematic rate
A8h	Erase F2 prompt
AAh	Scan for F2 key stroke
ACh	Enter SETUP
A Eh	Clear Boot flag
B0h	Check for errors
B1h	Inform RomPilot about the end of POST.
B2h	POST done - prepare to boot operating system
B4h	1 One short beep before boot
B5h	Terminate QuietBoot (optional)
B6h	Check password (optional)
B7h	Initialize ACPI BIOS
B9h	Prepare Boot
BAh	Initialize SMBIOS
BBh	Initialize PnP Option ROMs
BCh	Clear parity checkers
BDh	Display MultiBoot menu
BEh	Clear screen (optional)
BFh	Check virus and backup reminders
C0h	Try to boot with INT 19
C1h	Initialize POST Error Manager (PEM)
C2h	Initialize error logging
C3h	Initialize error display function
C4h	Initialize system error handler
C5h	PnPnd dual CMOS (optional)
C6h	Initialize note dock (optional)
C7h	Initialize note dock late
C8h	Force check (optional)
C9h	Extended checksum (optional)
CAh	Redirect Int 15h to enable remote keyboard
CBh	Redirect Int 13h to Memory Technologies Devices such as ROM, RAM, PCMCIA, and serial disk
CCh	Redirect Int 10h to enable remote serial video

<b>POST Code</b>	<b>Description</b>
CDh	Re-map I/O and memory for PCMCIA
CEh	Initialize digitizer and display message
D2h	Unknown interrupt

**The following are for boot block in Flash ROM**

<b>POST Code</b>	<b>Description</b>
E0h	Initialize the chipset
E1h	Initialize the bridge
E2h	Initialize the CPU
E3h	Initialize system timer
E4h	Initialize system I/O
E5h	Check force recovery boot
E6h	Checksum BIOS ROM
E7h	Go to BIOS
E8h	Set Huge Segment
E9h	Initialize Multi Processor
EAh	Initialize OEM special code
EBh	Initialize PIC and DMA
ECh	Initialize Memory type
EDh	Initialize Memory size
EEh	Shadow Boot Block
EFh	System memory test
F0h	Initialize interrupt vectors
F1h	Initialize Run Time Clock
F2h	Initialize video
F3h	Initialize System Management Manager
F4h	Output one beep
F5h	Clear Huge Segment
F6h	Boot to Mini DOS
F7h	Boot to Full DOS

\* If the BIOS detects errors on 2C, 2E, or 30 (base 512K RAM error), it displays an additional word-bitmap (**xxxx**) indicating the address line or bits that have failed. For example, "2C 0002" means address line 1 (bit one set) has failed. "2E 1020" means data bits 12 and 5 (bits 12 and 5 set) have failed in the lower 16 bits. The BIOS also sends the bitmap to the port-80 LED display. It first displays the checkpoint code, followed by a delay, the high-order byte, another delay, and then the loworder byte of the error. It repeats this sequence continuously.

## **Notes**

## Appendix C

# Software Installation

After all the hardware has been installed, you must first configure Intel's ICH7R SATA RAID\* before you install the Windows Operating System and other software drivers.

### **Important Notes to the User:**

Note 1: If you do not wish to configure onboard SATA RAID functions, please go directly to Section C-3 for Operating System & Other Software Installation.

Note 2: This chapter describes RAID Configuration Instructions for the Intel ICH RAID Controller designed for the Windows OS.

Note 3: GLAN2 is available on the PDSML-LN2+/PDSML-E+ only.

## **C-1 Introduction to Serial ATA and Parallel ATA**

To configure the SATA RAID functions, you must first use the Intel ICH7R SATA RAID Utility program to configure the RAID Level that you desire before installing the Windows XP/2000/2003 operating system and other software drivers. (The necessary drivers are all included on the Supermicro CD that came packaged with your motherboard.) Note that the current version of the ICH7R SATA RAID Utility can only support Windows XP/2000/2003 Operating Systems.

### **Serial ATA (SATA)**

Serial ATA (SATA) is a physical storage interface that uses a single cable with a minimum of four wires to create a point-to-point connection between devices. It is a serial link, which supports transfer rates up to 3Gbps. Because the serial cables used in SATA are thinner than the traditional cables used in Parallel ATA (PATA), SATA systems have better airflow and can be installed in smaller chassis than Parallel ATA. In addition, the cables used in PATA are limited to a length of 40cm, while Serial ATA cables can be up to one meter in length. Overall, SATA provides better functionality than PATA.

### **Introduction to Intel ICH7R Serial RAID**

Located in the South Bridge of the 3000 chipset, the I/O Controller Hub (ICH7R) provides the I/O subsystem with access to the rest of the system. It supports a 2-channel UltraATA/100 Bus Master IDE controller (PATA) and four Serial ATA (SATA) ports. The ICH7R supports the following PATA and SATA device configurations: Legacy mode and Native mode.

## RAID Configurations

The following types of RAID configurations are supported:

RAID 0 (Data Striping): this writes data in parallel, interleaved ("striped") sections of two hard drives. Data transfer rate is doubled over using a single disk.

RAID1 (Data Mirroring): an identical data image from one drive is copied to another drive. The second drive must be the same size or larger than the first drive.

RAID 10 (Striping & Mirroring): RAID 0 and 1 schemes are combined (without parity information) to get the benefits of both.

RAID 5: both data and parity information are striped and mirrored across three or more hard drives.

## Intel Matrix Storage Technology

The Intel Matrix Storage Technology, supported by the ICH7R, allows the user to create RAID 0 and RAID1 set by using only two identical hard disk drives. The Intel Matrix Storage Technology creates two partitions on each hard disk drive and generate a virtual RAID0 and RAID1 sets. It also allows you the change the HDD partition size without any data.

### Configuring BIOS settings for SATA RAID Functions (Native Mode)

1. Press the <Del> key during system bootup to enter the BIOS Setup Utility.

Note: If it is the first time powering on the system, we recommend you load the Optimized Default Settings. If you have already done so, please skip to Step 3.

2. Use the arrow keys to select the "Exit" Settings. Once in the "Exit" settings, Scroll down to select "Load Optimized Default Settings" and press the <Enter> key. Select "OK" to confirm the selection. Press the <Enter> key to load the default settings for the BIOS.

3. Use the arrow keys to select the "Main" section in BIOS.

4. Scroll down to "SATA Control Mode" and press the <Enter> key to select "Enhanced"

5. Scroll down to "SATA RAID Enabled" and press <Enter>. Then, select "Enabled."

6. Scroll down to "Exit". Select "Save and Exit" from the "Exit" menu. Press the <Enter> key to save the changes and exit the BIOS.

7. Once you've exited the BIOS Utility, the system will re-boot.

8. During the system boot-up, press the <Ctrl> and <I> keys simultaneously to run the Intel RAID Configuration Utility when prompted by the following message: *Press <Ctrl> <I> for Intel RAID Configuration Utility.*



## Using the Intel ICH7R SATA RAID Utility Program

### 1. Creating, Deleting and Resetting RAID Volumes:

a. After the system exits from the BIOS Setup Utility, the system will automatically reboot. The following screen appears after Power-On Self Test.

```

RAID Volumes:
None defined.

Physical Disks:
Port Drive Model      Serial #              Size   Type/Status(Vol ID)
0    WDC WD2500SD-01K  WD-WMAAL72834971     232.9GB Non-RAID Disk
1    WDC WD2500SD-01K  WD-WMAAL72834599     232.9GB Non-RAID Disk
2    WDC WD2500JD-00F  WD-WMAEH1376109     232.9GB Non-RAID Disk
3    WDC WD2500JD-00F  WD-WMAEH1449527     232.9GB Non-RAID Disk

Press <CTRL-I> to enter Configuration Utility...

Adaptec SCSI BIOS v4.30.0
Copyright 2003 Adaptec, Inc. All Rights Reserved.

<<< Press <Ctrl><A> for SCSISelect(TM) Utility! >>>

Slot Ch ID LUN Vendor      Product              Size Bus Status
-----
04  A  10  0

```

b. When you see the above screen, press the <Ctrl> and the <I> keys simultaneously to have the main menu of the SATA RAID Utility appear:

**Note:** All graphics and screen shots shown in the manual are for reference only. The screen shots shown in the manual do not imply Supernico's endorsement or non-endorsement on any 3rd party's product. Your screens may or many not look exactly the same as the graphics shown in this manual.

**Creating a RAID 0 Volume:**

a. Select "Create RAID Volume" from the main menu and press the <Enter> key. The following screen will appear:

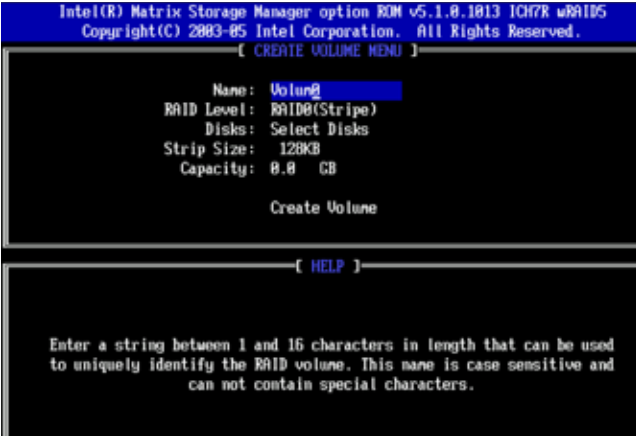

- b. Specify a name for the **RAID 0** set and press the <Tab> key or the <Enter> key to go to the next field. (You can use the <Esc> key to select the previous menu.)
- c. When RAID Level item is highlighted, press the <Up Arrow>, <Down Arrow> keys to select **RAID 0 (Stripe)** and hit <Enter>.
- d. When the Disks item is highlighted, press <Enter> to select the HDD to configure as RAID. The following pop-up screen (\*See the note on Page C-3) displays:

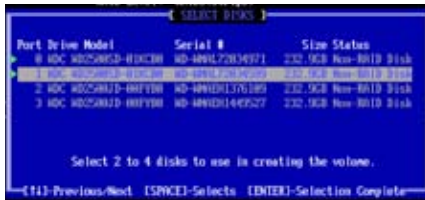

- e. Use the <Up Arrow>, <Down Arrow> keys to highlight a drive and press <Space> to select it. A triangle appears to confirm the selection of the drive.
- f. Use the <Up Arrow>, <Down Arrow> keys to select the stripe size, ranging from 4 KB to 128 KB for the RAID 0 array, and hit <Enter>. Note: For a server, please use a lower stripe size, and for a multimedia system, use a higher stripe size. The default stripe size is 128 KB.
- g. Press <Enter> when the Create Volume item is highlighted. A warning message displays.
- h. When asked "Are you sure you want to create this volume (Y/N), press "Y" to create the RAID volume, or type "N" to go back to the Create Volume menu.

## Creating a RAID 1 Volume:

a. Select "Create RAID Volume" from the main menu and press the <Enter> key. The following screen will appear:

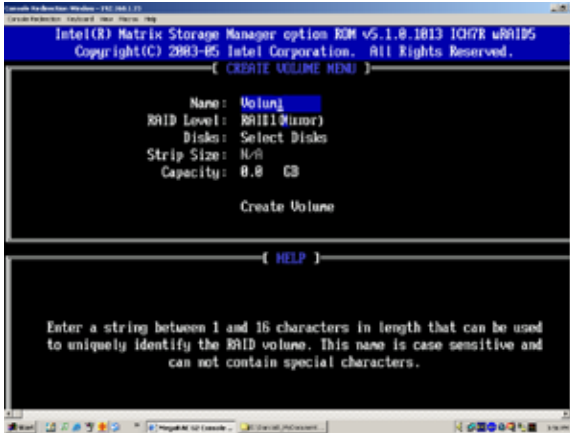

- b. Specify a name for the **RAID 1** set and press the <Tab> key or the <Enter> key to go to the next field. (You can use the <Esc> key to select the previous menu.)
- c. When RAID Level item is highlighted, press the <Up Arrow>, <Down Arrow> keys to select **RAID 1 (Mirror)** and hit <Enter>.
- d. When the Capacity item is highlighted, enter your RAID volume capacity and hit <Enter>. The default setting is the maximum capacity allowed.
- e. Press <Enter> when the Create Volume item is highlighted. A warning message displays.
- f. When asked "Are you sure you want to create this volume (Y/N), press "Y" to create the RAID volume, or type "N" to go back to the Create Volume menu.

**Creating a RAID 10 (RAID 1+ RAID 0):**

a. Select "Create RAID Volume" from the main menu and press the <Enter> key. The following screen will appear:



- b. Specify a name for the **RAID 10** set and press <Enter>.
- c. When RAID Level item is highlighted, use the <Up Arrow>, <Down Arrow> keys to select **RAID 10 (RAID1 + RAID0)** and hit <Enter>.
- d. When the Stripe Size is highlighted, use the <Up Arrow>, <Down Arrow> keys to select the stripe size from 4 KB to 128 KB for your RAID 10 and hit <Enter>. The default setting is 6 KB. Note: For a server, please use a lower stripe size, and for a multimedia system, use a higher stripe size.)
- e. When the RAID Volume Capacity item is highlighted, enter your RAID volume capacity and hit <Enter>. The default setting is the maximum capacity allowed.
- f. Press <Enter> when the Create Volume item is highlighted. A warning message displays.
- g. When asked "Are you sure you want to create this volume (Y/N), press "Y" to create the RAID volume, or type "N" to go back to the Create Volume menu.

## Creating a RAID 5 Set (Parity):

- a. Select "Create RAID Volume" from the main menu and press the <Enter> key. The following screen will appear:

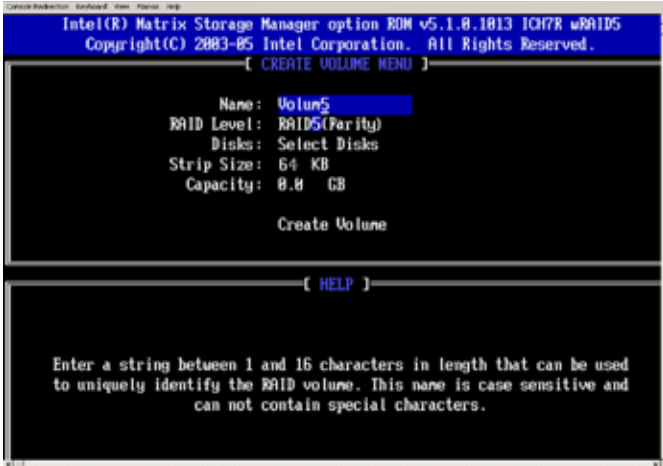

- b. Specify a name for the **RAID 5** set and press <Enter>.
- c. When the Raid Level is highlighted, use the <Up Arrow>, <Down Arrow> keys to select **RAID 5 (Parity)** and hit <Enter>.
- d. When the Disk item is highlighted, press <Enter> to select the HDD to configure as RAID. The following pop-up screen (\*See the note on Page C-3) displays:

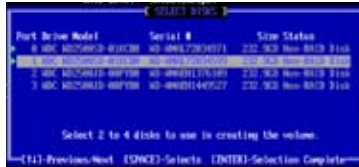

- e. Use the <Up Arrow>, <Down Arrow> keys to highlight a drive and press <Space> to select it. A triangle appears to confirm the selection of the drive.
- f. Use the <Up Arrow>, <Down Arrow> keys to select the stripe size, ranging from 4 KB to 128 KB for the RAID 5 array, and hit <Enter>. Note: For a server, please use a lower stripe size, and for a multimedia system, use a higher stripe size. The default stripe size is 128 KB.)
- g. Enter your desired RAID volume capacity and press <Enter> when the capacity item is highlighted. The default setting is the maximum capacity allowed.
- h. Press Enter when the Create Volume item is highlighted. A warning message displays.
- i. When asked "Are you sure you want to create this volume (Y/N), press "Y" to create the RAID volume, or type "N" to go back to the Create Volume menu.

### **Deleting RAID Volume:**



**(Warning:** Be sure to back up your data before deleting a RAID set. You will lose all data on the disk drives when deleting a RAID set.)

- a. From the main menu, select item2-Delete RAID Volume, and press <Enter>.
- b. Use the <Up Arrow>, <Down Arrow> keys to select the RAID set you want to delete and press <Del>. A Warning message displays.
- c. When asked "Are you sure you want to delete this volume (Y/N), press "Y" to delete the RAID volume, or type "N" to go back to the Delete Volume menu.

## Resetting to Non-RAID and Resetting a RAID HDD



**(Warning:** Be cautious when you reset a RAID volume HDD to non-RAID or Resetting a RAID HDD. Resetting a RAID volume HDD or Resetting a RAID HDD will reformat the HDD and delete the internal RAID structure on the drive.)

- a. From the main menu, select item3-Reset Disks to Non- RAID, and press <Enter>. The following screen will appear:



- b. Use the <Up Arrow>, <Down Arrow> keys to highlight the RAID set drive to reset and press <Space> to select.
- c. Press <Enter> to reset the RAID set drive. A Warning message displays.
- d. Press "Y" to reset the drive, or type "N" to go back to the main menu.

### Exiting the Intel Matrix Storage Manager Utility:

- a. From the main menu, select item4-Exit, and press <Enter>. A warning message will appear.
- b. Press "Y" to reset the drive, or type "N" to go back to the main menu.

## C-2 Installing the Windows XP/2000/2003 for systems with RAID Functions

### Installing a New Operating System-Windows XP/2000/2003 OS

- a. Insert the Microsoft Windows XP/2000/2003 Setup CD in the CD Drive, and the system will start booting up from CD.
- b. Press the <F6> key when the message-" Press F6 if you need to install a third party SCSI or RAID driver" displays.
- c. When the Windows XP/2000/2003 Setup screen appears, press "S" to specify additional device(s).
- d. Insert the driver diskette-"Intel AA RAID XP/2000/2003 Driver for ICH7R into Drive A: and press the <Enter> key.
- e. Choose the Intel(R)82801GR/GH *SATA RAID Controller* from the list indicated in the XP/2000/2003 Setup Screen, and press the <Enter> key.
- f. Press the <Enter> key to continue the installation process. (If you need to specify any additional devices to be installed, do it at this time.) Once all devices are specified, press the <Enter> key to continue with the installation.
- g. From the Windows XP/2000/2003 Setup screen, press the <Enter> key. The XP/2000/2003 Setup will automatically load all device files and then, continue the Windows XP/2000/2003 installation.
- h. After the Windows XP/2000/2003 Installation is completed, the system will automatically reboot.
- i. Insert Supermicro CD that came with the package into the CD Drive during system reboot, and the following screen will appear:

Note: the current version of the ICH7R SATA RAID Utility can only support the Windows XP/2000/2003 Operating System.



## C-3 Installing the Operating System and other Software Programs

After all the hardware has been installed, you must first install the operating system, and then, other software drivers. The necessary drivers are all included on the Supermicro CDs that came packaged with your motherboard. Note: for the Windows 2003 OS, please refer to Page C-10.

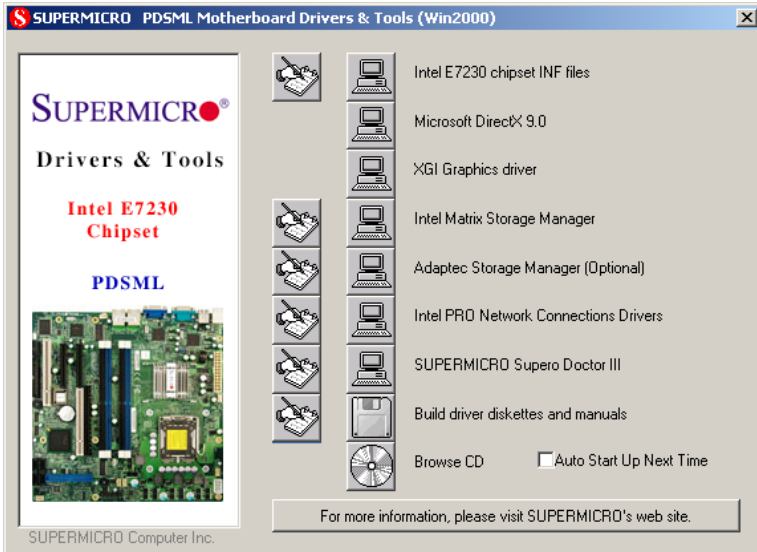

**Driver/Tool Installation Display Screen**

**Note:** Click the icons showing a hand writing on the paper to view the readme files for each item. Click the computer icons to the right of these items to install each item (from top to the bottom) one at a time. **After installing each item, you must re-boot the system before moving on to the next item on the list.** The bottom icon with a CD on it allows you to view the entire contents of the CD.

## Supero Doctor III

The Supero Doctor III program is a Web-base management tool that supports remote management capability. It includes Remote and Local Management tools. The local management is called the SD III Client. The Supero Doctor III program included on the CDROM that came with your motherboard allows you to monitor the environment and operations of your system. Supero Doctor III displays crucial system information such as CPU temperature, system voltages and fan status. See the Figure below for a display of the Supero Doctor III interface.

**Note 1:** The default user name and password are ADMIN.

**Note 2:** In the Windows OS environment, the Supero Doctor III settings take precedence over the BIOS settings. When first installed, Supero Doctor III adopts the temperature threshold settings previously set in the BIOS. Any subsequent changes to these thresholds must be made within Supero Doctor, since the SD III settings override the BIOS settings. For the Windows OS to adopt the BIOS temperature threshold settings, please change the SDIII settings to be the same as those set in the BIOS.

### Supero Doctor III Interface Display Screen-I (Health Information)

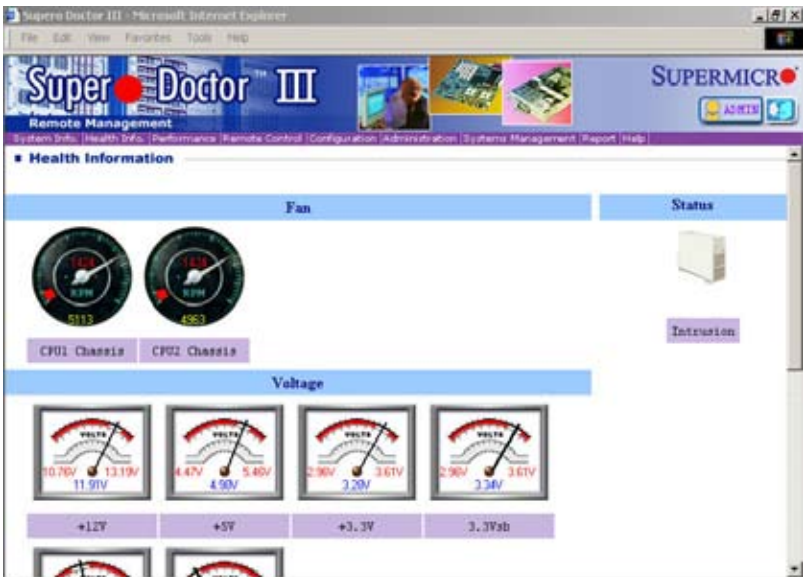

## Supero Doctor III Interface Display Screen-II (Remote Control)



**Note:** SD III Software Revision 1.0 can be downloaded from our Web Site at: [ftp://ftp.supermicro.com/utility/Supero\\_Doctor\\_III/](ftp://ftp.supermicro.com/utility/Supero_Doctor_III/). You can also download SDIII User's Guide at: <http://www.supermicro.com/PRODUCT/Manuals/SDIII/UserGuide.pdf>. For Linux, we will still recommend Supero Doctor II.

## **Notes**

(Disclaimer)

The products sold by Supermicro are not intended for and will not be used in life support systems, medical equipment, nuclear facilities or systems, aircraft, aircraft devices, aircraft/emergency communication devices or other critical systems whose failure to perform be reasonably expected to result in significant injury or loss of life or catastrophic property damage. Accordingly, Supermicro disclaims any and all liability, and should buyer use or sell such products for use in such ultra-hazardous applications, it does so entirely at its own risk. Furthermore, buyer agrees to fully indemnify, defend and hold Supermicro harmless for and against any and all claims, demands, actions, litigation, and proceedings of any kind arising out of or related to such ultra-hazardous use or sale.