

SUPER[®]

SUPER[®]PDSBA-Q+

SUPER[®]PDSBA+

SUPER[®]PDSBA

SUPER[®]PDSBE

USER'S MANUAL

Revision 1.1c

The information in this User's Manual has been carefully reviewed and is believed to be accurate. The vendor assumes no responsibility for any inaccuracies that may be contained in this document, makes no commitment to update or to keep current the information in this manual, or to notify any person or organization of the updates. **Please Note: For the most up-to-date version of this manual, please see our website at www.supermicro.com.**

Super Micro Computer, Inc. ("Supermicro") reserves the right to make changes to the product described in this manual at any time and without notice. This product, including software, if any, and documentation may not, in whole or in part, be copied, photocopied, reproduced, translated or reduced to any medium or machine without prior written consent.

IN NO EVENT WILL SUPER MICRO COMPUTER, INC. BE LIABLE FOR DIRECT, INDIRECT, SPECIAL, INCIDENTAL, SPECULATIVE OR CONSEQUENTIAL DAMAGES ARISING FROM THE USE OR INABILITY TO USE THIS PRODUCT OR DOCUMENTATION, EVEN IF ADVISED OF THE POSSIBILITY OF SUCH DAMAGES. IN PARTICULAR, SUPER MICRO COMPUTER, INC. SHALL NOT HAVE LIABILITY FOR ANY HARDWARE, SOFTWARE, OR DATA STORED OR USED WITH THE PRODUCT, INCLUDING THE COSTS OF REPAIRING, REPLACING, INTEGRATING, INSTALLING OR RECOVERING SUCH HARDWARE, SOFTWARE, OR DATA.

Any disputes arising between manufacturer and customer shall be governed by the laws of Santa Clara County in the State of California, USA. The State of California, County of Santa Clara shall be the exclusive venue for the resolution of any such disputes. Super Micro's total liability for all claims will not exceed the price paid for the hardware product.

FCC Statement: This equipment has been tested and found to comply with the limits for a Class B digital device pursuant to Part 15 of the FCC Rules. These limits are designed to provide reasonable protection against harmful interference in a residential installation. This equipment generates, uses, and can radiate radio frequency energy and, if not installed and used in accordance with the manufacturer's instruction manual, may cause interference with radio communications. However, there is no guarantee that interference will not occur in a particular installation. If this equipment does cause harmful interference to radio or television reception, which can be determined by turning the equipment off and on, you are encouraged to try to correct the interference by one or more of the following measures:

Reorient or relocate the receiving antenna.

Increase the separation between the equipment and the receiver.

Connect the equipment into an outlet on a circuit different from that to which the receiver is connected.

Consult the dealer or an experienced radio/television technician for help.

California Best Management Practices Regulations for Perchlorate Materials: This Perchlorate warning applies only to products containing CR (Manganese Dioxide) Lithium coin cells. "Perchlorate Material-special handling may apply. See www.dtsc.ca.gov/hazardouswaste/perchlorate".

WARNING: Handling of lead solder materials used in this product may expose you to lead, a chemical known to the State of California to cause birth defects and other reproductive harm.

Manual Revision: Rev. 1.1c

Release Date: August 13, 2009

Unless you request and receive written permission from Super Micro Computer, Inc., you may not copy any part of this document.

Information in this document is subject to change without notice. Other products and companies referred to herein are trademarks or registered trademarks of their respective companies or mark holders.

Copyright © 2009 by Super Micro Computer, Inc.

All rights reserved.

Printed in the United States of America

Preface

About This Manual

This manual is written for system integrators, PC technicians and knowledgeable PC users. It provides information for the installation and use of the **SUPER**® motherboard. The PDSBA-Q+/PDSBA+/PDSBA/PDSBE supports a single Intel Quad-core/Dual-core Core2 Duo/E6000/E4000/Xeon 3000/Pentium® D/Pentium® 4/Celeron Processor with a system bus speed of 1066/800/533 MHz. The Intel Core2 Duo, Xeon, Pentium® D, Pentium® 4 and Celeron Processors, housed in a Flip-Chip Land Grid Array, support the 775-Land Grid Array Package that interfaces with the motherboard via an LGA775 socket. The PDSBA-Q+/PDSBA+/PDSBA/PDSBE supports up to 4MB of L2 Cache, Intel Trusted Platform Module (TPM) (Note), EM64T, Enhanced Intel SpeedStep (EIST), Intel Virtualization Technology (VT), Streaming SIMD Extensions 2 (SSE2), Streaming SIMD Extensions 3 (SSE3), and Execute Disable (XD) Bit. Please refer to the motherboard specifications pages on our website (<http://www.supermicro.com/Product/motherboard>) for updates on processor support. This product is intended to be professionally installed by a technician.

Manual Organization

Chapter 1 describes the features, specifications and performance of the mainboard and provides detailed information about the chipset.

Chapter 2 provides hardware installation instructions. Read this chapter when installing the processor, memory modules and other hardware components into the system. If you encounter any problems, see **Chapter 3**, which describes troubleshooting procedures for the video, the memory and the system setup stored in CMOS.

Chapter 4 includes an introduction to BIOS and provides detailed information on running the CMOS Setup utility.

Appendix A lists BIOS POST Error Codes.

Appendix B and Appendix C list Windows OS and Software Installation Instructions.



Note: TPM support is available for the PDSBA-Q+/PDSBA+/PDSBA only.

Conventions Used in the Manual:

Special attention should be given to the following symbols for proper installation and to prevent damage done to the components or injury to yourself:



Danger/Caution: Instructions to be strictly followed to prevent catastrophic system failure or to avoid bodily injury.



Warning: Important information given to ensure proper system installation or to prevent damage to the components.



Note: Additional Information given to differentiate various models or to ensure correct system setup.

Notes

Table of Contents

Preface

About This Manual	iii
Manual Organization	iii
Conventions Used in the Manual.....	iii

Chapter 1: Introduction

1-1 Overview	1-1
Checklist.....	1-1
Contacting Supermicro.....	1-2
SUPER PDSBA-Q+/PDSBA+/PDSBA/PDSBE Image	1-3
SUPER PDSBA-Q+/PDSBA+/PDSBA/PDSBE Layout.....	1-4
SUPER PDSBA-Q+/PDSBA+/PDSBA/PDSBE Quick Reference.....	1-5
Motherboard Features	1-6
Intel Q965/G965/P965 Chipsets: System Block Diagram	1-8
1-2 Chipset Overview	1-9
1-3 PC Health Monitoring	1-10
1-4 Power Configuration Settings	1-10
1-5 Power Supply.....	1-11
1-6 Super I/O	1-12

Chapter 2: Installation

2-1 Static-Sensitive Devices	2-1
2-2 Motherboard Installation	2-1
2-3 Processor and Heatsink Installation	2-2
2-4 Installing DDR2 Memory	2-4
2-5 Control Panel Connectors/IO Ports	2-6
Back Panel Connectors/IO Ports	2-6
Front Control Panel.....	2-7
Front Control Panel Pin Definitions.....	2-8
PWR LED	2-8
HDD LED.....	2-8
NIC1 LED Indicators	2-9
OH/Fan Fail LED	2-9
Reset Button.....	2-10
PWR Button.....	2-10
2-6 Connecting Cables	2-11
ATX/Auxiliary Power Connectors	2-11
Universal Serial Bus (USB).....	2-12

Chassis Intrusion	2-12
Fan Headers.....	2-13
ATX PS/2 Keyboard and PS/2 Mouse Ports.....	2-14
Serial Ports.....	2-14
Wake-On-Ring	2-15
Wake-On-LAN	2-15
GLAN1 Port.....	2-16
Speaker Connector	2-16
High Definition Audio (HDA).....	2-17
CD Header/Auxiliary Audio Header.....	2-17
2-7 Jumper Settings	2-18
Explanation of Jumpers	2-18
GLAN Enable/Disable	2-18
CMOS Clear	2-19
Watch Dog Enable	2-19
CPU Front Side Speed	2-20
PCI/PCI-Exp. Slots to SMB Speeds.....	2-20
USB Wake-Up	2-21
IDE Enable/Disable	2-22
TPM Enable.....	2-22
Keyboard Wake-Up	2-23
2-8 Onboard Indicators	2-24
GLAN LED Indicators.....	2-24
Power LED	2-25
External RAID LED	2-25
2-9 Parallel Port and Floppy Drive Connections	2-26
Parallel Port Connector.....	2-26
Floppy Connector.....	2-27
IDE Connectors	2-28

Chapter 3: Troubleshooting

3-1 Troubleshooting Procedures	3-1
Before Power On.....	3-1
No Power.....	3-1
No Video	3-2
Memory Errors.....	3-2
Losing the System's Setup Configuration	3-2
3-2 Technical Support Procedures	3-2
3-3 Frequently Asked Questions	3-3
3-4 Returning Merchandise for Service	3-4

Chapter 4: BIOS

4-1	Introduction	4-1
4-2	Running Setup	4-2
4-3	Main BIOS Setup	4-2
4-4	Advanced Setup	4-6
4-5	Security Setup	4-19
4-6	TPM State.....	4-21
4-7	Physical Presence Operations.....	4-22
4-8	Boot Settings	4-23
4-9	Exit.....	4-24

Appendices:

Appendix A: BIOS POST Error Codes	A-1
Appendix B: Installing the Windows OS	B-1
Appendix C: Software Installation Instructions.....	C-1

Chapter 1

Introduction

1-1 Overview

Checklist

Congratulations on purchasing your computer motherboard from an acknowledged leader in the industry. Supermicro boards are designed with the utmost attention to detail to provide you with the highest standards in quality and performance.

Please check that the following items have all been included with your motherboard. If anything listed here is damaged or missing, contact your retailer.

All items are included in the Retail Box Only.

One (1) Supermicro Mainboard

Four (4) SATA cables (CBL-0044L)

Two (2) IDE hard drive cables (CBL-0036L-2) (PDSBA-Q+/PDSBA+ only)

One (1) USB cable (CBL-041)

One (1) floppy drive ribbon cable (CBL-022L)

One (1) I/O shield (MCP-260-0001-00)

One (1) Supermicro CD containing drivers and utilities

One (1) User's/BIOS Manual

1-2 Contacting Supermicro

Headquarters

Address: Super Micro Computer, Inc.
980 Rock Ave.
San Jose, CA 95131 U.S.A.

Tel: +1 (408) 503-8000

Fax: +1 (408) 503-8008

Email: marketing@supermicro.com (General Information)
support@supermicro.com (Technical Support)

Website: www.supermicro.com

Europe

Address: Super Micro Computer, B.V.
Het Sterrenbeeld 28, 5215 ML
's-Hertogenbosch, The Netherlands

Tel: +31 (0) 73-6400390

Fax: +31 (0) 73-6416525

Email: sales@supermicro.nl (General Information)
support@supermicro.nl (Technical Support)
rma@supermicro.nl (Customer Support)

Asia-Pacific

Address: Super Micro Computer, Inc.
4F, No. 232-1, Liancheng Rd.
Chung-Ho 235, Taipei County
Taiwan, R.O.C.

Tel: +886-(2) 8226-3990

Fax: +886-(2) 8226-3991

Website: www.supermicro.com.tw

Technical Support:

Email: support@supermicro.com.tw

Tel: 886-2-8228-1366, ext.132 or 139

SUPER PDSBA-Q+/PDSBA+ Image



SUPER PDSBA/PDSBE Image



Note: All pictures and drawings shown in this manual were based upon the latest PCB Revision available at the time of publishing of the manual. The motherboard you've received may or may not look exactly the same as the ones shown in this manual.

Motherboard Layout
(not drawn to scale)

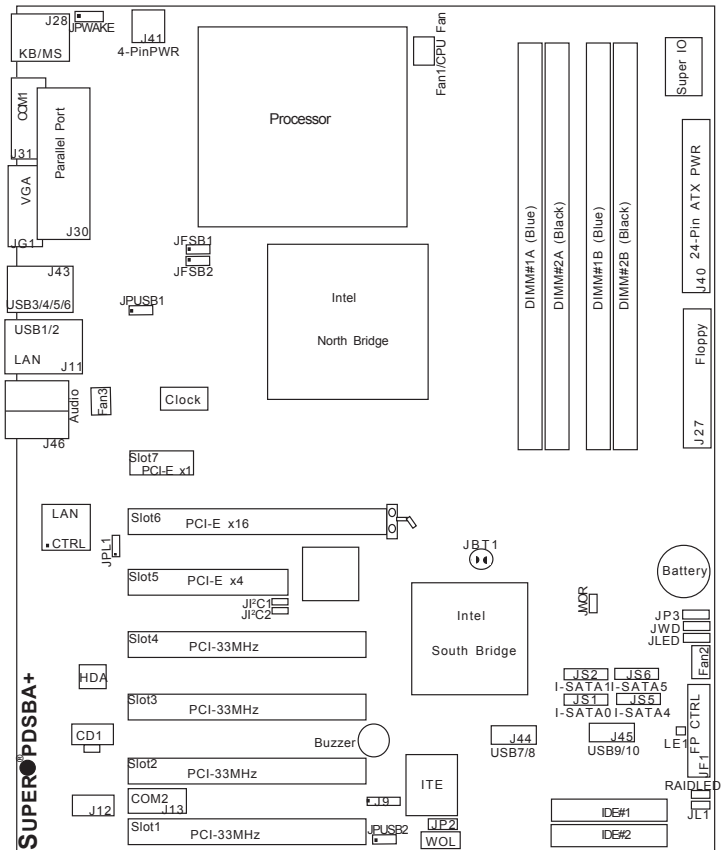

- See Chapter 2 for detailed information on jumpers, I/O ports and JF1 front panel connections.
- "■" indicates the location of "Pin 1".
- The ITE Controller, IDE#1 and IDE#2 are available on the PDSBA-Q+/PDSBA+ only.
- Trusted Platform Module support and VGA are available on the PDSBA-Q+/PDSBA+/PDSBA only.
- A special Consideration on Overclocking: Setting a high CPU FSB Speed, using a high DRAM Frequency, or selecting a high CPU V-Core voltage, memory voltage, chipset voltage, ICH chipset voltage, or FSB termination voltage may cause the system to become unstable. If this occurs, reset the setting to the default setting. Extra fans may be needed for proper system cooling.

Quick Reference

Jumpers	Description	Default Setting
JBT1	CMOS Clear	(See Chapter 2)
JFSB1/JFSB2	CPU Frequency	Pins 1-2/Pins 1-2(Auto)
J1 ² C1/J1 ² C2	SMB to PCI Slots	Open/Open (Disabled)
JP2 (PDSBA-Q+/PDSBA+)	ITE IDE Enabled	Pins 1-2 (Enabled)
JP3 (PDSBA-Q+/PDSBA+/PDSBA)	TPM Enable	Pins 1-2 (Enabled)
JPL1	Giga-bit LAN Enable	Pins 1-2 (Enabled)
JPUSB1	B/P USB Wake Up	Pins 2-3 (Disabled)
JPUSB2	F/P USB Wake Up	Pins 2-3 (Disabled)
JPWAKE1	Keyboard/Mouse Wake-Up	Pins 1-2 (Enabled)
JWD	Watch Dog Timer Out Option	Pins 1-2 (Reset)

Connectors	Description
Audio	Audio Port
CD-In (CD1)	Audio CD Input Header
Chassis Intrusion	Chassis Intrusion Header
COM1, COM2	COM Port/Serial Port 1 & Port 2 Connectors
DIMM#1A,#2A,#1B,#2B	Memory (DIMM) Slots (1 through 4)
Fans 1-3	Fan1: CPU Fan, Fan2/3: Chassis Fan Headers
Floppy	Floppy Disk Connector
FP Audio	Front Panel Audio Connector (See Chapter 2)
LAN Port	Ethernet RJ45 (Gigabit LAN) Connector
IDE#1/IDE#2	IDE Hard Drive #1 & Hard Drive #2 (See Page 1-4)
J40	ATX 24-Pin Power Connector
J41	12V 4-pin Power Connector (required)
JF1	Front Control Panel Header
SATA #0/1/4/5	SATA (#0/1/4/5) Headers
KB/Mouse	PS/2 Keyboard/Mouse
LE1	Standby Warning LED Indicator
PWR LED	Power LED Indicator
Printer	Parallel Printer Port
RAID LED	External RAID LED Header (Optional for OEM Only)
Slot 1-Slot 4	PCI 33 MHz (PCI #1-#4) (Note)
Slots 5-7	PCI-E x4 (Slot5), PCI-E x16 (Slot6), PCI-Ex1 (Slot7)
Speaker	Speaker Header
USB 1/2	(Back Panel) Universal Serial Ports 1-2
USB 3/4/5/6	(Back Panel) Universal Serial Ports 3-6
USB 7/8/9/10	(Front Panel) USB ports 7/8 (J44), USB 9/10 (J45)
VGA	Video/Graphic Connector (See Notes on Page 1-4)
WOL	Wake-On-LAN Header
WOR	Wake-On-Ring Header

Note: PCI Slot 4 (PCI-33 MHz) is not available on the PDSBA/PDSBE only.

Motherboard Features

CPU

- Single Intel Quad-core/Dual-core Core2 Duo/E6000/E4000/Xeon 3000/Pentium® D/Pentium® 4/Celeron Processor with a system bus speed of 1066/800/533 MHz
- Supports Intel EM64T, Enhanced Intel SpeedStep (EIST), Intel Virtualization Technology (VT), Streaming SIMD Extensions 2 & 3 (SSE2 & SSE3) and Execute Disable (XD) Bit.

Memory

- Supports unbuffered single or dual channel ECC/Non ECC Unbuffered DDR2 up to 8GB/s (DDR2 800/667/533) for single channel mode or dual-channel Interleaved mode.

Chipsets

- Intel Q965-Express GMCH (North Bridge) and ICH8 (South Bridge) (PDSBA-Q+)
- Intel G965 GMCH (North Bridge) and ICH8 (South Bridge) (PDSBA/PDSBA+)
- Intel P965 MCH (North Bridge) and ICH8 (South Bridge) (PDSBE)

Expansion Slots

- One (1) PCI-Express x16 (Slot 6)
- One (1) PCI-Express x4 (Slot 5)
- One (1) PCI-Express x1 (Slot 7)
- Four (4) 32-bit PCI 33MHz (Slot 1 to Slot 4) (PCI Slot 4 are available on the PDSBA/PDSBE only.)

BIOS

- 8 Mb Firmware Hub Phoenix Flash BIOS
- DMI 2.3, PCI 2.2, ACPI 1.0/2.0, Hardware BIOS virus protection, SMBIOS 2.3, Plug and Play (PnP)

PC Health Monitoring

- Onboard voltage monitors for +1.8V, CPU core, +3.3V, +3.3V standby, +5V, Vbat (battery voltage) and ±12V
- Fan status monitor with firmware 4 pin fan speed control
- CPU 3-Phase-switching voltage regulator
- SuperDoctor III, Watch Dog, NMI
- Power-up mode control for recovery from AC power loss
- CPU/System overheat LED and control
- System resource alert via Supero Doctor III
- Auto-switching voltage regulator for the CPU core
- CPU Thermal Trip support

- Thermal Monitor 2 (TM2) support
- SMT support (PDSBA-Q+/PDSBA+/PDSBA only)

ACPI Features

- Slow blinking LED for suspend state indicator
- BIOS support for USB keyboard
- Main switch override mechanism
- External modem ring-on

Onboard I/O

- Built in ICH8 SATA Controller, 4 connectors for 4 devices (300MB/S)
- 1 floppy port interface (up to 2.88 MB)
- 1 Fast UART 16550 compatible serial port/header
- Intel 82573L Gigabit Ethernet Controller (PCI-E)
- 1 EPP (Enhanced Parallel Port) and ECP (Extended Capabilities Port) with parallel port supported
- PS/2 mouse and PS/2 keyboard ports
- ITE Controller supports four IDE hard drives (PDSBA-Q+/PDSBA+ only)
- Up to 10 USB (Universal Serial Bus) 2.0 ports for a speed of up to 480Mbps
- Realtek ALC 883 7.1 Channel High Definition Audio (HDA) codecs supports 10 DAC Channels
- Built-in GMCH and Onboard VGA Connector (PDSBA-Q+/PDSBA+/PDSBA only)

Other

- Trusted Platform Module (TPM) support (PDSBA-Q+/PDSBA+/PDSBA only)
- Wake-on-LAN
- Wake-on-Ring (WOR)
- System Bus Clock Frequency Selection (Overclocking) Support (Note)
- Suspend-to-RAM
- Onboard +3V Standby Power Warning LED ("LE1")
- Pb Free

CD Utilities

- BIOS flash upgrade utility
- Drivers and software for Intel Q965-Express/G965/P965 chipset utilities

Dimensions

- ATX form factor, 11.6" x 9.6" (294.6 x 243.8 mm)



Note: For SATA RAID configuration instructions, please refer to the Intel HostRAID Utility User Guide listed on our website (<http://www.supermicro.com/Product/motherboard>).

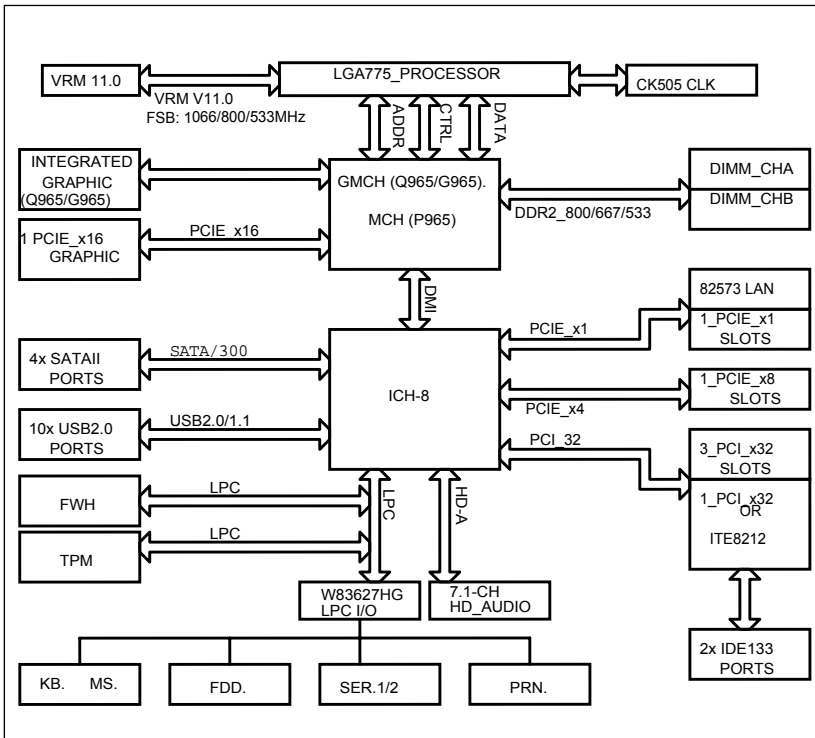

System Block Diagram

Note: This is a general block diagram and may not exactly represent the features on your motherboard. See the following pages for the actual specifications of each motherboard.

Note: Integrated Graphics is NOT available for the P965 Chipset.

1-2 Chipset Overview

The Intel Q965-Express/G965/P965 Chipsets are specially designed for use with Quad-core or Dual-core 1066/800/533 MHz processors. These chipsets consist of two primary components: the Graphic Memory Controller Hub (GMCH)/Memory Controller Hub (MCH) and the I/O Controller Hub (ICH8). Optimized for the Quad-core/Dual-core Core2 Duo/E6000/E4000/Xeon 3000/Pentium® D/Pentium® 4/Celeron Processor via an LGA775 socket, the Q965-Express/G965/P965 provides the performance and feature-set required for high-end UP quad-core and Dual-core processor desktop solutions. (Note: GMCH is for the Q965-Express and G965 only.)

Graphic Memory Controller Hub (GMCH)/Memory Controller Hub (MCH)

The GMCH/MCH manages the data flow of the following interfaces: the CPU interface (FSB), the System Memory interface (DRAM Controller) and the I/O Controller through DMI (Direct Media) Interface. The MCH supports a FSB frequency of 1066/800/533 MHz using a scalable CPU. The Q965-Express/G965/P965 platforms support the eighth generation I/O Controller Hub (Intel ICH8) to provide a variety of I/O related functions.

Intel ICH8 System Features

The Intel ICH8 offers the data buffering and interface arbitration required for the system to obtain peak performance. The Intel ICH8 supports up to six PCI-Express root ports, up to four SATA ports at generation 1 and 2 speeds and up to ten USB 2.0 ports. In addition, the Intel ICH8 features High Definition Audio controller which supports extreme multimedia applications and various third party codecs.

1-3 PC Health Monitoring

This section describes the PC health monitoring features of the PDSBA-Q+/PDSBA+/PDSBA/PDSBE. The motherboard has an onboard System Hardware Monitor chip that supports PC health monitoring.

Recovery from AC Power Loss

BIOS provides a setting for you to determine how the system will respond when AC power is lost and then restored to the system. You can choose for the system to remain powered off (in which case you must hit the power switch to turn it back on) or for it to automatically return to a power on state. See the Power Lost Control setting in the BIOS chapter of this manual to change this setting. The default setting is Always OFF.

Onboard Voltage Monitoring

The onboard voltage monitor will scan the following voltages continuously for the CPU Core, +1.8V, +3.3V, +3.3V standby, +5V, Vbat and $\pm 12V$. Once a voltage becomes unstable, it will give a warning or send an error message to the screen. Users can adjust the voltage thresholds to define the sensitivity of the voltage monitor by using SD III.

Fan Status Monitor with Software

The PC health monitor can check the RPM status of the cooling fans via Supero Doctor III.

CPU Overheat LED and Control

This feature is available when the user enables the CPU overheat warning function in the BIOS. This allows the user to define an overheat temperature. When this temperature reaches the pre-defined threshold, the CPU thermal trip feature will be activated and it will send a signal to the Speaker LED and, at the same time, the CPU speed will be decreased.

1-4 Power Configuration Settings

This section describes features of your motherboard that deal with power and power settings.

Slow Blinking LED for Suspend-State Indicator

When the CPU goes into a suspend state, the chassis power LED will start blinking to indicate that the CPU is in suspend mode. When the user presses any key, the CPU will wake-up and the LED will automatically stop blinking and remain on.

BIOS Support for USB Keyboard

If the USB keyboard is the only keyboard in the system, it will function like a normal keyboard during system bootup.

Main Switch Override Mechanism

When an ATX power supply is used, the power button can function as a system suspend button. When the user presses the power button, the system will enter a SoftOff state. The monitor will be suspended, and the hard drive will spin down. Pressing the power button again to wake-up the whole system. During the SoftOff state, the ATX power supply provides power to keep the required circuitry in the system alive. In case the system malfunctions and you want to turn off the power, just press and hold the power button for 4 seconds. The power will turn off and no power will be provided to the motherboard.

Wake-On-Ring (WOR) Header

Wake-up events can be triggered by a device such as the external modem ringing when the system is in the SoftOff state. Note that external modem ring-on can only be used with an ATX 2.01 (or above) compliant power supply.

1-5 Power Supply

As with all computer products, a stable power source is necessary for proper and reliable operation. It is even more important for processors that have high CPU clock rates of 1 GHz and faster.

The **SUPER** PDSBA-Q+/PDSBA+/PDSBA/PDSBE accommodates 12V ATX power supplies. It is strongly recommended that you use a high quality power supply that meets 12V ATX power supply Specification 1.1 or above. It is also required that the 12V 4-pin power connection (J41) be used for high-load configurations. In areas where noisy power transmission is present, you may choose to install a line filter to shield the computer from noise. It is recommended that you also install a power surge protector to help avoid problems caused by power surges.

1-6 Super I/O

The disk drive adapter functions of the Super I/O chip include a floppy disk drive controller that is compatible with industry standard 82077/765, a data separator, write pre-compensation circuitry, decode logic, data rate selection, a clock generator, drive interface control logic and interrupt and DMA logic. The wide range of functions integrated onto the Super I/O greatly reduces the number of components required for interfacing with floppy disk drives. The Super I/O supports two 360 K, 720 K, 1.2 M, 1.44 M or 2.88 M disk drives and data transfer rates of 250 Kb/s, 500 Kb/s or 1 Mb/s.

It also provides two high-speed, 16550 compatible serial communication ports (UARTs). Each UART includes a 16-byte send/receive FIFO, a programmable baud rate generator, complete modem control capability and a processor interrupt system. Both UARTs provide legacy speed with baud rate of up to 115.2 Kbps as well as an advanced speed with baud rates of 250 K, 500 K, or 1 Mb/s, which support higher speed modems.

The Super I/O provides functions that comply with ACPI (Advanced Configuration and Power Interface), which includes support of legacy and ACPI power management through a SMI or SCI function pin. It also features auto power management to reduce power consumption.

Chapter 2

Installation

2-1 Static-Sensitive Devices

Electro-Static-Discharge (ESD) can damage electronic components. To prevent damage to your system board, it is important to handle it very carefully. The following measures are generally sufficient to protect your equipment from ESD.

Precautions

- Use a grounded wrist strap designed to prevent static discharge.
- Touch a grounded metal object before removing the board from the antistatic bag.
- Handle the board by its edges only; do not touch its components, peripheral chips, memory modules or gold contacts.
- When handling chips or modules, avoid touching their pins.
- Put the motherboard and peripherals back into their antistatic bags when not in use.
- For grounding purposes, make sure your computer chassis provides excellent conductivity between the power supply, the case, the mounting fasteners and the motherboard.
- Use only the correct type of onboard CMOS battery as specified by the manufacturer. Do not install the battery upside down to avoid a possible explosion.

Unpacking

The motherboard is shipped in antistatic packaging to avoid static damage. When unpacking the board, make sure the person handling it is static protected.

2-2 Motherboard Installation

All motherboards have standard mounting holes to fit different types of chassis. Make sure that the locations of all the mounting holes for both motherboard and chassis match. Make sure that the metal standoffs click in or are screwed in tightly. Then, use a screwdriver to secure the motherboard onto the motherboard tray. Do not use more than 8lbs of torq when tightening the screws. Take precautionary measures to prevent damage to the components when installing the motherboard to the chassis.

2-3 Installing the CPU



When handling the processor package, avoid placing direct pressure on the label area of the fan.

Notes:

1. Always connect the power cord last and always remove it before adding, removing or changing any hardware components. Make sure that you install the processor into the CPU LGA 775 socket before you install the CPU heatsink.
2. Intel's LGA CPU package contains the CPU fan and heatsink assembly. If you buy a CPU separately, make sure that you use only Intel-certified multi-directional heatsink and fan.
3. The Intel LGA6 heatsink and fan comes with a push-pin design and no tool is needed for installation.
4. Make sure to install the motherboard into the chassis before you install the CPU heatsink and fan.
5. When purchasing an FC-LGA6 CPU or when receiving a motherboard with an FC-LGA6 CPU pre-installed, make sure that the CPU plastic cap is in place and none of the CPU pins are bent; otherwise, contact the retailer immediately.
6. Refer to the MB Features Section for more details on CPU support.

Installing the LGA6 Processor

1. Press the load lever to release the load plate, which covers the CPU socket, from its locking position.

2. Gently lift the load lever to open the load plate.

PnP Cap on top of the Load Plate



Load Lever



Load Plate (with PnP Cap attached)



3. Use your thumb and your index finger to hold the CPU at the North Center Edge and the South Center Edge of the CPU.

4. Align CPU Pin1 (the CPU corner marked with a triangle) against the socket corner that is marked with a triangle cutout.

5. Align the CPU key that is the semi-circle cutout below a golden dot against the socket key, the Notch on the same side of the triangle cutout on the socket.

6. Once aligned, carefully lower the CPU straight down to the socket. (Do not drop the CPU on the socket nor move the CPU horizontally or vertically. Do not rub the CPU against the surface or against any pins of the socket to avoid damage to the CPU or the socket.)

7. With the CPU inside the socket, inspect the four corners of the CPU to make sure that the CPU is properly installed.

8. Use your thumb to gently push the load lever down to the lever lock.

9. If the CPU is properly installed into the socket, the plastic PnP cap will be automatically released from the load plate when the load lever is pushed in the lever lock. Remove the PnP cap from the motherboard.



Warning: Please save the plastic PnP cap. The motherboard must be shipped with the PnP cap properly installed to protect the CPU socket pins. Shipment without the PnP cap properly installed will cause damage to the socket pins.)

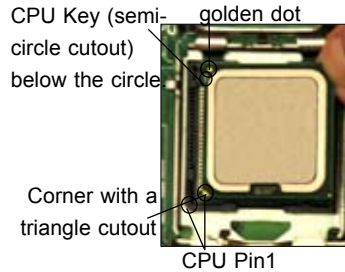
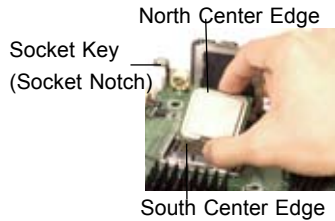

CPU in the CPU socket

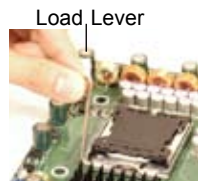

Load Lever



Plastic cap is released from the load plate if CPU properly installed.

2-4 Installing DIMM Modules

Note: Check the Supermicro website for recommended memory modules.



CAUTION

Exercise extreme care when installing or removing DIMM modules to prevent any possible damage. Also note that the memory is interleaved to improve performance (see step 1).

DIMM Installation

1. Insert the desired number of DIMMs into the memory slots, starting with Bank 1. The memory scheme is interleaved so you must install two modules of the same type at a time, beginning with Bank 1, then Bank 2, and so on.
2. Insert each DIMM module vertically into its slot. Pay attention to the notch along the bottom of the module to prevent inserting the DIMM module incorrectly.
3. Gently press down on the DIMM module until it snaps into place in the slot. Repeat for all modules (see step 1 above).

Memory Support

The PDSBA-Q+/PDSBA+/PDSBA/PDSBE supports up to 8 GB Unbuffered Non-ECC DDR2 800/667/533 in 4 DIMMs. Populating DIMM modules with a pair (or pairs) of memory modules that are of the same size and of the same type in DIMM#1A, DIMM#1B, DIMM#2A and DIMM#2B will result in interleaving memory.



Notes:

1. Due to the OS limitations, some operating systems may not show more than 4 GB of memory.
2. Both Unbuffered ECC and Non-ECC memory modules can be installed in the memory slots. However, the functionality of ECC is not supported by the chipset.
3. Due to memory allocation to system devices, memory remaining available for operational use will be reduced when 4 GB of RAM is used. The reduction in memory availability is disproportional. (See the Memory Availability Table on the following page.)

Possible System Memory Allocation & Availability		
System Device	Size	Physical Memory Remaining (-Available) (4 GB Total System Memory)
Firmware Hub flash memory (System BIOS)	1 MB	3.99GB
Local APIC	4 KB	3.99GB
Area Reserved for the chipset	2 MB	3.99GB
I/O APIC (4 Kbytes)	4 KB	3.99GB
PCI Enumeration Area 1	256 MB	3.76GB
PCI Express (256 MB)	256 MB	3.51GB
PCI Enumeration Area 2 (if needed) -Aligned on 256-MB boundary-	512 MB	3.01GB
VGA Memory	16 MB	2.85GB
TSEG	1 MB	2.84GB
Memory available for the OS & other applications		2.84GB

Installing and Removing DIMMs

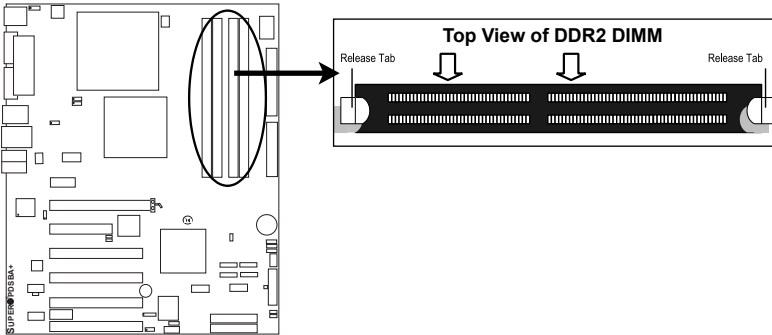

To Install: Insert module vertically and press down until it snaps into place. Pay attention to the alignment notch at the bottom.

To Remove:
Use your thumbs to gently push the release tabs near both ends of the module. This should release it from the slot.

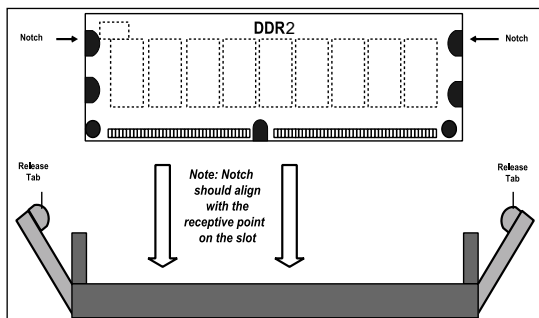

2-5 Control Panel Connectors/IO Ports

The I/O ports are color coded in conformance with the PC 99 specification. See Figure 2-3 below for the colors and locations of the various I/O ports.

Back Panel Connectors/IO Ports

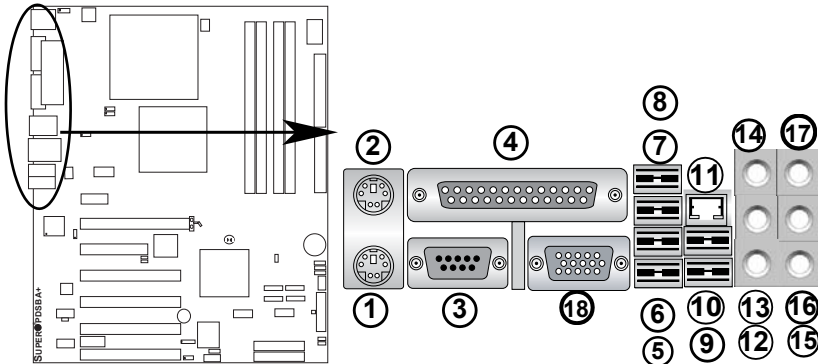

Back Panel I/O Port Locations and Definitions

Back Panel Connectors

1. Keyboard (Purple)
2. PS/2 Mouse (Green)
3. COM Port 1 (Turquoise)
4. Parallel Port (Printer)
5. Back Panel USB Port 3
6. Back Panel USB Port4
7. Back Panel USB Port 5
8. Back Panel USB Port 6
9. Back Panel USB Port 1
10. Back Panel USB Port 2
11. Gigabit LAN 1
12. Side_Surround (Grey)
13. Back_Surround (Black)
14. CEN/LFE (Orange)
15. Microphone-In (Pink)
16. Front (Green)
17. Line-In (Blue)
18. VGA (For PDSBA-Q+/PDS-BA+/PDSBA only. See Section 2-5 for details.)

Front Control Panel

JF1 contains header pins for various buttons and indicators that are normally located on a control panel at the front of the chassis. These connectors are designed specifically for use with Supermicro server chassis. See the figure below for the descriptions of the various control panel buttons and LED indicators. Refer to the following section for descriptions and pin definitions.

JF1 Header Pins

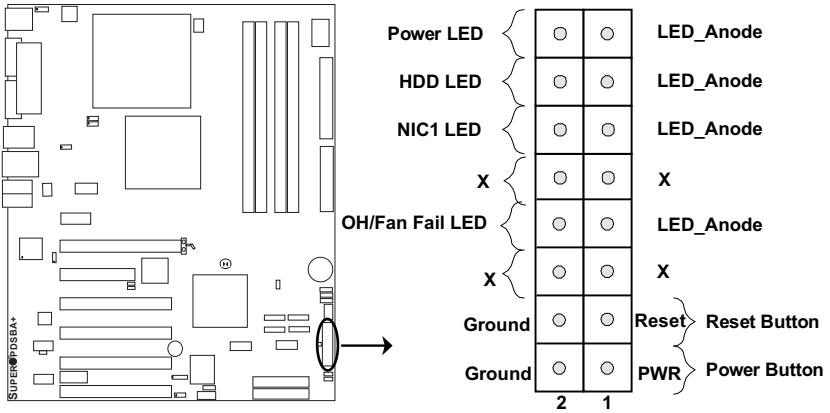

Front Control Panel Pin Definitions

Power LED

The Power LED connection is located on pins 15 and 16 of JF1. Refer to the table on the right for pin definitions.

Power LED Pin Definitions (JF1)	
Pin#	Definition
15	LED_Anode
16	PWR LED Signal

HDD LED

The HDD LED connection is located on pins 13 and 14 of JF1. Attach a hard drive LED cable here to display disk activity (for any hard drives on the system, including SAS and Serial ATA). See the table on the right for pin definitions.

HDD LED Pin Definitions (JF1)	
Pin#	Definition
13	LED_Anode
14	HD Active

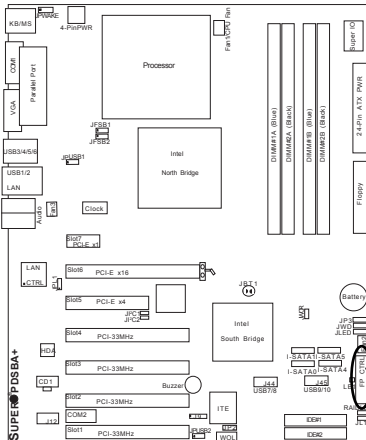

A. PWR LED

B. HDD LED

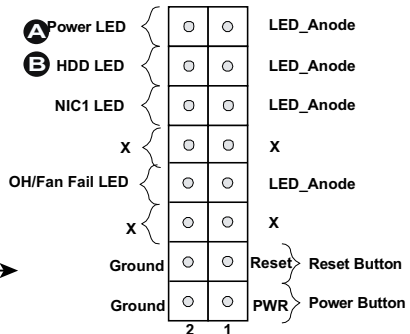

NIC1 Indicator

The NIC (Network Interface Controller) LED connection for GLAN port1 is located on pins 11 and 12 of JF1. Attach a NIC LED cables to display network activity. Refer to the table on the right for pin definitions.

GLAN LED Pin Definitions (JF1)	
Pin#	Definition
11	LED_Anode
12	NIC1 LED Signal

Overheat/Fan Fail LED (OH)

Connect an LED to the OH/Fan Fail LED connection on pins 7 and 8 of JF1 to provide advanced warning of chassis overheating or fan failure. Refer to the table on the right for pin definitions.

OH/Fan Fail LED Pin Definitions (JF1)	
Pin#	Definition
7	LED_Anode
8	OH/Fan Fail LED Signal

OH/Fan Fail Indicator Status	
State	Definition
Off	Normal
On	Overheat
Flashing	Fan Fail

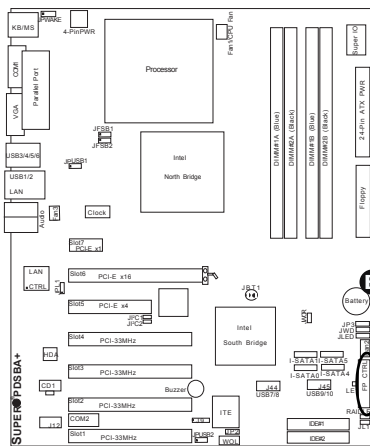

A. NIC1 LED

B. OH/Fan Fail LED

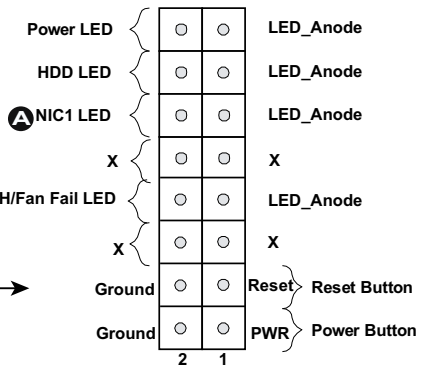

Reset Button

The Reset Button connection is located on pins 3 and 4 of JF1. Attach it to the hardware reset switch on the computer case. Refer to the table on the right for pin definitions.

Reset Button Pin Definitions (JF1)	
Pin#	Definition
3	Reset
4	Ground

Power Button

The Power Button connection is located on pins 1 and 2 of JF1. Momentarily contacting both pins will power on/off the system. This button can also be configured to function as a suspend button (with a setting in the BIOS - see Chapter 4). To turn off the power when in suspend mode, press the button for at least 4 seconds. Refer to the table on the right for pin definitions.

Power Button Pin Definitions (JF1)	
Pin#	Definition
1	Signal
2	+3V Standby

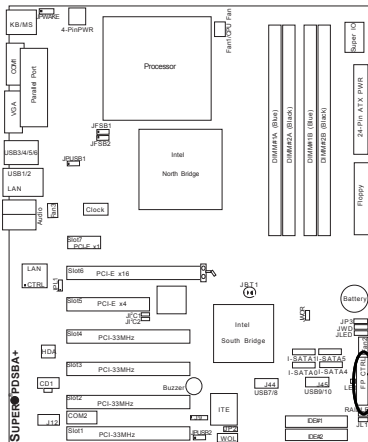

- A. Reset
- B. PWR Button

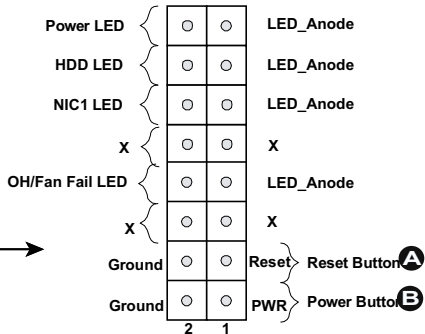

2-6 Connecting Cables

ATX/Auxiliary Power Connectors

There are one 24-pin main power connector (J40) and one 4-pin power connector (J41) on the motherboard. These power connectors meet the SSI EPS 12V specification. The 4-pin 12V PWR supply is required to provide adequate power to the system. See the table on the right for pin definitions.

ATX Power 24-pin Connector Pin Definitions			
Pin#	Definition	Pin #	Definition
13	+3.3V	1	+3.3V
14	-12V	2	+3.3V
15	COM	3	COM
16	PS_ON	4	+5V
17	COM	5	COM
18	COM	6	+5V
19	COM	7	COM
20	Res (NC)	8	PWR_OK
21	+5V	9	5VSB
22	+5V	10	+12V
23	+5V	11	+12V
24	COM	12	+3.3V

Required Connection

12V 4-pin Power Connector Pin Definitions	
Pins	Definition
1 and 2	Ground
3 and 4	+12V

Required Connection

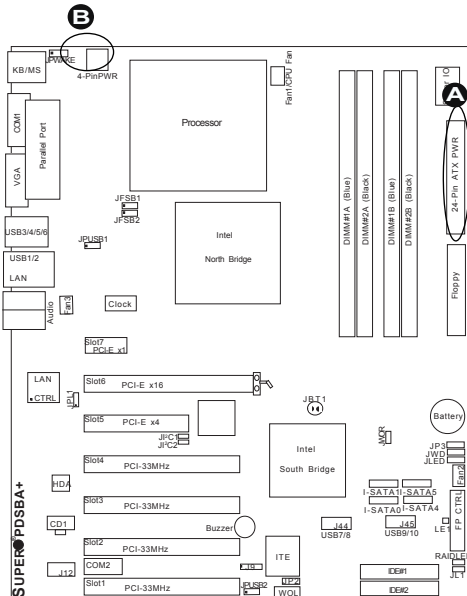

A. 24-pin ATX PWR

B. 4-pin PWR

Universal Serial Bus (USB)

There are ten USB 2.0 (Universal Serial Bus) ports/headers on the motherboard. Six of them are Back Panel USB ports (USB#1~2 at J11, USB#3~6 at J43), and four Front Panel USB headers (USB#7~8 at J44, and USB#9~10 at J45). See the tables on the right for pin definitions.

Back Panel USB Pin Definitions	
Pin#	Definitions
1	+5V
2	PO-
3	PO+
4	Ground
5	N/A

Front Panel USB Pin Definitions			
J44		J45	
Pin #	Definition	Pin #	Definition
1	+5V	1	+5V
2	PO-	2	PO-
3	PO+	3	PO+
4	Ground	4	Ground
5	Key	5	No connection

Chassis Intrusion

A Chassis Intrusion header is located at JL1 on the motherboard. Attach an appropriate cable from the chassis to inform you of a chassis intrusion when the chassis is opened.

Chassis Intrusion Pin Definitions (JL1)	
Pin#	Definition
1	Intrusion Input
2	Ground

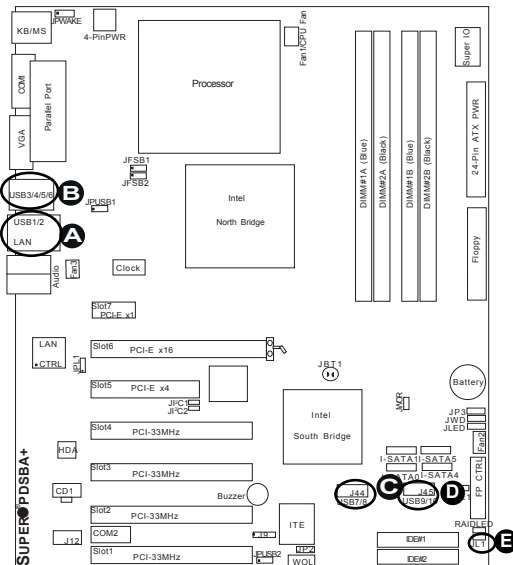

- A. Back panel USB Ports 1/2
- B. Back panel USB Ports 3/4/5/6
- C. Front Panel USB 7/8
- D. Front Panel USB 9/10
- E. Chassis Intrusion

Fan Headers

The PDSBA-Q+/PDSBA+/PDSBA/PDSBE has three chassis fan headers (Fan1 to Fan3). Fan 1 is the CPU Fan. Fan 2 and Fan 3 are system/chassis fans. (**Note:** all these fans are 4-pin fans. However, Pins 1-3 of these fan headers are backward compatible with the traditional 3-pin fans. For proper cooling, please use all 3-pin fans on the motherboard.) See the table on the right for pin definitions.

Fan Header Pin Definitions	
Pin#	Definition
1	Ground
2	+12V
3	Tachometer

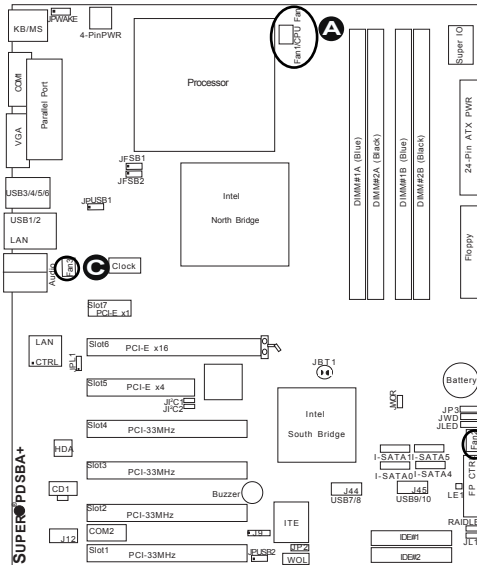

A. Fan 1 (CPU Fan)

B. Fan 2

C. Fan 3

ATX PS/2 Keyboard and PS/2 Mouse Ports

The ATX PS/2 keyboard and the PS/2 mouse are located at J28. See the table on the right for pin definitions. (The mouse port is above the keyboard port.) See the table on the right for pin definitions.

PS/2 Keyboard and Mouse Port Pin Definitions	
Pin#	Definition
1	Data
2	NC
3	Ground
4	VCC
5	Clock
6	NC

Serial Ports

COM1 (J28) is a connector located on the IO Backplane, and COM2 is a header located at J13. See the table on the right for pin definitions.

Serial Port Pin Definitions (COM1/COM2)			
Pin #	Definition	Pin #	Definition
1	CD	6	DSR
2	RD	7	RTS
3	TD	8	CTS
4	DTR	9	RI
5	Ground	10	NC

(Pin 10 is available on COM2 only. NC: No Connection.)

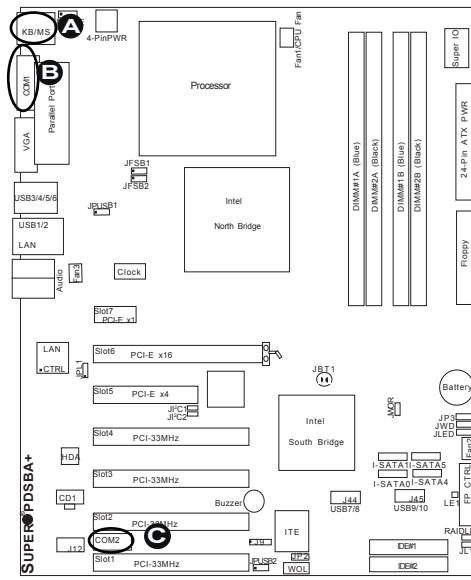

A. Keyboard/Mouse

B. COM1

C. COM2

Wake-On-Ring

The Wake-On-Ring header is located at JWOR. This connection allows your computer to "wale up" when receiving an incoming call to the modem when the system is in the suspend state. See the table on the right for pin definitions. You must have a Wake-On-Ring card and a cable to use this feature.

Wake-On-Ring Pin Definitions (JWOR)	
Pin#	Definition
1	Ground
2	Wake-up

Wake-On-LAN

The Wake-On-LAN header is located at JWOL on the motherboard. See the table on the right for pin definitions. (You must also have a LAN card with a Wake-On-LAN connector and a cable to use this feature.)

Wake-On-LAN Pin Definitions (JWOL)	
Pin#	Definition
1	+5V Standby
2	Ground
3	Wake-up

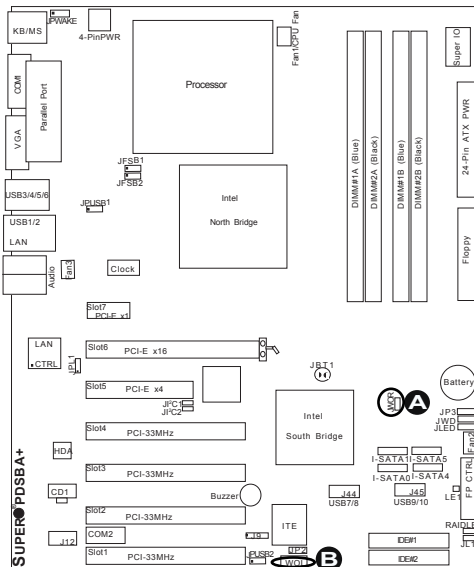

A. WOR
B. WOL

GLAN 1 (Giga-bit Ethernet Port)

A G-bit Ethernet port is located at J11 on the IO backplane. This port accepts RJ45 type cables.



GLAN1

Speaker

A Speaker/Buzzer header (J9) is located on the motherboard. See the table on the right for speaker pin definitions. The speaker connector pins are for use with an external speaker. If you wish to use the onboard speaker, you should close pins 3-4 with a jumper.

Speaker Connector	
Pin Setting	Definition
Pins 3-4	Internal Speaker
Pins 1-4	External Speaker

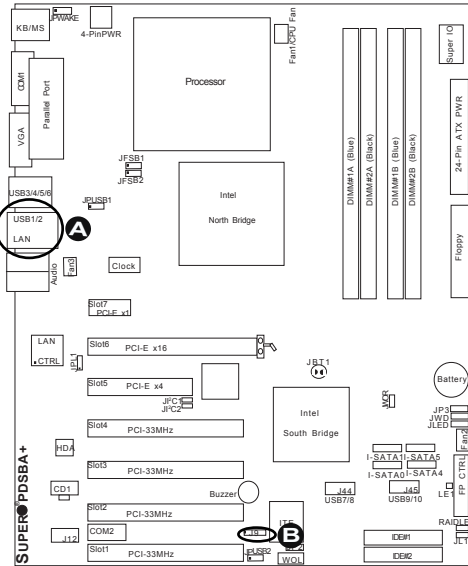

A. GLAN1

B. Speaker/Buzzer

High Definition Audio (HDA)

This motherboard features a 7.1+2 Channel High Definition Audio (HDA) (J46) codecs that provide ten DAC channels, simultaneously supporting 7.1 sound playback, and two channels of independent stereo sound output with multiple streaming through the front panel stereo out for front L&R, rear L&R, center and subwoofer speakers. Sound is then output through the Line In, Line Out and MIC jacks. Use the Advanced software program (included in the CD-ROM that came with your motherboard) to activate HD Audio.

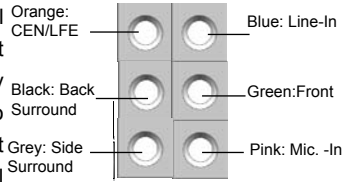

CD Header/Front Panel Audio Header

A 4-pin CD header (CD1) and a Front Panel Audio header (J12) are located on the motherboard. These headers allow you to use the onboard sound for audio CD playback. Connect the audio cable from your CD drive to the header that fits your cable's connector. Only one CD header can be used at a time. See the tables at right for pin definitions.

CD1 Pin Definition	
Pin#	Definition
1	Left Stereo Signal
2	Common
3	Common
4	Right Stereo Signal

Audio Output Header: rev. 1.2 Pin Definitions (Audio_FP)	
Pin#	Definition
1	MIC left channel
2	Ground
3	MIC right channel
4	Front panel audio detect
5	Line out right channel
6	MIC jack detect
7	Front audio jack detect
8	Key
9	Line out left channel
10	Line out jack detect

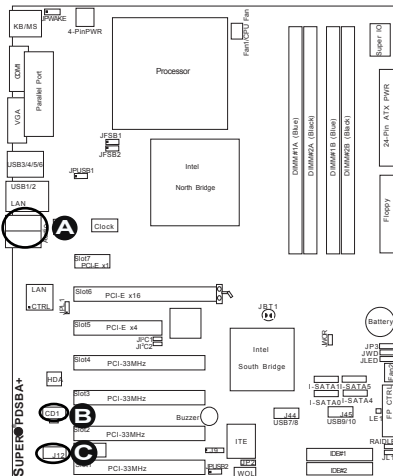

A. HD Audio

B. CD-In

C. Front Panel Audio

2-7 Jumper Settings

Explanation of Jumpers

To modify the operation of the motherboard, jumpers can be used to choose between optional settings. Jumpers create shorts between two pins to change the function of the connector. Pin 1 is identified with a square solder pad on the printed circuit board. See the motherboard layout pages for jumper locations.

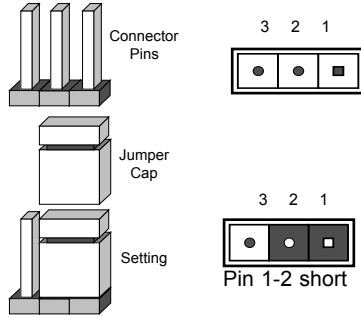

Note: On two pin jumpers, "Closed" means the jumper is on and "Open" means the jumper is off the pins.

GLAN Enable/Disable

JPL1 enables or disables GLAN Port1 on the motherboard. See the table on the right for jumper settings. The default setting is enabled.

GLAN Enable	
Pin#	Definition
1-2	Enabled (*default)
2-3	Disabled

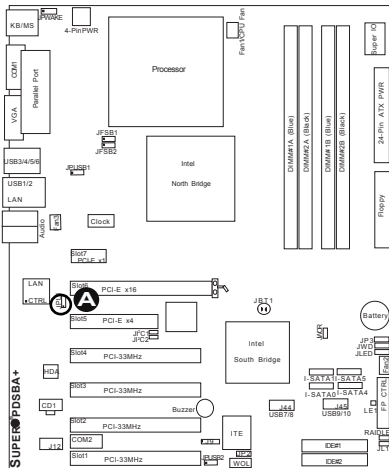

A. GLAN Port1 Enable

CMOS Clear

JBT1 is used to clear CMOS. Instead of pins, this "jumper" consists of contact pads to prevent the accidental clearing of CMOS. To clear CMOS, use a metal object such as a small screwdriver to touch both pads at the same time to short the connection. Always remove the AC power cord from the system before clearing CMOS.

 **Note:** For an ATX power supply, you must completely shut down the system, remove the AC power cord, and then short JBT1 to clear CMOS.



Watch Dog Enable/Disable

Watch Dog is a system monitor that can reboot the system when a software application hangs. Close Pins 1-2 to reset the system when an application hangs. Close pins 2-3 to generate a non-maskable interrupt signal for the application that hangs. See the table on the right for jumper settings. Watch Dog must also be enabled in the BIOS.

Watch Dog Jumper Settings (JWD)	
Jumper Setting	Definition
Pins 1-2	Reset (*default)
Pins 2-3	NMI
Open	Disabled

 **Note:** When enabled, the user needs to write their own application software in order to disable the Watch Dog Timer.

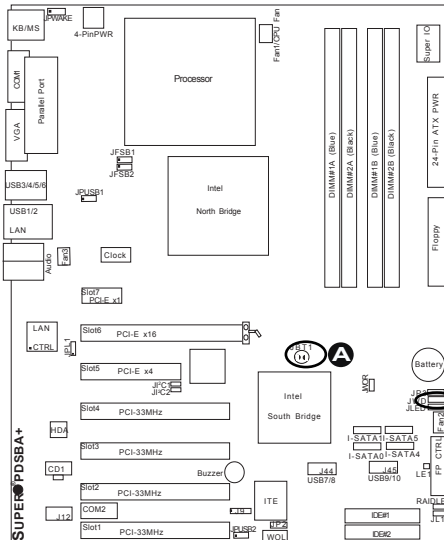

- A. Clear CMOS
- B. Watch Dog Enable

CPU Front Side Bus Speed

JFSB1 and JFSB2 allow you to set the Front Side Bus Frequency. See the table on the right for pin definitions. (Default is **Auto**.)

CPU FSB Jumper Settings Jumper Settings		
JFSB2	JFSB1	Frequency
1-2	1-2	*Auto
2-3	2-3	266MHz
Open	2-3	200MHz
2-3	Open	133MHz

PCI/PCI-E Slots to SMB Speeds

Jumper J1²C1/J1²C2 allow you to connect PCI/PCI-Exp. slots to the System Management Bus. The default setting is open to disable the connection. See the table on the right for jumper settings.

SMBus to PCI-X/PCI-Exp Slots Jumper Settings	
Jumper Setting	Definition
Closed	Enabled
Open	Disabled (*Default)

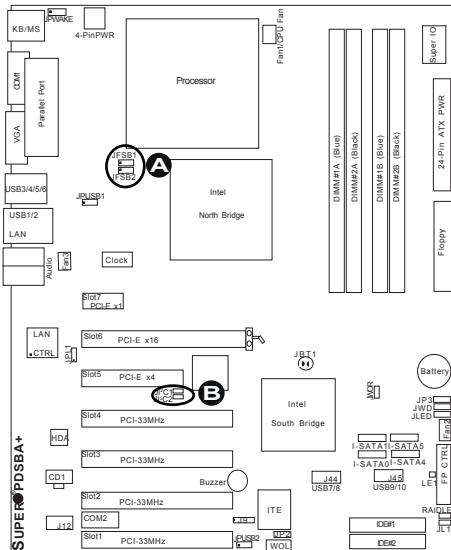

A. FSB CPU Speeds

B. PCI slots to SMB

USB Wake-Up

Use JPUSB jumpers to enable the function of "System Wake-Up via USB devices", which allows you to "wake-up" the system by pressing a key on the USB keyboard or by clicking the USB mouse of your system. The JPUSB jumpers are used together with the USB Wake-Up function in the BIOS. Enable both the jumpers and the BIOS setting to allow the system to "wake-up via USB Devices". See the table on the right for jumper settings and jumper connections. (**Note:** JPUSB1 is for Back Panel USB ports:1~6, and JPUSB2 is for Front Panel USB ports:7~10.)

(**Note:** The default jumper setting for the USB ports is **Disabled**. However, when the "USB Wake-Up" function is enabled in the BIOS, and the desired USB ports are enabled via the JPUSB jumper, please be sure to remove all USB devices from the USB ports whose USB jumpers are set to Disabled before the system goes into the standby mode.)

JPUSB1 (Back Panel USB Wake-up)	
Pin#	Definition
1-2	Enabled
2-3	Disabled (*default)

JPUSB2 (Front Panel USB Wake-up)	
Pin#	Definition
1-2	Enabled
2-3	Disabled (*default)

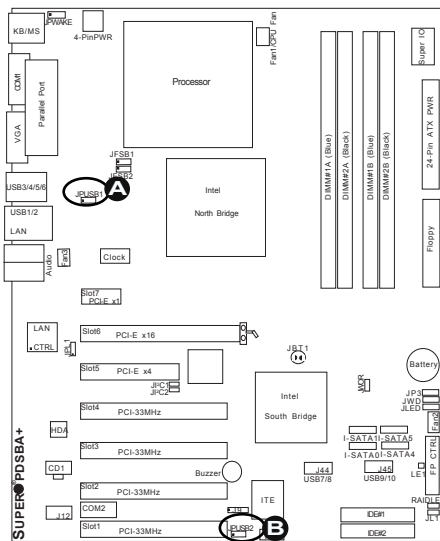

A. BP USB Wake-up

B. FP USB Wake-up

IDE Enable/Disable (*PDSBA-Q+/PDSBA+ only)

JP2 enables or disables IDE#1 and IDE#2 on the motherboard. See the table on the right for jumper settings. The default setting is enabled.

IDE Enable	
Pin#	Definition
1-2	Enabled (*default)
2-3	Disabled

TPM Enable (*PDSBA/PDSBA-Q+/PDSBA+ only)

JP3 enables or disables Trust Platform Module (Management) on the motherboard. See the table on the right for jumper settings. The default setting is enabled.

TPM Enable	
Pin#	Definition
1-2	Enabled (*default)
2-3	Disabled

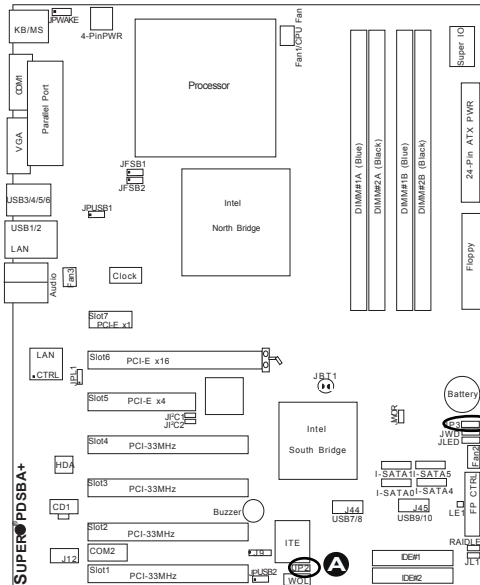

- A. IDE Enable
- B. TPM Enable

Keyboard Wake-Up

The JPWAKE jumper is used together with the Keyboard Wake-Up function in the BIOS. Enable both the jumper and the BIOS setting to allow the user to wake up the system when hitting a key on the keyboard. See the table on the right for jumper settings. Your power supply must meet ATX Specification 2.01 or higher and supply 720 mA of standby power to use this feature.

PS2 Keyboard Wake-up Jumper Settings

Pin#	Definition
1-2	Enabled (*default)
2-3	Disabled

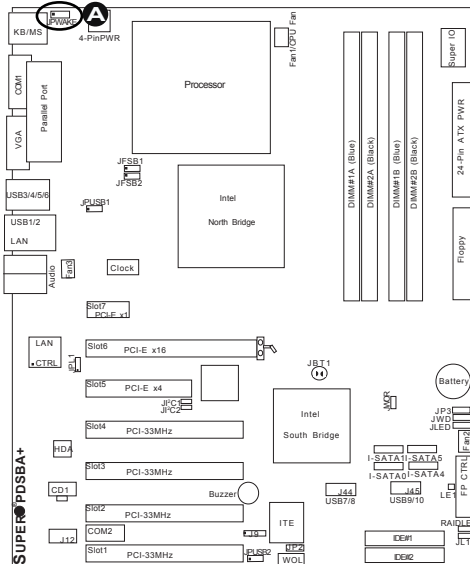

A. Keyboard Wake-up

2-8 Onboard Indicators

GLAN LEDs

A Gigabit LAN port is located at J11 above USB Ports 1 and 2 on the I/O Backpanel. This Gigabit Ethernet LAN port has two LEDs. The green LED indicates activity, while the Link LED may be green, amber or off to indicate the speed of the connection. See the tables at right for more information.

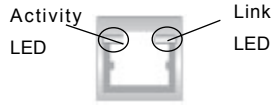

(Rear View: when viewing it from the rear side of chassis)

GLAN Activity Indicator		
Color	Status	Definition
Green	Flashing	Active

GLAN Link Indicator	
LED Color	Definition
Off	No Connection or 10 Mbps
Green (On)	100 Mbps
Amber (On)	1 Gbps

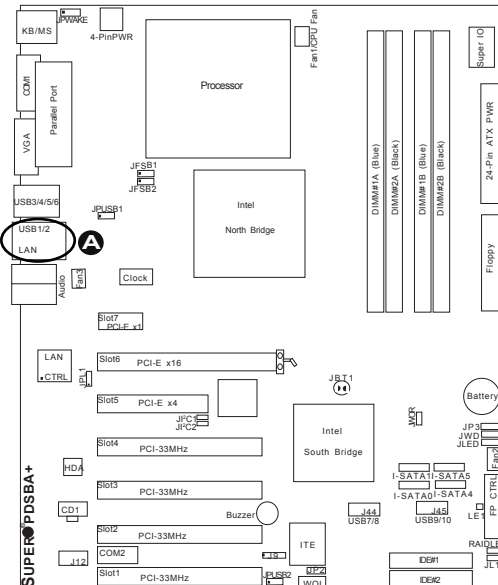

A. GLAN Port1 LEDs

Power LED

An Onboard Power LED is located at JLED on the motherboard. When this LED is lit, the system is on. Be sure to turn off the system and unplug the power cord before removing or installing components. See the layout below for the LED location.

Power LED Jumper Settings	
Jumper Setting	Definition
On	Enabled (*Default)
Off	Disabled

External RAID LED Header

An onboard RAID LED Header is located at J_RAID_LED on the motherboard. This LED header is for the external RAID card use only. See the layout below for the LED location.

RAID_LED LED Jumper Settings	
Jumper Setting	Definition
On	Enabled (*Default)
Off	Disabled

(*Optional for OEM only.)

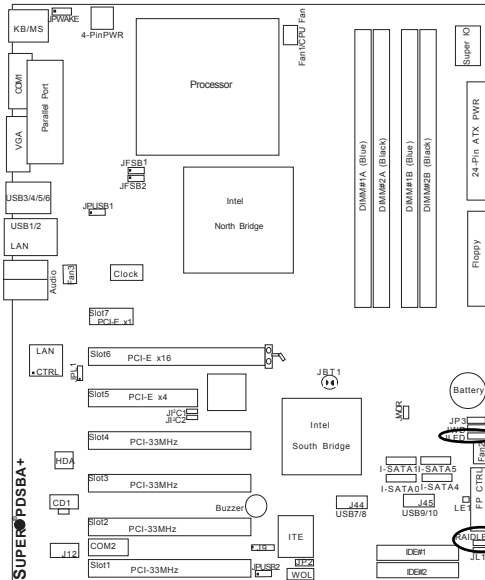

- A. Power LED
- B. External RAID LED

2-9 Parallel Port, Floppy Drive and IDE Hard Drive Connections

Note the following when connecting the floppy and hard disk drive cables:

- The floppy disk drive cable has seven twisted wires.
- A red mark on a wire typically designates the location of pin 1.
- A single floppy disk drive ribbon cable has two connectors to provide for two floppy disk drives. The connector with twisted wires always connects to drive A, and the connector that does not have twisted wires always connects to drive B.

Parallel (Printer) Port Connector

The parallel (printer) port is located at J30. See the table on the right for pin definitions.

Parallel (Printer) Port Connector Pin Definitions			
Pin#	Definition	Pin #	Definition
1	Strobe-	2	Auto Feed-
3	Data Bit 0	4	Error-
5	Data Bit 1	6	Init-
7	Data Bit 2	8	SLCT IN-
9	Data Bit 3	10	GND
11	Data Bit 4	12	GND
13	Data Bit 5	14	GND
15	Data Bit 6	16	GND
17	Data Bit 7	18	GND
19	ACK	20	GND
21	BUSY	22	Write Data
23	PE	24	Write Gate
25	SLCT	26	NC

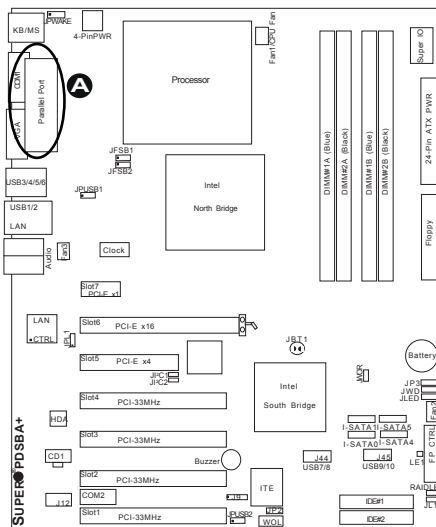

A. Parallel Port

Floppy Connector

The floppy connector is located at J27. See the table below for pin definitions.

Floppy Drive Connector Pin Definitions (Floppy)			
Pin#	Definition	Pin #	Definition
1	Ground	2	FDHDIN
3	Ground	4	Reserved
5	Key	6	FDEDIN
7	Ground	8	Index
9	Ground	10	Motor Enable
11	Ground	12	Drive Select B
13	Ground	14	Drive Select B
15	Ground	16	Motor Enable
17	Ground	18	DIR
19	Ground	20	STEP
21	Ground	22	Write Data
23	Ground	24	Write Gate
25	Ground	26	Track 00
27	Ground	28	Write Protect
29	Ground	30	Read Data
31	Ground	32	Side 1 Select
33	Ground	34	Diskette

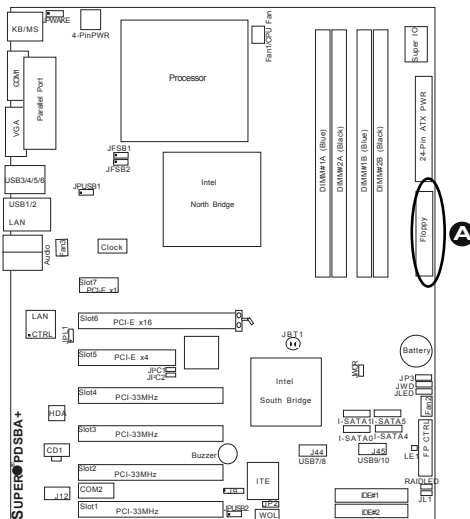

A. Floppy

IDE Connectors (*PDSBA-Q+/PDSBA+ only)

There are two ITE IDE Connectors on the PDSBA-Q+/PDSBA+. Be sure to close Pin 1 and Pin 2 of JP2 to enable the IDE connectors before using the connectors. (Please refer to the jumper section for more details.) See the table on the right for pin definitions.

IDE Connectors Pin Definitions			
Pin#	Definition	Pin #	Definition
1	Reset IDE	2	Ground
3	Host Data 7	4	Host Data 8
5	Host Data 6	6	Host Data 9
7	Host Data 5	8	Host Data 10
9	Host Data 4	10	Host Data 11
11	Host Data 3	12	Host Data 12
13	Host Data 2	14	Host Data 13
15	Host Data 1	16	Host Data 14
17	Host Data 0	18	Host Data 15
19	Ground	20	Key
21	DRQ3	22	Ground
23	I/O Write	24	Ground
25	I/O Read	26	Ground
27	IOCHRDY	28	BALE
29	DACK3	30	Ground
31	IRQ14	32	IOCS16
33	Addr1	34	Ground
35	Addr0	36	Addr2
37	Chip Select 0	38	Chip Select 1
39	Activity	40	Ground
41	Vcc	42	Vcc
43	Ground	44	No Connection

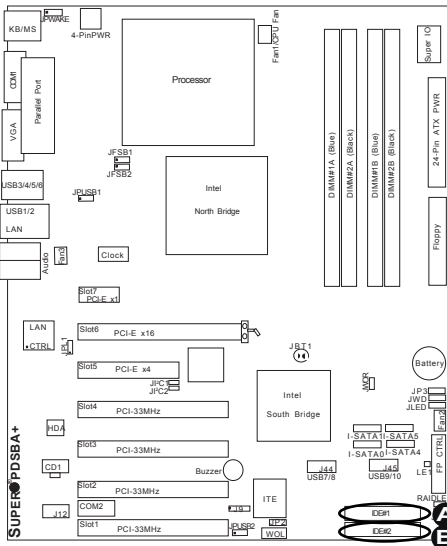

A. IDE#1

B. IDE#2

Chapter 3

Troubleshooting

3-1 Troubleshooting Procedures

Use the following procedures to troubleshoot your system. If you have followed all of the procedures below and still need assistance, refer to the 'Technical Support Procedures' and/or 'Returning Merchandise for Service' section(s) in this chapter. Always disconnect the AC power cord before adding, changing or installing any hardware components.

Before Power On

1. Make sure that there are no short circuits between the motherboard and chassis.
2. Disconnect all ribbon/wire cables from the motherboard including those for the keyboard and mouse.
3. Remove all add-on cards.
4. Install a CPU and heatsink (-making sure it is fully seated), connect the chassis speaker and the power LED to the motherboard. Check all jumper settings as well.
5. Make sure the 4-pin 12v power connector at J41 is connected to your power supply.

No Power

1. Make sure that there are no short circuits between the motherboard and chassis.
2. Make sure that all jumpers are set to their default positions.
3. Make sure that the 115V/230V switch on the power supply is properly set.
4. Turn the power switch on and off to test the system.
5. The battery on your motherboard may be old. Check to verify that it still supplies ~3VDC. If it does not, replace it with a new one.

No Video

1. If the power is on but you have no video, remove all the add-on cards and cables.
2. Use the speaker to determine if any beep codes exist. Refer to Appendix A for details on beep codes.

NOTE

If you are a system integrator, VAR or OEM, a POST diagnostics card is recommended. For I/O port 80h codes, refer to App. B.

Memory Errors

1. Make sure that the DIMM modules are properly and fully installed.
2. You should be using unbuffered DDR2 memory. Also, it is recommended that you use the same memory speed for all DIMMs in the system. [See Section 2-4 for memory limitations.](#)
3. Check for bad DIMM modules or slots by swapping modules between slots and noting the results.
4. Check the power supply voltage 115V/230V switch.

Losing the System's Setup Configuration

1. Make sure that you are using a high quality power supply. A poor quality power supply may cause the system to lose the CMOS setup information. Refer to Section 1-6 for details on recommended power supplies.
2. The battery on your motherboard may be old. Check to see if it still supplies ~3VDC. If it does not, replace it with a new one.
3. If the above steps do not fix the Setup Configuration problem, contact your vendor for repairs.

3-2 Technical Support Procedures

Before contacting Technical Support, please take the following steps. Also, note that as a motherboard manufacturer, Supermicro does not sell directly to end-users, so it is best to first check with your distributor or reseller for troubleshooting services.

They should know of any possible problem(s) with the specific system configuration that was sold to you.

1. Please go through the 'Troubleshooting Procedures' and 'Frequently Asked Question' (FAQ) sections in this chapter or see the FAQs on our website (<http://www.supermicro.com/support/faqs/>) before contacting Technical Support.
2. BIOS upgrades can be downloaded from our website at (<http://www.supermicro.com/support/bios/>).
3. If you still cannot resolve the problem, include the following information when contacting Supermicro for technical support: Motherboard model and PCB revision number
 - BIOS release date/version (this can be seen on the initial display when your system first boots up)
 - System configuration
 - An example of a Technical Support form is on our website at (<http://www.supermicro.com/support/contact.cfm>).
 - Distributors: For immediate assistance, please have your account number ready when placing a call to our technical support department. We can be reached by e-mail at support@supermicro.com, by phone at:(408) 503-8000, option 2, or by fax at (408)503-8019.



Note: Not all BIOS can be flashed; it depends on the modifications to the boot block code.

3-3 Frequently Asked Questions

Question: What type of memory does my motherboard support?

Answer: The PDSBA-Q+/PDSBA+/PDSBA/PDSBE supports unbuffered, DDR2-800/667/533 MHz memory modules. See Section 2-4 for details on installing memory.

Question: Why does Microsoft Windows XP (SP2) and Windows Vista show less memory than what is physically installed?

Answer: Microsoft implemented a design change in Windows XP with Service Pack 2 (SP2) and Windows Vista. This change is specific to the Physical Address Extension (PAE) mode behavior which improves driver compatibility. For

more information, please read the following article at Microsoft's Knowledge Base website at: <http://support.microsoft.com/kb/888137>.

Question: How do I update my BIOS?

Answer: It is recommended that you **do not** upgrade your BIOS if you are not experiencing any problems with your system. Updated BIOS files are located on our web site at <http://www.supermicro.com/support/bios/>. Please check our BIOS warning message and the information on how to update your BIOS on our web site. Select your motherboard model and download the BIOS file to your computer. Also, check the current BIOS revision and make sure that it is newer than your BIOS before downloading. You can choose from the zip file and the .exe file. If you choose the zip BIOS file, please unzip the BIOS file onto a bootable device or a USB pen. Run the batch file using the format flash.bat filename.rom from your bootable device or USB pen to flash the BIOS. Then, your system will automatically reboot. If you choose the .exe file, please run the .exe file under Windows to create the BIOS flash floppy disk. Insert the floppy disk into the system you wish to flash the BIOS. Then, bootup the system to the floppy disk. The BIOS utility will automatically flash the BIOS without any prompts. Please note that this process may take a few minutes to complete. Do not be concerned if the screen is paused for a few minutes.



Note: The SPI BIOS chip installed on this motherboard is not removable. To repair or replace a damaged BIOS chip, please send your motherboard to RMA at Supermicro for service.

Question: What's on the CD that came with my motherboard?

Answer: The supplied compact disc has quite a few drivers and programs that will greatly enhance your system. We recommend that you review the CD and install the applications you need. Applications on the CD include chipset drivers for Windows and security and audio drivers.

Question: How do I utilize the eight-channel sound?

Answer: The eight-channel sound available on the PDSBA-Q+/PDSBA+/PDSBA/PDSBE can be enabled with the audio driver software that was included in your motherboard package. When activated, sound will be routed through the jacks next to the LAN Port according to the audio connection descriptions listed on Page 2-6. You must also set the Azalia Audio setting to "Auto" in the Advanced Chipset section of the BIOS setup.

Question: I installed my microphone correctly but I can't record any sound. What should I do?

Answer: Go to <Start>, <Programs>, <Accessories>, <Entertainment> and then <Volume Control>. Under the Properties tab, scroll down the list of devices in the menu and check the box beside "Microphone".

Question: After I have installed 4 pieces of 1GB Memory, why does the BIOS only detect about 3.145 GB of memory during POST?

Answer: Because the chipset does not support memory remapping, and PCI-E memory requires a great deal of memory, so there is a memory hole located around the 4GB memory address.

Question: I have already enabled the USB Wake-Up mode in the BIOS, my system still cannot enter "Standby Mode"? Why?

Answer: In order for this function to work properly, please make sure that the USB Wake-Up Jumpers (JPUSB1/JPUSB2) are also enabled on the motherboard.

3-4 Returning Merchandise for Service

A receipt or copy of your invoice marked with the date of purchase is required before any warranty service will be rendered. You can obtain service by calling your vendor for a Returned Merchandise Authorization (RMA) number. When returning to the manufacturer, the RMA number should be prominently displayed on the outside of the shipping carton, and mailed prepaid or hand-carried. Shipping and handling charges will be applied for all orders that must be mailed when service is complete.

This warranty only covers normal consumer use and does not cover damages incurred in shipping or from failure due to the alteration, misuse, abuse or improper maintenance of products.

For faster service, RMA authorizations may be requested online (<http://www.supermicro.com/support/rma/>).

During the warranty period, contact your distributor first for any product problems.

Notes

Chapter 4

BIOS

4-1 Introduction

This chapter describes the Phoenix BIOS™ Setup utility for the PDSBA-Q+/PDS-BA+/PDSBA/PDSBE. The Phoenix ROM BIOS is stored in a flash chip and can be easily upgraded using a floppy disk-based program.



Note: Due to periodic changes to the BIOS, some settings may have been added or deleted and might not yet be recorded in this manual. Please refer to the Manual Download area of the Supermicro website <<http://www.supermicro.com>> for any changes to the BIOS that may not be reflected in this manual.

System BIOS

BIOS is the Basic Input Output System used in all IBM® PC, XT™, AT®, and PS/2® compatible computers. The Phoenix BIOS stores the system parameters, types of disk drives, video displays, etc. in the CMOS. The CMOS memory requires very little electrical power. When the computer is turned off, a backup battery provides power to the CMOS logic, enabling it to retain system parameters. Each time when the computer is powered on, the computer is configured with the values stored in the CMOS logic by the system BIOS, which gains control at boot up.

How To Change the Configuration Data

The CMOS information that determines the system parameters may be changed by entering the BIOS Setup utility. This Setup utility can be accessed by pressing the <Delete> key at the appropriate time during system boot. Normally, the only visible POST (Power On Self Test) routine is the memory test. As the memory is being tested, press the <Delete> key to enter the main menu of the BIOS Setup utility. From the main menu, you can access the other setup screens. Beginning with Section 4-3, detailed descriptions are given for each parameter setting in the Setup utility.

4-2 Running Setup

Default settings are in bold text unless otherwise noted.

The BIOS setup options described in this section are selected by choosing the appropriate text from the main BIOS Setup screen. All displayed text is described in this section, although the screen display is often all you need to understand how to set the options (See the next page).

When you first power on the computer, the Phoenix BIOS™ is immediately activated.

While the BIOS is in control, the Setup program can be activated in one of two ways:

1. By pressing <Delete> immediately after turning the system on, or
2. When the message shown below appears briefly at the bottom of the screen during the POST (Power On Self-Test), press the <Delete> key to activate the main Setup menu.

Press the <Delete> key to enter Setup

4-3 Main BIOS Setup

All main Setup options are described in this section. The main BIOS Setup screen displays below.

Use the Up/Down arrow keys to move between the different settings in each menu. Use the Left/Right arrow keys to change the options for each setting.

Press the <Esc> key to exit the BIOS Setup Menu. The next section describes in detail how to navigate through the menus.

Items that use submenus are indicated with the ► icon. With the item highlighted, press the <Enter> key to access the submenu.



Warning: Do not shut down or reset the system while updating the BIOS to prevent possible boot failure.

Main BIOS Setup Menu

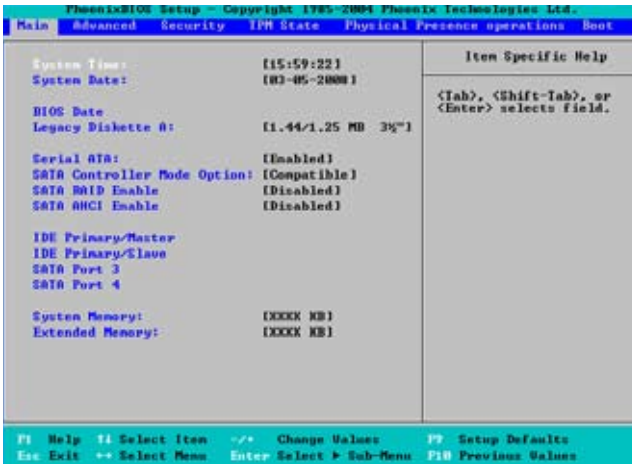

Main Setup Features

System Time

To set the system date and time, key in the correct information in the appropriate fields. Then press the <Enter> key to save the data.

System Date

Using the arrow keys, highlight the month, day and year fields, and enter the correct data. Press the <Enter> key to save the data.

BIOS Date

The item displays the date that this version of BIOS was built.

Legacy Diskette A

This setting allows the user to set the type of floppy disk drive installed as diskette A. The options are Disabled, 360Kb 5.25 in, 1.2MB 5.25 in, 720Kb 3.5 in, **1.44/1.25MB**, 3.5 in and 2.88 MB 3.5 in.

Serial ATA

This setting allows the user to enable or disable Serial ATA connections. The options are Disabled and **Enabled**.

SATA Controller Mode

Select **Compatible** to allow the SATA and PATA drives to be automatically-detected and be placed in the Legacy Mode by the BIOS. Select **Enhanced** to allow the SATA and PATA drives to be to be automatically-detected and be placed in the Native Mode.



Note: The Enhanced mode is supported by the Windows 2000 or a later version of OS. Also, for SATA RAID configuration instructions, please refer to the Intel HostRAID Utility User Guide listed on our website (<http://www.supermicro.com/Product/motherboard>).

Serial ATA (SATA) RAID Enable

Select **Enable** to enable Serial ATA RAID functions. (For the Windows OS environment, use the RAID driver if this feature is set to Enabled. When set to Enabled, the item: ICH RAID Code Base will become available. If this item is set to Disabled, the item-SATA AHCI Enable will be available.) The options are **Enabled** and **Disabled**.

ICH RAID Code Base

Select **Intel** to enable the Intel SATA Host RAID Utility. Select **Intel** to use the Intel HostRAID Utility. The default setting is **Intel**.

SATA AHCI

Select **Enable** to enable the function of Serial ATA Advanced Host Interface. (Take caution when using this function. This feature is for advanced programmers only. The Enhanced AHCI mode is available when the Windows XP-SP1 OS and the IAA Driver is used.) The options are **Enabled** and **Disabled**.

►IDE Primary Master/Slave, SATA Port3/SATA Port4 (SATA Port3 and SATA Port4 are optional for OEM only.)

These settings allow the user to set the parameters of IDE Primary Master/Slave, SATA Port 3 and SATA Port 4 connections. Hit <Enter> to activate the following sub-menu screen for detailed options of the items. Set the correct configurations accordingly. The items included in the sub-menu are:

Type

This feature allows the user to select the type of a drive specified. Select **Auto** to allow the BIOS to automatically set the capacity of the drive specified. Enter a number between 1 and 39 to select a predetermined type of this drive. Select **User** to allow the user to enter the parameters of the drive installed at this connection. Select **CDROM** if a CDROM drive is installed. Select **ATAPI** if a

removable disk drive is installed.

Multi-Sector Transfers

This item allows the user to specify the number of sectors per block to be used for multi-sector transfer. The options are **Disabled**, 4 Sectors, 8 Sectors, and 16 Sectors.

32-Bit I/O

Select Enable to enable the function of 32-bit IDE data transfer. The options are Enabled and **Disabled**.

LBA Mode Control

This item determines whether the Phoenix BIOS will access the IDE Primary Master device via the LBA mode. The options are Enabled and **Disabled**.

Transfer Mode

This option allows the user to set the transfer mode. The options are **Standard**, Fast PIO1, Fast PIO2, Fast PIO3, Fast PIO4, FPIO3/DMA1 and FPIO4/DMA2.

Ultra DMA Mode

This option allows the user to configure the Ultra DMA Mode. The options are **Disabled**, Mode 0, Mode 1, Mode 2, Mode 3, Mode 4, and Mode 5.

System Memory

This feature informs you how much system memory has been detected by the BIOS.

Extended Memory

This feature informs you how much extended memory has been detected by the BIOS.

4-4 Advanced Setup

Choose Advanced from the Phoenix BIOS Setup Utility main menu with the arrow keys. You should see the following display. The items with a triangle beside them have submenus that can be accessed by highlighting the item and pressing <Enter>.



▶ Boot Features

Access the submenu to make changes to the following settings.

QuickBoot Mode

If enabled, this feature will speed up the POST (Power On Self Test) routine by skipping certain tests after the computer is turned on. The settings are **Enabled** and Disabled. If Disabled, the POST routine will run at normal speed.

Quiet Mode

This setting allows you to **Enable** or Disable the graphic logo screen display at bootup.

POST Errors

Select **Enabled** to stop the POST routine and allow the system to display error messages when an error occurs at bootup. The options are **Enabled** and Disabled.

POST Beeps

Select **Enabled** to activate the alarm if an error occurs at bootup. If set to Disabled, the alarm will not be activated even if a boot error occurs.

ACPI Mode

Select **Yes** to use the ACPI (Advanced Configuration and Power Interface) power management on your system. The options are **Yes** and **No**.

ACPI Sleep Mode

Use this setting to configure the ACPI (Advanced Configuration and Power Interface) power management mode on your system when it is in the sleep mode. The options are **S1**, **S3** and **S1S3**.

Enable Multimedia Timer

Select **Yes** to enable the onboard multimedia timer. The options are **Yes** and **No**.

Power Button Behavior

If set to **Enabled**, the system will power on or power off immediately as soon as the user hits the power button. The options are **Enabled** and **Disabled**.

Resume On Modem Ring

Select **On** to “wake your system up” when an incoming call is received by your modem. The options are **On** and **Off**.

Resume On PME#

Select **On** to “wake your system up” from the PME#. The options are **On** and **Off**.

PS2 Keyboard (KB)/Mouse Wake Up

Select **Enable** to “wake your system up” from the **S3**, **S4** or **S5** state. If this feature is set enabled, you will also need to enable the JPWAKE jumper by closing pins 1-2. (Please refer to Page 1-5 and Chapter 2 for more details). The default setting is **Disabled**.

Power Loss Control

This setting allows you to choose how the system will react when power returns after an unexpected power loss. The options are **Stay Off**, **Power On**, and **Last State**.

Watch Dog

If enabled, this option will automatically reset the system if it is not active for more than 5 minutes. The options are **Enabled** and **Disabled**.

Summary Screen

This setting allows you to **Enable** or Disable the summary screen which displays the system configuration during bootup.

►Advanced Processor Options

Access the submenu to make changes to the following settings.

CPU Speed

This is a display to indicate the speed of the CPU installed on the motherboard.

Frequency Ratio (Available when supported by the CPU)

The feature allows the user to set the internal frequency multiplier for the CPU. The options are: **Default** and x9.

CPU Overclocking (Available when supported by the CPU)

Select enabled to enable CPU Overclocking which will cause the CPU to operate at a higher speed than that is intended. (**Note:** Supermicro does not recommend CPU Overclocking because it might impede CPU or system stability.) The options are: **Disabled**, +5%, +10%, +15%, and +20%.

CPU Overvoltage (Available when supported by the CPU)

Select enabled to enable CPU Overvoltage which will allow the CPU to operate at a higher voltage rate than that is intended. (**Note:** Supermicro does not recommend CPU Overvoltage because it might impede CPU or system stability.) The default setting is **Disabled**.

Core-Multi-Processing (Available when supported by the CPU)

Set to Enabled to use a processor's Second Core and beyond. (Please refer to Intel's website for more information.) The options are Disabled and **Enabled**.

Hyperthreading (Available when supported by the CPU)

Set to Enabled to use the Intel Hyperthreading Technology, which will result in increased CPU performance. The options are Disabled and Enabled.

Machine Checking (Available when supported by the CPU)

Set to Enabled to activate the function of Machine Checking and allow the CPU to detect and report hardware (machine) errors via a set of model-specific registers (MSRs). The options are **Disabled** and Enabled.

Fast String Operations (Available when supported by the CPU)

Set to **Enabled** to enable the fast string operations for special CPU instructions. The options are Disabled and **Enabled**.

Compatible FPU Code (Available when supported by the CPU)

Set to Enabled to keep the content of the last instruction Operating Code (OPCode) in the floating point (FP) state. The options are **Disabled** and Enabled.

Split Lock Operation

Set to **Enabled** to mask alignment check exceptions for split-lock transactions. The options are Disabled and **Enabled**.

Thermal Management 2 (Available when supported by the CPU)

Set to **Enabled** to use Thermal Management 2 (TM2) which will lower CPU voltage and frequency when the CPU temperature reaches a predefined overheat threshold. Set to Disabled to use Thermal Manager 1 (TM1), allowing CPU clocking to be regulated via CPU Internal Clock modulation when the CPU temperature reaches the overheat threshold.

Adjacent Cache Line Prefetch (Available when supported by the CPU)

The CPU fetches the cache line for 64 bytes if this option is set to Disabled. The CPU fetches both cache lines for 128 bytes as comprised if Enabled. The options are Disabled and **Enabled**.

Set Maximum Ext. CPUID=3

When set to Enabled, the Maximum Extended CPUID will be set to 3. The options are **Disabled** and Enabled.

Echo TPR

Set to **Enabled** to prevent xTPR messages from being sent to the system. The options are Disabled and **Enabled**.

C1 Enhanced Mode (Available when supported by the CPU)

Set to Enabled to enable the Enhanced Halt State to lower CPU voltage/frequency to prevent overheat. The options are Enabled and **Disabled**. (**Note:** please refer to Intel's website for detailed information.)

Intel <R> Virtualization Technology (Available when supported by the CPU)

Select Enabled to use the feature of Virtualization Technology and allow one platform to run multiple operating systems and applications in independent partitions, creating multiple virtual systems in one physical computer. The options are Enabled and **Disabled**. (**Note:** If there is any change to this setting, you will need to power off and restart the system for the change to take effect.) Please refer to Intel's website for detailed information.

No Execute Mode Memory Protection (Available when supported by the CPU and the OS.)

Set to Enabled to enable Execute Disable Bit and allow the processor to classify areas in the memory slot where an application code can execute and where it cannot, and thus preventing a worm or a virus from inserting and creating a flood of codes to overwhelm the processor and damage the system during an attack.

Note: this feature is available when your OS and your CPU support the functionality of Execute Disable Bit. The options are Disabled and **Enabled**. For more information regarding hardware/software support for this function, please refer to Intel's and Microsoft's websites.

Intel Speed Step Support (Available when supported by the CPU)

Select Enabled to use the Enhanced Intel SpeedStep Technology and allow the system to automatically adjust processor voltage and core frequency in an effort to reduce power consumption and heat dissipation. The options are Enabled and **Disabled**. Please refer to Intel's website for detailed information.

► Advanced Chipset Control

Access the submenu to make changes to the following settings.



Warning: Take caution when changing the Advanced settings. An incorrect setting, a very high DRAM frequency, or an incorrect DRAM timing may make the system to become unstable. When this occurs, reset the setting to the default setting.

Clock Spectrum Feature

If Enabled, the BIOS will monitor the level of Electromagnetic Interference caused by the components and will attempt to decrease the interference whenever needed. The options are Enabled and **Disabled**.

PCI Express Graphics Port

If set to **Enabled**, the PCI Express Graphics port will always be enabled. If set to disabled, the PCI-E Graphics port will always be disabled. If set to Auto, the PCI-E graphics port will be enabled when a card is detected. If set to debug, the PCI-E graphics port will be enabled when a graphics card is detected; however, its link width will not be enforced. The options are Enabled, **Auto**, Debug and Disabled.

Default Primary Video Adapter

This feature allows the user to select the video device used by the BIOS during POST. If set to **Auto**, PEG, PCI, IGD (Internal Graphics Device) devices will be selected. If set to IGD (Internal Graphics Device), IGD and PCI devices will be selected. If set to PEG, PEG and PCI devices will be selected. If set to PCI, PCI, PEG and IGD devices will be selected.

On-chip Graphics (IGD) Enable

This feature allows the user to enable or disable the internal graphics device by setting this item to the desired value. The options are Disabled and **Auto**.

DVMT 3.0 Mode

This feature allows the user to configure the DVMT 3.0 Graphics Memory allocated by the driver for the use of an Internal Graphics Device. The options are Fixed, **DVMT** and Auto.

Pre-allocated Memory Size

This feature allows the user to set the total amount of Pre-allocated graphics memory to be used by the Internal Graphics Device. The options are 1 MB and **8 MB**.

Total Graphics Memory

This feature allows the user to set the total amount of graphics memory (including: pre-allocated, fixed and DVMT memory) to be used by the Internal Graphics Device. The default setting is **256MB**.

USB Function

Select Enabled to enable the function of the USB devices specified. The settings are **Enabled** and Disabled.

USB Support

This setting allows you to enable support for the USB devices. The settings are **Enabled** and Disabled.

Azalia Audio

Select **Auto** to enable Azalia Audio. The settings are **Auto** and Disabled.

► Memory Cache

Memory Cache

This setting allows the user to enable or disable the functionality of Memory Cache. The options are **Enabled** and Disabled.

Cache System BIOS Area

This setting allows you to designate a reserve area in the system memory to be used as a System BIOS buffer to allow the BIOS to write (cache) its data into this reserved memory area. Select **Write Protect** to enable this function, and this area will be reserved for BIOS ROM access only. Select Uncached to disable this function and make this area available for other devices.

Cache Video BIOS Area

This setting allows you to designate a reserve area in the system memory to be used as a Video BIOS buffer to allow the BIOS to write (cache) data into this reserved memory area. Select **Write Protect** to enable the function and this area will be reserved for Video BIOS ROM access only. Select Uncached to disable this function and make this area available for other devices.

Cache Base 0-512K

If enabled, this feature will allow the data stored in the base memory area: block 0-512K to be cached (written) into a buffer, a storage area in the Static DROM (SDROM) or to be written into L1, L2 cache inside the CPU to speed up CPU operations. Select Uncached to disable this function. Select Write Through to allow data to be cached into the buffer and written into the system memory at the same time. Select Write Protect to prevent data from being written into the base memory area of Block 0-512K. Select Write Back to allow the CPU to write data back directly from the buffer without writing data to the System Memory for fast CPU data processing and operation. The options are Uncached, Write Through, Write Protect, and **Write Back**.

Cache Base 512K-640K

If enabled, this feature will allow the data stored in the memory area: 512K-640K to be cached (written) into a buffer, a storage area in the Static DROM (SDROM) or written into L1, L2 or L3 cache inside the CPU to speed up CPU operations. Select Uncached to disable this function. Select Write Through to allow data to be cached into the buffer and written into the system memory at the same time.

Select Write Protect to prevent data from being written into the base memory area of Block 512K-640K. Select Write Back to allow the CPU to write data back directly from the buffer without writing data to the System Memory for fast CPU data processing and operation. The options are Uncached, Write Through, Write Protect, and **Write Back**.

Cache Extended Memory

If enabled, this feature will allow the data stored in the extended memory area to be cached (written) into a buffer, a storage area in the Static DROM (SDROM) or written into L1, L2 or L3 cache inside the CPU to speed up CPU operations. Select Uncached to disable this function. Select Write Through to allow data to be cached into the buffer and written into the system memory at the same time. Select Write Protect to prevent data from being written into the extended memory area above 1 MB. Select Write Back to allow the CPU to write data back directly from the buffer without writing data to the System Memory for fast CPU data processing and operation. The options are Uncached, Write Through, Write Protect, and **Write Back**.

Discrete MTRR Allocation

If enabled, MTRRs (-Memory Type Range Registers) are configured as distinct, separate units and cannot be overlapped. If enabled, the user can achieve better graphic effects when using a Linux graphic driver that requires the write-combining configuration with 4GB or more memory. The options are Enabled and **Disabled**.

► PCI Configuration

Access the submenu to make changes to the following settings for PCI devices.

► PCI 33 MHz Slot#1- PCI 33 MHz Slot#4

Access the submenu for each of the settings above to make changes to the following:

Option ROM Scan

When enabled, this setting will initialize the device expansion ROM. The options are **Enabled** and Disabled.

Enable Master

This setting allows you to enable the selected device as the PCI bus master. The options are **Enabled** and Disabled.

Latency Timer

This setting allows you to set the clock rate for the Bus Master. A high-priority, high-throughput device may benefit from a greater clock rate. The options are

Default, 0020h, 0040h, 0060h, 0080h, 00A0h, 00C0h, and 00E0h. For Unix, Novelle and other Operating Systems, please select the option: other. If a drive fails after the installation of a new software, you might want to change this setting and try again. A different OS requires a different Bus Master clock rate.

► **PCI-E x4 Slot#5/PCI-E x1 Slot#7/Onboard PCI-E x1 NIC/ Onboard PCI IDE**

Access the submenu for each of the settings above to make changes to the following:

PCI-E x4 Slot#5

PCI Express Port#1

Select Enabled to always enable PCI-Ex4 Slot 5 and all other PCI-E ports. Select Disabled to disable PCI-Ex4 Slot 5 and all other PCI-E ports. When set to Auto, PCI-Ex4 Slot 5 will be enabled if a PCI add-on card is detected. The options are **Auto**, Enabled and Disabled.

Option ROM Scan

When enabled, this setting will initialize the device expansion ROM. The options are **Enabled** and Disabled.

Enable Master

This setting allows you to enable the selected device as the PCI bus master. The options are **Enabled** and Disabled.

Latency Timer

This setting allows you to set the clock rate for the Bus Master. A high-priority, high-throughput device may benefit from a greater clock rate. The options are **Default**, 0020h, 0040h, 0060h, 0080h, 00A0h, 00C0h, and 00E0h. For the Unix, Novelle and other Operating Systems, please select the option: other. If a drive fails after the installation of a new software, you might want to change this setting and try again. A different OS requires a different Bus Master clock rate.

PCI-E x1 Slot#7

PCI Express Port#5

Select Enabled to always enable PCI-Ex1 Slot 7 and all other PCI-E ports. Select Disabled to disable PCI-Ex1 Slot 7 and all other PCI-E ports. When set to Auto, PCI-Ex1 Slot 7 will be enabled if a PCI add-on card is detected. The options are **Auto**, Enabled and Disabled.

Option ROM Scan

When enabled, this setting will initialize the device expansion ROM. The options are **Enabled** and Disabled.

Enable Master

This setting allows you to enable the selected device as the PCI bus master. The options are **Enabled** and Disabled.

Latency Timer

This setting allows you to set the clock rate for the Bus Master. A high-priority, high-throughput device may benefit from a greater clock rate. The options are **Default**, 0020h, 0040h, 0060h, 0080h, 00A0h, 00C0h, and 00E0h. For Unix, Novelle and other Operating Systems, please select the option: other. If a drive fails after the installation of a new software, you might want to change this setting and try again. A different OS requires a different Bus Master clock rate.

PCI-E x1 NIC**PCI Express Port#6**

Select Enabled to always enable PCI-Ex1 NIC and all other PCI-E ports. Select Disabled to disable PCI-Ex1 NIC and all other PCI-E ports. When set to Auto, PCI-Ex1 NIC will be enabled if a PCI add-on card is detected. The options are **Auto**, Enabled and Disabled.

Onboard GbE Option ROM Scan

When enabled, this setting will initialize the device expansion ROM. The options are **Enabled** and Disabled.

Enable Master

This setting allows you to enable the selected device as the PCI bus master. The options are **Enabled** and Disabled.

Latency Timer

This setting allows you to set the clock rate for the Bus Master. A high-priority, high-throughput device may benefit from a greater clock rate. The options are **Default**, 0020h, 0040h, 0060h, 0080h, 00A0h, 00C0h, and 00E0h. For Unix, Novelle and other Operating Systems, please select the option: other. If a drive fails after the installation of a new software, you might want to change this setting and try again. A different OS requires a different Bus Master clock rate.

Onboard PCI IDE

Option ROM Scan

When enabled, this setting will initialize the device expansion ROM. The options are **Enabled** and Disabled.

Enable Master

This setting allows you to enable the selected device as the PCI bus master. The options are **Enabled** and Disabled.

Latency Timer

This setting allows you to set the clock rate for the Bus Master. A high-priority, high-throughput device may benefit from a greater clock rate. The options are **Default**, 0020h, 0040h, 0060h, 0080h, 00A0h, 00C0h, and 00E0h. For Unix, Novelle and other Operating Systems, please select the option: other. If a drive fails after the installation of a new software, you might want to change this setting and try again. A different OS requires a different Bus Master clock rate.

IDE RAID Mode

This setting allows you to configure the IDE RAID Mode. The options are ATA and **ATA/ATAPI**. (**Note:** To configure ITE RAID settings, please refer to the ITE RAID documentation included in the CD that came with your motherboard.)

► I/O Device Configuration

Access the submenu to make changes to the following settings.

KBC Clock Input

This setting allows you to set a clock frequency for the KBC. The options are 6MHz, 8MHz, **12MHz**, and 16MHz.

Serial Port A

This setting allows you to decide how Serial Port A will be controlled. The options are **Enabled** (user defined), Disabled, and Auto (BIOS- or OS- controlled).

Base I/O Address

This setting allows you to select the base I/O address for Serial Port A. The options are **3F8**, 2F8, 3E8, and 2E8.

Interrupt

This setting allows you to select the IRQ (interrupt request) for Serial Port A. The options are IRQ3 and **IRQ4**.

Serial Port B

This setting allows you to decide how Serial Port B will be controlled. The options are **Enabled** (user defined), Disabled, Auto (BIOS controlled) and OS Controlled.

Mode

This setting allows you to set the type of a device that will be connected to Serial Port B. The options are **Normal** and IR (for an infrared device).

Base I/O Address

This setting allows you to select the base I/O address for Serial Port B. The options are 3F8, **2F8**, 3E8 and 2E8.

Interrupt

This setting allows you to select the IRQ (interrupt request) for Serial Port B. The options are **IRQ3** and IRQ4.

Parallel Port

This setting allows you to decide how the parallel port will be controlled. The options are **Enabled** (user defined), Disabled and Auto (BIOS-or OS- controlled).

Base I/O Address

Select the base I/O address for the parallel port. The options are **378**, 278 and 3BC.

Interrupt

This setting allows you to select the IRQ (interrupt request) for the parallel port. The options are IRQ5 and **IRQ7**.

Mode

This feature allows you to specify the parallel port mode. The options are Output only, Bi-Directional, EPP and **ECP**.

DMA Channel

This item allows you to specify the DMA channel for the parallel port. The options are DMA1 and **DMA3**.

Floppy Disk Controller

This setting allows you to decide how the floppy disk controller will be controlled. The options are **Enabled** (user defined), Disabled, and Auto (BIOS and OS controlled).

► Hardware Monitoring

CPU Overheat Temperature

This option allows the user to set a CPU temperature overheat threshold that will activate the alarm system when the CPU temperature reaches this pre-set temperature threshold. The options are 70°C, 75°C, **80°C** and 85°C. (See the note below.)

Highlight this and hit <Enter> to see the status of each of the following items:

CPU Temperature/System Temperature

If the feature of Auto Fan Control is enabled, the BIOS will automatically display the status of the fan as specified.

Fan Speed Control

Set to Enabled to enable Fan Speed Control. If set to Disabled, the function of Fan Speed Control will be turned off, and the fan will be running at the full speed of 12V at all time. The options are **Enabled** and Disabled.

Overheat Beep Function

Set to Enabled to activate the alarm when an overheating occurs. If set to Disabled, the alarm will not be turned on when an overheat occurs. The options are **Enabled** and Disabled.

Voltage Monitoring

The following items will be monitored and displayed:

Vcore-CPU/12V Vcc/5V Vcc/3.3V Vcc/-12V Vcc/5V Standby/3V Standby/Vbatt.



Note: In the Windows OS environment, the Supero Doctor III settings take precedence over the BIOS settings. When first installed, Supero Doctor III adopts the temperature threshold settings previously set in the BIOS. Any subsequent changes to these thresholds must be made within Supero Doctor, since the SD III settings override the BIOS settings. For the Windows OS to adopt the BIOS temperature threshold settings, please change the SDIII settings to be the same as those set in the BIOS.

4-5 Security Settings

Choose the Security menu from the Phoenix BIOS Setup Utility main menu with the arrow keys. You should see the following display. Security setting options are displayed by highlighting the setting using the arrow keys and pressing <Enter>. All Security BIOS settings are described in this section.

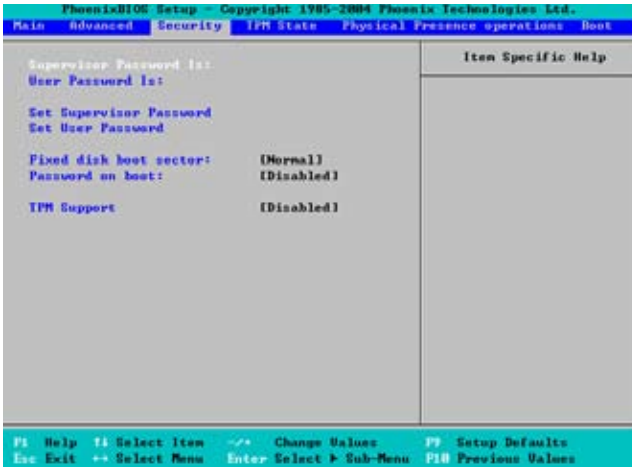

Supervisor Password Is:

This item indicates if a supervisor password has been entered for the system. Clear means such a password has not been used and Set means a supervisor password has been entered for the system.

User Password Is:

This item indicates if a user password has been entered for the system. Clear means such a password has not been used and Set means a user password has been entered for the system.

Set Supervisor Password

When the item Set Supervisor Password is highlighted, hit the <Enter> key. When prompted, type the Supervisor's password in the dialogue box to set or to change supervisor's password, which allows access to the BIOS.

Set User Password

When the item Set User Password is highlighted, hit the <Enter> key. When prompted, type the user's password in the dialogue box to set or to change the user's password, which allows access to the system at boot-up.

Fixed Disk Boot Sector

Select **Normal** to enable Write-Protect the boot sector on the hard drives to protect against viruses.

Password on Boot

This setting allows you to require a password to be entered when the system boots up. The options are Enabled (password required) and Disabled (password not required).

Trusted Platform Support (PDSBA-Q+/PDSBA+/PDSBA only)

Select Enabled to enable the Trusted Platform Support and allow the BIOS to automatically download the drivers needed in order to provide better support for the platform specified. The options are Enabled and **Disabled**.

4-6 TPM (Trusted Platform Modules) State

Choose the TPM State menu from the Phoenix BIOS Setup Utility with the arrow keys. You should see the following display.



Current TPM State

This item shows the current TPM State only.

Change TPM State

Select Enabled & Activate to enable TPM support for the system. Select De-activate & Disabled to disable the function of TPM support. If No Change is selected, no changes will be made to the current TPM State. Select Clear to clear or erase all information related to TPM support.

If set to Clear, the submenu:-Physical Presence Operations will appear. Select Reject to cancel the selection. Select Execute to proceed with selection. All information related to TPM Support will be erased.

4-7 Physical Presence Operations

If the item-Change TPM State on the previous menu is set Clear, the submenu of Physical Presence Operations will display as shown below.



Reject

Select Reject to cancel all the changes you've made to the TPM Support configuration settings.

Execute

Select Execute to proceed with the selections you've made on the TPM Support setting.

4-8 Boot Settings

Choose Boot from the Phoenix BIOS Setup Utility main menu with the arrow keys. You should see the following display. See details on how to change the order and specs of boot devices in the Item Specific Help window. All Boot BIOS settings are described in this section.

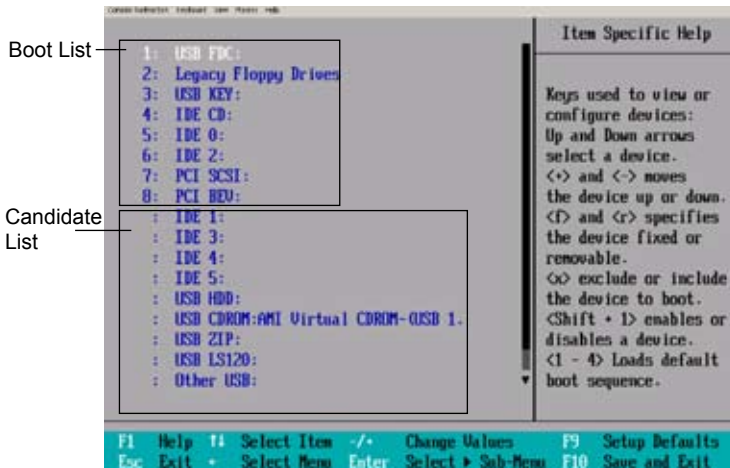

Boot Priority Order/Excluded from Boot Orders

The devices included in the boot list section (above) are bootable devices listed in the sequence of boot order as specified. The boot functions for the devices included in the candidate list (above) are currently disabled. Use a <+> key or a <-> key to move the device up or down. Use the <f> key or the <r> key to specify the type of an USB device, either fixed or removable. You can select one item from the boot list and hit the <x> key to remove it from the list of bootable devices (to make its resource available for other bootable devices). Subsequently, you can select an item from the candidate list and hit the <x> key to remove it from the candidate list and put it in the boot list. This item will then become a bootable device. See details on how to change the priority of boot order of devices in the Item Specific Help window.

4-9 Exit

Choose Exit from the Phoenix BIOS Setup Utility main menu with the arrow keys. You should see the following display. All Exit BIOS settings are described in this section.



Exit Saving Changes

Highlight this item and hit <Enter> to save any changes you may have made and to exit the BIOS Setup utility.

Exit Discarding Changes

Highlight this item and hit <Enter> to exit the BIOS Setup utility without saving any changes you may have made.

Load Setup Defaults

Highlight this item and hit <Enter> to load the default settings for all items in the BIOS Setup. These are the safest settings to use.

Discard Changes

Highlight this item and hit <Enter> to discard (cancel) any changes you have made. You will remain in the Setup utility.

Save Changes

Highlight this item and hit <Enter> to save any changes you have made. You will remain in the Setup utility.

Appendix A

POST Error Beep Codes

This section lists POST (Power On Self Test) error beep codes for the Phoenix BIOS. POST error beep codes are divided into two categories: recoverable and terminal. This section lists Beep Codes for recoverable POST errors.

Recoverable POST Error Beep Codes

When a recoverable type of error occurs during POST, BIOS will display a POST code that describes the problem. BIOS may also issue one of the following beep codes:

- 1 long and two short beeps - video configuration error
- 1 repetitive long beep - no memory detected
- 1 continuous beep with Front Panel OH LED on - system overheat

Notes

Appendix B

Installing the Windows OS

After all hardware components have been installed, you must first configure Intel South Bridge RAID Settings before you install the Windows OS and other software drivers. To configure RAID settings, please refer to RAID Configuration User Guides posted on our website at www.supermicro.com/support/manuals.

Installing the Windows XP/2003 OS

1. Insert Microsoft's Windows XP/2003 Setup CD in the CD Drive, and the system will start booting up from CD.
2. Press the <F6> key when the message-" Press F6 if you need to install a third party SCSI or RAID driver" displays.
3. When the Windows XP/2003 Setup screen appears, press "S" to specify additional device(s).
4. Insert the driver diskette-"ITE RAID XP/2003 Driver for IDE" into Drive A: and press the <Enter> key.
5. Press the <Enter> key to proceed with the installation process. (If you need to specify any additional devices to be installed, do it at this time.) Once all devices are specified, press the <Enter> key to continue with the installation.
6. From the Windows XP/2003 Setup screen, press the <Enter> key. The XP/2003 Setup will automatically load all device files and then continue with the Windows XP/2003 installation.
7. After the Windows XP/2003 OS Installation is completed, the system will automatically reboot.
8. Insert the Supermicro Setup CD that came with your motherboard into the CD Drive during system boot, and the main screen will display.

Notes

Appendix C

Software Installation Instructions

C-1 Installing Drivers

After you've installed the Windows Operating System, a screen as shown below will appear. You are ready to install software programs and drivers that have not yet been installed. To install these software programs and drivers, click the icons to the right of these items.

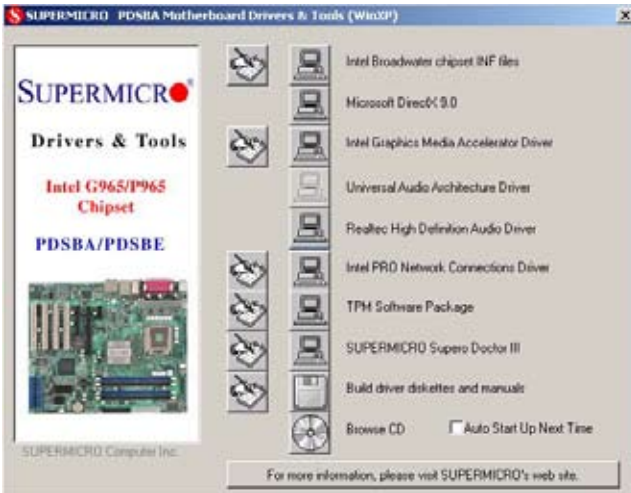

Driver/Tool Installation Display Screen

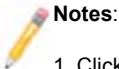

Notes:

1. Click the icons showing a hand writing on the paper to view the readme files for each item. Click a computer icon to the right of an item to install an item (from top to the bottom) one at a time. **After installing each item, you must reboot the system before proceeding with the next item on the list.** The bottom icon with a CD on it allows you to view the entire contents of the CD.
2. To configure ITE RAID settings, please refer to the ITE RAID documentation included in this CD.
3. For SATA RAID configuration instructions, please refer to the Intel HostRAID Utility User Guide listed on our website (<http://www.supermicro.com/Product/motherboard>).

C-2 Configuring Supero Doctor III

The Supero Doctor III program is a Web-based management tool that supports remote management capability. It includes remote and local Management tools. The local management is called the SD III Client. The Supero Doctor III program included on the CDROM that came with your motherboard allows you to monitor the environment and operations of your system. Supero Doctor III displays crucial system information such as CPU temperature, system voltages and fan status. See the Figure below for a display of the Supero Doctor III interface.

Notes

1: Both default user name and password are ADMIN.

2: In the Windows OS environment, the Supero Doctor III settings take precedence over the BIOS settings. When first installed, Supero Doctor III adopts the temperature threshold settings previously set in the BIOS. Any subsequent changes to these thresholds must be made within Supero Doctor, since the SD III settings override the BIOS settings. For the Windows OS to adopt the BIOS temperature threshold settings, please change the SDIII settings to be the same as those set in the BIOS.

Supero Doctor III Interface Display Screen-I (Health Information)



Supero Doctor III Interface Display Screen-II (Remote Control)

 **Note:** SD III Software Revision 1.0 can be downloaded from our Website at: ftp://ftp.supermicro.com/utility/Supero_Doctor_III/. You can also download SDIII User's Guide at: <http://www.supermicro.com/PRODUCT/Manuals/SDIII/UserGuide.pdf>. For Linux, we will still recommend that you use Supero Doctor II.

Notes

(Disclaimer)

The products sold by Supermicro are not intended for and will not be used in life support systems, medical equipment, nuclear facilities or systems, aircraft, aircraft devices, aircraft/emergency communication devices or other critical systems whose failure to perform be reasonably expected to result in significant injury or loss of life or catastrophic property damage. Accordingly, Supermicro disclaims any and all liability, and should buyer use or sell such products for use in such ultra-hazardous applications, it does so entirely at its own risk. Furthermore, buyer agrees to fully indemnify, defend and hold Supermicro harmless for and against any and all claims, demands, actions, litigation, and proceedings of any kind arising out of or related to such ultra-hazardous use or sale.