

SUPER[®]

SUPER 370DE6
SUPER 370DER
SUPER 370DEI

USER'S MANUAL

Revision 2.0

The information in this User's Manual has been carefully reviewed and is believed to be accurate. The vendor assumes no responsibility for any inaccuracies that may be contained in this document, makes no commitment to update or to keep current the information in this manual, or to notify any person or organization of the updates.

Please Note: For the most up-to-date version of this manual, please see our web site at www.supermicro.com.

SUPERMICRO COMPUTER reserves the right to make changes to the product described in this manual at any time and without notice. This product, including software, if any, and documentation may not, in whole or in part, be copied, photocopied, reproduced, translated or reduced to any medium or machine without prior written consent.

IN NO EVENT WILL SUPERMICRO COMPUTER BE LIABLE FOR DIRECT, INDIRECT, SPECIAL, INCIDENTAL, OR CONSEQUENTIAL DAMAGES ARISING FROM THE USE OR INABILITY TO USE THIS PRODUCT OR DOCUMENTATION, EVEN IF ADVISED OF THE POSSIBILITY OF SUCH DAMAGES. IN PARTICULAR, THE VENDOR SHALL NOT HAVE LIABILITY FOR ANY HARDWARE, SOFTWARE, OR DATA STORED OR USED WITH THE PRODUCT, INCLUDING THE COSTS OF REPAIRING, REPLACING, INTEGRATING, INSTALLING OR RECOVERING SUCH HARDWARE, SOFTWARE, OR DATA.

Any disputes arising between manufacturer and customer shall be governed by the laws of Santa Clara County in the State of California, USA. The State of California, County of Santa Clara shall be the exclusive venue for the resolution of any such disputes. Supermicro's total liability for all claims will not exceed the price paid for the hardware product.

Unless you request and receive written permission from SUPER MICRO COMPUTER, you may not copy any part of this document.

Information in this document is subject to change without notice. Other products and companies referred to herein are trademarks or registered trademarks of their respective companies or mark holders.

Copyright © 2000-2001 by SUPER MICRO COMPUTER INC.
All rights reserved.

Printed in the United States of America.

Preface

PREFACE

About This Manual

This manual is written for system integrators, PC technicians and knowledgeable PC users. It provides information for the installation and use of the SUPER 370DE6/370DER(370DER+)/370DEI(370DEI+) mainboard. The SUPER 370DE6/370DER/370DER+/370DEI/370DEI+ supports single or dual Pentium® III 500 MHz-1.13 GHz FCPGA processors with a 133/100 MHz front side bus. Please refer to the support section of our web site (<http://www.supermicro.com/TechSupport.htm>) for a complete listing of supported processors.

Pentium III FCPGA (Flip Chip Pin Grid Array) processors are housed in a 370-pin socket, which is the standard that will support future Intel processors. The 370DER/370DER+/370DEI/370DEI+ were designed specifically for use in rackmount 1-U systems.

Manual Organization

Chapter 1 includes a checklist of what should be included in your mainboard box, describes the features, specifications and performance of the SUPER 370DE6/370DER/370DER+/370DEI/370DEI+ mainboard and provides detailed information about the chipset.

Chapter 2 begins with instructions on handling static-sensitive devices. Read this chapter when you want to install the processor and DIMM memory modules and when mounting the mainboard in the chassis. Also refer to this chapter to connect the floppy and hard disk drives, SCSI drives, the IDE interfaces, the parallel and serial ports and the twisted wires for the power supply, the reset button, the power LED, the speaker and the keyboard.

If you encounter any problems, see **Chapter 3**, which describes troubleshooting procedures for the video, the memory and the setup configuration stored in CMOS. For quick reference, a general FAQ [Frequently Asked Questions] section is provided. Instructions are also included for contacting technical support. In addition, you can visit our web site at www.supermicro.com/techsupport.htm for more detailed information.

Chapter 4 includes an introduction to BIOS and provides detailed information on running the CMOS Setup utility.

Appendix A gives information on BIOS error beep codes.

Appendix B provides post checkpoint codes.

Preface

About This Manual	iii
Manual Organization	iii

Chapter 1: Introduction

1-1 Overview	1-1
Checklist	1-1
Contacting Supermicro	1-2
Notes	1-3
SUPER 370DE6 SECTION	1-4
SUPER 370DE6 Image	1-5
SUPER 370DE6 Layout	1-6
SUPER 370DE6 Quick Reference	1-7
SUPER 370DER SECTION	1-8
SUPER 370DER Image	1-9
SUPER 370DER Layout	1-10
SUPER 370DER+ Layout	1-11
SUPER 370DER Quick Reference	1-12
SUPER 370DER+ Quick Reference	1-13
SUPER 370DEI SECTION	1-14
SUPER 370DEI Image	1-15
SUPER 370DEI Layout	1-16
SUPER 370DEI+ Layout	1-17
SUPER 370DEI Quick Reference	1-18
SUPER 370DEI+ Quick Reference	1-19
General SECTION	1-20
Features of Motherboards	1-21
Server Works HE-SL Chipset: System Block Diagram	1-23
1-2 Chipset Overview	1-24
1-3 Special Features	1-24
ATI Graphics Controller	1-24
BIOS Recovery	1-24
Recovery from AC Power Loss	1-24
1-4 PC Health Monitoring	1-25
1-5 ACPI/PC 98 Features	1-26
1-6 Power Supply	1-28
1-7 Super I/O	1-28

Chapter 2: Installation

2-1 Static-Sensitive Devices	2-1
Precautions	2-1
Unpacking	2-1
2-2 FCPGA Processor Installation	2-2
2-3 Installing DIMMs	2-4

Table of Contents

2-4	Port/Control Panel Connector Locations	2-5
2-5	Connecting Cables	2-8
	Power Supply Connector	2-8
	Power LED	2-8
	Hard Drive LED	2-8
	PWR_ON	2-9
	NIC_LED	2-9
	Reset	2-9
	PC	2-9
	Chassis Intrusion	2-10
	Keyboard Lock	2-10
	Overheat LED	2-10
	Extra Universal Serial Bus Connection (USB3)	2-10
	Speaker	2-11
	Fan Headers	2-11
	Serial Ports	2-11
	ATX PS/2 Keyboard and Mouse Ports	2-11
	Universal Serial Bus Connector	2-12
	Extra Universal Serial Bus Connection (USB4)	2-12
	Wake-On-LAN	2-12
	Power Supply Fail Header	2-13
	SLED1 (SCSI LED) Indicator	2-13
2-6	DIP Switch Settings	2-14
	DIP Switch 1: Core/Bus Ratio	2-14
2-7	Jumper Settings	2-14
	CMOS Clear	2-15
	Front Side Bus Speed	2-15
	SCSI Termination Enable/Disable	2-16
	Speaker Enable/Disable	2-16
	Onboard LAN/NIC Enable/Disable	2-16
	Third Power Supply Failure Alarm Enable/Disable	2-17
2-8	Parallel Port, Floppy/Hard Disk Drive and SCSI Connections	2-17
	Parallel Port Connector	2-17
	Floppy Connector	2-18
	IDE Connectors	2-18
	Ultra160 SCSI Connector	2-19
	Installing Software Drivers	2-20

Chapter 3: Troubleshooting

3-1	Troubleshooting Procedures	3-1
	Before Power On	3-1
	No Power	3-1
	No Video	3-1
	Memory Errors	3-2
	Losing the System's Setup Configuration	3-2
3-2	Technical Support Procedures	3-2
3-3	Frequently Asked Questions	3-3
3-4	Returning Merchandise for Service	3-5

Chapter 4: BIOS

4-1	Introduction	4-1
4-2	BIOS Features	4-2
4-3	Running Setup	4-2
	Standard CMOS Setup	4-3
4-4	Advanced CMOS Setup	4-4
4-5	Chipset Setup	4-15
4-6	PCI/Plug and Play Setup	4-18
4-7	Power Setup	4-22
4-8	Boot Setup	4-25
4-9	Security Setup	4-27
4-10	Exit Setup	4-29

Appendices:

Appendix A:	BIOS Error Beep Codes	A-1
Appendix B:	AMIBIOS Post Checkpoint Codes	B-1

Notes

Chapter 1

Introduction

1-1 Overview

Checklist

Congratulations on purchasing your computer motherboard from an acknowledged leader in the industry. Supermicro boards are designed with the utmost attention to detail to provide you with the highest standards in quality and performance.

Please check that the following items have all been included with your motherboard. If anything listed here is damaged or missing, contact your retailer.

One (1) Supermicro Mainboard

One (1) ribbon cable for IDE devices

One (1) floppy ribbon cable for (a) 5.25-inch floppy and
(b) 3.5-inch floppy drives

One (1) I/O backpanel shield

SCSI Accessories (not with 370DEI/370DEI+):

One (1) 50-pin Ultra SCSI cable (370DE6 only)

One (1) 68-pin LVD SCSI cable

One (1) set of SCSI driver diskettes

One (1) SCSI manual

One (1) Supermicro CD or diskettes containing drivers and utilities

One (1) User's/BIOS Manual

CONTACTING SUPERMICRO

Headquarters

Address: Super Micro Computer, Inc.
980 Rock Avenue
San Jose, CA 95131 U.S.A.

Tel: +1 (408) 503-8000

Fax: +1 (408) 503-8008

E-mail: marketing@supermicro.com (General Information)
support@supermicro.com (Technical Support)

Web site: www.supermicro.com

European Office

Address: Super Micro Computer B.V.
Het Sterrenbeeld 28, 5215 ML,
's-Hertogenbosch, The Netherlands

Tel: +31 (0) 73-6400390

Fax: +31 (0) 73-6416525

E-mail: sales@supermicro.nl (General Information)
support@supermicro.nl (Technical Support)
rma@supermicro.nl (Customer Support)

Asia-Pacific

Address: 6th Floor, No. 755 Chung-cheng Road
Chung-Ho City, Taipei Hsien, Taiwan, R.O.C.

Tel: 886 (2) 8221-1690

Fax: 886 (2) 8221-2790

www: www.supermicro.com.tw

Email: support@supermicro.com.tw

Notes

SUPER 370DE6 SECTION

SUPER 370DE6

Figure 1-1. SUPER 370DE6 Image

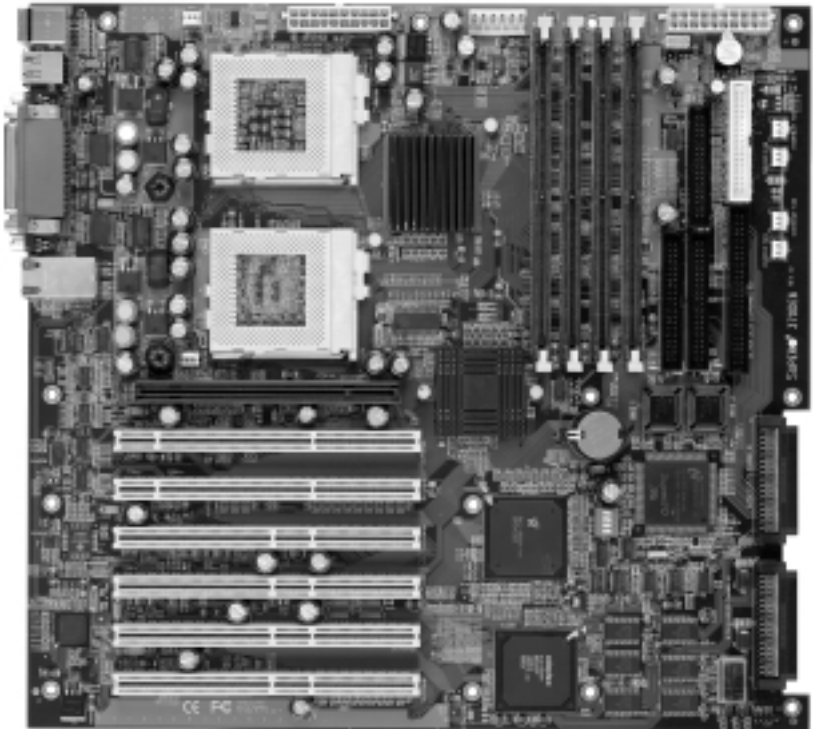
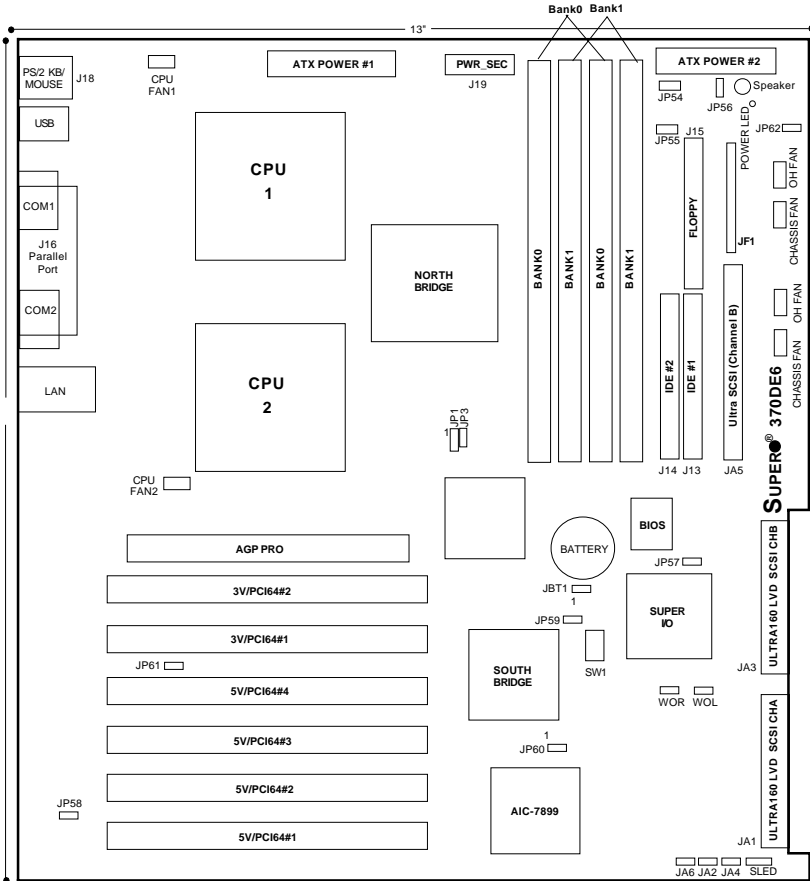

Figure 1-3. SUPER 370DE6 Layout
(not drawn to scale)



(*Notes: Memory modules should be installed in pairs only.)

Also see the figure on page 2-5 for the locations of the I/O ports and 2-7 for the Front Control Panel (JF1) connectors.

370DE6 Quick Reference

<u>Jumpers</u>	<u>Description</u>	<u>Default Setting</u>
JA2	LVD SCSI Ch A Term.	Open (Enabled)
JA4	LVD SCSI Ch B Term.	Open (Enabled)
JA6	50pin SCSI Ch B Term	Open (Enabled)
JBT1	CMOS Clear	Pin 1-2 (Normal)
JP1	FSB Speed Setting	Pin 1-2 (Auto)
JP3	Spread Spectrum Enable	Open (Disabled)
JP55	Third P/S Fail Enable/Disable	Off (Disabled)
JP56	Speaker Enable/Disable	On (Enabled)
JP57	BIOS Select	Pin 1-2 (BIOS1)
JP58	LAN/NIC Enable/Disable	Off (Enabled)
JP60	SCSI Enable/Disable	Pin 1-2 (Enabled)

<u>DIP Switch</u>	<u>Description</u>	<u>Default Setting</u>
SW1(1-4)	CPU Core/Bus Ratio	

<u>Connectors</u>	<u>Description</u>
ATX POWER #1	Primary ATX Power Connector
ATX POWER #2	Secondary ATX Power Connector BANK0-
BANK1	Memory (RAM) Slots
COM1/COM2	COM1/COM2 Serial Port Connector
CPU1/CPU2	CPU 1 and CPU2 Sockets
CPU/CH/OH FAN	CPU/Overheat/Chassis Fan Headers
J13, J14	IDE Hard Disk Drive Connectors
J15	Floppy Disk Drive Connector
J16	Parallel Printer Port
J18	PS/2 Keyboard/Mouse
LAN	Ethernet Port
JA1	Ultra160 LVD SCSI CH A Connector
JA3	Ultra160 LVD SCSI CH B Connector
JF1	Front Control Panel
JP54	Third Power Supply Fail Header
PWR_SEC	Secondary ATX Power Connector
SLED1	SCSI Active LED header
USB	Universal Serial Bus Ports
WOL	Wake-on-LAN Header
WOR	Wake-on-Ring Header

***Notes: Please refer to Chapter 2 for detailed information on jumper settings and pin definitions.**

SUPER 370DER SECTION

SUPER 370DER

Figure 1-2. SUPER 370DER Image

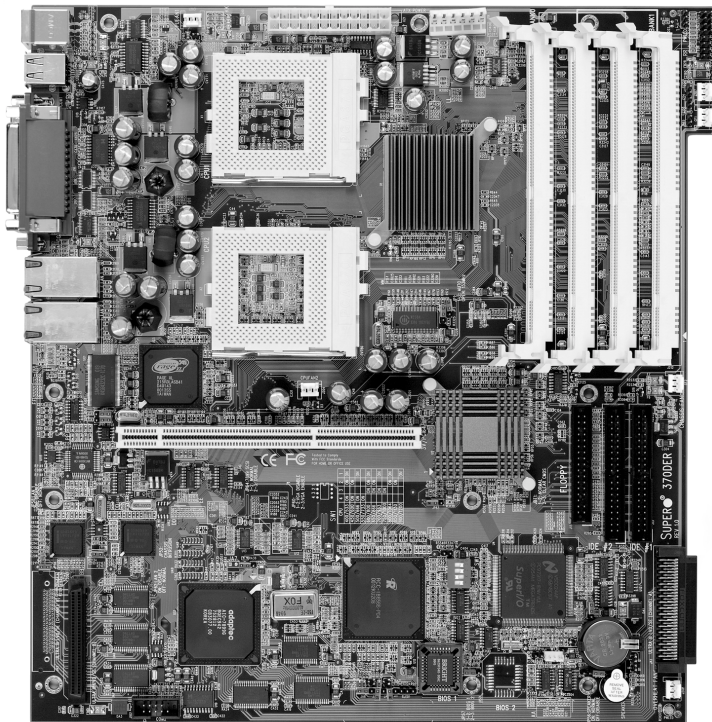
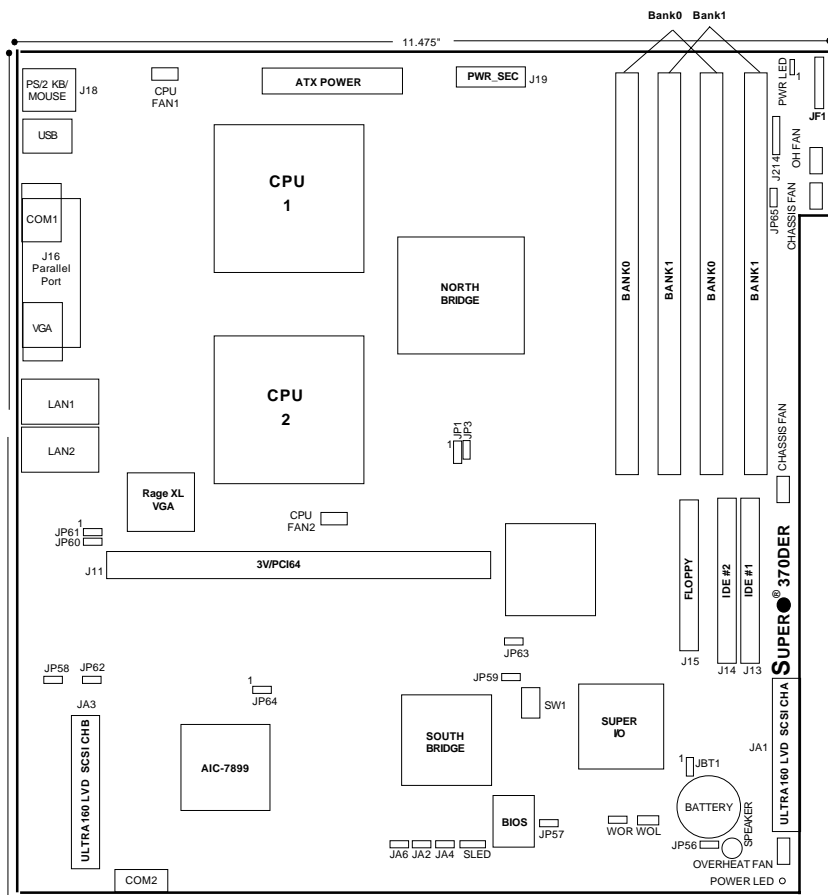

Figure 1-4. SUPER 370DER Layout
(not drawn to scale)



(*Notes: Memory modules should be installed in pairs only.)

Also see the figure on page 2-6 for the locations of the I/O ports and 2-7 for the Front Control Panel (JF1) connectors.

370DER Quick Reference

<u>Jumpers</u>	<u>Description</u>	<u>Default Setting</u>
JA2	LVD SCSI Ch A Term.	Open (Enabled)
JA4	LVD SCSI Ch B Term.	Open (Enabled)
JA6	Manufacturer's Setting	Always Closed
JBT1	CMOS Clear	Pin 1-2 (Normal)
JP1	FSB Speed Setting	Pin 1-2 (Auto)
JP3	Spread Spectrum Enable	Closed (Disabled)
JP56	Speaker Enable/Disable	On (Enabled)
JP57	BIOS Select	Pin 1-2 (BIOS1)
JP58	LAN1 Enable/Disable	Off (Enabled)
JP60	VGA Enable/Disable	Pin 2-3 (Enabled)
JP61	VGA Interrupt Enable	Pin 2-3 (Enabled)
JP62	LAN2 Enable/Disable	Off (Enabled)
*JP63(Notes)	Chipset Speed Setting	Off (133 MHz)
JP64	SCSI Enable/Disable	Pin 1-2 (Enabled)
(*Note 1: for 370DER V.1.00 only.)		
(*Note 2: If the FSB speed is 100MHz, JP63 should be set to "on".)		

<u>DIP Switches</u>	<u>Description</u>	<u>Default Setting</u>
SW1 (1-4)	CPU Core/Bus Ratio	
<u>Connectors</u>		
<u>Description</u>		
ATX POWER	Primary ATX Power Connector	
BANK0/BANK1	Memory (RAM) Slots	
COM1/COM2	COM1/2 Serial Port Conn/Header	
CPU/CH/OH FAN	CPU/Overheat/Chassis Fan Headers	
J13, J14	IDE Hard Disk Drive Connectors	
J15	Floppy Disk Drive Connector	
J16	Parallel Printer Port	
J18	PS/2 Keyboard/Mouse	
J214	USB0 Header	
JA1	Ultra160 Channel A LVD SCSI	
JA3	Ultra160 Channel B LVD SCSI	
JF1	Front Control Panel	
LAN1/LAN2	Ethernet Port 1 / Ethernet Port 2	
PWR_SEC	Secondary ATX Power Connector	
SLED1	SCSI Active LED header	
USB	Universal Serial Bus Ports	
VGA	Onboard VGA Monitor Connector	
WOL	Wake-on-LAN Header	
WOR	Wake-on-Ring Header	

***Notes: Please refer to Chapter 2 for detailed information on jumper settings and pin definitions.**

370DER+ Quick Reference

<u>Jumpers</u>	<u>Description</u>	<u>Default Setting</u>
JA2	LVD SCSI Ch A Term.	Open (Enabled)
JA4	LVD SCSI Ch B Term.	Open (Enabled)
JA6	Manufacturer's Setting	Always Closed
JBT1	CMOS Clear	Pin 1-2 (Normal)
JP1	FSB Speed Setting	Pin 1-2 (Auto)
JP3	Spread Spectrum Enable	Open (Disabled)
JP56	Speaker Enable/Disable	On (Enabled)
JP57	BIOS Select	Pin 1-2 (BIOS1)
JP58	LAN1 Enable/Disable	Off (Enabled)
JP60	VGA Enable/Disable	Pin 2-3 (Enabled)
JP61	VGA Interrupt Enable	Pin 2-3 (Enabled)
JP62	LAN2 Enable/Disable	Off (Enabled)
*JP63(Notes)	Chipset Speed Setting	Off (133 MHz)
JP64	SCSI Enable/Disable	Pin 1-2 (Enabled)

(*Note1 : 370DER+ V.1.00 only.)
 (*Note2 : If the FSB speed is 100MHz, JP63 should be set to "On".)

<u>DIP Switches</u>	<u>Description</u>	<u>Default Setting</u>
SW1(1-4)	CPU Core/Bus Ratio	

<u>Connectors</u>	<u>Description</u>
ATX POWER	Primary ATX Power Connector
BANK0/BANK1	Memory (RAM) Slots
COM1/COM2	COM1/2 Serial Port Conn/Header
CPU/CH/OH FAN	CPU/Overheat/Chassis Fan Headers
J13, J14	IDE Hard Disk Drive Connectors
J15	Floppy Disk Drive Connector
J18	PS/2 Keyboard/Mouse
J214	USB0 Header
JA1	Ultra160 Channel A LVD SCSI
JA5	External U160 Channel B LVD SCSI
JF1	Front Control Panel
LAN1/LAN2	Ethernet Port 1 / Ethernet Port 2
PWR_SEC	Secondary ATX Power Connector
SLED1	SCSI Active LED header
USB	Universal Serial Bus Ports
VGA	Onboard VGA Monitor Connector
WOL	Wake-on-LAN Header
WOR	Wake-on-Ring Header

***Notes: Please refer to Chapter 2 for detailed information on jumper settings and pin definitions.**

SUPER 370DEI SECTION

SUPER 370DEI

Figure 1-2. SUPER 370DEI Image

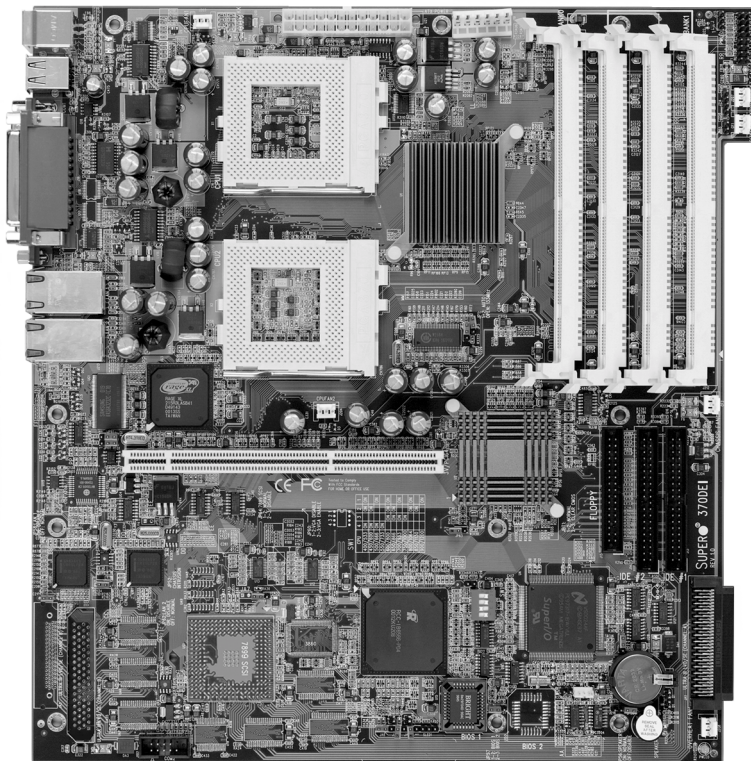
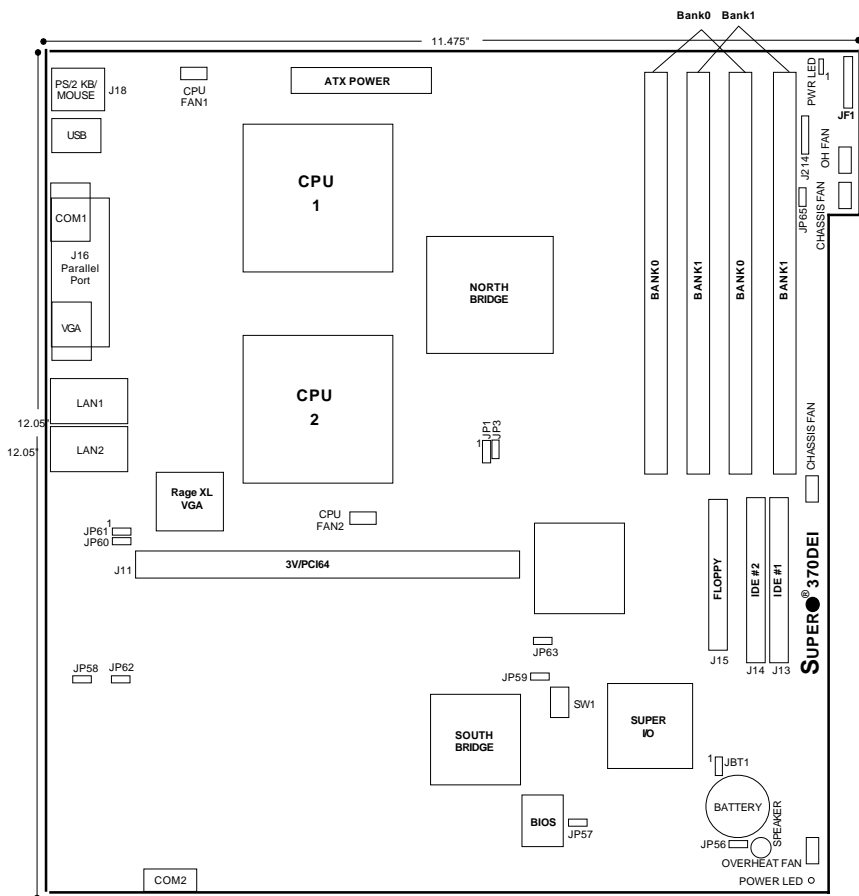

Figure 1-4. SUPER 370DEI Layout
(not drawn to scale)



(*Notes: Memory modules should be installed in pairs only.)

Also see the figure on page 2-6 for the locations of the I/O ports and 2-7 for the Front Control Panel (JF1) connectors.

Figure 1-4. SUPER 370DEI+ Layout
(not drawn to scale)

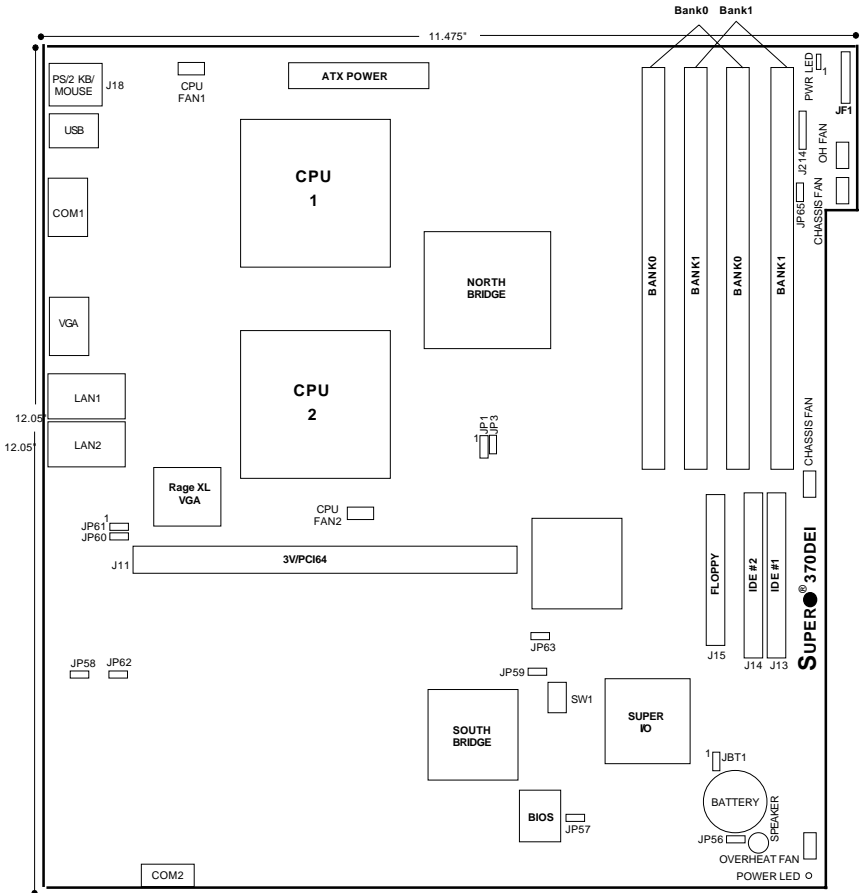

(*Notes: Memory modules should be installed in pairs only.)

Also see the figure on page 2-6 for the locations of the I/O ports and 2-7 for the Front Control Panel (JF1) connectors.

370DEI Quick Reference

<u>Jumpers</u>	<u>Description</u>	<u>Default Setting</u>
JBT1	CMOS Clear	Pin 1-2 (Normal)
JP1	FSB Speed Setting	Pin 1-2 (Auto)
JP3	Spread Spectrum Enable	Open (Disabled)
JP56	Speaker Enable/Disable	On (Enabled)
JP57	BIOS Select	Pin 1-2 (BIOS1)
JP58	LAN1 Enable/Disable	Off (Enabled)
JP60	VGA Enable/Disable	Pin 2-3 (Enabled)
JP61	VGA Interrupt Enable	Pin 2-3 (Enabled)
JP62	LAN2 Enable/Disable	Off (Enabled)
*JP63	Chipset Speed Setting	Off (133 MHz)

(*Note1 : If the FSB speed is 100MHz, JP63 should be set to "On".)

<u>DIP Switches</u>	<u>Description</u>	<u>Default Setting</u>
SW1 (1-4)	CPU Core/Bus Ratio	

<u>Connectors</u>	<u>Description</u>
ATX POWER	Primary ATX Power Connector
BANK0/BANK1	Memory (RAM) Slots
COM1/COM2	COM1/2 Serial Port Conn/Header
CPU/CH/OH FAN	CPU/Overheat/Chassis Fan Headers
J13, J14	IDE Hard Disk Drive Connectors
J15	Floppy Disk Drive Connector
J16	Parallel Printer Port
J18	PS/2 Keyboard/Mouse
J214	USB0 Header
JA1	Ultra160 Channel A LVD SCSI
JA5	External U160 Channel B LVD SCSI
JF1	Front Control Panel
LAN1/LAN2	Ethernet Port 1 / Ethernet Port 2
PWR_SEC	Secondary ATX Power Connector
USB	Universal Serial Bus Ports
VGA	Onboard VGA Monitor Connector
WOL	Wake on Lan
WOR	Wake on Ring

***Notes: Please refer to Chapter 2 for detailed information on jumper settings and pin definitions.**

370DEI+ Quick Reference

<u>Jumpers</u>	<u>Description</u>	<u>Default Setting</u>
JBT1	CMOS Clear	Pin 1-2 (Normal)
JP1	FSB Speed Setting	Pin 1-2 (Auto)
JP3	Spread Spectrum Enable	Open (Disabled)
JP56	Speaker Enable/Disable	On (Enabled)
JP57	BIOS Select	Pin 1-2 (BIOS1)
JP58	LAN1 Enable/Disable	Off (Enabled)
JP60	VGA Enable/Disable	Pin 2-3 (Enabled)
JP61	VGA Interrupt Enable	Pin 2-3 (Enabled)
JP62	LAN2 Enable/Disable	Off (Enabled)
*JP63	Chipset Speed Setting	Off (133 MHz)

(*Note1 : If the FSB speed is 100MHz, JP63 should be set to "On".)

<u>DIP Switches</u>	<u>Description</u>	<u>Default Setting</u>
SW1(1-4)	CPU Core/Bus Ratio	

<u>Connectors</u>	<u>Description</u>
ATX POWER	Primary ATX Power Connector
BANK0/BANK1	Memory (RAM) Slots
COM1/COM2	COM1/2 Serial Port Conn/Header
CPU/CH/OH FAN	CPU/Overheat/Chassis Fan Headers
J13, J14	IDE Hard Disk Drive Connectors
J15	Floppy Disk Drive Connector
J18	PS/2 Keyboard/Mouse
J214	USB0 Header
JA1	Ultra160 Channel A LVD SCSI
JA5	External U160 Channel B LVD SCSI
JF1	Front Control Panel
LAN1/LAN2	Ethernet Port 1 / Ethernet Port 2
PWR_SEC	Secondary ATX Power Connector
USB	Universal Serial Bus Ports
VGA	Onboard VGA Monitor Connector
WOL	Wake on Lan
WOR	Wake on Ring

***Notes: Please refer to Chapter 2 for detailed information on jumper settings and pin definitions.**

**GENERAL
SECTION**

Features of the 370DE6/370DER/370DER+/370DEI

CPU

- Single or dual Pentium III FCPGA 500 MHz-1.13 GHz processors at 133 or 100 MHz front side bus

Note: Please refer to the support section of our web site for a complete listing of supported processors. (<http://www.supermicro.com/TechSupport.htm>)

Memory

- Four 168-pin DIMM sockets supporting up to 4 GB registered ECC SDRAM

Note 1: The memory speed must match the front side bus speed being used. (Both 133 or 100 MHz.)

Note 2: The DIMM slots on the 370DER are set at a 25° angle to provide a low vertical profile.

Note 3: Memory Modules should be installed in pairs (first in the two slots of Bank0, then in both slots of Bank1, if needed).

Chipset

- ServerWorks ServerSet III HE Super Light (see page 1-13 for details)

Expansion Slots

370DE6:

- Two 64-bit, 66/33 MHz PCI slots
- Four 64-bit, 33 MHz PCI slots
- One 2x/AGP Pro slot

370DER/DER+/DEI:

- One 64-bit, 66/33 MHz PCI slot

BIOS

- 4 Mb AMI® Flash ROM
- APM 1.2, DMI 2.1, PCI 2.2, ACPI 1.0, Plug and Play (PnP)

PC Health Monitoring

- Seven onboard voltage monitors for CPU core, chipset voltage, +5V and +12V
- Fan status monitor with firmware/software on/off control
- Environmental temperature monitor and control
- CPU fan auto-off in sleep mode
- Power-up mode control for recovery from AC power loss
- System overheat LED and control
- System resource alert

ACPI/PC 98 Features

- Microsoft OnNow
- Slow blinking LED for suspend state indicator
- Main switch override mechanism
- External modem ring-on

Onboard I/O

- AIC-7899 for dual channel Ultra160 SCSI (370DE6/370DER/370DER+)
- Integrated ATI Rage XL Graphics Controller (370DER/370DER+/370DEI)
- Intel 82559 for integrated onboard Ethernet (370DER/370DER+/370DEI)
- 2 EIDE bus master interfaces support Ultra DMA/33
- 1 floppy port interface (up to 2.88 MB)
- 2 Fast UART 16550A compatible serial ports
- 1 EPP/ECP (Enhanced Parallel Port/Extended Capabilities Port)
(370DE6/370DER/370DEI)
- PS/2 mouse and PS/2 keyboard ports
- 2 USB (Universal Serial Bus) ports

Other

- Internal/external modem ring-on
- Recovery from AC power loss control
- Wake-on-LAN (WOL)

CD/Diskette Utilities

- BIOS flash upgrade utility
- Device Drivers

Dimensions

- SUPER 370DE6
Extended ATX: 12.05" x 13" (306 x 330 mm)
- SUPER 370DER/370DER+/370DEI
Full ATX: 12.05" x 11.475" (306 x 291 mm)

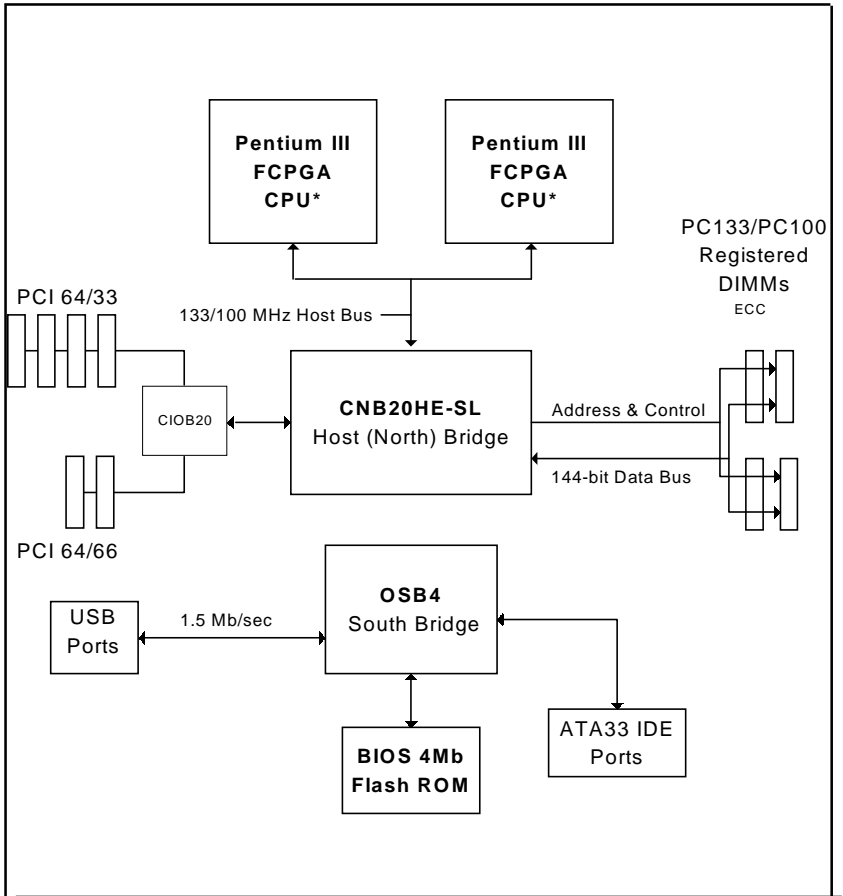

**Figure 1-5. ServerWorks HE-SL Chipset:
System Block Diagram**

***Note: This is a general block diagram. Please see the previous Motherboard Features Section for details on the PCI slots included on each motherboard.**

1-2 Chipset Overview

The ServerWorks ServerSet™ III HE SL is a high-performance core logic chipset that consists of a North Bridge and a South Bridge.

The North Bridge integrates the main memory subsystem and a dual channel PCI bus and bridges the processor bus to a 64-bit PCI bus. The memory subsystem consists of a two-way interleaved 4-DIMM configuration accessed over a 144-bit memory bus (most chipsets have a 72-bit memory bus), which provides a significant boost in performance. The North Bridge also packs and unpacks data for PCI accesses to reserve more processor bandwidth for multiprocessor motherboards.

The South Bridge provides various integrated functions, including the PCI to ISA bridge and support for UDMA33, security (passwords and system protection), Plug & Play, USBs, power management, interrupt controllers and the SMBus.

1-3 Special Features

ATI Graphics Controller (370DER/DER+/370DEI only)

The 370DER/370DER+/370DEI has an integrated ATI video controller based on the Rage XL graphics chip. The Rage XL fully supports sideband addressing and AGP texturing. This onboard graphics package can provide a bandwidth of up to 512 MB/sec over a 32-bit graphics memory bus.

BIOS Recovery

The BIOS Recovery function allows you to recover your BIOS image file if the BIOS flashing procedure fails (see Section 3-3).

Recovery from AC Power Loss

BIOS provides a setting for you to determine how the system will respond when AC power is lost and then restored to the system. You can choose for the system to remain powered off (in which case you must hit the power switch to turn it back on) or for it to automatically return to a power on state. See the Power Lost Control setting in the Advanced BIOS Setup section (Peripheral Device Configuration) to change this setting. The default setting is Always On.

1-4 PC Health Monitoring

This section describes the PC health monitoring features of the SUPER 370DE6/370DER/370DER+/370DEI. These motherboards have an onboard System Hardware Monitor chip that supports PC health monitoring.

Onboard Voltage Monitors for the CPU Core, Chipset Voltage, +5V and +12V

The onboard voltage monitor will scan these voltages continuously. The 370DE6 also monitors +3.3V. Once a voltage becomes unstable, a warning is given or an error message is sent to the screen. Users can adjust the voltage thresholds to define the sensitivity of the voltage monitor.

Fan Status Monitor with Firmware/Software On/Off Control

The PC health monitor can check the RPM status of the cooling fans. The onboard 3-pin CPU and chassis fans are controlled by the power management functions. The thermal fan is controlled by the overheat detection logic.

Environmental Temperature Control

The thermal control sensor monitors the CPU temperature in real time and will turn on the thermal control fan whenever the CPU temperature exceeds a user-defined threshold. The overheat circuitry runs independently from the CPU. It can continue to monitor for overheat conditions even when the CPU is in sleep mode. Once it detects that the CPU temperature is too high, it will automatically turn on the thermal control fan to prevent any overheat damage to the CPU. The onboard chassis thermal circuitry can monitor the overall system temperature and alert users when the chassis temperature is too high.

CPU Fan Auto-Off in Sleep Mode

The CPU fan activates when the power is turned on. It can be turned off when the CPU is in sleep mode. When in sleep mode, the CPU will not run at full power, thereby generating less heat.

CPU Overheat LED and Control

This feature is available when the user enables the CPU overheat warning function in the BIOS. This allows the user to define an overheat temperature. When this temperature is exceeded, both the overheat fan and the warning LED are triggered.

System Resource Alert

This feature is available when used with Intel's LANDesk Client Manager (optional). It is used to notify the user of certain system events. For example, if the system is running low on virtual memory and there is insufficient hard drive space for saving the data, you can be alerted of the potential problem.

Hardware BIOS Virus Protection

The system BIOS is protected by hardware that prevents viruses from infecting the BIOS area. The user can only change the BIOS content through the flash utility provided by SUPERMICRO. This feature can prevent viruses from infecting the BIOS area and destroying valuable data.

Auto-Switching Voltage Regulator for the CPU Core

The auto-switching voltage regulator for the CPU core can support up to 20A current and auto-sense voltage IDs ranging from 1.4V to 3.5V. This will allow the regulator to run cooler and thus make the system more stable.

1-5 ACPI/PC 98 Features

ACPI stands for Advanced Configuration and Power Interface. The ACPI specification defines a flexible and abstract hardware interface that provides a standard way to integrate power management features throughout a PC system, including its hardware, operating system and application software. This enables the system to automatically turn on and off peripherals such as CD-ROMs, network cards, hard disk drives and printers. This also includes consumer devices connected to the PC such as VCRs, TVs, telephones and stereos.

In addition to enabling operating system-directed power management, ACPI provides a generic system event mechanism for Plug and Play and an operating system-independent interface for configuration control. ACPI lever-

ages the Plug and Play BIOS data structures while providing a processor architecture-independent implementation that is compatible with both Windows 98 and Windows NT

5.0. **Note:** To utilize ACPI, you must reinstall Windows 98. To reinstall Windows 98 with ACPI, enter DOS and type "setup /p J" at the CDROM prompt (usually D:\) with the Windows 98 CD loaded. (Make sure you include the spaces after "setup" and "p".) Then hit <Enter>. You can check to see if ACPI has been properly installed by looking for it in the Device Manager, which is located in the Control Panel in Windows.

Microsoft OnNow

The OnNow design initiative is a comprehensive, system-wide approach to system and device power control. OnNow is a term for a PC that is always on but appears to be off and responds immediately to user or other requests.

Slow Blinking LED for Suspend-State Indicator

When the CPU goes into a suspend state, the chassis power LED will start blinking to indicate that the CPU is in suspend mode. When the user presses any key, the CPU will wake-up and the LED will automatically stop blinking and remain on.

Main Switch Override Mechanism

When an ATX power supply is used, the power button can function as a system suspend button to make the system enter a SoftOff state. The monitor will be suspended and the hard drive will spin down. Depressing the power button again will cause the whole system to wake-up. During the SoftOff state, the ATX power supply provides power to keep the required circuitry in the system alive. In case the system malfunctions and you want to turn off the power, just depress and hold the power button for 4 seconds. This option can be set in the Power section of the BIOS Setup routine.

External Modem Ring-On

Wake-up events can be triggered by a device such as the external modem ringing when the system is in the SoftOff state. Note that external modem ring-on can only be used with an ATX 2.01 (or above) compliant power supply.

Wake-On-LAN (WOL) (not on 370DEI)

Wake-On-LAN is defined as the ability of a management application to remotely power up a computer that is powered off. Remote PC setup, updates and asset tracking can occur after hours and on weekends so that daily LAN traffic is kept to a minimum and users are not interrupted. The motherboards have a 3-pin header (WOL) to connect to the 3-pin header on a Network Interface Card (NIC) that has WOL capability. Wake-On-LAN must be enabled in BIOS. Note that Wake-On-Lan can only be used with an ATX 2.01 (or above) compliant power supply.

1-6 Power Supply

As with all computer products, a stable power source is necessary for proper and reliable operation. It is even more important for processors that have CPU clock rates.

The SUPER 370DE6/370DER/370DER+/370DEI accommodates ATX power supplies. Although most power supplies generally meet the specifications required by the CPU, some are inadequate. You should use one that will supply at least 300W of power - an even higher wattage power supply is recommended for high-load configurations. Also your power supply must provide a +5V standby voltage that supplies at least 720 mA of current. But for the 370DE6, 1.5A is needed for LAN1 and LAN2.

It is strongly recommended that you use a high quality power supply that meets ATX power supply Specification 2.02 or above. Additionally, in areas where noisy power transmission is present, you may choose to install a line filter to shield the computer from noise. It is recommended that you also install a power surge protector to help avoid problems caused by power surges.

1-7 Super I/O

The disk drive adapter functions of the Super I/O chip include a floppy disk drive controller that is compatible with industry standard 82077/765, a data separator, write pre-compensation circuitry, decode logic, data rate selection, a clock generator, drive interface control logic and interrupt and DMA logic. The wide range of functions integrated onto the Super I/O greatly reduces the number of components required for interfacing with floppy disk drives. The Super I/O supports 360 K, 720 K, 1.2 M, 1.44 M or 2.88 M disk drives and data transfer rates of 250 Kb/s, 500 Kb/s or 1 Mb/s. It also

provides two high-speed, 16550 compatible serial communication ports (UARTs), one of which supports serial infrared communication. Each UART includes a 16-byte send/receive FIFO, a programmable baud rate generator, complete modem control capability and a processor interrupt system.

Each UART includes a 16-byte send/receive FIFO, a programmable baud rate generator, complete modem control capability and a processor interrupt system. Both UARTs provide legacy speed with baud rate of up to 115.2 Kbps as well as an advanced speed with baud rates of 250 K, 500 K, or 1 Mb/s, which support higher speed modems.

The Super I/O supports one PC-compatible printer port (SPP), Bi-directional Printer Port (BPP) , Enhanced Parallel Port (EPP) or Extended Capabilities Port (ECP).

The Super I/O provides functions that comply with ACPI (Advanced Configuration and Power Interface), which includes support of legacy and ACPI power management through an SMI or SCI function pin. It also features auto power management to reduce power consumption.

The IRQs, DMAs and I/O space resources of the Super I/O can flexibly adjust to meet ISA PnP requirements, which support ACPI and APM (Advanced Power Management).

Chapter 2

Installation

2-1 Static-Sensitive Devices

Electric-Static-Discharge (ESD) can damage electronic components. To prevent damage to your system board, it is important to handle it very carefully. The following measures are generally sufficient to protect your equipment from ESD.

Precautions

- Use a grounded wrist strap designed to prevent static discharge.
- Touch a grounded metal object before removing the board from the anti-static bag.
- Handle the board by its edges only; do not touch its components, peripheral chips, memory modules or gold contacts.
- When handling chips or modules, avoid touching their pins.
- Put the motherboard and peripherals back into their antistatic bags when not in use.
- For grounding purposes, make sure your computer chassis provides excellent conductivity between the power supply, the case, the mounting fasteners and the motherboard.

Unpacking

The motherboard is shipped in antistatic packaging to avoid static damage. When unpacking the board, make sure the person handling it is static protected.

2-2 FCPGA Processor Installation



When handling the FCPGA processor package, avoid placing direct pressure on the label area of the fan.

This section covers the installation procedure for FCPGA (Flip Chip Plastic Grid Array) type processors. You should install the processor first and then install the motherboard in the chassis. Following the installation procedures in the order they appear in this section should eliminate the most common problems encountered when installing a system.

IMPORTANT: Always connect the power cord last and always remove it before adding, removing or changing any hardware components.

Heat Sink

Follow the instructions that came with your processor or heat sink to attach a heat sink to the processor. Your heat sink should have a 3-pin fan, which connects to the CPU FAN header. Make sure that good contact is made between the CPU chip (the die) and the heat sink. Insufficient contact or improper types of heat sinks, thermal compound, and fans can cause the processor to overheat, which may crash the system. (You can check the CPU temperature readings in the "Peripheral Setup" Section of BIOS.)

Processor

Your motherboard has two 370-pin sockets, which support Intel FCPGA processors. Lift the lever on the FCPGA socket and insert the processor with the notched corner oriented toward pin one on the socket. Make sure the processor is fully seated in the socket and then close the lever. You can also install a single 370-pin FCPGA CPU on a dual-processor motherboard without changing any jumper settings. See Figure 2-1 for views of the 370-pin FCPGA socket before and after processor installation.

Mounting the Motherboard in the Chassis

All motherboards have standard mounting holes to fit different types of chassis. Make sure the location of all the mounting holes for both the motherboard and the chassis match. Although a chassis may have both plastic and metal mounting fasteners, metal ones are highly recommended because they ground the motherboard to the chassis. Make sure the metal standoffs click in or are

screwed in tightly. Then use a screwdriver to secure the motherboard onto the motherboard tray.

Figure 2-1. FCPGA Socket: Empty and with Processor Installed

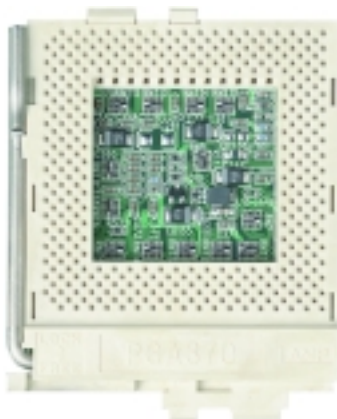

2-3 Installing DIMMs

NOTE: Check the Supermicro web site for recommended memory modules:

http://www.supermicro.com/TECHSUPPORT/FAQs/Memory_vendors.htm

CAUTION

Exercise extreme care when installing or removing DIMM modules to prevent any possible damage. Also note that the memory is interleaved to improve performance (see step 1).

DIMM Installation (See Figure 2-2)

1. Insert either two or four DIMMs as required for the desired system memory. Two-way interleaved memory requires that memory modules be installed in pairs(-first in the two slots of Bank0 and then in both slots of Bank1, if needed).
2. Insert each DIMM module vertically into its slot. Pay attention to the two notches along the bottom of the module to prevent inserting the DIMM module incorrectly.
3. Gently press down on the DIMM module until it snaps into place in the slot. Repeat for all modules (see step 1 above).

Support

The 370DE6/370DER/370DER+ only supports ECC registered SDRAM memory. PC133 and PC100 memory are both supported at their respective speeds. However, the memory bus is synchronized to the front side bus speed, so using PC100 with a 133 MHz FSB or using PC133 with a 100 MHz FSB, will result in 100 MHz memory speed operation in either case.

Figure 2-2. Side View of DIMM Installation into Slot

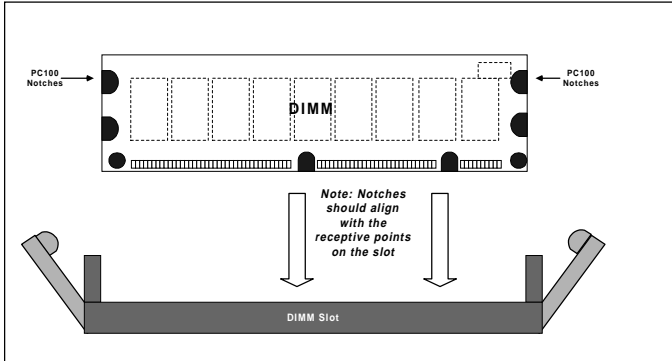

To Install: Insert module vertically and press down until it snaps into place. Pay attention to the notches.

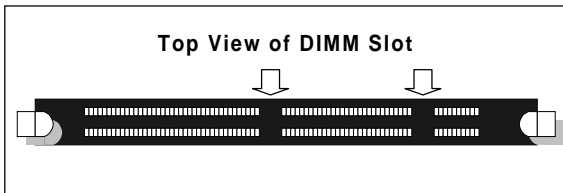

To Remove:

Use your thumbs to gently push near the edge of both ends of the module. This should release it from the slot.

2-4 Port/Control Panel Connector Locations

The I/O ports are color coded in conformance with the PC 99 specification. See Figure 2-3 below for the colors and locations of the various I/O ports.

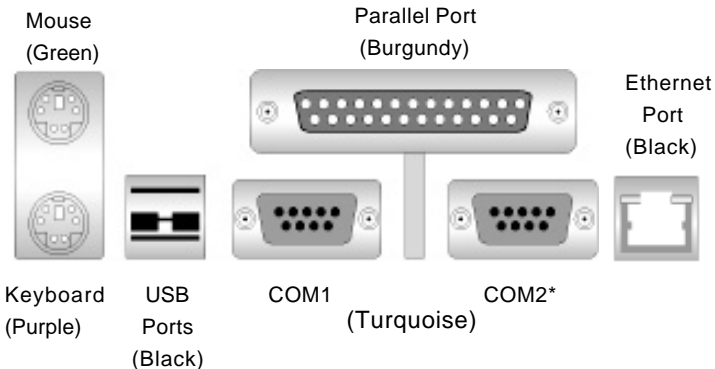
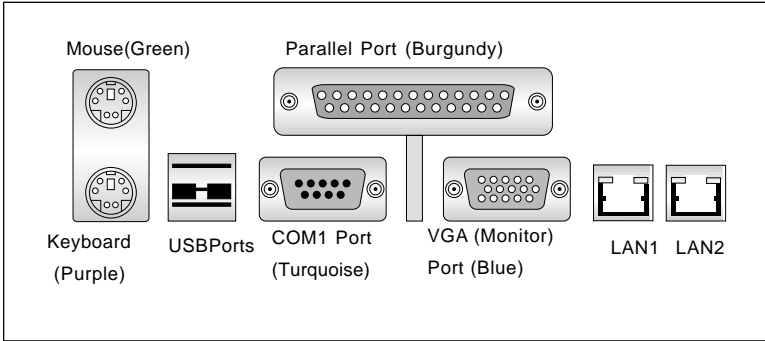

Figure 2-3a. I/O Port Locations and Definitions (370DE6)



***Note:** On the 370DER,r, 370DER+ and 370DEI, the COM2 connector as shown in Figure 2-3 is replaced by a VGA connector. The COM2 connection is made with a header located near the Ultra160 SCSI channel B header (JA3) on the motherboard.

***Note:** On the 370DER+ and the 370DEI+, the Parallel Port (burgundy), as shown in the above figure, is NOT installed in order to fit in a 1-U chassis.

**Figure 2-3b. I/O Port Locations and Definitions
370DER/370DER+/370DEI/370DEI+**

Front Control Panel

JF1 contains header pins for various front control panel connectors. See Figure 2-4 for the pin locations of the various front control panel buttons and LED indicators. Please note that even and odd numbered pins are on opposite sides. The 370DER/DER+ has a different JF1 configuration - pin definitions for JF1 on the 370DER are provided below. Refer to pages 2-8 to 2-13 for descriptions and 370DE6 pin definitions.

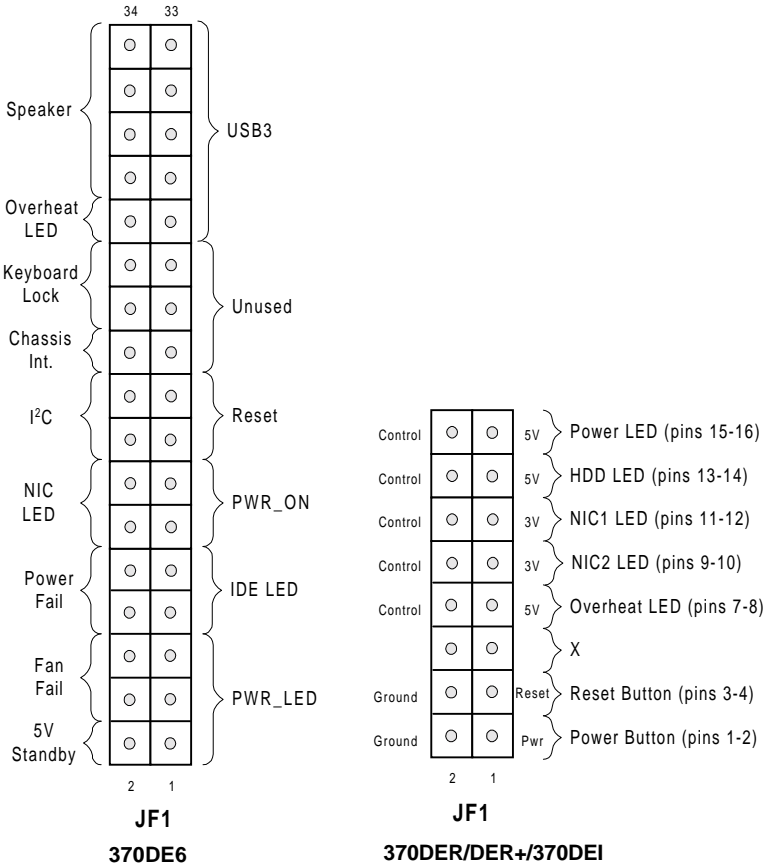

Figure 2-4. JF1 Connections

2-5 Connecting Cables

Power Supply Connector

(*370DE6: 20-pin connector)

After you have mounted the motherboard, added memory, and PCI cards, you are ready to connect the cables. For the 370DE6, attach an ATX power supply cable to either ATX #1 or ATX#2. PWR_SEC is used only when you have dual CPUs. Please refer to Table 2-1 for pin definitions.

(*360DER/DER+/370DEI: 24-pin connector)

The power supply connector on the 370DER/DER+/370DEI meets the SSI (Superset ATX) 24-pin specification; however, it also supports a 20-pin PS connector. Make sure that the orientation of the PS connector is correct. Please refer to Table 2-2 for pin definitions.

Power LED

The Power LED connection is located on JF1. See Table 2-3 for pin definitions (370DE6).

Hard Drive LED

The Hard Drive LED connection is located on JF1. Attach the IDE hard drive LED cable to the correct pins to display disk activity. See Table 2-4 for pin definitions (370DE6).

Table 2-1
ATX Power Supply Connector Pin Definitions
(For 370DE6 only)

Pin Number	Definition	Pin Number	Definition
1	3.3V	11	3.3V
2	3.3V3	12	-12V
3	Ground	13	Ground
4	5V	14	PS-ON
5	Ground	15	Ground
6	5V	16	Ground
7	Ground	17	Ground
8	PW-OK	18	-5V
9	5VSB	19	5V
10	12V	20	5V

Table 2-2
ATX Power Supply 24-pin Connector
Pin Definitions: (For 370DER/DER+)

Pin Number	Definition	Pin Number	Definition
13	+3.3V	1	+3.3V
14	-12V	2	+3.3V
15	COM	3	COM
16	PS_ON#	4	+5V
17	COM	5	COM
18	COM	6	+5V
19	COM	7	COM
20	Res(NC)	8	PWR_OK
21	+5V	9	5VSB
22	+5V	10	+12V
23	+5V	11	+12V
24	COM	12	+3.3V

Table 2-3
PWR_LED Pin
Definitions (JF1)

Pin Number	Definition
1	+5V
3	Key
5	GND

Table 2-4
IDE_LED Pin
Definitions
(JF1)

Pin Number	Definition
7	+5V
9	HD Active

PWR_ON

The PWR_ON connection is located on JF1. Momentarily contacting both pins will power on/off the system. The user can also configure this button to function as a suspend button. (See the Power Button Mode setting in BIOS.) To turn off the power when set to suspend mode, hold down the power button for at least 4 seconds. See Table 2-5 for pin definitions (370DE6).

Table 2-5
PWR_ON Connector
Pin Definitions
(JF1)

Pin Number	Definition
11	PW_ON
13	Ground

NIC_LED

The Network Interface Controller LED connection is located on JF1. Attach the NIC LED cable to these pins to display network activity. See Table 2-6 for pin definitions (370DE6). **Note:** the 370DER has two LAN ports and has connections for two NIC LEDs on JF1.

Table 2-6
NIC_LED Pin
Definitions
(JF1)

Pin Number	Definition
12	+5V
14	GND

Reset

The Reset connection is located on JF1. This connector attaches to the hardware reset switch on the computer case. See Table 2-7 for pin definitions (370DE6).

Table 2-7
Reset Pin
Definitions
(JF1)

Pin Number	Definition
15	Reset
17	Ground

I²C (370DE6 only)

The I²C connection is located on pins 16 and 18 of JF1. See Table 2-8 for pin definitions.

Table 2-8
I²C Pin Definitions
(JF1)

Pin Number	Definition
16	SDA
18	SCL

Chassis Intrusion

A Chassis Intrusion connection is located on pin 20 of JF1 for the 370DE6 and onpin 20 of JF1&JP52 for the 370DER/DER+/370DEI. See Table 2-9 for pin definitions. **Note:** An extra chassis intrusion header is provided at JL1.

Table 2-9
Pin Definitions (JF1)

Pin Number	Definition
20	Intrusion Input

Chassis Intrusion (IT)--370DE6

Pin Definitions (JF1) Pin Definitions (JP52)

Pin Number	Definition	Pin Number	Definition
20	Intrusion Input	1	Signal
		2	Ground

Chassis Intrusion (IT)--370DER/DER+

Keyboard Lock (370DE6 only)

The Keyboard Lock connection is located on pins 22 and 24 of JF1. See Table 2-10 for pin definitions. Pins 5 through 7 are for the power LED. Pins 8 and 9 are for the keylock.

Table 2-10
Keyboard Lock
(KL) Pin Definitions
(JF1)

Pin Number	Definition
22	+5V
24	GND

Overheat LED (OH)

Connect an LED to the OH connection on JF1 to provide advanced warning of chassis overheating. Refer to Table 2-11 for pin definitions (370DE6).

Table 2-11
Overheat LED (OH)
Pin Definitions (JF1)

Pin #	Definition
26	OH Active
25	PWR: Individual Connector only

Extra Universal Serial Bus Connection (USB3) (370DE6 only)

An additional connection for USB3 is included on pins 25, 27, 29 and 31 of JF1 for front side USB access. You will need a USB cable (not included) to use this connection.

Note: The USB4 (J105) connector is described on page 2-11.

Table 2-12
USB3 Pin
Definitions (JF1)

Pin Number	Definition
1	+5V
2	Key
3	IRRX
4	Ground

Speaker (370DE6 only)

The speaker connection is located on pins 28, 30, 32 and 34 of JF1. See Table 2-13 for pin definitions.

Table 2-13
Speaker Connector Pin
Definitions (JF1)

Pin Number	Function	Definition
28	+	Red wire, Speaker data
30	Key	No connection
32		Key
34		Speaker data

Fan Headers*

Fan headers on the motherboard include those for each CPU, chassis fans and overheat fans, designated CPU, CHASSIS and OH FAN, respectively. Refer to Table 2-14 for pin definitions.

Table 2-14
Fan Header Pin Definitions
(CPU/CHASSIS/OH Fans)

Pin Number	Definition
1	Ground (black)
2	+12V (red)
3	Tachometer

* Caution: These fan headers are DC power.

Serial Ports

On the 370DE6, the COM1 and COM2 serial ports are located under the parallel port (see Figure 2-3). See Table 2-15 for pin definitions. On the 370DER/DER+/370DEI, the COM2 connector is a header located near the Ultra160 SCSI channel B header (JA3) on the motherboard.

Table 2-15
Serial Port Pin Definitions
(COM1, COM2)

Pin Number	Definition	Pin Number	Definition
1	DCD	6	CTS
2	DSR	7	DTR
3	Serial In	8	RI
4	RTS	9	Ground
5	Serial Out	10	NC

ATX PS/2 Keyboard and PS/2 Mouse Ports

The ATX PS/2 keyboard and the PS/2 mouse are located on J18. See Table 2-16 for pin definitions. (The mouse port is above the keyboard port. See Figure 2-5.)

Table 2-16
PS/2 Keyboard
and Mouse Port
Pin Definitions
(J18)

Pin Number	Definition
1	Data
2	NC
3	Ground
4	VCC
5	Clock
6	NC

Universal Serial Bus (USB)

Two Universal Serial Bus ports are located beside the keyboard/mouse ports. USB0 is the bottom connector and USB1 is the top connector. See Table 2-17 for pin definitions.

Table 2-17
Universal Serial Bus Pin Definitions

USB0		USB1	
Pin Number	Definition	Pin Number	Definition
1	+5V	1	+5V
2	P0-	2	P0-
3	P0+	3	P0+
4	Ground	4	Ground
5	N/A	5	Key

Wake-On-LAN

The Wake-On-LAN header is designated as WOL. Refer to Table 2-18 for pin definitions. You must enable the LAN Wake-Up setting in BIOS to use this feature. You must also have a LAN card with a Wake-on-LAN connector and cable.

Table 2-18
Wake-On-LAN Pin Definitions (WOL)

Pin Number	Definition
1	+5V Standby
2	Ground
3	Wake-up

Power Supply Fail Header (370DE6 only)

Connect a cable from your power supply to the header labelled JP54 to provide warning of power supply failure. This warning signal is passed through the PWR_LED pin on JF1 to provide indication of a power failure on the chassis. This feature is only available when using Supermicro power supplies. See Table 2-20 for pin definitions.

Table 2-20
Power Supply Fail Header Pin Definitions
(JP54)

Pin Number	Definition
1	P/S 1 Fail Signal
2	P/S 2 Fail Signal
3	P/S 3 Fail Signal
4	Reset (from MB)

SLED1 (SCSI LED) Indicator

The SLED connector is used to provide an LED indication of SCSI activity. Refer to Table 2-21 for connecting the SCSI LED.

Table 2-21
SLED1 Pin Definitions

Pin Number	Definition
1	Positive
2	Negative
3	Negative
4	Positive

Note: SCSI is NOT supported on the 370DEI.

2-6 DIP Switch Settings

DIP Switch 1: Core/Bus Ratio

A red "DIP" switch labeled SW1 is located on the 370DE6/370DER/370DER+/370DEI. SW1 has four individual switches, which are used to set the core/bus ratio.

The example on the right will show you which CPU Core/Bus Ratio to use. The general rule is to divide the CPU speed by the bus speed. If you have a 550 MHz CPU, dividing it by a 100 Mhz front side bus will give you a CPU Core/BUS Ratio of 5.5. After determining the CPU Core/Bus Ratio, refer to Table 2-22 for the correct settings of DIP Switch 1.

Note: Most Intel processors have a fixed Core/Bus ratio that will overwrite the setting of DIP Switch 1.

Table 2-22
CPU Core/Bus Ratio Selection
(DIP Switch1)

CPU	SW1	SW1	SW1	SW1
	#4	#3	#2	#1
400-533	ON	OFF	ON	ON
450-600	ON	OFF	ON	OFF
500-666	ON	OFF	OFF	ON
550-733	ON	OFF	OFF	OFF
600-800	OFF	ON	ON	ON
650-866	OFF	ON	ON	OFF
700-933	OFF	ON	OFF	ON
750-1000	OFF	ON	OFF	OFF
800-1064	OFF	OFF	ON	ON
850-1130	OFF	OFF	ON	OFF
900-1200	OFF	OFF	OFF	ON

$$550 \text{ (MHz)} / 100 \text{ (MHz)} = 5.5$$

$$\text{CPU Speed} / \text{Bus Freq.} = \text{Ratio}$$

2-7 Jumper Settings

Explanation of Jumpers

To modify the operation of the motherboard, jumpers can be used to choose between optional settings. Jumpers create shorts between two pins to change the function of the connector. Pin 1 is identified with a square solder pad on the printed circuit board. See the motherboard layout pages for jumper locations. Note: On two pin jumpers, "closed" means the jumper is on and "open" means the jumper is off the pins.

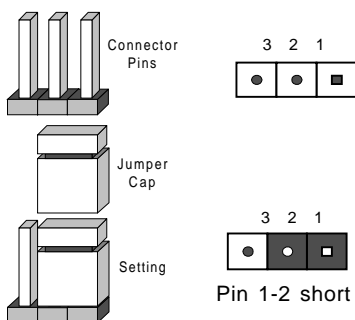

CMOS Clear

Refer to Table 2-23 for the jumper settings to clear CMOS. Always remove the AC power cord from the system before clearing CMOS.

NOTE: For an ATX power supply, you must completely shut down the system, remove the AC power cord and *then* use JBT1 to clear CMOS. Replace JBT1 back to the pin 1-2 position before powering up the system again. Do not use the PW_ON connector to clear CMOS.

Jumper Position	Definition
1-2	Normal
2-3	CMOS Clear

Front Side Bus Speed

CPU speed = FSB x Core/Bus ratio

The jumper settings for FSB Speed are JP1 for the 370DE6 (Rev. 1.00 & 1.1--Table 2-24a), and JP1&JP63 for the 370DER/370DER+/370DEI (Rev. 1.00 & 1.1--Table 2-24b).

Core/Bus Ratio settings are described in Section 2-7.

370DE6(Rev. 1.00/1.1)

Table 2-24a
Jumper Settings (JP1)

Jumper Position	Definition
1-2	Auto
2-3	100 MHz
OFF	133 MHz

* Note: The Auto setting allows the CPU to set the speed.

370DER/370DER+(Rev.1.00/1.1)

Table 2-24b
Jumper Settings(JP1 & JP 63)

JP1	JP63	Definition	Definition
1-2	Auto	OFF	
2-3	100 MHz	ON	
OFF	133 MHz	OFF	

*See Notes below:

*Notes:

1. The auto setting allows the CPU to set the speed.
2. If the FSB speed is 100MHz, JP63 should be set to "On".

SCSI Termination Enable/Disable

370DE6: Jumper JP60.

370DER/DER+: Jumper JP64.

370DEI: NOT APPLICABLE

The SCSI Termination jumper allow you to enable or disable termination for the SCSI connectors. The normal (default) position is open to enable SCSI termination. See Table 2-25 for jumper settings.

Table 2-25
SCSI Termination Enable/Disable Jumper Settings (JP60, JP64)

Jumper Position	Definition
Open	Enabled
Closed	Disabled

Speaker Enable/Disable

You may want to disable the onboard speaker. Jumper JP56 gives you this option. See Table 2-26 for jumper settings.

Table 2-26
Speaker Enable/Disable Jumper Settings (JP56)

Jumper Position	Definition
Open	Disabled
Closed	Enabled

Onboard LAN/NIC Enable/Disable

370DE6: Jumper JP58.

370DER/DER+: Jumpers:JP58&JP62

Change the setting of jumper JP58 to enable or disable the onboard LAN or NIC (Network Interface Card) on your motherboard. See Table 2-27 for jumper settings.

Table 2-27a
Onboard LAN/NIC Enable/Disable Jumper Settings (JP58)

Jumper Position	Definition
Open	Enabled
Closed	Disabled

370DE6

Table 2-27b
Onboard LAN1/LAN2 Enable/Disable Jumper Settings (JP58 & JP62)

Jumper Position	Definition
JP58	LAN1
JP62	LAN2

370DER/370DER+

Third Power Supply Failure Alarm Enable/Disable (370DE6 only) (*For Supermicro's Hot-Swap Triple Redundant Power Supplies only)

The system will notify you in the event of a power supply failure. This feature assumes that three power supply units are installed in the chassis, with one acting as a backup. If you only have one or two power supply units installed, you should disable this with JP55 to prevent false alarms. See Table 2-28 for jumper settings.

**Table 2-28
Power Supply Failure Alarm Enable/Disable Jumper Settings (JP55)**

Jumper Position	Definition
Open	Disabled
Closed	Enabled

2-8 Parallel Port, Floppy/Hard Disk Drive and SCSI Connections

Note the following when connecting the floppy and hard disk drive cables:

- The floppy disk drive cable has seven twisted wires.
- A red mark on a wire typically designates the location of pin 1.
- A single floppy disk drive ribbon cable has 34 wires and two connectors to provide for two floppy disk drives. The connector with twisted wires always connects to drive A, and the connector that does not have twisted wires always connects to drive B.

**Table 2-29
Parallel (Printer) Port Pin Definitions (J16)**

Pin Number	Function	Pin Number	Function
1	Strobe-	2	Auto Feed-
3	Data Bit 0	4	Error-
5	Data Bit 1	6	Init-
7	Data Bit 2	8	SLCT IN-
9	Data Bit 3	10	GND
11	Data Bit 4	12	GND
13	Data Bit 5	14	GND
15	Data Bit 6	16	GND
17	Data Bit 7	18	GND
19	ACK	20	GND
21	BUSY	22	GND
23	PE	24	GND
25	SLCT	26	NC

Parallel Port Connector (370DE6/370DER only)

The parallel port is located on J16. See Table 2-29 for pin definitions.

Floppy Connector

The floppy connector is located on J15. See Table 2-30 for pin definitions.

Table 2-30
Floppy Connector Pin Definitions (JP15)

Pin Number	Function	Pin Number	Function
1	GND	2	FDHDIN
3	GND	4	Reserved
5	Key	6	FDEDIN
7	GND	8	Index-
9	GND	10	Motor Enable
11	GND	12	Drive Select B-
13	GND	14	Drive Select A-
15	GND	16	Motor Enable
17	GND	18	DIR-
19	GND	20	STEP-
21	GND	22	Write Data-
23	GND	24	Write Gate-
25	GND	26	Track 00-
27	GND	28	Write Protect-
29	GND	30	Read Data-
31	GND	32	Side 1 Select-
33	GND	34	Diskette

IDE Connectors

There are no jumpers to configure the onboard IDE connectors J13 and J14. Refer to Table 2-31 for pin definitions.

Table 2-31
IDE Connector Pin Definitions
(J13, J14)

Pin Number	Function	Pin Number	Function
1	Reset IDE	2	GND
3	Host Data 7	4	Host Data 8
5	Host Data 6	6	Host Data 9
7	Host Data 5	8	Host Data 10
9	Host Data 4	10	Host Data 11
11	Host Data 3	12	Host Data 12
13	Host Data 2	14	Host Data 13
15	Host Data 1	16	Host Data 14
17	Host Data 0	18	Host Data 15
19	GND	20	Key
21	DRQ3	22	GND
23	I/O Write-	24	GND
25	I/O Read-	26	GND
27	IOCHRDY	28	BALE
29	DACK3-	30	GND
31	IRQ14	32	IOCS16-
33	Addr 1	34	GND
35	Addr 0	36	Addr 2
37	Chip Select 0	38	Chip Select 1-
39	Activity	40	GND

Ultra160 SCSI Connector (not on 370DEI)

Refer to Table 2-32 for pin definitions for the Ultra160 SCSI connectors located at JA1, JA3 and JA5. JA5 is a connector for external SCSI drives and is included only on the 370DER+.

Table 2-32
68-pin Ultra160 SCSI Connectors (JA1, JA3, JA5)

Connector Contact Number	Signal Names	Connector Contact Number	Signal Names
1	+DB(12)	35	-DB(12)
2	+DB(13)	36	-DB(13)
3	+DB(14)	37	-DB(14)
4	+DB(15)	38	-DB(15)
5	+DB(P1)	39	-DB(P1)
6	+DB(0)	40	-DB(0)
7	+DB(1)	41	-DB(1)
8	+DB(2)	42	-DB(2)
9	+DB(3)	43	-DB(3)
10	+DB(4)	44	-DB(4)
11	+DB(5)	45	-DB(5)
12	+DB(6)	46	-DB(6)
13	+DB(7)	47	-DB(7)
14	+DB(P)	48	-DB(P)
15	GROUND	49	GROUND
16	DIFFSENS	50	GROUND
17	TERMPWR	51	TERMPWR
18	TERMPWR	52	TERMPWR
19	RESERVED	53	RESERVED
20	GROUND	54	GROUND
21	+ATN	55	-ATN
22	GROUND	56	GROUND
23	+BSY	57	-BSY
24	+ACK	58	-ACK
25	+RST	59	-RST
26	+MSG	60	-MSG
27	+SEL	61	-SEL
28	+C/D	62	-C/D
29	+REQ	63	-REQ
30	+I/O	64	-I/O
31	+DB(8)	65	-DB(8)
32	+DB(9)	66	-DB(9)
33	+DB(10)	67	-DB(10)
34	+DB(11)	68	-DB(11)

2-9 Installing Software Drivers

After all the hardware has been installed you must install the software drivers. The necessary drivers are all included on the Supermicro CD that came packaged with your motherboard. After inserting this CD into your CDROM drive, the display shown in Figure 2-5 should appear. (If this display does not appear, click on the My Computer icon and then on the icon representing your CDROM drive. Finally, double click on the S "Setup" icon.)

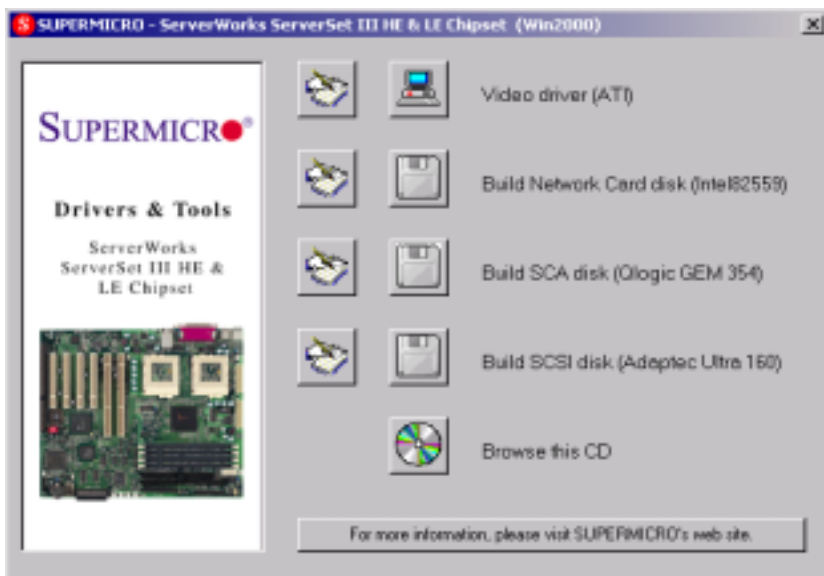

Figure 2-5. Driver/Tool Installation Display Screen

Click the icons showing a hand writing on paper to view the readme files for each item. The bottom icon with a CD on it allows you to view the entire contents of the CD.

Video driver (ATI): For the 370DL6 only.

Build Network Card disk: For the S2DL3/370DL6/370DL3/370DLE.

Build SCA disk (QLogic GEM 354): For integration with the SuperServer SC850 and SC860 chassis.

Build SCSI disk (Ultra160): For the S2DL3/370DL6/370DL3 only.

Chapter 3

Troubleshooting

3-1 Troubleshooting Procedures

Use the following procedures to troubleshoot your system. If you have followed all of the procedures below and still need assistance, refer to the 'Technical Support Procedures' and/or 'Returning Merchandise for Service' section(s) in this chapter.

Note: Always disconnect the power cord before adding, changing or installing any hardware components.

Before Power On

1. Make sure no short circuits exist between the motherboard and chassis.
2. Disconnect all ribbon/wire cables from the motherboard, including those for the keyboard and mouse.
3. Remove all add-on cards.
4. Install one CPU (making sure it is fully seated) and connect the chassis speaker and the power LED to the motherboard. (Check all jumper settings as well.)

No Power

1. Make sure no short circuits exist between the motherboard and the chassis.
2. Verify that all jumpers are set to their default positions.
3. Check that the 115V/230V switch on the power supply is properly set.
4. Turn the power switch on and off to test the system.
5. The battery on your motherboard may be old. Check to verify that it still supplies ~3VDC. If it does not, replace it with a new one.

No Video

1. If the power is on but you have no video, remove all the add-on cards and cables.
2. Use the speaker to determine if any beep codes exist. Refer to Appendix A for details on beep codes.

NOTE

If you are a system integrator, VAR or OEM, a POST diagnostics card is recommended. For I/O port 80h codes, refer to App. B.

Memory Errors

1. Make sure the DIMM modules are properly and fully installed in pairs.
2. Determine if different speeds of DIMMs have been installed and verify that the BIOS setup is configured for the fastest speed of RAM used. It is recommended to use the same RAM speed for all DIMMs in the system.
3. Make sure you are using PC133 or PC100 compliant, registered ECC, SDRAM. EDO SDRAM is not supported.
4. Check for bad DIMM modules or slots by swapping a single module between two slots and noting the results.
5. Make sure all memory modules are fully seated in their slots.
6. Check the power supply voltage 115V/230V switch.

Losing the System's Setup Configuration

1. Check the setting of jumper JBT1. Ensure that you are using a high quality power supply. A poor quality power supply may cause the system to lose the CMOS setup information. Refer to page 1-19 for details on recommended power supplies.
2. The battery on your motherboard may be old. Check to verify that it still supplies ~3VDC. If it does not, replace it with a new one.
3. If the above steps do not fix the Setup Configuration problem, contact your vendor for repairs.

3-2 Technical Support Procedures

Before contacting Technical Support, please take the following steps. Also, note that as a motherboard manufacturer, Super Micro does not sell directly to end-users, so it is best to first check with your distributor or reseller for troubleshooting services. They should know of any possible problem(s) with the specific system configuration that was sold to you.

1. Please go through the 'Troubleshooting Procedures' and 'Frequently Asked Question' (FAQ) sections in this chapter or see the FAQs on our

- web site (<http://www.supermicro.com/techsupport.htm>) before contacting Technical Support.
2. BIOS upgrades can be downloaded from our web site at <http://www.supermicro.com/techsupport/download.htm>.

Note: Not all BIOS can be flashed depending on the modifications to the boot block code.

3. If you still cannot resolve the problem, include the following information when contacting Super Micro for technical support:
 - Motherboard model and PCB revision number
 - BIOS release date/version
(this can be seen on the initial display when your system first boots up)
 - System configurationAn example of a Technical Support form is on our web site at http://www.supermicro.com/techsupport/contact_support.htm.
4. Distributors: For immediate assistance, please have your account number ready when placing a call to our technical support department. We can be reached by e-mail at support@supermicro.com or by fax at: (408) 503-8000, option 2.

3-3 Frequently Asked Questions

Question: What are the various types of memory that the 370DE6/370DER motherboard can support?

Answer: The370DE6/370DER/370DEI has four DIMM slots that support 168-pin, registered ECC DIMMs ECC only. Unbuffered SDRAM or non-ECC memory is not supported. PC133 and PC100 memory are both fully supported at their respective speeds. **Important: The memory employs a two-way interleaving scheme, which requires you to install memory modules in pairs (-first in the two slots of Bank0, and then, in both slots of Bank1, if needed.)**

Question: How do I update my BIOS?

Answer: It is recommended that you **do not** upgrade your BIOS if you are experiencing no problems with your system. Updated BIOS files are located on our web site at <http://www.supermicro.com>. Please check our BIOS warning message and the info on how to update your BIOS on our web site. Also, check the current BIOS revision and make sure it is newer than

your BIOS before downloading. Select your motherboard model and download the BIOS file to your computer. Unzip the BIOS update file and you will find the readme.txt (flash instructions), the fwhflash.com (BIOS flash utility) and the BIOS image (xxxxxx.rom) files. Copy these files onto a bootable floppy and reboot your system. It is not necessary to set BIOS boot block protection jumpers on the motherboard. At the DOS prompt, enter the command "fwhflash." This will start the flash utility and give you an opportunity to save your current BIOS image. Flash the boot block and enter the name of the update BIOS image file.

Note: It is important to save your current BIOS and **rename it "super.rom"** in case you need to recover from a failed BIOS update. Select flash boot block, then enter the update BIOS image. Select "Y" to start the BIOS flash procedure and do not disturb your system until the flash utility displays that the procedure is complete. After updating your BIOS, please clear the CMOS then load Optimal Values in the BIOS.

Question: After flashing the BIOS my system does not have video. How can I correct this?

Answer: If the system does not have video after flashing your new BIOS, it indicates that the flashing procedure failed. To remedy this, first clear CMOS per the instructions in this manual and retry the BIOS flashing procedure. If you still do not have video, please use the following **BIOS Recovery Procedure**. First, make sure the JPWAKE jumper is disabled. Then, turn your system off and place the floppy disk with the saved BIOS image file (see above FAQ) in drive A. Press and hold <CTRL> and <Home> at the same time, then turn on the power with these keys pressed until your floppy drive starts reading. Your screen will remain blank until the BIOS program is done. If the system reboots correctly, then the recovery was successful. The BIOS Recovery Procedure will not update the boot block in your BIOS.

Question: Do I need the CD that came with your motherboard?

Answer: The supplied compact disc has quite a few drivers and programs that will greatly enhance your system. We recommend that you review the CD and install the applications you need. Applications on the CD include chipset drivers for Windows and security and audio drivers.

Question: Why can't I turn off the power using the momentary power on/off switch?

Answer: The instant power off function is controlled in BIOS by the Power Button Mode setting. When the On/Off feature is enabled, the motherboard

will have instant off capabilities as long as the BIOS has control of the system. When the Standby or Suspend feature is enabled or when the BIOS is not in control such as during memory count (the first screen that appears when the system is turned on), the momentary on/off switch must be held for more than four seconds to shut down the system. This feature is required to implement the ACPI features on the motherboard.

3-4 Returning Merchandise for Service

A receipt or copy of your invoice marked with the date of purchase is required before any warranty service will be rendered. You can obtain service by calling your vendor for a Returned Merchandise Authorization (RMA) number. When returning to the manufacturer, the RMA number should be prominently displayed on the outside of the shipping carton, and mailed prepaid or hand-carried. Shipping and handling charges will be applied for all orders that must be mailed when service is complete.

This warranty only covers normal consumer use and does not cover damages incurred in shipping or from failure due to the alternation, misuse, abuse or improper maintenance of products.

During the warranty period, contact your distributor first for any product problems.

Notes

Chapter 4

BIOS

4-1 Introduction

This chapter describes the AMIBIOS for the 370DE6/370DER/370DER+/370DEI/370DEI+. The AMI ROM BIOS is stored in a Flash EEPROM and can be easily upgraded using a floppy disk-based program.

Note: Due to periodic changes to BIOS, some settings may have been added or deleted and might not yet be recorded in this manual. Refer to the Manual Download area of our web site for any changes to BIOS that are not reflected in this manual.

System BIOS

The BIOS is the Basic Input Output System used in all IBM® PC, XT™, AT®, and PS/2® compatible computers. The BIOS ROM stores the system parameters, such as amount of memory, type of disk drives and video displays, etc. BIOS ROM requires very little power. When the computer is turned off, a back-up battery provides power to the BIOS ROM, enabling it to retain the system parameters. Each time the computer is powered-on, the computer is then configured with the values stored in the BIOS ROM by the system BIOS, which gains control when the computer is powered on.

How To Change the Configuration Data

The configuration data that determines the system parameters may be changed by entering the BIOS Setup utility. This Setup utility can be accessed by pressing at the appropriate time during system boot.

Starting the Setup Utility

Normally, the only visible POST (Power On Self Test) routine is the memory test. As the memory is being tested, press the <Delete> key to enter the main menu of the BIOS Setup utility. From the main menu, you can access the other setup screens, such as the Chipset and Power menus. Section 4-3 gives detailed descriptions of each parameter setting in the Setup utility.

An AMIBIOS identification string is displayed at the left bottom corner of the screen, below the copyright message.

4-2 BIOS Features

- Supports Plug and Play V1.0A and DMI 2.3
- Supports Intel PCI (Peripheral Component Interconnect) (PME) local bus specification 2.2
- Supports Advanced Power Management (APM) specification v 1.1
- Supports ACPI
- Supports Flash ROM

AMIBIOS supports the LS120 drive made by Matsushita-Kotobuki Electronics Industries Ltd. The LS120:

- Can be used as a boot device
- Is accessible as the next available floppy drive

AMIBIOS supports PC Health Monitoring chips. When a failure occurs in a monitored activity, AMIBIOS can sound an alarm and display a message. The PC Health Monitoring chips monitor:

- CPU temperature
- Chassis intrusion detector
- Five positive voltage inputs
- Four fan speed monitor inputs

4-3 Running Setup

**Optimal default settings are in bold text unless otherwise noted.*

The BIOS setup options described in this section are selected by choosing the appropriate text from the Standard Setup screen. All displayed text is described in this section, although the screen display is often all you need to understand how to set the options (see on next page).

The Main BIOS Setup Menu

Press the <Delete> key during the POST (Power On Self Test) to enter the Main Menu of the BIOS Setup Utility. All Main Setup options are described in this section. The Main BIOS Setup screen is displayed below.

BIOS SETUP UTILITY	
Main Advanced Chipset PCIPnP Power Boot Security Exit	
AMIBIOS Version : 07.00xx BIOS Build Date : xx/xx/xx BIOS ID : Processor Type : PentiumIII™ Processor Speed : 933MHz System Memory : 256MB System Time [10:10:00] System Date [Thu 08/24/00]	← Select Screen ↑↓ Select Item +- Change Field Tab Select Field F1 General Help F10 Save and Exit ESC Exit
V02.03 (C)Copyright 1985-2000, American Megatrends, Inc.	

Use the Up/Down arrow keys or the <Tab> key to move between the different settings in the above menu.

When the items "System Time", and "System Date" are highlighted, type in the correct time/date in the time field, and then press "Enter". The date must be entered in MM/DD/YY format. The time is entered in HH:MM:SS format. The time is in also 24-hour format. For example, 5:30 a.m. appears as 05:30:00 and 5:30 p.m. as 17:30:00.

Press the <ESC> key to exit the Main Menu and use the Left/Right arrow keys to enter the the other categories of BIOS settings. The next section is described in detail to illustrate how to navigate through the menus.

***Note:** Items displayed in gray are preset and cannot be selected. Items with a blue arrow are commands, not options (i.e. Discard Changes).

4-4 Advanced BIOS Setup

Choose Advanced BIOS Setup from the AMIBIOS Setup Utility main menu with the Left/Right arrow keys. You should see the following display. Select one of the items in the left frame of the screen, such as SuperIO Configuration, to go to the sub screen for that item. Advanced BIOS Setup options are displayed by highlighting the option using the arrow keys. All Advanced BIOS Setup options are described in this section.

BIOS SETUP UTILITY							
Main	Advanced	Chipset	PCIPnP	Power	Boot	Security	Exit
Setup Warning Setting items on this screen to incorrect values may cause the system to malfunction! > SuperIO Configuration > IDE Configuration > Floppy Configuration > Boot Settings Configuration > Event Log Configuration > Peripheral Device Configuration > System Health Monitor				Configure SuperIO Chipset Winbond627F ↔ Select Screen ↑↓ Select Item Enter Go to Sub Screen F1 General Help F10 Save and Exit ESC Exit			
V02.03 (C)Copyright 1985-2000, American Megatrends, Inc.							

Use the Up/Down arrow keys to select the "Super I/O Configuration line.

When the "Super IO Configuration" line is highlighted, hit "ENTER" to display its menu.

The following Super IO Configuration screen will appear. Here you can select your options for the your computer's I/O (Input/Output) devices.

Super IO Configuration

BIOS SETUP UTILITY	
Advanced	
Configure Nat3l7Serial Port(s)and Parallel P	
Serial Port1 Address	[3F8]
Serial Port1 IRQ	[4]
Serial Port2 Address	[2F8]
Serial Port2 IRQ	[3]
Parallel Port Address	[378]
Parallel Port IRQ	[7]
Parallel Port Mode	[ECP]
ECP Mode DMA Channel	[3]
	↔ Select Screen ↑↓ Select Item +- Change Option F1 General Help F10 Save and Exit ESC Exit
V02.03 (C)Copyright 1985-2000, American Megatrends, Inc.	

The Super IO Configuration includes the following items:

Serial Port 1 Address

This option specifies the base I/O port address of serial port 1. The settings for this item include Disabled, **3F8** and 3E8 and 2E8. Select the desired setting and then press "Enter".

Serial Port 1 IRQ

This option specifies the Interrupt Request address of serial port 1. The settings for this item include Disabled, **4** and 3.

Serial Port 2 Address

This option specifies the base I/O port address of serial port 2. The settings for this item include Disabled, **2F8**, 3E8 and 2E8.

Serial Port 2 IRQ

This option specifies the Interrupt Request address of serial port 2. The settings for this item include Disabled, **4** and **3**.

Parallel Port Address

(370DE6/370DER/370DER+/370DEI/370DEI+)

This option specifies the I/O address used by the parallel port. The settings for this item include Disabled, **378**, 278 and 3BC. Select your setting and then press "Enter".

Parallel Port IRQ

(370DE6/370DER/370DER+/370DEI/370DEI+)

This option allows the user to set the Parallel Port IRQ. The settings for this item include 5 and 7.

Parallel Port Mode

(370DE6/370DER/370DER+/370DEI/370DEI+)

This option specifies the parallel port mode. The settings for this item include Normal, Bi-directional, EPP and **ECP**.

ECP Mode DMA Channel

(370DE6/370DER/370DER+/370DEI/370DEI+)

This option allows the user to set the setting for the ECP Mode of the DMA Channel. The settings for this item include **0**, 1 and 3.

IDE Configuration

Onboard PCI IDE Controller

This option allows the user to enable or disable the integrated IDE Controller. The settings include Disabled, Primary, Second and **Both**. Select "Disabled" to disable the Integrated IDE Controller. Select "Primary" to enable the Primary IDE controller only. Select "Secondary" to enable the Secondary IDE Controller only. Select "Both" to enable both Primary and Secondary IDE Controllers.

Primary IDE Master

When entering "Setup", BIOS automatically detects the presence of IDE devices. This displays the auto detection status of the IDE devices. You can also manually configure the IDE drives by providing the following information:

This option allows the user to configure the IDE devices. When the desired item is highlighted (selected), press "Enter" and the following screen will be displayed:

Type

This option sets the type of device that the AMIBIOS attempts to boot from after AMIBIOS POST is completed. The settings include Not installed, **Auto**, CDROM and ARMD. The "Auto" setting allows BIOS to automatically detect the presence of the IDE controller.

LBA/Large Mode

LBA (Logical Block Addressing) is a method of addressing data on a disk drive. In LBA mode, the maximum drive capacity is 137 GB. The settings are Disabled and **Auto**. Select "Disabled" to disable LBA mode. Select "Auto" to enable LBA mode if your device supports it and is not already formatted with the LBA mode.

Block (Multi-Sector Transfer) Mode

This option sets the block mode multi sector transfers option. The settings include Disabled and **Auto**. Disabled: This option prevents the BIOS from using Multi-Sector Transfer on the specified channel. The data to and from the device will occur one sector at a time. Auto: This option allows the BIOS to auto detect device support for Multi-Sector Transfers on the specified channel. If supported, this option allows the BIOS to auto detect the number of sectors per block for transfer from the hard disk drive to memory. The data transfer to and from the device will occur multiple sectors at a time (if the device supports it).

PIO Mode

IDE PIO (Programmable I/O) mode programs timing cycles between the IDE drive and the programmable IDE controller. As the PIO mode increases, the cycle time decreases. The settings are: **Auto**, 0, 1, 2, 3 and 4.

DMA Mode

This item allows the users to select the DMA mode. The settings are: **Auto**, SWDMA0, SWDMA1, SWDMA2, MWDMA0, MWDMA1, MWDMA2, UWDMA0, UWDMA1, UWDMA2, UWDMA3 and UWDMA4. Select Auto to auto detect the DMA Mode. Select SWDMA0 through SWDMA2 to set single word DMA0 through DMA2. Select MWDMA0 through MWDMA2 to set Multi-word DMA0 through DMA2. Select UDMA0 through UDMA4 to set Ultra DMA0 through Ultra DMA4.

S.M.A.R.T.

S.M.A.R.T stands for Self-Monitoring Analysis and Reporting Technology, a feature that can help predict impending drive failures. The settings are **Auto**, Disabled and Enabled. Select "Enabled" or "Disabled" to enable or disable the S.M.A.R.T. Select "Auto" to auto detect S.M.A.R.T.

32Bit Data Transfer

The settings are Auto, Disabled and **Enabled**. Select "Enabled" or "Disabled" to enable or disable the 32-bit Data Transfer function. Select "Auto" to auto detect the 32-bit Data Transfer function.

ARMD Emulation Type

This option is used to select the emulation used when configuring an LS120, MO (Magneto-Optical), or Iomega Zip drive. The settings are **Auto**, Floppy and HardDisk.

Primary IDE Slave

When the system enters "Setup", BIOS automatically detects the presence of IDE devices. This option displays the auto detection status of IDE devices. The settings for "Primary IDE Slave" are the same as those for the "Primary IDE Master".

Secondary IDE Master

This displays the status of auto detection of IDE devices. The settings for "Secondary IDE Master" are the same as those for the "Primary IDE Master".

Secondary IDE Slave

This displays the status of auto detection of IDE devices. The settings for "Secondary IDE Slave" are the same as those for the "Primary IDE Master".

Hard Disk Write Protect

This item allows the user to prevent the hard disk from being overwritten. The options are Enabled or **Disabled**. Enabled allows the drive to be used normally; read, write and erase functions can all be performed. Disabled prevents the hard disk from being erased. This function is effective only when the device is accessed through BIOS.

ATA(PI) Detect Timeout (Second)

Set this option to stop the system search for ATAPI devices within the specified number of seconds. The options are 0, 5, 10, 15, 20, 25, 30, and **35** (seconds). Most ATA disk drives can be detected within 5 seconds.

ATA(PI) 80Pin Cable Detection

This option selects the mechanism for detecting the 80-pin ATA(PI) cable. Options include **Host and Device**, Host, and Device. Host: This option uses the motherboard onboard IDE controller to detect the type of IDE cable used. Device: This option uses the IDE disk drive to detect the type of IDE cable used. Host & Device: This option uses both the motherboard onboard IDE controller and IDE disk drive to detect the type of IDE cable used.

Floppy Configuration

Floppy A

Use this option to specify which of floppy drive you have installed in the A drive. The settings are Disabled, 360 KB 5 1/4", 1.2 MB 5 1/4", 720 KB 3 1/2", **1.44 MB 3 1/2"** and 2.88 MB 3 1/2".

Floppy B

Use this option to specify which of floppy drive you have installed in the B drive. The settings are Disabled, 360 KB 5 1/4", 1.2 MB 5 1/4", 720 KB 3 1/2", **1.44 MB 3 1/2"** and 2.88 MB 3 1/2".

Diskette Write Protect

This option allows you to prevent any writing to your floppy diskette. The settings are **Disabled**, 360 KB 5 1/4", 1.2 MB 5 1/4", 720 KB 3 1/2", **1.44 MB 3 1/2"** and 2.88 MB 3 1/2". The Enabled setting is effective only if the device is accessed through BIOS.

Floppy Drive Seek

Use this option to Enable or **Disable** the floppy seek routine on bootup.

Boot Settings Configuration

Quick Boot

This option allows the BIOS to skip certain tests that are normally performed on boot up. You can disable the option to speed up boot time. The settings are **Disabled** and Enabled.

Quiet Boot

If Disabled, this option will cause the normal POST messages to be displayed upon setup. When Enabled, the OEM logo is displayed instead of the POST messages. The settings are Enabled, and **Disabled**.

Add-On ROM Display Mode

Set this option to display add-on ROM (read-only memory) messages. The settings for this option are **Force BIOS** and Keep Current. Force BIOS allows the computer to force a third party BIOS to display during system

boot. Keep Current has the system display AMIBIOS information on bootup.

BootUp Num Lock

This option is used to select the status of the Number Lock function on your keyboard on bootup. The settings are **On** and Off.

BootUp CPU Speed

This option is used set the CPU speed to either **High** or Low.

PS/2 Mouse Support

This option specifies whether a PS/2 Mouse will be supported. Settings are **Enabled** and Disabled.

Typematic Rate

Set this option to select the rate at which the computer repeats a key that is held down. Settings are **Fast** and Slow. Fast: This sets the rate the computer repeats a key to over 20 times per second. Under normal operations, this setting should not be changed. Slow: This sets the rate the computer repeats a key to under 8 times per second.

System Keyboard

This option is to let the system know if a keyboard is **Present** or Absent.

Primary Display

This option specifies the type of monitor display you have installed on the system. The settings are Absent, **VGA/EGA**, Color 40 x 25, Color 80 x 25 and monochrome.

Parity Check

Use this option to either Enable or **Disable** the use of memory parity checking.

Boot to OS/2

This option can be used to boot the system to an OS/2 operating system. The settings are **No** and Yes.

Wait for F1 if Error

This settings for this option are **Enabled** and Disabled. Disabled: This prevents the AMIBIOS to wait on an error for user intervention. This setting should be used if there is a known reason for a BIOS error to appear. An example would be a system administrator must remote boot the system. The computer system does not have a keyboard currently attached. If this setting is set, the system will continue to bootup in to the operating system. If 'F1' is enabled, the system will wait until the BIOS setup is entered. Enabled: This option allows the system BIOS to wait for any error. If an error is detected, pressing <F1> will enter Setup and the BIOS setting can be adjusted to fix the problem. This normally happens when upgrading the hardware and not setting the BIOS to recognize it.

Hit "Delete" Message Display

This option tells the system to display or not display the "Hit Delete to Enter Setup" message. The settings are **Enabled** and Disabled.

Processor Serial Number

This option allows the operating system and applications to be able to read the CPU serial number from your CPUs. The settings are Enabled and **Disabled**. (*Note: This option is not available for Intel Celeron Processors because these processors do not contain a processor serial number.)

Internal Cache

This option is for enabling or disabling the internal CPU L1 cache. Settings include Disabled, Write-Thru, **Write-Back** and Reserved. Disabled: This option prevents the system from using the internal CPU L1 cache. This setting should be used to slow the computer system down or to troubleshoot error messages. Write-Thru: This option allows the computer system to use the internal CPU L1 cache as Write-Through cache. Write-Through cache is slower than Write-Back cache. It performs write operations to the internal L1 CPU cache and system memory simultaneously. Write-Back: This option allows the computer system to use the internal CPU L1 cache as Write-Back cache. Write-Back cache is faster than Write-Through cache. Write-Back cache is a caching method in which modifications to data in the cache aren't copied to the cache source until absolutely necessary. Write-back caching is available on all CPUs supported by this BIOS. With these

CPUs, write operations stored in the L1 cache aren't copied to main memory until absolutely necessary. This is the default setting.

System BIOS Cacheable

This option enables you to move the system BIOS to the memory cache to improve performance. Settings are **Enabled** and Disabled.

External Cache

This option is for enabling or disabling the internal CPU L2 cache. Settings include Disabled, Write-Thru and **Write-Back**. See description above.

Event Log Configuration

Event Logging

This option **Enables** or Disables the logging of events. You can use this screen to select options for the Event Log Configuration Settings. You can access sub screens to view the event log and mark all events as read. Use the up and down arrow keys to select an item, and the plus (+) and minus (-) keys to change the option setting. The settings are described on the following pages. The screen is shown below.

ECC Event Logging

This option Enables or **Disables** the logging of ECC events. The events logged by AMIBIOS are post errors such as a bad BIOS, floppy errors, or hard drive errors.

Clear All Event Logs

This option can be used to tell the system to clear the event log on the next boot up. The settings are **No** and Yes.

View Event Log

Highlighting this and pressing <Enter> will allow you to view the unread events from the event log area.

View Event Log

Highlighting [OK] and pressing <Enter> will mark all events in the log area as read. The settings are OK and Cancel.

Peripheral Device Configuration

Onboard SCSI

This option allows you to Enable the onboard SCSI. The settings are **Enabled** and Disabled.

Power Lost Control

This option determines how the system will respond when power is reapplied after a power loss condition. **Always On** means the system will automatically start up when power is reapplied. Always Off means you must push the main power button to restart the system after power is restored.

System Health Monitor

The BIOS continuously monitors the health of your system by measuring certain voltage levels and temperatures.

CPU1 Current Temperature

CPU2 Current Temperature

This option allows the system to auto detect and display the temperatures of CPU1 and CPU2.

System Overheat Warning

This option allows you to **Enable** or Disable a system overheat warning signal, used to notify you in the event of a dangerous rise in heat levels.

Overheat Warning Temperature

This option allows you to specify the temperature threshold that, when exceeded, will trigger the overheat warning alarm.

The rest of the System Health Monitor menu lists various voltages and temperatures as they are currently being measured. These include CPU temperature, CPU voltage, the rpms of the CPU, chassis and thermal control fans as well as the primary voltage levels used by the system: +3.3V, +5V, +12V and -12V. Items such as H/W Monitor CPU1VCORE, H/W Monitor CPU2VCORE, H/W Monitor +3.3V, H/W Monitor +5V, H/W Monitor +12V, CPU Fan1, CPU Fan2, ChassisFan1, Chassis Fan2 are also included in this option.

4-5 Chipset Setup

Choose Chipset Setup from the AMIBIOS Setup Utility main menu. The screen is shown below. All Chipset Setup options are described following the screen.

BIOS SETUP UTILITY							
Main	Advanced	Chipset	PCIPnP	Power	Boot	Security	Exit
C000,16k Shadow				[Cached]			
C400,16k Shadow				[Cached]			
C800,16k Shadow				[Disabled]			
CC00,16k Shadow				[Disabled]			
D000,16k Shadow				[Disabled]			
D400,16k Shadow				[Disabled]			
D800,16k Shadow				[Disabled]			
DC00,16k Shadow				[Disabled]			
Write Combining for P6 to PCI				[Enabled]		↔	Select Screen
Act to DeAct				[6CLKS]		↑↓	Select Item
Act to Read/Write				[3CLKS,2CLKS]		+-	Change Option
RA Cycle Time				[9CLK]		F1	General Help
SDRAM CAS Latency				[CAS Latency3]		F10	Save and Exit
Memory Auto Precharge				[Disabled]		ESC	Exit
SDRAM Fast Timing				[11-1-1,10-1-1]			
V02.03 (C)Copyright 1985-2000, American Megatrends, Inc.							

C000, 16k Shadow

C400, 16k Shadow

C800, 16k Shadow

CC00, 16k Shadow

D000, 16k Shadow

D400, 16k Shadow

D800, 16k Shadow

DC00, 16k Shadow

These options specify how the 16 KB of video ROM at each of the above addresses is treated. When Disabled, the contents of the video ROM are not copied to RAM. When Enabled, the contents of 16 KB of video ROM beginning at the above address are copied (shadowed) from ROM to RAM for faster application. When set to Cached/WP, the contents of 16 KB of

video ROM beginning at the above address are copied (shadowed) from ROM to RAM and can be written to or read from cache memory. The settings for this option are Disabled, Enabled and Cached/WP. (The optimal settings are Cached/WP for C000 and C400 and Disabled for all the other settings.

Write Combining for P6-to-PCI

This settings for this option are **Disabled** and **Enabled**. Select "Enabled" to enable the function of Write Combining for P6-to-PCI.

Act to Deact

This settings for this option are **6 CLKS** and 5 CLKS.

Act to Read/Write

This settings for this option are **3 CLKS** and 2 CLKS.

RAS Cycle Time

This option defines the RAS cycle time. Settings include 10 CLKS, **9 CLKS**, 8 CLKS and 7 CLKS.

SDRAM CAS Latency

This option defines the SDRAM CAS Lantency settings. CAS stands for Column Address Strobe. Settings include CAS Lantgency 3, CAS Lantgency 2.

Memory Auto Precharge

The settings are **Enabled**, and Disabled.

SDRAM Fast Timing

This option defines the Fast timing settings for SDRAM . Settings include 11-1-1 and 10-1-1.

MemoryWriting Posting

The settings are **Enabled**, and Disabled.

Fast ECC Enable

The settings are Enabled, and **Disabled**.

ISA IO Cycle Delay

This settings for this option are Full Delay, **1.5 BCLK**, 2.5 BCLK and 3.5 BCLK.

Scrubbing Enable

The settings are Enabled, and **Disabled**.

AGP Device Address Space Size

This settings for this option are **32MB, 64MB, 128MB, 256MB, and 512MB**.

AGP Operations

This settings for this option are **Enabled, and Disabled**.

MPS 1.4 Support

The settings for this option are **Enabled** and Disabled.

4-6 PCI PnP Setup

Choose PCI/PnP Setup from the AMIBIOS Setup main menu. All PCI/PnP options are described in this section. The PCI/PnP Setup screen is shown below.

BIOS SETUP UTILITY		
Main	Advanced	Chipset PCIPnP Power Boot Security Exit
Plug & Play O/S	[No]	No: lets the BIOS configure all the devices in the system.
Reset Config Data	[No]	Yes: lets the operating system configure Plug and Play (PnP) devices not required for boot if your system has a Plug and Play operating system.
PCI Latency Timer	[64]	
Allocate IRQ to VGA	[Yes]	
Palette Snooping	[Disabled]	
PCI IDE BusMaster	[Disabled]	
OffBoard PCI/ISA IDE Card	[Auto]	
USB Controller	[Enabled]	
USB Controller	[Disabled]	
IRQ3	[Available]	
IRQ4	[Available]	↔ Select Screen
IRQ5	[Available]	↑↓ Select Item
IRQ7	[Available]	+ - Change Option
IRQ9	[Available]	F1 General Help
IRQ10	[Available]	F10 Save and Exit
IRQ11	[Available]	ESC Exit
IRQ14	[Available]	
V02.03 (C)Copyright 1985-2000, American Megatrends, Inc.		

Plug & Play OS

Choose the **No** setting for computers that do not meet the Plug and Play specifications, which will allow the BIOS to configure all the devices in the system. Choosing the Yes setting lets the operating system configure PnP devices that are not required for boot up (if the system has a PnP operating system). The operating system would have the ability to change interrupt, I/O, and DMA settings. Set this option if the system is running Windows 95®, Windows 98® or Windows 2000®. Other operating systems are also PnP-aware.

Reset Configuration Data

Choosing the Yes setting will cause the PnP configuration data in the BIOS to be cleared on the next boot up. Choosing the **No** setting does not force PnP data to be cleared on the next boot.

PCI Latency Timer

This option specifies the latency timing of the PCI clocks for all PCI devices. Settings include 32, **64**, 96, 128, 160, 192, 224 and 248 PCI clocks.

Allocate IRQ to PCI VGA

This option lets you allocate an interrupt request (IRQ) to the PCI VGA adapter card (if used). The settings are **Yes** and No.

Palette Snooping

When enabled, this option informs PCI devices that an ISA graphics device is installed. The settings are **Disabled** and Enabled. This does not necessarily indicate a physical ISA adapter card. The graphics chipset can be mounted on a PCI card. Always check with your adapter card manuals first, before modifying the default settings in the BIOS.

PCI IDE BusMaster

The settings for this option are **Disabled** and Enabled. Enable to specify that the IDE controller on the PCI bus has bus mastering capabilities.

OffBoard PCI/ISA IDE Card

This option specifies which PCI slot has an IDE controller card installed. Settings are **Auto**, PCI slot 1, PCI slot 2, PCI slot 3, PCI slot 4, PCI slot 5 and PCI slot 6. (PCI slot numbers will be available in this option even if your motherboard does not have that slot number. If your motherboard does not have a PCI slot 5, for example, do not set this option to "PCI slot5".)

USB Function

The settings for this option are Disabled and **Enabled**. Disabled prevents the use of the USB ports and Enabled allows the use of the USB ports.

Legacy USB Support

This option allows Legacy USB support. The settings are **Disabled**, **Enabled** and **Auto**. **Disabled** prevents the use of any USB device in DOS or during system boot. **Enabled** allows the use of USB devices during boot and while using DOS. The **Auto** setting auto detects USB keyboards or mice and if found, allows them to be utilized during boot and while using DOS.

IRQ 3

IRQ 4

IRQ 5

IRQ 7

IRQ 9

IRQ 10

IRQ 11

IRQ 14

IRQ 15

The settings for the above options are **Available** and **Reserved**. **Available** allows the specified IRQ to be available for use by PCI/PnP devices. **Reserved** means the specified IRQ is reserved for use by Legacy ISA devices.

DMA Channel 0

DMA Channel 1

DMA Channel 3

DMA Channel 5

DMA Channel 6

DMA Channel 7

Each of the above list of DMA channel setting options can be set to **Available** and **Reserved**. **Available** means the specified DMA channel is available for use by PCI/PnP devices. **Reserved** means the specified DMA channel is reserved for use by Legacy ISA devices.

Reserved Memory Size

This option specifies the size of a memory area to be reserved for Legacy ISA adapter cards. The settings are **Disabled**, 16k, 32k and 64k.

4-7 Power Setup

Choose Power Setup from the AMIBIOS Setup main menu. All Power Setup options are described in this section. The Power Setup screen is shown below.

BIOS SETUP UTILITY							
Main	Advanced	Chipset	PCIPnP	Power	Boot	Security	Exit
ACPI Aware O/S				[No]			
Power Management				[Enabled]			
Power Button Mode				[On/Off]			
Sleep Button Mode				[Suspend]			
Green PC Monitor Power State				[StandBy]			
Video Power Down Mode				[Suspend]			
Inactivity Timer				[Off]			
Suspend Timeout (Minutes)				[Off]			
IRQ1				[Monitor]			
IRQ3				[Ignore]			
IRQ4				[Ignore]			
IRQ5				[Ignore]			↔ Select Screen
IRQ6				[Ignore]			↑↓ Select Item
IRQ7				[Ignore]			+ - Change Option
IRQ9				[Ignore]			F1 General Help
IRQ10				[Ignore]			F10 Save and Exit
IRQ11				[Ignore]			ESC Exit
IRQ12				[Monitor]			
IRQ14				[Monitor]			
IRQ15				[Ignore]			
V02.03 (C)Copyright 1985-2000, American Megatrends, Inc.							

ACPI Aware O/S

This option allows the system to utilize Intel's ACPI (Advanced Configuration and Power Interface) specification. Settings are **No** and **Yes**. DOS®, Windows 3.x®, and Windows NT® are examples of non-ACPI aware operating systems. Windows 95®, Windows 98®, Windows ME® and Windows 2000® are examples of ACPI aware operating systems.

Power Management

This option allows you to select using APM (Advanced Power Management). The settings are **Disabled** and **Enabled**.

Power Button Mode

This option specifies how the external power button on the computer chassis functions. When set to **On/Off**, depressing the power button turns the computer on or off. When set to **Suspend**, depressing the power button places the computer in Suspend mode or Full On power mode. The **Standby** setting places the computer in Standby or Full On mode.

Sleep Button Enable

This option is to enable the use of the sleep button. The settings are **Suspend** and **Disable**.

Green PC Monitor Power State

This option specifies the power state that a green PC-compliant monitor enters when BIOS places it in a power saving state after the specified period of display inactivity has expired. The settings include **Standby**, **Suspend** and **Off**.

Video Power Down Mode

This option specifies the power state that the VGA video subsystem enters after the specified period of display inactivity has expired. The settings include **Disabled**, **Standby** and **Suspend**.

Inactivity Timer

This option specifies the length of hard disk inactivity time that should expire before entering the power conserving state. The settings include **Off**, 1, 5, 10, 20, 30, 60 and 120 (minutes).

Suspend Timeout

This option specifies if BIOS is to monitor for display activity when in a power saving state. The settings include **Off**, 1, 2, 3, 4, 5, 6, 7, 8, 9 and 10 (minutes).

IRQ1

IRQ3

IRQ4

IRQ5

IRQ6

IRQ7

IRQ9

IRQ10

IRQ11

IRQ12

IRQ14

IRQ15

With the above options, you can monitor each interrupt request and resume the system's normal power up state when activated. Settings are Ignore and Monitor. All IRQs are defaulted to Ignore except for IRQ 1, 12 and 14, which default to Monitor.

USB Controller Resume

This allows you to wake up the system from a USB device. The settings for this option **Disabled** and Enabled.

PME Resume

This allows you to wake up the system from a PME device. The settings for this option **Disabled** and Enabled.

RI Resume

This option allows the system to resume the function of Ring Indicator. The settings for this option **Disabled** and Enabled.

4-8 Boot Setup

Choose Boot Setup from the AMIBIOS Setup main menu. All Boot Setup options are described in this section. The Boot Setup screen is shown below.

BIOS SETUP UTILITY							
Main	Advanced	Chipset	PCIPnP	Power	Boot	Security	Exit
> <u>Boot Device Priority</u> > Hard Disk Drives > Removable Devices > ATAPI CDROM Drives						↔ Select Screen ↑↓ Select Item Enter Go to Sub Screen F1 General Help F10 Save and Exit ESC Exit	
V02.03 (C)Copyright 1985-2000, American Megatrends, Inc.							

Boot Device Priority

1st Boot Device

This option is used to specify the order of the boot sequence that will be followed from the available system devices. The settings for the 1st Boot Device are **Removable Device**, ATAPI CDROM, Hard Drive and Disabled.

2nd Boot Device

The settings for the 2nd Boot Device are Removable Device, **ATAPI CDROM**, Hard Drive and Disabled.

3rd Boot Device

The settings for the 3rd Boot Device are **Removable Device**, **ATAPI CDROM**, **Hard Drive** and **Disabled**.

Hard Disk Drives

Use this screen to view the boot sequency of hard drives that have been auto-detected or entered manually on your system.

Removable Devices

Use this screen to view the boot sequency of the removeable devices that have been auto-detected or entered manually on your system.

ATAPI CDROM Drives

Use this screen to view the boot sequency ofthe ATAPI CDROM drives that have been auto-detected or entered manually on your system.

4-9 Security Setup

Choose Security Setup from the AMIBIOS Setup main menu. All Security Setup options are described in this section. The Security Setup screen is shown below.

BIOS SETUP UTILITY							
Main	Advanced	Chipset	PCIPnP	Power	Boot	Security	Exit
Supervisor Password :						Not Installed	
User Password :						Not Installed	
> <u>Change Supervisor Password</u>							
> Change User Password							
> Clear User Password							
Boot Sector Virus Protection						[Disabled]	
						Install or Change the password. ↔ Select Screen ↑↓ Select Item Enter Go to Sub Screen F1 General Help F10 Save and Exit ESC Exit	
V02.03 (C)Copyright 1985-2000, American Megatrends, Inc.							

Supervisor Password

User Password

AMIBIOS provides both Supervisor and User password functions. If you use both passwords, the Supervisor password must be set first. The system can be configured so that all users must enter a password every time the system boots or when AMIBIOS Setup is executed, using either or both the Supervisor password or User password. The Supervisor and User passwords activate two different levels of password security. If you select password support, you are prompted for a 1 – 6 character password. Type the password on the keyboard. The password does not appear on the screen when typed. Make sure you write it down. If you forget it, you must clear CMOS and reconfigure. **Remember your Password!** Keep a record of the new password when the password is changed. If you forget the password, you must erase the system configuration information in CMOS.

Change Supervisor Password

This option allows you to change a supervisor password that was entered previously.

Change User Password

This option allows you to change a user password that was entered previously.

Clear User Password

Use this option to clear the user password so that it is not required to be entered when the system boots up.

Boot Sector Virus Protection

This option allows you to enable or disable a virus detection program to protect the boot sector of your hard disk drive. The settings for this option **Disabled** and Enabled. If Enabled, AMIBIOS will display a warning when any program (or virus) issues a Disk Format command or attempts to write to the boot sector of the hard disk drive.

Load Optimal Defaults

Highlighting this setting and then pressing <Enter> provides the optimum performance settings for all devices and system features.

Load Failsafe Defaults

Highlighting this setting and then pressing <Enter> provides the safest set of parameters for the system. Use them if the system is behaving erratically.

Discard Changes

Highlighting this setting and then pressing <Enter> will ignore any changes you made in the BIOS Setup program but will not exit the BIOS Setup program.

Appendix A

BIOS Error Beep Codes & Messages

During the POST (Power-On Self-Test) routines, which are performed each time the system is powered on, errors may occur.

Non-fatal errors are those which, in most cases, allow the system to continue the boot-up process. The error messages normally appear on the screen.

Fatal errors are those which will not allow the system to continue the boot-up procedure. If a fatal error occurs, you should consult with your system manufacturer for possible repairs.

These fatal errors are usually communicated through a series of audible beeps. The numbers on the fatal error list, on the following page, correspond to the number of beeps for the corresponding error. All errors listed, with the exception of Beep Code 8, are fatal errors.

AMI BIOS Error Beep Codes

Beep Code	Error Message	Description
1 beep	Refresh	<i>The memory refresh circuitry on the motherboard is faulty</i>
2 beeps	BIOS ROM file absent	<i>The BIOS was unable to find the specific file name required to flash the BIOS</i>
3 beeps	Base 64KB memory failure	<i>Memory failure occurred in the first 64KB of Memory</i>
4 beeps	Flash program successful	<i>The flash was properly programmed with the BIOS ROM file.</i>
5 beeps	Media read error	<i>The floppy or ATAPI media is not presented or cannot be read</i>
6 beeps	Keyboard controller Gate A20 failure	<i>The keyboard controller may be bad. The BIOS cannot switch to protected mode.</i>
7 beeps	Processor exception interrupt error	<i>The CPU generated an exception interrupt</i>
8 beeps	Display memory read/write error	<i>The system video adapter is either missing or its memory is faulty. This is not a fatal error.</i>
10 beeps	Flash erase error	<i>The flash device was unable to be properly programmed.</i>
11 beeps	Flash program error	<i>The flash device was unable to be properly programmed.</i>
12 beeps	BIOS ROM file incorrect size	<i>The BIOS ROM file found does not match the size of the flash device</i>
13 beeps	BIOS ROM image mismatch	<i>The BIOS ROM file layout configuration does not match image present in the flash device.</i>
5 short +_1 long beeps	Memory Error	<i>No memory detected in the system</i>
6 short + 1 long beeps	Memory Error	<i>EDO memory detected in system</i>
7 short + 1 long beeps	SMBUS Error	<i>SMBUS error</i>

Appendix B

AMIBIOS POST Checkpoint Codes

When AMIBIOS performs the Power On Self Test, it writes diagnostic codes checkpoint codes to I/O port 0080h. If the computer cannot complete the boot process, diagnostic equipment can be attached to the computer to read I/O port 0080h.

B-1 Uncompressed Initialization Codes

The uncompressed initialization checkpoint codes are listed in order of execution:

Checkpoint	Code Description
D0h	The NMI is disabled. Power on delay is starting. Next, the initialization code checksum will be verified.
D1h	Initializing the DMA controller, performing the keyboard controller BAT test, starting memory refresh, and entering 4 GB flat mode next.
D3h	Starting memory sizing next.
D4h	Returning to real mode. Executing any OEM patches and setting the Stack next.
D5h	Passing control to the uncompressed code in shadow RAM at E000:0000h. The initialization code is copied to segment 0 and control will be transferred to segment 0.
D6h	Control is in segment 0. Next, checking if <Ctrl> <Home> was pressed and verifying the system BIOS checksum. If either <Ctrl> <Home> was pressed or the system BIOS checksum is bad, next will go to checkpoint code E0h. Otherwise, going to checkpoint code D7h.

B-2 Bootblock Recovery Codes

The bootblock recovery checkpoint codes are listed in order of execution:

Checkpoint	Code	Description
E0h		The onboard floppy controller if available is initialized. Next, beginning the base 512 KB memory test.
E1h		Initializing the interrupt vector table next.
E2h		Initializing the DMA and Interrupt controllers next.
E6h		Enabling the floppy drive controller and Timer IRQs. Enabling internal cache memory.
Edh		Initializing the floppy drive.
Eeh		Looking for a floppy diskette in drive A:. Reading the first sector of the diskette.
Efh		A read error occurred while reading the floppy drive in drive A:.
F0h		Next, searching for the AMIBOOT.ROM file in the root directory.
F1h		The AMIBOOT.ROM file is not in the root directory.
F2h		Next, reading and analyzing the floppy diskette FAT to find the clusters occupied by the AMIBOOT.ROM file.
F3h		Next, reading the AMIBOOT.ROM file, cluster by cluster.
F4h		The AMIBOOT.ROM file is not the correct size.
F5h		Next, disabling internal cache memory.
FBh		Next, detecting the type of flash ROM.
FC		Next, erasing the flash ROM.
FDh		Next, programming the flash ROM.
FFh		Flash ROM programming was successful. Next, restarting the system BIOS.

B-3 Uncompressed Initialization Codes

The following runtime checkpoint codes are listed in order of execution.

These codes are uncompressed in F0000h shadow RAM.

Checkpoint	Code	Description
03h		The NMI is disabled. Next, checking for a soft reset or a power on condition.
05h		The BIOS stack has been built. Next, disabling cache memory.
06h		Uncompressing the POST code next.
07h		Next, initializing the CPU and the CPU data area.
08h		The CMOS checksum calculation is done next.
0Ah		The CMOS checksum calculation is done. Initializing the CMOS status register for date and time next.
0Bh		The CMOS status register is initialized. Next, performing any required initialization before the keyboard BAT command is issued.
0Ch		The keyboard controller input buffer is free. Next, issuing the BAT command to the keyboard controller.
0Eh		The keyboard controller BAT command result has been verified. Next, performing any necessary initialization after the keyboard controller BAT command test.
0Fh		The initialization after the keyboard controller BAT command test is done. The keyboard command byte is written next.
10h		The keyboard controller command byte is written. Next, issuing the Pin 23 and 24 blocking and unblocking command.
11h		Next, checking if <End> or <Ins> keys were pressed during power on.

	Initializing CMOS RAM if the <i>Initialize CMOS RAM in every boot</i> AMIBIOS POST option was set in AMIBCP or the <End> key was pressed.
12h	Next, disabling DMA controllers 1 and 2 and interrupt controllers 1 and 2.
13h	The video display has been disabled. Port B has been initialized. Next, initializing the chipset.
14h	The 8254 timer test will begin next.
19h	The 8254 timer test is over. Starting the memory refresh test next.
1Ah	The memory refresh line is toggling. Checking the 15 second on/off time next.
2Bh	Passing control to the video ROM to perform any required configuration before the video ROM test.
2Ch	All necessary processing before passing control to the video ROM is done. Looking for the video ROM next and passing control to it.
2Dh	The video ROM has returned control to BIOS POST. Performing any required processing after the video ROM had control.
23h	Reading the 8042 input port and disabling the MEGAKEY Green PC feature next. Making the BIOS code segment writable and performing any necessary configuration before initializing the interrupt vectors.
24h	The configuration required before interrupt vector initialization has completed. Interrupt vector initialization is about to begin.

Checkpoint	Code	Description
25h		Interrupt vector initialization is done. Clearing the password if the POST DIAG switch is on.
27h		Any initialization before setting video mode will be done next.
28h		Initialization before setting the video mode is complete. Configuring the monochrome mode and color mode settings next.
2Ah		Bus initialization system, static, output devices will be done next, if present. See the last page for additional information.
2Eh		Completed post-video ROM test processing. If the EGA/VGA controller is not found, performing the display memory read/write test next.
2Fh		The EGA/VGA controller was not found. The display memory read/write test is about to begin.
30h		The display memory read/write test passed. Look for retrace checking next.
31h		The display memory read/write test or retrace checking failed. Performing the alternate display memory read/write test next.
32h		The alternate display memory read/write test passed. Looking for alternate display retrace checking next.
34h		Video display checking is over. Setting the display mode next.
37h		The display mode is set. Displaying the power on message next.
38h		Initializing the bus input, IPL, general devices next, if present. See the last page of this chapter for additional information.
39h		Displaying bus initialization error messages. See the last page of this chapter for additional information.
3Ah		The new cursor position has been read and saved. Displaying the <i>Hit </i> message next.
3Bh		The <i>Hit </i> message is displayed. The protected mode memory test is about to start.
40h		Preparing the descriptor tables next.
42h		The descriptor tables are prepared. Entering protected mode for the memory test next.
43h		Entered protected mode. Enabling interrupts for diagnostics mode next.
44h		Interrupts enabled if the diagnostics switch is on. Initializing data to check memory wraparound at 0:0 next.
45h		Data initialized. Checking for memory wraparound at 0:0 and finding the total system memory size next.
46h		The memory wraparound test is done. Memory size calculation has been done. Writing patterns to test memory next.
47h		The memory pattern has been written to extended memory. Writing patterns to the base 640 KB memory next.
48h		Patterns written in base memory. Determining the amount of memory below 1 MB next.
49h		The amount of memory below 1 MB has been found and verified. Determining the amount of memory above 1 MB memory next.

Checkpoint	Code	Description
4Bh		The amount of memory above 1 MB has been found and verified. Checking for a soft reset and clearing the memory below 1 MB for the soft reset next. If this is a power on situation, going to checkpoint 4Eh next.
4Ch		The memory below 1 MB has been cleared via a soft reset. Clearing the memory above 1 MB next.
4Dh		The memory above 1 MB has been cleared via a soft reset. Saving the memory size next. Going to checkpoint 52h next.
4Eh		The memory test started, but not as the result of a soft reset. Displaying the first 64 KB memory size next.
4Fh		The memory size display has started. The display is updated during the memory test. Performing the sequential and random memory test next.
50h		The memory below 1 MB has been tested and initialized. Adjusting the displayed memory size for relocation and shadowing next.
51h		The memory size display was adjusted for relocation and shadowing. Testing the memory above 1 MB next.
52h		The memory above 1 MB has been tested and initialized. Saving the memory size information next.
53h		The memory size information and the CPU registers are saved. Entering real mode next.
54h		Shutdown was successful. The CPU is in real mode. Disabling the Gate A20 line, parity, and the NMI next.
57h		The A20 address line, parity, and the NMI are disabled. Adjusting the memory size depending on relocation and shadowing next.
58h		The memory size was adjusted for relocation and shadowing. Clearing the <i>Hit </i> message next.
59h		The <i>Hit </i> message is cleared. The <i><WAIT...></i> message is displayed. Starting the DMA and interrupt controller test next.

Checkpoint	Code Description
60h	The DMA page register test passed. Performing the DMA Controller 1 base register test next.
62h	The DMA controller 1 base register test passed. Performing the DMA controller 2 base register test next.
65h	The DMA controller 2 base register test passed. Programming DMA controllers 1 and 2 next.
66h	Completed programming DMA controllers 1 and 2. Initializing the 8259 interrupt controller next.
67h	Completed 8259 interrupt controller initialization.
7Fh	Extended NMI source enabling is in progress.
80h	The keyboard test has started. Clearing the output buffer and checking for stuck keys. Issuing the keyboard reset command next.
81h	A keyboard reset error or stuck key was found. Issuing the keyboard controller interface test command next.
82h	The keyboard controller interface test completed. Writing the command byte and initializing the circular buffer next.
83h	The command byte was written and global data initialization has completed. Checking for a locked key next.
84h	Locked key checking is over. Checking for a memory size mismatch with CMOS RAM data next.
85h	The memory size check is done. Displaying a soft error and checking for a password or bypassing WINBIOS Setup next.
86h	The password was checked. Performing any required programming before WINBIOS Setup next.
87h	The programming before WINBIOS Setup has completed. Uncompressing the WINBIOS Setup code and executing the AMIBIOS Setup or WINBIOS Setup utility next.
88h	Returned from WINBIOS Setup and cleared the screen. Performing any necessary programming after WINBIOS Setup next.

Checkpoint	Code	Description
89h		The programming after WINBIOS Setup has completed. Displaying the power on screen message next.
8Bh		The first screen message has been displayed. The <WAIT...> message is displayed. Performing the PS/2 mouse check and extended BIOS data area allocation check next.
8Ch		Programming the WINBIOS Setup options next.
8Dh		The WINBIOS Setup options are programmed. Resetting the hard disk controller next.
8Fh		The hard disk controller has been reset. Configuring the floppy drive controller next.
91h		The floppy drive controller has been configured. Configuring the hard disk drive controller next.
95h		Initializing the bus option ROMs from C800 next. See the last page of this chapter for additional information.
96h		Initializing before passing control to the adaptor ROM at C800.
97h		Initialization before the C800 adaptor ROM gains control has completed. The adaptor ROM check is next.
98h		The adaptor ROM had control and has now returned control to BIOS POST. Performing any required processing after the option ROM returned control.
99h		Any initialization required after the option ROM test has completed. Configuring the timer data area and printer base address next.
9Ah		Set the timer and printer base addresses. Setting the RS-232 base address next.

Checkpoint	Code Description
9Bh	Returned after setting the RS-232 base address. Performing any required initialization before the Coprocessor test next.
9Ch	Required initialization before the Coprocessor test is over. Initializing the Coprocessor next.
9Dh	Coprocessor initialized. Performing any required initialization after the Coprocessor test next.
9Eh	Initialization after the Coprocessor test is complete. Checking the extended keyboard, keyboard ID, and Num Lock key next. Issuing the keyboard ID command next.
A2h	Displaying any soft errors next.
A3h	The soft error display has completed. Setting the keyboard typematic rate next.
A4h	The keyboard typematic rate is set. Programming the memory wait states next.
A5h	Memory wait state programming is over. Clearing the screen and enabling parity and the NMI next.
A7h	NMI and parity enabled. Performing any initialization required before passing control to the adaptor ROM at E000 next.
A8h	Initialization before passing control to the adaptor ROM at E000h completed. Passing control to the adaptor ROM at E000h next.
A9h	Returned from adaptor ROM at E000h control. Performing any initialization required after the E000 option ROM had control next.
Aah	Initialization after E000 option ROM control has completed. Displaying the system configuration next.
Abh	Uncompressing the DMI data and executing DMI POST initialization next.
B0h	The system configuration is displayed.
B1h	Copying any code to specific areas.
00h	Code copying to specific areas is done. Passing control to INT 19h boot loader next.

B-4 Bus Checkpoint Codes

The system BIOS passes control to different buses at the following checkpoints:

Checkpoint	Code	Description
2Ah		Initializing the different bus system, static, and output devices, if present.
38h		Initialized bus input, IPL, and general devices, if present.
39h		Displaying bus initialization error messages, if any.
95h		Initializing bus adaptor ROMs from C8000h through D8000h.

Additional Bus Checkpoints

While control is inside the different bus routines, additional checkpoints are output to I/O port address 0080h as word to identify the routines being executed. These are word checkpoints.

The low byte of checkpoint is the system BIOS checkpoint where control is passed to the different bus routines.

The high byte of checkpoint indicates that the routine is being executed in Different buses.

High Byte

The high byte of these checkpoints includes the following information:

Bits	Description
Bits 7-4	
0000	Function 0. Disable all devices on the bus.
0001	Function 1. Initialize static devices on the bus.
0010	Function 2. Initialize output devices on the bus.
0011	Function 3. Initialize input devices on the bus.
0100	Function 4. Initialize IPL devices on the bus.
0101	Function 5. Initiate general devices on the bus.
0110	Function 6. Initialize error reporting on the bus.
0111	Function 7. Initialize add-on ROMs for all buses.

Bits 3-0 Specify the bus	
0	Generic DIM Device Initialization Manager.
1	Onboard System devices.
2	ISA devices.
3	EISA devices.
4	ISA PnP devices.
5	PCI devices.

Notes