

SUPERO[®]

SUPER PIIDR3
SUPER PIIDRE

USER'S MANUAL

Revision 2.0

The information in this User's Manual has been carefully reviewed and is believed to be accurate. The vendor assumes no responsibility for any inaccuracies that may be contained in this document, makes no commitment to update or to keep current the information in this manual, or to notify any person or organization of the updates. **Please Note: For the most up-to-date version of this manual, please see our web site at www.supermicro.com.**

SUPERMICRO COMPUTER reserves the right to make changes to the product described in this manual at any time and without notice. This product, including software, if any, and documentation may not, in whole or in part, be copied, photocopied, reproduced, translated or reduced to any medium or machine without prior written consent.

IN NO EVENT WILL SUPERMICRO COMPUTER BE LIABLE FOR DIRECT, INDIRECT, SPECIAL, INCIDENTAL, OR CONSEQUENTIAL DAMAGES ARISING FROM THE USE OR INABILITY TO USE THIS PRODUCT OR DOCUMENTATION, EVEN IF ADVISED OF THE POSSIBILITY OF SUCH DAMAGES. IN PARTICULAR, THE VENDOR SHALL NOT HAVE LIABILITY FOR ANY HARDWARE, SOFTWARE, OR DATA STORED OR USED WITH THE PRODUCT, INCLUDING THE COSTS OF REPAIRING, REPLACING, INTEGRATING, INSTALLING OR RECOVERING SUCH HARDWARE, SOFTWARE, OR DATA.

Any disputes arising between manufacturer and customer shall be governed by the laws of Santa Clara County in the State of California, USA. The State of California, County of Santa Clara shall be the exclusive venue for the resolution of any such disputes. Supermicro's total liability for all claims will not exceed the price paid for the hardware product.

Unless you request and receive written permission from SUPER MICRO COMPUTER, you may not copy any part of this document.

Information in this document is subject to change without notice. Other products and companies referred to herein are trademarks or registered trademarks of their respective companies or mark holders.

Copyright © 2000 by SUPER MICRO COMPUTER INC.
All rights reserved.

Printed in the United States of America.

Preface

About This Manual

This manual is written for system integrators, PC technicians and knowledgeable PC users. It provides information for the installation and use of the SUPER PIIIDR3/PIIIDRE motherboard. The SUPER PIIIDR3/PIIIDRE supports single or dual Pentium® II 350-450 MHz and Pentium III 450-933 MHz processors. Please refer to the support section of our web site (<http://www.supermicro.com/TechSupport.htm>) for a complete listing of supported processors.

Pentium II processors with the Dual Independent Bus (DIB) architecture are housed in a package called a Single Edge Contact Cartridge (SECC). Pentium III processors are packaged in SECC2 type cartridges.

Manual Organization

Chapter 1 includes a checklist of what should be included in your mainboard box, describes the layout, specifications and features of the SUPER PIIIDR3/PIIIDRE mainboard and provides detailed information about the chipset.

Chapter 2 begins with instructions on handling static-sensitive devices. Read this chapter when you want to install the processor and RIMM memory modules and when mounting the mainboard in the chassis. Also refer to this chapter to connect the floppy and hard disk drives, SCSI drives, the IDE interfaces, the parallel and serial ports and the twisted wires for the power supply, the reset button, the keylock/power LED, the speaker and the keyboard.

If you encounter any problems, see **Chapter 3**, which describes troubleshooting procedures for the video, the memory and the setup configuration stored in CMOS. For quick reference, a general FAQ [Frequently Asked Questions] section is provided. Instructions are also included for contacting technical support. In addition, you can visit our web site at www.supermicro.com/techsupport.htm for more detailed information.

Chapter 4 includes an introduction to the BIOS used in the PIIIDR3/PIIIDRE and provides detailed information on the CMOS Setup utility.

Appendix A offers information on BIOS error beep codes and messages.

Appendix B provides post diagnostic error messages.

Table of Contents

Preface

About This Manual	iii
Manual Organization	iii

Chapter 1: Introduction

1-1 Overview	1-1
Checklist	1-1
Contacting Supermicro	1-2
SUPER PIIIDR3 Image	1-4
SUPER PIIIDRE Image	1-5
SUPER PIIIDR3 Layout	1-6
SUPER PIIIDRE Layout	1-8
840 Chipset: System Block Diagram	1-10
Motherboard Features	1-11
1-2 Chipset Overview	1-13
1-3 PC Health Monitoring	1-14
1-4 ACPI/PC 98 Features	1-16
1-5 Power Supply	1-18
1-6 Super I/O	1-18

Chapter 2: Installation

2-1 Static-Sensitive Devices	2-1
2-2 Processor Installation	2-2
2-3 Mounting the Motherboard in the Chassis	2-3
2-4 Installing RIMMs	2-4
2-5 Port/Control Panel Connector Locations	2-6,7
2-6 Connecting Cables	2-8
Power Supply Connector	2-8
Secondary Power Connector	2-8
Power LED	2-8
Hard Drive LED	2-8
PWR_ON	2-9
NIC_LED	2-9
Reset	2-9
I ² C	2-9
Chassis Intrusion	2-10
Keyboard Lock	2-10

Overheat LED	2-10
Extra Universal Serial Bus Connection	2-10
Speaker	2-11
Infrared Header	2-11
Fan Headers	2-11
Serial Ports	2-11
ATX PS/2 Keyboard and Mouse Ports	2-12
Universal Serial Bus Connector	2-12
CD Headers	2-12
Wake-On-LAN	2-12
Wake-On-Ring	2-13
Extra Chassis Intrusion Header	2-13
Power Supply Fail Header	2-13
SLED1 (SCSI LED) Indicator	2-14
2-7 Jumper Settings	2-14
CMOS Clear	2-14
Front Side Bus Speed	2-15
Host Bus ECC	2-15
AC'97 Enable/Disable	2-15
SCSI Termination Enable/Disable	2-16
Overheat Alarm Enable/Disable	2-16
Onboard LAN/NIC Enable/Disable	2-16
Power Supply Failure Alarm Enable/Disable	2-17
2-8 Parallel Port/Floppy/Hard Disk Drive/AGP Port/SCSI Connections	2-17
Parallel Port Connector	2-18
Floppy Connector	2-18
IDE Connectors	2-18
AGP Pro Slot	2-19
50-pin Legacy SCSI Connector	2-19
Ultra Wide SCSI Connector	2-20
Ultra160 SCSI Connectors	2-21
2-9 Installing Software Drivers	2-22

Chapter 3: Troubleshooting

3-1 Troubleshooting Procedures	3-1
Before Power On	3-1
No Power	3-1
No Video	3-1
Memory Errors	3-2

Losing the System's Setup Configuration	3-2
3-2 Technical Support Procedures	3-2
3-3 Frequently Asked Questions	3-3
3-4 Returning Merchandise for Service	3-6

Chapter 4: BIOS

4-1 Introduction	4-1
4-2 BIOS Features	4-2
4-3 Running Setup	4-2
Standard CMOS Setup	4-4
Advanced CMOS Setup	4-5
Advanced Chipset Setup	4-9
Power Management	4-11
PCI/Plug and Play Setup	4-14
Peripheral Setup	4-17
Auto-Detect Hard Disks	4-19
Change User/Supervisor Password	4-19
Change Language Setting	4-20
Auto Configuration with Optimal Settings	4-20
Auto Configuration with Fail Safe Settings	4-20
Save Settings and Exit.....	4-20
Exit Without Saving	4-21

Appendices:

Appendix A: BIOS Error Beep Codes and Messages	A-1
Appendix B: AMIBIOS Post Diagnostic Error Messages	B-1

Notes

Chapter 1

Introduction

1-1 Overview

Checklist

Congratulations on purchasing your computer motherboard from an acknowledged leader in the industry. Supermicro boards are designed with the utmost attention to detail to provide you with the highest standards in quality and performance.

Please check that the following items have all been included with your motherboard. If anything listed here is damaged or missing, contact your retailer.

One (1) Supermicro Mainboard

One (1) ATA66 ribbon cable for IDE devices

One (1) floppy ribbon cable for (1) 5.25-inch and (2) 3.5-inch floppy drives

One (1) serial COM 2 cable

One (1) I/O backpanel shield

SCSI accessories (for PIIDR3 only)

One (1) 50-pin Ultra SCSI cable

One (1) 68-pin Ultra Wide SCSI cable

One (1) 68-pin LVD SCSI cable

One (1) set of SCSI driver diskettes

One (1) SCSI manual

One (1) Supermicro CD containing drivers and utilities

One (1) URM (Universal Retention Mechanism for the CPU - preinstalled)

One (1) User's/BIOS Manual

CONTACTING SUPERMICRO

Headquarters

Address: Super Micro Computer, Inc.
2051 Junction Avenue
San Jose, CA 95131 U.S.A.

Tel: +1 (408) 895-2001

Fax: +1 (408) 895-2008

E-mail: marketing@supermicro.com (General Information)
support@supermicro.com (Technical Support)

Web site: www.supermicro.com

European Office

Address: Super Micro Computer B.V.
Het Sterrenbeeld 28, 5215 ML,
's-Hertogenbosch, The Netherlands

Tel: +31 (0) 73-6400390

Fax: +31 (0) 73-6416525

E-mail: sales@supermicro.nl (General Information)
support@supermicro.nl (Technical Support)
rma@supermicro.nl (Customer Support)

Notes

SUPER PIIIDR3

Figure 1-1. SUPER PIIIDR3 Image

SUPER PIIIDRE

Figure 1-2. SUPER PIIIDRE Image

Figure 1-3. SUPER PIIIDR3 Layout
(not drawn to scale)

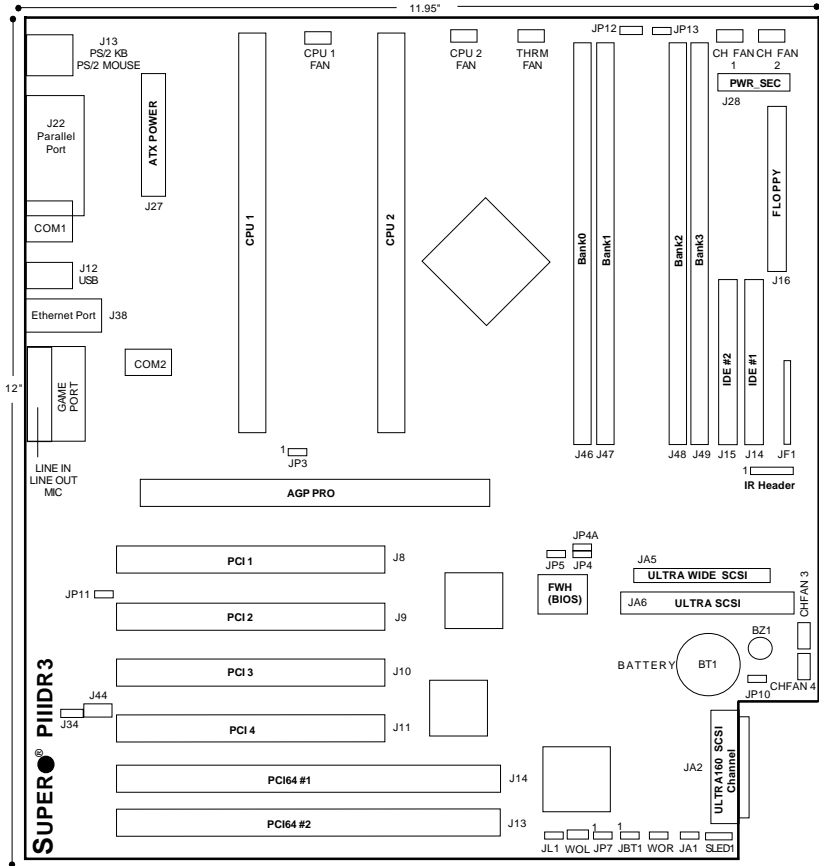

Also see the figure on page 2-6 for the locations of the I/O ports and 2-7 for the Front Control Panel (JF1) connectors.

<u>Jumpers</u>	<u>Description</u>	<u>Default Setting</u>
JA1	SCSI Termination (p. 2-16)	Open (Enabled)
JBT1	CMOS Clear (p. 2-14)	Pin 1-2 (Normal)
JP3	Front Side Bus Speed (p. 2-15)	Pin 1-2 (CPU Select)
JP4/4A	Manufacturer's Setting	Pin 1-2
JP5	Host Bus ECC (p. 2-15)	Closed (Enabled)
JP7	AC97 Audio (p. 2-15)	Pin 1-2 (Enabled)
JP10	Overheat Alarm (p. 2-16)	Closed (Enabled)
JP11	Onboard LAN/NIC (p. 2-16)	Closed (Enabled)
JP13	P/S Failure Alarm (p. 2-17)	Open (Disabled)

<u>Connectors</u>	<u>Description</u>
CHASSIS FAN1	Primary Chassis Fan Header (p. 2-11)
CHASSIS FAN2	Secondary Chassis Fan Header (p. 2-11)
COM1/COM2	COM1/COM2 Serial Port Conn/Hdr (p. 2-11)
CPU1/CPU2 FAN	CPU1/CPU2 Fan Header (p. 2-11)
GAME	Game Port
IR Header	Infrared Device Header (p. 2-11)
J46, J47, J48, J49	Memory (RAM) Slots (p. 2-4)
J12	Universal Serial Bus Ports (p. 2-12)
J13	PS/2 Keyboard/Mouse (p. 2-12)
J14, J15	IDE Hard Disk Drive Connectors (p. 2-18)
J16	Floppy Disk Drive Connector (p. 2-18)
J22	Parallel Printer Port (p. 2-18)
J27	ATX Power Connector (p. 2-8)
J34	Audio CD Input (small connector) (p. 2-12)
J38	Ethernet Port
JA2	Ultra160 SCSI Connector (p. 2-21)
JA5	Ultra Wide SCSI Connector (p. 2-20)
JA6	Ultra (Legacy) SCSI Connector (p. 2-19)
J44	Audio CD Input (large connector) (p. 2-12)
JP1	Front Control Panel (p. 2-7)
JL1	Chassis Intrusion Header (p. 2-13)
JP12	Power Supply Fail Header (p. 2-13)
LINE IN	Audio In Connector
LINE OUT	Audio Out (Speaker) Connector
MIC	Microphone Input
PWR_SEC	Secondary ATX Power Connector (p. 2-8)
SLED1	SCSI LED Indicator (p. 2-14)
THRM FAN	Thermal Control Fan Header (p. 2-11)
WOL	Wake-on-LAN Header (p. 2-12)
WOR	Wake-on-Ring Header (p. 2-13)

Figure 1-4. SUPER PIIIDRE Layout
(not drawn to scale)

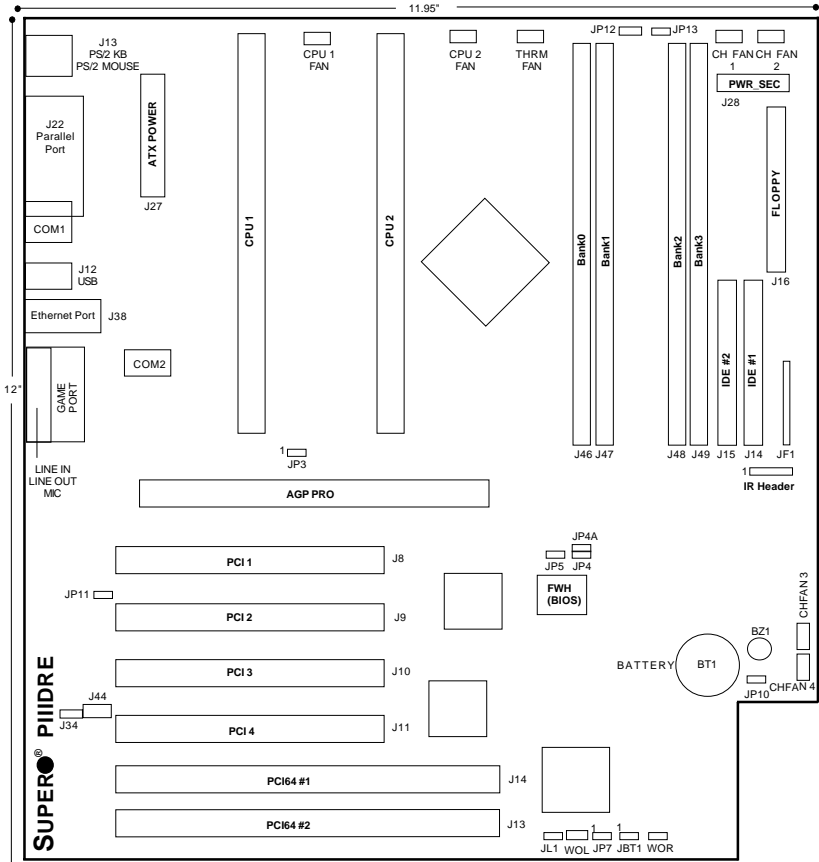

Also see the figure on page 2-6 for the locations of the I/O ports and 2-7 for the Front Control Panel (JF1) connectors.

<u>Jumpers</u>	<u>Description</u>	<u>Default Setting</u>
JBT1	CMOS Clear (p. 2-14)	Pin 1-2 (Normal)
JP3	Front Side Bus Speed (p. 2-15)	Pin 1-2 (CPU Select)
JP4/4A	Manufacturer's Setting	Pin 1-2
JP5	Host Bus ECC (p. 2-15)	Closed (Enabled)
JP7	AC97 Audio (p. 2-15)	Pin 1-2 (Enabled)
JP10	Overheat Alarm (p. 2-16)	Closed (Enabled)
JP11	Onboard LAN/NIC (p. 2-16)	Closed (Enabled)
JP13	P/S Failure Alarm (p. 2-17)	Open (Disabled)

<u>Connectors</u>	<u>Description</u>
CHASSIS FAN1	Primary Chassis Fan Header (p. 2-11)
CHASSIS FAN2	Secondary Chassis Fan Header (p. 2-11)
COM1/COM2	COM1/COM2 Serial Port Conn/Hdr (p. 2-11)
CPU1/CPU2 FAN	CPU1/CPU2 Fan Header (p. 2-11)
GAME	Game Port
IR Header	Infrared Device Header (p. 2-11)
J46, J47, J48, J49	Memory (RAM) Slots (p. 2-4)
J12	Universal Serial Bus Ports (p. 2-12)
J13	PS/2 Keyboard/Mouse (p. 2-12)
J14, J15	IDE Hard Disk Drive Connectors (p. 2-18)
J16	Floppy Disk Drive Connector (p. 2-18)
J22	Parallel Printer Port (p. 2-18)
J27	ATX Power Connector (p. 2-8)
J34	Audio CD Input (small connector) (p. 2-12)
J38	Ethernet Port
J44	Audio CD Input (large connector) (p. 2-12)
JF1	Front Control Panel (p. 2-7)
JL1	Chassis Intrusion Header (p. 2-13)
JP12	Power Supply Fail Header (p. 2-13)
LINE IN	Audio In Connector
LINE OUT	Audio Out (Speaker) Connector
MIC	Microphone Input
PWR_SEC	Secondary ATX Power Connector (p. 2-8)
THRM FAN	Thermal Control Fan Header (p. 2-11)
WOL	Wake-on-LAN Header (p. 2-12)
WOR	Wake-on-Ring Header (p. 2-13)

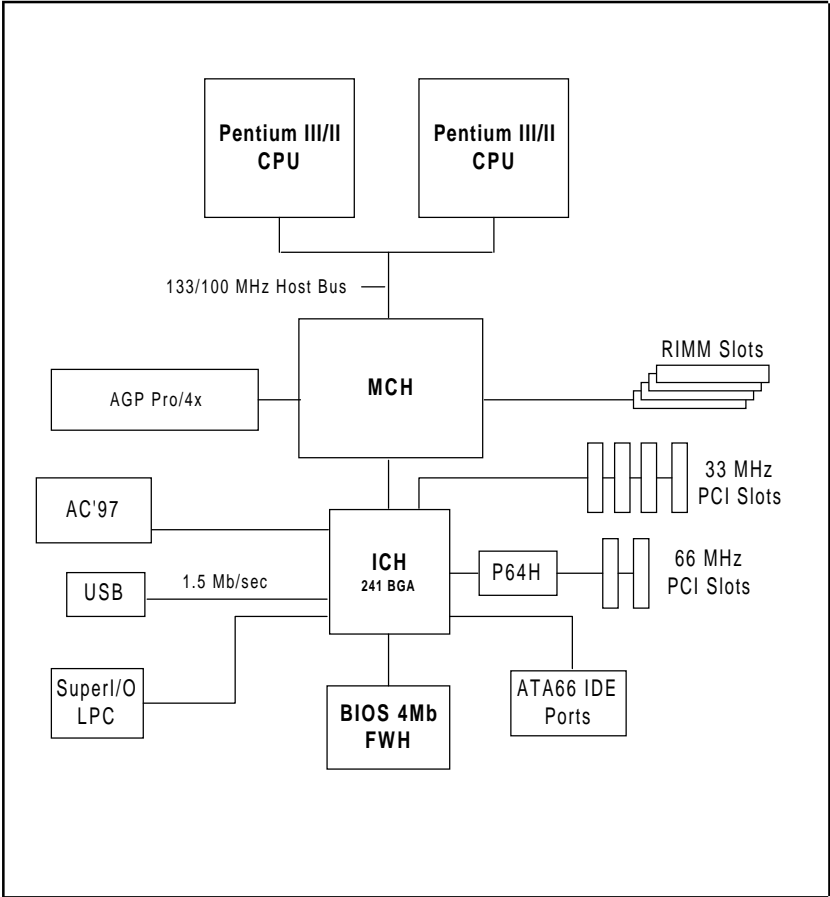

**Figure 1-5. 840 Chipset:
System Block Diagram**

NOTE: See the following page for the actual specifications of each motherboard.

Features of the PIIIDR3/PIIIDRE

CPU

- Single or dual Pentium II 350-450 MHz processors at 100 MHz bus speed or single or dual Pentium III 450-933 MHz processors at 133/100 MHz bus speed **Note:** Please refer to the support section of our web site for a complete listing of supported processors. (<http://www.supermicro.com/TechSupport.htm>)

Memory

- Four 184-pin RIMM sockets supporting up to 2 GB RAMBUS
Note: Please see page 3-3 for details on supported memory.

Chipset

- Intel 840-ICH (see page 1-13 for details)

Expansion Slots

- Two 64-bit, 66 MHz PCI slots
- Four 32-bit, 33 MHz PCI slots
- 1 AGP Pro/4xAGP slot

BIOS

- 4 Mb Firmware Hub AMI® Flash BIOS
- APM 1.2, DMI 2.1, PCI 2.2, ACPI 1.0, Plug and Play (PnP)

PC Health Monitoring

- Seven onboard voltage monitors for CPU core, chipset voltage, +3.3V, ±5V and ±12V
- Four-fan status monitor with firmware/software on/off control
- Environmental temperature monitor and control
- CPU fan auto-off in sleep mode
- Power-up mode control for recovery from AC power loss
- System overheat LED and control
- System resource alert
- Hardware BIOS virus protection
- Auto-switching voltage regulator for the CPU core

ACPI/PC 98 Features

- Microsoft OnNow
- Slow blinking LED for suspend state indicator

- BIOS support for USB keyboard
- Real-time clock wake-up alarm
- Main switch override mechanism
- External modem ring-on
- STR (Suspend to RAM)

Onboard I/O

- AIC-7892 for single channel Ultra160 SCSI (PIIIDR3 only)
- 2 EIDE bus master interfaces support Ultra DMA/66
- 1 floppy port interface (up to 2.88 MB)
- 2 Fast UART 16550A compatible serial ports
- 1 EPP (Enhanced Parallel Port) and ECP (Extended Capabilities Port) supported parallel port
- PS/2 mouse and PS/2 keyboard ports
- 1 infrared port
- 2 USB (Universal Serial Bus) ports

Other

- AOL2 (see page 1-14)
- Selectable CPU and chassis fan speed control (set in BIOS)
- Internal/external modem ring-on
- Recovery from AC power loss control
- Wake-on-LAN (WOL)
- Multiple FSB clock frequency selections (set in BIOS)

CD Utilities

- BIOS flash upgrade utility
- Drivers for 840 chipset utilities

Dimensions

- SUPER PIIIDR3 - Extended ATX: 12" x 11.95" (305 x 304 mm)
- SUPER PIIIDRE - Extended ATX: 12" x 11.95" (305 x 304 mm)

1-2 Chipset Overview

Intel's 840 chipset is based on the new modular design introduced by the 800 series chipsets and consisting of three main components. The 82840 Memory Controller Hub (MCH) provides support for 4x/2xAGP and AGP Pro. (AGP Pro is a superset of 4xAGP.) An 82801 I/O Controller Hub (ICH) connects the PCI slots, IDE controllers and USB ports to the MCH via an accelerated hub architecture. The third main component is the 82802 Firmware Hub (FWH), which stores both system and video BIOS and includes a Random Number Generator (RNG).

Memory Controller Hub (MCH)

The MCH includes the host (CPU) interface, DRAM interface, ICH interface, 4xAGP interface and P64 interface for the 840 chipset. It contains advanced power management logic and supports dual channels for DRAM. The AGP 2.0 interface supports 4x data transfer and 2x/4x fast write capability and operates at a peak bandwidth of 266 MB/sec. The MCH host interface bus (or front side bus) runs at 133/100 MHz.

I/O Controller Hub (ICH)

The ICH is the Controller Hub for the I/O subsystem and integrates many of the Input/Output functions of the 840 chipset, including a two-channel UDMA/66 Bus Master IDE controller. It also provides the interface to the PCI bus and communicates with the MCH over a dedicated hub interface.

Firmware Hub (FWH)

The FWH is a component that brings added security and manageability to the PC platform infrastructure. This device includes an integrated Random Number Generator (RNG) for stronger encryption, digital signing and security protocols. The FWH stores the system BIOS and video BIOS to eliminate a redundant nonvolatile memory component.

PCI 64-bit Hub (P64H)

The P64H chip provides a bridge between the MCH and the PCI bus. It has a 16-bit primary hub interface to the MCH and a secondary 64-bit PCI Bus interface, which supports both 64-bit and 32-bit PCI devices. The P64H is PCI 2.2 compliant.

Suspend to RAM (STR)

When the system goes into a sleep state, power is removed from most of the system components but can remain supplied to RAM to quickly restore the system to its previous state of operation. Because system restoration happens in only ~5 seconds, applications that were open before the sleep state can reopen for immediate access. In STR, all data in system memory is stored in RAM when the system is suspended and system power is turned off (the power supply fan also shuts off). You must be running ACPI for this feature to take effect (see Section 1-4 for details on initiating ACPI). All drivers and add-on cards must be ACPI supported for STR to function. Note: STR only works with a single processor installed.

Alert on LAN 2 (AOL2)

AOL2 ASIC brings an advanced level of management interface between a remote management console/server and the client system. It provides interfaces to the 82559 Ethernet controller chip and to system monitoring devices. AOL2 can send "Alert" messages to the management console to notify administrators of important events or problems such as high temperatures, chassis intrusion and voltages exceeding safe margins.

Recovery from AC Power Loss

BIOS provides a setting for you to determine how the system will respond when AC power is lost and then restored to the system. You can choose for the system to remain powered off (in which case you must hit the power switch to turn it back on) or for it to automatically return to a power on state. See the Power Lost Control setting in the BIOS chapter of this manual to change this setting. The default setting is Always OFF.

1-3 PC Health Monitoring

This section describes the PC health monitoring features of the SUPER PIIIDR3/PIIIDRE. Both have an onboard System Hardware Monitor chip that supports PC health monitoring.

Seven Onboard Voltage Monitors for the CPU Core, Chipset Voltage, +3.3V, $\pm 5V$ and $\pm 12V$

The onboard voltage monitor will scan these seven voltages continuously. Once a voltage becomes unstable, it will give a warning or send an error

message to the screen. Users can adjust the voltage thresholds to define the sensitivity of the voltage monitor.

Four-Fan Status Monitor with Firmware/Software On/Off Control

The PC health monitor can check the RPM status of the cooling fans. The onboard 3-pin CPU and chassis fans are controlled by the power management functions. The thermal fan is controlled by the overheat detection logic.

Environmental Temperature Control

The thermal control sensor monitors the CPU temperature in real time and will turn on the thermal control fan whenever the CPU temperature exceeds a user-defined threshold. The overheat circuitry runs independently from the CPU. It can continue to monitor for overheat conditions even when the CPU is in sleep mode. Once it detects that the CPU temperature is too high, it will automatically turn on the thermal control fan to prevent any overheat damage to the CPU. The onboard chassis thermal circuitry can monitor the overall system temperature and alert users when the chassis temperature is too high.

CPU Fan Auto-Off in Sleep Mode

The CPU fan activates when the power is turned on. It can be turned off when the CPU is in sleep mode. When in sleep mode, the CPU will not run at full power, thereby generating less heat.

CPU Overheat LED and Control

This feature is available when the user enables the CPU overheat warning function in the BIOS. This allows the user to define an overheat temperature. When this temperature is exceeded, both the overheat fan and the warning LED are triggered.

System Resource Alert

This feature is available when used with Intel's LANDesk Client Manager (optional) to notify the user of certain system events. For example, if the system is running low on virtual memory and there is insufficient hard drive space for saving the data, you can be alerted of the potential problem.

Hardware BIOS Virus Protection

The system BIOS is protected by hardware so that no virus can infect the BIOS area. The user can only change the BIOS content through the flash utility provided by SUPERMICRO. This feature can prevent viruses from infecting the BIOS area and destroying valuable data.

Auto-Switching Voltage Regulator for the CPU Core

The auto-switching voltage regulator for the CPU core can support up to 20A current and auto-sense voltage IDs ranging from 1.3V to 3.5V. This will allow the regulator to run cooler and thus make the system more stable.

1-4 ACPI/PC 98 Features

ACPI stands for Advanced Configuration and Power Interface. The ACPI specification defines a flexible and abstract hardware interface that provides a standard way to integrate power management features throughout a PC system, including its hardware, operating system and application software. This enables the system to automatically turn on and off peripherals such as CD-ROMs, network cards, hard disk drives and printers. This also includes consumer devices connected to the PC such as VCRs, TVs, telephones and stereos.

In addition to enabling operating system-directed power management, ACPI provides a generic system event mechanism for Plug and Play and an operating system-independent interface for configuration control. ACPI leverages the Plug and Play BIOS data structures while providing a processor architecture-independent implementation that is compatible with both Windows 98 and Windows NT 5.0. **Note:** To utilize ACPI, you must reinstall Windows 98. To reinstall Windows 98 with ACPI, enter DOS and type "setup /p J" at the CDROM prompt (usually D:\) with the Windows 98 CD loaded. (Make sure you include the spaces after "setup" and "p".) Then hit <Enter>. You can check to see if ACPI has been properly installed by looking for it in the Device Manager, which is located in the Control Panel in Windows.

Microsoft OnNow

The OnNow design initiative is a comprehensive, system-wide approach to system and device power control. OnNow is a term for a PC that is always on but appears to be off and responds immediately to user or other re-

quests.

Slow Blinking LED for Suspend-State Indicator

When the CPU goes into a suspend state, the chassis power LED will start blinking to indicate that the CPU is in suspend mode. When the user presses any key, the CPU will wake-up and the LED will automatically stop blinking and remain on.

BIOS Support for USB Keyboard

If a USB keyboard is the only keyboard in the system, it will work like a normal keyboard during system boot-up.

Real Time Clock Wake-Up Alarm

Although the PC may appear to be off when not in use, it is still capable of responding to preset wake-up events. In the BIOS, the user can set a timer to wake-up the system at a predetermined time.

Main Switch Override Mechanism

When an ATX power supply is used, the power button can function as a system suspend button. When the user depresses the power button, the system will enter a SoftOff state. The monitor will be suspended and the hard drive will spin down. Depressing the power button again will cause the whole system to wake-up. During the SoftOff state, the ATX power supply provides power to keep the required circuitry in the system alive. In case the system malfunctions and you want to turn off the power, just depress and hold the power button for 4 seconds. The power will turn off and no power will be provided to the motherboard.

External Modem Ring-On

Wake-up events can be triggered by a device such as the external modem ringing when the system is in the SoftOff state. Note that external modem ring-on can only be used with an ATX 2.01 (or above) compliant power supply.

Wake-On-LAN (WOL)

Wake-On-LAN is defined as the ability of a management application to remotely power up a computer that is powered off. Remote PC setup, updates and asset tracking can occur after hours and on weekends so that daily LAN traffic is kept to a minimum and users are not interrupted. The motherboards have a 3-pin header (WOL) to connect to the 3-pin header on a Network Interface Card (NIC) that has WOL capability. Wake-On-LAN must be enabled in BIOS. Note that Wake-On-Lan can only be used with an ATX 2.01 (or above) compliant power supply.

1-5 Power Supply

As with all computer products, a stable power source is necessary for proper and reliable operation. It is even more important for processors that have high CPU clock rates of 300 MHz and above.

The SUPER PIIIDR3/PIIIDRE accommodates ATX power supplies. Although most power supplies generally meet the specifications required by the CPU, some are inadequate.

It is strongly recommended that you use a high quality power supply that meets ATX power supply Specification 2.02 or above. Additionally, in areas where noisy power transmission is present, you may choose to install a line filter to shield the computer from noise. It is recommended that you also install a power surge protector to help avoid problems caused by power surges.

1-6 Super I/O

The disk drive adapter functions of the Super I/O chip include a floppy disk drive controller that is compatible with industry standard 82077/765, a data separator, write pre-compensation circuitry, decode logic, data rate selection, a clock generator, drive interface control logic and interrupt and DMA logic. The wide range of functions integrated onto the Super I/O greatly reduces the number of components required for interfacing with floppy disk drives. The Super I/O supports one 360 K, 720 K, 1.2 M, 1.44 M or 2.88 M disk drive and data transfer rates of 250 Kb/s, 500 Kb/s or 1 Mb/s.

It also provides two high-speed, 16550 compatible serial communication ports (UARTs), one of which supports serial infrared communication. Each UART includes a 16-byte send/receive FIFO, a programmable baud rate generator, complete modem control capability and a processor interrupt system. Both UARTs provide legacy speed with baud rate of up to 115.2 Kbps as well as an advanced speed with baud rates of 250 K, 500 K, or 1 Mb/s, which support higher speed modems.

The Super I/O supports one PC-compatible printer port (SPP), Bi-directional Printer Port (BPP), Enhanced Parallel Port (EPP) or Extended Capabilities Port (ECP).

The Super I/O provides functions that comply with ACPI (Advanced Configuration and Power Interface), which includes support of legacy and ACPI power management through an SMI or SCI function pin. It also features auto power management to reduce power consumption.

The IRQs, DMAs and I/O space resources of the Super I/O can flexibly adjust to meet ISA PnP requirements, which support ACPI and APM (Advanced Power Management).

Notes

Introduction

Chapter 2 Installation

2-1 Static-Sensitive Devices

Static-sensitive electrical discharge can damage electronic components. To prevent damage to your system board, it is important to handle it very carefully. The following measures are generally sufficient to protect your equipment from static discharge.

Precautions

- Use a grounded wrist strap designed to prevent static discharge.
- Touch a grounded metal object before removing the board from the antistatic bag.
- Handle the board by its edges only; do not touch its components, peripheral chips, memory modules or gold contacts.
- When handling chips or modules, avoid touching their pins.
- Put the motherboard and peripherals back into their antistatic bags when not in use.
- For grounding purposes, make sure your computer chassis provides excellent conductivity between the power supply, the case, the mounting fasteners and the motherboard.

Unpacking

The motherboard is shipped in antistatic packaging to avoid static damage. When unpacking the board, make sure the person handling it is static protected.

2-2 Processor Installation



When handling the processor package, avoid placing direct pressure on the label area of the fan.

The following pages cover the installation procedure. You should install the processor to the motherboard first, then install the motherboard in the chassis, then the memory and add-on cards, and finally the cables and drivers. Following the installation procedures in the order they appear in this chapter should eliminate the most common problems you may encounter. **IMPORTANT: Always connect the power cord last and always remove it before adding, removing or changing any hardware components.**

Heat Sink

Follow the instructions that came with your processor or heat sink to attach a heat sink to the processor. Your heat sink should have a 3-pin fan, which connects to the CPU 1/2 header. Make sure that good contact is made between the CPU cartridge and the heat sink, particularly with SECC2 Pentium III OEM packages. Insufficient contact will cause the processor to overheat, which may crash the system. Also, due to the high power consumption of the 840's MCH and MRH-S chips, the heat sinks on these chips must be provided with adequate airflow.

URM

Your motherboard has a preinstalled URM (Universal Retention Mechanism). A picture of a URM is shown in Figure 2-1. (This is one of several types - all of which can support SEPP, SECC and SECC2 packages.) Before installing your processor, you must flip the arms of the URM to their upright positions. Some URMs may have extra caps to be used for Pentium III processors (AMP URMs do not use these). After the processor is installed in the motherboard, place one of these caps (if included) on each end of the URM and push down until they snap into place. These caps are not left/right specific.

Processor

You are now ready to install the processor. Your motherboard has a Slot 1 type connector, which supports Celeron, Pentium II* and Pentium III processors housed in SEPP, SECC* and SECC2 packages, respectively. Please see the note on the following page when installing a Pentium II processor with the SECC package.

***Note:** The Pentium II processor comes in the SECC package, which has locking tabs on the top corners. Before installing the Pentium II package into the URM, push these two locks inward until you hear a click. (After you have fully seated the processor into the Slot 1 connector as instructed below, these locks should return to their outer positions.)

Arm (in upright position)

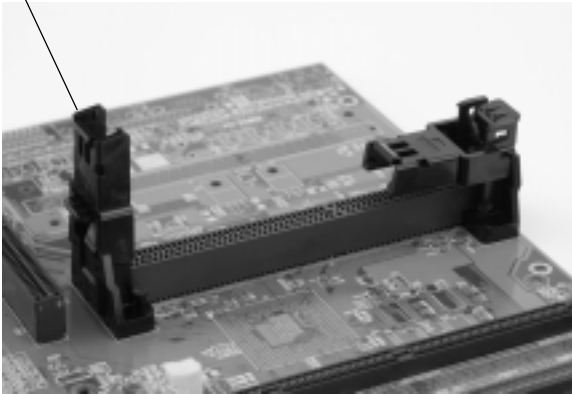

Figure 2-1. Universal Retention Mechanism (URM)

With the heat sink facing toward the memory slots, slide the SEPP/SECC/SECC2 processor package into the URM and continue pushing it down until fully seated in the Slot 1 connector. Some URMs have extra caps to be used for SECC2 processors (AMP URMs do not have these). If so, after the processor is installed in the motherboard, place a cap on each end of the URM and push down until they snap into place. These caps are not left/right specific.

2-3 Mounting the Motherboard in the Chassis

All motherboards have standard mounting holes to fit different types of chassis. Use the mounting holes to orient the motherboard to the motherboard tray in the chassis. Chassis may include a variety of mounting fasteners made of metal, plastic or both. Metal fasteners are the most highly recommended because they ground the motherboard to the chassis. For this reason, it is best to use as many metal fasteners as possible. You should also use a wrist strap when installing the motherboard.

2-4 Installing RIMMs

CAUTION

Exercise extreme care when installing or removing RIMM modules to prevent any possible damage. **Also note that continuity modules must be installed into any empty RIMM slots.**

RIMM Installation (See Figure 2-2)

1. Insert RIMMs as required for desired system memory. Note that the PIIIDR3/PIIIDRE uses an interleaved memory scheme for increased performance. **This requires you to install at least two modules at a time and in pairs (not one or three modules). If installing only two modules, they must be installed into either Banks 0 and 2 or Banks 1 and 3.** See "RAMBUS Support" below for details on supported memory.
2. Insert each RIMM module vertically into its slot. Pay attention to the two notches along the bottom of the module to prevent inserting the module incorrectly.
3. Gently press down on the RIMM module until it snaps into place in the slot. As stated in 1 above, you must populate either two or four banks of memory.

Note: Continuity modules must be installed in empty RIMM slots.

RAMBUS Support (Important!)

The Memory Controller Hub (MCH) enables the use of RAMBUS in the RIMM slots on the PIIIDR3/PIIIDRE. This hub supports both ECC and non-ECC type memory. Check the Memory ECC Mode BIOS setting to enable the use of ECC. (See Section 1-2 for more on the MCH.) Also, be aware that PC800 RAMBUS can only be used when running at a 133 MHz FSB speed. PC700 can only be used when running with a 100 MHz FSB speed.

Note: Dual memory module installation (required minimum)

If installing only two RIMM modules, install them in the two RIMM slots nearest to the CPU slot and insert continuity modules in the RIMM slots that remain empty.

Figure 2-2. RIMM Installation

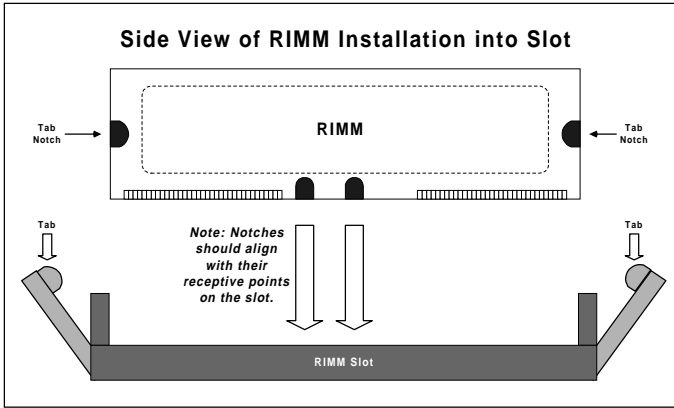
**To Install:**

With the tabs pulled outward, insert the RIMM module vertically and press down straight down until it snaps into place. Pay attention to the alignment of the two notches.

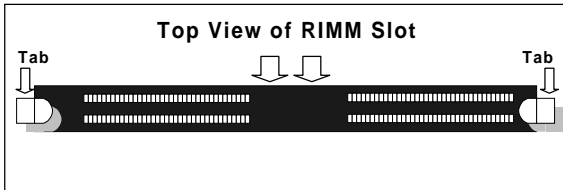
**To Remove:**

Use your thumbs to gently push out the tabs at both ends of the module. This should release it from the slot.

2-5 Port/Control Panel Connector Locations

The I/O ports are color coded in conformance with the PC 99 specification. See Figure 2-3 below for the colors and locations of the various I/O ports.

Figure 2-3. I/O Port Locations and Definitions

Installation

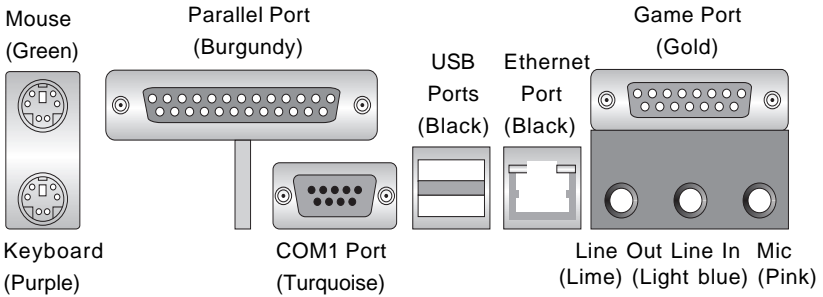

Front Control Panel

JF1 contains header pins for various front control panel connectors. See Figure 2-4 for the pin definitions of the speaker, overhear LED, keyboard lock, chassis intrusion, I2C, USB0, reset, power on, hard drive LED and power LED headers, which are all located on JF1. Please note that even and odd numbered pins are on opposite sides. Refer to pages 2-8 to 2-11 for details.

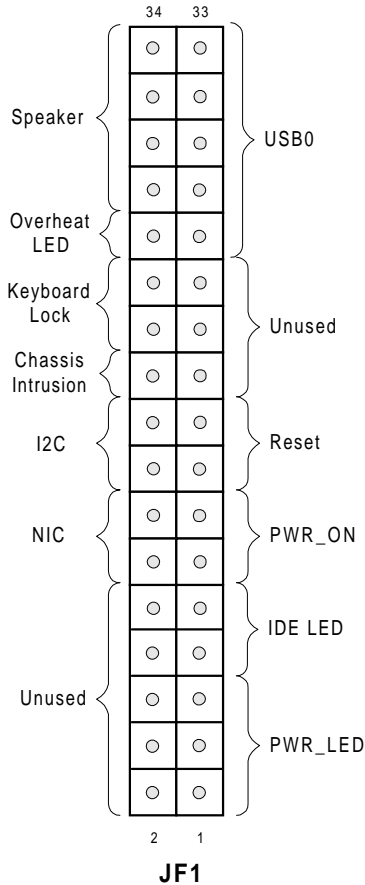

Figure 2-4. Front Control Panel Connectors

2-6 Connecting Cables

(see previous page for JF1 connection locations)

Power Supply Connector

After you have securely installed the motherboard, memory and add-on cards, you are ready to connect the cables. Attach an ATX power supply cable to J27 making sure the tabs on both connectors are aligned. See Table 2-1 for the pin definitions of an ATX power supply.

Table 2-1
ATX Power Supply Connector
Pin Definitions (J27)

Pin Number	Definition	Pin Number	Definition
1	3.3V	11	3.3V
2	3.3V3	12	-12V
3	Ground	13	Ground
4	5V	14	PS-ON
5	Ground	15	Ground
6	5V	16	Ground
7	Ground	17	Ground
8	PW-OK	18	-5V
9	5VSB	19	5V
10	12V	20	5V

Secondary Power Connector

Use of the Secondary Power connector (PWR_SEC) is recommended when a heavy load of peripherals has been added to the motherboard. See Table 2-2 for pin definitions. **Note: Use a 6-pin connector and be sure to check the power supply layout before attaching it.**

Table 2-2
Secondary Power Connector
(PWR_SEC)

Pin Number	Definition
1	Ground
2	Ground
3	Ground
4	+3.3V
5	+3.3V
6	+5V (keyed)

Power LED

The Power LED connection is located on pins 1, 3 and 5 of JF1. See Table 2-3 for pin definitions.

Table 2-3
PWR_LED Pin
Definitions (JF1)

Pin Number	Definition
1	+5V
3	Key
5	GND

Hard Drive LED

The Hard Drive LED connection is located on pins 7 and 9 of JF1. Attach the hard drive LED cable to these pins to display disk activity. See Table 2-4 for pin definitions.

Table 2-4
IDE_LED Pin
Definitions
(JF1)

Pin Number	Definition
7	+5V
9	HD Active

PWR_ON

The PWR_ON connection is located on pins 11 and 13 of JF1. Momentarily contacting both pins will power on/off the system. The user can also configure this button to function as a suspend button. (See the Power Button Mode setting in BIOS.) To turn off the power when set to suspend mode, hold down the power button for at least 4 seconds. See Table 2-5 for pin definitions.

Table 2-5
PWR_ON Connector
Pin Definitions
(JF1)

Pin Number	Definition
11	PW_ON
13	Ground

NIC_LED

The Network Interface Controller LED connection is located on pins 12 and 14 of JF1. Attach the NIC LED cable to these pins to display network activity. See Table 2-6 for pin definitions.

Table 2-6
NIC_LED Pin
Definitions
(JF1)

Pin Number	Definition
12	+5V
14	GND

Reset

The Reset connection is located on pins 15 and 17 of JF1. This connector attaches to the hardware reset switch on the computer case. See Table 2-7 for pin definitions.

Table 2-7
Reset Pin
Definitions
(JF1)

Pin Number	Definition
15	Reset
17	Ground

I²C

The I²C connection is located on pins 16 and 18 of JF1. See Table 2-8 for pin definitions.

Table 2-8
I²C Pin Definitions
(JF1)

Pin Number	Definition
16	SDA
18	SCL

Chassis Intrusion

The Chassis Intrusion connection is located on pin 20 of JF1. See Table 2-9 for pin definitions.

Table 2-9
Chassis Intrusion (IT)
Pin Definitions (JF1)

Pin Number	Definition
20	Intrusion Input

Keyboard Lock

The Keyboard Lock connection is located on pins 22 and 24 of JF1. See Table 2-10 for pin definitions. Pins 5 through 7 are for the power LED. Pins 8 and 9 are for the keylock.

Table 2-10
Keyboard Lock
(KL) Pin Definitions
(JF1)

Pin Number	Definition
22	+5V
24	GND

Overheat LED (OH)

Connect an LED to the OH connection on pin 26 of JF1 to provide advanced warning of chassis overheating. Refer to Table 2-11 for pin definitions.

Table 2-11
Overheat LED (OH)
Pin Definitions (JF1)

Pin Number	Definition
10	OH Active

NOTE: Because the OH and USB0 connectors both share pin 25, you cannot have both connected at the same time.

Extra Universal Serial Bus Connection (USB0)

An additional connection for USB0 is included on pins 25, 27, 29 and 31 of JF1 for front side USB access. You cannot have devices connected to both this and the back side connector at J12. See Table 2-12 for pin definitions. You will need a USB cable (not included) to use this connection.

Table 2-12
USB0 Pin
Definitions

Pin Number	Definition
1	+5V
2	Key
3	IRRX
4	Ground

Speaker

The speaker connection is located on pins 28, 30, 32 and 34 of JF1. See Table 2-13 for pin definitions.

Table 2-13
Speaker Connector Pin
Definitions (JF1)

Pin Number	Function	Definition
28	+	Red wire, Speaker data
30	Key	No connection
32		Key
34		Speaker data

Infrared Header

A 6-pin header for infrared devices is located just below JF1 on the motherboard. See Table 2-14 for pin definitions. Also, see the Technical Support section of our web page for information on infrared devices you can connect to the motherboard.

Table 2-14
Infrared (IR) Pin
Definitions

Pin Number	Definition
1	+5V
2	Key
3	IRRXX
4	Ground
5	IRTX

Fan Headers*

The thermal control fan header is designated THRM FAN on your board. The CPU and chassis fan headers are designated CPU1, CPU2, CHASSIS FAN1 and CHASSIS FAN2, respectively. Refer to Table 2-15 for pin definitions.

Table 2-15
Fan Header Pin Definitions
(THRM FAN, CPU1/2, CHASSIS
FAN1/2)

Pin Number	Definition
1	Ground (black)
2	+12V (red)
3	Tachometer

* Caution: These fan headers are DC power.

Serial Ports

Two connectors, for the COM1 and COM2 serial ports, are provided on your board. COM1 is located below the parallel port (see Figure 2-3) and COM2 is located just behind the Game Port. See Table 2-16 for pin definitions.

Table 2-16
Serial Port Pin Definitions
(COM1, COM2)

Pin Number	Definition	Pin Number	Definition
1	DCD	6	CTS
2	DSR	7	DTR
3	Serial In	8	RI
4	RTS	9	Ground
5	Serial Out	10	NC

ATX PS/2 Keyboard and PS/2 Mouse Ports

The ATX PS/2 keyboard and the PS/2 mouse are located on J13. See Table 2-17 for pin definitions. (The mouse port is above the keyboard port. See Figure 2-3.)

Table 2-17
PS/2 Keyboard
and Mouse Port
Pin Definitions
(J13)

Pin Number	Definition
1	Data
2	NC
3	Ground
4	VCC
5	Clock
6	NC

Universal Serial Bus (USB)

Two Universal Serial Bus connectors are located on J12. USB0 is the bottom connector and USB1 is the top connector. See Table 2-18 for pin definitions.

Table 2-18
Universal Serial Bus Pin Definitions
J12 **J12**

Pin Number	Definition	Pin Number	Definition
1	+5V	1	+5V
2	P0-	2	P0-
3	P0+	3	P0+
4	Ground	4	Ground
5	N/A	5	Key

CD Headers

There are two CD headers of different sizes on the motherboard to enable audio CD playback. Connect an audio cable from your CD player to whichever header fits your cable's connector. Refer to Table 2-19 for pin definitions.

Table 2-19
Audio CD Header Pin Definitions
(J34, J44)

Pin Number	Definition
1	Right Stereo Signal
2	Ground
3	Ground
4	Left Stereo Signal

Wake-On-LAN

The Wake-On-LAN header is designated as WOL. Refer to Table 2-20 for pin definitions. You must enable the LAN Wake-Up setting in BIOS to use this feature. You must also have a LAN card with a Wake-on-LAN connector and cable.

Table 2-20
Wake-On-LAN Pin
Definitions (WOL)

Pin Number	Definition
1	+5V Standby
2	Ground
3	Wake-up

Wake-On-Ring

The Wake-On-Ring header is designated as WOR. This function allows your computer to receive and be "woken up" by an incoming call when in the suspend state. Refer to Table 2-21 for pin definitions. You must also have a WOR card and cable to use WOR.

Table 2-21
Wake-On-Ring Pin
Definitions (WOR)

Pin Number	Definition
1	+5V Standby
2	Ground
3	Wake-up

Extra Chassis Intrusion Header

An additional chassis intrusion header (the other is located on JF1) is included on your motherboard at JL1. If a chassis intrusion condition has been detected, the mouse and keyboard will be disabled (but no audible alarm will be activated). All system operations will halt until the intrusion microswitch is set back to normal. See Table 2-22 for pin definitions.

Table 2-22
Chassis Intrusion
Header Pin Definitions
(JL1)

Pin Number	Definition
1	Intrusion Input
26	Ground

Power Supply Fail Header

Connect a cable from your power supply to the header at JP12 to provide warning of power supply failure. This warning signal is passed through the PWR_LED pin on JL1 to provide indication of a power failure on the chassis. This feature is only available when using Supermicro power supplies. See Table 2-23 for pin definitions.

Table 2-23
Power Supply Fail Header Pin Definitions
(JP12)

Pin Number	Definition
1	P/S 1 Fail Signal
2	P/S 2 Fail Signal
3	P/S 3 Fail Signal
4	Reset (from MB)

SLED1 (SCSI LED) Indicator (not on PIIIDRE)

The SLED connector is used to provide an LED indication of SCSI activity. Refer to Table 2-24 for connecting the SCSI LED.

Table 2-24
SLED1 Pin Definitions

Pin Number	Definition
1	Positive
2	Negative
3	Negative
4	Positive

2-7 Jumper Settings

Explanation of Jumpers

To modify the operation of the motherboard, jumpers can be used to choose between optional settings. Jumpers create shorts between two pins to change the function of the connector. Pin 1 is identified with a square solder pad on the printed circuit board. See the motherboard layout pages for jumper locations.

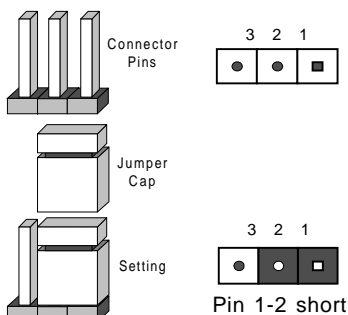

CMOS Clear

Refer to Table 2-25 for the jumper settings to clear CMOS. Always remove the AC power cord from the system before clearing CMOS.

NOTE: For an ATX power supply, you must completely shut down the system, remove the AC power cord and *then* use JBT1 to clear CMOS. Replace JBT1 back to the pin 1-2 position before powering up the system again. Do not use the PW_ON connector to clear CMOS.

Table 2-25
CMOS Clear Jumper Settings (JBT1)

Jumper Position	Definition
1-2	Normal
2-3	CMOS Clear

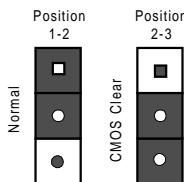

Front Side Bus Speed

Use JP3 to change the FSB speed. You can also change the CPU speed with the "CPU Speed at FSB" setting in BIOS. This setting will show you the actual CPU speed for each FSB speed option selected. See Table 2-26 for jumper settings. **Note:** If the system does not reboot after changing the CPU speed, clear CMOS, reboot and then set the correct CPU speed in BIOS.

Table 2-26
Front Side Bus Speed
Jumper Settings (JP3)

Jumper Position	Definition
1-2	Auto
2-3	133 MHz
OFF	100 MHz

* Note: The Auto setting allows the CPU to set the speed.

Host Bus ECC

Jumper JP5 is used to enable or disable ECC (Error Correction and Control) on the host (front side) bus. See Table 2-27 for jumper settings.

Table 2-27
Host Bus ECC Enable/
Disable
Jumper Settings (JP5)

Jumper Position	Definition
1-2	Enabled
2-3	Disabled

AC'97 Enable/Disable

AC'97 brings high quality audio to PCs. When enabled with JP7, audio is processed onboard. The disabled setting should be selected when you wish to use an add-on card for audio. See Table 2-28 for jumper settings.

Table 2-28
AC'97 Enable/Disable
Jumper Settings (JP7)

Jumper Position	Definition
1-2	Enabled
2-3	Disabled

SCSI Termination Enable/ Disable (not on PIIIDRE)

Jumper JA1 allows you to enable or disable termination for the SCSI connectors. The normal (default) position is open to enable SCSI termination. See Table 2-29 for jumper settings.

Table 2-29
SCSI Termination
Enable/Disable
Jumper Settings (JA1)

Jumper Position	Definition
Open	Enabled
Closed	Disabled

Overheat Alarm Enable/ Disable

You may want to disable the audio alarm signal that notifies you of over temperature conditions. Jumper JP10 gives you this option. If disabled, you will still be notified of such conditions by the Overheat LED. See Table 2-30 for jumper settings.

Table 2-30
Overheat Alarm
Enable/Disable
Jumper Settings (JP10)

Jumper Position	Definition
Open	Disabled
Closed	Enabled

Onboard LAN/NIC Enable/Disable

Jumper JP11 enables or disables the onboard LAN or NIC (Network Interface Card) on your motherboard. See Table 2-31 for jumper settings.

Table 2-31
Onboard LAN/NIC
Enable/Disable
Jumper Settings (JP11)

Jumper Position	Definition
Open	Disabled
Closed	Enabled

Power Supply Failure Alarm Enable/Disable

The system will notify you in the event of a power supply failure. This alarm assumes that your chassis has three power supply units, with one acting as a backup. If you only have one or two power supply units installed, you should disable this with JP13 to prevent false alarms. See Table 2-32 for jumper settings.

Table 2-32
Power Supply Failure
Alarm Enable/Disable
Jumper Settings (JP13)

Jumper Position	Definition
Open	Disabled
Closed	Enabled

2-8 Parallel Port, Floppy/Hard Disk Drive, AGP Port and SCSI Connections

Note the following when connecting the floppy and hard disk drive cables:

- The floppy disk drive cable has seven twisted wires.
- A red mark on a wire typically designates the location of pin 1.
- A single floppy disk drive ribbon cable has 34 wires and two connectors to support two floppy disk drives. The connector with twisted wires always connects to drive A, and the connector without twisted wires always connects to drive B.
- The 80-wire ATA66 IDE hard disk drive cable that came with your system has two connectors to support two drives. This special cable should be used to take advantage of the speed this new technology offers. The blue connector connects to the onboard IDE header and the other connector(s) to your hard drive(s). Consult the documentation that came with your disk drive for details on hard drive jumper locations and settings.

Table 2-33
Parallel (Printer) Port Pin Definitions
(J22)

Pin Number	Function	Pin Number	Function
1	Strobe-	2	Auto Feed-
3	Data Bit 0	4	Error-
5	Data Bit 1	6	Init-
7	Data Bit 2	8	SLCT IN-
9	Data Bit 3	10	GND
11	Data Bit 4	12	GND
13	Data Bit 5	14	GND
15	Data Bit 6	16	GND
17	Data Bit 7	18	GND
19	ACK	20	GND
21	BUSY	22	GND
23	PE	24	GND
25	SLCT	26	NC

Parallel Port Connector

The parallel port is located on J22. See Table 2-33 for pin definitions.

Floppy Connector

The floppy connector is located on J16. See Table 2-34 for pin definitions.

Table 2-34
Floppy Connector Pin Definitions (JP16)

Pin Number	Function	Pin Number	Function
1	GND	2	FDHDIN
3	GND	4	Reserved
5	Key	6	FDEDIN
7	GND	8	Index-
9	GND	10	Motor Enable
11	GND	12	Drive Select B-
13	GND	14	Drive Select A-
15	GND	16	Motor Enable
17	GND	18	DIR-
19	GND	20	STEP-
21	GND	22	Write Data-
23	GND	24	Write Gate-
25	GND	26	Track 00-
27	GND	28	Write Protect-
29	GND	30	Read Data-
31	GND	32	Side 1 Select-
33	GND	34	Diskette

Table 2-35
IDE Connector Pin Definitions
(J14, J15)

Pin Number	Function	Pin Number	Function
1	Reset IDE	2	GND
3	Host Data 7	4	Host Data 8
5	Host Data 6	6	Host Data 9
7	Host Data 5	8	Host Data 10
9	Host Data 4	10	Host Data 11
11	Host Data 3	12	Host Data 12
13	Host Data 2	14	Host Data 13
15	Host Data 1	16	Host Data 14
17	Host Data 0	18	Host Data 15
19	GND	20	Key
21	DRQ3	22	GND
23	I/O Write-	24	GND
25	I/O Read-	26	GND
27	IOCHRDY	28	BALE
29	DACK3-	30	GND
31	IRQ14	32	IOCS16-
33	Addr 1	34	GND
35	Addr 0	36	Addr 2
37	Chip Select 0	38	Chip Select 1-
39	Activity	40	GND

IDE Connectors

There are no jumpers to configure the onboard IDE connectors J14 and J15. Refer to Table 2-35 for pin definitions. You must use the ATA66 cable included with your system to benefit from the ATA66 technology.

AGP Pro Slot

The AGP Pro slot is backward compatible with AGP and 4xAGP graphics cards, which have fewer pins than AGP Pro cards. Because of this, care must be taken when installing a graphics card into this slot, as doing so incorrectly can damage your motherboard. For AGP Pro cards, you should remove the orange sticker covering one end of the slot. For other cards, leave this sticker in place and make sure your card does not plug into the section it covers. A general rule of thumb is to make sure your card fills the center section of pins first, then the end toward the edge of the motherboard if there are more. If the I/O shield of your card is flush with the edge of the motherboard, the card should be inserted correctly.



50-pin Legacy SCSI Connector

Refer to Table 2-36 for pin definitions for the 50-pin Legacy SCSI connector located at JA6.

Table 2-36
50-pin Legacy SCSI Connector Pin Definitions
(JA6)

Pin Number	Function	Pin Number	Function
1	GND	26	-DB (0)
2	GND	27	-DB (1)
3	GND	28	-DB (2)
4	GND	29	-DB (3)
5	GND	30	-DB (4)
6	GND	31	-DB (5)
7	GND	32	-DB (6)
8	GND	33	-DB (7)
9	GND	34	-DB (P)
10	GND	35	GND
11	GND	36	GND
12	Reserved	37	Reserved
13	Open	38	Termprwr
14	Reserved	39	Reserved
15	GND	40	GND
16	GND	41	-ATN
17	GND	42	GND
18	GND	43	-BSY
19	GND	44	-ACK
20	GND	45	-RST
21	GND	46	-MSG
22	GND	47	-SEL
23	GND	48	-C/D
24	GND	49	-REQ
25	GND	50	-I/O

Ultra Wide SCSI Connector

Refer to Table 2-37 for the Ultra Wide SCSI pin definitions. The connector is located at JA5.

Table 2-37
Ultra Wide SCSI Connector (JA5)

Pin Number	Function	Pin Number	Function
1	GND	35	-DB (12)
2	GND	36	-DB (13)
3	GND	37	-DB (14)
4	GND	38	-DB (15)
5	GND	39	Parity H
6	GND	40	-DB (0)
7	GND	41	-DB (1)
8	GND	42	-DB (2)
9	GND	43	-DB (3)
10	GND	44	-DB (4)
11	GND	45	-DB (5)
12	GND	46	-DB (6)
13	GND	47	-DB (7)
14	GND	48	Parity L
15	GND	49	GND
16	GND	50	Termpwrđ
17	Termpwrđ	51	Termpwrđ
18	Termpwrđ	52	Termpwrđ
19	GND	53	NC
20	GND	54	GND
21	GND	55	-ATTN
22	GND	56	GND
23	GND	57	-BSY
24	GND	58	-ACK
25	GND	59	-RST
26	GND	60	-MSG
27	GND	61	-SEL
28	GND	62	-CD
29	GND	63	-REQ
30	GND	64	-IO
31	GND	65	-DB (8)
32	GND	66	-DB (9)
33	GND	67	-DB (10)
34	GND	68	-DB (11)

Ultra160 SCSI Connector

Refer to Table 2-38 for pin definitions for the Ultra160 SCSI connector located at JA2.

Table 2-38
68-pin Ultra160 SCSI Connector (JA2)

Connector Contact Number	Signal Names	Connector Contact Number	Signal Names
1	+DB(12)	35	-DB(12)
2	+DB(13)	36	-DB(13)
3	+DB(14)	37	-DB(14)
4	+DB(15)	38	-DB(15)
5	+DB(P1)	39	-DB(P1)
6	+DB(0)	40	-DB(0)
7	+DB(1)	41	-DB(1)
8	+DB(2)	42	-DB(2)
9	+DB(3)	43	-DB(3)
10	+DB(4)	44	-DB(4)
11	+DB(5)	45	-DB(5)
12	+DB(6)	46	-DB(6)
13	+DB(7)	47	-DB(7)
14	+DB(P)	48	-DB(P)
15	GROUND	49	GROUND
16	DIFFSENS	50	GROUND
17	TERMPWR	51	TERMPWR
18	TERMPWR	52	TERMPWR
19	RESERVED	53	RESERVED
20	GROUND	54	GROUND
21	+ATN	55	-ATN
22	GROUND	56	GROUND
23	+BSY	57	-BSY
24	+ACK	58	-ACK
25	+RST	59	-RST
26	+MSG	60	-MSG
27	+SEL	61	-SEL
28	+C/D	62	-C/D
29	+REQ	63	-REQ
30	+I/O	64	-I/O
31	+DB(8)	65	-DB(8)
32	+DB(9)	66	-DB(9)
33	+DB(10)	67	-DB(10)
34	+DB(11)	68	-DB(11)

2-9 Installing Software Drivers

After all the hardware has been installed you must install the software drivers. The necessary drivers are all included on the Supermicro CD that came packaged with your motherboard. After inserting this CD into your CDROM drive, the display shown in Figure 2-5 should appear. (If this display does not appear, click on the My Computer icon and then on the icon representing your CDROM drive. Finally, double click on the S "Setup" icon.)



Figure 2-5. Driver/Tool Installation Display Screen

Click the icons showing a hand writing on paper to view the readme files for each item. Click the tabs to the right of these *in order from top to bottom* to install each item one at a time. **After installing each item marked "Reboot System", you must reboot the system before moving on to the next item on the list.** You should install everything here except for the Security Drivers and the Super Doctor utility, which are optional. The Security Drivers support multiple languages. Click the arrow to pull down a menu of choices. The bottom icon with a CD on it allows you to view the entire contents of the CD.

Chapter 3 Troubleshooting

3-1 Troubleshooting Procedures

Use the following procedures to troubleshoot your system. If you have followed all of the procedures below and still need assistance, refer to the 'Technical Support Procedures' and/or 'Returning Merchandise for Service' section(s) in this chapter. **Note: Always disconnect the power cord before adding, changing or installing any hardware components.**

Before Power On

1. Make sure no short circuits exist between the motherboard and chassis.
2. Disconnect all ribbon/wire cables from the motherboard, including those for the keyboard and mouse.
3. Remove all add-on cards.
4. Install a CPU (making sure it is fully seated) and connect the chassis speaker and the power LED to the motherboard. (Check all jumper settings as well.)

No Power

1. Make sure no short circuits exist between the motherboard and the chassis.
2. Verify that all jumpers are set to their default positions.
3. Check that the 115V/230V switch on the power supply is properly set.
4. Turn the power switch on and off to test the system.
5. The battery on your motherboard may be old. Check to verify that it still supplies ~3VDC. If it does not, replace it with a new one.

No Video

1. If the power is on but you have no video, remove all the add-on cards and cables.
2. Use the speaker to determine if any beep codes exist. Refer to Appendix A for details on beep codes.

NOTE

If you are a system integrator, VAR or OEM, a POST diagnostics card is recommended. For I/O port 80h codes, refer to App. B.

Memory Errors

1. Make sure the RIMM modules are properly and fully installed. Interleaved memory requires that modules must be installed in pairs (two slots at a time).
2. Determine if different speeds of RIMMs have been installed and verify that the BIOS setup is configured for the fastest speed of memory used. It is recommended to use the same memory speed for all RIMMs in the system.
3. For DIMMs, make sure you are using PC133 or PC100 compliant, unbuffered SDRAM. EDO SDRAM is not supported.
4. Check for bad RIMM modules or slots by swapping modules between slots and noting the results.
5. Make sure all memory modules are fully seated in their slots.
6. Check the power supply voltage 115V/230V switch.

Losing the System's Setup Configuration

1. Check the setting of jumper JBT1. Ensure that you are using a high quality power supply. A poor quality power supply may cause the system to lose the CMOS setup information. Refer to Section 1-5 for details on recommended power supplies.
2. The battery on your motherboard may be old. Check to verify that it still supplies ~3VDC. If it does not, replace it with a new one.
3. If the above steps do not fix the Setup Configuration problem, contact your vendor for repairs.

3-2 Technical Support Procedures

Before contacting Technical Support, please take the following steps. Also, note that as a motherboard manufacturer, Supermicro does not sell directly to end-users, so it is best to first check with your distributor or reseller for troubleshooting services. They should know of any possible problem(s) with the specific system configuration that was sold to you.

1. Please go through the 'Troubleshooting Procedures' and 'Frequently Asked Question' (FAQ) sections in this chapter or see the FAQs on our web site (<http://www.supermicro.com/techsupport.htm>) before contacting Technical Support.
2. BIOS upgrades can be downloaded from our web site at <http://www.supermicro.com/techsupport/download.htm>.

Note: Not all BIOS can be flashed depending on the modifications to the boot block code.

3. If you still cannot resolve the problem, include the following information when contacting Supermicro for technical support:
 - Motherboard model and PCB revision number
 - BIOS release date/version
(this can be seen on the initial display when your system first boots up)
 - System configurationAn example of a Technical Support form is on our web site at http://www.supermicro.com/techsupport/contact_support.htm.
4. Distributors: For immediate assistance, please have your account number ready when placing a call to our technical support department. We can be reached by e-mail at support@supermicro.com or by fax at (408) 895-2012.

3-3 Frequently Asked Questions

Question: What are the various types of memory that the PIIIDR3/PIIIDRE motherboard can support?

Answer: The PIIIDR3/PIIIDRE has 4 RIMM sockets, which support up to 2 GB RDRAM. Use 300/400 MHz (600/800 MB/sec) RIMM modules for RAMBUS. Both ECC and non-ECC RDRAM are supported. Check the Memory ECC Mode setting in BIOS to enable the use of ECC.

Note: Continuity modules must be installed into empty RIMM slots. In addition, memory modules must be installed in pairs (two slots at a time) because interleaved memory technology is used. If installing only two modules, they must be installed into either Banks 0 and 2 or Banks 1 and 3. Also, be aware that PC800 RAMBUS can only be used when running at a 133 MHz FSB speed. PC700 can only be used when running with a 100 MHz FSB speed.

Question: How do I update my BIOS?

Answer: It is recommended that you **do not** upgrade your BIOS if you are experiencing no problems with your system. Updated BIOS files are located

on our web site at <http://www.supermicro.com>. Please check our BIOS warning message and the info on how to update your BIOS on our web site. Also, check the current BIOS revision and make sure it is newer than your BIOS before downloading. Select your motherboard model and download the BIOS file to your computer. Unzip the BIOS update file and you will find the readme.txt (flash instructions), the fwhflash.com (BIOS flash utility) and the BIOS image (xxxxxx.rom) files. Copy these files onto a bootable floppy and reboot your system. It is not necessary to set BIOS boot block protection jumpers on the motherboard. At the DOS prompt, enter the command "fwhflash." This will start the flash utility and give you an opportunity to save your current BIOS image. Flash the boot block and enter the name of the update BIOS image file.

Note: It is important to save your current BIOS and **rename it "super.rom"** in case you need to recover from a failed BIOS update. Select flash boot block, then enter the update BIOS image. Select "Y" to start the BIOS flash procedure and do not disturb your system until the flash utility displays that the procedure is complete. After updating your BIOS, please clear the CMOS then load Optimal Values in the BIOS.

Question: After flashing the BIOS my system does not have video. How can I correct this?

Answer: If the system does not have video after flashing your new BIOS, it indicates that the flashing procedure failed. To remedy this, first clear CMOS per the instructions in this manual and retry the BIOS flashing procedure. If you still do not have video, please use the following **BIOS Recovery Procedure**. First, make sure the keyboard wakeup jumper is disabled. Then, turn your system off and place the floppy disk with the saved BIOS image file (see above FAQ) in drive A. Press and hold <CTRL> and <Home> at the same time, then turn on the power with these keys pressed until your floppy drive starts reading. Your screen will remain blank until the BIOS program is done. If the system reboots correctly, then the recovery was successful. The **BIOS Recovery Procedure** will not update the boot block in your BIOS.

Question: Do I need the CD that came with your motherboard?

Answer: The supplied compact disc has quite a few drivers and programs that will greatly enhance your system. We recommend that you review the CD and install the applications you need. Applications on the CD include 840 chipset drivers for Windows and security and audio drivers.

Question: Why can't I turn off the power using the momentary power on/off switch?

Answer: The instant power off function is controlled in BIOS by the Power Button Mode setting. When the On/Off feature is enabled, the motherboard will have instant off capabilities as long as the BIOS has control of the system. When the Standby or Suspend feature is enabled or when the BIOS is not in control such as during memory count (the first screen that appears when the system is turned on), the momentary on/off switch must be held for more than four seconds to shut down the system. This feature is required to implement the ACPI features on the motherboard.

Question: I see some of my PCI devices sharing IRQs, but the system seems to be fine. Is this correct or not?

Answer: Some PCI Bus Mastering devices can share IRQs without performance penalties. These devices are designed to work correctly while sharing IRQs. See Table 3-1 below for details on shared IRQs.

Table 3-1. Shared IRQs**PIIIDR3/PIIIDRE**

PCI 1 shares an IRQ with the NIC and the AGP Pro slot
 PCI 2 shares an IRQ with the onboard audio and the SM bus*
 PCI 3 shares an IRQ with 64-bit PCI slots 1 and 2
 PCI 4 shares an IRQ with the USB
 *System Management bus

Question: I installed my microphone correctly but I can't record any sound. What should I do?

Answer: Go to <Start>, <Programs>, <Accessories>, <Entertainment> and then <Volume Control>. Under the Properties tab, scroll down the list of devices in the menu and check the box beside "Microphone".

Question: How do I connect the ATA66 cable to my IDE device(s)?

Answer: The 80-wire/40-pin ATA66 IDE cable that came with your system has two connectors to support two drives. This special cable must be used to take advantage of the speed the ATA66 technology offers. Connect the blue connector to the onboard IDE header and the other connector(s) to your hard drive(s). Consult the documentation that came with your disk drive for details on actual jumper locations and settings.

3-4 Returning Merchandise for Service

A receipt or copy of your invoice marked with the date of purchase is required before any warranty service will be rendered. You can obtain service by calling your vendor for a Returned Merchandise Authorization (RMA) number. When returning to the manufacturer, the RMA number should be prominently displayed on the outside of the shipping carton, and mailed prepaid or hand-carried. Shipping and handling charges will be applied for all orders that must be mailed when service is complete.

This warranty only covers normal consumer use and does not cover damages incurred in shipping or from failure due to the alternation, misuse, abuse or improper maintenance of products.

During the warranty period, contact your distributor first for any product problems.

Chapter 4

BIOS

4-1 Introduction

This chapter describes the AMIBIOS for the PIIIDR3/PIIIDRE. The AMI ROM BIOS is stored in a Flash EEPROM and can be easily upgraded using a floppy disk-based program.

Note: Due to periodic changes to BIOS, some settings may have been added or deleted and might not yet be recorded in this manual. Refer to the Manual Download area of our web site for any changes to BIOS that are not reflected in this manual.

System BIOS

The BIOS is the Basic Input Output System used in all IBM® PC, XT™, AT®, and PS/2® compatible computers.

Configuration Data

AT-compatible systems, also called ISA (Industry Standard Architecture) must have a place to store system information when the computer is turned off. The original IBM AT had 64 kbytes of non-volatile memory storage in CMOS RAM. All AT-compatible systems have at least 64 kbytes of CMOS RAM, which is usually part of the Real Time Clock.

How Data Is Configured

AMIBIOS provides a Setup utility in ROM that is accessed by pressing at the appropriate time during system boot. Setup configures data in CMOS RAM.

POST Memory Test

Normally, the only visible POST routine is the memory test. The screen that appears when the system is powered on is shown on the next page.

An AMIBIOS identification string is displayed at the left bottom corner of the screen, below the copyright message.

4-2 BIOS Features

- Supports Plug and Play V1.0A and DMI 2.1
- Supports Intel PCI 2.2 (Peripheral Component Interconnect) local bus specification
- Supports Advanced Power Management (APM) specification v 1.1
- Supports ACPI
- Supports Flash ROM

AMIBIOS supports the LS120 drive made by Matsushita-Kotobuki Electronics Industries Ltd. The LS120:

- Can be used as a boot device
- Is accessible as the next available floppy drive

AMIBIOS supports PC Health Monitoring chips. When a failure occurs in a monitored activity, AMIBIOS can sound an alarm and display a message. The PC Health Monitoring chips monitor:

- CPU temperature
- Additional temperature sensors
- Chassis intrusion
- Five positive voltage inputs
- Two negative voltage inputs
- Four fan-speed monitor inputs

4-3 Running Setup

**Optimal default settings are in bold text unless otherwise noted.*

The BIOS setup options described in this section are selected by choosing the appropriate text from the Standard Setup screen. All displayed text is described in this section, although the screen display is often all you need to understand how to set the options (see on next page).

AMIBIOS HIFLEX SETUP UTILITY VERSION 1.18

© 1998 American Megatrends, Inc. All Rights Reserved.

STANDARD CMOS SETUP
 ADVANCED CMOS SETUP
 ADVANCED CHIPSET SETUP
 POWER MANAGEMENT SETUP
 PCI / PLUG AND PLAY SETUP
 PERIPHERAL SETUP
 AUTO-DETECT HARD DISK
 CHANGE USER PASSWORD
 CHANGE SUPERVISOR PASSWORD
 CHANGE LANGUAGE SETTING
 AUTO CONFIGURATION WITH OPTIMAL SETTINGS
 AUTO CONFIGURATION WITH FAIL-SAFE SETTINGS
 SAVE SETTINGS AND EXIT
 EXIT WITHOUT SAVING

Standard CMOS setup for changing time, date, hard disk type, etc.

Esc:Exit ↑↑↓↓:Sel F2/F3:Color F10:Save & Exit

AMIBIOS SETUP-STANDARD CMOS SETUP

(C)1998 American Megatrends, Inc. All Rights Reserved

Date (mm/dd/yyyy): Tue Sep 1,1998

Base Memory: 640

KB Time (hh/mm/ss) : 16:05:13
 KB

Extd Memory: 255

Floppy Drive A: 1.44MB 3½

Floppy Drive B: Not Installed

LBA Blk PIO 32Bit

Type Size Cyln Head Wpcom Sec Mode Mode Mode

Pri Master: Auto 42 40 981 5 981 17 Off Off Auto
 On

Pri Slave: Not Installed

Sec Master: Not Installed

Sec Slave: Not Installed

Boot Sector Virus Protection Disabled

Month: Jan - Dec

ESC:Exit ↑↓:Sel

Day: 01 - 31

PgUp/PgDn:Modify

Year: 1901 - 2099

F2/F3:Color

Standard CMOS Setup

Date and Time Configuration

Select the Standard option. Select the *Date/Time* icon. The current values for each category are displayed. Enter new values through the keyboard.

Floppy A

Floppy B

Choose the Floppy Drive A or B icon to specify the floppy drive type. The settings are *Not Installed*, *360 KB 5¼ inch*, *1.2 MB 5¼ inch*, *720 KB 3½ inch*, *1.44 MB 3½ inch* or *2.88 MB 3½ inch*. **Note: The Optimal and Fail-Safe settings for Floppy Drive A are 1.44 MB 3 1/2 inch and for Floppy Drive B are Not Installed.**

Pri Master

Pri Slave

Sec Master

Sec Slave

Select these options to configure the drive named in the option. Select *Auto Detect IDE* to let AMIBIOS automatically configure the drive. A screen with a list of drive parameters appears. Click on *OK* to configure the drive.

Type

How to Configure

SCSI

Select *Type*. Select *Not Installed* on the drive parameter screen. The SCSI drivers provided by the SCSI manufacturer should allow you to configure the SCSI drive.

IDE

Select *Type*. Select *Auto* to let AMIBIOS determine the parameters. Click on *OK* when AMIBIOS displays the drive parameters. Select *LBA Mode*. Select *On* if the drive has a capacity greater than 540 MB. Select the *Block Mode*. Select *On* to allow block mode data transfers. Select the *32-bit mode*. Select *On* to allow 32-bit data transfers. Select *PIO mode*. Select *On* to allow AMIBIOS to determine the PIO Mode. It is best to select *Auto* to allow AMIBIOS to determine the PIO mode. If you select a PIO mode that is not supported by the IDE drive, the drive will not work properly. If you are absolutely certain that you know the drive's PIO mode, select PIO mode 0-4, as appropriate

Entering Drive Parameters

You can also enter the hard disk drive parameters. The drive parameters are:

Parameter	Description
Type	The number for a drive with certain identification parameters.
Cylinders	The number of cylinders in the disk drive.
Heads	The number of heads.
Write Precompensation	The size of a sector gets progressively smaller as the track diameter diminishes. Yet each sector must still hold 512 bytes. Write precompensation circuitry on the hard disk compensates for the physical difference in sector size by boosting the write current for sectors on inner tracks. This parameter is the track number where write precompensation begins.
Sectors	The number of sectors per track. MFM drives have 17 sectors per track. RLL drives have 26 sectors per track. ESDI drives have 34 sectors per track. SCSI and IDE drive may have even more sectors per track.
Capacity	The formatted capacity of the drive is (Number of heads) x (Number of cylinders) x (Number of sectors per track) x (512 bytes per sector)

Boot Sector Virus Protection

This setting allows you to prevent any data from being written the boot sector of the hard drive. While this may prevent viruses from infecting your system, you may need to change information here when installing new programs. The options for this setting are *Enabled* or *Disabled*.

Advanced CMOS Setup

Quick Boot

The Settings are *Disabled* or *Enabled*. Set to *Enabled* to permit AMIBIOS to boot quickly when the computer is powered on. This option replaces the old Above 1 MB Memory Test Advanced Setup option. The settings are:

<u>Setting</u>	<u>Description</u>
<i>Disabled</i>	AMIBIOS tests all system memory. AMIBIOS waits up to 40 seconds for a READY signal from the IDE hard disk drive. AMIBIOS waits for .5 seconds after sending a RESET signal to the IDE drive to allow the IDE drive time to get ready again.

AMIBIOS checks for a key press and runs AMIBIOS Setup if the key has been pressed.

Enabled

AMIBIOS does not test system memory above 1 MB. AMIBIOS does not wait up to 40 seconds for a READY signal from the IDE hard disk drive. If a READY signal is not received immediately from the IDE drive, AMIBIOS does not configure that drive. AMIBIOS does not wait for .5 seconds after sending a RESET signal to the IDE drive to allow the IDE drive time to get ready again. In *Enabled*, keyboard will be bypassed.

Note: You cannot run AMIBIOS Setup at system boot, because there is no delay for the "Hit to run Setup" message.

Pri Master ARMD Emulated as

Pri Slave ARMD Emulated as

Sec Master ARMD Emulated as

Sec Slave ARMD Emulated as

The settings for these options are **Auto**, *Floppy* or *Hard disk*. If set to Auto, the default emulation type depends on the ARMD drive: floppy for LS120, Hard Disk for MO and Hard Disk for Iomega Zip.

1st Boot Device

2nd Boot Device

3rd Boot Device

The options for the 1st Boot Device are *Disabled*, *1st IDE-HDD*, *2nd IDE-HDD*, *3rd IDE-HDD*, *4th IDE-HDD*, **Floppy**, *ARMD-FDD*, *ARMD-HDD*, *ATAPI CDROM*, *SCSI*, *Network* or *I₂O*. The options for the 2nd Boot Device are *Disabled*, **1st IDE-HDD**, *2nd IDE-HDD*, *3rd IDE-HDD*, *4th IDE-HDD*, *Floppy*, *ARMD-FDD*, *ARMD-HDD*, *ATAPI CDROM* or *SCSI*. The options for the 3rd Boot Device are *Disabled*, *1st IDE-HDD*, *2nd IDE-HDD*, *3rd IDE-HDD*, *4th IDE-HDD*, *Floppy*, *ARMD-FDD*, *ARMD-HDD* or **ATAPI CDROM**.

1st IDE-HDD, 2nd IDE-HDD, 3rd IDE-HDD and 4th IDE-HDD are the four hard disks that can be installed by the BIOS. 1st IDE-HDD is the first hard disk installed by the BIOS, 2nd IDE-HDD is the second hard disk, and so on. For example, if the system has a hard disk connected to Primary Slave and another hard disk to Secondary Master, then 1st IDE-HDD will be referred to as the hard disk connected to Primary Slave and 2nd IDE-HDD will be referred to as the hard disk connected to the Secondary Master. 3rd IDE-HDD and 4th IDE-HDD are not present. Note that the order of the initialization of the devices connected to the primary and secondary channels are Primary Master first, Primary Slave second, Secondary Master third, and

Secondary Slave fourth.

The BIOS will attempt to read the boot record from 1st, 2nd, 3rd and 4th boot device in the selected order until it is successful in reading the booting record. The BIOS will not attempt to boot from any device which is not selected as the boot device.

Try Other Boot Devices

This option controls the action of the BIOS if all the selected boot devices failed to boot. The settings for this option are **Yes** or **No**. If **Yes** is selected and all the selected boot devices failed to boot, the BIOS will try to boot from the other boot devices (in a predefined sequence) which are present but not selected as boot devices in the setup (and hence have not yet been tried for booting). If selected as **No** and all selected boot devices failed to boot, the BIOS will not try to boot from the other boot devices which may be present but not selected as boot devices in setup.

Initialize I2O Devices

The settings for this option are **Yes** or **No**. This initializes I2O processor(s) and I2O storage devices.

Initial Display Mode

This option determines the display screen with which the POST is going to start the display. The settings for this option are **BIOS** or **Silent**. If selected as **BIOS**, the POST will start with the normal sign-on message screen. If **Silent** is selected, the POST will start with the Supermicro screen.

Display Mode at Add-On ROM Init

The settings for this option are **Force BIOS** or **Keep Current**.

Floppy Access Control

The settings for this option are **Read-Write** or **Read-Only**. This option will be effective only if the device is accessed through BIOS.

Hard Disk Access Control

The settings for this option are **Read-Write** or **Read-Only**. This option will be effective only if the device is accessed through BIOS.

S.M.A.R.T. for Hard Disks

S.M.A.R.T. (Self-Monitoring, Analysis and Reporting Technology) is a technology developed to manage the reliability of the hard disk by predicting future device failures. The hard disk needs to be S.M.A.R.T. capable.

The settings for this option are **Disabled** or **Enabled**. ***Note: S.M.A.R.T. cannot predict all future device failures. S.M.A.R.T. should be used as a warning tool, not as a tool to predict the device reliability.**

Boot Up Num-Lock

Settings for this option are **On** or **Off**. When this option is set to **On**, the BIOS turns off the Num Lock key when the system is powered on. This will enable the end user to use the arrow keys on both the numeric keypad and the keyboard.

PS/2 Mouse Support

Settings for this option are **Enabled** or **Disabled**. When this option is set to **Enabled**, AMIBIOS supports a PS/2-type mouse.

Primary Display

The settings for this option are **Absent**, **VGA/EGA**, **CGA 40x25**, **CGA 80x25** or **Mono**.

Password Check

This option enables the password check option every time the system boots or the end user runs WinBIOS Setup. If **Always** is chosen, a user password prompt appears every time the computer is turned on. If **Setup** is chosen, the password prompt appears if WinBIOS Setup is executed.

Boot to OS/2

If DRAM size is over 64 MB, set this option to **Yes** to permit AMIBIOS to run with IBM OS/2. The settings are **No** or **Yes**.

Internal Cache

This option is for enabling or disabling the internal cache memory. The settings for this option are **Disabled**, **WriteThru** or **WriteBack**.

External Cache

This option is for enabling or disabling the external cache memory. The settings for this option are **Disabled**, **WriteThru** or **WriteBack**.

System BIOS Cacheable

When set to **Enabled**, the contents of the F0000h system memory segment can be read from or written to cache memory. The contents of this memory segment are always copied from the BIOS ROM to system RAM for faster execution. The settings are **Enabled** or **Disabled**. **Note: The Optimal default setting is Enabled and the Fail-Safe default**

setting is Disabled. Set this option to Enabled to permit the contents of F0000h RAM memory segment to be written to and read from cache memory.

Processor Serial Number

Intel included a serial number in their Pentium III processors as a unique system identifier. For privacy reasons, you can disable this setting to prevent the release of this identifier. The settings for this option are *Enabled* or *Disabled*.

C000 Shadow (16K)

C400 Shadow (16K)

C800 Shadow (16K)

CC00 Shadow (16K)

D000 Shadow (16K)

D400 Shadow (16K)

D800 Shadow (16K)

DC00 Shadow (16K)

These options specify how the 32 KB of video ROM at C0000h (or D0000h) is treated. The settings are: *Disabled*, *Enabled* or *Cached*. The default is *Disabled* for all settings except C000 and C400, which are *Cached* for default. When set to *Disabled*, the contents of the video ROM are not copied to RAM. When set to *Enabled*, the contents of the video ROM area from C0000h-x7FFFh (or D0000h-D7FFFh) are copied (shadowed) from ROM to RAM for faster execution. When set to *Cached*, the contents of the video ROM area from C0000h-C7FFFh (or D0000h-D7FFFh) are copied from ROM to RAM, and can be written to or read from cache memory.

Advanced Chipset Setup

USB Function

The settings for this option are *Enabled* or *Disabled*. Set this option to *Enabled* to enable the USB (Universal Serial Bus) functions.

USB KB/Mouse Legacy Support

The settings for this option are *Keyboard*, *Auto*, *Keyboard+Mouse* or *Disabled*.

Graphics Aperture Size

The option specifies the amount of system memory that can be used by the Accelerated Graphics Port (AGP). The settings are *4 MB*, *8 MB*, *16 MB*, *32 MB*, ***64 MB***, *128 MB* or *256 MB*.

PC/PCIB Select Enable

The settings for this option are *Enabled* or *Disabled*.

Search for MDA Resources

The settings for this option are *Yes* or *No*.

AC97 Audio Controller

This setting is used to switch the onboard audio on and off. The settings for this option are *Enabled* or *Disabled*.

Memory Hole

Some ISA cards may require specific areas of memory in order to function. This can be done by choosing the *15MB -16MB* option as an area reserved for ISA use. The *Disabled* option will not reserve a portion of memory for ISA cards.

DMA-0 Type**DMA-1 Type****DMA-2 Type****DMA-3 Type****DMA-5 Type****DMA-6 Type****DMA-7 Type**

These options determine the bus that the specified DMA channel can be used on. The settings are *LPC DMA* or *PC/PCI*.

CPU Speed at FSB 133/100

This option allows you to increase the FSB speed over the normal 100 and 133 MHz settings controlled by JP3. The settings for this option are *2x266/200*, *4x533/400*, *3x400/300*, *5x666/500*, *2.5x333/250*, *4.5x600/450*, *3.5x466/350*, *5.5x733/550*, *6x800/600*, *8x1K/800*, *7x933/700*, *6.5x866/650*, *1.5x200/150* and *7.5x999/750* (MHz). (The Auto setting on JP3 allows the system to determine which front side bus speed will be used.)

MRHS Memory Buffer Strength

This settings for this option are *Auto* and *Strong*.

Power Management

NOTE: APM is automatically installed. If using ACPI, changes to the following settings up to and including LAN Wake-Up will have no affect. If you prefer to use ACPI, refer to the instructions on initializing ACPI on page 1-22.

Suspend to RAM Support

This allows you to Enable or Disable the Suspend to RAM feature. The settings for this option are *Enabled* or **Disabled**. Available with ACPI only.

Repost Video on S3 Resume

This determines whether or not to invoke the VGA BIOS post when resuming from STR/S3. The settings for this option are **Enabled** and *Disabled*. Available with ACPI only.

Suspend Power Saving Type

The settings for this option are **S1** and **C2**. S1 is a normal suspend state, in which no system (CPU or chipset) context is lost. C2 is a low power state. In this state, the system cache is maintained.

Standby Time Out

This option specifies the length of a period of system inactivity while in the standby state. When this length of time expires, the computer enters a suspend power state. The settings are **Disabled**, *1Min*, *5Min* and *10Min*.

Power Button Mode

This option specifies how the power button mounted externally on the computer chassis is used. The settings are: *Standby* and **On/Off**. When set to *On/Off*, pushing the power button turns the computer on or off. The *Standby* setting places the computer in Standby mode or Full On power mode.

Power Lost Control

This option determines when Power Lost Control will be effective. The settings are **Always Off** and *Always On*.

Green PC Monitor Power State

This option specifies the power state that the green PC-compliant video monitor enters when AMIBIOS places it in a power savings state after the specified period of display inactivity has expired. The settings are **Standby** and **Off**.

Video Power Down Mode

This option specifies the power conserving state that the VGA video subsystem enters after the specified period of display inactivity has expired. The settings are *Disabled* and **Standby**. **Note: The Optimal default setting for this option is Standby and the Fail-Safe default setting is Disabled.**

Hard Disk Power Down Mode

This option specifies the power conserving state that the hard disk drive enters after the specified period of hard drive inactivity has expired. The settings are *Disabled* and **Standby**. **Note: The Optimal default setting for this option is Standby and the Fail-Safe default setting is Disabled.**

Hard Disk Time Out (Minutes)

This option specifies the length of a period of hard disk drive inactivity. When this length of time expires, the computer enters the power-conserving state specified in the Hard Disk Power Down Mode option. The settings are **Disabled** and *1 Min* through *14 Min* in 1 minute increments.

Display Activity

This option specifies if AMIBIOS is to monitor display activity for power conservation purposes. When this option is set to *Monitor* and there is no display activity for the length of time specified in the Standby Timeout (Minutes) option, the computer enters a power savings state. The settings are *Monitor* or **Ignore**.

Manual Throttle Ratio

Throttling is used to lower power consumption and reduce heat. This option allows the CPU to operate at a reduced average power at a sacrifice in performance. The settings for this option are *87.5%*, *75.0%*, *62.5%*, **50%**, *37.5%*, *25%* or *12.5%*.

Intruder Sel

The settings for this option are *SCI* and **SMI**.

Advanced SMI Enable Controls

Timer Overflow Enable

This allows the system to generate a System Management Interrupt after a specific amount of time has passed. The settings are *Enabled* and *Disabled*.

Thermal SMI Enable

This allows the system to generate a System Management Interrupt after a specific temperature has been exceeded. The settings are *Enabled* and *Disabled*.

PME SMI Enable

This allows the system to generate a System Management Interrupt after a Power Management Event has occurred. The settings are *Enabled* and *Disabled*.

SW SMI Timer Enable

The settings for this option are *Enabled* and *Disabled*.

TCO Logic SMI Enable

This allows the TCO logic to generate a System Management Interrupt when a century rollover occurs. The settings are *Enabled* and *Disabled*.

SLP SMI Enable

The settings for this option are *Disabled* and *Enabled*.

Advanced Resume Event Controls

RTC Resume

You can have the system resume operation at a predetermined time by use of the real-time clock. Enabling this setting allows you to determine the following four settings. The settings are *Enabled* and *Disabled*.

RTC Alarm Date

This allows you to set a time at which the system will wake-up. The setting is a number representing the alarm date.

RTC Alarm Hour

This allows you to set a time at which the system will wake-up. The setting is a number representing the alarm hour.

RTC Alarm Minute

This allows you to set a time at which the system will wake-up. The setting is a number representing the alarm minute.

RTC Alarm Second

This allows you to set a time at which the system will wake-up. The setting is a number representing the alarm second.

USB Controller Resume

This allows you to wake up the system from a USB device. The settings for this option are *Enabled* and ***Disabled***.

PME Resume

This allows you to wake up the system from a PME device. The settings for this option are *Enabled* and ***Disabled***.

Remote Ring On

This allows you to wake up the system from a serial port modem. The settings for this option are *Enabled* and ***Disabled***.

SMBUS Resume

This allows you to wake up the system from a system management bus device. The settings for this option are *Enabled* and ***Disabled***.

LAN Wake-Up

This allows you to make use of the Wake-on-LAN feature. The settings for this option are *Enabled* and ***Disabled***.

Keyboard Wake-Up Function

This allows you to wake-up the system by depressing any key on the keyboard. The settings for this option are ***Enabled*** and *Disabled*.

Mouse Wake-Up Function

This allows you to wake-up the system by moving or clicking a button on the mouse. The settings for this option are ***Enabled*** and *Disabled*.

PCI/Plug and Play Setup

Plug and Play-Aware OS

The settings for this option are **No** or Yes. Set this option to Yes if the operating system in the computer is aware of and follows the Plug and Play specification. AMIBIOS only detects and enables PnP ISA adapter cards that are required for system boot. Currently, only Windows 95 is PnP-

Aware. Set this option to *No* if the operating system (such as DOS, OS/2, Windows 3.x) does not use PnP. You must set this option correctly. Otherwise, PnP-aware adapter cards installed in the computer will not be configured properly.

PCI Latency Timer (PCI Clocks)

This option specifies the latency timings in PCI clocks for all PCI devices. The settings are 32, **64**, 96, 128, 160, 192, 224, or 248.

PCI VGA Palette Snoop

The settings for this option are **Disabled** or **Enabled**. When set to **Enabled**, multiple VGA devices operating on different buses can handle data from the CPU on each set of palette registers on every video device. Bit 5 of the command register in the PCI device configuration space is the VGA Palette Snoop bit (0 is disabled). For example: if there are two VGA devices in the computer (one PCI and one ISA) and this option is disabled, data read and written by the CPU is only directed to the PCI VGA device's palette registers. If enabled, data read and written by the CPU is directed to both the PCI VGA device's palette registers and the ISA VGA palette registers. This will permit the palette registers of both devices to be identical. This option must be set to **Enabled** if any ISA adapter card installed in the system requires VGA palette snooping.

PCI IDE Busmaster

The settings for this option are **Disabled** or **Enabled**. Set to **Enabled** to specify the IDE Controller on the PCI bus has bus mastering capabilities. Under Windows 95, you should set this option to **Disabled** and install the Bus Mastering driver.

Offboard PCI IDE Card

This option specifies if an offboard PCI IDE controller adapter card is installed in the computer. The PCI expansion slot on the motherboard where the offboard PCI IDE controller is installed must be specified. If an offboard PCI IDE controller is used, the onboard IDE controller is automatically disabled. The settings are **Auto** (AMIBIOS automatically determines where the offboard PCI IDE controller adapter card is installed), *Slot 1*, *Slot 2*, *Slot 3*, *Slot 4*, *Slot 5* and *Slot 6*.

This option forces IRQ14 and IRQ15 to a PCI slot on the PCI local bus. This is necessary to support non-compliant ISA IDE controller adapter cards. If an offboard PCI IDE controller adapter card is installed in the computer, you must also set the Offboard PCI IDE Primary IRQ and Offboard PCI IDE Secondary IRQ options.

Offboard PCI IDE Primary IRQ**Offboard PCI IDE Secondary IRQ**

These options specify the PCI interrupt used by the primary (or secondary) IDE channel on the offboard PCI IDE controller. The settings are **Disabled**, **Hardwired**, **INTA**, **INTB**, **INTC**, and **INTD**.

PCI Slot1 & AGP Slot IRQ**PCI Slot2 IRQ****PCI Slot3 & PCI Slot 1, 2 IRQ****PCI Slot4 IRQ**

Use these options to specify the IRQ priority for PCI devices installed in the PCI expansion slots. The settings are **Auto**, (**IRQ**) **3**, **4**, **5**, **7**, **9**, **10**, **11** and **14**, in priority order.

DMA Channel 0**DMA Channel 1****DMA Channel 3****DMA Channel 5****DMA Channel 6****DMA Channel 7**

These DMA channels control the data transfers between the I/O devices and the system memory. The chipset allows the BIOS to choose which channels to do the job. The settings are **PnP** or **ISA/EISA**.

IRQ3**IRQ4****IRQ5****IRQ7****IRQ9****IRQ10****IRQ11****IRQ14****IRQ15**

These options specify which bus the specified IRQ line is used on and allow you to reserve IRQs for legacy ISA adapter cards. If more IRQs must be removed from the pool, the end user can use these options to reserve the IRQ by assigning an **ISA/EISA** setting to it. Onboard I/O is configured by AMIBIOS. All IRQs used by onboard I/O are configured as **PCI/PnP**.

IRQ14 and 15 will not be available if the onboard PCI IDE is enabled. If all IRQs are set to **ISA/EISA** and IRQ14 and 15 are allocated to the onboard PCI IDE, IRQ 9 will still be available for PCI and PnP devices. This is because at

least one IRQ must be available for PCI and PnP devices. The settings are **PCI/PnP** or **ISA/EISA**. (See page 3-5 for information on shared IRQs.)

Reserved Memory Size

This option specifies the size of the memory area reserved for legacy ISA adapter cards. The settings are **Disabled**, **16K**, **32K** or **64K**.

Reserved Memory Address

This option specifies the beginning address (in hex) of the reserved memory area. The specified ROM memory area is reserved for use by legacy ISA adapter cards. The settings are **C0000**, **C4000**, **C8000**, **CC000**, **D0000**, **D4000**, **D8000** or **DC000**.

Peripheral Setup

Onboard SCSI

This setting enables or disables the onboard SCSI (non-applicable to the PIIIDME). The settings are **Enabled** and **Disabled**.

CPU1 Current Temperature

The current temperature of CPU1 is displayed here.

CPU2 Current Temperature

The current temperature of CPU2 is displayed here.

CPU Overheat Warning

The settings for this option are **Enabled** or **Disabled**. When set to **Enabled** this option allows the user to set an overheat warning temperature.

CPU Overheat Warning Temperature

Use this option to set the CPU overheat warning temperature. The settings are 25 °C through 75 °C in 1 °C intervals. **Note: The Optimal and Fail-Safe default settings are 55 °C.**

H/W Monitor IN0 (CPU1)

H/W Monitor IN1 (CPU2)

H/W Monitor IN2 (+3.3V)

H/W Monitor IN3 (+5V)

H/W Monitor IN4 (+12V)

CPU1 Fan

CPU2 Fan

Chassis Fan1**Chassis Fan2**

The above features are for PC Health Monitoring. The motherboards with W83781D have seven onboard voltage monitors for the CPU core, CPU I/O, +3.3V, +5V, -5V, +12V, and -12V, and for the four-fan status monitor.

OnBoard IDE

This option enables the IDE (Hard Disk Drive Controller) drives(s) on the motherboard. The settings are *Disabled*, *Primary*, *Secondary* and **Both**.

OnBoard FDC

This option enables the FDC (Floppy Drive Controller) on the motherboard. The settings are *Disabled* and **Enabled**.

OnBoard Serial Port1

This option specifies the base I/O port address of serial port 1. The settings are *Disabled*, **3F8h**, **2F8h**, **3E8h** and **2E8h**.

OnBoard Serial Port2

This option specifies the base I/O port address of serial port 2. The settings are *Disabled*, **3F8h**, **2F8h**, **3E8h** and **2E8h**.

Serial Port2 Mode

The settings for this option are **Normal**, *IrDA SIR-A.*, *IrDA SIR-B*, *ASKIR*, *Consumer* and *Raw IR*. When set to anything but **Normal**, the IR Duplex Mode becomes available and can be set to either *Half* or **Full**.

Serial Port2 Duplex Mode

This option is enabled by the selection made in the previous Serial Port 2 Mode option. This makes the IR Duplex Mode available, which can be set to either *Half* or **Full**.

Onboard Parallel Port

This option specifies the base I/O port address of the parallel port on the motherboard. The settings are *Auto* (AMIBIOS automatically determines the correct base I/O port address), *Disabled*, **378h**, **278h** and **38Ch**.

Parallel Port Mode

This option specifies the parallel port mode. The settings are **Normal**, **EPP** and **ECP**. When set to **Normal**, the normal parallel port mode is used. Use *Bi-Dir* to support bidirectional transfers. Use **EPP** (Enhanced Parallel Port) to provide asymmetric bidirectional

data transfer driven by the host device. Use *ECP* (Extended Capabilities Port) to achieve data transfer rates of up to 2.5 Mbps. ECP uses the DMA protocol and provides symmetric bidirectional communication. **Note: The Optimal default setting for this option is ECP and the Fail-Safe setting is Normal.**

EPP Version

The settings are *Enabled* and *Disabled*. **Note: The Optimal and Fail-Safe default settings are N/A.**

Parallel Port IRQ

This option specifies the IRQ to be used by the parallel port. The settings are *5* and *7*.

Parallel Port ECP DMA Channel

This option is only available if the setting of the parallel port mode option is *ECP*. The settings are *0, 1, 2, 3, 5, 6* and *7*.

Onboard MIDI Port

This option specifies the base address to be used for the MIDI port. The settings are *Disabled, 300h* and ***330h***.

MIDI IRQ

This option specifies the IRQ to be used for the parallel port. The settings are ***5, 7, 9*** and *10*.

Onboard Game Port

This option is used to either ***Enable*** or *Disable* the Game Port.

Auto-Detect Hard Disks

This section allows BIOS to look for and configure any hard disk drives on your system. After highlighting this option, hit <Enter> and wait momentarily while BIOS performs the auto-detect. You will soon see the disk drives appear properly configured.

Change User Password

Change Supervisor Password

The system can be configured so that all users must enter a password every time the system boots or when the AMIBIOS setup is executed. You can set either a Supervisor password or a User password. If you do not want to use a password, just press <Enter> when the password prompt appears.

The password check option is enabled in the Advanced Setup by choosing either *Always* or *Setup*. The password is stored in CMOS RAM. You can enter a password by typing it out on the keyboard or by selecting each letter via the mouse or a pen stylus. Pen access must be customized for each specific hardware platform.

When you select to change the Supervisor or User password, AMIBIOS prompts you for the new password. You must set the Supervisor password before you can set the User password. Enter a 1-6 character password. (It will not appear on the screen when typed.) Retype the new password as prompted and press <Enter>. Make sure you write it down. If you forget it, you must clear CMOS RAM and reset the password.

Change Language Setting

Because this version of BIOS only supports English at this time, this setting cannot be chosen. Future releases may support other languages.

Auto Configuration with Optimal Settings

The Optimal default settings provide optimum performance settings for all devices and system features.

Auto Configuration with Fail Safe Settings

The Fail-Safe default settings consist of the safest set of parameters. Use them if the system is behaving erratically. They should always work but do not provide optimal system performance characteristics.

Save Settings and Exit

Highlight this and hit <Enter> when you wish to save any changes made to settings in BIOS and exit back to the system boot-up procedure.

Exit Without Saving

Highlight this and hit <Enter> when you wish to exit back to the system boot-up procedure without saving any changes.

Notes

Appendix A

BIOS Error Beep Codes & Messages

During the POST (Power-On Self-Test) routines, which are performed each time the system is powered on, errors may occur.

Non-fatal errors are those which, in most cases, allow the system to continue the boot-up process. The error messages normally appear on the screen.

Fatal errors are those which will not allow the system to continue the boot-up procedure. If a fatal error occurs, you should consult with your system manufacturer for possible repairs.

These fatal errors are usually communicated through a series of audible beeps. The numbers on the fatal error list, on the following page, correspond to the number of beeps for the corresponding error. All errors listed, with the exception of #8, are fatal errors.

Beeps	Error message	Description
1	Refresh Failure	The memory refresh circuitry on the motherboard is faulty.
2	Parity Error	A parity error was detected in the base memory (the first 64 KB block) of the system.
3	Base 64 KB Memory Failure	A memory failure occurred within the first 64 KB of memory.
4	Timer Not Operational	A memory failure was detected in the first 64 KB of memory, or Timer 1 is not functioning.
5	Processor Error	The CPU on the system board generated an error.
6	8042 - Gate A20 Failure	The keyboard controller (8042) contains the Gate A20 switch which allows the CPU to operate in virtual mode. This error means that the BIOS cannot switch the CPU into protected mode.
7	Processor Exception Interrupt Error	The CPU on the motherboard generated an exception interrupt.
8	Display Memory Read/Write Error	The system video adapter is either missing or its memory is faulty. Please Note: This is not a fatal error.
9	ROM Checksum Error	The ROM checksum value does not match the value encoded in the BIOS.
10	CMOS Shutdown Register Read/Write Error	The shutdown register for CMOS memory has failed.

Refer to the table on page A-3 for solutions to the error beep codes.

If it beeps...	then ...
1, 2, 3 times	reseat the DIMM memory. If the system still beeps, replace the memory.
6 times	reseat the keyboard controller chip. If it still beeps, replace the keyboard controller. If it still beeps, try a different keyboard, or replace the keyboard fuse, if the keyboard has one.
8 times	there is a memory error on the video adapter. Replace the video adapter, or the RAM on the video adapter.
9 times	the BIOS ROM chip is bad. The system probably needs a new BIOS ROM chip.
4, 5, 7, or 10 times	the motherboard must be replaced.

If you hear...	it's because...
5 short and 1 long beeps	no memory is installed
8 short and 1 long beeps	EDO memory is installed
6 short and 1 long beeps	registered or buffered memory is installed

Error Message	Information
8042 Gate -- A20 Error	Gate A20 on the keyboard controller (8042) is not working. Replace the 8042.
Address Line Short!	Error in the address decoding circuitry on the motherboard.
C: Drive Error	Hard disk drive C: does not respond. Run the Hard Disk Utility to correct this problem. Also, check the C: hard disk type in Standard Setup to make sure that the hard disk type is correct.
C: Drive Failure	Hard disk drive C: does not respond. Replace the hard disk drive.
Cache Memory Bad	Cache memory is defective. Replace it. Do Not Enable Cache!
CH-2 Timer Error	Most ISA computers include two times. There is an error in time 2.
CMOS Battery State Low	CMOS RAM is powered by a battery. The battery power is low. Replace the battery.
CMOS Checksum Failure	After CMOS RAM values are saved, a checksum value is generated for error checking. The previous value is different from the current value. Run WINBIOS Setup or AMIBIOS Setup.
CMOS System Option Not Set	The values stored in CMOS RAM are either corrupt or nonexistent. Run WINBIOS Setup or AMIBIOS Setup.
CMOS Display Type Mismatch	The video type in CMOS RAM does not match the type detected by the BIOS. Run WINBIOS Setup or AMIBIOS Setup.
CMOS Memory Size Mismatch	The amount of memory on the motherboard is different than the amount in CMOS RAM. Run WINBIOS Setup or AMIBIOS Setup.

Error Message	Information
CMOS Time and Date Not Set	Run Standard Setup to set the date and time in CMOS RAM.
D: Drive Error	Hard disk drive D: does not respond. Run the Hard Disk Utility. Also check the D: hard disk type in Standard Setup to make sure that the hard disk drive type is correct.
D: Drive Failure	Hard disk drive D: does not respond. Replace the hard disk.
Diskette Boot Failure	The boot disk in floppy drive A: is corrupt. It cannot be used to boot the computer. Use another boot disk and follow the screen instructions.
Display Switch Not Proper	Some computers require a video switch on the motherboard be set to either color or monochrome. Turn the computer off, set the switch, then power on.
DMA Error	Error in the DMA controller.
DMA #1 Error	Error in the first DMA channel.
DMA #2 Error	Error in the second DMA channel.
FDD Controller Failure	The BIOS cannot communicate with the floppy disk drive controller. Check all appropriate connections after the computer is powered down.
HDD Controller Failure	The BIOS cannot communicate with the hard disk drive controller. Check all appropriate connections after the computer is powered down.
INTR #1 Error	Interrupt channel 1 failed POST.
INTR #2 Error	Interrupt channel 2 failed POST.

Error Message	Information
Invalid Boot Diskette	The BIOS can read the disk in floppy drive A:, but cannot boot the computer. Use another boot disk.
Keyboard Is Locked... Unlock It	The keyboard lock on the computer is engaged. The computer must be unlocked to continue.
Keyboard Error	There is a timing problem with the keyboard. Set the <i>Keyboard</i> options in Standard Setup to <i>Not Installed</i> to skip the keyboard post routines.
KB/Interface Error	There is an error in the keyboard connector.
No ROM BASIC	Cannot find a bootable sector on either disk drive A: or hard disk drive C:. The BIOS calls INT 18h which generates this message. Use a bootable disk.
Off Board Parity Error	Parity error in memory installed in an expansion slot. The format is: OFF BOARD PARITY ERROR ADDR (HEX) = (XXXX) XXXX is the hex address where the error occurred. Run AMIDdiag to find and correct memory problems.
On Board Parity Error	Parity error in motherboard memory. The format is: ON BOARD PARITY ERROR ADDR (HEX) = (XXXX) XXXX is the hex address where the error occurred. Run AMIDdiag to find and correct memory problems.
Parity Error????	Parity error in system memory at an unknown address. Run AMIDdiag to find and correct memory problems.

Appendix B

AMIBIOS POST Diagnostic Error Messages

This section describes the power-on self-tests (POST) port 80 codes for the AMIBIOS.

Check

<u>Point</u>	<u>Description</u>
00	Code copying to specific areas is done. Passing control to INT 19h boot loader next.
03	NMI is Disabled. Next, checking for a soft reset or a power-on condition.
05	The BIOS stack has been built. Next, disabling cache memory.
06	Uncompressing the post code unit next.
07	Next, initializing the CPU init and the CPU data area.
08	The CMOS checksum calculation is done next.
0B	Next, performing any required initialization before keyboard BAT command is issued.
0C	The keyboard controller I/B is free. Next, issuing the BAT command to the keyboard controller.
0E	The keyboard controller BAT command result has been verified. Next, performing any necessary initialization after the keyboard controller BAT command test.
0F	The initialization after the keyboard controller BAT command test is done. The keyboard command byte is written next.

Check Point	<u>Description</u>
10	The keyboard controller command byte is written. Next, issuing the pin 23 and 24 blocking and unblocking commands.
11	Next, checking if the <End or <Ins> keys were pressed during power on. Initializing CMOS RAM if the Initialize CMOS RAM in every boot AMIBIOS POST option was set in AMIBCP or the <End> key was pressed.
12	Next, disabling DMA controllers 1 and 2 and interrupt controllers 1 and 2.
13	The video display has been disabled. Port B has been initialized. Next, initializing the chipset.
14	The 8254 timer test will begin next.
19	The 8254 timer test is over. Starting the memory refresh test next.
1A	The memory refresh test line is toggling. Checking the 15 second on/off time next.
23	Reading the 8042 input port and disabling the MEGAKEY Green PC feature next. Making the BIOS code segment writable and performing any necessary configuration before initializing the interrupt vectors.
24	The configuration required before interrupt vector initialization has completed. Interrupt vector initialization is done. Clearing the password if the POST DIAG switch is on.
25	Interrupt vector initialization is done. Clearing the password if the POST DIAG Switch is on.
27	Any initialization before setting video mode will be done next.

Check Point	Description
28	Initialization before setting the video mode is complete. Configuring the monochrome mode and color mode settings next.
2A	Bus initialization system, static, output devices will be done next, if present.
2B	Passing control to the video ROM to perform any required configuration before the video ROM test.
2C	All necessary processing before passing control to the video ROM is done. Looking for the video ROM next and passing control to it.
2D	The video ROM has returned control to BIOS POST. Performing any required processing after the video ROM had control.
2E	Completed post-video ROM test processing. If the EGA/VGA controller is not found, performing the display memory read/write test next.
2F	The EGA/VGA controller was not found. The display memory read/write test is about to begin.
30	The display memory read/write test passed. Look for retrace checking next.
31	The display memory read/write test or retrace checking failed. Performing the alternate display memory read/write test next.
32	The alternate display memory read/write test passed. Looking for alternate display retrace checking next.
34	Video display checking is over. Setting the display mode next.
37	The display mode is set. Displaying the power on message next.

Check Point	<u>Description</u>
38	Initializing the bus input, IPL, and general devices next, if present.
39	Displaying bus initialization error messages.
3A	The new cursor position has been read and saved. Displaying the Hit message next.
40	Preparing the descriptor tables next.
42	The descriptor tables are prepared. Entering protected mode for the memory test next.
43	Entered protected mode. Enabling interrupts for diagnostics mode next.
44	Interrupts enabled if the diagnostics switch is on. Initializing data to check memory wraparound at 0:0 next.
45	Data initialized. Checking for memory wraparound at 0:0 and finding the total system memory size next.
46	The memory wraparound test has completed. The memory size calculation has been completed. Writing patterns to test memory next.
47	The memory pattern has been written to extended memory. Writing patterns to the base 640 KB memory next.
48	Patterns written in base memory. Determining the amount of memory below 1 MB next.
49	The amount of memory below 1 MB has been found and verified. Determining the amount of memory above 1 MB memory next.
4B	The amount of memory above 1 MB has been found and verified. Checking for a soft reset and clearing the memory below 1 MB for the soft reset next. If this is a power on situation, going to checkpoint 4Eh next.

Check Point	Description
4C	The memory below 1 MB has been cleared via a soft reset. Clearing the memory above 1 MB next.
4D	The memory above 1 MB has been cleared via a soft reset. Saving the memory size next. Going to checkpoint 52h next.
4E	The memory test started, but not as the result of a soft reset. Displaying the first 64 KB memory size next.
4F	The memory size display has started. The display is updated during the memory test. Performing the sequential and random memory test next.
50	The memory below 1 MB has been tested and initialized. Adjusting the displayed memory size for relocation and shadowing next.
51	The memory size display was adjusted for relocation and shadowing. Testing the memory above 1 MB next.
52	The memory above 1 MB has been tested and initialized. Saving the memory size information next.
53	The memory size information and the CPU registers are saved. Entering real mode next.
54	Shutdown was successful. The CPU is in real mode. Disabling the Gate A20 line, parity, and the NMI next.
57	The A20 address line, parity, and the NMI are disabled. Adjusting the memory size depending on relocation and shadowing next.
58	The memory size was adjusted for relocation and shadowing. Clearing the Hit message next.
59	The Hit message is cleared. The <WAIT> message is displayed. Starting the DMA and interrupt controller test next.

Check Point	<u>Description</u>
60	The DMA page register test passed. Performing the DMA Controller 1 base register test next.
62	The DMA controller 1 base register test passed. Performing the DMA controller 2 base register test next.
65	The DMA controller 2 base register test passed. Programming DMA controllers 1 and 2 next.
66	Completed programming DMA controllers 1 and 2. Initializing the 8259 interrupt controller next.
7F	Extended NMI source enabling is in progress.
80	The keyboard test has started. Clearing the output buffer and checking for stuck keys. Issuing the keyboard reset command next.
81	A keyboard reset error or stuck key was found. Issuing the keyboard controller interface test command next.
82	The keyboard controller interface test completed. Writing the command byte and initializing the circular buffer next.
83	The command byte was written and global data initialization has been completed. Checking for a locked key next.
84	Locked key checking is over. Checking for a memory size mismatch with CMOS RAM data next.
85	The memory size check is done. Displaying a soft error and checking for a password or bypassing WINBIOS Setup next.
86	The password was checked. Performing any required programming before WINBIOS Setup next.

Check Point	Description
87	The programming before WINBIOS Setup has been completed. Uncompressing the WINBIOS Setup code and executing the AMIBIOS Setup or WINBIOS Setup utility next.
88	Returned from WINBIOS Setup and cleared the screen. Performing any necessary programming after WINBIOS Setup next.
89	The programming after WINBIOS Setup has been completed. Displaying the power-on screen message next.
8B	The first screen message has been displayed. The <WAIT...> message is displayed. Performing the PS/2 mouse check and extended BIOS data area allocation check next.
8C	Programming the WINBIOS Setup options next.
8D	The WINBIOS Setup options are programmed. Resetting the hard disk controller next.
8F	The hard disk controller has been reset. Configuring the floppy drive controller next.
91	The floppy drive controller has been configured. Configuring the hard disk drive controller next.
95	Initializing the bus option ROMs from C800 next.
96	Initializing before passing control to the adaptor ROM at C800.
97	Initialization before the C800 adaptor ROM gains control has been completed. The adaptor ROM check is next.
98	The adaptor ROM had control and has now returned control to BIOS POST. Performing any required processing after the option ROM returned control.

Check Point	<u>Description</u>
99	Any initialization required after the option ROM test has been completed. Configuring the timer data area and printer base address next.
9A	Set the timer and printer base addresses. Setting the RS-232 base address next.
9B	Returned after setting the RS-232 base address. Performing any required initialization before the Coprocessor test next.
9C	Required initialization before the Coprocessor test is over. Initializing the Coprocessor next.
9D	Coprocessor initialized. Performing any required initialization after the Coprocessor test next.
9E	Initialization after the Coprocessor test is complete. Checking the extended keyboard, keyboard ID, and Num Lock key next. Issuing the keyboard ID command next.
A2	Displaying any soft errors next.
A3	The soft error display has completed. Setting the keyboard typematic rate next.
A4	The keyboard typematic rate is set. Programming the memory wait states next.
A5	Memory wait state programming is over. Clearing the screen and enabling parity and the NMI next.
A7	NMI and parity enabled. Performing any initialization required before passing control to the adaptor ROM at E000 next.
A8	Initialization before passing control to the adaptor ROM at E000h completed. Passing control to the adaptor ROM at E000h next.

Check Point	Description
A9	Returned from adaptor ROM at E000h control. Next, performing any initialization required after the E000 option ROM had control.
AA	Initialization after E000 option ROM control has completed. Displaying the system configuration next.
AB	Building the multiprocessor table, if necessary. POST next.
B0	The system configuration is displayed.
AC	Uncompressing the DMI data and initializing DMI.
B1	Copying any code to specific areas.
D0h	The NMI is disabled. Power on delay is starting. Next, the initialization code checksum will be verified.
D1h	Initializing the DMA controller. Performing the keyboard controller BAT test. Starting memory refresh, and entering 4 GB flat mode next.
D3h	Starting memory sizing next.
D4h	Returning to real mode. Executing any OEM patches and setting the stack next.
D5h	Passing control to the uncompressed code in shadow RAM at E000:0000h. The initialization code is copied to segment 0 and control will be transferred to segment 0.
D6h	Control is in segment 0. Next, checking if <Ctrl><Home> was pressed and verifying the system BIOS checksum. If either <Ctrl><Home> was pressed or the system BIOS checksum is bad, next the system will go to checkpoint code E0h. Otherwise, going to checkpoint code D7h.

Notes