



# SY-K7VTA PRO Motherboard

\*\*\*\*\*

AMD® Athlon/Duron™

Processor supported

VIA KT133A AGP/PCI Motherboard

266 MHz Front Side Bus supported

ATX Form Factor

\*\*\*\*\*

## User's Manual

Copyright © 2001 by Soyo Computer Inc.

**Trademarks:**

Soyo is the registered trademark of Soyo Computer Inc. All trademarks are the properties of their owners.

**Product Rights:**

All names of the product and corporate mentioned in this publication are used for identification purposes only. The registered trademarks and copyrights belong to their respective companies.

**Copyright Notice:**

All rights reserved. This manual has been copyrighted by Soyo Computer Inc. No part of this manual may be reproduced, transmitted, transcribed, translated into any other language, or stored in a retrieval system, in any form or by any means, such as by electronic, mechanical, magnetic, optical, chemical, manual or otherwise, without permission in writing from Soyo Computer Inc.

**Disclaimer:**

Soyo Computer Inc. makes no representations or warranties regarding the contents of this manual. We reserve the right to amend the manual or revise the specifications of the product described in it from time to time without obligation to notify any person of such revision or amend. The information contained in this manual is provided to our customers for general use. Customers should be aware that the personal computer field is subject to many patents. All of our customers should ensure that their use of our products does not infringe upon any patents. It is the policy of Soyo Computer Inc. to respect the valid patent rights of third parties and not to infringe upon or to cause others to infringe upon such rights.

**Restricted Rights Legend:**

Use, duplication, or disclosure by the Government is subject to restrictions set forth in subparagraph (c)(1)(ii) of the Rights in Technical Data and Computer Software clause at 252.277-7013.

**About This Guide:**

This Quick Start Guide can help system manufacturers and end users in setting up and installing the Motherboard. Information in this guide has been carefully checked for reliability; however, to the correctness of the contents there is no guarantee given. The information in this document is subject to amend without notice.

For further information, please visit our **Web Site** on the Internet. The address is "<http://www.soyo.com.tw>".

**Edition: May 2001**  
**Version 1.1**  
**K7VTA PRO SERIAL**

**FC** Tested To Comply  
With FCC Standards  
FOR HOME OR OFFICE USE

**100%** POST CONSUMER  
RECYCLED PAPER

# Table of Contents

<b>CHAPTER 1</b>	<b>MOTHERBOARD DESCRIPTION .....</b>	<b>1</b>
1-1	INTRODUCTION .....	1
1-2	KEY FEATURES .....	1
1-3	ELECTROSTATIC DISCHARGE PRECAUTIONS .....	5
1-4	SY-K7VTA PRO MOTHERBOARD LAYOUT .....	6
1-5	SY-K7VTA PRO MOTHERBOARD COMPONENTS.....	7
1-6	MICROPROCESSOR.....	9
1-7	MEMORY .....	10
1-8	CHIPSET .....	12
1-9	I/O INTERFACE CONTROLLER .....	15
1-10	HARDWARE MONITOR.....	17
1-11	WAKE ON LAN TECHNOLOGY .....	18
<b>CHAPTER 2</b>	<b>HARDWARE INSTALLATION .....</b>	<b>19</b>
2-1	PREPARATIONS .....	19
2-2	UNPACKING THE MOTHERBOARD .....	20
2-3	INSTALLATION GUIDE .....	21
2-3.1	<i>CPU Installation.....</i>	<i>22</i>
2-3.2	<i>SDRAM Memory Module Installation.....</i>	<i>26</i>
2-3.3	<i>Motherboard Connector.....</i>	<i>28</i>
2-3.4	<i>Jumper Setting .....</i>	<i>42</i>
2-3.5	<i>Voice Doctor.....</i>	<i>44</i>
2-3.6	<i>CMOS Clearing (JP5).....</i>	<i>44</i>
2-3.7	<i>Power On.....</i>	<i>45</i>
2-3.8	<i>Quick BIOS Setup.....</i>	<i>46</i>
2-3.9	<i>Troubleshooting at First Start .....</i>	<i>47</i>
2-3.10	<i>Power Off.....</i>	<i>50</i>
<b>CHAPTER 3</b>	<b>BIOS SETUP UTILITY .....</b>	<b>51</b>

---

3-1	SOYO COMBO SETUP .....	54
3-2	STANDARD CMOS SETUP .....	57
3-3	ADVANCED BIOS FEATURES.....	60
3-4	ADVANCED CHIPSET FEATURES.....	64
3-5	INTEGRATED PERIPHERALS .....	69
3-6	POWER MANAGEMENT SETUP .....	74
3-7	PNP/PCI CONFIGURATION SETUP.....	78
3-8	PC HEALTH STATUS.....	81
3-9	LOAD FAIL-SAFE DEFAULTS.....	83
3-10	LOAD OPTIMIZED DEFAULTS.....	84
3-11	SUPERVISOR PASSWORD.....	85
3-12	USER PASSWORD.....	86
3-13	IDE HDD AUTO DETECTION .....	87
3-14	BOOT MENU .....	88
<b>CHAPTER 4 DRIVER INSTALLATION.....</b>		<b>89</b>

## Chapter 1

# MOTHERBOARD DESCRIPTION

### 1-1 INTRODUCTION

The **SY-K7VTA PRO** AGP/PCI/ISA Motherboard is a high-performance Socket 462 ATX form-factor system board. The **SY-K7VTA PRO** uses VIA Chipset technology and supports Socket 462 class processors. This Motherboard is fully compatible with industry standards and adds many technical enhancements.

### 1-2 KEY FEATURES

#### ➤ CPU SUPPORT

The SY-K7VTA PRO supports THE FOLLOWING AMD® CPUs:

- ❑ Supports 200MHz Front Side Bus DDR(Double Data Rate) transfer on Athlon(750MHz~1.2GHz)/Duron™(600MHz~800MHz)
- ❑ Supports 266MHz Front Side Bus DDR (Double Data Rate) transfer on Athlon(1GHz~1.2GHz)

New released AMD Socket 462 CPUs will very likely be supported by the SY-K7VTA PRO as well.

#### ➤ CPU SETTINGS

The SY-K7VTA PRO provides the user with a very complete and convenient CPU setting environment. The CPU settings are all adjusted through the special SOYO COMBO page in the BIOS, therefore rendering the use of jumpers obsolete.

##### ■ CPU Frequency

The SY-K7VTA PRO supports an incredible wide range of CPU frequency settings:

600,650,700,750,800,850,900,950,1000+MHz.

This gives the SY-K7VTA PRO an overwhelming overclocking potential.

- **CPU Multiplier**

➤ **EXPANDABILITY**

The SY-K7VTA PRO provides all the standard expansion slots, and many more additional expansion features:

- ◆ **Expansion slots**

- 1 x 32-bit bus master AGP slot
- 5 x 32-bit bus master PCI slots
- 1 x 16-bit ISA slots

- ◆ **Enhanced IO**

- Floppy disk controller
- 2x EIDE controllers with support for up to 4 Ultra DMA 33/66/100 devices
- Standard/EPP/ECP parallel port
- 2x 16550 compatible serial ports
- IrDA compatible infrared port
- 4x USB (Universal Serial Bus) connectors
- PS/2 mouse connector
- PS/2 keyboard connector

➤ **ADVANCED FUNCTIONS**

The SY-K7VTA PRO supports advanced functions such as:

■ **Wake-On-LAN**

Supports Wake-On-LAN (*Some advanced network cards can wake the system up over the network, the WOL connector is provided by the SY-K7VTA PRO to support this function*).

■ **Multiple boot**

The SY-K7VTA PRO supports booting from devices such as CD-ROM, FLOPPY DRIVE & HDD, LS120, SCSI, ZIP.

■ **Power on by modem or alarm**

If the SY-K7VTA PRO system is in suspend mode, it can be switched back on through the modem or RTC alarm function. This opens a lot of possibilities, such as remote access that switches the system on only after the modem receives a call.

➤ **FAIL SAFE**

The SY-K7VTA PRO comes with added functionality to make managing the system easy and safe

◆ **Hardware Monitor**

The integrated Hardware Monitor IC and Hardware doctor software enables the user to monitor system voltages, temperatures and FAN speeds. This makes sure that the user is in full control of the system

◆ **Power Failure Resume Function**

This function can be set in the BIOS, and determines whether the system will automatically turn on again after a power failure. This function is indispensable for server systems that need to always be on line.

➤ **SOYO Bonus Pack CD-ROM**

➤ **COMPLIANCE**

The SY-K7VTA PRO complies with all important industry standards. The following underlines the reliability of the SY-K7VTA PRO, a motherboard to trust.

■ **PC99, ACPI compliant**

➤ **USER FRIENDLY**

- SOYO Combo Setup
- Jumperless design
- You can set up the following options through the BIOS setting
  - CPU FSB frequency
  - CPU multiplier by H/W switch
  - CPU Vcore voltage
  - PCI clock
  - AGP Clock
  - SDRAM Clock

➤ **Voice Doctor**

If the system does not boot-up properly, the Voice Doctor will inform the user by voice through internal/external speaker at what point in boot-up sequence the problem arises.

Below are the possible errors the user may encounter:

1. The Processor might be damaged or not installed properly
2. The memory module might be damaged or not installed properly
3. VGA card might be damaged or not inserted properly
4. No Keyboard connected
5. Defective HD-Driver (IDE)
6. Floppy might error



## ➤ **HANDLING THE MOTHERBOARD**

To avoid damage to your Motherboard, follow these simple rules while unpacking:

- Before handling the Motherboard, ground yourself by grasping an unpainted portion of the system's metal chassis.
- Remove the Motherboard from its anti-static packaging. Hold the Motherboard by the edges and avoid touching its components.
- Check the Motherboard for damage. If any chip appears loose, press carefully to seat it firmly in its socket.



---

**Warning:** Do not apply power if the Motherboard appears damaged. If there is damage to the board, contact your dealer immediately.

---

## **1-3 ELECTROSTATIC DISCHARGE PRECAUTIONS**

Make sure to ground yourself before handling the Motherboard or other system components. Electrostatic discharge can easily damage the components. Note that you must take special precautions when handling the Motherboard in dry or air-conditioned environment.

To protect your equipment from electrostatic discharge, take the following precautions:

- Do not remove the anti-static packaging until you are ready to install.
- Ground yourself before removing any system component from its protective anti-static packaging. (To ground yourself, grasp the expansion slot covers or other unpainted portions of the computer chassis.)
- Frequently ground yourself while working or use a grounding strap.
- Handle the Motherboard by its edges and avoid touching its components.

## 1-4 SY-K7VTA PRO MOTHERBOARD LAYOUT

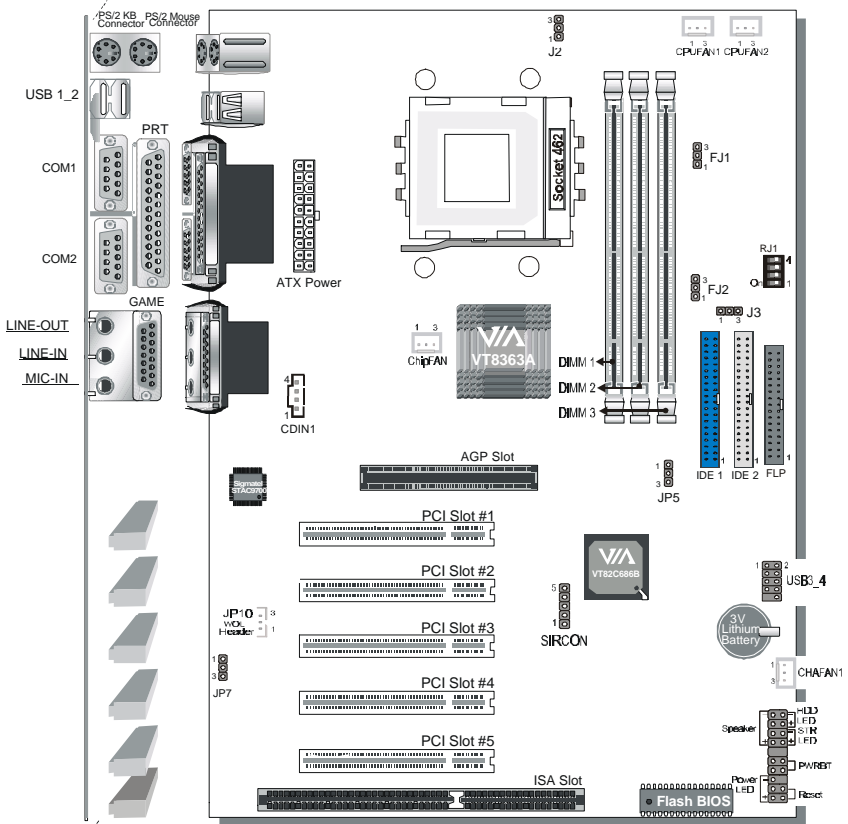

Back Panel

SY-K7VTA PRO Platform

### 1-5 SY-K7VTA PRO MOTHERBOARD COMPONENTS

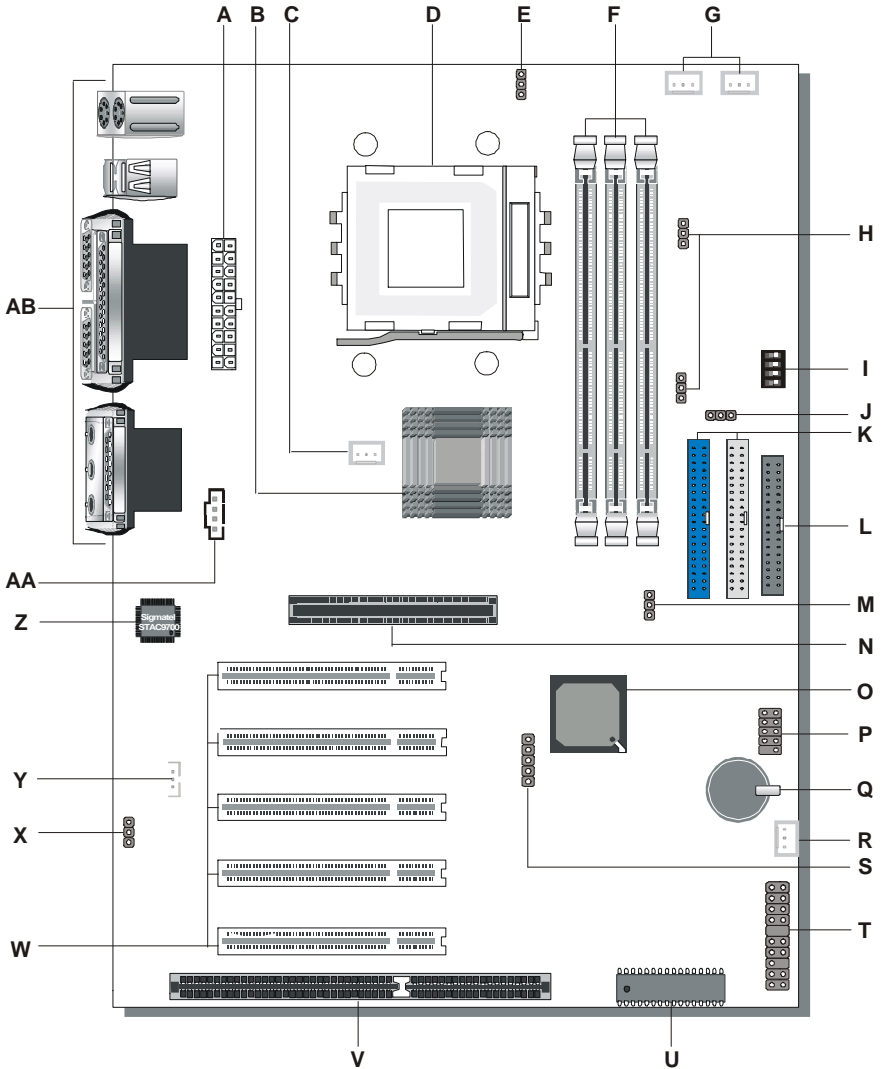

- A ATX Power Supply Connector**
- B Via VT8363A North Bridge chip**
- C Chipset Cooling Fan Connector**
- D Socket 462 Connector**
- E Frequency Multiplier setting Jumper**
- F DIMM Banks**
- G CPU Cooling Fan Connector**
- H CPU FSB setting Jumper**
- I Ratio adjustment setting switch**
- J Frequency Multiplier setting Jumper**
- K Bus Mastering E-IDE/ATAPI Ports**
- L Floppy Disk Drive (FDD) Port**
- M CMOS Clear Jumper**
- N 32-bit AGP 1X/2X/4X Slot**
- O Via VT82C686B South Bridge Chip**
- P USB3\_4 Connectors**
- Q 3V Lithium Battery**
- R Chassis Cooling Fan**
- S Serial Infrared (IrDA) Device Header**
- T Front panel connectors**
- U Flash BIOS**
- V 16-bit ISA Slot**
- W 32-bit PCI Mastering Slots**
- X Voice Doctor Language Setting Jumper**
- Y Wake-On-LAN (WOL) Header**
- Z AC97 Codec Chip**
- AA CD In Connector**
- AB Back panel Connectors**

## **1-6 MICROPROCESSOR**

The motherboard supports a single Socket 462 processor. The processor's VID pins automatically program the voltage regulator on the motherboard to the required processor voltage. In addition, the front side bus speed (200 MHz ) is automatically selected. The motherboard supports all current Socket 462 processor speeds, voltages, and bus frequencies.

### **1-6.1 Microprocessor Packaging**

The CPU is packaged in a 462 pin PGA package. A fan must be used to ensure adequate cooling.

### **1-6.2 Second Level Cache**

The second-level cache is located on the substrate of the CPU package. The cache includes Athlon-256KB / Duron-64KB of synchronous pipelined burst static RAM. All supported onboard memory can be cached.

### **1-6.3 Microprocessor Upgrades**

The motherboard can be upgraded with Socket 462 processors that run at higher speeds. When upgrading the processor, use the BIOS configuration mode to change the processor speed.

## **1-7 MEMORY**

### **1-7.1 Main Memory**

The motherboard has three DIMM sockets. SDRAM can be installed in one, two, or three sockets. Using the serial presence detect (SPD) data structure, programmed into an E<sup>2</sup>PROM on the DIMM, the BIOS can determine the SDRAM's size and speed. Minimum DIMM memory size is 8 MB; maximum DIMM memory size is 256/512 MB. Memory size and speed can vary between sockets.

The motherboard supports the following memory features:

- DRAM interface synchronous with host CPU (66/100/133MHz) or AGP (66MHz) for more flexible configuration
- DRAM interface may be faster than CPU by 33 MHz to allow use of PC133 memory modules
- DRAM interface may be slower than CPU by 33 MHz to allow use of older memory modules with newer CPUs
- Concurrent CPU, AGP, and PCI access
- Supports SDRAM and VCM SDRAM memory types
- Different DRAM types may be used in mixed combinations
- Different DRAM timing for each bank
- Dynamic Clock Enable (CKE) control for SDRAM power reduction in high speed system.
- Mixed 1M/2M/4M/8M/16M/32MxN DRAMs
- The K7VTA PRO supports 3 DIMMs or 6 banks at 133MHz for 1.5GB (max memory)
- Flexible row and column addresses
- 64-bit data width and 3.3V DRAM interface
- Programmable I/O drive capability for MA, command, and MD signals
- Supports PC100 and PC133 SDRAM
- Two-bank interleaving for 16Mbit SDRAM support
- Two-bank and four bank interleaving for 64Mbit SDRAM support
- Independent SDRAM control for each bank

- Seamless DRAM command scheduling for maximum DRAM bus utilization (e.g., precharge other banks while accessing the current bank)
- Four cache lines (32quadwords) of CPU to DRAM write buffers
- Four cache lines 32 quadwords of CPU to DRAM read prefetch buffers
- Read around write capability for non-stalled CPU read
- Burst read and write operation
- BIOS shadow at 16KB increment
- Decoupled and burst DRAM refresh with staggered RAS timing
- CAS before RAS or self refresh

## **1-8 CHIPSET**

### **➤ VT8363A**

The KT133A chip set consists of the VT8363A system controller (552 pin BGA) and the VT82C686B PCI to ISA bridge (352 pin BGA). The system controller provides superior performance between the CPU, DRAM, AGP bus, and PCI bus with pipelined, burst, and concurrent operation.

The VT8363A support six banks of DRAMs up to 1.5GB. The DRAM controller supports standard Synchronous DRAM (SDRAM) and Virtual Channel SDRAM (VC SDRAM), in a flexible mix / match manner. The Synchronous DRAM interface allows zero wait state bursting between the DRAM and the data buffers at 66/100/133 MHz. The six banks of DRAM can be composed of an arbitrary mixture of 1M / 2M / 4M / 8M / 16M / 32MxN DRAMs.

The VT8363A system controller also supports full AGP v2.0 capability for maximum bus utilization including 1x, 2x and 4x mode transfers, SBA (SideBand Addressing), Flush/fence commands, and pipelined grants. An eight level request queue plus a four level post-write request queue with thirty-two and sixteen quadwords of read and write data FIFO's respectively are included for deep pipelined and split AGP transactions. A single-level GART TLB with 16 full associative entries and flexible CPU / AGP / PCI remapping control is also provided for operation under protected mode operating environments. Both Windows-95 VXD and Windows-98 / Windows 2000 miniport drivers are supported for interoperability with major AGP-based 3D and DVD-capable multimedia accelerators.

The VT8363A supports two 32-bit 3.3 / 5V system buses (one AGP and one PCI) that are synchronous / pseudo-synchronous to the CPU bus. The chip also contains a built-in bus-to-bus bridge to allow simultaneous concurrent operations on each bus. Five levels (doublewords) of post write buffers are included to allow for concurrent CPU and PCI operation. For PCI master operation, forty-eight levels (doublewords) of post write

---



buffers and sixteen levels (doublewords) of prefetch buffers are included for concurrent PCI bus and DRAM/cache accesses. The chip also supports enhanced PCI bus commands such as Memory-Read-Line, Memory-Read-Multiple and Memory-Write-Invalid commands to minimize snoop overhead. In addition, advanced features are supported such as snoop ahead, snoop filtering, L1/L2 write-back forward to PCI master, and L1/L2 write-back merged with PCI post write buffers to minimize PCI master read latency and DRAM utilization. Delay transaction and read caching mechanisms are also implemented for further improvement of overall system performance.

➤ **VT82C686B**

The VT82C686B PSIPC (PCI Super-I/O integrated Peripheral Controller) is a high integration, high performance, power-efficient, and high compatibility device that supports AMD and non-AMD based processor to PCI bus bridge functionality to make a complete Microsoft PC99-compliant PCI/ISA system. In addition to complete ISA extension bus functionality, the VT82C686B includes standard AMDLigent peripheral controllers:

- 1) Master mode enhanced IDE controller with dual channel DMA engine and interlaced dual channel commands. Dedicated FIFO coupled with scatter and gather master mode operation allows high performance transfers between PCI and IDE \devices. In addition to standard PIO and DMA mode operation, the VT82C686B also supports the UltraDMA-33 standard to allow reliable data transfer rates up to 33MB/sec throughput. The VT82C686B also supports the UltraDMA-66 standard. The IDE controller is SFF-8038I v1.0 and Microsoft Windows-family compliant.
- 2) Universal Serial Bus controller that is USB v1.1 and Universal HCI v1.1 compliant. The VT82C686B includes the root hub with four function ports with integrated physical layer transceivers. The USB controller allows hot plug and play and isochronous peripherals to be inserted into the system with universal driver support. The controller also implements legacy keyboard and mouse support so that legacy

software can run transparently in non-USB-aware operating system environment.

- 3) Keyboard controller with PS2 mouse support.
- 4) Real Time Clock with 256 byte extended CMOS. In addition to the standard ISA RTC functionality, the integrated RTC also includes the date alarm, century field, and other enhancements for compatibility with the ACPI standard.
- 5) Hardware monitoring subsystem for managing system/ motherboard voltage levels, temperatures, and fan speeds
- 6) Full System Management Bus (SMBus) interface.
- 7) Two 16550-compatible serial I/O ports with infrared communications port option. A third serial port is available to be dedicated to the IR interface.
- 8) Integrated PCI-mastering dual full-duplex direct-sound AC97-link-compatible sound system. Hardware soundblaster-pro and hardware-assisted FM blocks are included for Windows DOS box and real-mode DOS compatibility. Loopback capability is also implemented for directing mixed audio streams into USB and 1394 speakers for high quality digital audio
- 9) Two game ports and One MIDI port
- 10) ECP/EPP-capable parallel port
- 11) Standard floppy disk drive interface
- 12) Distributed DMA capability for support O ISA legacy DMA over the PCI bus. Serial IRQ is also supported for docking and non-docking application.
- 13) Plug and Play controller that allows complete steerability of all PCI interrupts and internal interrupts/ DMA channels to any interrupt channel. One additional steerable interrupt channel is provided to allow plug and play and reconfigurability of onboard peripherals for Windows family compliance.

The VT82C686B also enhances the functionality of the standard ISA peripherals. The integrated interrupt controller supports both edge and

level triggered interrupts channel by channel. The integrated DMA controller supports type F DMA in addition to standard ISA DMA modes. Compliant with the PCI2.2 specification, the VT83C686A supports delayed transactions and remote power management so that slower ISA peripherals do not block the traffic of the PCI bus. Special circuitry is built in to allow concurrent operation without causing dead lock even in a PCI-to PCI bridge environment. The chip also includes eight levels (doublewords) of line buffers from the PCI bus to the ISA bus to further enhance overall system performance.

## **1-9 I/O INTERFACE CONTROLLER**

The motherboard uses the VT82C686B Super-I/O controller which features:

- Supports 2 serial ports, IR port, parallel port, and floppy disk controller functions
- Two UARTs for Complete Serial Ports
  - Even, odd, stick or no parity bit generation and detection
  - Programmable baud rate generator
  - High speed baud rate (230Kbps, 460Kbps) support
  - Independent transmit/receiver FIFOs
  - Modem Control
  - Plug and play with 96 base IO address and 12 IRQ options
- One dedicated IR port
  - Third serial port dedicated to IR function
  - IR function either through the two complete serial ports or the third dedicated port
  - Infrared-IrDA (HPSIR) and ASK (Amplitude Shift Keyed) IR
- Multi-mode parallel port
  - Standard mode, ECP and EPP support
  - Plug and play with 192 base IO address, 12 IRQ and 4 DMA options
- Floppy Disk Controller
  - 16bytes of FIFO

- Data rates up to 1Mbps
- Perpendicular recording driver support
- Two FDDs with drive swap support
- Plug and play with 48 base IO address, 12 IRQ and 4 DMA options

The Setup program provides configuration option for the I/O controller.

### **1-9.1 Serial Ports**

The motherboard has two 9-pin D-Sub serial port connectors located on the back panel. The NS16C5450-compatible UARTs support data transfers at speeds up to 115.2 Kbits/sec with BIOS support.

### **1-9.2 Parallel Port**

The connector for the multimode bi-directional parallel port is a 25-pin D-Sub connector located on the back panel of the motherboard. In the Setup program, there are four options for parallel port operation:

- Compatible (standard mode)
- Bi-directional (PS/2 compatible)
- Bi-directional EPP. A driver from the peripheral manufacturer is required for operation.
- Bi-directional high-speed ECP

### **1-9.3 Diskette Drive Controller**

The I/O controller is software compatible with the 82077 diskette drive controller and supports both PC-AT and PS/2 modes. In the Setup program, the diskette drive interface can be configured for the following diskette drive capacities and sizes.

- 360 KB, 5.25-inch
- 1.2 MB, 5.25-inch
- 720 KB, 3.5-inch
- 1.2 MB, 3.5-inch (driver required)
- 1.25-1.44 MB, 3.5-inch
- 2.88 MB, 3.5-inch

### 1-9.4 PS/2 Keyboard and Mouse Interface

PS/2 keyboard and mouse connectors are located on the back panel of the motherboard. The +5 V lines to keyboard and mouse connectors are protected with a fuse that prevents motherboard components from being damaged when an over-current condition occurs.



#### **Note**

*The mouse and keyboard can be plugged into either PS/2 connector. Power to the computer should be turned off before a keyboard or mouse is connected or disconnected.*

The keyboard controller contains code, which provides the traditional keyboard and mouse control functions, and also supports Power On/Reset password protection. Power On/Reset password can be specified in the BIOS Setup program.

The keyboard controller also supports the hot-key sequence <Ctrl><Alt><Del>, software reset. This key sequence resets the computer's software by jumping to the beginning of the BIOS code and running the Power On Self Test (POST).

### 1-9.5 Infrared Support

On the front panel I/O connector, there are six pins that support Hewlett Packard HSDL-1000 compatible infrared (IR) transmitters and receivers. In the Setup program, Serial Port B can be directed to a connected IR device. (In this case, the Serial Port B connector on the back panel cannot be used.) The IR connection can be used to transfer files to or from portable devices like laptops, PDAs, and printers. The Infrared Data Association (IrDA) specification supports data transfers of 115Kbits/sec at a distance of 1 meter.

## 1-10 HARDWARE MONITOR

The optional hardware monitor subsystem provides low-cost instrumentation capabilities. The features of the hardware monitor

subsystem include:

- An integrated ambient temperature sensor
- Fan speed sensors, which monitor the fan 1 and fan 2 connector.
- Power supply voltage monitoring to detect levels above or below acceptable values

When suggested ratings for temperature, fan speed, or voltage are exceeded, an interrupt is activated. The hardware monitor component connects to the SMBus.

## **1-11 WAKE ON LAN TECHNOLOGY**

Wake on LAN technology enables remote wakeup of the computer through a network. Wake on LAN technology requires a PCI add-in network interface card (NIC) with remote wakeup capabilities. The remote wakeup connector on the NIC must be connected to the onboard Wake on LAN connector. The NIC monitors network traffic at the Ethernet interface; upon detecting a Magic Packet, the NIC asserts a wakeup signal that powers up the computer. This feature uses the Wake on LAN connector.

### **⚠ CAUTION**

For Wake on LAN, the 5-V standby line for the power supply must be capable of delivering +5V  $\pm$ 5 % at 720 mA. Failure to provide adequate standby current when implementing Wake on LAN can damage the power supply.

## Chapter 2

# HARDWARE INSTALLATION

Congratulations on your purchase of **SY-K7VTA PRO** Motherboard. You are about to install and connect your new Motherboard.



---

**Note:** Do not unpack the Motherboard from its protective anti-static packaging until you have made the following preparations.

---

### 2-1 PREPARATIONS

Gather and prepare all the following hardware equipment to complete the installation successfully:

1. Socket 462 processor with built-in CPU cooling fan (boxed type).



---

**Note:** This Motherboard supports non-boxed type CPUs. The heavier CPU cooling fan requires the installation of a CPU support stand.

---

2. DIMM memory module (s)
3. Computer case and chassis with adequate power supply unit
4. Monitor
5. PS/2 Keyboard
6. Pointing Device (PS/2 mouse)
7. Speaker(s) (optional)
8. Disk Drives: HDD, CD-ROM, Floppy drive ...
9. External Peripherals: Printer, Plotter, and Modem (optional)
10. Internal Peripherals: Modem and LAN cards (optional)

## 2-2 UNPACKING THE MOTHERBOARD

When unpacking the Motherboard, check for the following items:

---

◆ The SY-K7VTA PRO KT133A AGP/PCI/ISA Motherboard

---



---

◆ The Quick Start Guide

---



---

◆ The Installation CD-ROM

---



---

◆ SOYO Bonus Pack CD-ROM

---



---

◆ One IDE Device ATA 66 Flat Cable

---



---

◆ One Floppy Disk Drive Flat Cable

---

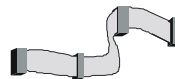

---

◆ One Heat Sink Compound

---



---

**Warning:** Do not unpack the Motherboard from its anti-static packaging until you are ready to install it.

---

Like most electronic equipment, your Motherboard may be damaged by electrostatic discharge. To avoid permanent damage to components ground yourself while working by using a grounding strap. Otherwise, ground yourself frequently by touching the unpainted portion of the computer chassis to drain the static charges.

Handle the Motherboard carefully, hold it by the edges.

You are now ready to start the installation.



---

## 2-3 INSTALLATION GUIDE

We will now begin the installation of the Motherboard. Please follow the step-by-step procedure designed to lead you to a complete and correct installation.



---

**Warning:** Turn off the power to the Motherboard, system chassis, and peripheral devices before performing any work on the Motherboard or system.

---

**BEGIN THE INSTALLATION**

## 2-3.1 CPU Installation

Your SY-K7VTA PRO motherboard comes with a CPU retention set kit. The retention set is used to hold the processor attached to the Socket 462 CPU connector on the motherboard.



### **FOC ( Fan-Off Control )**

The newly designed SOYO “FOC” is based on the concept of total protection for CPU, which is very different from currently seen on the market. The H/W control function is used to see a passive security system of monitoring and warning. “FOC”, designed by SOYO, gives emphasis on the concept of total protection. S/W Simultaneous Signal Follow-ups techniques and Auto Power Off System are included to prevent all possible damage caused by the MAL-functioning of the CPU fan. With the help of “O/S On Time Monitoring And Warning” function, provided by the H/W monitoring system, the double-protection purpose is achieved.

“FOC” includes the following functions:

- (1) Simultaneous Signal Follow Ups: Before the system enters the O/S, H/W will detect the signals of the CPU fan pins, get their revolution information and send it to the BIOS.
- (2) Auto Power Off System: If the BIOS gets the information of CPU fan revolution, it goes on working normally. If not, it will inform the system and have the power supply disconnected immediately. Thus, the CPU is protected from over heating.

**Note:** The following must be observed to secure the normal functioning of “Fan-Off Control”:

1. CPU fan with sensor pins must be used.
2. CPU fans approved by AMD are strongly recommended.
3. The “HOT KEY” function is provided for the CPU fans without

sensor pins, to avoid the power off. Users may press the “Insert” key to jump over the “Power Off” mode; go to the BIOS and disable “FOC”. Now system can be booted normally.

4. The power connector of the CPU fan must be connected to the specified “CPU Fan Connector” on the motherboard to secure the normal functioning of the system.

We provide the following User-Friendly protection features:

1. **Fan-Off Control** : The motherboard detects the status of the CPU fan and protects the CPU by automatically disconnecting the power supply. The default value of this function is Enable. After booting up, the user may disable it.
2. **CPU Socket Sticker** : Users will find a sticker on the CPU socket, which reminds them of the correct usage of the K7 CPU.
3. **Heat Dissipation Paste**: Heat Dissipation Paste is included for all Socket-A motherboards, to enhance the heat dissipation capability.

Furthermore, we strongly recommend our users to enable the function of H/W monitoring in the BIOS. This function, together with the FOC, provide the total protection to the CPU and allow it to maximize its performance.

**Mark your CPU Frequency**: Record the working frequency of your CPU that should be clearly marked on the CPU cover.

#### 200MHz FSB DDR transfer on Athlon

<input type="checkbox"/> 750 MHz (100 x 7.5)	<input type="checkbox"/> 800 MHz (100 x 8.0)	<input type="checkbox"/> 850 MHz (100 x 8.5)	<input type="checkbox"/> 900 MHz (100 x 9.0)	<input type="checkbox"/>
<input type="checkbox"/> 950 MHz (100 x 9.5)	<input type="checkbox"/> 1000 MHz (100 x 10.0)	<input type="checkbox"/> 1.1GHz (100 x 11.0)	<input type="checkbox"/> 1.2GHz (100 x 12.0)	

#### 200MHz FSB DDR transfer on Duron

<input type="checkbox"/> 600 MHz (100 x 6.0)	<input type="checkbox"/> 650 MHz (100 x 6.5)	<input type="checkbox"/> 700 MHz (100 x 7.0)	<input type="checkbox"/> 750 MHz (100 x 7.5)	<input type="checkbox"/> 800 MHz (100 x 8.0)
----------------------------------------------	----------------------------------------------	----------------------------------------------	----------------------------------------------	----------------------------------------------

#### 266MHz Front Side Bus DDR transfer on Athlon

<input type="checkbox"/> 1 GHz (133 x 7.5)	<input type="checkbox"/> 1.13 GHz (133 x 8.5)	<input type="checkbox"/> 1.2 GHz (133 x 9.0)	<input type="checkbox"/>
--------------------------------------------	-----------------------------------------------	----------------------------------------------	--------------------------

Follow these instructions to install your Socket 462 processor correctly.

1. Lift the socket handle up to a vertical position.

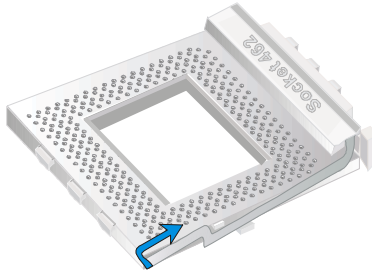

2. Align the blunt edge of the CPU with the matching pinhole distinctive edge on the socket.

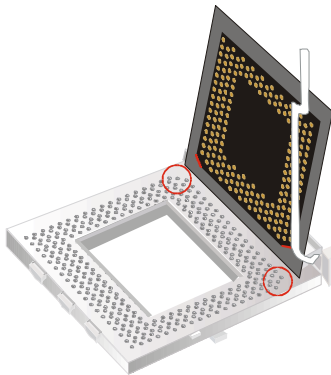

3. Seat the processor in the socket completely and without forcing.

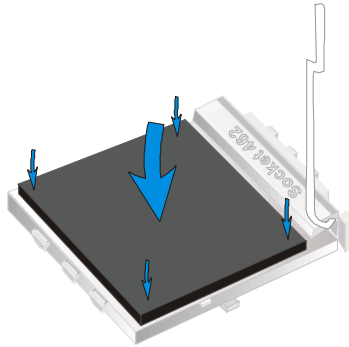

4. Then close the socket handle to secure the CPU in place.

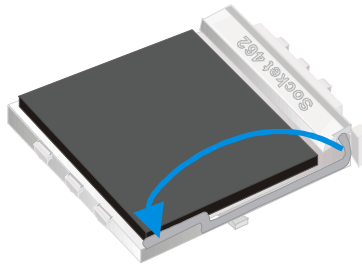

 **HOT**

---

Remember to connect the CPU Cooling Fan to the appropriate power connector on the Motherboard. *The fan is a key component that will ensure system stability. The fan prevents overheating, therefore prolonging the life of your CPU.*

---

## 2-3.2 SDRAM Memory Module Installation

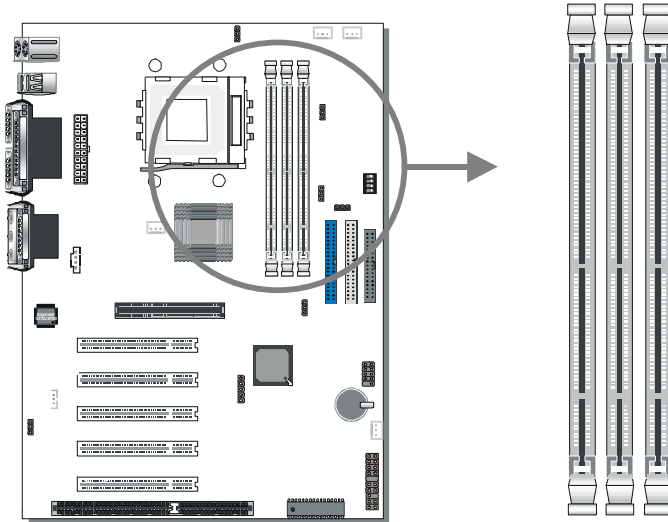

Your board comes with two DIMM sockets, providing support for up to 1.5GB of main memory using unbuffered and registered DIMM modules from 8MB to 512MB. On this motherboard, DRAM speed can be set independent from the CPU front side bus speed. Depending on the DRAM clock speed setting in the BIOS setup (Chapter 3), appropriate memory modules must be used. For 66MHz DRAM speed, use PC66 memory; for 100MHz DRAM speed, use PC100 memory; for 133MHz DRAM speed, use PC133 memory.

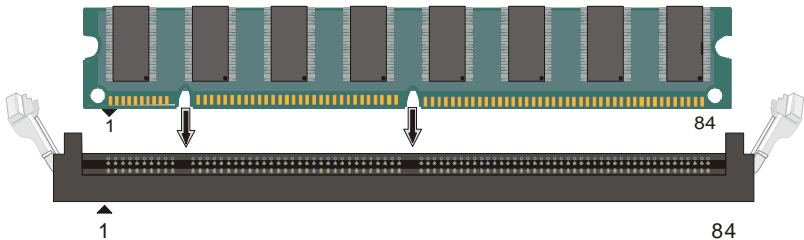

***Memory Configuration Table***

<b>Number of Memory Modules</b>	<b>DIMM 1</b>	<b>DIMM 2</b>	<b>DIMM 3</b>
<b>RAM Type</b>	SDRAM/VCM SDRAM		
<b>Memory Module Size (MB)</b>	32/64/128/256/512 MB		

## 2-3.3 Motherboard Connector

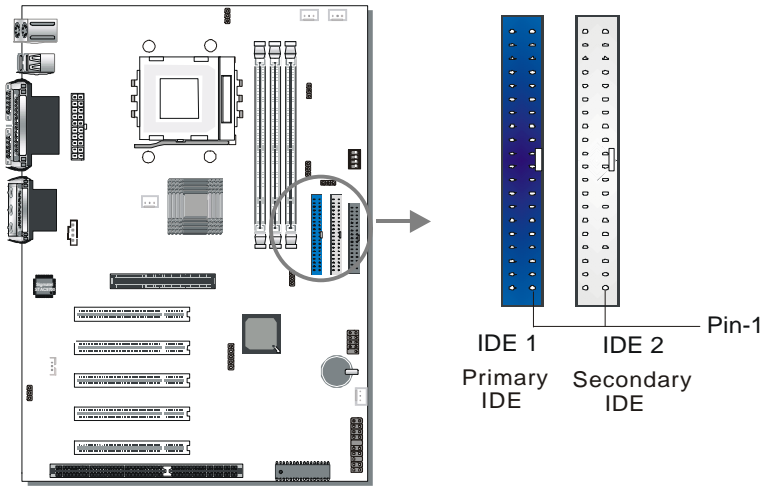

### 2-3.3.1 IDE Device Installation (HDD, CD-ROM)

This Motherboard offers two primary and secondary IDE device connectors (IDE1, IDE2). It can support up to four high-speed Ultra DMA 33/66/100HDD or CD-ROM.

Connect one side of the ATA66/100 flat cable to the IDE device (HDD or CD-ROM) and plug the other end to the primary (IDE1) or secondary (IDE2) directionally keyed IDE connector on the Motherboard. The ATA66/100 cable is backward compatible with ATA33 HDDs.

This Motherboard can support up to four HDDs.

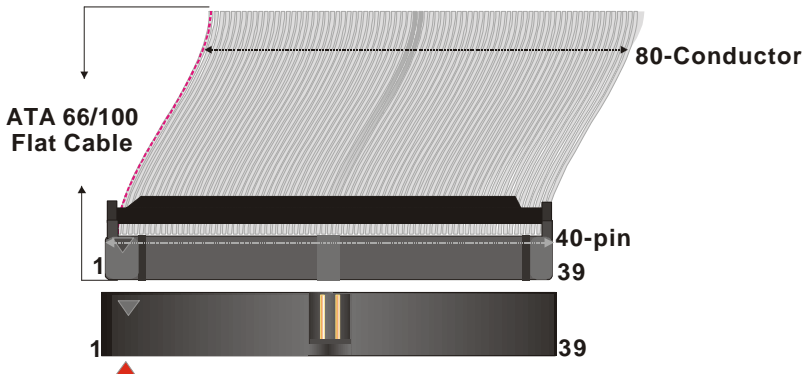



### 2-3.3.2 Floppy Drive Installation

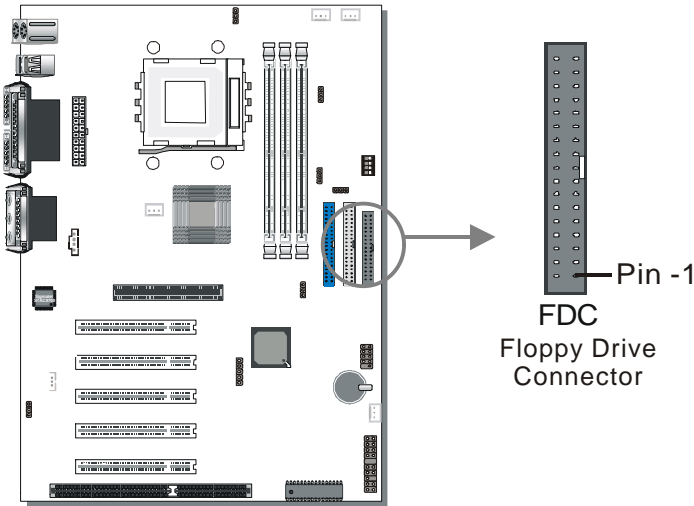

The system supports 5 possible floppy drive types: 720 KB, 1.2 MB, 1.44 MB, 2.88 MB, and LS-120.

Connect one side of the 34-pin flat cable to the floppy drive and plug the other end to the floppy drive connector on the Motherboard.

This Motherboard can support up to 2 floppy drives.

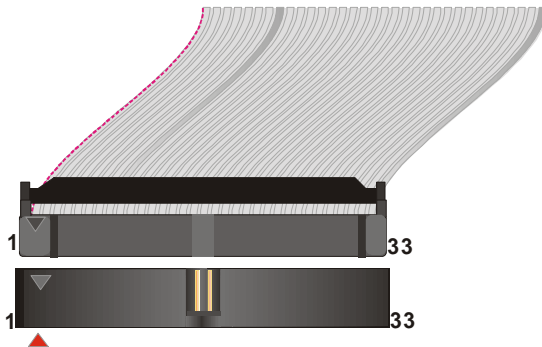

### 2-3.3.3 Front Panel Connections

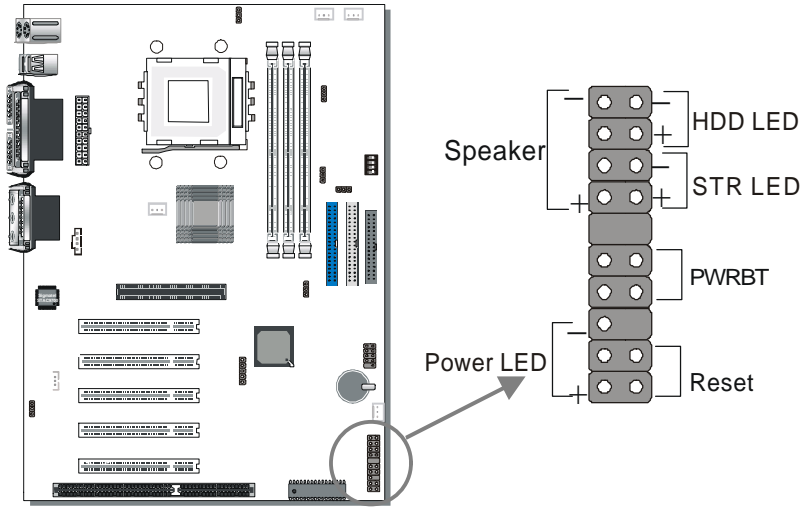

Plug the computer case's front panel devices to the corresponding headers on the Motherboard.

#### 1. Power LED

Please install according to the following pin assignment: pin 1,3 are for Power LED.

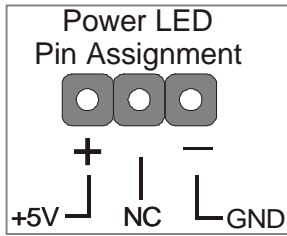

## 2. Reset

Plug the Reset push-button cable into the 2-pin Reset header on the Motherboard. Pushing the Reset button on the front panel will cause the system to restart the boot-up sequence.

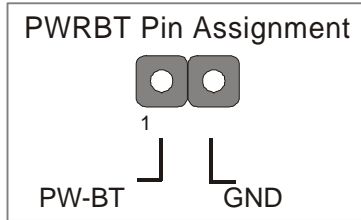

## 3. Speaker

Attach the 4-pin PC speaker cable from the case to the Speaker header on the Motherboard.

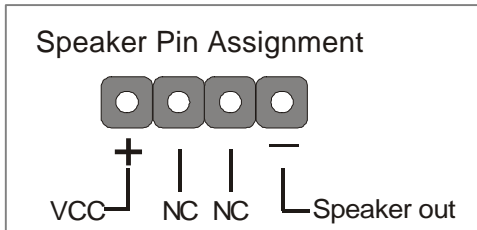

## 4. IDE LED

Attach the 2-pin IDE device LED cable to the corresponding IDE LED header on the Motherboard. This will cause the LED to light up when an IDE (HDD, CD-ROM) device is active.

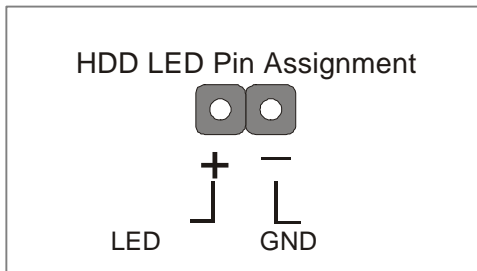

### 5. ATX Power On/Off Switch

Attach the 2-pin momentary type switch to the PWRBT header for turning On or Off your ATX power supply.

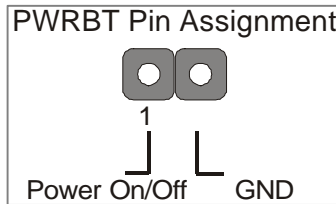

### 6. STR LED

The STR LED is connected to the Voltage that feeds the DIMM sockets.

Therefore the following table applies:

	Suspend to RAM	Normal Operation	Power Off
STR LED	Blinking	ON	OFF

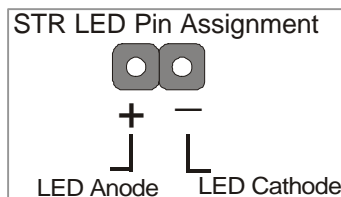

### 2-3.3.4 Back Panel Connections

All external devices such as the PS/2 keyboard, PS/2 mouse, printer, modem, USB can be plugged directly onto the Motherboard back panel.

Only after you have fixed and locked the Motherboard to the computer case can you start connecting the external peripheral devices.

When connecting an external device, use the following figure to locate and identify which back panel connector to plug the device to.

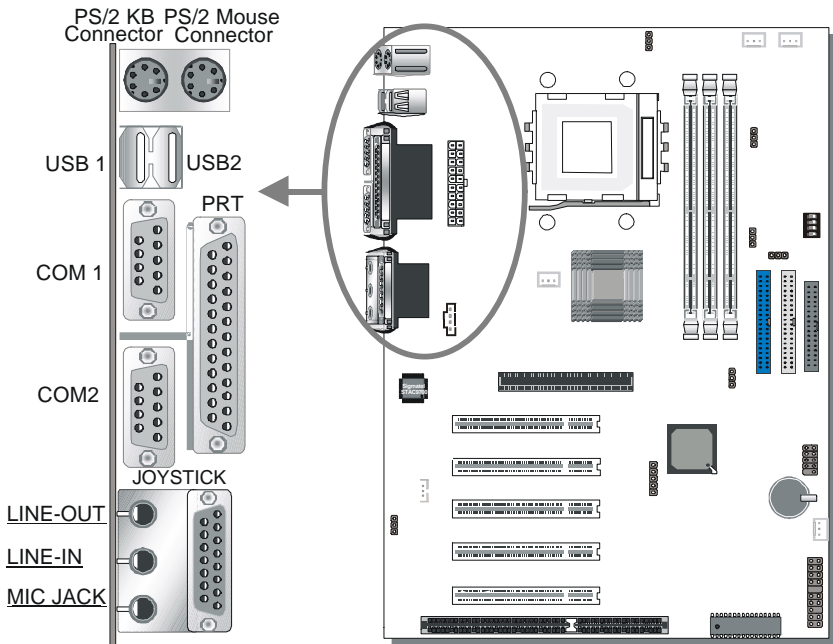

## 1. Onboard Serial Ports COM1/COM2

External peripherals that use serial transmission scheme include:

- serial mouse,
- and modem.

Plug the serial device cables directly into the COM1/COM2 9-pin male connectors located at the rear panel of the Motherboard.

## 2. Parallel Port PRT

This parallel port is used to connect the printer or other parallel devices.

Plug the parallel device cable into the 25-pin female connector located at the rear panel of the Motherboard.

## 3. PS/2 Keyboard

Plug the keyboard jack directly into the 6-pin female PS/2 keyboard connector located at the rear panel of the Motherboard.

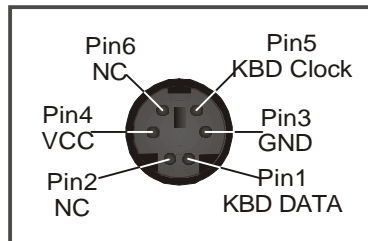

## 4. PS/2 Mouse

Similarly, plug the mouse jack directly into the 6-pin female PS/2 mouse connector.

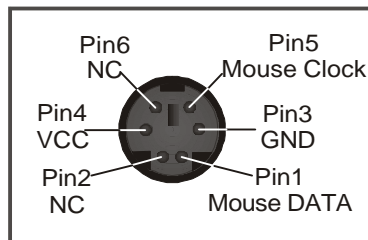

## 5. Universal Serial Bus USB1/USB2/(USB3, USB4)

This Motherboard provides four USB ports for your additional devices. Plug the USB device jack into the available USB connector USB1 or USB2.

- Standard device drivers come with the Win98 for commonly used USB devices.
- With Win95, use the flow UHCI specifications. To use USB devices under Win95, usually you have to install the device that driver comes with the USB device you have purchased.

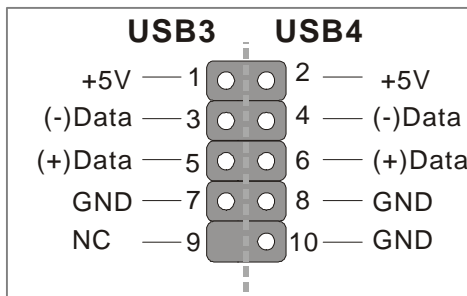

USB3 and 4 are available. To make use of these USB ports, purchase a USB cable from your dealer. The lay-out of USB3 and 4 is as follows:

## 6. Onboard Joystick port/audio

This Motherboard provides Joystick port and audio.

- Attach the joystick cable to the 15-pin JOYSTICK port at the rear panel of you motherboard.
- This Motherboard features three built-in audio-stereo ports (labeled line-in, line-out, and mic jack) convenient to directly plug-in all your external audio devices.

### 2-3.3.5 Other Connections

#### 1. Wake-On-LAN (WOL)

Attach the 3-pin connector from the LAN card which supports the Wake-On-LAN (WOL) function to the JP10 header on the Motherboard. This WOL function lets users wake up the connected computer through the LAN card.

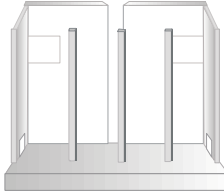

Please install according to the following pin assignment:

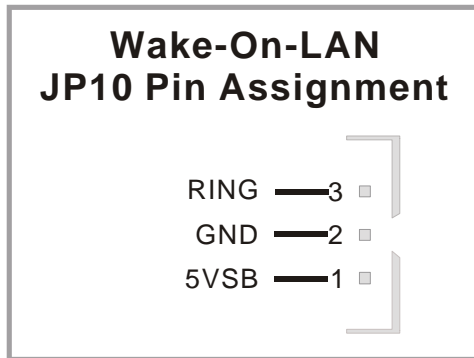



## 2. Infrared (SIRCON)

Plug the 5-pin infrared device cable to the SIRCON header. This will enable the infrared transfer function. This Motherboard meets both the ASKIR and HPSIR specifications.



Please install according to the following pin assignment:

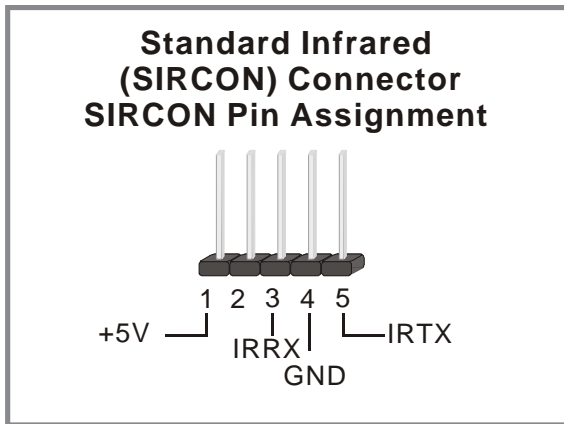

## 3. Other Display Cards

Insert other types of VGA cards into the PCI or ISA expansion slots according to card specifications.

#### 4. Cooling Fan Installation

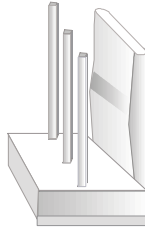

##### (1) CPU Cooling Fan

After you have seated the CPU properly on the processor, attach the 3-pin fan cable to the CPUFAN connector on the Motherboard. The fan will stop when the system enters into Suspend Mode. (Suspend mode can be enabled from the BIOS Setup Utility, [POWER MANAGEMENT] menu.) To avoid damage to the system, install according to the following pin assignment:

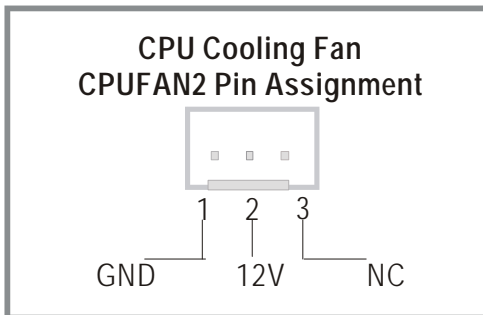
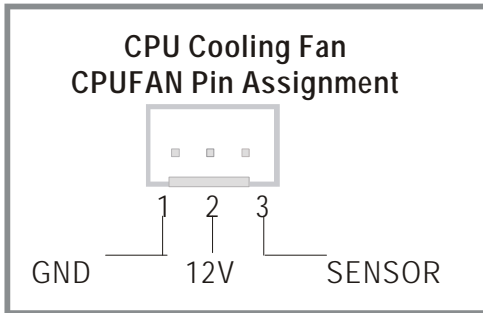

**(2) Chassis Cooling Fan**

Some chassis also feature a cooling fan. This Motherboard features a CHAFAN connector to provide 12V power to the chassis fan. Connect the cable from the chassis fan to the CHAFAN 3-pin connector. Install according to the following pin assignment:

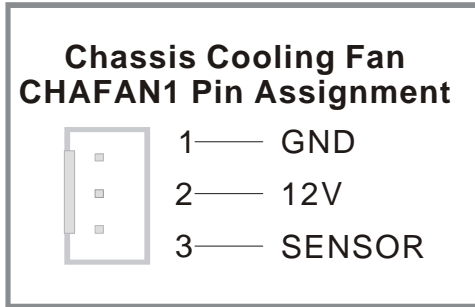

**(3) Chipset Cooling Fan**

Some chipset also feature a cooling fan. This Motherboard features a ChipFAN connector to provide 12V power to the chassis fan. Connect the cable from the chassis fan to the ChipFAN 3-pin connector. Install according to the following pin assignment:

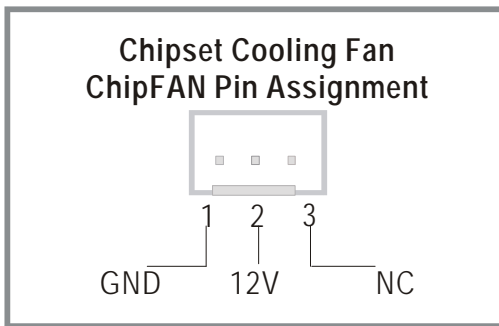

---

**Note:** CPUFAN/ChipFAN must be installed for this Motherboard, CHAFAN is optional.

---

## 5. CD Line-in (CDIN1)

This Motherboard provides two CD-Line in connectors. Please connect the 4-pin audio cable from your CD-ROM drive to either CDIN1. (It fits in only one, depending on the cable that came with your CD-ROM drive)

Please install according to the following pin assignment:

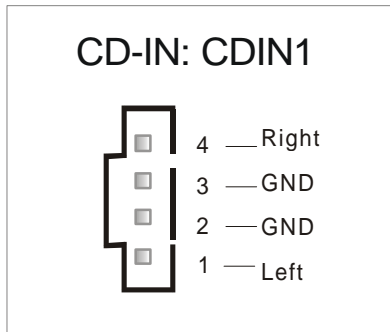

### 2-3.3.6 AGP VGA Card

Insert the AGP VGA card into the AGP slot. Then connect the monitor information cable to the AGP card back plane external connector.

Follow the manufacturer's instructions to perform the AGP VGA drivers installation.

### 2-3.3.7 AT X Power Supply

Plug the connector from the power directly into the 20-pin male ATX PW connector on the Motherboard, as shown in the following figure.

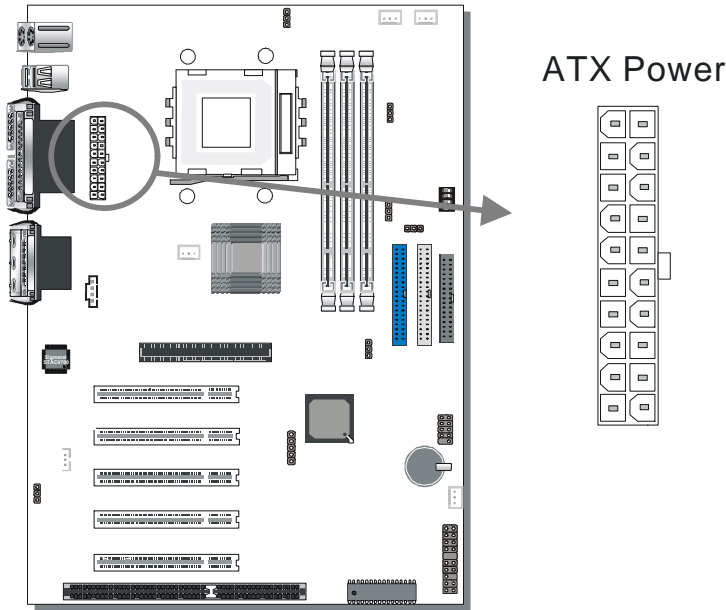

**Warning:** Follow these precautions to preserve your Motherboard from any remnant currents when connecting to ATX power supply:

**Turn off the power supply and unplug the power cord of the ATX power supply before connecting to ATX PW connector.**

The Motherboard requires a power supply with at least 200 Watts and a "power good" signal. Make sure the ATX power supply can take at least 720 mA \* load on the 5V Standby lead (5VSB) to meet the standard ATX specification.

\* **Note:** If you use the Wake-On-LAN (WOL) function, make sure the ATX power supply can support at least 720 mA on the 5V Standby lead (5VSB).

Please install the ATX power according to the following pin assignment:

### ATX Power

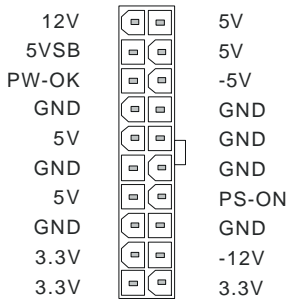





➤ **Pay special care to the directionality.**

## 2-3.4 Jumper Setting

### 2-3.4.1 Ratio Adjustment Setting (RJ1)

Refer to the following table to set the Frequency Multiplier of your CPU.

Frequency Multiplier Setting	J2	J3
Auto	Short Pin1-2 	Short Pin1-2 
Manual	Short Pin2-3 	Short Pin2-3 

If you set ratio to manual and configure the RJ1 jumper to the settings that match your CPU speed as follow table.

RJ1	1	2	3	4	RJ1	1	2	3	4
<b>5</b>	<b>on</b>	<b>off</b>	<b>on</b>	<b>on</b>	<b>9</b>	<b>off</b>	<b>off</b>	<b>on</b>	<b>on</b>
<b>5.5</b>	<b>on</b>	<b>off</b>	<b>on</b>	<b>off</b>	<b>9.5</b>	<b>off</b>	<b>off</b>	<b>on</b>	<b>off</b>
<b>6</b>	<b>on</b>	<b>off</b>	<b>off</b>	<b>on</b>	<b>10</b>	<b>off</b>	<b>off</b>	<b>off</b>	<b>on</b>
<b>6.5</b>	<b>on</b>	<b>off</b>	<b>off</b>	<b>off</b>	<b>10.5</b>	<b>off</b>	<b>off</b>	<b>off</b>	<b>off</b>
<b>7</b>	<b>off</b>	<b>on</b>	<b>on</b>	<b>on</b>	<b>11</b>	<b>on</b>	<b>on</b>	<b>on</b>	<b>on</b>
<b>7.5</b>	<b>off</b>	<b>on</b>	<b>on</b>	<b>off</b>	<b>11.5</b>	<b>on</b>	<b>on</b>	<b>on</b>	<b>off</b>
<b>8</b>	<b>off</b>	<b>on</b>	<b>off</b>	<b>on</b>	<b>12</b>	<b>on</b>	<b>on</b>	<b>off</b>	<b>on</b>
<b>8.5</b>	<b>off</b>	<b>on</b>	<b>off</b>	<b>off</b>	<b>12.5</b>	<b>on</b>	<b>on</b>	<b>off</b>	<b>off</b>





**Note:** SOYO does not guarantee system stability if the user over clocks the system. Any malfunctions due to over-clocking are not covered by the warranty.

### 2-3.4.2 CPU FSB Setting (FJ1,FJ2)

For certain AMD™ CPUs, the multiplier is not locked such that setting a multiplier higher than specified on the CPU is possible. For technical details read the following:

However, the FSB Frequency can also be set through jumpers FJ1 and FJ2 and it may therefore differ from the Frequency the CPU specifies. Doing so may however force your CPU to operate out of its specifications and therefore SOYO can not guarantee the proper functioning of your system.

Refer to the following table:

CPU FSB Setting	FJ1	FJ2
<b>200MHz</b>	Short Pin2-3 	Short Pin2-3 
<b>266MHz</b>	Short Pin1-2 	Short Pin1-2 

### 2-3.5 Voice Doctor

If the system does not boot-up properly, the Voice Doctor will inform the user by voice through internal/external speaker at what point in boot-up sequence the problem arises.

Below are the possible errors the user may encounter:

7. The Processor might be damage or not installed properly
8. The memory module might be damage or not installed properly
9. VGA card might be damage or not inserted properly
10. No Keyboard connected
11. Defective HD-Driver (IDE)
12. Floppy might error

Voice Doctor supports two language, refer the table below on the language you prefer.

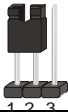
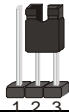
Voice Doctor's Language	English Language	Chinese Language
JP7 Setting	Short pin 1-2 	Short pin 2-3 

### 2-3.6 CMOS Clearing (JP5)

After you have turned off your computer, clear the CMOS memory by momentarily shorting pins 2-3 on jumper JP5, for a few seconds. Then restore JP5 to the initial 1-2 jumper setting in order to recover and retain the default settings.

Jumper JP5 can be easily identified by its white colored cap.

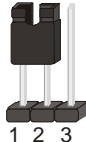
CMOS Clearing	Clear CMOS Data	Retain CMOS Data
JP5 Setting	Short pin 2-3 for <i>at least 5 seconds</i> to clear the CMOS 	Short pin 1-2 to retain new settings 

**Note:** You must unplug the ATX power cable from the ATX power connector when performing the CMOS Clear operation.



## 2-3.7 Power On

You have now completed the hardware installation of your Motherboard successfully.

1. Turn the power on
2. To enter the BIOS Setup Utility, press the <DEL> key while the system is performing the diagnostic checks,



---

**Note:** If you have failed to enter the BIOS, wait until the boot up sequence is completed. Then push the RESET button and press <DEL> key again at the beginning of boot-up, during diagnostic checks.

---

Repeat this operation until you get the following screen.

3. The BIOS Setup screen appears:

CMOS Setup Utility – Copyright ( C ) 1984-2000 Award Software	
<ul style="list-style-type: none"> <li>▶ Soyo Combo Feature</li> <li>▶ Standard CMOS Features</li> <li>▶ Advanced BIOS Features</li> <li>▶ Advanced Chipset Features</li> <li>▶ Integrated Peripherals</li> <li>▶ Power Management Setup</li> <li>▶ PnP/PCI Configurations</li> </ul>	<ul style="list-style-type: none"> <li>▶ PC Health Status</li> <li>Load Fail - Safe Defaults</li> <li>Load Optimized Defaults</li> <li>Set Supervisor Password</li> <li>Set User Password</li> <li>Save &amp; Exit Setup</li> <li>Exit Without Saving</li> </ul>
Esc : Quit F10 : Save & Exit Setup	↑↓→← : Select Item
Change CPU's Clock & Voltage	

## 2-3.8 Quick BIOS Setup

This Motherboard does not use any hardware jumpers to set the CPU frequency. Instead, CPU settings are software configurable with the BIOS [SOYO COMBO SETUP]. The [SOYO COMBO SETUP] menu combines the main parameters that you need to configure, all in one menu, for a quick setup in BIOS.

After the hardware installation is complete, turn the power switch on, then press the <DEL> key during the system diagnostic checks to enter the Award BIOS Setup program. The CMOS SETUP UTILITY will display on screen. Follow these steps to configure the CPU settings.

**Step 1.** Select [STANDARD CMOS SETUP]

Set [Date/Time] and [Floppy drive type], then set [Hard Disk Type] to “Auto”.

**Step 2.** Select [LOAD SETUP DEFAULT]

Select the “LOAD SETUP DEFAULT” menu and type “Y” at the prompt to load the BIOS optimal setup.

**Step 3.** Select [SAVE & EXIT SETUP]

Press <Enter> to save the new configuration to the CMOS memory, and continue the boot sequence.

## 2-3.9 Troubleshooting at First Start

### Video (no display) related issues

**I built a new computer system using a Soyo board and nothing happens when turning it on, no video and no beeps from the PC speaker. What is happening and how can it be fixed?**

No screen and no beeps mean that your CPU and motherboard do not work at all. It could be that the CPU is not seated correctly or that a component on the M/B is grounded (shorted) with the case. Also make sure to check the voltage setting switch (110V/220V) on the back of the power supply. To isolate the problem do the following:

1. Press and hold down on the “Ins” (insert) key while turning on the computer until you get video. If you do not get video then,
2. Double-check jumpers setting on you motherboard and remove all add-on cards, unplug all hard-disk and floppy-disk drive cables and see if you can hear some beeps. If you still do not get any beeps, then try putting the motherboard on the table (to isolate it from the case) with the CPU and speaker only, and give it one more try.

**I hear a series of beeps and I do not get anything from my monitor. What could be wrong?**

The following lists some basic beep codes and their possible meanings:

- One long beep and 3 very short beeps - The video card is not detected by the motherboard. Please re-seat your video card. If you are using an AGP card, please push your AGP card down real hard. You may have to push VERY hard without the AGP card mounting screw. Make sure not to insert the card the other way around.
- Continuous beeps – One or more of the memory modules is not seated correctly in its socket.

**My PCI VGA card works fine with my system, but when I put in a new AGP card, it does not give me any video. Is my AGP slot bad?**

This is a common problem with AGP video cards. The reason is that your AGP card did not get seated into the AGP slot fully and firmly. Please push your AGP card down into the socket real hard, it should snap twice. You may have to unscrew the AGP card to allow the card to go further down. Do take care not to damage the card by using too much force.

**I get distorted video my AGP card right after I save my bios. Why is that?**

The cause is likely that your AGP card is not running at the correct bus speed. To fix this, please clear the CMOS via JP5 and if it still does not work, please upgrade your motherboard bios to the latest version.

## **BIOS Issues**

**Where can I find the BIOS revision of my mainboard?**

It will be displayed on the up-left corner on the screen during boot-up. It will show as your board type followed by the revision number, such as 5EH\_2CA1 (meaning revision 2CA1 for the SY-5EH board) or 6BA+ IV\_2AA2 which means SY-6BA+ IV motherboard with 2AA2 bios.

**Where can I find the latest BIOS of my motherboard?**

Please go to the technical support page of one of the SOYO websites (Taiwan: [www.soyo.com.tw](http://www.soyo.com.tw)), and look up your motherboard to find the latest BIOS revision.

## **Hard disk, floppy drive, CD-ROM etc**

**When I boot up my new computer I got "floppy boot failure" and the LED on the floppy stays on**

Make sure the red wire of floppy ribbon cable goes to Pin1 on the floppy drive side (don't trust the "key lock" or "notch") and use the end-connector of the cable (don't use middle one).

## **Modem issues**

**I get an "I/O Conflict" message when I turn on my system and I can not get my modem to work**

What you need to do is to disable 'COM2' (or UART2 or serial port 2) in the bios under integrated peripheral setup.

**I have installed my modem drivers several times and I still cannot get my modem to work. Why?**

If you are sure that the modem driver has been installed correctly, then you need to install the south bridge driver from the SOYO CD, this is because Windows does not properly recognize relatively new chipsets.

## **Audio Issues**

**I do not get any sound from my sound card. What could be wrong?**

Please make sure the speaker is connected to the speaker out port on your sound card.

**In Device Manager, I keep getting yellow exclamation signs on my sound port even though I have installed my sound driver several times and I could not get my sound card to work. What is wrong?**

It is likely that you did not have the correct driver installed. If you are sure that the correct sound driver has been installed, then please install the 'south bridge' driver for the motherboard.

**The sound is working in my system, but when I play CD music from the CD-ROM, I do not get any sound. What is wrong?**

This is because the 3-wire audio cable from the CD-ROM to the sound card is not connected or it is loose.

**The sound from my sound card is distorted when Windows starts. What is wrong?**

First, if you are using an ISA sound card, please make sure the IRQ needed for the sound card is set to 'Legacy ISA' in the bios. In other words, if your ISA sound card takes IRQ5, then set IRQ5 to 'Legacy ISA'. Next, install the 'south bridge' driver for the motherboard.

**The sound and everything else works fine except that the recorder and microphone do not work. What is wrong?**

This is because the recorder and microphone in the Windows are not enabled. Please go to sound properties and enable them.

### **Lock up (freeze)**

**When I boot up my system, everything works fine. It sees my CPU and memory, detects my hard drive, floppy drive and CD-ROM but locks up at "Verify DMI pool data... ", and it won't go any further.**

#### **What should I do?**

Please clear the CMOS via JP5 then choose 'load setup default' in the bios and save the bios and exit. Next, unplug all other add-on cards except the video card and floppy drive controller, and see if it can boot from floppy. Then put back the peripherals one by one to identify which one causes the lockup. If you are running a Cyrix CPU, make sure the 'linear burst function' is enabled in the bios.

#### **I can not get my board to run properly.**

Please make sure you have the latest bios and driver from the SOYO web site at: <http://www.soyo.com>

## **2-3.10 Power Off**

There are two possible ways to turn off the system:

1. Use the **Shutdown** command in the **Start Menu** of Windows 95/98 to turn off your computer.
2. Press the mechanical power-button and **hold down for over 4 seconds**, to shutdown the computer. If you press the power-button for less than 4 seconds, then your system will enter into **Suspend Mode**.

You are now ready to configure your system with the BIOS setup program. Go to *Chapter 3: BIOS SETUP*

## Chapter 3

### BIOS SETUP UTILITY

This Motherboard's BIOS setup program uses the ROM PCI/ISA BIOS program from Award Software Inc.

To enter the Award BIOS program's Main Menu:

1. Turn on or reboot the system.
2. After the diagnostic checks, press the [Del] key to enter the Award BIOS Setup Utility.

CMOS Setup Utility – Copyright ( C ) 1984-2000 Award Software	
<ul style="list-style-type: none"> <li>▶ SOYO COMBO Feature</li> <li>▶ Standard CMOS Features</li> <li>▶ Advanced BIOS Features</li> <li>▶ Advanced Chipset Features</li> <li>▶ Integrated Peripherals</li> <li>▶ Power Management Setup</li> <li>▶ PnP/PCI Configurations</li> </ul>	<ul style="list-style-type: none"> <li>▶ PC Health Status</li> <li>Load Fail - Safe Defaults</li> <li>Load Optimized Defaults</li> <li>Set Supervisor Password</li> <li>Set User Password</li> <li>Save &amp; Exit Setup</li> <li>Exit Without Saving</li> </ul>
Esc : Quit F10 : Save & Exit Setup	↑↓→← : Select Item
Change CPU's Clock & Voltage	

#### Selecting items

- Use the arrow keys to move between items and select fields.
- From the Main Menu press arrow keys to enter the selected submenu.

#### Modifying selected items

- Use the [Up]/[Down] keys to modify values within the selected fields. Some fields let you enter values directly.

**Hot Keys:** Function keys give you access to a group of commands throughout the BIOS utility.

<b>Function</b>	<b>Command</b>	<b>Description</b>
<b>F1</b>	General Help	Gives the list of options available for each item.
<b>F5</b>	Previous Values	Restore the old values. These are the values that the user started the current session with.
<b>F6</b>	Load Fail-Safe Defaults	Loads all items with the most conservative values.
<b>F7</b>	Load Optimized Defaults	Loads all options with the optimize values.
<b>F10</b>	Save	Saves your changes and reboots the system.
<b>[Esc]</b>	Exit	Returns at anytime and from any location to the Main Menu.
<b>[Enter]</b>	Select	Will display a overlapping window with all options for the current item.
<b>[+/-/PU/PD]</b>	Value	Using the +, -, Page Up and Page Down keys the user can toggle the value of the current item.



### SAVE AND EXIT SETUP

Select the [SAVE & EXIT SETUP] option from the Main Menu to save data to CMOS and exit the setup utility. This option saves all your changes and causes the system to reboot.

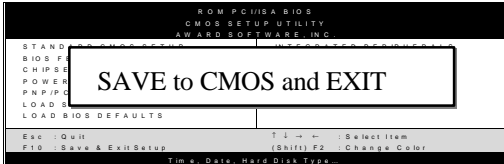

Type [Y] to save the changes and exit or [N] to return to the Main Menu and keep current values.

### EXIT WITHOUT SAVING

Selecting the [EXIT WITHOUT SAVING] option allows you to abandon all data and exit setup, therefore ignoring all your changes.

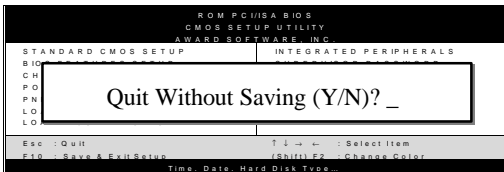

Type [Y] to abandon changes and exit or [N] to return to the Main Menu and keep current values.

### 3-1 SOYO COMBO SETUP

This Motherboard does not use any hardware jumpers to set the CPU frequency. Instead, CPU settings are software configurable with the BIOS [SOYO COMBO SETUP].

After the hardware installation is complete, turn the power switch on, then press the <DEL> key during the system diagnostic checks to enter the Award BIOS Setup program. The CMOS SETUP UTILITY will display on screen. Then, select the [SOYO COMBO SETUP] option from the main menu and press the <Enter> key.

CMOS Setup Utility – Copyright ( C ) 1984-2000 Award Software  
SOYO COMBO Feature

Auto Detect DIMM/PCI Clk <b>Enabled</b> Spread Spectrum Modulated <b>Disabled</b> CPU Host/PCI Clock <b>Default</b> CPU L2 Cache ECC Checking <b>Enabled</b> CPU Vcore Select <b>Default</b> Quick Power On Self Test <b>Enabled</b>  First Boot Device <b>Floppy</b> Second Boot Device <b>HDD-0</b> Third Boot Device <b>LS120</b> Boot Other Device <b>Enabled</b>  OnChip Sound <b>Auto</b>	Item Help <hr/> Menu Level   ▶
-------------------------------------------------------------------------------------------------------------------------------------------------------------------------------------------------------------------------------------------------------------------------------------------------------------------------------------------------------------------------------------------------------------------------------------	-----------------------------------

↑↓→←:Move    Enter:Select    +/-/PU/PD:Value    F10:Save    ESC:Exit    F1:General Help  
 F5:Previous Values    F6:Fail-Safe Defaults    F7: Optimized Defaults

The [SOYO COMBO SETUP] menu combines the main parameters that you need to configure, all in one menu, for a quick setup in BIOS.

### 3-1.1

	Setting	Description	Note	
<b>Auto Detect DIMM/PCI Clk</b>	Disabled	For EMI test purpose.		
	Enabled		Default	
<b>Spread Spectrum Modulated</b>	Disabled		Default	
	Enabled	When using Spread Spectrum Modulated 1.5% or 6% for FCC or DOC testing.		
<b>CPU Host/PCI Clock</b>	Default	109/36 MHz	This item lists the CPU host clock and the PCI bus clock. It is a read only item.	Default
	100/33 MHz	110/36 MHz		
	101/33 MHz	111/37 MHz		
	102/34 MHz	113/37 MHz		
	103/34 MHz	115/38 MHz		
	105/35 MHz	117/39 MHz		
	107/35 MHz	120/40 MHz		

### 3-1.2 L2 Cache Memory

	Setting	Description	Note
<b>CPU L2 Cache ECC Checking</b>	Disabled	This option activates the CPU L2 cache ECC checking function.	
	Enabled		Default

### 3-1.3 CPU Vcore Select

	Setting	Description	Note	
<b>CPU Vcore Select</b>	Default	+0.200V	This function adjust the CPU voltage.	Default
	+0.025V	+0.225V		
	+0.050V	+0.250V		
	+0.075V	-0.025V		
	+0.100V	-0.050V		
	+0.125V	-0.075V		
	+0.150V	-0.100V		
	+0.175V			

### 3-1.4 Quick Power On Self Test

	Setting	Description	Note
<b>Quick Power On Self Test</b>	Disabled		
	Enabled	Provides a fast POTS at boot-up.	Default

### 3-1.5 System Boot Control Settings

System Boot Control Settings	Setting	Description	Note
<b>First /Second/Third Boot Device</b>	Floppy	Select Your Boot Device Priority	
	LS/ZIP		
	HDD-0		
	SCSI		
	CDROM		
	HDD-1		
	HDD-2		
	HDD-3		
	LAN		
	Disabled		
<b>Boot Other Device</b>	Disabled	Select Your Boot Device Priority	Default
	Enabled		
<b>OnChip Sound</b>	Disabled	This item allows you to control the onboard AC 97 audio.	Default
	Auto		

### 3-2 STANDARD CMOS SETUP

Select the [STANDARD CMOS SETUP] option from the Main Menu and press [Enter] key.

CMOS Setup Utility – Copyright ( C ) 1984-2000 Award Software  
 Standard CMOS Features

Date (mm:dd:yy)	Tue, Jan 4 2000	Item Help
Time (hh:mm:ss)	1 : 22 : 12	
▶ IDE Primary Master	Maxtor 82160D2	Menu Level ▶
▶ IDE Primary Slave	None	
▶ IDE Secondary Master	None	
▶ IDE Secondary Slave	NEC	
Drive A	1.44M, 3.5 in.	
Drive B	None	
Floppy 3 Mode Support	Disabled	
Video	EGA/VGA	
Halt On	All Errors	
Base Memory	640K	
Extended Memory	64512K	
Total Memory	65536K	

↑↓→←:Move    Enter:Select    +/-/PU/PD:Value    F10:Save    ESC:Exit    F1:General Help  
 F5:Previous Values    F6:Fail-Safe Defaults    F7: Optimized Defaults

This screen allows you to modify the basic CMOS settings. After you have completed the changes, press [Esc] key to return to the Main Menu.

#### 3-2.1 Date & Time

	Display	Setting	Please Note
<b>Date</b>	mm/dd/yyyy	Type the current date	You can also the PUp/PDn keys to toggle
<b>Time</b>	hh:mm:ss	Type the current time	24-hour clock format 3:15 PM is displayed as 15:15:00

### 3-2.2 Hard Disks Type & Mode

Choose the type and mode for the hard disks that you have already installed.

Primary (Secondary) Master & Slave	Setting	Description	Note
<b>IDE HDD Auto-Detection</b>	Press Enter	To auto-detect the HDD's size, head ..on this channel	
	Auto	BIOS detects hard disk type automatically.	Default
<b>IDE Primary Slave (User Type)</b>	User	User defines the type of hard disk.	
	None		
<b>Access Mode</b>	Auto	BIOS detects hard disk mode automatically.	Default
	Normal	Normal IDE hard disk	<528MB
	LBA	Enhanced IDE hard disk	>528MB
	Large	Large IDE hard disk (for certain hard disk)	



**Note:** If you have any questions on your hard disk type or mode, ask your hard disk provider or previous user for details.

### 3-2.3 Floppy Drives

Floppy Drives	Setting	Description	Note
<b>Drives A &amp; B</b>	360KB, 5.25 in.		
	1.2MB, 5.25 in.		
	720KB, 3.5 in.		
	1.44MB, 3.5 in.		Default
	2.88MB, 3.5 in.		
	None	Not installed	
<b>Floppy 3-Mode Support</b>	Disabled		Default
	Drive A Drive B Both	Supports 3-mode floppy diskette: 740KB/1.2MB/1.44MB on selected disk drive.	Special disk drive commonly used in Japan

**3-2.4 Others Optional**

	<b>Setting</b>	<b>Description</b>	<b>Note</b>
<b>Video</b>	EGA/VGA	Select the video mode.	Default
	CGA 40		
	CGA 80		
	MONO (Monochrome)		
<b>Halt On</b>	ALL Errors	When the BIOS detects system errors, this function will stop the system. Select which type of error will cause the system halt.	Default
	No Errors		
	All, But Keyboard		
	All, But Diskette		
	All, But Disk/Key		

### 3-3 ADVANCED BIOS FEATURES

Select the [Advanced BIOS Features] option from the Main Menu and press [Enter] key.

CMOS Setup Utility – Copyright ( C ) 1984-2000 Award Software  
Advanced BIOS Features

Virus Warning                    Disabled CPU Internal Cache            Enabled External Cache                Enabled Swap Floppy Drive            Disabled Boot Up Floppy Seek          Enabled Boot Up NumLock Status      On Gate A20 Option              Fast Typematic Rate Setting       Disabled x Typematic Rate (Chars/Sec) 6 x Typematic Delay (Msec)    250 Security Option                Setup OS Select For DRAM > 64MB Non-OS2 HDD S.M.A.R.T. Capability    Disabled Video BIOS Shadow            Enabled C8000-CBFFF Shadow          Disabled CC000-CFFFF Shadow          Disabled D0000-D3FFF Shadow          Disabled D4000-D7FFF Shadow          Disabled D8000-DBFFF Shadow          Disabled DC000-DFFFF Shadow          Disabled		Item Help <hr/> Menu Level ▶
-----------------------------------------------------------------------------------------------------------------------------------------------------------------------------------------------------------------------------------------------------------------------------------------------------------------------------------------------------------------------------------------------------------------------------------------------------------------------------------------------------------------------------------------------------------------------------------------------------------------------------------------------------------------------------------------------------------------------------------------------------------------------------------------------------------------	-----------------------------------------------------------------------------------	---------------------------------

↑↓→←:Move    Enter:Select    +/-/PU/PD:Value    F10:Save    ESC:Exit    F1:General Help  
 F5:Previous Values    F6:Fail-Safe Defaults    F7: Optimized Defaults

After you have completed the changes, press [Esc] key and follow the instructions on your screen to save your settings or exit without saving.



### 3-3.1 Virus Warning

	Setting	Description	Note
<b>Virus Warning</b>	Disabled	Allows you to choose the VIRUS Warning feature for IDE Hard Disk boot sector protection. If this function is enabled and someone attempt to write data into this area, BIOS will show a warning message on screen and alarm beep.	Default
	Enabled		

### 3-3.2 Cache Memory Options

	Setting	Description	Note
<b>CPU Internal Cache</b>	Disabled	Enables the CPU's internal cache.	Default
	Enabled		
<b>External Cache</b>	Disabled	Enables the external memory.	Default
	Enabled		

### 3-3.3 Floppy Driver Settings

	Setting	Description	Note
<b>Swap Floppy Drive</b>	Disabled	Changes the sequence of A and B drives.	Default
	Enabled		

### 3-3.4 Boot Up Floppy Seek

	Setting	Description	Note
<b>Boot Up Floppy Seek</b>	Disabled	Seeks disk drives during boot up.	Default
	Enabled	Disabling speeds boot up.	

### 3-3.5 Boot Up NumLock Status

	Setting	Description	Note
<b>Boot Up NumLock Status</b>	On	Puts numeric keypad in NumLock mode at boot-up.	Default
	Off	Puts numeric keypad in arrow key mode at boot-up.	

### 3-3.6 Gate A20 Options

	Setting	Description	Note
<b>Gate A20 Options</b>	Normal	Lets chipset control GateA20.	
	Fast	A pin in the keyboard controller controls GateA20.	Default

### 3-3.7 Typematic Settings

Typematic Settings	Setting	Description	Note
<b>Typematic Rate Setting</b>	Disabled	Keystrokes repeat at a rate determined by the keyboard.	Default
	Enabled	When enables , the typematic rate and typematic delay can be selected.	
The following [Typematic Rate] and [Typematic Delay] fields are active only if [Typematic Rate Setting] is set to [Enabled]			
<b>Typematic Rate</b>	6 (Char/sec)	Choose the rate at which a character is repeated when holding down a key.	Default
	8 (Char/sec)		
	10 (Char/sec)		
	12 (Char/sec)		
	15 (Char/sec)		
	20 (Char/sec)		
	24 (Char/sec)		
30 (Char/sec)			
<b>Typematic Delay</b>	250 (msec)	Choose how long after you press a key down the character begins repeating.	Default
	500 (msec)		
	750 (msec)		
	1000 (msec)		

### 3-3.8 Security Option

Use this feature to prevent unauthorized system boot-up or use of BIOS Setup. The following table describes the security settings.

	Setting	Description
<b>Security Option</b>	System	Each time the system is booted, the password prompt appears.
	Setup	If a password is set, the password prompt only appears when you attempt to enter the BIOS Setup program.

### 3-3.9 Other Control Options

Other Control Options	Setting	Description	Note
<b>OS Select for DRAM&gt;64MB</b>	OS2	When using an OS2 operating system.	
	Non-OS2	When using another, non-OS2 operating system.	Default
<b>HDD S.M.A.R.T. Capability</b>	Disabled		Default
	Enabled	Enable this field when your HDD supports the S.M.A.R.T. function. Consult your HDD provider for details.	
<b>Video BIOS Shadow</b>	Disabled		
	Enabled	The BIOS is shadowed in a 16K segment if it is enabled and if it has BIOS present. These 16 segments can be shadowed from ROM to RAM. BIOS shadow copies BIOS code from slower ROM to faster RAM. BIOS can then execute from RAM.	Default

### 3-4 ADVANCED CHIPSET FEATURES



**Caution:** Change these settings only if you are already familiar with the Chipset.

The [Advanced Chipset Features] option changes the values of the chipset registers. These registers control the system options in the computer.

CMOS Setup Utility – Copyright ( C ) 1984-2000 Award Software  
Advanced Chipset Features

DRAM Timing By SPD	Disabled		Item Help
DRAM Clock	100MHz		
SDRAM Cycle Length	3		
Bank Interleave	Disabled		
Memory Hole	Disabled		
PCI Master Dipeline Req	Enabled		
P2C/C2P Concurrency	Enabled		
Fast R-W Turn Around	Disabled		
System BIOS Cacheable	Disabled		
Video RAM Cacheable	Disabled		
AGP Aperture Size	64M		
AGP-4X Mode	Enabled		
AGP Driving Control	Auto		
x AGP Driving Value	DA		
OnChip USB	Enabled		
USB Keyboard Support	Disabled		
CPU to PCI Write Buffer	Enabled		
PCI Dynmic Bursting	Enabled		
PCI Master 0 WS Write	Enabled		
PCI Delay Transaction	Enabled		
PCI#2 Access #1 Retry	Enabled		
AGP Master 1 WS Write	Disabled		
AGP Master 1 WS Read	Disabled		

↑↓→←:Move    Enter:Select    +/-/PU/PD:Value    F10:Save    ESC:Exit    F1:General Help  
 F5:Previous Values    F6:Fail-Safe Defaults    F7: Optimized Defaults

After you have completed the changes, press [Esc] and follow the instructions on your screen to save your settings or exit without saving.

The following table describes each field in the Advanced Chipset Features Menu and how to configure each parameter.

### 3-4.1 CHIPSET FEATURES SETUP

CHIPSET FEATURES	Setting	Description	Note
<b>DRAM Timing By SPD</b>	Disabled	If enable the DRAM will auto detect the DRAM timing	Default
	Enabled		
<b>DRAM Clock</b>	100MHz	This item allows you to control the DRAM speed.	Default
	133MHz		
<b>SDRAM Cycle Length</b>	3	When synchronous DRAM is installed, the number of clock cycles of CAS latency depends on the DRAM timing. Do not reset this field from the default value specified by the system designer.	Default
	2		
<b>Bank Interleave</b>	Disabled	Increase DRAM performance.	Default
	2 Bank		
	4 Bank		
<b>Memory Hole</b>	Disabled	Some interface cards will map their ROM address to this area. If this occurs, select [Enabled] in this field.	Default
	Enabled		
<b>PCI master Pipeline Req</b>	Disabled	Disabled/Enabled PCI Master Pipeline Req.	Default
	Enabled		
<b>P2C/C2P Concurrency</b>	Disabled	This item allows you to enable/disable the PCI to CPU, CPU to PCI concurrency.	Default
	Enabled		

## CHIPSET FEATURES SETUP (Continued)

CHIPSET FEATURES	Setting	Description	Note
<b>Fast R-W Turn Around</b>	Disabled	This item controls the DRAM timing. It allows you to enable/disable the fast read/write turn around.	Default
	Enabled		
<b>System BIOS Cacheable</b>	Disabled	The ROM area F0000H-FFFFFFH is cacheable.	Default
	Enabled		
<b>Video RAM Cacheable</b>	Disabled	When synchronous DRAM is installed, the number of clock cycles of CAS latency depends on the DRAM timing. Do not reset this field from the default value specified by the system designer	Default
	Enabled		
<b>AGP Aperture Size</b>	64M	Select the size of Accelerated Graphics Port (AGP) aperture. The aperture is a portion of the PCI memory address range dedicated for graphics memory address space. Host cycles that hit the aperture range are forwarded to the AGP without any translation.	Default
	4M, 8M, 16M, 32M, 128M, 256M.		
<b>AGP-4X Mode</b>	Disabled	This item allows you to enable / disable the AGP-4X Mode.	
	Enabled		Default
<b>AGP Driving Control</b>	Auto	This item allows you to adjust the AGP driving force. Choose <i>Manual</i> to key in a AGP Driving Value in the next selection. This field is recommended to set in Auto for avoiding any error in your system.	Default
	Manual		
<b>AGP Driving Value</b>	Min=0000 ~ Max=00FF	This item allows you to adjust the AGP driving force.	

**CHIPSET FEATURES SETUP (Continued)**

CHIPSET FEATURES	Setting	Description	Note
<b>OnChip USB</b>	Disabled	This should be enabled if your system has a USB installed on the system board and you want to use it. Even when so equipped, if you add a higher performance controller, you will need to disable this feature.	Default
	Enabled		
<b>USB Keyboard Support</b>	Disabled		Default
	Enabled	Select <i>Enabled</i> if your system contains a Universal Serial Bus (USB) controller and you have a USB keyboard.	
<b>CPU to PCI Write Buffer</b>	Disabled	When this field is <i>Enabled</i> , writes from the CPU to the PCI bus are buffered, to compensate for the speed differences between the CPU and the PCI bus. When <i>Disabled</i> , the writes are not buffered and the CPU must wait until the write is complete before starting another write cycle.	Default
	Enabled		
<b>PCI Dynmic Bursting</b>	Disabled	When <i>Enabled</i> , every write transaction goes to the write buffer. Burstable transactions then burst on the PCI bus and nonburstable transactions don't.	Default
	Enabled		
<b>PCI Master 0 WS Write</b>	Disabled	When <i>Enabled</i> , writes to the PCI bus are executed with zero wait states.	Default
	Enabled		

## CHIPSET FEATURES SETUP (Continued)

CHIPSET FEATURES	Setting	Description	Note
<b>PCI Delay Transaction</b>	Disabled	The chipset has an embedded 32-bit posted write buffer to support delay transactions cycles. Select <i>Enabled</i> to support compliance with PCI specification version 2.1.	Default
	Enabled		
<b>PCI#2 Access #1 Retry</b>	Disabled	When disabled, PCI#2 will not be disconnected until access finishes (default). When enabled, PCI#2 will be disconnected if max retries are attempted without success.	Default
	Enabled		
<b>AGP Master 1 WS Write</b>	Disabled	When <i>Enabled</i> , writes to the AGP(Accelerated Graphics Port) are executed with one wait states.	Default
	Enabled		
<b>AGP Master 1 WS Read</b>	Disabled	When <i>Enabled</i> , read to the AGP (Accelerated Graphics Port) are executed with one wait states.	Default
	Enabled		



### 3-5 INTEGRATED PERIPHERALS



**Caution:** Change these settings only if you are already familiar with the Chipset.

The [INTEGRATED PERIPHERALS] option changes the values of the chipset registers. These registers control the system options in the computer. The following screen shows setup default settings.

CMOS Setup Utility – Copyright ( C ) 1984-2000 Award Software		Item Help
Integrated Peripherals		Menu Level ▶
OnChip IDE Channel0	Enabled	
OnChip IDE Channel1	Enabled	
IDE Prefetch Mode	Enabled	
Primary Master PIO	Auto	
Primary Slave PIO	Auto	
Secondary Master PIO	Auto	
Secondary Slave PIO	Auto	
Primary Master UDMA	Auto	
Primary Slave UDMA	Auto	
Secondary Master UDMA	Auto	
Secondary Slave UDMA	Auto	
Init Display First	PCI Slot	
IDE HDD Block Mode	Enabled	
Onboard FDD Controller	Enabled	
Onboard Serial Port 1	3F8/IRQ4	
Onboard Serial Port 2	2F8/IRQ3	
UART 2 Mode	Standard	
x IR Function Duplex	Half	
x TX,RX inverting enable	No, Yes	
Onboard Parallel Port	378/IRQ7	
Onboard Parallel Mode	Normal	
x ECP Mode Use DMA	3	
x Parallel Port EPP Type	Epp1.9	
Onboard Legacy Audio	Enabled	
Sound Blaster	Disabled	
SB I/O Base Address	220H	
SB IRQ Select	IRQ 5	
SB DMA Select	DMA 1	
MPU-401	Disabled	
MPU-401 I/O Address	330-333H	
Game Port (200-207H)	Enabled	

↑↓→←:Move    Enter:Select    +/-/PU/PD:Value    F10:Save    ESC:Exit    F1:General Help  
 F5:Previous Values    F6:Fail-Safe Defaults    F7: Optimized Defaults

The following tables describe each field in the INTEGRATED PERIPHERALS Menu and provide instructions on how to configure the IDE controls, FDC controls, and the onboard serial and parallel ports.

### 3-5.1 IDE Device Controls

IDE Controls	Setting	Description	Note
<b>On-Chip PCI IDE</b>	Disabled	Turn off the on-board IDE	
	Enabled	Use the on-board IDE	Default
➤ <b>Primary</b>			
➤ <b>Secondary</b>			
<b>IDE Prefetch Mode</b>	Disabled	The onboard IDE drive interfaces supports IDE prefetching for faster drive accesses. If you install a primary and/or secondary add-in IDE interface, set this field to <i>Disabled</i> if the interface does not support prefetching.	Default
	Enabled		
<b>IDE</b>	mode 0-4	0 is the slowest speed 4 is the fastest speed	
	➤ <b>Primary Master PIO</b>	For better performance and stability, we suggest you use the Auto setting to set the HDD control timing.	Default
	➤ <b>Primary Slave PIO</b>		
➤ <b>Secondary Master PIO</b>			
➤ <b>Secondary Slave PIO</b>			
<b>IDE</b>	Disabled	Select Auto to enable Ultra DMA Mode support.	Default
	Auto		
➤ <b>Primary Master UDMA</b>			
➤ <b>Primary Slave UDMA</b>			
➤ <b>Secondary Master UDMA</b>			
➤ <b>Secondary Slave UDMA</b>			

### 3-5.2 Keyboard Controls

Keyboard Controls	Setting	Description	Note
<b>Init Display First</b>	PCI Slot	Choose which card – AGP	Default
	AGP	Display card or PCI VGA card – to initialize first.	

### 3-5.3 IDE HDD Block Mode

	Setting	Description	Note
<b>IDE HDD Block Mode</b>	Disabled		
	Enabled	Invokes multi-sector transfer instead of one sector per transfer. Not all HDDs support this function.	Default

### 3-5.4 FDD Controls

FDD Controls	Setting	Description	Note
<b>Onboard FDD controller</b>	Disabled	Turn off the on-board floppy controller	
	Enabled	Use the on-board floppy controller	Default

### 3-5.5 Onboard Serial Ports

Onboard Serial Ports	Setting	Description	Note
<b>Onboard Serial Port 1 / Serial Port 2</b>	Disabled		
	3F8/IRQ4	Choose serial port 1 & 2's I/O address.	Default (port 1)
	2F8/IRQ3	Do not set port 1 & 2 to the same address except for	Default (port 2)
	3E8/IRQ4	Disabled or Auto.	
	2E8/IRQ3		
	Auto		
<b>UART 2 Mode</b>	Standard	The second serial port offers these InfraRed interface modes.	Default
	HPSIR		
	ASKIR		
If [UART Mode Select] is set to [IrDA]/[ASKIR]			
<b>IR Function Duplex</b>	Half	Choose [Half] or [Duplex] to set UR2 in half duplex mode or full duplex mode respectively. Refer to your IR device specifications to select the suitable mode.	Default
	Full		

### Onboard Serial Ports(Continued)

Onboard Serial Ports	Setting	Description	Note
<b>TX,RX inverting enable</b>	No, Yes	This item allow you to enable the TX, RX inverting which depends on different H/W requirement. This field is not recommended to change its default setting for avoiding any error in your system	Default
	No, No/ Yes, No/ Yes, Yes.		

### 3-5.6 Onboard Parallel Ports

Onboard Parallel Ports	Setting	Description	Note
<b>Onboard Parallel Port</b>	Disabled	Choose the printer I/O address.	
	378/IRQ7		Default
	3BC/IRQ7		
	278/IRQ5		
<b>Parallel Port Mode</b>	Normal	The mode depends on your external device that connects to this port.	Default
	EPP		
	ECP		
	ECP+EPP		
If [Parallel Port Mode] is set to [ECP] mode			
<b>ECP Mode use DMA</b>	3	Choose DMA3	Default
	1	Choose DMA1	
If [Parallel Port Mode] is set to [EPP] mode			
<b>Parallel Port EPP TYPE</b>	EPP 1.9	Select EPP port type 1.9	
	EPP 1.7	Select EPP port type 1.7	Default

### 3-5.7 Onboard Legacy Audio

This field controls the onboard legacy audio.

	Setting	Description	Note
<b>Onboard Legacy Audio</b>	Disabled	Set this item to Enabled if using software (like DOS games) that needs a 'legacy' audio device.	Default
	Enabled		
<b>Sound Blaster</b>	Disabled	Set this item to enabled if your on-board audio-chip is sound Blaster compatible.	Default
	Enabled		
<b>SB I/O Base Address</b>	220H	Select the base address for your sound Blaster (SB) compatible Audio IC.	Default
	240H		
	260H		
	280H		
<b>SB IRQ Select</b>	IRQ 5	Select the IRQ your SB Audio IC uses.	Default
	IRQ7		
	IRQ9		
	IRQ10		
<b>SB DMA Select</b>	DMA1	Select the DMA channel your SB Audio IC uses.	Default
	DMA0		
	DMA2		
	DMA3		
<b>MPU-401</b>	Disabled	Set this item to enabled to make use of MIPI.	Default
	Enabled		
<b>MPU-401 I/O Address</b>	330-333H	Select the I/O address for your MIDI functionality.	Default
	300-303H		
	310-313H		
	320-323H		
<b>Game Port (200-207H)</b>	Disabled	Set this item to enabled to make use of the game port.	Default
	Enabled		

### 3-6 POWER MANAGEMENT SETUP

The [POWER MANAGEMENT SETUP] sets the system's power saving functions.

CMOS Setup Utility – Copyright ( C ) 1984-2000 Award Software  
Power Management Setup

▶ Power Management	Press Enter	Item Help
ACPI Suspend Type	S1 (POS)	Menu Level ▶
PM Control by APM	Yes	
Video Off Option	Suspend -> Off	
Video Off Method	V/H SYNC+Blank	
MODE Use IRQ	3	
Soft-Off by PWRBTN	Instant-Off	
State After Power Failure	Off	
Wake Up Events	Press Enter	

↑↓→←:Move Enter:Select +/-/PU/PD:Value F10:Save ESC:Exit F1:General Help  
F5:Previous Values F6:Fail-Safe Defaults F7: Optimized Defaults



CMOS Setup Utility – Copyright ( C ) 1984-2000 Award Software  
Wake Up Events

VGA	OFF	Item Help
LPT & COM	LPT/COM	Menu Level ▶
HDD & FDD	ON	
PCI Master	OFF	
Wake up On LAN/Ring	Disabled	
RTC Alarm Resume	Disabled	
Primary INTR	ON	
▶ IRQs Activity Monitoring	Press Enter	

↑↓→←:Move Enter:Select +/-/PU/PD:Value F10:Save ESC:Exit F1:General Help  
F5:Previous Values F6:Fail-Safe Defaults F7: Optimized Defaults

After you have completed the Power Management Setup, press [Esc] to return to the Main Menu.

### 3-6.1 Power Management Controls

Power Management Controls	Setting	Description	Note		
Power Management	User Define	Lets you define the HDD and system power down times.	Default		
		Doze timer	Standby timer	Suspend timer	HDD power down
	Min Saving	1 Hour	1 Hour	1 Hour	15 Min
	Max Saving	1 Min	1 Min	1 Min	1 Min
	ACPI Suspend Type	S1(POS)	The system will enter the S1 state during suspend. (Low latency wake up)	Default	
S3(STR)					
PM Control by APM	Yes	When enabled, an Advanced Power Management device will be activated to enhance the Max. Power Saving mode and stop the CPU internal clock. If Advance Power Management (APM) is installed on your system, selecting Yes gives better power savings.	Default		
	NO				
Video Off Option	Suspend --> Off	When enabled, this feature allows the VGA adapter to operate in a power saving mode.	Default		
	Always On All Modes --> Off				
Video Off Method	V/H Sync+Blank	Selects the method by which the monitor is blanked.	Default		
	Blank screen				
	DPMS				

**Power Management Controls (Continued)**

Power Management Controls	Setting	Description	Note
<b>MODEM Use IRQ</b>	3	Assigns an IRQ# to the modem device.	Default
	3-11, NA		
<b>Soft-Off by PWR-BTTN</b>	Instant-off		Default
	Delay 4 Sec.	Turns off the system power 4 seconds after pushing the power button.	
<b>State After Power Failure</b>	On	The system will switch on when power comes back after a power failure.	
	Off	The system will remain off when power comes back after a power failure.	Default
	Auto	The system will return to the state it was in before the power failure when power returns. (i.e: If the system was on, it will switch on again, if it was off, it will remain off)	
<b>Wake Up Events</b>	Press Enter	Select items that will wake up your system when in one of sleep modes. Press enter to go the select item page.	

Wake Up Events	Setting	Description	Note
<b>VGA</b>	OFF		Default
	ON	You can set the VGA awakens the system.	
<b>LPT &amp; COM</b>	LPT/COM	When <i>On of</i> LPT & COM, any activity from one of the listed system peripheral devices or IRQs wakes up the system.	Default
	NONE		
	COM		



Wake Up Events	Setting	Description	Note
<b>HDD &amp; FDD</b>	OFF		
	ON	When <i>On of HDD &amp; FDD</i> , any activity from one of the listed system peripheral devices wakes up the system.	Default
<b>PCI Master</b>	OFF		Default
	ON	When <i>On of PCI Master</i> , any activity from one of the listed system peripheral devices wakes up the system	
<b>Wake up On LAN/Ring</b>	Disabled	An input signal on the serial Ring Indicator (RI) line (in other words, an incoming call on the modem/LAN) awakens the system from a soft off state.	Default
	Enabled		
<b>RTC Alarm Resume</b>	Disabled	The system ignores the alarm.	Default
	Enabled	Set alarm to power on the system by the date (1-31) or time (hh:mm:ss). If the date is set to [0], the system will self-power on by alarm everyday at the set time.	
<b>Primary INTR</b>	ON	When set to <i>On</i> , any event occurring at will awaken a system which has been powered down.	Default
	OFF		
<b>IRQs Activity Monitoring (Press Enter)</b>	Disabled	IRQ8 (RTC Alarm), IRQ9(IRQ2 Redir), IRQ10( Reserved), IRQ11(Reserved), IRQ15 (Reserved)	
	Secondary	IRQ3(COM2), IRQ4(COM1), IRQ5(LPT2), IRQ6(Floppy Disk), IRQ7(LPT1), IRQ12(PS/2 Mouse), IRQ13(Coprocessor), IRQ14(HardDisk)	

### 3-7 PNP/PCI CONFIGURATION SETUP

This option sets the Motherboard's PCI Slots.

CMOS Setup Utility – Copyright ( C ) 1984-2000 Award Software  
 PnP/PCI Configurations

PNP OS Installed	NO	Item Help
Reset Configuration Data	Disabled	
Resources Controlled By	Auto (ESCD)	Menu Level ▶
x IRQ Resources	Press Enter	
x DMA Resources	Press Enter	
PCI/VGA Palette Snoop	Disabled	
Assign IRQ For VGA	Enabled	
Assign IRQ For USB	Enabled	

↑↓→←:Move   Enter:Select   +/-/PU/PD:Value   F10:Save   ESC:Exit   F1:General Help  
F5:Previous Values   F6:Fail-Safe Defaults   F7: Optimized Defaults



**Note:** Starred (\*) items will disappear when the [Resources Controlled By] option is set to [Auto].

After you have completed the PCI Slot Configuration, press [Esc] and follow the instructions on your screen to save your settings or exit without saving.

### 3-7.1 PNP/PCI Configuration Controls

PNP/PCI Controls	Setting	Description	Note
<b>PnP OS Installed</b>	Yes	Set this field to [Yes] if you are running Windows 95, which is PnP compatible.	
	No	If the OS you are running does not support PnP configuration.	Default (If there is any doubt, set this field to [No])
<b>Reset Configuration Data</b>	Disabled	Retain PnP configuration data in BIOS.	Default
	Enabled	Reset PnP configuration data in BIOS.	
<b>Resources Controlled By</b>	Manual	BIOS does not manage PCI/ISA PnP card IRQ assignment. Requires to assign IRQ-# and DMA-# to PCI or ISA PnP manually. IRQ-3,4,5,7,9,10,11,12,14,15 assigned to: _ DMA-0,1,3,5,6,7 assigned to: _	
	Auto (ESCD)	The Plug-and-Play BIOS auto manages PCI/ISA PnP card IRQ assignment automatically.	<b>Recommended</b>
If [Resources Controlled By] is set to [Manual]			
<b>IRQ-# and DMA-# assigned to:</b>	PCI/ISA PnP	Choose IRQ-# and DMA-# assigned to PCI/ISA PnP card.	IRQ-3,4,5,7,9,10,11,12,14,15 DMA-0,1,3,5,6,7
	Legacy ISA	Choose IRQ-# and DMA-# assigned to Legacy ISA card.	IRQ-3,4,5,7,9,10,11,12,14,15 DMA-0,1,3,5,6,7
Under this item the user can assign an IRQ to a PCI slot. However, there under some conditions the IRQ will not be assigned as selected under this item:			
<ol style="list-style-type: none"> <li>1. IRQs 0, 1, 2, 6, 8, 13 can NOT be assigned, because they are fixed.</li> <li>2. IRQs 5, 9, 10, 11 are available</li> <li>3. IRQs 3,4,7,12,14 and 15 will only be assigned if they are free. See the table below on how to free them:</li> </ol>			

### PNP/PCI Configuration Setup (Continued)

PNP/PCI Setup	Setting	Description	Note
Interrupt Line	How to set the BIOS to release the IRQ to the PnP Interrupt pool:		
	PnP / PCI configuration	Integrated Peripherals	
IRQ 15	IRQ 15: <b>PCI / ISA PnP</b>	On-Chip Secondary PCI IDE:	<b>disabled</b>
IRQ 14	IRQ 14: <b>PCI / ISA PnP</b>	On-Chip Primary PCI IDE:	<b>disabled</b>
IRQ 12	IRQ 12: <b>PCI / ISA PnP</b>	<i>Interrupt 12 will be released by the PnP BIOS automatically if the PS/2 Mouse Port is not used.</i>	
IRQ 7	IRQ 7: <b>PCI / ISA PnP</b>	Onboard parallel port:	<b>disabled</b>
IRQ 4	IRQ 4: <b>PCI / ISA PnP</b>	Onboard Serial port 1:	<b>disabled</b>
IRQ 3	IRQ 3: <b>PCI / ISA PnP</b>	Onboard Serial port 2:	<b>disabled</b>
4. Your OS may reassign another interrupt to a PCI slot after BIOS passes control to the OS, especially if you use Windows 95, 98 or NT.			
<b>PCI/VGA Palette Snoop</b>	Disabled	Leave this field at <i>Disabled</i> .	Default
	Enabled		
<b>Assign IRQ For VGA/USB</b>	Disabled	BIOS will assign IRQ for VGA/USB port.	
	Enabled	BIOS won't assign IRQ for VGA/USB port.	Default

### 3-7.2 MULTI I/O ADDRESSES

Default settings for multi-I/O addresses are as follows:

Port	I/O Address	IRQ	Status
LPT1	378H	7	ECP/EPP
COM1	3F8H	4	
COM2	2F8H	3	



**Warning:** If a default I/O address conflicts with other I/O cards such as sound card, you must change one of the I/O addresses to remedy to this address conflict. (I/O addresses can be adjusted from the BIOS Setup Utility)

### 3-8 PC HEALTH STATUS

This option sets the Motherboard's PC Health Status.

CMOS Setup Utility – Copyright ( C ) 1984-2000 Award Software  
 PC Health Status

Current CPU Temp.      38 °C / 100 °F Current System Temp.    31 °C / 87 °F Current CUFAN Speed      5002 RPM Current CHAFAN Speed    0 RPM Vcore                        1.60 V 2.5V                         2.44 V 3.3V                         3.30 V 5V                            4.80 V 12V                          11.94 V  Protect CPU Overheating <span style="color: yellow;">Enabled</span>	Item Help  Menu Level ▶
--------------------------------------------------------------------------------------------------------------------------------------------------------------------------------------------------------------------------------------------------------------------------------------------------------------------------------------------------------------------------------------------------------------------------------------	-------------------------------

↑↓→←:Move    Enter:Select    +/-/PU/PD:Value    F10:Save    ESC:Exit    F1:General Help  
 F5:Previous Values    F6:Fail-Safe Defaults    F7: Optimized Defaults



**Note:** Starred (\*) items will disappear when the [Resources Controlled By] option is set to [Auto].

### 3-8.1 CPU Device Monitoring

CPU Device Monitoring	Setting	Description	Note
<b>Current CPU Temperature</b>	°C/°F	Show the current status of CPU temperature.	
<b>Current Sys Temperature</b>	°C/°F	Show the current status of the system temperature.	
<b>Current CPUFAN/ CHAFAN Speed</b>	°C/°F	Show the current status of CPU Fan.	
<b>Vcore, 2.5V, 3.3V, 5V, 12V</b>	V	Show the current voltage status.	
<b>Protect CPU Overheating</b>	Disabled	If enable, this function protect user's CPU from overheating in an event there's a problem with the CPU FAN. The user should also plug the CPU FAN power on the CPU FAN1 pin. The system will auto shutdown if the power is plug in CPU FAN2 pin.	Default
	Enabled		

### 3-9 LOAD FAIL-SAFE DEFAULTS

Select the [Load Fail-Safe Defaults] option from the Main Menu to load the system values you have previously saved. This option is recommended if you need to reset the system setup and to retrieve the old values.

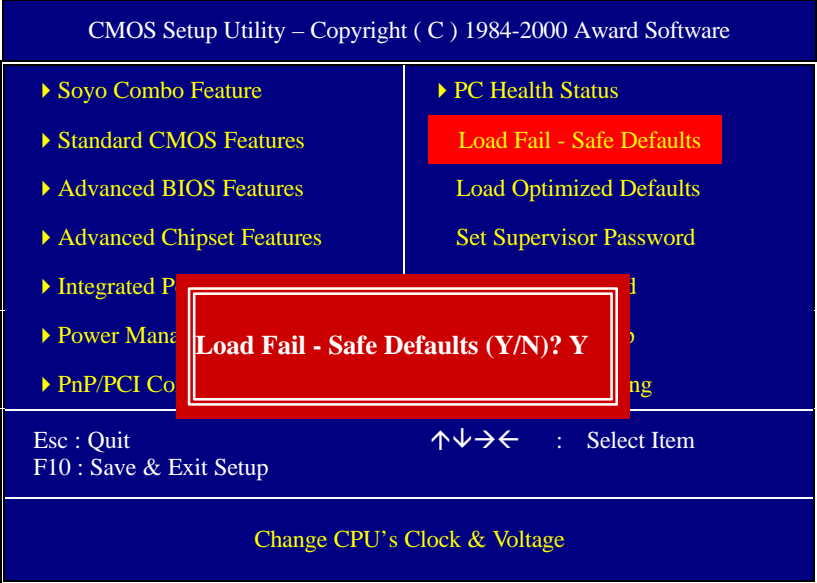

Type [Y] to use the Setup Defaults followed by [Enter] or otherwise [N] to return to the Main Menu and keep current values.



**Warning:** If you run into any problem after changing the BIOS configuration, please load the SETUP DEFAULTS for stable performance.

### 3-10 LOAD OPTIMIZED DEFAULTS

Select the [Load Optimized Defaults] option from the Main Menu to load the system values you have previously saved. This option is recommended if you need to reset the system setup and to retrieve the old values.

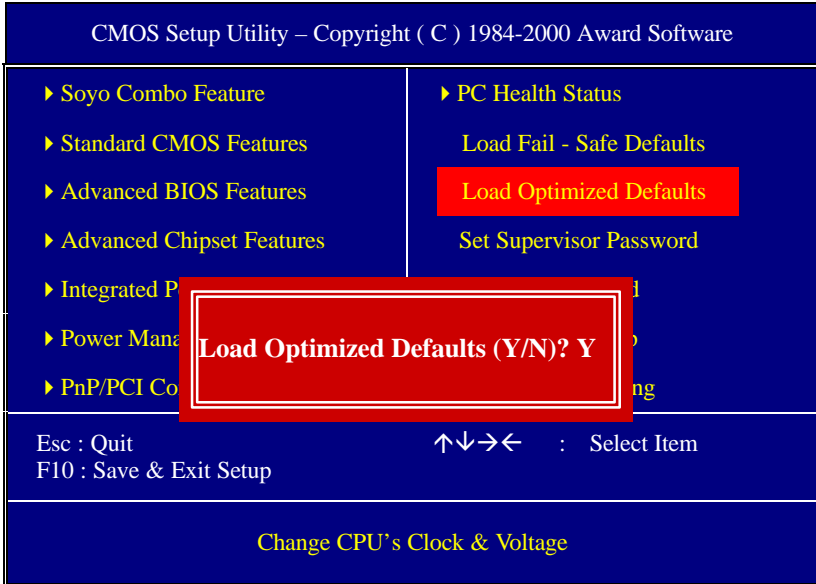

Type [Y] to use the Setup Defaults followed by [Enter] or otherwise [N] to return to the Main Menu and keep current values.



**Warning:** If you run into any problem after changing the BIOS configuration, please load the SETUP DEFAULTS for stable performance.



### 3-11 SUPERVISOR PASSWORD

Based on the setting you have made in the [Security Option] of the [BIOS FEATURES SETUP] section, the password prevents access to the system or the setup program by unauthorized users. Follow this procedure to set a new password or disable the password:

1. Choose [BIOS FEATURES SETUP] in the Main Menu and press [Enter]. Select the [Security Options] item and set the field to:
  - a. [System]: The password is required every time the system is booted. This means only a person who knows the password can use this computer.
  - b. [Setup]: The password is required only when you attempt to enter the BIOS Setup program.
  
2. Choose [SUPERVISOR PASSWORD] from the Main Menu and press [Enter]. The following prompt appear:

Enter Password:



---

**Warning:** If you forget or lose the password, the only way to access the system is to set jumper JP5 to clear the CMOS RAM. All setup information is lost and you must run the BIOS setup program again.

---



---

**Note:** If you do not wish to use the password function, press [Enter] directly and the following message appears:

Password Disabled!!

---

- 3. Enter your new password and press [Enter]. The following message appears, prompting to confirm the new password:

Confirm Password:

- 4. Re-enter your password and then press [Enter] to exit to the Main Menu.

This diagram outlines the password selection procedure:

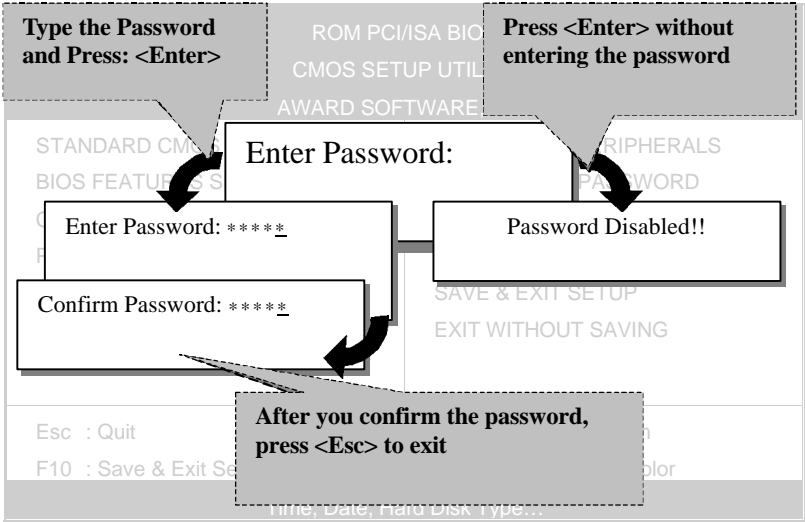

### 3-12 USER PASSWORD

When the user password option is on, you are not allowed to change any setting in the [CMOS SETUP UTILITY] except for changing the user's password.

The password setting procedure is similar to that for the [SUPERVISOR PASSWORD] (Refer to section 3-9).

### 3-13 IDE HDD AUTO DETECTION

This Main Menu function automatically detects the hard disk type and configures the [Standard CMOS Features] accordingly.

CMOS Setup Utility – Copyright ( C ) 1984-2000 Award Software  
 IDE Primary Master

IDE HDD Auto-Detection <b>Press Enter</b>  IDE Primary Master <b>Auto</b>  Capacity                      0 MB Access Mode <b>Auto</b> 0 Cylinder                      0 Head                            0 Precomp                        0 Landing Zone                0 Sector                            0	Item Help  Menu Level ▶
-----------------------------------------------------------------------------------------------------------------------------------------------------------------------------------------------------------------------------------------------------------------------------------------------------------------------------------------------	-------------------------------

↑↓→←:Move    Enter:Select    +/-/PU/PD:Value    F10:Save    ESC:Exit    F1:General Help  
 F5:Previous Values        F6:Fail-Safe Defaults        F7: Optimized Defaults



**Note:** This function is only valid for IDE type of hard disk drives.

### 3-14 BOOT MENU

Boot Menu enables user to boot-up on different boot device without going into the BIOS setup.

*To enable boot Menu, press “ESC” after memory initialization, user will see a device menu, in which user can choose on which device they wish to boot from.*

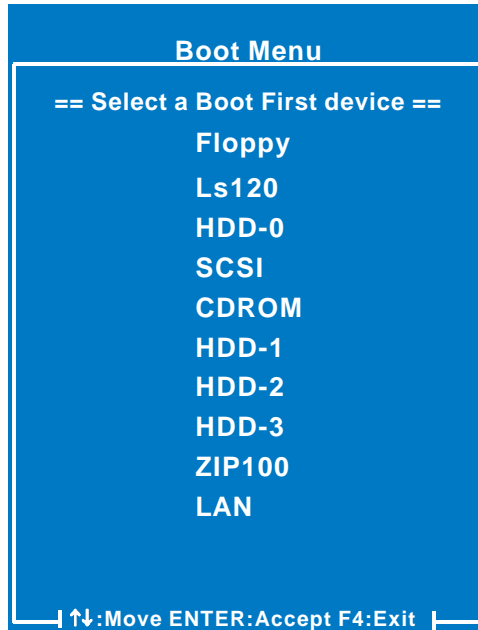

## Chapter 4

### DRIVER INSTALLATION

Your SY-K7VTA PRO Motherboard comes with a CD-ROM labeled "SOYO CD." The SOYO CD contains the user's manual file for your new Motherboard, the drivers software available for installation, and a database in HTML format with information on SOYO Motherboards and other products.

#### **Step 1. Insert the SOYO CD into the CD-ROM drive**

If you use Windows NT, the SOYO-CD will not detect your motherboard type. In that case the following dialog will pop up, please choose your motherboard and press OK. Now the SOYO-CD Start Up Menu will be shown.

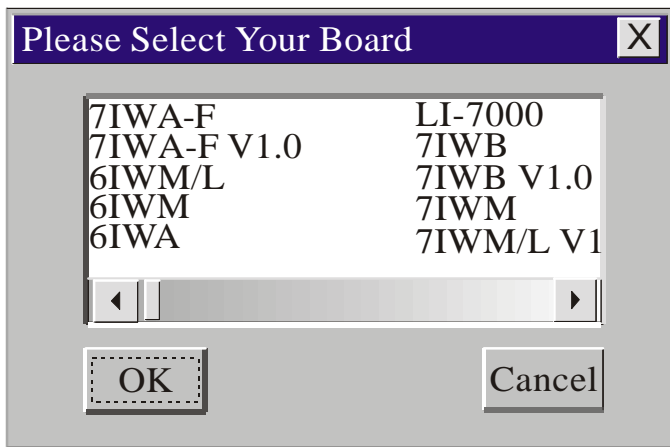

(SOYO CD Start Up Program Menu)

If you use Windows 95 or 98, the SOYO CD Start Up Program automatically detects which SOYO Motherboard you own and displays the corresponding model name.



The user's manual files included on the SOYO CD are in PDF (Postscript Document) format. In order to read a PDF file, the appropriate Acrobat Reader software must be installed in your system.

**Note:** The Start Up program automatically detects if the Acrobat Reader utility is already present in your system, and otherwise prompts you on whether or not you want to install it. You must install the Acrobat Reader utility to be able to read the user's manual file. Follow the instructions on your screen during installation, then once the installation is completed, restart your system and re-run the SOYO CD.

## Step 2. Install Drivers

Click the **Install Drivers** button to display the list of drivers software that can be installed with your Motherboard. The Start Up program displays the drivers available for the particular model of Motherboard you own. We recommend that you only install those drivers.

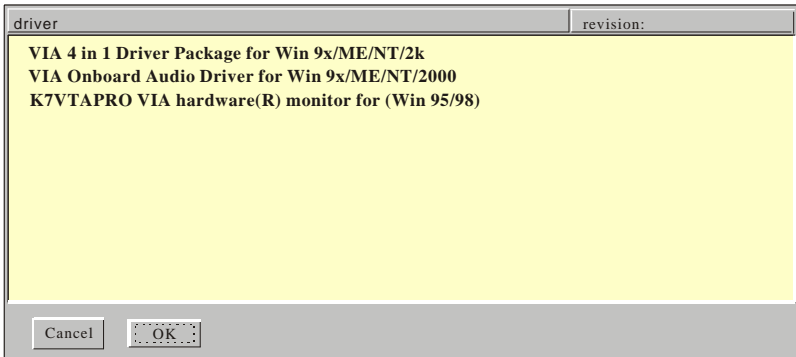

### (Driver Installation Menu)

A short description of all available drivers follows:

➤ **VIA 4in1 Driver Package for Win 9x/ME/NT/2k**

The 4 in 1 Driver Package includes all drivers your motherboard needs. After selecting this Driver Package, one driver will be installed automatically (the IRQ remapping utility), the other three are installed if selected. By default all three drivers are selected. A description of the 4 drivers follows:

—**Bus Master PCI IDE Driver**

This driver will speed up the data-transfer rate to and from the harddisk.

—**AGP VxD Driver**

This driver must be installed in order to be able to make use of the on-board AGP Video functionality.

—**VIA Chipset Functions Registry**

This driver will make the necessary changes to the Windows registry, in order to make sure that Windows has no problems recognizing your VIA chipset.

—**IRQ remapping utility (This driver is installed automatically)**

This utility will remap the IRQ lines to make sure that everything functions properly under Windows.

➤ **VIA Onboard Audio Driver for Win 9x/ME/NT/2000**

You have to install the drivers before installing any application for the Onboard Audio.

➤ **K7VTAPRO VIA hardware(R) monitor for (Win 95/98)**

Your motherboard comes with a hardware monitoring IC. By installing this utility Temperature, Fan speed and Voltages can be monitored. It is also possible to set alarms when current system values exceed or fall below pre-set values.

Select which driver you want to install and click **OK**, or click **Cancel** to abort the driver installation and return to the main menu.

**Note:** Once you have selected a driver, the system will automatically exit the SOYO CD to begin the driver installation program. When the installation is complete, most drivers require to restart your system before they can become active.

**Step 3. Select which driver you want to install and click OK**

**Notice 1:** Once you have selected a driver, the system will automatically exit the SOYO CD to begin the driver installation program. When the installation is complete, most drivers require to restart your system before they can become active.

**Notice 2:** You may click **Cancel** to abort the driver installation and return to the main menu.



#### **Step 4. Check the Latest Releases**

Click the 'Check the latest Releases' button to go the SOYO Website to automatically find the latest BIOS, manual and driver releases for your motherboard. This button will only work if your computer is connected to the internet through a network or modem connection. Make sure to get your modem connection up before clicking this button.

