



SY-D6IBA

Motherboard

Single or Dual Slot 1 processor supported

82440 BX AGP/PCI Motherboard

66&100MHz Front Side Bus supported

ATX Form Factor

Ultra-SCSI onboard

User's Guide
&
Technical Reference

About This Guide

This User's Guide is for assisting system manufacturers and end users in setting up and installing the Motherboard. Information in this guide has been carefully checked for reliability; however, no guarantee is given as to the correctness of the contents. The information in this document is subject to change without notice.

Copyright Notice

Copyright 1998, Soyo Computer Inc. All rights reserved. This manual is copyrighted by Soyo Computer Inc. You may not reproduce, transmit, transcribe, store in a retrieval system, or translate into any language, in any form or by any means, electronic, mechanical, magnetic, optical, chemical, manual or otherwise, any part of this publication without express written permission of Soyo Computer Inc.

Trademarks

Soyo is a registered trademark of Soyo Computer Inc. All trademarks are the property of their owners.

Disclaimer

Soyo Computer Inc. makes no representations or warranties regarding the contents of this manual. We reserve the right to revise the manual or make changes in the specifications of the product described within it at any time without notice and without obligation to notify any person of such revision or change. The information contained in this manual is provided for general use by our customers. Our customers should be aware that the personal computer field is the subject of many patents. Our customers should ensure that their use of our products does not infringe upon any patents. It is the policy of Soyo Computer Inc. to respect the valid patent rights of third parties and not to infringe upon or assist others to infringe upon such rights.

Restricted Rights Legend

Use, duplication, or disclosure by the Government is subject to restrictions set forth in subparagraph (c)(1)(ii) of the Rights in Technical Data and Computer Software clause at 252.277-7013.

Product Rights

Products mentioned in this manual are mentioned for identification purpose only. Product names appearing in this manual may or may not be registered trademarks or copyrights of their respective companies.

If you need any further information, please come to our home page on the Internet. The address is "<http://www.soyo.com.tw>".

Edition: June 1999
Version 2.0
D6IBA SERIAL

FC Tested To Comply
With FCC Standards
FOR HOME OR OFFICE USE

100% POST CONSUMER
RECYCLED PAPER

Table of Contents

SY-D6IBA MOTHERBOARD LAYOUT..... 1

CHAPTER 1 INTRODUCTION 2

1-1 KEY FEATURES.....2

1-2 HANDLING THE MOTHERBOARD.....5

1-3 ELECTROSTATIC DISCHARGE PRECAUTIONS5

CHAPTER 2 HARDWARE SETUP 6

2-1 PREPARATIONS6

2-2 UNPACKING THE MOTHERBOARD7

2-3 INSTALLATION GUIDE.....8

CHAPTER 3 BIOS SETUP UTILITY 29

3-1 SOYO COMBO SETUP 31

3-2 STANDARD CMOS SETUP 36

3-3 BIOS FEATURES SETUP 39

3-4 CHIPSET FEATURES SETUP 44

3-5 POWER MANAGEMENT SETUP 47

3-6 PNP/PCI CONFIGURATION SETUP 51

3-7 LOAD SETUP DEFAULTS 54

3-8 INTEGRATED PERIPHERALS 55

3-9 SUPERVISOR PASSWORD 60

3-10 USER PASSWORD 61

3-11 IDE HDD AUTO DETECTION 62

CHAPTER 4 DRIVERS INSTALLATION..... 63

CHAPTER 5 ULTRA-SCSI I/O SUBSYSTEM 68

5-1 INTRODUCTION TO ULTRA-SCSI 68

5-2 INSTALLING SCSI DEVICES..... 69

5-3 CONNECTING INTERNAL SCSI DEVICES 70

5-4 ADAPTEC RAIDPORT TM..... 71

SY-D6IBA MOTHERBOARD LAYOUT

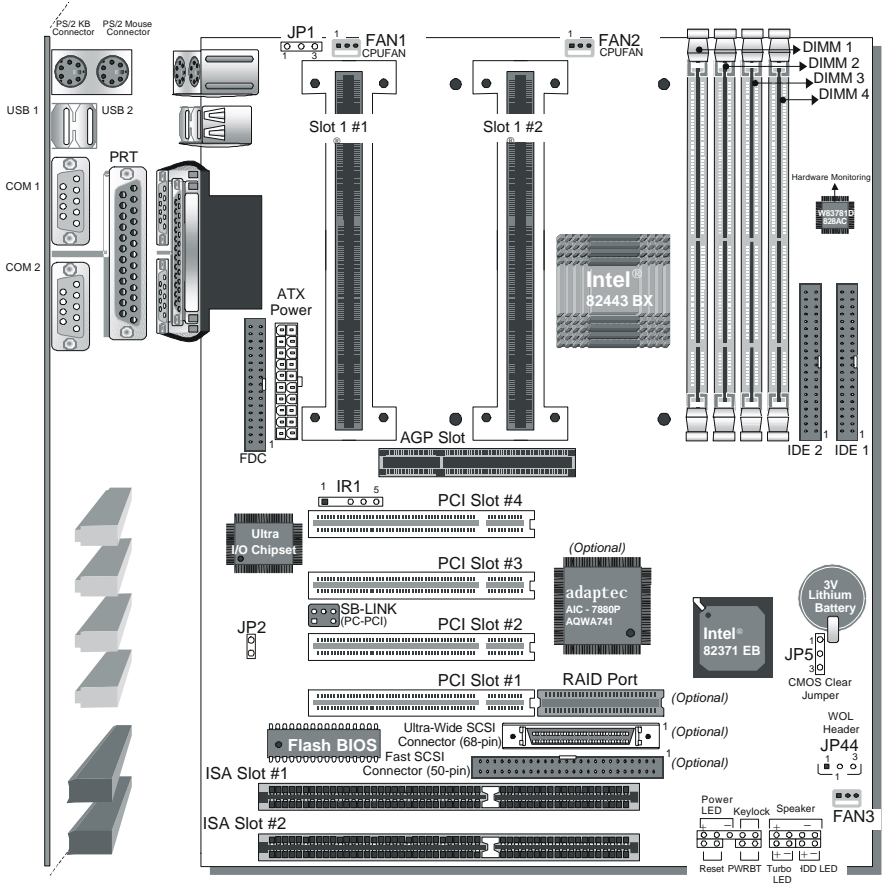

Back Panel

SY-D6IBA Platform

Chapter 1

INTRODUCTION

The **SY-D6IBA** AGP/PCI Motherboard is a high-performance, **Single or Dual slot 1 processor** supported, ATX form-factor system board. **SY-D6IBA** uses the 82440 BX Chipset technology and supports most slot 1 processors. This Motherboard is fully compatible with industry standards and adds many technical enhancements.

1-1 KEY FEATURES

Supports Intel Pentium® III processor (450-550MHz) & Pentium® II processor (233-450MHz)

Auto-detect CPU voltage

Soft CPU settings in BIOS with the "SOYO COMBO Setup"

SCSI and RAIDport™onboard (*optional*)

PC97, ACPI, Ultra DMA/33

Supports system memory up to 1GB (1000 Mbytes)

Power-on by modem or alarm

Supports Wake-On-LAN (WOL)

Supports Power-On by PS/2 keyboard

Supports Creative SB-LINK™(PC-PCI) for PCI audio

Supports onboard hardware monitoring and includes

Hardware Doctor™utility

1 x 32-bit AGP slot

4 x 32-bit bus mastering PCI slots

2 x USB ports onboard

1 x IrDA port

Supports multiple-boot function

ATX power connector

Y2K Compliant

Support Power failure resume

SY-D6IBA PLATFORM FEATURES

| | |
|----------------|---|
| Board Size | 4-layer PCB, 25x30.5cm (9.8" x 12"), ATX Form Factor |
| Slot1 | Slot 1 for Pentium® III & Pentium® II <ul style="list-style-type: none">➤ Supports the following processors<ul style="list-style-type: none">◆ 100MHz FSB Pentium® II 350/400/450 MHz Pentium® III 450/500/550 MHz◆ 66MHz FSB Pentium® II 233/266/300/333 MHz➤ Supports both boxed and non-boxed type of CPUs➤ Includes a CPU mount kit with retention clip➤ Features Auto-detection of CPU voltage |
| Chipset | 82440 BX AGP/PCI Set |
| ATX Power | 20-pin Male Connector |
| FAN1 | Slot1 #1 CPU: 3-pin CPU Cooling Fan Connector |
| FAN2 | Slot1 #2 CPU: 3-pin CPU Cooling Fan Connector |
| FAN3 | Chassis Cooling Fan Connector |
| Memory | DIMM Bank (DIMM1~4) <ul style="list-style-type: none">➤ Four strips of 168-pin Unbuffered and Registered SDRAM DIMM➤ Supports 8/16/32/64/128/256MB DIMM modules in each bank➤ Provides up to 1 Gbytes (1000 MB) of main memory➤ Supports ECC configuration |
| BIOS | System BIOS built-in, Award BIOS <ul style="list-style-type: none">➤ APM, ACPI and "Plug-and-Play" functions➤ Supports multiple-boot function➤ Onboard FLASH memory for easy upgrade➤ DMI utility |
| Bus Controller | Compliant with v2.1 PCI specifications |
| PCI Slots | 4 x 32-bit Bus Mastering Slots |
| AGP Slot | 1 x 32-bit AGP Slot |
| ISA Slots | 2 x 16-bit ISA Slots |

| | |
|-----------------|--|
| IDE1, IDE2 | 2 x 40-pin Bus Mastering E-IDE/ATAPI Ports <ul style="list-style-type: none">➤ IDE1: Primary IDE Device Connector➤ IDE2: Secondary IDE Device Connector➤ Supports Ultra DMA/33 |
| FDC | 1 Floppy Disk Drive (FDD) Port (Supports 1.2MB/1.44MB/2.88MB and LS120/3-mode FDD) |
| IR | 5-pin Serial Infrared Device Header |
| Keylock | 5-pin KeyLock Header |
| Reset | 2-pin Reset Switch Header |
| Speaker | 4-pin PC Speaker Header |
| TB_LED | 2-pin Turbo LED Header |
| HDD_LED | 2-pin IDE Device LED Header |
| PWRBT | ATX Power On/Off Switch 2-pin Header |
| JP1 | Power-On by PS/2 Keyboard Jumper |
| JP2 | Power Button Enable Jumper |
| JP5 | CMOS Clear Jumper |
| JP44 | WOL (Wake-On-LAN) 3-pin Header |
| SBLINK™ | PCI Audio Card Header, (PC-PCI) |
| Ultra-Wide SCSI | 68-pin Ultra-Wide SCSI Connector onboard (<i>optional</i>) |
| Fast SCSI | 50-pin Fast SCSI Connector onboard (<i>optional</i>) |
| RAIDport™ | 60-pin Adaptec® RAIDport™ Slot onboard (<i>optional</i>) |

SY-D6IBA BACK-PANEL FEATURES

| | |
|------------|--|
| PRT | 1 x Onboard 26-pin Female Parallel Printer Port <ul style="list-style-type: none">➤ ECP/EPP/SPP multi-mode parallel printer port |
| COM1, COM2 | 2 x Onboard RS-232 Serial Ports <ul style="list-style-type: none">➤ Feature 2 x high-speed UARTs (with 16550 FIFO) |
| PS/2 KB | 1 x Onboard PS/2 Keyboard Connector |
| PS/2 Mouse | 1 x Onboard PS/2 Mouse Connector |
| USB1, USB2 | 2 x Onboard USB (Universal Serial Bus) Connectors |

1-2 HANDLING THE MOTHERBOARD

To avoid damage to your Motherboard, follow these simple rules while unpacking:

- Before handling the Motherboard, ground yourself by grasping an unpainted portion of the system's metal chassis.
- Remove the Motherboard from its anti-static packaging. Hold the Motherboard by the edges and avoid touching its components.
- Check the Motherboard for damage. If any chip appears loose, press carefully to seat it firmly in its socket.



Warning: Do not apply power if the Motherboard appears damaged. If there is damage to the board, contact your dealer immediately.

1-3 ELECTROSTATIC DISCHARGE PRECAUTIONS

Make sure to ground yourself before handling the Motherboard or other system components. Electrostatic discharge can easily damage the components. Note that you must take special precautions when handling the Motherboard in dry or air-conditioned environment.

To protect your equipment from electrostatic discharge, take the following precautions:

- Do not remove the anti-static packaging until you are ready to install.
 - Ground yourself before removing any system component from its protective anti-static packaging. (To ground yourself, grasp the expansion slot covers or other unpainted portions of the computer chassis.)
 - Frequently ground yourself while working or use a grounding strap.
 - Handle the Motherboard by its edges and avoid touching its components.
-

Chapter 2

HARDWARE SETUP

Congratulations on your purchase of **SY-D6IBA** Motherboard. You are about to install and connect your new Motherboard.



Note: Do not unpack the Motherboard from its protective anti-static packaging until you have made the following preparations.

2-1 PREPARATIONS

Gather and prepare all the following hardware equipment to complete the installation successfully:

1. Single or Dual Pentium® II/III processor with built-in CPU cooling fan (boxed type).



Note: This Motherboard supports non-boxed type CPUs. The heavier CPU cooling fan requires the installation of a CPU support stand included in the Motherboard package.

2. DIMM memory module
3. Computer case and chassis with adequate power supply unit
4. Monitor
5. PS/2 Keyboard
6. Pointing Device (PS/2 mouse)
7. Speaker(s) (optional)
8. Disk Drives: HDD, CD-ROM, and Floppy drive ...
9. External Peripherals: Printer, Plotter, and Modem (optional)
10. Internal Peripherals: Modem and LAN cards (optional)
11. Internal SCSI Devices: Hard/Floppy/CD-ROM Drives, Tape Drives, Removable Media Drives, etc. (*optional*)

2-2 UNPACKING THE MOTHERBOARD

When unpacking the Motherboard, check for the following items:

- The **SY-D6IBA** 82440 BX AGP/PCI Motherboard
- The *Quick Start Guide* *
- The Installation CD-ROM *
- Two SCSI Driver Installation Diskettes labeled "7800 Family Manager Set V2.10" (*optional*)
- Two CPU Retention sets
- One IDE Device Flat Cable
- One Floppy Disk Drive Flat Cable
- One 50-pin Fast SCSI Cable (*optional*)
- One 68-pin Ultra-Wide SCSI Cable (*optional*)

* If your board comes with a driver disc and a paper manual, the Quick Start Guide and the CD-ROM are not included in the package.



Warning: Do not unpack the Motherboard from its anti-static packaging until you are ready to install it.

Like most electronic equipment, your Motherboard may be damaged by electrostatic discharge. To avoid permanent damage to components ground yourself while working by using a grounding strap. Otherwise, ground yourself frequently by touching the unpainted portion of the computer chassis to drain the static charges.

Handle the Motherboard carefully, holding it by the edges. You are now ready to start the installation.

2-3 INSTALLATION GUIDE

We will now begin the installation of the Motherboard. Please follow the step-by-step procedure designed to lead you to a complete and correct installation.



Warning: Turn off the power to the Motherboard, system chassis, and peripheral devices before performing any work on the Motherboard or system.

BEGIN THE INSTALLATION

Step 1. Single or Dual CPU Installation



Notice 1 (Dual processor): When installing two processors (Dual CPU), please make sure the front side bus and working frequency are identical for both processors.



Notice 2 (Single processor): If you are using a single processor, preferably install the processor in Slot 1 #1, leaving Slot 1 #2 empty for future expansion to dual CPU.

Your SY-D6IBA Motherboard comes with two CPU retention Module. The retention set is used to hold each Single or Dual Slot1 processor attached to the Slot 1 #1 or Slot1 #2 CPU connectors on the Motherboard.

Your SY-D6IBA motherboard comes with a CPU retention set kit. The retention set is used to hold the processor attached to the Slot 1 CPU connector on the motherboard.

Follow these instructions to install your Slot 1 processor correctly.

➤ Retention Module



1. Open the two sides by folding them up.

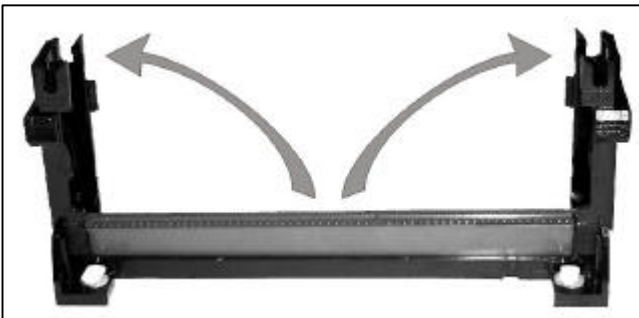

2. Push the locks on top of the CPU inward.



3. Insert the CPU into the retention module. The CPU fits in the CPU slot in only ONE way, do not try to force it in.



4. After completely inserting the CPU, push the two locks on top of the CPU outward. Now your CPU is ready for use.



HOT

To remove the CPU, press the two notches on top of the CPU inward. Now press the two slides on the retention module down and remove the CPU.



Note: Installing a heat sink and cooling fan on top of your CPU is necessary for proper heat dissipation. Failing to install these items may result in overheating and possible burn-out of your CPU.

Step 2. CPU Fan Installation

Your Slot 1 processor kit comes with a cooling fan. Mount the fan on the processor according to the instructions provided by the manufacturer. The fan is a key component that will ensure system stability. The fan prevents overheating, therefore prolonging the life of your CPU.



Note: Remember to connect the fan to the appropriate power source.

Step 3. SDRAM Memory Module Installation

This Motherboard features 4 x DIMM Banks for 168-pin 3.3V unbuffered and registered DIMM modules.

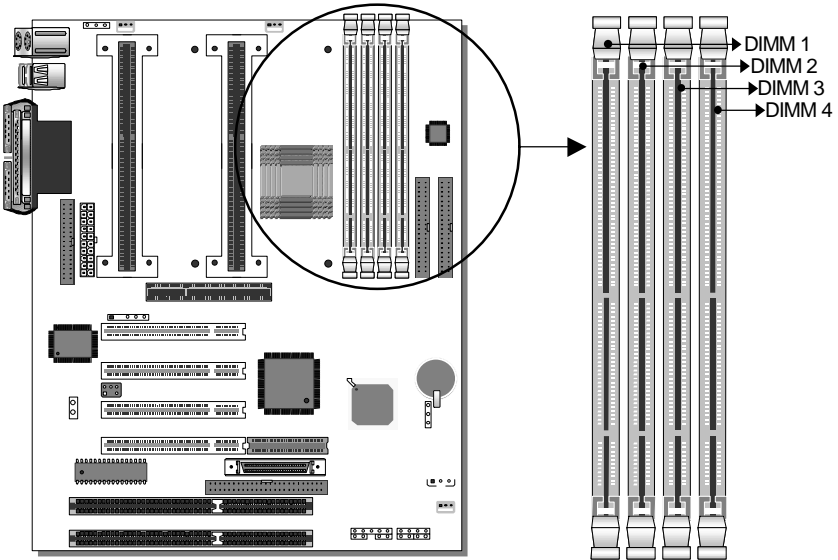

Your board comes with four DIMM sockets, providing support for up to 1GB of main memory using DIMM modules from 8MB to 256MB. For 66MHz front side bus CPUs use 12ns or faster memory; for 100MHz front side bus CPUs use 8ns (100MHz, PC100 compliant) memory.

Memory Configuration

| Number of Memory Modules | DIMM 1 | DIMM 2 | DIMM 3 | DIMM 4 |
|---|---------------------------|-----------------|-----------------|-----------------|
| 1 | 1 st | | | |
| 2 | 1 st | 2 nd | | |
| 3 | 1 st | 2 nd | 3 rd | |
| 4 | 1 st | 2 nd | 3 rd | 4 th |
| RAM Type | SDRAM | | | |
| Memory Module Size (MB) | 8/16/32/64/128/256 Mbytes | | | |
| Notice 1: 256 MB memory modules only available on PC registered DIMM. | | | | |
| Notice 2: Always install memory modules in the order prescribed in this table. | | | | |
| Notice 3: Do not install unbuffered and registered memory modules together. | | | | |



Important: It is of prime importance that you install DIMM modules as outlined in the table above in order to preserve signal integrity on 100MHz front side bus systems.

Step 4. IDE Device Installation (HDD, CD-ROM)

This Motherboard offers two primary and secondary IDE device connectors (IDE1, IDE2.) It can support up to four high-speed HDD or CD-ROM.

Connect one side of the 40-pin flat cable to the IDE device (HDD or CD-ROM) and plug the other end to the primary (IDE1) or secondary (IDE2) directionally keyed IDE connector on the Motherboard.

This Motherboard can support up to four HDDs.

Step 5. Floppy Drive Installation

The system supports 5 possible floppy drive types: 720 KB, 1.2 MB, 1.44 MB, 2.88 MB, and LS-120. In addition, this Motherboard supports a 3-mode (720KB/1.2MB/1.44MB) floppy commonly used in Japan.

Connect one side of the 34-pin flat cable to the floppy drive and plug the other end to the floppy drive connector on the Motherboard.

This Motherboard can support up to 2 floppy drives.

Step 6. Front Panel Connections

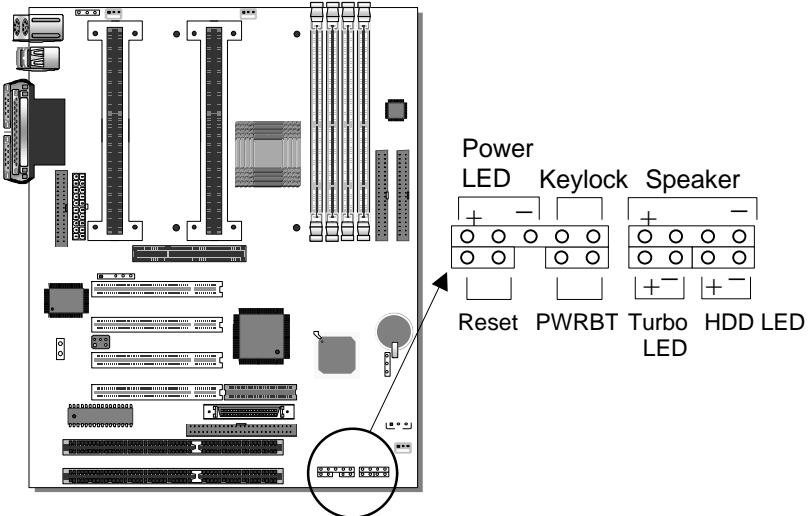

Plug the computer case's front panel devices to the corresponding headers on the Motherboard.

1. Power LED & KeyLock

Plug the Power LED cable into the 5-pin Keylock header.

Some systems may feature a KeyLock function with a front panel switch for enabling or disabling the keyboard. Connect the KeyLock switch to the 5-pin Keylock header on the Motherboard, according to the following pin assignment: pin 1,3 are for Power LED and pin 4,5 are for Keylock.

2. Reset

Plug the Reset push-button cable into the 2-pin Reset header on the Motherboard. Pushing the Reset button on the front panel will cause the system to restart the boot-up sequence.

3. Speaker

Attach the 4-pin PC speaker cable from the case to the Speaker header on the Motherboard.

4. Turbo LED

Connecting the 2-pin Turbo LED cable to the corresponding Turbo LED header will cause the LED to light whenever the system is in Turbo mode.

The manufacturer has permanently set this Motherboard in Turbo mode due to most hardware and software compliance to turbo mode.

5. IDE LED

Attach the 2-pin IDE device LED cable to the corresponding IDE LED header on the Motherboard. This will cause the LED to lighten when an IDE (HDD, CD-ROM) device is active.

6. ATX Power On/Off Switch

Attach the 2-pin momentary type switch to the PWRBT header for turning On or Off your ATX power supply.

Step 7. Back Panel Connections

All external devices such as the PS/2 keyboard, PS/2 mouse, printer, modem, USB can be plugged directly onto the Motherboard back panel.

Only after you have fixed and locked the Motherboard to the computer case can you start connecting the external peripheral devices.

When connecting an external device, use the following figure to locate and identify which back panel connector to plug the device to.

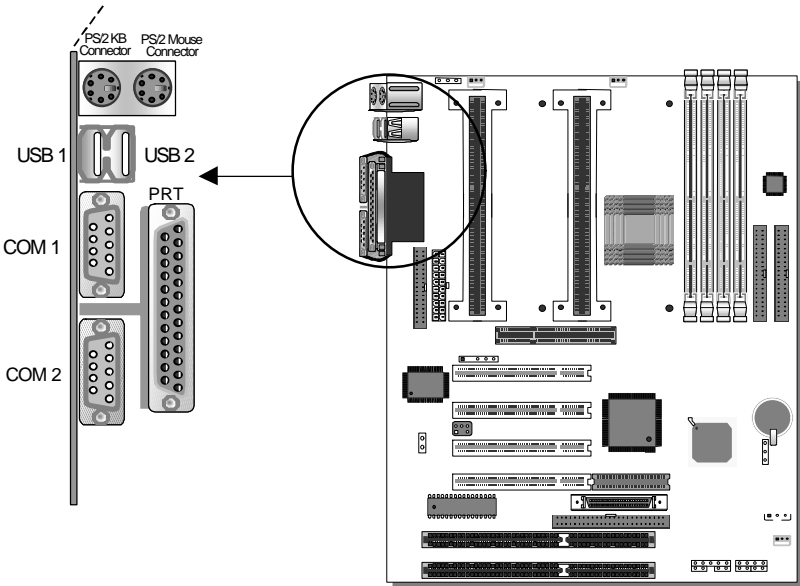

1. Onboard Serial Ports COM1/COM2

External peripherals that use serial transmission scheme include:

- serial mouse,
- and modem.

Plug the serial device cables directly into the COM1/COM2 9-pin male connectors located at the rear panel of the Motherboard.

2. Parallel Port PRT

This parallel port is used to connect the printer or other parallel devices.

Plug the parallel device cable into the 25-pin female connector located at the rear panel of the Motherboard.

3. PS/2 Keyboard

Plug the keyboard jack directly into the 6-pin female PS/2 keyboard connector located at the rear panel of the Motherboard.

4. PS/2 Mouse

Similarly, plug the mouse jack directly into the 6-pin female PS/2 mouse connector.

5. Universal Serial Bus USB1/USB2

This Motherboard provides two USB ports for your additional devices. Plug the USB device jack into the available USB connector USB1 or USB2.

- USB devices under Win98 are allowed.
- With Win95, use the flow UHCI specifications.

Step 8. Other Connections**1. Wake-On-LAN (WOL)**

Attach the 3-pin connector from the LAN card which supports the Wake-On-LAN (WOL) function to the JP44 header on the Motherboard. This WOL function lets users wake up the connected computer through the LAN card.

Please install according to the following pin assignment:

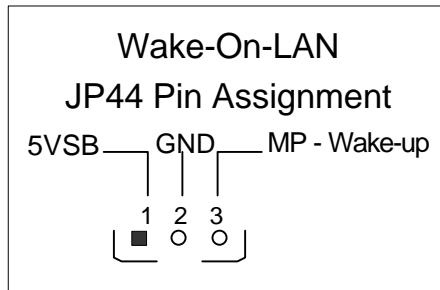

2. Infrared (IR1)

Plug the 5-pin infrared device cable to the IR1 header. This will enable the infrared transfer function. This Motherboard meets both the ASKIR and HPSIR specifications.

Please install according to the following pin assignment:

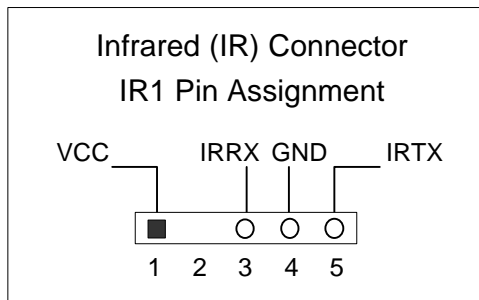

Step 9. Cooling Fan Installation

1. CPU Cooling Fans (FAN 1, FAN 2)

After you have seated the Single or Dual CPU properly on the Motherboard, attach the 3-pin fan cable from each CPU to the corresponding CPUFAN connector FAN 1 or FAN 2 on the Motherboard.

The CPU fans will stop when the system enters into Suspend Mode. (Suspend mode can be enabled from the BIOS Setup Utility, [POWER MANAGEMENT] menu.)

To avoid damage to the system, install according to the following pin assignment:

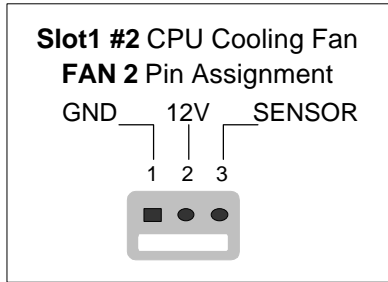
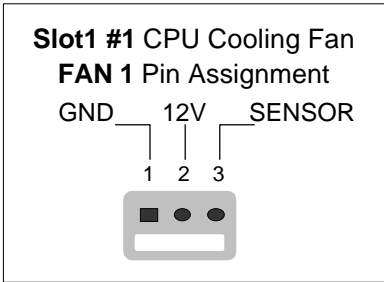

2. Chassis Cooling Fan (FAN 3)

Some chassis also feature a cooling fan. This Motherboard features a FAN 3 connector to provide 12V power to the chassis fan. Connect the cable from the chassis fan to the 3-pin connector labeled FAN 3. Install according to the following pin assignment:

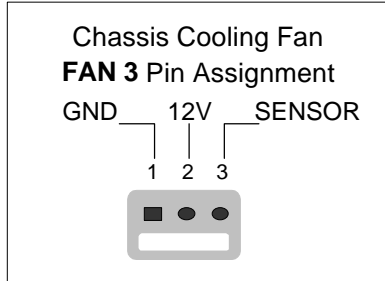

Note: FAN 1 and FAN2 must be installed for this Motherboard, CHAFAN is optional.

Step 10. AGP VGA Card

Insert the AGP VGA card into the AGP slot. Then connect the monitor information cable to the AGP card back plane external connector.

Follow the manufacturer's instructions to perform the AGP VGA drivers installation.

Other Display Cards: Insert other types of VGA cards into the PCI or ISA expansion slots according to card specifications.

Step 11. PCI Audio Card

Some PCI soundcards require a PC-PCI DMA channel. Attach the 5-pin cable from your creative sound blaster PCI audio card to the SB-LINK™ header on the Motherboard. The SB-LINK™ will forward requests for legacy DMA channel to the PCI Bus.

Step 12. ATX Power Supply

Plug the connector from the power directly into the 20-pin male ATX PW connector on the Motherboard, as shown in the following figure.

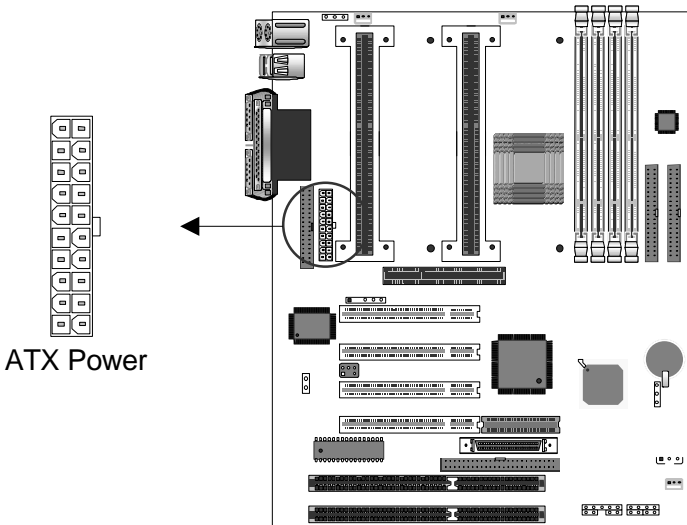

Warning: Follow these precautions to preserve your Motherboard from any remnant currents when connecting to ATX power supply:



Turn off the power supply and unplug the power cord of the ATX power supply before connecting to ATX PW connector.

The Motherboard requires a power supply with at least 200 Watts and a "power good" signal. Make sure the ATX power supply can take at least 10 mA* load on the 5V Standby lead (5VSB) to meet the standard ATX specification.



* **Note:** If you use the Wake-On-LAN (WOL) function, make sure the ATX power supply can support at least 720 mA on the 5V Standby lead (5VSB).

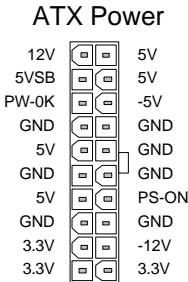

Please install the ATX power according to the following pin assignment:



➤ **Pay special care to the directionality.**

Step 13. Power-On by PS/2 Keyboard Jumper (JP1)

You can choose to enable the Power-On by PS/2 Keyboard function by shorting pin 1-2 on jumper JP1, otherwise, short pin 2-3 to disable this function.

| Power-On by PS/2 Keyboard | Enable | Disable |
|---------------------------|--|---|
| JP1 Setting | Short pin 2-3 to enable the Power-On by PS/2 Keyboard function.  | Short pin 1-2 to disable the Power-On by PS/2 Keyboard function.  |





Note: When using the Power-On by PS/2 Keyboard function, please make sure the ATX power supply can take at least 720mA load on the 5V Standby lead (5VSB) to meet the standard ATX specification.

Step 14. CMOS Clearing (JP5)

After you have turned off your computer, clear the CMOS memory by momentarily shorting pins 2-3 on jumper JP5, for a few seconds. Then restore JP5 to the initial 1-2 jumper setting in order to recover and retain the default settings.



After you have turned off your computer, clear the CMOS memory by momentarily shorting pin 2-3 on jumper JP5 for at least 5 seconds. Then permanently short pin 1-2 to retain new settings.

Jumper JP5 can be easily identified by its white colored cap.

| CMOS Clearing | Retain CMOS Data | Clear CMOS Data |
|---|---|---|
| JP5 Setting | Short pin 1-2 to retain the new CMOS settings.  | Short pin 2-3 for at least 5 seconds to clear the CMOS.  |
| Note: You must unplug the ATX power cable from the ATX power connector when performing the CMOS Clear operation. | | |

Step 15. Power Button Enable (JP2)

Your system can be power on by either pressing a power button or typing in a password, which can be set in the BIOS SOYO COMBO Setup. To avoid being unable to power up the system due to of forgetting the password, you can place a jumper cap to short JP2. This will always enable the Power Button.

| Power Button Enable | Power Button always enabled | Power Button according to BIOS setting |
|---------------------|--|---|
| JP2 Setting | Short pin to always enable the Power Button.  | Open pin for a Power Button function according to the BIOS setting.  |

Step 16. Power On

You have now completed the hardware installation of your Motherboard successfully.

1. Turn the power on
2. To enter the BIOS Setup Utility, press the key while the system is performing the diagnostic checks,



Note: If you fail to enter the BIOS, wait until the boot up sequence is completed. Then push the RESET button and press key again at the beginning of boot-up, during diagnostic checks.

Repeat this operation until you get the following screen.

3. The BIOS Setup screen appears:

| ROM PCI/ISA BIOS CMOS SETUP UTILITY AWARD SOFTWARE, INC. | |
|--|---------------------------|
| SOYO COMBO SETUP | INTEGRATED PERIPHERALS |
| STANDARD CMOS SETUP | SUPERVISOR PASSWORD |
| BIOS FEATURES SETUP | USER PASSWORD |
| CHIPSET FEATURES SETUP | IDE HDD AUTO DETECTION |
| POWER MANAGEMENT SETUP | SAVE & EXIT SETUP |
| PNP/PCI CONFIGURATION | EXIT WITHOUT SAVING |
| LOAD SETUP DEFAULTS | |
| Esc : Quit | ↑ ↓ → ← : Select Item |
| F10 : Save & Exit Setup | (Shift) F2 : Change Color |
| Time, Date, Hard Disk Type... | |

Step 17. Quick BIOS Setup

This Motherboard does not use any hardware jumpers to set the CPU frequency. Instead, CPU settings are software configurable with the BIOS [**SOYO COMBO SETUP**]. The [**SOYO COMBO SETUP**] menu combines the main parameters that you need to configure, all in one menu, for a quick setup in BIOS.

After the hardware installation is complete, turn the power switch on, then press the key during the system diagnostic checks to enter the Award BIOS Setup program. The CMOS SETUP UTILITY will display on screen. Follow these steps to configure the CPU settings.

1. Select [**LOAD SETUP DEFAULT**]

Select the "LOAD SETUP DEFAULT" menu and type "Y" at the prompt to load the BIOS optimal setup.

2. Select [**STANDARD CMOS SETUP**]

Set [Date/Time] and [Floppy drive type], then set [Hard Disk Type] to "Auto".

3. Select [SOYO COMBO SETUP]

Move the cursor to the [CPU Frequency] field to set the CPU working frequency, as shown in the following display.

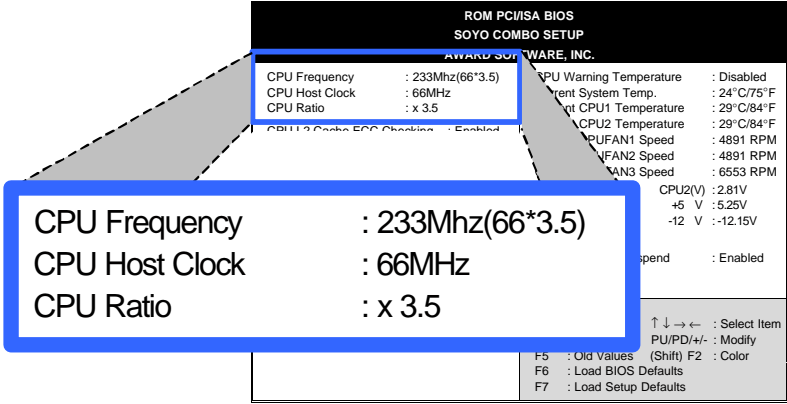

Available [CPU Frequency] settings on your SY-D6IBA Motherboard are detailed in the following table. If you set this field to [Manual], you are then required to fill in the next two consecutive fields: (1) the CPU Host Clock, and (2) the CPU Ratio.

| CPU Frequency | | Select the working frequency of your Pentium® III, Pentium® II, Celeron™ processor among these preset values. Note: <input checked="" type="checkbox"/> Mark the checkbox that corresponds to the working frequency of your Pentium® III, Pentium® II, Celeron™ processor in case the CMOS configuration should be lost. |
|--|---|--|
| <input type="checkbox"/> 233MHz (66 x 3.5) | <input type="checkbox"/> 350MHz (100 x 3.5) | |
| <input type="checkbox"/> 266MHz (66 x 4.0) | <input type="checkbox"/> 400MHz (100 x 4.0) | |
| <input type="checkbox"/> 300MHz (66 x 4.5) | <input type="checkbox"/> 450MHz (100 x 4.5) | |
| <input type="checkbox"/> 333MHz (66 x 5.0) | <input type="checkbox"/> 500MHz (100 x 5.0) | |
| <input type="checkbox"/> 366MHz (66 x 5.5) | <input type="checkbox"/> 550MHz (100 x 5.5) | |
| <input type="checkbox"/> 400MHz (66 x 6.0) | <input type="checkbox"/> 600MHz (100 x 6.0) | |
| <input type="checkbox"/> 433MHz (66 x 6.5) | <input type="checkbox"/> | |

4. Select [SAVE & EXIT SETUP]

Press <Enter> to save the new configuration to the CMOS memory, and continue the boot sequence.

Step 18. Power Off

There are two possible ways to turn off the system:

1. Use the **Shutdown** command in the **Start Menu** of Windows 95/98 to turn off your computer.
2. Press the mechanical power-button and **hold down for over 4 seconds**, to shutdown the computer. If you press the power-button for less than 4 seconds, then your system will enter into **Suspend Mode**.

Troubleshooting at First Start

- **What should I do if the Motherboard refuses to start?**

The 350MHz setting is used as default so whenever the BIOS settings are erased or reset, the board will be able to boot up. If the CPU speed was set too high and the Motherboard refuses to start up, you can always load the default values by pressing the [Ins] key during boot up.

- **Over-clocking may cause system malfunctions!**

The SY-D6IBA Motherboard provides over-clocking capability. Due to the over-clocking setting your system may fail to boot up or hang during run time. If this occurs, please perform the following steps to recover your system from the abnormal situation:

1. Turn off system power. (If you use an ATX power supply, and depending on your system, you may have to press the power button for more than 4 seconds to shut down the system.)
2. Press and hold down the <Insert> key while turning on the system power. Keep holding down the <Insert> key until you see the message of the CPU type and frequency (133MHz or 200MHz) appear on screen.
3. Press the key during the system diagnostic checks to enter the Award BIOS Setup program.
4. From the BIOS main menu, select [SOYO COMBO SETUP] and move the cursor to the [CPU Frequency] field to set the proper working frequency.
5. Select [Save & Exit SETUP] and press <Enter> to save the configuration to the CMOS memory, and continue the boot sequence.



Note: SOYO **does not** guarantee system stability if the user over clocks the system. Any malfunctions due to over-clocking **are not** covered by the warranty.

You are now ready to configure your system
with the *BIOS Setup* program.



Please go to ***Chapter 3: BIOS SETUP***

Chapter 3

BIOS SETUP UTILITY

This Motherboard's BIOS setup program uses the ROM PCI/ISA BIOS program from Award Software Inc.

To enter the Award BIOS program's Main Menu:

1. Turn on or reboot the system.
2. After the diagnostic checks, press the [Del] key to enter the Award BIOS Setup Utility.

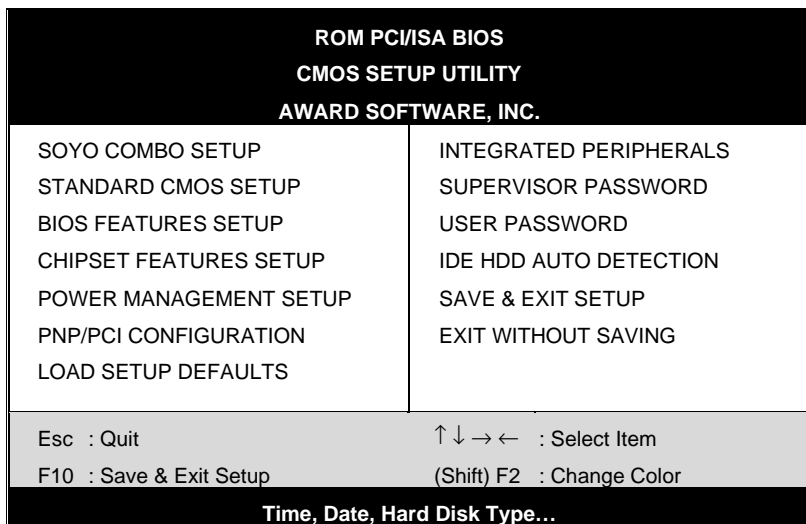

Selecting items

- Use the arrow keys to move between items and select fields.
- From the Main Menu press arrow keys to enter the selected submenu.

Modifying selected items

- Use the [Up]/[Down] keys to modify values within the selected fields. Some fields let you enter values directly.

Hot Keys: Function keys give you access to a group of commands throughout the BIOS utility.

| Function | Command | Description |
|----------|---------------------|--|
| F1 | Help | Gives the list of options available for each item. |
| Shift F2 | Color | Change the color of the display window. |
| F5 | Old values | Restore the old values. These are the values that the user started the current session with. |
| F6 | Load BIOS Defaults | Loads all options with the BIOS Setup default values. |
| F7 | Load Setup Defaults | Loads all options with the Power-On default values. |
| F10 | Save & Exit Setup | Saves your changes and reboots the system. |
| [Esc] | Quit | Let's you return at anytime and from any location to the Main Menu. |

SAVE AND EXIT SETUP

Select the [SAVE & EXIT SETUP] option from the Main Menu to save data to CMOS and exit the setup utility. This option saves all your changes and causes the system to reboot.

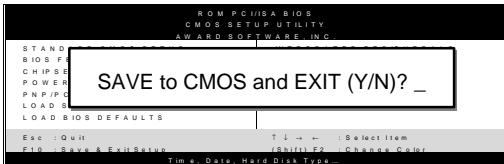

Type [Y] to save the changes and exit or [N] to return to the Main Menu and keep current values.

EXIT WITHOUT SAVING

Selecting the [EXIT WITHOUT SAVING] option allows you to abandon all data and exit setup, therefore ignoring all your changes.

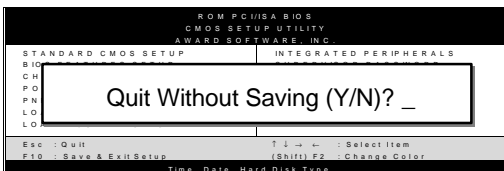

Type [Y] to abandon changes and exit or [N] to return to the Main Menu and keep current values.

3-1 SOYO COMBO SETUP

This Motherboard does not use any hardware jumpers to set the CPU frequency. Instead, CPU settings are software configurable with the BIOS **[SOYO COMBO SETUP]**.

| ROM PCI/ISA BIOS | |
|---------------------------|-----------------------|
| SOYO COMBO SETUP | |
| AWARD SOFTWARE, INC. | |
| CPU Frequency | : 233Mhz(66*3.5) |
| CPU Host Clock | : 66MHz |
| CPU Ratio | : x 3.5 |
| CPU L2 Cache ECC Checking | : Enabled |
| Boot Sequence | : A,C,SCSI |
| Quick Power On Self Test | : Enabled |
| POWER ON Function | : BUTTON ONLY |
| KB Power ON Password | : Enter |
| Hot Key Power ON | : Ctrl-F1 |
| Soft-Off by PWR-BTTN | : Instant-Off |
| Power-On by Ring/LAN | : Enabled |
| Power-On by Alarm | : Disabled |
| CPU Warning Temperature | : Disabled |
| Current System Temp. | : 24°C/75°F |
| Current CPU1 Temperature | : 29°C/84°F |
| Current CPU2 Temperature | : 29°C/84°F |
| Current CPUFAN1 Speed | : 4891 RPM |
| Current CPUFAN2 Speed | : 4891 RPM |
| Current CPUFAN3 Speed | : 6553 RPM |
| CPU1(V) | : 2.81 V |
| CPU2(V) | : 2.81V |
| +3.3 V | : 3.40 V |
| +5 V | : 5.25V |
| +12 V | : 12.16V |
| -12 V | : -12.15V |
| -5 V | : -5.26V |
| CPUFAN Off In Suspend | : Enabled |
| ESC | : Quit |
| F1 | : Help |
| F5 | : Old Values |
| F6 | : Load BIOS Defaults |
| F7 | : Load Setup Defaults |
| ↑ ↓ → ← | : Select Item |
| PU/PD/+/- | : Modify |
| (Shift) F2 | : Color |

After the hardware installation is complete, turn the power switch on, then press the key during the system diagnostic checks to enter the Award BIOS Setup program. The CMOS SETUP UTILITY will display on screen. Then, select the **[SOYO COMBO SETUP]** option from the main menu and press the <Enter> key.

The **[SOYO COMBO SETUP]** menu combines the main parameters that you need to configure, all in one menu, for a quick setup in BIOS.

3-1.1 Quick CPU Speed Settings

| Quick CPU Speed Settings | Setting | Description | Note |
|---|---|--|---|
| CPU Speed (*Default) | Manual | Select the working frequency of your Pentium®II processor among these preset values. | Note: Setting this field to [Manual] requires you to fill in the next two consecutive fields: (1) the [CPU Host Clock], (2) the [CPU Ratio]. |
| | 133MHz (66 x 2) | | |
| | 166MHz (66 x 2.5) | | |
| | 200MHz (66 x 3) | | |
| | 233MHz (66 x 3.5) | | |
| | 266MHz (66 x 4) | | |
| | 300MHz (66 x 4.5) | | |
| | 333MHz (66 x 5) | | |
| | 350MHz (100 x 3.5) | | |
| | 400MHz (100 x 4) | | |
| | 450MHz (100 x 4.5) | | |
| 500MHz (100 x 5) | | | |
| 550MHz (100 x 5.5) | | | |
| If [CPU Speed] field is set to [Manual] | | | |
| CPU Host Clock | 68 MHz | Select the host clock of your Pentium®II processor among these values. | Note: For the EX/LX chipset, 66MHz and 100MHz host clock frequencies are acceptable. However, the system stability is not guaranteed for other frequencies due to the limitations of this chipset. |
| | 75 MHz | | |
| | 83 MHz | | |
| | 66 MHz | | |
| | 103 MHz | | |
| | 112 MHz | | |
| | 133 MHz | | |
| | 100 MHz | | |
| If [CPU Speed] field is set to [Manual] | | | |
| CPU Ratio | After you have selected the host clock, choose the right multiplier for the CPU. Options are: [2, 2.5, 3., 3.5, 4, 4.5, 5, 5.5]. The CPU frequency is then defined as [host clock freq.]x[multiplier], and should match the working frequency of your Pentium®II processor. | | |

3-1.2 L2 Cache Memory

| | Setting | Description | Note |
|----------------------------------|----------|---|---------|
| CPU L2 Cache ECC Checking | Disabled | | Default |
| | Enabled | This option activates the CPU L2 cache ECC checking function. | |

3-1.3 System Boot Control Settings

| System Boot Control Settings | Setting | Description | Note |
|---------------------------------|------------|---|---------|
| Boot Sequence | A,C,SCSI | Choose the boot sequence adapted to your needs, for example: <ul style="list-style-type: none"> • [A,C,SCSI] means the BIOS will look for an operating system first in drive A, then in drive C, and eventually in SCSI device. | |
| | C,A,SCSI | | |
| | C,CD-ROM,A | | |
| | CD-ROM,C,A | | |
| | D,A,SCSI | | |
| | E,A,SCSI | | |
| | F,A,SCSI | | |
| | SCSI,A,C | | |
| | SCSI,C,A | | |
| | C only | | |
| LS/ZIP,C | | | |
| Quick Power On Self Test | Disabled | | |
| | Enabled | Provides a fast POST (Power-On Self Test) at boot-up. | Default |

3-1.4 Power Management

| PM Events | Setting | Description | Note |
|---|-----------------------|---|---------|
| POWER ON Function | BUTTON-ONLY | Disables the Wake-Up by Keyboard function. | Default |
| | KB Power ON Password | Enables you to wake-up the system by entering a password at the keyboard. | |
| | Hot Key | You can wake-up the system by pressing the key combination of your choice (Ctrl-F1~F12). | |
| If [POWER ON Function] is set to [KB Power ON Password] | | | |
| KB Power ON Password | Enter (your password) | Set the password that will wake-up your system. | |
| If [POWER ON Function] is set to [Hot Key] | | | |
| KB Power ON Password | Ctrl-F1~F12 | Choose the key combination that will wake-up the system. [Ctrl-F1 to Ctrl-F12] | |
| Soft-Off by PWR-BTTN | Instant-off | | Default |
| | Delay 4 Sec. | Turns off the system power 4 seconds after pushing the power button. | |
| Power-On by Ring/LAN | Disabled | | |
| | Enabled | The system will self-power on me when the modem is ringing. | Default |
| Power-On by Alarm | Disabled | The system ignores the alarm. | Default |
| | Enabled | Set alarm to power on the system by the date (1-31) or time (hh:mm:ss). If the date is set to [0], the system will self-power on by alarm everyday at the set time. | |

3-1.5 CPU Device Monitoring

| CPU Device Monitoring | Setting | Description | Note |
|----------------------------------|----------------|--|----------------|
| CPU Warning Temperature | Disabled | | Default |
| | Enabled | Set CPU temperature from 50°C to 70°C. The CPU will slow down when CPU temperature goes beyond the preset value. The CPU will continue to run slow until the temperature returns back within the safe range. | |
| Current System Temp. | °C/°F | Shows the current status of the system temperature. | |
| Current CPU1 Temperature | °C/°F | Shows the current status of the CPU1 temperature. | Slot #1 |
| Current CPU2 Temperature | °C/°F | Shows the current status of the CPU2 temperature. | Slot #2 |
| Current CPUFAN1 Speed | °C/°F | Shows the current status of CPU Fan speed for CPU1. | Slot #1 |
| Current CPUFAN2 Speed | °C/°F | Shows the current status of CPU Fan speed for CPU2. | Slot #2 |
| Current CPUFAN3 Speed | °C/°F | Shows the current status of the Chassis Fan speed | |
| CPU1(V), +3.3V, +12V, -5V | V | Shows the current voltage status on CPU1. | Slot #1 |
| CPU2(V), +5V, -12V | V | Shows the current voltage status on CPU2. | Slot #2 |
| CPUFAN Off In Suspend | Disabled | Disables the PM timer. | |
| | Enabled | Switches off the CPU Fan when the system enters Suspend Mode. | Default |

3-2 STANDARD CMOS SETUP

Select the [STANDARD CMOS SETUP] option from the Main Menu and press [Enter] key.

| ROM PCI/ISA BIOS | | | | | | | |
|----------------------------------|--------|-------------------|----------------|-------------------------|-----------|-------------------|-------------|
| STANDARD CMOS SETUP | | | | | | | |
| AWARD SOFTWARE, INC. | | | | | | | |
| Date (mm:dd:yy) | | : Mon, Sep 7 1998 | | | | | |
| Time (hh:mm:ss) | | : 11 : 30 : 33 | | | | | |
| HARD DISKS | TYPE | SIZE | CYLS | HEAD | PRECOMP | LANDZ | SECTOR MODE |
| Primary Master | : AUTO | 0 | 0 | 0 | 0 | 0 | 0 AUTO |
| Primary Slave | : None | 0 | 0 | 0 | 0 | 0 | 0 ---- |
| Secondary Master | : None | 0 | 0 | 0 | 0 | 0 | 0 ---- |
| Secondary Slave | : None | 0 | 0 | 0 | 0 | 0 | 0 ---- |
| Drive A : 1.44M, 3.5 in. | | | | Base Memory: 640K | | | |
| Drive B : None | | | | Extended Memory: 31744K | | | |
| Floppy 3 Mode Support : Disabled | | | | Other Memory: 384K | | | |
| Video : EGA/VGA | | | | Total Memory: 32768K | | | |
| Halt On : All Errors | | | | | | | |
| Esc | : Quit | ↑ ↓ → ← | : Select Item | | PU/PD/+/- | : Modify | |
| F1 | : Help | (Shift) F2 | : Change Color | | F3 | : Toggle Calendar | |

This screen allows you to modify the basic CMOS settings. After you have completed the changes, press [Esc] key to return to the Main Menu.

3-2.1 Date & Time

| | Display | Setting | Please Note |
|-------------|------------|-----------------------|---|
| Date | mm/dd/yyyy | Type the current date | You can also press the PUp/PDn keys to toggle between values. |
| Time | hh:mm:ss | Type the current time | |
| | | | 24-hour clock format 3:15 PM is displayed as 15:15:00 |

3-2.2 Hard Disks Type & Mode

Choose the type and mode for the hard disks that you have already installed.

| Primary (Secondary) Master & Slave | Setting | Description | Note |
|--|---------|---|---------|
| Type | Auto | BIOS detects hard disk type automatically. | Default |
| | User | User defines the type of hard disk. | |
| | None | | |
| Mode | Auto | BIOS detects hard disk mode automatically. | Default |
| | Normal | Normal IDE hard disk | <528MB |
| | LBA | Enhanced IDE hard disk | >528MB |
| | Large | Large IDE hard disk (for certain hard disk) | |



Note: If you have any questions on your hard disk type or mode, ask your hard disk provider or previous user for details.

3-2.3 Floppy Drives

| Floppy Drives | Setting | Description | Note |
|------------------------------|----------------------------|---|---|
| Drives A & B | 360KB, 5.25 in. | | |
| | 1.2MB, 5.25 in. | | |
| | 720KB, 3.5 in. | | |
| | 1.44MB, 3.5 in. | | Default |
| | 2.88MB, 3.5 in. | | |
| | None | Not installed | |
| Floppy 3-Mode Support | Disabled | | Default |
| | Drive A Drive B Both | Supports 3-mode floppy diskette: 740KB/1.2MB/1.44MB on selected disk drive. | Special disk drive commonly used in Japan |
| | | | |

3-2.4 Video

Select the video mode: EGA/VGA (Default), CGA 40, CGA 80, MONO (Monochrome).

3-2.5 Halt On

When the BIOS detects system errors, this function will stop the system. Select which type of error will cause the system halt: All Errors (Default), No Errors, All But Keyboard, All But Diskette, All But Disk/Key.

3-3 BIOS FEATURES SETUP

Select the [BIOS FEATURES SETUP] option from the Main Menu and press [Enter] key.

| ROM PCI/ISA BIOS | |
|---|------------|
| BIOS FEATURES SETUP | |
| AWARD SOFTWARE, INC. | |
| Virus Warning | : Disabled |
| CPU Internal Cache | : Enabled |
| External Cache | : Enabled |
| Swap Floppy Drive | : Disabled |
| Boot Up NumLock Status | : On |
| Typematic Rate Setting | : Disabled |
| Typematic Rate (Chars/Sec) | : 6 |
| Typematic Delay (Msec) | : 250 |
| Security Option | : Setup |
| PCI/VGA Palette Snoop | : Disabled |
| Assign IRQ for VGA | : Enabled |
| MPS Version Control For OS | : 1.4 |
| OS Select for DRAM > 64MB | : Non-OS2 |
| HDD S.M.A.R.T. capability | : Disabled |
| Report No FDD For WIN 95 | : Yes |
| Video BIOS Shadow | : Enabled |
| C8000-CBFFF Shadow | : Disabled |
| CC000-CFFFF Shadow | : Disabled |
| D0000-D3FFF Shadow | : Disabled |
| D4000-D7FFF Shadow | : Disabled |
| D8000-DBFFF Shadow | : Disabled |
| DC000-DFFFF Shadow | : Disabled |
| ESC : Quit ↑ ↓ → ← : Select Item F1 : Help PU/PD/+/- : Modify F5 : Old Values (Shift) F2 : Color F6 : Load BIOS Defaults F7 : Load Setup Defaults | |

After you have completed the changes, press [Esc] key and follow the instructions on your screen to save your settings or exit without saving.

3-3.1 Virus Warning

| | Setting | Description | Note |
|----------------------|----------------|--|-------------|
| Virus Warning | Disabled | | Default |
| | Enabled | Enable this option to protect the boot sectors and partition tables of your hard disk. Any attempt to write to them will the system to halt and display a warning message. | |

3-3.2 Cache Memory Options

| | Setting | Description | Note |
|---------------------------|----------------|-----------------------------------|-------------|
| CPU Internal Cache | Disabled | | |
| | Enabled | Enables the CPU's internal cache. | Default |
| External Cache | Disabled | | |
| | Enabled | Enables the external memory. | Default |

3-3.3 System Boot Control Settings

| | Setting | Description | Note |
|-------------------------------------|----------------|---|-------------|
| System Boot Control Settings | | | |
| Swap Floppy Drive | Disabled | | Default |
| | Enabled | Changes the sequence of A and B drives. | |
| Boot Up NumLock Status | On | Puts numeric keypad in NumLock mode at boot-up. | Default |
| | Off | Puts numeric keypad in arrow key mode at boot-up. | |

3-3.4 Typematic Settings

| Typematic Settings | Setting | Description | Note |
|---|---------------|--|---------|
| Typematic Rate Setting | Disabled | | Default |
| | Enabled | Enables to adjust the keystroke repeat rate. | |
| The following [Typematic Rate] and [Typematic Delay] fields are active only if [Typematic Rate Setting] is set to [Enabled] | | | |
| Typematic Rate | 6 (Char/sec) | Choose the rate at which a character is repeated when holding down a key. | Default |
| | 8 (Char/sec) | | |
| | 10 (Char/sec) | | |
| | 12 (Char/sec) | | |
| | 15 (Char/sec) | | |
| | 20 (Char/sec) | | |
| | 24 (Char/sec) | | |
| 30 (Char/sec) | | | |
| Typematic Delay | 250 (msec) | Choose how long after you press a key down the character begins repeating. | Default |
| | 500 (msec) | | |
| | 750 (msec) | | |
| | 1000 (msec) | | |

3-3.5 Security Option

Use this feature to prevent unauthorized system boot-up or use of BIOS Setup. The following table describes the security settings.

| Security Option | Setting | Description | Note |
|------------------------|---------|--|---------|
| Security Option | System | Each time the system is booted, the password prompt appears. | |
| | Setup | If a password is set, the password prompt only appears when you attempt to enter the BIOS Setup program. | Default |

3-3.6 Other Control Options

| Other Control Options | Setting | Description | Note |
|-----------------------------------|----------|---|---------|
| PCI/VGA Palette Snoop | Disabled | | Default |
| | Enabled | The color of the monitor may be altered when using an MPEG card. Enable this option to restore the monitor's normal color. | |
| Assign IRQ For VGA | Disabled | | |
| | Enabled | Use this default setting. | Default |
| MPS Version Control For OS | 1.1 | To specify which MPS version to use. | |
| | 1.4 | | Default |
| OS Select for DRAM>64MB | OS2 | When using an OS2 operating system. | |
| | Non-OS2 | When using another, non-OS2 operating system. | Default |
| HDD S.M.A.R.T. capability | Disabled | | Default |
| | Enabled | Enable this field when your HDD supports the S.M.A.R.T. function. Consult your HDD provider for details. | |
| Report No FDD For WIN 95 | Yes | Windows will release IRQ line 6 (normally used by the Floppy Disk Drive) after you disable your on-board FDD and set this field to [Yes]. | Default |
| | No | Windows will reserve INT 6 for your FDD, whether it is disabled or not. | |

Other Control Options (continued)

| Other Control Options | Setting | Description | Note |
|---|----------------|---|-------------|
| Video BIOS Shadow | Disabled | | |
| | Enabled | The BIOS is shadowed in a 16K segment if it is enabled and if it has BIOS present. These 16 segments can be shadowed from ROM to RAM. BIOS shadow copies BIOS code from slower ROM to faster RAM. BIOS can then execute from RAM. | Default |
| C8000-CBFFF/ CC000-CFFFF/ D0000-D3FFF/ D4000-D7FFF/ D8000-DBFFF/ DC000-DFFFF/ Shadow | Disabled | | Default |
| | Enabled | The ROM data at the specified address range will be copied to RAM. | |

3-4 CHIPSET FEATURES SETUP



Caution: Change these settings only if you are already familiar with the Chipset.

The [CHIPSET FEATURES SETUP] option changes the values of the chipset registers. These registers control the system options in the computer.

| ROM PCI/ISA BIOS CHIPSET FEATURES SETUP AWARD SOFTWARE, INC. | |
|--|------------|
| Auto Configuration | : Enabled |
| SDRAM CAS latency Time | : 3 |
| DRAM Data Integrity Mode | : Non-ECC |
| System BIOS Cacheable | : Disabled |
| Video BIOS Cacheable | : Disabled |
| Video RAM Cacheable | : Disabled |
| 8 Bit I/O Recovery Time | : 1 |
| 16 Bit I/O Recovery Time | : 1 |
| Memory Hole At 15M-16M | : Disabled |
| Passive Release | : Enabled |
| Delayed Transaction | : Enabled |
| AGP Aperture Size (MB) | : 64 |
| Spread Spectrum Modulated | : Disabled |
| ESC : Quit ↑ ↓ → ← : Select Item F1 : Help PU/PD/+/- : Modify F5 : Old Values (Shift) F2 : Color F6 : Load BIOS Defaults F7 : Load Setup Defaults | |

After you have completed the changes, press [Esc] and follow the instructions on your screen to save your settings or exit without saving.

The following table describes each field in the CHIPSET FEATURES SETUP Menu and how to configure each parameter.

CHIPSET FEATURES SETUP

| CHIPSET FEATURES | Setting | Description | Note |
|---------------------------------|----------|--|---------|
| Auto Configuration | Disabled | | |
| | Enabled | It is strongly recommended to enable this option so that the system automatically sets all chipset feature options on the left panel of the screen (except for cache update & BIOS cacheable). | Default |
| SDRAM Cache Latency Time | 3 | Use the default setting | Default |
| | 2 | | |
| DRAM Data Integrity Mode | Non-ECC | Choose according to the DRAM type you have. | Default |
| | ECC | | |
| System BIOS Cacheable | Disabled | | Default |
| | Enabled | The ROM area F0000H-FFFFFFH is cacheable. | |
| Video BIOS Cacheable | Disabled | | Default |
| | Enabled | The video BIOS C0000H-C7FFFH is cacheable. | |
| Video RAM Cacheable | Disabled | | Default |
| | Enabled | The ROM area A0000-BFFFF is cacheable. | |
| 8 BIT I/O Recovery Time | 1 | Use the default setting | Default |
| | 2-8,NA | | |
| 16 BIT I/O Recovery Time | 1 | Use the default setting | Default |
| | 2-4,NA | | |
| Memory Hole At 15M-16M | Disabled | | Default |
| | Enabled | Some interface cards will map their ROM address to this area. If this occurs, select [Enabled] in this field. | |

CHIPSET FEATURES SETUP (Continued)

| CHIPSET FEATURES | Setting | Description | Note |
|----------------------------------|----------------|---|-------------|
| Passive Release | Enabled | Use the default setting | Default |
| Delayed Transaction | Enabled | Use the default setting | Default |
| AGP Aperture Size | 64 4-256MB | AGP could use the DRAM as its video RAM. Choose the DRAM size that you wish to allocate as video RAM. | Default |
| Spread Spectrum Modulated | Disabled | | Default |
| | Enabled | When using Spread Spectrum modulated 1.5% or 6% for FCC or DOC testing. | |

3-5 POWER MANAGEMENT SETUP

The [POWER MANAGEMENT SETUP] sets the system's power saving functions.

| ROM PCI/ISA BIOS | | |
|------------------------|------------------|---|
| POWER MANAGEMENT SETUP | | |
| AWARD SOFTWARE, INC. | | |
| Power Management | : User Define | ** Reload Global Timer Events ** |
| PM Control by APM | : Yes | IRQ [3-7,9-15], NMI : Enabled |
| Video Off Method | : V/H SYNC+Blank | Primary IDE 0 : Disabled |
| Video Off After | : Standby | Primary IDE 1 : Disabled |
| MODEM Use IRQ | : 3 | Secondary IDE 0 : Disabled |
| Doze Mode | : Disable | Secondary IDE 1 : Disabled |
| Standby Mode | : Disable | Floppy Disk : Disabled |
| Suspend Mode | : Disable | Serial Port : Enabled |
| HDD Power Down | : Disable | Parallel Port : Disabled |
| VGA Active Monitor | : Disabled | |
| IRQ 8 Break Suspend | : Disabled | |
| | | ESC : Quit ↑ ↓ → ← : Select Item |
| | | F1 : Help PU/PD/+/- : Modify |
| | | F5 : Old Values (Shift) F2 : Color |
| | | F6 : Load BIOS Defaults |
| | | F7 : Load Setup Defaults |

After you have completed the Power Management Setup, press [Esc] to return to the Main Menu.

3-5.1 Power Management Controls

| Power Management Controls | Setting | Description | | | | Note |
|---------------------------|----------------|--|---------------|---------------|----------------|---------|
| Power Management | User Define | Lets you define the HDD and system power down times. | | | | Default |
| | Disable | Disables the Green PC Features. | | | | |
| | | Doze timer | Standby timer | Suspend timer | HDD power down | |
| | Min Saving | 1 Hour | 1 Hour | 1 Hour | 15 Min | |
| | Max Saving | 1 Min | 1 Min | 1 Min | 1 Min | |
| PM Control by APM | Yes | To use Advanced Power Management (APM) you must run [power.exe] under DOS V6.0 or later version. | | | | Default |
| | No | | | | | |
| Video Off Method | V/H Sync+Blank | Selects the method by which the monitor is blanked. | | | | Default |
| | Blank Screen | | | | | |
| | DPMS | | | | | |
| Video Off After | Standby | Choose the PM mode you want video to go off after the mode is being active. | | | | Default |
| | Suspend | | | | | |
| | Doze | | | | | |
| | NA | | | | | |
| MODEM Use IRQ | 3 | Assigns an IRQ# to the modem device. | | | | Default |
| | 3-11,NA | | | | | |

3-5.2 PM Timers

| PM Timers | Setting | Description | Note |
|---|------------|---|---|
| The following [Doze Mode] field may be configured only if [Power Management] is set to [User Define] | | | |
| Doze Mode | Disable | | Default |
| | 1Min-1Hour | When the set time has elapsed, BIOS sends a command to the system to enter Doze Mode. | System clock drops to 33MHz. |
| The following [Standby Mode] field may be configured only if [Power Management] is set to [User Define] | | | |
| Standby Mode | Disable | | Default |
| | 1Min-1Hour | When the set time has elapsed, BIOS sends a command to the system to enter Standby Mode. | |
| The following [Suspend Mode] field may be configured only if [Power Management] is set to [User Define] | | | |
| Suspend Mode | Disable | | Default |
| | 1Min-1Hour | In Suspend mode, the CPU stops completely (no instructions are executed.) | Only an SL-Enhanced (or SMI) CPU can enter this mode. |
| HDD Power Down | Disabled | | Default |
| | 1-15Min | When the set time has elapsed, BIOS sends a command to the HDD to power down. This turns off the HDD motor. | Some older model HDDs may not support this advanced function. |

3-5.3 PM Events

| PM Events | Setting | Description | Note |
|----------------------------|----------|--|---------|
| VGA Active Monitor | Disabled | | Default |
| | Enabled | Enables the power management timers when a [no activity] event is detected on the monitor. | |
| IRQ 8 Break Suspend | Disabled | | Default |
| | Enabled | Alarm function is active. | |

3-5.4 Reload Global Timer Events

| Power Down & Resume Events | Setting | Description | Note |
|---|----------|---|---------|
| IRQ [3-7,9-15], NMI | Disabled | | |
| | Enabled | The system monitors these elements for activity. The system will resume if an [IRQ activity] is detected. | Default |
| IDE0, IDE1 ➤ Primary ➤ Secondary | Disabled | | Default |
| | Enabled | Enables the PM timers when [No Activity Event] is detected. | |
| Floppy Disk | Disabled | | Default |
| | Enabled | Enables the PM timers when [No Activity Event] is detected on the floppy disk drive. | |
| Serial Port | Disabled | | |
| | Enabled | Enables the PM timers when [No Activity Event] is detected on the serial port. | Default |
| Parallel Port | Disabled | | Default |
| | Enabled | Enables the PM timers when [No Activity Event] is detected on the parallel port. | |

3-6 PNP/PCI CONFIGURATION SETUP

This option sets the Motherboard's PCI Slots.

| ROM PCI/ISA BIOS | |
|--------------------------|---------------------------------|
| PNP/PCI CONFIGURATION | |
| AWARD SOFTWARE, INC. | |
| PnP OS Installed | : No |
| Resources Controlled By | : Manual |
| Reset Configuration Data | : Disabled |
| Used MEM base addr | : N/A |
| Assign IRQ For USB | : Enabled |
| IRQ-3 assigned to | : Legacy ISA* |
| IRQ-4 assigned to | : Legacy ISA* |
| IRQ-5 assigned to | : PCI/ISA PnP* |
| IRQ-7 assigned to | : PCI/ISA PnP* |
| IRQ-9 assigned to | : PCI/ISA PnP* |
| IRQ-10 assigned to | : PCI/ISA PnP* |
| IRQ-11 assigned to | : PCI/ISA PnP* |
| IRQ-12 assigned to | : PCI/ISA PnP* |
| IRQ-14 assigned to | : PCI/ISA PnP* |
| IRQ-15 assigned to | : PCI/ISA PnP* |
| DMA-0 assigned to | : PCI/ISA PnP* |
| DMA-1 assigned to | : PCI/ISA PnP* |
| DMA-3 assigned to | : PCI/ISA PnP* |
| DMA-5 assigned to | : PCI/ISA PnP* |
| DMA-6 assigned to | : PCI/ISA PnP* |
| DMA-7 assigned to | : PCI/ISA PnP* |
| ESC | : Quit |
| F1 | : Help |
| F5 | : Old Values (Shift) F2 : Color |
| F6 | : Load BIOS Defaults |
| F7 | : Load Setup Defaults |
| | ↑ ↓ → ← : Select Item |
| | PU/PD/+/- : Modify |



Note: Starred (*) items will disappear when the [Resources Controlled By] option is set to [Auto].

After you have completed the PCI Slot Configuration, press [Esc] and follow the instructions on your screen to save your settings or exit without saving.

3-6.1 PNP/PCI Configuration Controls

| PNP/PCI Controls | Setting | Description | Note |
|---------------------------------|----------|--|---|
| PnP OS Installed | Yes | Set this field to [Yes] if you are running Windows 95/98, which are PnP compatible. | |
| | No | If the OS you are running does not support PnP configuration. | Default (If there is any doubt, set this field to [No]) |
| Resources Controlled By | Manual | BIOS does not manage PCI/ISA PnP card IRQ assignment. Requires to assign IRQ-# and DMA-# to PCI or ISA PnP manually. IRQ-3,4,5,7,9,10,11,12,14,15 assigned to: _ DMA-0,1,3,5,6,7 assigned to: _ | |
| | Auto | The Plug-and-Play BIOS auto manages PCI/ISA PnP card IRQ assignment automatically. | Recommended |
| Reset Configuration Data | Disabled | Retain PnP configuration data in BIOS. | Default |
| | Enabled | Reset PnP configuration data in BIOS. | |

3-6.2 PNP/PCI Configuration Setup

| PNP/PCI Setup | Setting | Description | Note |
|---|---------------|---|---|
| If [Resources Controlled By] is set to [Manual] | | | |
| IRQ-# and DMA-# assigned to: | PCI/ISA PnP | Choose IRQ-# and DMA-# assigned to PCI/ISA PnP card. | IRQ-3,4,5,7,9,10,11,12,14,15 DMA-0,1,3,5,6,7 |
| | Legacy ISA | Choose IRQ-# and DMA-# assigned to Legacy ISA card. | IRQ-3,4,5,7,9,10,11,12,14,15 DMA-0,1,3,5,6,7 |
| Used MEM base addr | N/A | | Default |
| | I/O address | C800,CC00,D000,D400,D800,DC00. (Asking card provider for the exactly I/O address of this add-on card.) | Use this function only when problems occur while using some certain add-on cards. |
| Used MEM Length | Memory length | 8K,16K,32K,64K. (Please ask your card provider for the exactly memory length of this add-on card.) | This item appears only when the [Used MEM base addr] field is set to I/O address. |
| Assign IRQ For USB | Enabled | BIOS will assign IRQ for USB port. | Default |
| | Disabled | BIOS won't assign IRQ for USB port. | |

3-7 LOAD SETUP DEFAULTS

Select the [LOAD SETUP DEFAULTS] option from the Main Menu to load the system values you have previously saved. This option is recommended if you need to reset the system setup and to retrieve the old values.

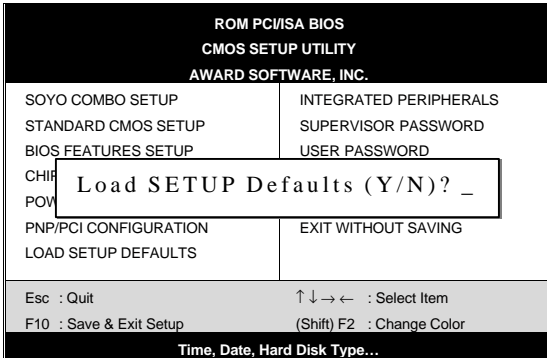

Type [Y] to use the Setup Defaults followed by [Enter] or otherwise [N] to return to the Main Menu and keep current values.



Warning: If you run into any problem after changing the BIOS configuration, please load the SETUP DEFAULTS for stable performance.

3-8 INTEGRATED PERIPHERALS



Caution: Change these settings only if you are already familiar with the Chipset.

The [INTEGRATED PERIPHERALS] option changes the values of the chipset registers. These registers control the system options in the computer.

The following screen shows setup default settings.

| ROM PCI/ISA BIOS | |
|---|------------|
| INTEGRATED PERIPHERALS | |
| AWARD SOFTWARE, INC. | |
| IDE HDD Block Mode | : Enabled |
| IDE Primary Master PIO | : Auto |
| IDE Primary Slave PIO | : Auto |
| IDE Secondary Master PIO | : Auto |
| IDE Secondary Slave PIO | : Auto |
| IDE Secondary Master UDMA | : Auto |
| IDE Secondary Slave UDMA | : Auto |
| On-Chip Primary PCI IDE | : Enabled |
| On-Chip Secondary PCI IDE | : Enabled |
| Onboard PCI SCSI Chip | : Enabled |
| USB Keyboard Support | : Disabled |
| Init Display First | : PCI Slot |
| Onboard PDC Controller | : Enabled |
| Onboard Serial Port 1 | : 3F8/IRQ4 |
| Onboard Serial Port 2 | : 2F8/IRQ3 |
| URART Mode Select | : Normal |
| RxD , TxD Active | : Hi,Lo |
| IR Transmission Delay | : Enabled |
| Onboard Parallel Port | : 378/IRQ7 |
| Parallel Port Mode | : SPP |
| ECP Mode Use DMA | : 3 |
| EPP Mode Select | : EPP1.7 |
| ESC : Quit ↑ ↓ → ← : Select Item F1 : Help PU/PD/+/- : Modify F5 : Old Values (Shift) F2 : Color F6 : Load BIOS Defaults F7 : Load Setup Defaults | |

The following tables describe each field in the INTEGRATED PERIPHERALS Menu and provide instructions on how to configure the IDE controls, FDC controls, and the onboard serial and parallel ports.

3-8.1 IDE Device Controls

| IDE Controls | Setting | Description | Note |
|--|----------|--|---------|
| IDE HDD Block Mode | Disabled | | |
| | Enabled | Invokes multi-sector transfer instead of one sector per transfer. Not all HDDs support this function. | Default |
| IDE <ul style="list-style-type: none"> ➤ Primary Master PIO ➤ Primary Slave PIO ➤ Secondary Master PIO ➤ Secondary Slave PIO | mode 0-4 | 0 is the slowest speed 4 is the fastest speed | |
| | Auto | For better performance and stability, we suggest you use the Auto setting to set the HDD control timing. | Default |
| | Disabled | | |
| | Auto | Select Auto to enable Ultra DMA Mode support. | Default |
| IDE <ul style="list-style-type: none"> ➤ Primary Master UDMA ➤ Primary Slave UDMA | Disabled | | |
| | Auto | Select Auto to enable Ultra DMA Mode support. | Default |
| On-Chip PCI IDE <ul style="list-style-type: none"> ➤ Primary ➤ Secondary | Disabled | Turn off the on-board IDE | |
| | Enabled | Use the on-board IDE | Default |

3-8.2 Onboard SCSI Subsystem Controls

| SCSI Subsystem Controls | Setting | Description | Note |
|------------------------------|----------|---|---------|
| Onboard PCI SCSI Chip | Disabled | | |
| | Enabled | Enables the on-board SCSI function. Also, allows you to configure the SCSISelect™ BIOS utility. (Press <Ctrl-A> during boot-up to enter the SCSI BIOS utility.) | Default |

3-8.3 Keyboard Controls

| Keyboard Controls | Setting | Description | Note |
|-----------------------------|----------------|--------------------|-------------|
| USB Keyboard Support | Disabled | | Default |
| | Enabled | Use a USB keyboard | |

3-8.4 Display Controls

| Display Controls | Setting | Description | Note |
|---------------------------|----------------|---|-------------|
| Init Display First | PCI Slot | Choose which card – AGP Display card or PCI VGA card – to initialize first. | Default |
| | AGP | | |

3-8.5 FDC Controls

| FDC Controls | Setting | Description | Note |
|-------------------------------|----------------|---|-------------|
| Onboard FDC controller | Disabled | Turn off the on-board floppy controller | |
| | Enabled | Use the on-board floppy controller | Default |

3-8.6 Onboard Serial Ports

| Onboard Serial Ports | Setting | Description | Note |
|--|-------------------------|--|------------------|
| Onboard ➤ Serial Port 1 ➤ Serial Port 2 | Disabled | | |
| | 3F8/IRQ4 | Choose serial port 1 & 2's I/O address. | Default (port 1) |
| | 2F8/IRQ3 | Do not set port 1 & 2 to the same address except for [Disabled] or [Auto]. | Default (port 2) |
| | 3E8/IRQ4 | | |
| | 2E8/IRQ3 | | |
| UART Mode Select | Auto | | |
| | Normal | Supports a Standard serial infrared IrDA. | Default |
| | IrDA 1.0 | | |
| | ASKIR | Supports a Sharp serial interface format. | |
| VxD,TxD Active | FIR | Fast Infrared Interface | |
| | Hi,Lo/Lo,Hi/Lo,Lo/Hi,Hi | Check with your IR-device provider for exact setting. | |
| IR Transmission Delay | Enabled | Check with your IR-device provider for exact setting. | Default |
| | Disabled | | |

3-8.7 Onboard Parallel Ports

| Onboard Parallel Ports | Setting | Description | Note |
|---|----------|--|---------|
| Onboard Parallel Port | 378/IRQ7 | Choose the printer I/O address. | Default |
| | 3BC/IRQ7 | | |
| | 278/IRQ5 | | |
| | Disable | | |
| Parallel Port Mode | ECP/EPP | The mode depends on your external parallel device that connects to this port. | |
| | SPP | | Default |
| | ECP | | |
| | EPP | | |
| If [Parallel Port Mode] is set to [ECP] or [ECP/EPP] mode | | | |
| ECP Mode use DMA | 3 | Choose DMA3 | Default |
| | 1 | Choose DMA1 | |
| If [Parallel Port Mode] is set to [EPP] or [ECP/EPP] mode | | | |
| EPP Mode Select | EPP1.7 | Select the correct EPP operating mode of your on-board parallel port. (This setting should match your parallel device requirements.) | Default |
| | EPP1.9 | | |

3-8.8 MULTI I/O ADDRESSES

Default settings for multi-I/O addresses are as follows:

| Port | I/O Address | IRQ | Status |
|------|-------------|-----|--------|
| LPT1 | 378 | 7 | SPP |
| COM1 | 3F8 | 4 | |
| COM2 | 2F8 | 3 | |



Warning: If a default I/O address conflicts with other I/O cards such as sound card, you must change one of the I/O addresses to remedy to this address conflict. (I/O addresses can be adjusted from the BIOS Setup Utility)

3-9 SUPERVISOR PASSWORD

Based on the setting you have made in the [Security Option] of the [BIOS FEATURES SETUP] section, the password prevents access to the system or the setup program by unauthorized users. Follow this procedure to set a new password or disable the password:

1. Choose [BIOS FEATURES SETUP] in the Main Menu and press [Enter]. Select the [Security Options] item and set the field to:
 - a. [System]: The password is required every time the system is booted. This means only a person who knows the password can use this computer.
 - b. [Setup]: The password is required only when you attempt to enter the BIOS Setup program.
2. Choose [SUPERVISOR PASSWORD] from the Main Menu and press [Enter]. The following prompt appear:

Enter Password:



Warning: If you forget or lose the password, the only way to access the system is to set jumper JP5 to clear the CMOS RAM. All setup information is lost and you must run the BIOS setup program again.



Note: If you do not wish to use the password function, press [Enter] directly and the following message appears:

Password Disabled!!

- 3. Enter your new password and press [Enter]. The following message appears, prompting to confirm the new password:

Confirm Password:

- 4. Re-enter your password and then press [Enter] to exit to the Main Menu.

This diagram outlines the password selection procedure:

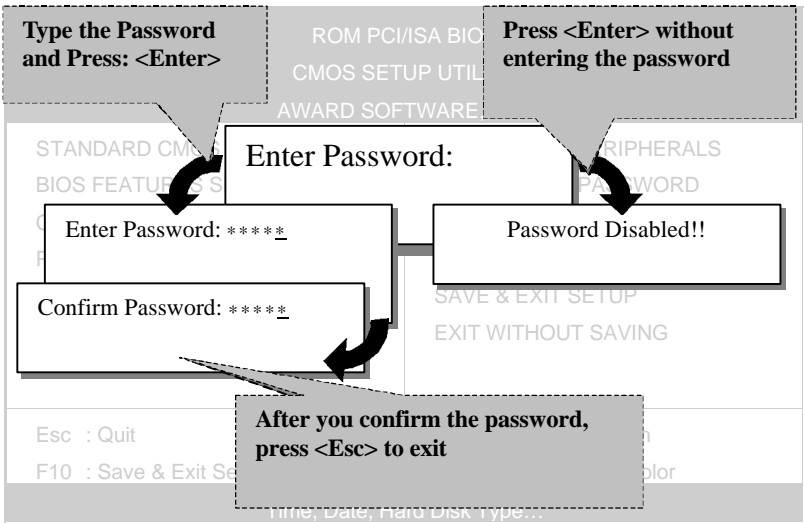

3-10 USER PASSWORD

When the user password option is on, you are not allowed to change any setting in the [CMOS SETUP UTILITY] except for changing the user's password.

The password setting procedure is similar to that for the [SUPERVISOR PASSWORD] (Refer to section 3-9).

3-11 IDE HDD AUTO DETECTION

This Main Menu function automatically detects the hard disk type and configures the STANDARD CMOS SETUP accordingly.

**ROM PCI/ISA BIOS
CMOS SETUP UTILITY
AWARD SOFTWARE, INC.**

| HARD DISKS | TYPE | SIZE | CYLS | HEAD | PRECOMP | LANDZ | SECTOR | MODE |
|---|------|------|------|---------|---------|--------|--------|------|
| Primary Master : | | | | | | | | |
| Select Primary Master Option (N=Skip) : N | | | | | | | | |
| OPTIONS | SIZE | CYLS | HEAD | PRECOMP | LANDZ | SECTOR | MODE | |
| 2(Y) | 1707 | 827 | 64 | 0 | 3308 | 63 | LBA | |
| 1 | 1707 | 3309 | 16 | 65535 | 3308 | 63 | NORMAL | |
| 3 | 1707 | 827 | 64 | 65535 | 3308 | 63 | LARGE | |

Note: Some Oses(SCO-UNIX Before v5.0) must use "NORMAL" for installation

ESC : Skip



Note: This function is only valid for IDE type of hard disk drives.

Chapter 4

DRIVERS INSTALLATION

Your SY-D6IBA Motherboard comes with a CD-ROM labeled "SOYO CD." The SOYO CD contains the user's manual file for your new Motherboard, the drivers software available for installation, and a database in HTML format with information on SOYO Motherboards and other products.

The SOYO CD Start Up Program automatically detects which SOYO Motherboard you own and displays the corresponding model name.

Step 1. Insert the SOYO CD into the CD-ROM drive

The SOYO CD will auto-run, and the SOYO CD Start Up Menu will display as shown below.



Step 2. Install Drivers

Click the **Install Drivers** button to display the list of drivers software that can be installed with your Motherboard. The Start Up program displays the drivers available for the particular model of Motherboard you own. We recommend that you only install those drivers.

The following drivers are available for Windows 95

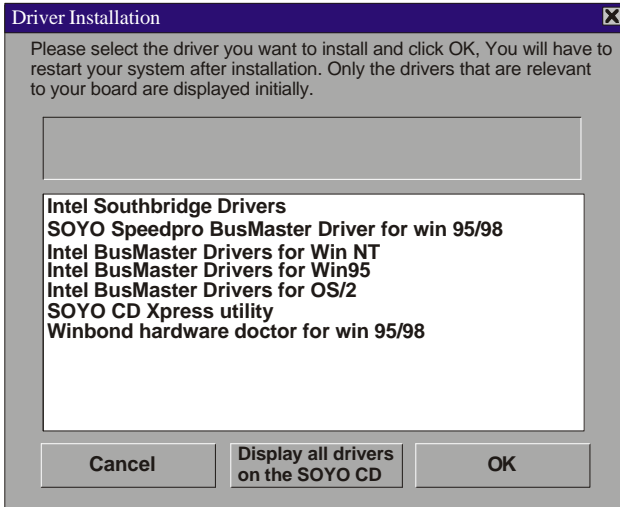

(Driver Installation Menu)

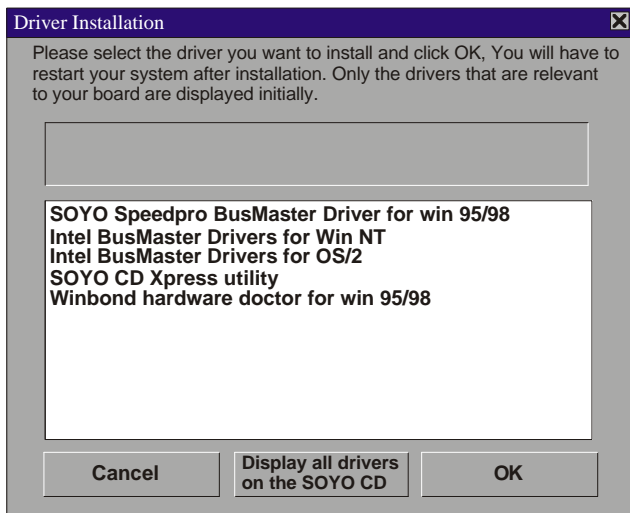
The following drivers are available for Windows 98**(Driver Installation Menu)**

However, to display the list of all drivers software available with SOYO Motherboards, click the **Display all drivers on the SOYO CD** button. Please make sure to install only the drivers adapted to your system, or otherwise this cause system malfunctions.

A short description of all available drivers follows:**➤ Intel Southbridge Drivers**

Because Windows 95 does not recognize the Southbridge of the newer Intel chipsets (TX, BX, ZX etc) this utility has to be run, it will update the necessary Windows files. (Only for Windows 95)

➤ SOYO SpeedPro Busmaster Driver for Win 95/98

Without the busmaster drivers the CPU will need to be involved every time data is read from or written to the Harddisk. The busmaster drivers make use of DMA (Direct Memory Access) to relieve the CPU of this burden, thus speeding up the system.

The SOYO SpeedPro driver makes use of an advanced caching algorithm, which gives it an advantage over other busmaster drivers.

- **Intel Busmaster Drivers for Windows 95**
- **Intel Busmaster Drivers for Win NT**
- **Intel Busmaster Drivers for OS/2**

These are the official busmaster drivers as supplied by Intel.



Note: Do NEVER install two types of busmaster drivers on your system, this will lead to conflicts and system instability. Therefore, if you install the SOYO SpeedPro Busmaster driver you can NOT install the Intel Busmaster drivers. Before installing a new busmaster driver first UNINSTALL the old busmaster driver.

- **SOYO CD Xpress Utility**

This utility will enhance your CD-ROM Drive data-throughput by using space on the Harddisk as cache. This way application programs can access data faster. This utility is suitable for Windows 95/98.

- **Winbond hardware doctor for Windows xx**

Your motherboard comes with a hardware monitoring IC. By installing this utility Temperature, Fan speed and Voltages can be monitored. It is also possible to set alarms when current system values exceed or fall below pre-set values.

This utility comes with a preset monitoring range for the CPU voltage. However, the core voltage of the processor you purchased may fall out of this preset range, so you may need to adjust the pre-set value. Please refer to the SY-D6IBA2 Motherboard's CD manual for the details.

Select which driver you want to install and click **OK**, or click **Cancel** to abort the driver installation and return to the main menu.

Note 1: Once you have selected a driver, the system will automatically exit the SOYO CD to begin the driver installation program. When the installation is complete, most drivers require to restart your system before they can become active.

Note 2: EZ-SCSI Utility: The SCSI utility for use with the onboard Adaptec® SCSI chip is located in the `\drivers\EZ-SCSI` directory. EZ-SCSI is suitable for DOS or Windows 3.1 environment only. The manual file in PDF format can be found at the following location: `Manual\EZ-SCSI.pdf`.

Step 3. Check the Latest Releases

Click the 'Check the latest Releases' button to go the SOYO Website to automatically find the latest BIOS, manual and driver releases for your motherboard. This button will only work if your computer is connected to the internet through a network or modem connection. Make sure to get your modem connection up before clicking this button.

Step 4. Select which driver you want to install and click **OK**

Notice 1: You may click **Cancel** to abort the driver installation and return to the main menu.

Notice 2: Once you have selected a driver, the system will automatically exit the SOYO CD to begin the driver installation program. When the installation is complete, most drivers require you to restart your system before they can become active.

Chapter 5

ULTRA SCSI I/O SUBSYSTEM

Note: For details on how to perform the SCSI driver installation, refer to the “*Adaptec® 7800 Family Manager Set User’s Guide*” included on the *Installation CD-ROM* that comes with your Motherboard. You may also obtain additional SCSI driver information by visiting Adaptec®’s Web site at: <http://www.adaptec.com>

Follow the instructions in Adaptec’s SCSI driver installation guide to install the SCSI driver specific to your system:

- Microsoft Windows NT®
 - Microsoft Windows® 95
 - Novell NetWare
 - IBM OS/2
 - SCO UNIX
 - SCO UnixWare
-

5-1 INTRODUCTION TO ULTRA-SCSI

Your new **SYD6IBA** high-performance Motherboard is equipped with the onboard **Adaptec® AIC-7880 Ultra SCSI host adapter** for your high bandwidth applications, providing data transfer rates of up to 40 Mbytes per second. The Ultra-wide SCSI is an input/output bus interface that provides a powerful multitasking interface between your computer’s PCI bus and your SCSI devices.

With SCSI, you can connect a variety of devices on your computer (Hard/Floppy Disk Drives, CD-ROM Drives, Scanners, Tape Drives, Removable Media Drives, etc.) in a daisy-chain topology to a common host adapter. Daisy-chaining SCSI devices allows them to communicate with each other by sending commands and data via the SCSI bus.

The AIC-7880 Ultra SCSI provides maximum data transfer rates of 20 Mbytes/sec in the narrow 8-bit mode (Fast SCSI) and 40 Mbytes/sec in the wide 16-bit mode (Ultra-Wide SCSI).

5-2 INSTALLING SCSI DEVICES

Your Motherboard features two internal SCSI connectors onboard, and comes with one 50-pin and one 68-pin flat cables.

5-2.1 50-pin Fast SCSI Connector



Narrow SCSI bus allows data transfer rates of up to 20 Mbytes/sec. With Narrow SCSI, you can connect up to 7 internal Fast SCSI devices to the 50-pin Fast SCSI connector on the Motherboard. Use the enclosed Narrow SCSI cable to connect up to 2 internal SCSI devices.

If you are connecting more than 2 internal SCSI devices, you must use an internal SCSI cable with enough connectors to accommodate all your devices. Contact your dealer for special cable service.

When Fast SCSI devices are connected to the bus, the total length of all cables is not to exceed 3 meters (9.8 ft.) to ensure reliable operation.

5-2.2 68-pin Ultra-Wide SCSI Connector

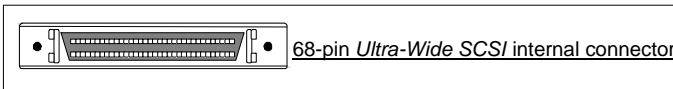

Ultra-Wide SCSI bus allows you to connect up to 15 devices (7 Narrow internal and 8 Wide internal or external SCSI devices, or 15 Wide internal or external SCSI devices) to the 68-pin Ultra-Wide SCSI connector on the Motherboard. Devices that connect to the 16-bit Wide SCSI bus can transfer data at the maximum rate of 40 Mbytes/sec.

5-3 CONNECTING INTERNAL SCSI DEVICES

If you are connecting several internal SCSI devices (more than 2 CD-ROM drives), make sure you have an internal SCSI cable with enough connectors to accommodate all of your devices. The enclosed SCSI flat cables can serve up to 2 CD-ROM drives.

Follow these steps to ensure a proper installation of your internal SCSI devices:

1. Prepare each CD-ROM drive for installation; configure the device **SCSI ID** and terminators (**terminate** the last internal device attached to the cable by setting its termination to the ON position; all other internal devices on the SCSI bus must have their termination set to OFF).
2. Install the CD-ROM drive in your computer.
3. Plug the connector at one end of the internal SCSI cable into the host adapter's SCSI connector on the Motherboard.

Note: Make sure the cable's colored stripe is aligned with pin-1 of the host adapter's connector. Pin-1 of the SCSI connector is usually designated by a small triangle (▲), or a "1" at one corner of the connector.

4. Connect the remaining connectors on the cable to the SCSI devices (CD-ROM drives, etc.).

Note: Make sure the cable's colored stripe is aligned with pin-1 of the SCSI device's connector.

5. Connect a DC power cable (from your computer's power supply) to the power connector on each SCSI device.

5-4 ADAPTEC RAIDPORT™

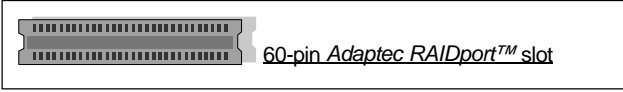

The onboard Adaptec RAIDport™slot is designed to provide embedded SCSI solutions to your Motherboard. To use this RAIDport solutions, plug the *Adaptec ARO™1130 RAIDport™* card into RAIDport slot on the Motherboard.

Adaptec RAIDport™solutions turn embedded SCSI channels into RAID channels, providing data protection and a faster data throughput with striping.

