

GA-870A-UD3

AM3 socket motherboard for
AMD Phenom™ II processor/ AMD Athlon™ II processor

User's Manual

Rev. 3001

12ME-870AU3-3001R

Declaration of Conformity

We, Manufacturer/Importer

G.B.T. Technology Trading GmbH

Bültenkoppl 16, 22647 Hamburg, Germany

declare that the product

(description of the apparatus, system, installation to which it refers)

GA-870A-UD3

is in conformity with

EN 55011

(reference to the specification under which conformity is declared)

in accordance with 2004/108/EC EMC Directive

EN 55011

Limits and methods of measurement of radio disturbance characteristics of household appliances, systems and high frequency equipment

EN 61008-2-2

Disturbances in supply systems caused by household appliances and similar electrical equipment "Voltage fluctuations"

EN 55013

Limits and methods of measurement of radio disturbance characteristics of broadcast receivers and associated equipment

EN 55024

Information Technology equipment/Immunity characteristics-Limits and methods of measurement

EN 55014-1

Limits and methods of measurement of radio disturbance characteristics of portable tools and similar electrical apparatus

EN 50082-1

Generic immunity standard Part 1: Residential, commercial and light industry

EN 50082-2

Generic immunity standard Part 2: Industrial environment

EN 55015

Limits and methods of measurement of radio disturbance characteristics of fluorescent lamps and luminaires

EN 55014-2

Immunity requirements for household appliances tools and similar apparatus

EN 55020

Immunity from radio interference of broadcast receivers and associated equipment

EN 50091-2

EMC requirements for uninterruptible power systems (UPS)

EN 55022

Limits and methods of measurement of radio disturbance characteristics of information technology equipment

DIN VDE 0855
 part 10
 part 15

Cabled distribution systems; Equipment for receiving and/or distribution from serial and television signals

CE marking



(CE conformity marking)

The manufacturer also declares the conformity of above mentioned product with the actual relevant safety standards in accordance with LVD 2006/95/EC

EN 60085

Safety requirements for mains operated electronic and related apparatus for household and similar general use

EN 60950

Safety for information technology equipment including data processing equipment

EN 60335

Safety of household and similar electrical appliances

EN 50091-1

General and Safety requirements for uninterruptible power systems (UPS)

Manufacturer/Importer

Signature: *Timmy Huang*

(Stamp)

Date: Jan. 14, 2011

Name: Timmy Huang

DECLARATION OF CONFORMITY

Per FCC Part 2 Section 2.1077(a)



Responsible Party Name: G.B.T. INC. (U.S.A)

Address: 17358 Railroad Street

City of Industry, CA 91748

Phone/Fax No: (818) 854-9336 / (818) 854-9339

hereby declares that the product

Product Name: **Motherboard**

Model Number: **GA-870A-UD3**

Conforms to the following specifications:

FCC Part 15, Subpart B, Section 15.107(a) and Section 15.109

(a), Class B Digital Device

Supplementary Information:

This device complies with part 15 of the FCC Rules. Operation is subject to the following two conditions: (1) This device may not cause harmful and (2) this device must accept any interference received, including that may cause undesired operation.

Representative Person's Name: ERIC LU

Signature: *Eric Lu*

Date: Jan. 14, 2011

Copyright

© 2011 GIGA-BYTE TECHNOLOGY CO., LTD. All rights reserved.

The trademarks mentioned in this manual are legally registered to their respective owners.

Disclaimer

Information in this manual is protected by copyright laws and is the property of GIGABYTE.

Changes to the specifications and features in this manual may be made by GIGABYTE without prior notice. No part of this manual may be reproduced, copied, translated, transmitted, or published in any form or by any means without GIGABYTE's prior written permission.

Documentation Classifications

In order to assist in the use of this product, GIGABYTE provides the following types of documentations:

- For quick set-up of the product, read the Quick Installation Guide included with the product.
- For detailed product information, carefully read the User's Manual.

For product-related information, check on our website at:

<http://www.gigabyte.com>

Identifying Your Motherboard Revision

The revision number on your motherboard looks like this: "REV: X.X." For example, "REV: 1.0" means the revision of the motherboard is 1.0. Check your motherboard revision before updating motherboard BIOS, drivers, or when looking for technical information.

Example:

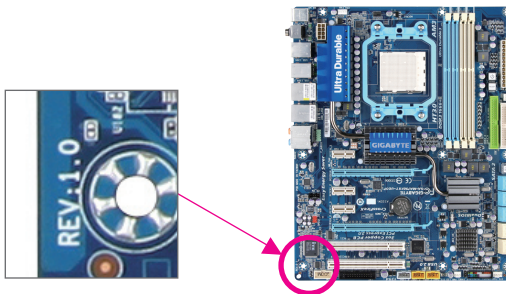

Table of Contents

| | |
|---|----|
| Box Contents | 6 |
| Optional Items | 6 |
| GA-870A-UD3 Motherboard Layout | 7 |
| GA-870A-UD3 Motherboard Block Diagram..... | 8 |
| | |
| Chapter 1 Hardware Installation | 9 |
| 1-1 Installation Precautions | 9 |
| 1-2 Product Specifications..... | 10 |
| 1-3 Installing the CPU and CPU Cooler | 13 |
| 1-3-1 Installing the CPU..... | 13 |
| 1-3-2 Installing the CPU Cooler | 15 |
| 1-4 Installing the Memory | 16 |
| 1-4-1 Dual Channel Memory Configuration | 16 |
| 1-4-2 Installing a Memory | 17 |
| 1-5 Installing an Expansion Card | 18 |
| 1-6 Back Panel Connectors..... | 19 |
| 1-7 Internal Connectors..... | 21 |
| | |
| Chapter 2 BIOS Setup | 33 |
| 2-1 Startup Screen | 34 |
| 2-2 The Main Menu | 35 |
| 2-3 MB Intelligent Tweaker(M.I.T.)..... | 37 |
| 2-4 Standard CMOS Features..... | 41 |
| 2-5 Advanced BIOS Features | 43 |
| 2-6 Integrated Peripherals..... | 45 |
| 2-7 Power Management Setup..... | 49 |
| 2-8 PC Health Status..... | 51 |
| 2-9 Load Fail-Safe Defaults..... | 53 |
| 2-10 Load Optimized Defaults..... | 53 |
| 2-11 Set Supervisor/User Password | 54 |
| 2-12 Save & Exit Setup | 55 |
| 2-13 Exit Without Saving..... | 55 |

| | |
|---|--------|
| Chapter 3 Drivers Installation..... | 57 |
| 3-1 Installing Chipset Drivers | 57 |
| 3-2 Application Software | 58 |
| 3-3 Technical Manuals..... | 58 |
| 3-4 Contact..... | 59 |
| 3-5 System | 59 |
| 3-6 Download Center | 60 |
| 3-7 New Utilities | 60 |
| Chapter 4 Unique Features..... | 61 |
| 4-1 Xpress Recovery2..... | 61 |
| 4-2 BIOS Update Utilities | 64 |
| 4-2-1 Updating the BIOS with the Q-Flash Utility..... | 64 |
| 4-2-2 Updating the BIOS with the @BIOS Utility | 67 |
| 4-3 EasyTune 6 | 68 |
| 4-4 Easy Energy Saver | 69 |
| 4-5 Q-Share..... | 71 |
| 4-6 SMART Recovery..... | 72 |
| 4-7 Auto Green..... | 73 |
| Chapter 5 Appendix..... | 75 |
| 5-1 Configuring SATA Hard Drive(s)..... | 75 |
| 5-1-1 Configuring AMD SB850 SATA Controller | 75 |
| 5-1-2 Configuring GIGABYTE SATA2/JMicron JMB362 SATA Controller..... | 81 |
| 5-1-3 Making a SATA RAID/AHCI Driver Diskette..... | 87 |
| 5-1-4 Installing the SATA RAID/AHCI Driver and Operating System | 89 |
| 5-2 Configuring Audio Input and Output | 98 |
| 5-2-1 Configuring 2/4/5.1/7.1-Channel Audio..... | 98 |
| 5-2-2 Configuring S/PDIF In/Out..... | 100 |
| 5-2-3 Enabling the Dolby Home Theater Function | 102 |
| 5-2-4 Configuring Microphone Recording | 103 |
| 5-2-5 Using the Sound Recorder | 105 |
| 5-3 Troubleshooting..... | 106 |
| 5-3-1 Frequently Asked Questions | 106 |
| 5-3-2 Troubleshooting Procedure | 107 |

Box Contents

- GA-870A-UD3 motherboard
- Motherboard driver disk
- User's Manual
- Quick Installation Guide
- One IDE cable
- Two SATA cables
- I/O Shield

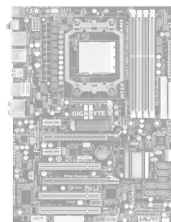

- The box contents above are for reference only and the actual items shall depend on the product package you obtain. The box contents are subject to change without notice.
- The motherboard image is for reference only.

Optional Items

- Floppy disk drive cable (Part No. 12CF1-1FD001-7*R)
- 2-port USB 2.0 bracket (Part No. 12CR1-1UB030-5*R)
- 2-port IEEE 1394a bracket (Part No. 12CF1-1IE008-0*R)
- 2-port SATA power cable (Part No. 12CF1-2SERPW-0*R)
- S/PDIF In cable (Part No. 12CR1-1SPDIN-0*R)
- COM port cable (Part No. 12CF1-1CM001-3*R)
- LPT port cable (Part No. 12CF1-1LP001-0*R)

GA-870A-UD3 Motherboard Layout

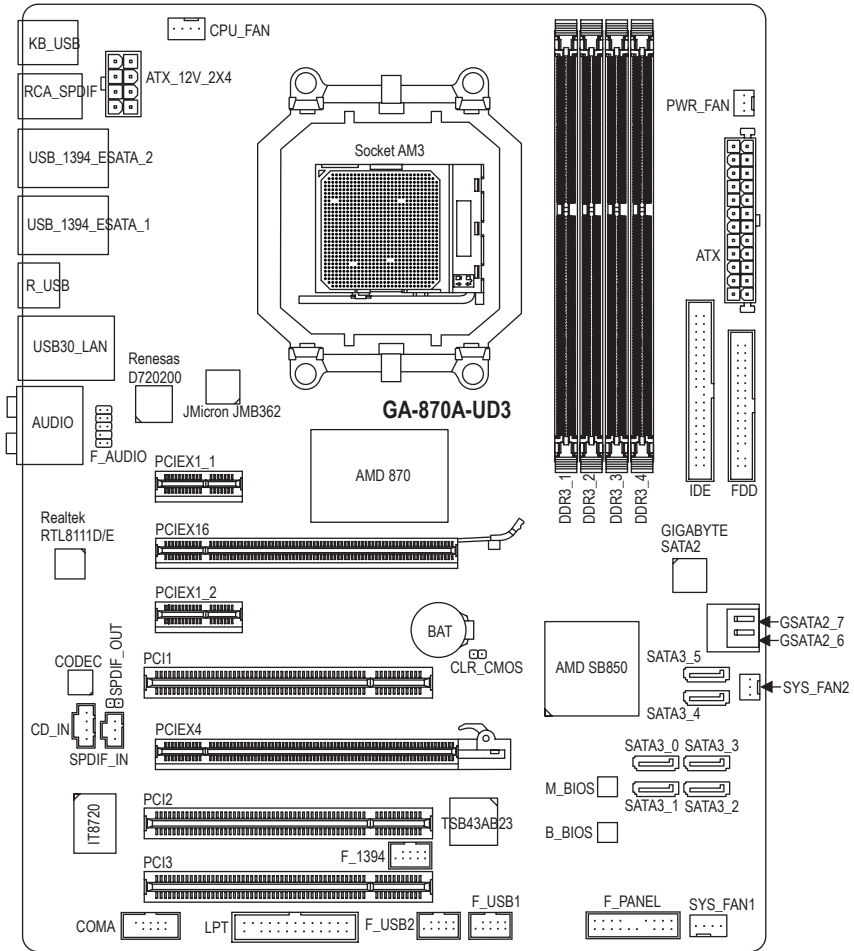

GA-870A-UD3 Motherboard Block Diagram

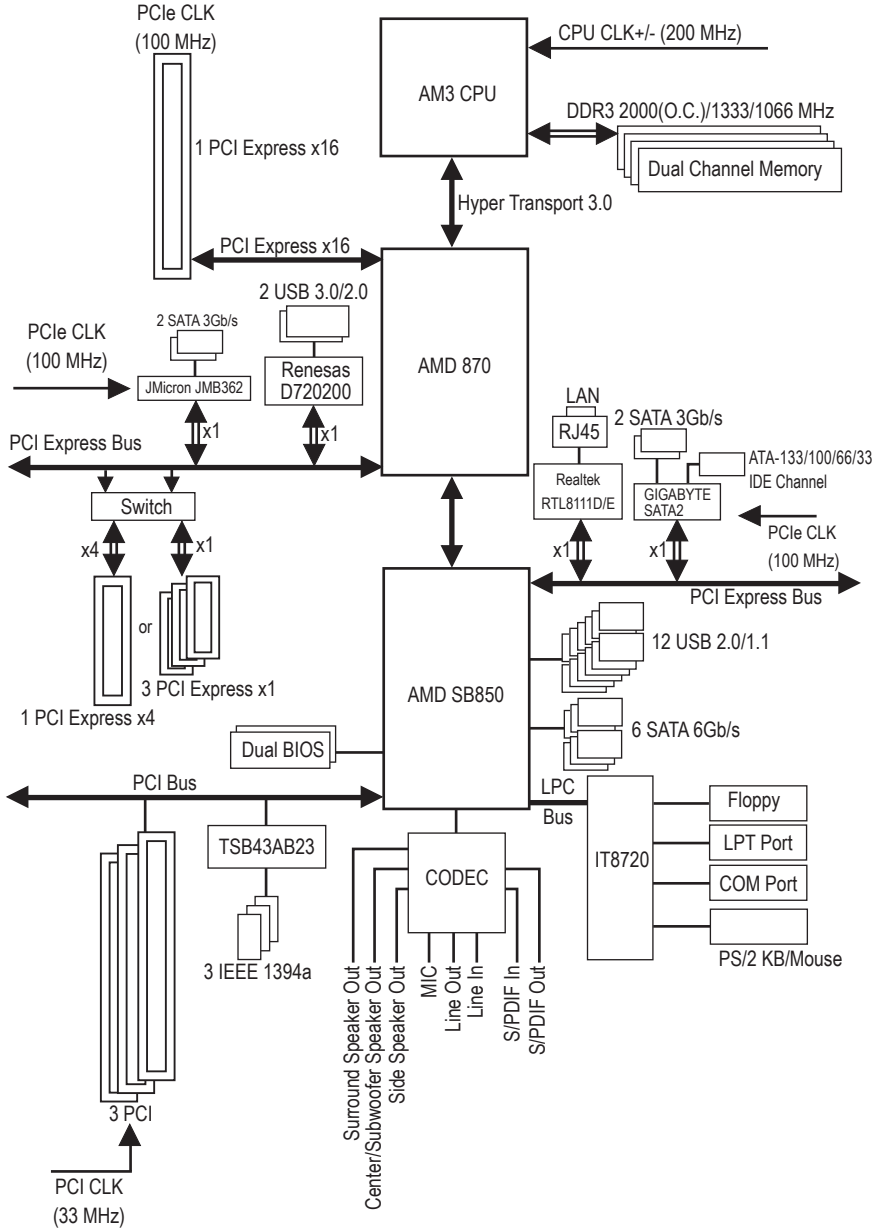









Chapter 1 Hardware Installation







1-1 Installation Precautions





The motherboard contains numerous delicate electronic circuits and components which can become damaged as a result of electrostatic discharge (ESD). Prior to installation, carefully read the user's manual and follow these procedures:

- Prior to installation, do not remove or break motherboard S/N (Serial Number) sticker or warranty sticker provided by your dealer. These stickers are required for warranty validation.
- Always remove the AC power by unplugging the power cord from the power outlet before installing or removing the motherboard or other hardware components.
- When connecting hardware components to the internal connectors on the motherboard, make sure they are connected tightly and securely.
- When handling the motherboard, avoid touching any metal leads or connectors.
- It is best to wear an electrostatic discharge (ESD) wrist strap when handling electronic components such as a motherboard, CPU or memory. If you do not have an ESD wrist strap, keep your hands dry and first touch a metal object to eliminate static electricity.
- Prior to installing the motherboard, please have it on top of an antistatic pad or within an electrostatic shielding container.
- Before unplugging the power supply cable from the motherboard, make sure the power supply has been turned off.
- Before turning on the power, make sure the power supply voltage has been set according to the local voltage standard.
- Before using the product, please verify that all cables and power connectors of your hardware components are connected.
- To prevent damage to the motherboard, do not allow screws to come in contact with the motherboard circuit or its components.
- Make sure there are no leftover screws or metal components placed on the motherboard or within the computer casing.
- Do not place the computer system on an uneven surface.
- Do not place the computer system in a high-temperature environment.
- Turning on the computer power during the installation process can lead to damage to system components as well as physical harm to the user.
- If you are uncertain about any installation steps or have a problem related to the use of the product, please consult a certified computer technician.

1-2 Product Specifications

| | | |
|--|-----------------------|---|
|  | CPU | <ul style="list-style-type: none"> ◆ Support for AM3 processors: AMD Phenom™ II processor/ AMD Athlon™ II processor (Go to GIGABYTE's website for the latest CPU support list.) |
|  | Hyper Transport Bus ◆ | 5200 MT/s |
|  | Chipset | <ul style="list-style-type: none"> ◆ North Bridge: AMD 870 ◆ South Bridge: AMD SB850 |
|  | Memory | <ul style="list-style-type: none"> ◆ 4 x 1.5V DDR3 DIMM sockets supporting up to 16 GB of system memory ^(Note 1) ◆ Dual channel memory architecture ◆ Support for DDR3 2000(O.C.)/1333/1066 MHz memory modules (Go to GIGABYTE's website for the latest supported memory speeds and memory modules.) |
|  | Audio | <ul style="list-style-type: none"> ◆ Realtek ALC892/889 codec ◆ High Definition Audio ◆ 2/4/5.1/7.1-channel ◆ Support for Dolby® Home Theater ◆ Support for S/PDIF In/Out ◆ Support for CD In |
|  | LAN | <ul style="list-style-type: none"> ◆ 1 x Realtek RTL8111D/E chip (10/100/1000 Mbit) |
|  | Expansion Slots | <ul style="list-style-type: none"> ◆ 1 x PCI Express x16 slot, running at x16 (PCIEX16) ◆ 1 x PCI Express x16 slot, running at x4 (PCIEX4) ^(Note 2) ◆ 2 x PCI Express x1 slots (The PCIEX1_1 and PCIEX1_2 slots share bandwidth with the PCIEX4 slot.) ^(Note 2) (All PCI Express slots conform to the PCI Express 2.0) ◆ 3 x PCI slots |
|  | Storage Interface | <ul style="list-style-type: none"> ◆ South Bridge: <ul style="list-style-type: none"> - 6 x SATA 6Gb/s connectors (SATA3_0~SATA3_5) supporting up to 6 SATA 6Gb/s devices - Support for SATA RAID 0, RAID 1, RAID 5, RAID 10, and JBOD ◆ GIGABYTE SATA2 chip: <ul style="list-style-type: none"> - 1 x IDE connector supporting ATA-133/100/66/33 and up to 2 IDE devices - 2 x SATA 3Gb/s connectors (GSATA2_6, GSATA2_7) supporting up to 2 SATA 3Gb/s devices - Support for SATA RAID 0, RAID 1 and JBOD ◆ JMicron JMB362 chip: <ul style="list-style-type: none"> - 2 x eSATA 3Gb/s connectors on the back panel supporting up to 2 SATA 3Gb/s devices - Support for SATA RAID 0, RAID 1, and JBOD ◆ iTE IT8720 chip: <ul style="list-style-type: none"> - 1 x floppy disk drive connector supporting up to 1 floppy disk drive |

| | | |
|---|-----------------------|--|
|  | USB | <ul style="list-style-type: none"> ◆ South Bridge: <ul style="list-style-type: none"> - Up to 12 USB 2.0/1.1 ports (8 on the back panel, 4 via the USB brackets connected to the internal USB headers) ◆ Renesas D720200 chip: <ul style="list-style-type: none"> - Up to 2 USB 3.0/2.0 ports on the back panel |
|  | IEEE 1394 | <ul style="list-style-type: none"> ◆ T.I. TSB43AB23 chip: <ul style="list-style-type: none"> - Up to 3 IEEE 1394a ports (2 on the back panel, 1 via the IEEE 1394a bracket connected to the internal IEEE 1394a header) |
|  | Internal Connectors | <ul style="list-style-type: none"> ◆ 1 x 24-pin ATX main power connector ◆ 1 x 8-pin ATX 12V power connector ◆ 1 x floppy disk drive connector ◆ 1 x IDE connector ◆ 6 x SATA 6Gb/s connectors ◆ 2 x SATA 3Gb/s connectors ◆ 1 x CPU fan header ◆ 2 x system fan headers ◆ 1 x power fan header ◆ 1 x front panel header ◆ 1 x front panel audio header ◆ 1 x CD In connector ◆ 1 x S/PDIF In header ◆ 1 x S/PDIF Out header ◆ 2 x USB 2.0/1.1 headers ◆ 1 x IEEE 1394a header ◆ 1 x serial port header ◆ 1 x parallel port header ◆ 1 x clearing CMOS jumper |
|  | Back Panel Connectors | <ul style="list-style-type: none"> ◆ 1 x PS/2 keyboard/mouse port ◆ 1 x coaxial S/PDIF Out connector ◆ 1 x optical S/PDIF Out connector ◆ 8 x USB 2.0/1.1 ports ◆ 2 x USB 3.0/2.0 ports ◆ 2 x eSATA 3Gb/s ports ◆ 2 x IEEE 1394a ports ◆ 1 x RJ-45 port ◆ 6 x audio jacks (Center/Subwoofer Speaker Out/Rear Speaker Out/Side Speaker Out/Line In/Line Out/Microphone) |
|  | I/O Controller | <ul style="list-style-type: none"> ◆ iTE IT8720 chip |
|  | Hardware Monitor | <ul style="list-style-type: none"> ◆ System voltage detection ◆ CPU/System temperature detection ◆ CPU/system/power fan speed detection ◆ CPU overheating warning ◆ CPU/system/power fan fail warning ◆ CPU/System fan speed control ^(Note 3) |

| | |
|--|--|
|  BIOS | <ul style="list-style-type: none"> ◆ 2 x 8 Mbit/16 Mbit flash ◆ Use of licensed AWARD BIOS ◆ Support for DualBIOS™ ◆ PnP 1.0a, DMI 2.0, SM BIOS 2.4, ACPI 1.0b |
|  Unique Features | <ul style="list-style-type: none"> ◆ Support for @BIOS ◆ Support for Q-Flash ◆ Support for Xpress BIOS Rescue ◆ Support for Download Center ◆ Support for Xpress Install ◆ Support for Xpress Recovery2 ◆ Support for EasyTune ^(Note 4) ◆ Support for Easy Energy Saver ◆ Support for Smart Recovery ◆ Support for Auto Green ◆ Support for ON/OFF Charge ◆ Support for Q-Share |
|  Bundled Software | <ul style="list-style-type: none"> ◆ Norton Internet Security (OEM version) |
|  Operating System | <ul style="list-style-type: none"> ◆ Support for Microsoft® Windows 7/Vista/XP |
|  Form Factor | <ul style="list-style-type: none"> ◆ ATX Form Factor; 30.5cm x 23.0cm |

(Note 1) Due to Windows 32-bit operating system limitation, when more than 4 GB of physical memory is installed, the actual memory size displayed will be less than 4 GB.

(Note 2) The PCIEX1_1 and PCIEX1_2 slots share bandwidth with the PCIEX4 slot. When the PCIEX4 slot is populated with a x4 card, the PCIEX1_1 and PCIEX1_2 slots become unavailable.

(Note 3) Whether the CPU/system fan speed control function is supported will depend on the CPU/system cooler you install.

(Note 4) Available functions in EasyTune may differ by motherboard model.

1-3 Installing the CPU and CPU Cooler



Read the following guidelines before you begin to install the CPU:

- Make sure that the motherboard supports the CPU.
(Go to GIGABYTE's website for the latest CPU support list.)
- Always turn off the computer and unplug the power cord from the power outlet before installing the CPU to prevent hardware damage.
- Locate the pin one of the CPU. The CPU cannot be inserted if oriented incorrectly. (Or you may locate the notches on both sides of the CPU and alignment keys on the CPU socket.)
- Apply an even and thin layer of thermal grease on the surface of the CPU.
- Do not turn on the computer if the CPU cooler is not installed, otherwise overheating and damage of the CPU may occur.
- Set the CPU host frequency in accordance with the CPU specifications. It is not recommended that the system bus frequency be set beyond hardware specifications since it does not meet the standard requirements for the peripherals. If you wish to set the frequency beyond the standard specifications, please do so according to your hardware specifications including the CPU, graphics card, memory, hard drive, etc.

1-3-1 Installing the CPU

- A. Locate the pin one (denoted by a small triangle) of the CPU socket and the CPU.

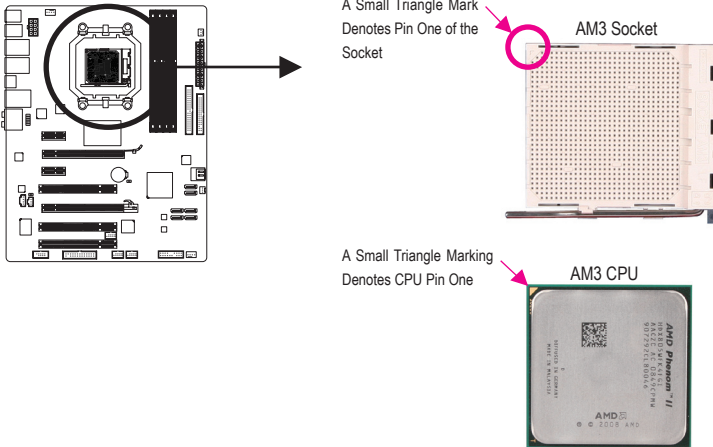

B. Follow the steps below to correctly install the CPU into the motherboard CPU socket.



- Before installing the CPU, make sure to turn off the computer and unplug the power cord from the power outlet to prevent damage to the CPU.
- Do not force the CPU into the CPU socket. The CPU cannot fit in if oriented incorrectly. Adjust the CPU orientation if this occurs.

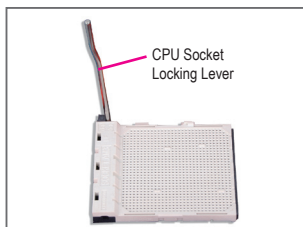

Step 1:

Completely lift up the CPU socket locking lever.

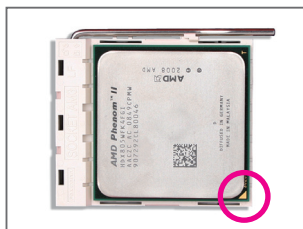

Step 2:

Align the CPU pin one (small triangle marking) with the triangle mark on the CPU socket and gently insert the CPU into the socket. Make sure that the CPU pins fit perfectly into their holes. Once the CPU is positioned into its socket, place one finger down on the middle of the CPU, lowering the locking lever and latching it into the fully locked position.

1-3-2 Installing the CPU Cooler

Follow the steps below to correctly install the CPU cooler on the CPU. (The following procedure uses the GIGABYTE cooler as the example.)

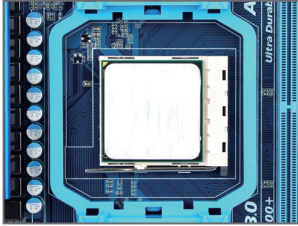

Step 1:
Apply an even and thin layer of thermal grease on the surface of the installed CPU.

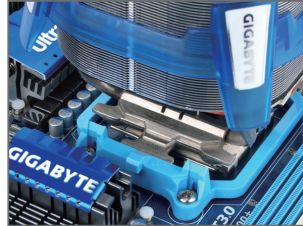

Step 2:
Place the CPU cooler on the CPU.

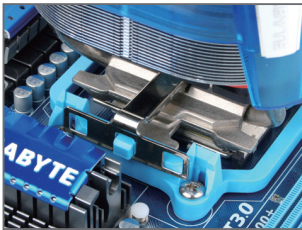

Step 3:
Hook the CPU cooler clip to the mounting lug on one side of the retention frame. On the other side, push straight down on the CPU cooler clip to hook it to the mounting lug on the retention frame.

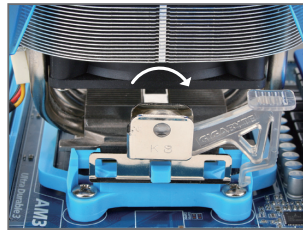

Step 4:
Turn the cam handle from the left side to the right side (as the picture above shows) to lock into place. (Refer to your CPU cooler installation manual for instructions on installing the cooler.)

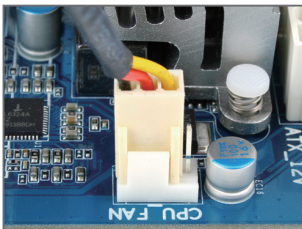

Step 5:
Finally, attach the power connector of the CPU cooler to the CPU fan header (CPU_FAN) on the motherboard.



Use extreme care when removing the CPU cooler because the thermal grease/tape between the CPU cooler and CPU may adhere to the CPU. Inadequately removing the CPU cooler may damage the CPU.

1-4 Installing the Memory



Read the following guidelines before you begin to install the memory:

- Make sure that the motherboard supports the memory. It is recommended that memory of the same capacity, brand, speed, and chips be used.
(Go to GIGABYTE's website for the latest supported memory speeds and memory modules.)
- Always turn off the computer and unplug the power cord from the power outlet before installing the memory to prevent hardware damage.
- Memory modules have a foolproof design. A memory module can be installed in only one direction. If you are unable to insert the memory, switch the direction.

1-4-1 Dual Channel Memory Configuration

This motherboard provides four DDR3 memory sockets and supports Dual Channel Technology. After the memory is installed, the BIOS will automatically detect the specifications and capacity of the memory. Enabling Dual Channel memory mode will double the original memory bandwidth.

The four DDR3 memory sockets are divided into two channels and each channel has two memory sockets as following:

▶▶ Channel 0: DDR3_1, DDR3_2

▶▶ Channel 1: DDR3_3, DDR3_4

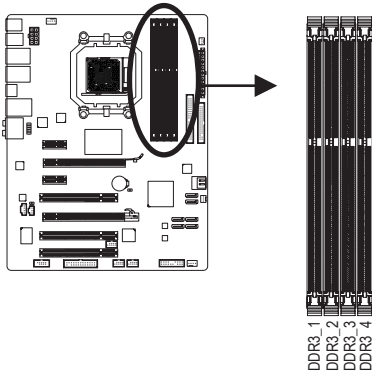

▶▶ Dual Channel Memory Configurations Table

| | DDR3_1 | DDR3_2 | DDR3_3 | DDR3_4 |
|--------------|--------|--------|--------|--------|
| Two Modules | DS/SS | -- | DS/SS | -- |
| | -- | DS/SS | -- | DS/SS |
| Four Modules | DS/SS | DS/SS | DS/SS | DS/SS |

(SS=Single-Sided, DS=Double-Sided, "--=No Memory)

Due to CPU limitations, read the following guidelines before installing the memory in Dual Channel mode.

1. Dual Channel mode cannot be enabled if only one DDR3 memory module is installed.
2. When enabling Dual Channel mode with two or four memory modules, it is recommended that memory of the same capacity, brand, speed, and chips be used and installed in the same colored DDR3 sockets for optimum performance.

1-4-2 Installing a Memory



Before installing a memory module, make sure to turn off the computer and unplug the power cord from the power outlet to prevent damage to the memory module.

DDR3 and DDR2 DIMMs are not compatible to each other or DDR DIMMs. Be sure to install DDR3 DIMMs on this motherboard.

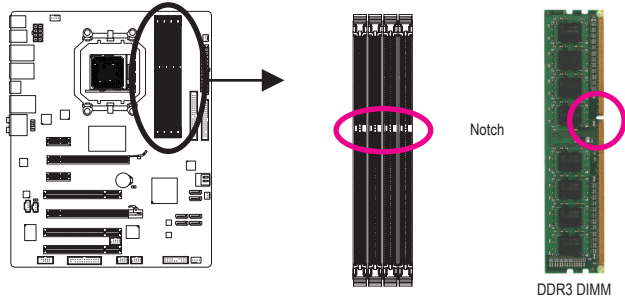

A DDR3 memory module has a notch, so it can only fit in one direction. Follow the steps below to correctly install your memory modules in the memory sockets.

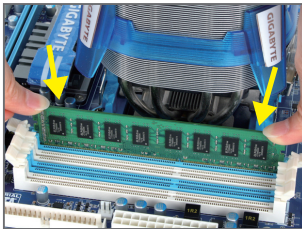

Step 1:

Note the orientation of the memory module. Spread the retaining clips at both ends of the memory socket. Place the memory module on the socket. As indicated in the picture on the left, place your fingers on the top edge of the memory, push down on the memory and insert it vertically into the memory socket.

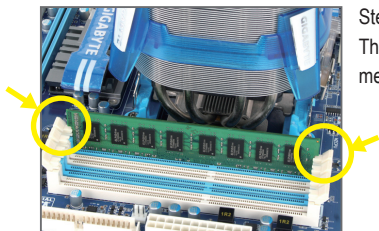

Step 2:

The clips at both ends of the socket will snap into place when the memory module is securely inserted.

1-5 Installing an Expansion Card



Read the following guidelines before you begin to install an expansion card:

- Make sure the motherboard supports the expansion card. Carefully read the manual that came with your expansion card.
- Always turn off the computer and unplug the power cord from the power outlet before installing an expansion card to prevent hardware damage.

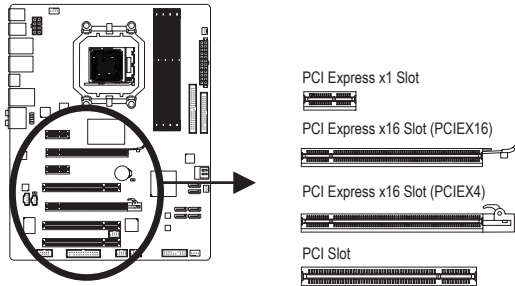

Follow the steps below to correctly install your expansion card in the expansion slot.

1. Locate an expansion slot that supports your card. Remove the metal slot cover from the chassis back panel.
2. Align the card with the slot, and press down on the card until it is fully seated in the slot.
3. Make sure the metal contacts on the card are completely inserted into the slot.
4. Secure the card's metal bracket to the chassis back panel with a screw.
5. After installing all expansion cards, replace the chassis cover(s).
6. Turn on your computer. If necessary, go to BIOS Setup to make any required BIOS changes for your expansion card(s).
7. Install the driver provided with the expansion card in your operating system.

Example: Installing and Removing a PCI Express Graphics Card:



- Installing a Graphics Card:
Gently push down on the top edge of the card until it is fully inserted into the PCI Express slot. Make sure the card is securely seated in the slot and does not rock.

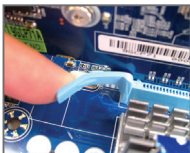

- Removing the Card from the PCIEX16 Slot:
Gently push back on the lever on the slot and then lift the card straight out from the slot.

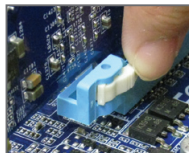

- Removing the Card from the PCIEX4 Slot:
Press the latch at the end of the PCI Express slot to release the card and then pull the card straight up from the slot.

1-6 Back Panel Connectors

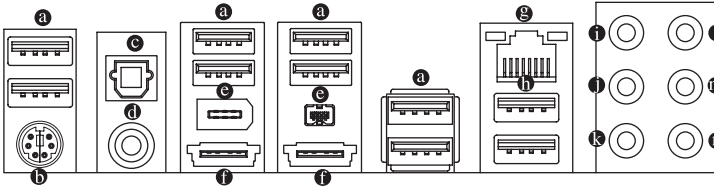

a USB 2.0/1.1 Port

The USB port supports the USB 2.0/1.1 specification. Use this port for USB devices such as a USB keyboard/mouse, USB printer, USB flash drive and etc.

b PS/2 Keyboard or PS/2 Mouse Port

Use this port to connect a PS/2 keyboard or mouse.

c Optical S/PDIF Out Connector

This connector provides digital audio out to an external audio system that supports digital optical audio. Before using this feature, ensure that your audio system provides an optical digital audio in connector.

d Coaxial S/PDIF Out Connector

This connector provides digital audio out to an external audio system that supports digital coaxial audio. Before using this feature, ensure that your audio system provides a coaxial digital audio in connector.

e IEEE 1394a Port

The IEEE 1394 port supports the IEEE 1394a specification, featuring high speed, high bandwidth and hotplug capabilities. Use this port for an IEEE 1394a device.

f eSATA 3Gb/s Port

The eSATA 3Gb/s port conforms to SATA 3Gb/s standard and is compatible with SATA 1.5Gb/s standard. Use the port to connect an external SATA device. Refer to Chapter 5, "Configuring SATA Hard Drive(s)," for instructions on configuring a RAID array.

g RJ-45 LAN Port

The Gigabit Ethernet LAN port provides Internet connection at up to 1 Gbps data rate. The following describes the states of the LAN port LEDs.

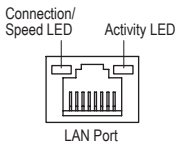

Connection/Speed LED:

| State | Description |
|--------|--------------------|
| Orange | 1 Gbps data rate |
| Green | 100 Mbps data rate |
| Off | 10 Mbps data rate |

Activity LED:

| State | Description |
|----------|--|
| Blinking | Data transmission or receiving is occurring |
| Off | No data transmission or receiving is occurring |



- When removing the cable connected to a back panel connector, first remove the cable from your device and then remove it from the motherboard.
- When removing the cable, pull it straight out from the connector. Do not rock it side to side to prevent an electrical short inside the cable connector.

⑩ **USB 3.0/2.0 Port**

The USB 3.0 port supports the USB 3.0 specification and is compatible to the USB 2.0/1.1 specification. Use this port for USB devices such as a USB keyboard/mouse, USB printer, USB flash drive and etc.

⑪ **Center/Subwoofer Speaker Out Jack (Orange)**

Use this audio jack to connect center/subwoofer speakers in a 5.1/7.1-channel audio configuration.

⑫ **Rear Speaker Out Jack (Black)**

Use this audio jack to connect rear speakers in a 7.1-channel audio configuration.

⑬ **Side Speaker Out Jack (Gray)**

Use this audio jack to connect side speakers in a 4/5.1/7.1-channel audio configuration.

⑭ **Line In Jack (Blue)**

The default line in jack. Use this audio jack for line in devices such as an optical drive, walkman, etc.

⑮ **Line Out Jack (Green)**

The default line out jack. Use this audio jack for a headphone or 2-channel speaker. This jack can be used to connect front speakers in a 4/5.1/7.1-channel audio configuration.

⑯ **Mic In Jack (Pink)**

The default Mic in jack. Microphones must be connected to this jack.



In addition to the default speakers settings, the ⑪ ~ ⑮ audio jacks can be reconfigured to perform different functions via the audio software. Only microphones still **MUST** be connected to the default Mic in jack (⑯). Refer to the instructions on setting up a 2/4/5.1/7.1-channel audio configuration in Chapter 5, "Configuring 2/4/5.1/7.1-Channel Audio."

1-7 Internal Connectors

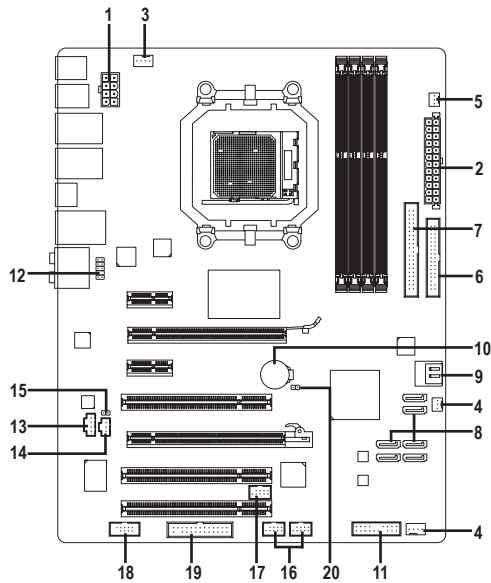

| | | | |
|-----|-------------------|-----|---------------|
| 1) | ATX_12V_2X4 | 11) | F_PANEL |
| 2) | ATX | 12) | F_AUDIO |
| 3) | CPU_FAN | 13) | CD_IN |
| 4) | SYS_FAN1/2 | 14) | SPDIF_IN |
| 5) | PWR_FAN | 15) | SPDIF_OUT |
| 6) | FDD | 16) | F_USB1/F_USB2 |
| 7) | IDE | 17) | F_1394 |
| 8) | SATA3_0/1/2/3/4/5 | 18) | COMA |
| 9) | GSATA2_6/7 | 19) | LPT |
| 10) | BAT | 20) | CLR_CMOS |



Read the following guidelines before connecting external devices:

- First make sure your devices are compliant with the connectors you wish to connect.
- Before installing the devices, be sure to turn off the devices and your computer. Unplug the power cord from the power outlet to prevent damage to the devices.
- After installing the device and before turning on the computer, make sure the device cable has been securely attached to the connector on the motherboard.

1/2) ATX_12V_2X4/ATX (2x4 12V Power Connector and 2x12 Main Power Connector)

With the use of the power connector, the power supply can supply enough stable power to all the components on the motherboard. Before connecting the power connector, first make sure the power supply is turned off and all devices are properly installed. The power connector possesses a foolproof design. Connect the power supply cable to the power connector in the correct orientation. The 12V power connector mainly supplies power to the CPU. If the 12V power connector is not connected, the computer will not start.



To meet expansion requirements, it is recommended that a power supply that can withstand high power consumption be used (500W or greater). If a power supply is used that does not provide the required power, the result can lead to an unstable or unbootable system.

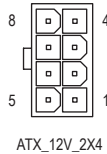
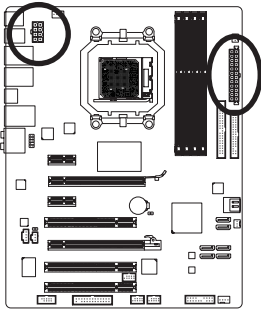

ATX_12V_2X4:

| Pin No. | Definition |
|---------|-----------------------------|
| 1 | GND (Only for 2x4-pin 12V) |
| 2 | GND (Only for 2x4-pin 12V) |
| 3 | GND |
| 4 | GND |
| 5 | +12V (Only for 2x4-pin 12V) |
| 6 | +12V (Only for 2x4-pin 12V) |
| 7 | +12V |
| 8 | +12V |

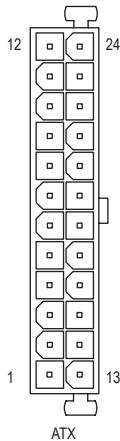

ATX:

| Pin No. | Definition | Pin No. | Definition |
|---------|------------------------------|---------|-----------------------------|
| 1 | 3.3V | 13 | 3.3V |
| 2 | 3.3V | 14 | -12V |
| 3 | GND | 15 | GND |
| 4 | +5V | 16 | PS_ON (soft On/Off) |
| 5 | GND | 17 | GND |
| 6 | +5V | 18 | GND |
| 7 | GND | 19 | GND |
| 8 | Power Good | 20 | -5V |
| 9 | 5VSB (stand by +5V) | 21 | +5V |
| 10 | +12V | 22 | +5V |
| 11 | +12V (Only for 2x12-pin ATX) | 23 | +5V (Only for 2x12-pin ATX) |
| 12 | 3.3V (Only for 2x12-pin ATX) | 24 | GND (Only for 2x12-pin ATX) |

3/4/5) CPU_FAN/SYS_FAN1/SYS_FAN2/PWR_FAN (Fan Headers)

The motherboard has a 4-pin CPU fan header (CPU_FAN), a 4-pin (SYS_FAN1) and a 3-pin (SYS_FAN2) system fan headers, and a 3-pin power fan header (PWR_FAN). Most fan headers possess a foolproof insertion design. When connecting a fan cable, be sure to connect it in the correct orientation (the black connector wire is the ground wire). The motherboard supports CPU fan speed control, which requires the use of a CPU fan with fan speed control design. For optimum heat dissipation, it is recommended that a system fan be installed inside the chassis.

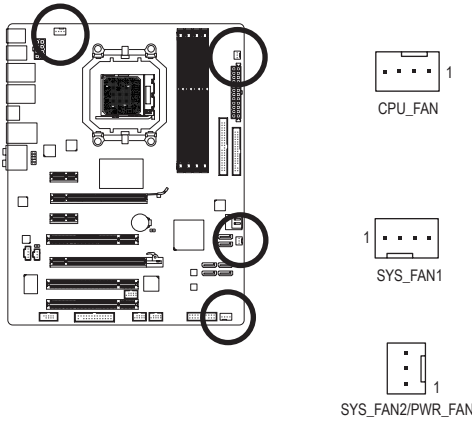

CPU_FAN:

| Pin No. | Definition |
|---------|----------------------|
| 1 | GND |
| 2 | +12V / Speed Control |
| 3 | Sense |
| 4 | Speed Control |

SYS_FAN1:

| Pin No. | Definition |
|---------|----------------------|
| 1 | GND |
| 2 | +12V / Speed Control |
| 3 | Sense |
| 4 | Reserve |

SYS_FAN2/PWR_FAN:

| Pin No. | Definition |
|---------|------------|
| 1 | GND |
| 2 | +12V |
| 3 | Sense |



- Be sure to connect fan cables to the fan headers to prevent your CPU and system from overheating. Overheating may result in damage to the CPU or the system may hang.
- These fan headers are not configuration jumper blocks. Do not place a jumper cap on the headers.

6) FDD (Floppy Disk Drive Connector)

This connector is used to connect a floppy disk drive. The types of floppy disk drives supported are: 360 KB, 720 KB, 1.2 MB, 1.44 MB, and 2.88 MB. Before connecting a floppy disk drive, be sure to locate pin 1 of the connector and the floppy disk drive cable. The pin 1 of the cable is typically designated by a stripe of different color. For purchasing the optional floppy disk drive cable, please contact the local dealer.

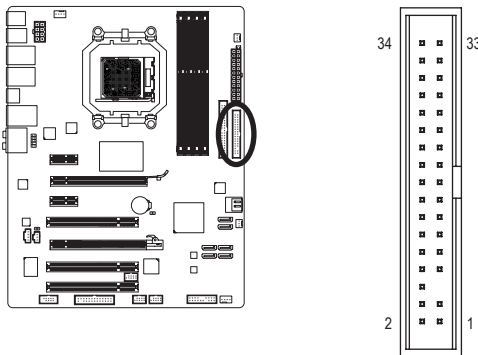

7) IDE (IDE Connector)

The IDE connector supports up to two IDE devices such as hard drives and optical drives. Before attaching the IDE cable, locate the foolproof groove on the connector. If you wish to connect two IDE devices, remember to set the jumpers and the cabling according to the role of the IDE devices (for example, master or slave). (For information about configuring master/slave settings for the IDE devices, read the instructions from the device manufacturers.)

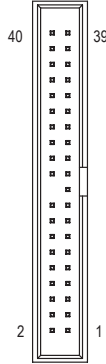
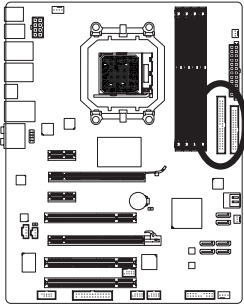

8) SATA3_0/1/2/3/4/5 (SATA 6Gb/s Connectors, Controlled by AMD SB850 South Bridge)

The SATA connectors conform to SATA 6Gb/s standard and are compatible with SATA 3Gb/s and SATA 1.5Gb/s standards. Each SATA connector supports a single SATA device. The AMD SB850 controller supports RAID 0, RAID 1, RAID 5, RAID 10, and JBOD. Refer to Chapter 5, "Configuring SATA Hard Drive(s)," for instructions on configuring a RAID array.

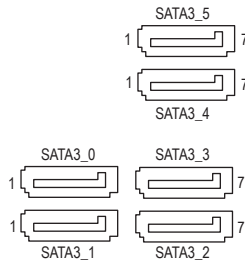
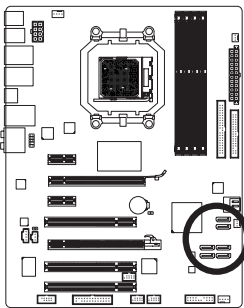

| Pin No. | Definition |
|---------|------------|
| 1 | GND |
| 2 | TXP |
| 3 | TXN |
| 4 | GND |
| 5 | RXN |
| 6 | RXP |
| 7 | GND |

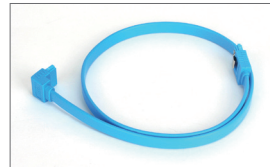

Please connect the L-shaped end of the SATA cable to your SATA hard drive.



- A RAID 0 or RAID 1 configuration requires at least two hard drives. If more than two hard drives are to be used, the total number of hard drives must be an even number.
- A RAID 5 configuration requires at least three hard drives. (The total number of hard drives does not have to be an even number.)
- A RAID 10 configuration requires at least four hard drives and the total number of hard drives must be an even number.

9) GSATA2_6/7 (SATA 3Gb/s Connectors, Controlled by GIGABYTE SATA2)

The SATA connectors conform to SATA 3Gb/s standard and are compatible with SATA 1.5Gb/s standard. Each SATA connector supports a single SATA device. The GIGABYTE SATA2 supports RAID 0 and RAID 1. Refer to Chapter 5, "Configuring SATA Hard Drive(s)," for instructions on configuring a RAID array.

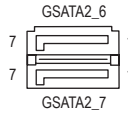
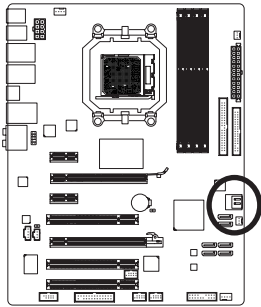

| Pin No. | Definition |
|---------|------------|
| 1 | GND |
| 2 | TXP |
| 3 | TXN |
| 4 | GND |
| 5 | RXN |
| 6 | RXP |
| 7 | GND |

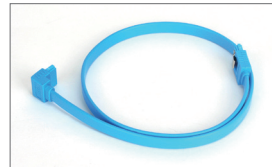

A RAID 0 or RAID 1 configuration requires at least two hard drives.

Please connect the L-shaped end of the SATA cable to your SATA hard drive.

10) BAT (Battery)

The battery provides power to keep the values (such as BIOS configurations, date, and time information) in the CMOS when the computer is turned off. Replace the battery when the battery voltage drops to a low level, or the CMOS values may not be accurate or may be lost.

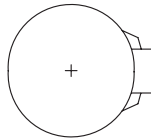
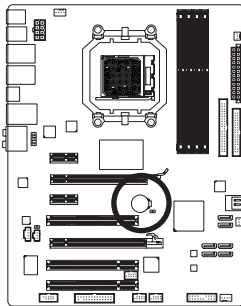

You may clear the CMOS values by removing the battery:

1. Turn off your computer and unplug the power cord.
2. Gently remove the battery from the battery holder and wait for one minute. (Or use a metal object like a screwdriver to touch the positive and negative terminals of the battery holder, making them short for 5 seconds.)
3. Replace the battery.
4. Plug in the power cord and restart your computer.



- Always turn off your computer and unplug the power cord before replacing the battery.
- Replace the battery with an equivalent one. Danger of explosion if the battery is replaced with an incorrect model.
- Contact the place of purchase or local dealer if you are not able to replace the battery by yourself or uncertain about the battery model.
- When installing the battery, note the orientation of the positive side (+) and the negative side (-) of the battery (the positive side should face up).
- Used batteries must be handled in accordance with local environmental regulations.

11) F_PANEL (Front Panel Header)

Connect the power switch, reset switch, speaker, chassis intrusion switch/sensor and system status indicator on the chassis to this header according to the pin assignments below. Note the positive and negative pins before connecting the cables.

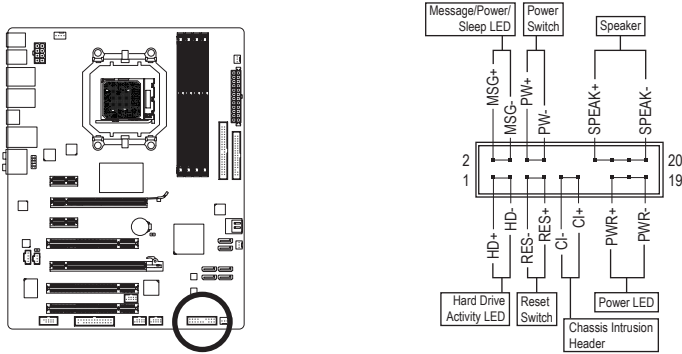

- **MSG/PWR** (Message/Power/Sleep LED, Yellow/Purple):

| System Status | LED |
|---------------|----------|
| S0 | On |
| S1 | Blinking |
| S3/S4/S5 | Off |

Connects to the power status indicator on the chassis front panel. The LED is on when the system is operating. The LED keeps blinking when the system is in S1 sleep state. The LED is off when the system is in S3/S4 sleep state or powered off (S5).

- **PW** (Power Switch, Red):

Connects to the power switch on the chassis front panel. You may configure the way to turn off your system using the power switch (refer to Chapter 2, "BIOS Setup," "Power Management Setup," for more information).

- **SPEAK** (Speaker, Orange):

Connects to the speaker on the chassis front panel. The system reports system startup status by issuing a beep code. One single short beep will be heard if no problem is detected at system startup. If a problem is detected, the BIOS may issue beeps in different patterns to indicate the problem. Refer to Chapter 5, "Troubleshooting," for information about beep codes.

- **HD** (Hard Drive Activity LED, Blue)

Connects to the hard drive activity LED on the chassis front panel. The LED is on when the hard drive is reading or writing data.

- **RES** (Reset Switch, Green):

Connects to the reset switch on the chassis front panel. Press the reset switch to restart the computer if the computer freezes and fails to perform a normal restart.

- **CI** (Chassis Intrusion Header, Gray):

Connects to the chassis intrusion switch/sensor on the chassis that can detect if the chassis cover has been removed. This function requires a chassis with a chassis intrusion switch/sensor.



The front panel design may differ by chassis. A front panel module mainly consists of power switch, reset switch, power LED, hard drive activity LED, speaker and etc. When connecting your chassis front panel module to this header, make sure the wire assignments and the pin assignments are matched correctly.

12) F_AUDIO (Front Panel Audio Header)

The front panel audio header supports Intel High Definition audio (HD) and AC'97 audio. You may connect your chassis front panel audio module to this header. Make sure the wire assignments of the module connector match the pin assignments of the motherboard header. Incorrect connection between the module connector and the motherboard header will make the device unable to work or even damage it.

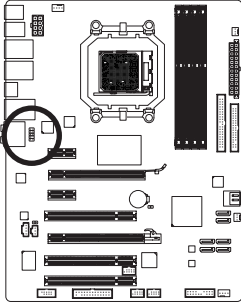

For HD Front Panel Audio:

| Pin No. | Definition |
|---------|------------|
| 1 | MIC2_L |
| 2 | GND |
| 3 | MIC2_R |
| 4 | -ACZ_DET |
| 5 | LINE2_R |
| 6 | GND |
| 7 | FAUDIO_JD |
| 8 | No Pin |
| 9 | LINE2_L |
| 10 | GND |

For AC'97 Front Panel Audio:

| Pin No. | Definition |
|---------|--------------|
| 1 | MIC |
| 2 | GND |
| 3 | MIC Power |
| 4 | NC |
| 5 | Line Out (R) |
| 6 | NC |
| 7 | NC |
| 8 | No Pin |
| 9 | Line Out (L) |
| 10 | NC |



- The front panel audio header supports HD audio by default. If your chassis provides an AC'97 front panel audio module, refer to the instructions on how to activate AC'97 functionality via the audio software in Chapter 5, "Configuring 2/4/5.1/7.1-Channel Audio."
- Audio signals will be present on both of the front and back panel audio connections simultaneously. If you want to mute the back panel audio (only supported when using an HD front panel audio module), refer to Chapter 5, "Configuring 2/4/5.1/7.1-Channel Audio."
- Some chassis provide a front panel audio module that has separated connectors on each wire instead of a single plug. For information about connecting the front panel audio module that has different wire assignments, please contact the chassis manufacturer.

13) CD_IN (CD In Connector)

You may connect the audio cable that came with your optical drive to the header.

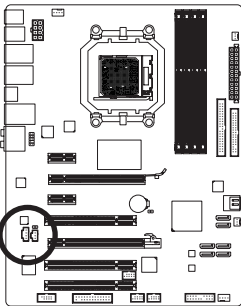

| Pin No. | Definition |
|---------|------------|
| 1 | CD-L |
| 2 | GND |
| 3 | GND |
| 4 | CD-R |

14) SPDIF_IN (S/PDIF In Header)

This header supports digital S/PDIF In and can connect to an audio device that supports digital audio out via an optional S/PDIF In cable. For purchasing the optional S/PDIF In cable, please contact the local dealer.

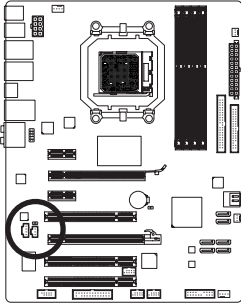

| Pin No. | Definition |
|---------|------------|
| 1 | Power |
| 2 | SPDIFI |
| 3 | GND |

15) SPDIF_OUT (S/PDIF Out Header)

This header supports digital S/PDIF Out and connects a S/PDIF digital audio cable (provided by expansion cards) for digital audio output from your motherboard to certain expansion cards like graphics cards and sound cards. For example, some graphics cards may require you to use a S/PDIF digital audio cable for digital audio output from your motherboard to your graphics card if you wish to connect an HDMI display to the graphics card and have digital audio output from the HDMI display at the same time. For information about connecting the S/PDIF digital audio cable, carefully read the manual for your expansion card.

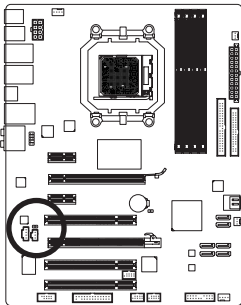

| Pin No. | Definition |
|---------|------------|
| 1 | SPDIFO |
| 2 | GND |

16) F_USB1/F_USB2 (USB Headers)

The headers conform to USB 2.0/1.1 specification. Each USB header can provide two USB ports via an optional USB bracket. For purchasing the optional USB bracket, please contact the local dealer.

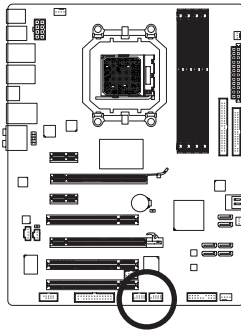

| Pin No. | Definition |
|---------|------------|
| 1 | Power (5V) |
| 2 | Power (5V) |
| 3 | USB DX- |
| 4 | USB DY- |
| 5 | USB DX+ |
| 6 | USB DY+ |
| 7 | GND |
| 8 | GND |
| 9 | No Pin |
| 10 | NC |



When the system is in S4/S5 mode, only the USB ports routed to the F_USB1 header can support the ON/OFF Charge function.



- Do not plug the IEEE 1394 bracket (2x5-pin) cable into the USB header.
- Prior to installing the USB bracket, be sure to turn off your computer and unplug the power cord from the power outlet to prevent damage to the USB bracket.

17) F_1394 (IEEE 1394a Header)

The header conforms to IEEE 1394a specification. The IEEE 1394a header can provide one IEEE 1394a port via an optional IEEE 1394a bracket. For purchasing the optional IEEE 1394a bracket, please contact the local dealer.

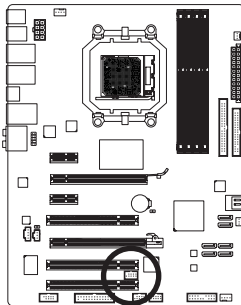

| Pin No. | Definition |
|---------|-------------|
| 1 | TPA+ |
| 2 | TPA- |
| 3 | GND |
| 4 | GND |
| 5 | TPB+ |
| 6 | TPB- |
| 7 | Power (12V) |
| 8 | Power (12V) |
| 9 | No Pin |
| 10 | GND |



- Do not plug the USB bracket cable into the IEEE 1394a header.
- Prior to installing the IEEE 1394a bracket, be sure to turn off your computer and unplug the power cord from the power outlet to prevent damage to the IEEE 1394a bracket.
- To connect an IEEE 1394a device, attach one end of the device cable to your computer and then attach the other end of the cable to the IEEE 1394a device. Ensure that the cable is securely connected.

18) COMA (Serial Port Header)

The COM header can provide one serial port via an optional COM port cable. For purchasing the optional COM port cable, please contact the local dealer.

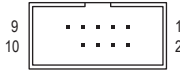
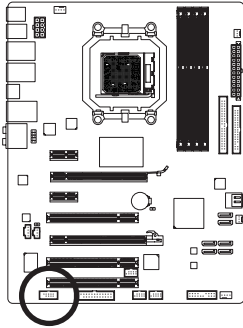

| Pin No. | Definition |
|---------|------------|
| 1 | NDCCD- |
| 2 | NSIN |
| 3 | NSOUT |
| 4 | NDTR- |
| 5 | GND |
| 6 | NDSR- |
| 7 | NRTS- |
| 8 | NCTS- |
| 9 | NRI- |
| 10 | No Pin |

19) LPT (Parallel Port Header)

The LPT header can provide one parallel port via an optional LPT port cable. For purchasing the optional LPT port cable, please contact the local dealer.

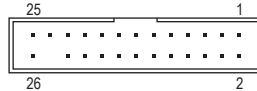
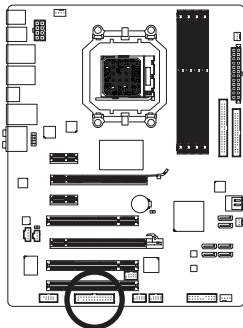

| Pin No. | Definition | Pin No. | Definition |
|---------|------------|---------|------------|
| 1 | STB- | 14 | GND |
| 2 | AFD- | 15 | PD6 |
| 3 | PD0 | 16 | GND |
| 4 | ERR- | 17 | PD7 |
| 5 | PD1 | 18 | GND |
| 6 | INIT- | 19 | ACK- |
| 7 | PD2 | 20 | GND |
| 8 | SLIN- | 21 | BUSY |
| 9 | PD3 | 22 | GND |
| 10 | GND | 23 | PE |
| 11 | PD4 | 24 | No Pin |
| 12 | GND | 25 | SLCT |
| 13 | PD5 | 26 | GND |

20) CLR_CMOS (Clearing CMOS Jumper)

Use this jumper to clear the CMOS values (e.g. date information and BIOS configurations) and reset the CMOS values to factory defaults. To clear the CMOS values, place a jumper cap on the two pins to temporarily short the two pins or use a metal object like a screwdriver to touch the two pins for a few seconds.

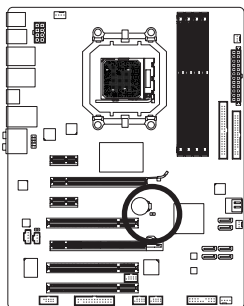

 Open: Normal

 Short: Clear CMOS Values



- Always turn off your computer and unplug the power cord from the power outlet before clearing the CMOS values.
- After clearing the CMOS values and before turning on your computer, be sure to remove the jumper cap from the jumper. Failure to do so may cause damage to the motherboard.
- After system restart, go to BIOS Setup to load factory defaults (select **Load Optimized Defaults**) or manually configure the BIOS settings (refer to Chapter 2, "BIOS Setup," for BIOS configurations).

Chapter 2 BIOS Setup

BIOS (Basic Input and Output System) records hardware parameters of the system in the CMOS on the motherboard. Its major functions include conducting the Power-On Self-Test (POST) during system startup, saving system parameters and loading operating system, etc. BIOS includes a BIOS Setup program that allows the user to modify basic system configuration settings or to activate certain system features. When the power is turned off, the battery on the motherboard supplies the necessary power to the CMOS to keep the configuration values in the CMOS.

To access the BIOS Setup program, press the <Delete> key during the POST when the power is turned on. To see more advanced BIOS Setup menu options, you can press <Ctrl> + <F1> in the main menu of the BIOS Setup program.

To upgrade the BIOS, use either the GIGABYTE Q-Flash or @BIOS utility.

- Q-Flash allows the user to quickly and easily upgrade or back up BIOS without entering the operating system.
- @BIOS is a Windows-based utility that searches and downloads the latest version of BIOS from the Internet and updates the BIOS.

For instructions on using the Q-Flash and @BIOS utilities, refer to Chapter 4, "BIOS Update Utilities."



- Because BIOS flashing is potentially risky, if you do not encounter problems using the current version of BIOS, it is recommended that you not flash the BIOS. To flash the BIOS, do it with caution. Inadequate BIOS flashing may result in system malfunction.
- BIOS will emit a beep code during the POST. Refer to Chapter 5, "Troubleshooting," for the beep codes description.
- It is recommended that you not alter the default settings (unless you need to) to prevent system instability or other unexpected results. Inadequately altering the settings may result in system's failure to boot. If this occurs, try to clear the CMOS values and reset the board to default values. (Refer to the "Load Optimized Defaults" section in this chapter or introductions of the battery/clearing CMOS jumper in Chapter 1 for how to clear the CMOS values.)

2-1 Startup Screen

The following screens may appear when the computer boots.

A. The LOGO Screen (Default)



B. The POST Screen

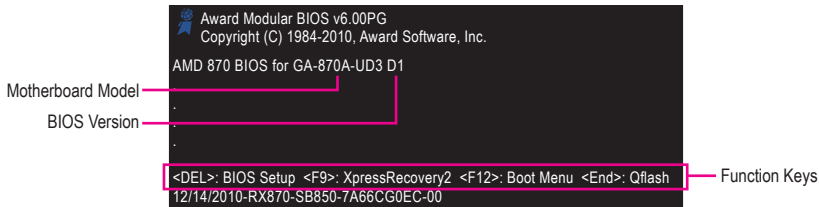

Function Keys:

<TAB>: POST SCREEN

Press the <Tab> key to show the BIOS POST screen. To show the BIOS POST screen at system start-up, refer to the instructions on the **Full Screen LOGO Show** item on page 44.

: BIOS SETUP|Q-FLASH

Press the <Delete> key to enter BIOS Setup or to access the Q-Flash utility in BIOS Setup.

<F9>: XPRESS RECOVERY2

If you have ever entered Xpress Recovery2 to back up hard drive data using the driver disk, the <F9> key can be used for subsequent access to Xpress Recovery2 during the POST. For more information, refer to Chapter 4, "Xpress Recovery2."

<F12>: BOOT MENU

Boot Menu allows you to set the first boot device without entering BIOS Setup. In Boot Menu, use the up arrow key <↑> or the down arrow key <↓> to select the first boot device, then press <Enter> to accept. To exit Boot Menu, press <Esc>. The system will directly boot from the device configured in Boot Menu.

Note: The setting in Boot Menu is effective for one time only. After system restart, the device boot order will still be based on BIOS Setup settings. You can access Boot Menu again to change the first boot device setting as needed.

<END>: Q-FLASH

Press the <End> key to access the Q-Flash utility directly without having to enter BIOS Setup first.

2-2 The Main Menu

Once you enter the BIOS Setup program, the Main Menu (as shown below) appears on the screen. Use arrow keys to move among the items and press <Enter> to accept or enter a sub-menu.

(Sample BIOS Version: D1)

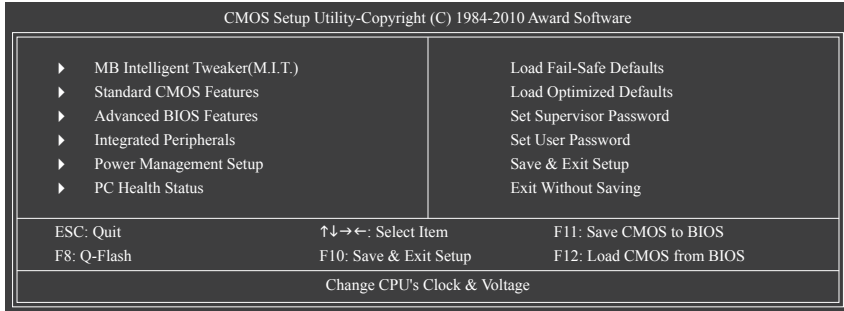

BIOS Setup Program Function Keys

| | |
|--------------|--|
| <↑><↓><←><→> | Move the selection bar to select an item |
| <Enter> | Execute command or enter the submenu |
| <Esc> | Main Menu: Exit the BIOS Setup program Submenus: Exit current submenu |
| <Page Up> | Increase the numeric value or make changes |
| <Page Down> | Decrease the numeric value or make changes |
| <F1> | Show descriptions of the function keys |
| <F2> | Move cursor to the Item Help block on the right (submenus only) |
| <F5> | Restore the previous BIOS settings for the current submenus |
| <F6> | Load the Fail-Safe BIOS default settings for the current submenus |
| <F7> | Load the Optimized BIOS default settings for the current submenus |
| <F8> | Access the Q-Flash utility |
| <F9> | Display system information |
| <F10> | Save all the changes and exit the BIOS Setup program |
| <F11> | Save CMOS to BIOS |
| <F12> | Load CMOS from BIOS |

Main Menu Help

The on-screen description of a highlighted setup option is displayed on the bottom line of the Main Menu.

Submenu Help

While in a submenu, press <F1> to display a help screen (General Help) of function keys available for the menu. Press <Esc> to exit the help screen. Help for each item is in the Item Help block on the right side of the submenu.



- If you do not find the settings you want in the Main Menu or a submenu, press <Ctrl>+<F1> to access more advanced options.
- When the system is not stable as usual, select the **Load Optimized Defaults** item to set your system to its defaults.
- The BIOS Setup menus described in this chapter are for reference only and may differ by BIOS version.

■ The Functions of the <F11> and <F12> keys (For the Main Menu Only)

▶ F11: Save CMOS to BIOS

This function allows you to save the current BIOS settings to a profile. You can create up to 8 profiles (Profile 1-8) and name each profile. First enter the profile name (to erase the default profile name, use the SPACE key) and then press <Enter> to complete.

▶ F12: Load CMOS from BIOS

If your system becomes unstable and you have loaded the BIOS default settings, you can use this function to load the BIOS settings from a profile created before, without the hassles of reconfiguring the BIOS settings. First select the profile you wish to load, then press <Enter> to complete.

■ MB Intelligent Tweaker(M.I.T.)

Use this menu to configure the clock, frequency and voltages of your CPU, memory, etc.

■ Standard CMOS Features

Use this menu to configure the system time and date, hard drive types, floppy disk drive types, and the type of errors that stop the system boot, etc.

■ Advanced BIOS Features

Use this menu to configure the device boot order, advanced features available on the CPU, and the primary display adapter.

■ Integrated Peripherals

Use this menu to configure all peripheral devices, such as IDE, SATA, USB, integrated audio, and integrated LAN, etc.

■ Power Management Setup

Use this menu to configure all the power-saving functions.

■ PC Health Status

Use this menu to see information about autodetected system/CPU temperature, system voltage and fan speed, etc.

■ Load Fail-Safe Defaults

Fail-Safe defaults are factory settings for the most stable, minimal-performance system operations.

■ Load Optimized Defaults

Optimized defaults are factory settings for optimal-performance system operations.

■ Set Supervisor Password

Change, set, or disable password. It allows you to restrict access to the system and BIOS Setup. A supervisor password allows you to make changes in BIOS Setup.

■ Set User Password

Change, set, or disable password. It allows you to restrict access to the system and BIOS Setup. A user password only allows you to view the BIOS settings but not to make changes.

■ Save & Exit Setup

Save all the changes made in the BIOS Setup program to the CMOS and exit BIOS Setup. (Pressing <F10> can also carry out this task.)

■ Exit Without Saving

Abandon all changes and the previous settings remain in effect. Pressing <Y> to the confirmation message will exit BIOS Setup. (Pressing <Esc> can also carry out this task.)

2-3 MB Intelligent Tweaker(M.I.T.)

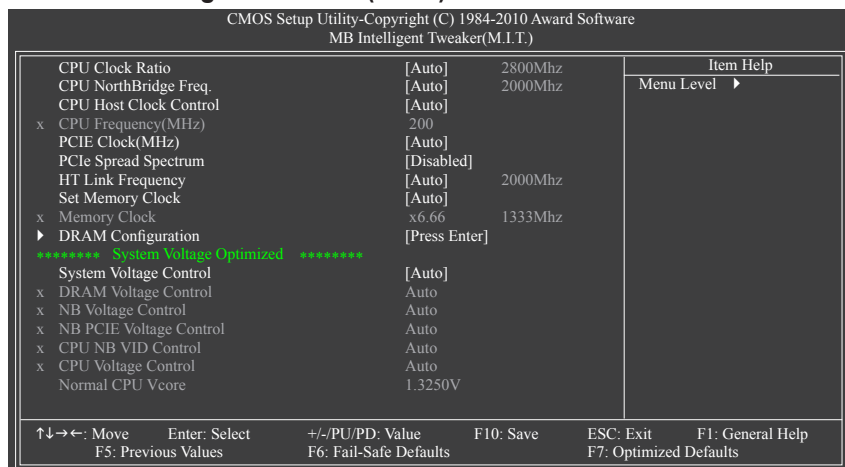

- Whether the system will work stably with the overclock/overvoltage settings you made is dependent on your overall system configurations. Incorrectly doing overclock/overvoltage may result in damage to CPU, chipset, or memory and reduce the useful life of these components. This page is for advanced users only and we recommend you not to alter the default settings to prevent system instability or other unexpected results. (Inadequately altering the settings may result in system's failure to boot. If this occurs, clear the CMOS values and reset the board to default values.)
- When the **System Voltage Optimized** item blinks in red, it is recommended that you set the **System Voltage Control** item to **Auto** to optimize the system voltage settings.

☞ CPU Clock Ratio

Allows you to alter the clock ratio for the installed CPU. The adjustable range is dependent on the CPU being used.

☞ CPU NorthBridge Freq.

Allows you to alter the North Bridge controller frequency for the installed CPU. The adjustable range is dependent on the CPU being used.

☞ CPU Host Clock Control

Enables or disables the control of CPU host clock. **Auto** (default) allows the BIOS to automatically adjust the CPU host frequency. **Manual** allows the **CPU Frequency (MHz)** item below to be configurable.

Note: If your system fails to boot after overclocking, please wait for 20 seconds to allow for automated system reboot, or clear the CMOS values to reset the board to default values.

☞ CPU Frequency(MHz)

Allows you to manually set the CPU host frequency. The adjustable range is from 200 MHz to 500 MHz. This option is configurable only when **CPU Host Clock Control** is set to **Manual**.

Important It is highly recommended that the CPU frequency be set in accordance with the CPU specifications.

☞ PCIE Clock(MHz)

Allows you to manually set the PCIe clock frequency. The adjustable range is from 100 MHz to 150 MHz. **Auto** sets the PCIe clock frequency to standard 100 MHz. (Default: Auto)

☞ PCIe Spread Spectrum

Enables or disables PCIe Spread Spectrum. (Default: Disabled)

☞ HT Link Frequency

Allows you to manually set the frequency for the HT Link between the CPU and chipset.

- ▶▶ Auto BIOS will automatically adjust the HT Link Frequency. (Default)
- ▶▶ x1~x10 Sets HT Link Frequency to x1~x10 (200 MHz~2.0 GHz).

☞ Set Memory Clock

Determines whether to manually set the memory clock. **Auto** lets BIOS automatically set the memory clock as required. **Manual** allows the memory clock control item below to be configurable. (Default: Auto)

☞ Memory Clock

This option is configurable only when **Set Memory Clock** is set to **Manual**.

- ▶▶ X4.00 Sets Memory Clock to X4.00.
- ▶▶ X5.33 Sets Memory Clock to X5.33.
- ▶▶ X6.66 Sets Memory Clock to X6.66.
- ▶▶ X8.00 Sets Memory Clock to X8.00.

☞ DRAM Configuration

CMOS Setup Utility-Copyright (C) 1984-2010 Award Software
DRAM Configuration

| | [Unganged] | SPD | Auto | Item Help |
|---------------------------|------------|------|------|---------------|
| DDR3 Timing Items | [Auto] | | Auto | Menu Level ▶▶ |
| x CAS# latency | Auto | 7T | 7T | |
| x RAS to CAS R/W Delay | Auto | 7T | 7T | |
| x Row Precharge Time | Auto | 7T | 7T | |
| x Minimum RAS Active Time | Auto | 30T | 30T | |
| x 1T/2T Command Timing | Auto | -- | -- | |
| x TwTr Command Delay | Auto | 5T | 5T | |
| x Trfc0 for DIMM1 | Auto | 90ns | 90ns | |
| x Trfc2 for DIMM2 | Auto | -- | -- | |
| x Trfc1 for DIMM3 | Auto | -- | -- | |
| x Trfc3 for DIMM4 | Auto | -- | -- | |
| x Write Recovery Time | Auto | 10T | 10T | |
| x Precharge Time | Auto | 5T | 5T | |
| x Row Cycle Time | Auto | 28T | 28T | |
| x RAS to RAS Delay | Auto | 4T | 4T | |
| Bank interleaving | [Enabled] | | | |
| Channel interleave | [Enabled] | | | |

↑↓→←: Move Enter: Select +/-/PU/PD: Value F10: Save ESC: Exit F1: General Help
 F5: Previous Values F6: Fail-Safe Defaults F7: Optimized Defaults

☞ DCTs Mode

Allows you to set memory control mode.

- ▶▶ Ganged Sets memory control mode to single dual-channel.
- ▶▶ Unganged Sets memory control mode to two single-channel. (Default)

☞ DDR3 Timing Items

Manual allows all DDR3 Timing items below to be configurable.

Options are: Auto (default), Manual.

☞ CAS# latency

Options are: Auto (default), 4T~12T.

- ☞ **RAS to CAS R/W Delay**
Options are: Auto (default), 5T~12T.
- ☞ **Row Precharge Time**
Options are: Auto (default), 5T~12T.
- ☞ **Minimum RAS Active Time**
Options are: Auto (default), 15T~30T.
- ☞ **1T/2T Command Timing**
Options are: Auto (default), 1T, 2T.
- ☞ **TwTr Command Delay**
Options are: Auto (default), 4T~7T.
- ☞ **Trfc0 for DIMM1**
Options are: Auto (default), 90ns, 110ns, 160ns, 300ns, 350ns.
- ☞ **Trfc2 for DIMM2**
Options are: Auto (default), 90ns, 110ns, 160ns, 300ns, 350ns.
- ☞ **Trfc1 for DIMM3**
Options are: Auto (default), 90ns, 110ns, 160ns, 300ns, 350ns.
- ☞ **Trfc3 for DIMM4**
Options are: Auto (default), 90ns, 110ns, 160ns, 300ns, 350ns.
- ☞ **Write Recovery Time**
Options are: Auto (default), 5T~8T, 10T, 12T.
- ☞ **Precharge Time**
Options are: Auto (default), 4T~7T.
- ☞ **Row Cycle Time**
Options are: Auto (default), 11T~42T.
- ☞ **RAS to RAS Delay**
Options are: Auto (default), 4T~7T.
- ☞ **Bank Interleaving**
Enables or disables memory bank interleaving. **Enabled** allows the system to simultaneously access different banks of the memory to increase memory performance and stability. (Default: Enabled)
- ☞ **Channel interleave**
Enables or disables memory channel interleaving. **Enabled** allows the system to simultaneously access different channels of the memory to increase memory performance and stability. (Default: Enabled)

***** System Voltage Optimized *****

☞ **System Voltage Control**

Determines whether to manually set the system voltages. **Auto** lets the BIOS automatically set the system voltages as required. **Manual** allows all voltage control items below to be configurable. (Default: Auto)

☞ **DRAM Voltage Control**

Allows you to set the memory voltage.

▶▶ Normal Supplies the memory voltage as required. (Default)

▶▶ 1.500V ~ 2.400V The adjustable range is from 1.500V to 2.400V.

Note: Increasing memory voltage may result in damage to the memory or reduce the useful life of the memory.

☞ **NB Voltage Control**

Allows you to set the North Bridge voltage.

▶▶ Normal Supplies the North Bridge voltage as required. (Default)

▶▶ 1.100V ~ 1.800V The adjustable range is from 1.100V to 1.800V.

☞ **NB PCIE Voltage Control**

Allows you to set the North Bridge PCIe voltage.

▶▶ Normal Supplies the North Bridge PCIe voltage as required. (Default)

▶▶ 1.800V ~ 2.200V The adjustable range is from 1.800V to 2.200V.

☞ **CPU NB VID Control**

Allows you to set the CPU Northbridge VID voltage. **Auto** sets the CPU Northbridge VID voltage as required. The adjustable range is dependent on the CPU being installed. (Default: Normal)

Note: Increasing CPU voltage may result in damage to your CPU or reduce the useful life of the CPU.

☞ **CPU Voltage Control**

Allows you to set the CPU voltage. **Auto** sets the CPU voltage as required. The adjustable range is dependent on the CPU being installed. (Default: Normal)

Note: Increasing CPU voltage may result in damage to your CPU or reduce the useful life of the CPU.

☞ **Normal CPU Vcore**

Displays the normal operating voltage of your CPU.

2-4 Standard CMOS Features

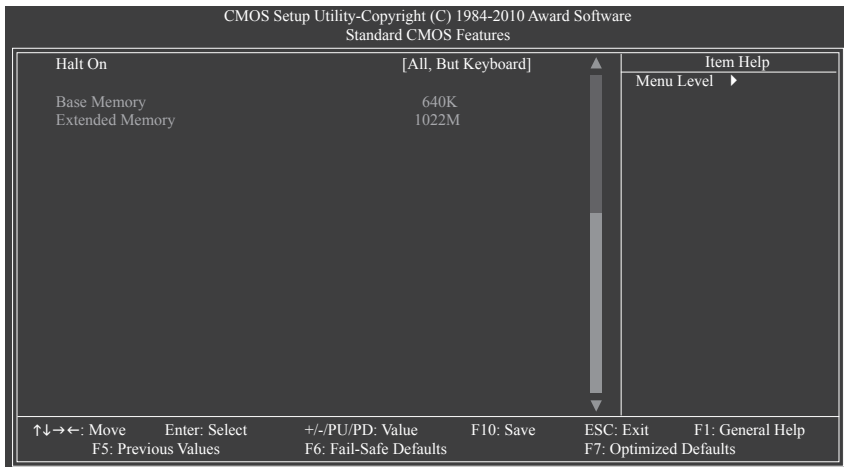
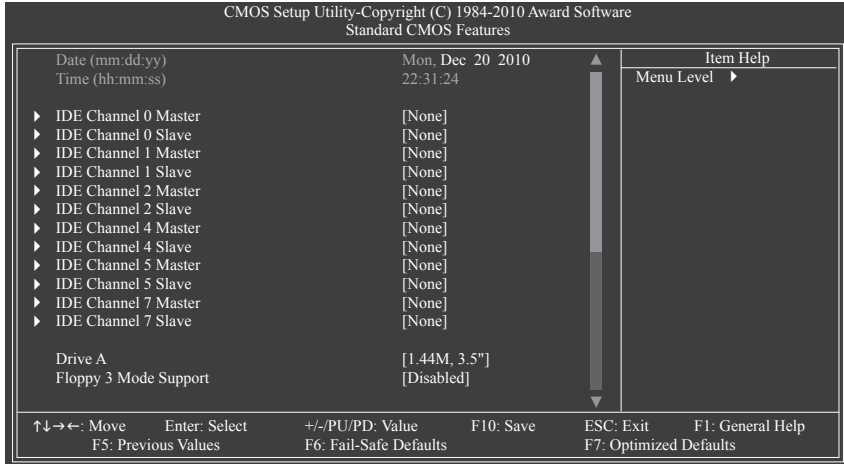

☞ **Date (mm:dd:yy)**

Sets the system date. The date format is week (read-only), month, date and year. Select the desired field and use the up arrow or down arrow key to set the date.

☞ **Time (hh:mm:ss)**

Sets the system time. For example, 1 p.m. is 13:0:0. Select the desired field and use the up arrow or down arrow key to set the time.

☞ **IDE Channel 0, 1 Master/Slave**

▶▶ IDE HDD Auto-Detection

Press <Enter> to autodetect the parameters of the IDE/SATA device on this channel.

▶▶ IDE Channel 0, 1 Master/Slave

Configure your IDE/SATA devices by using one of the two methods below:

- Auto Lets the BIOS automatically detect IDE/SATA devices during the POST. (Default)
- None If no IDE/SATA devices are used, set this item to **None** so the system will skip the detection of the device during the POST for faster system startup.

▶▶ Access Mode Sets the hard drive access mode. Options are: Auto (default), CHS, LBA, Large.

☞ IDE Channel 2, 4, 5, 7 Master/Slave

▶▶ IDE Auto-Detection

Press <Enter> to autodetect the parameters of the IDE/SATA device on this channel.

▶▶ Extended IDE Drive

Configure your IDE/SATA devices by using one of the two methods below:

- Auto Lets the BIOS automatically detect IDE/SATA devices during the POST. (Default)
- None If no IDE/SATA devices are used, set this item to **None** so the system will skip the detection of the device during the POST for faster system startup.

▶▶ Access Mode Sets the hard drive access mode. Options are: Auto (default), Large.

The following fields display your hard drive specifications. If you wish to enter the parameters manually, refer to the information on the hard drive.

- ▶▶ Capacity Approximate capacity of the currently installed hard drive.
- ▶▶ Cylinder Number of cylinders.
- ▶▶ Head Number of heads.
- ▶▶ Precomp Write precompensation cylinder.
- ▶▶ Landing Zone Landing zone.
- ▶▶ Sector Number of sectors.

☞ Drive A

Allows you to select the type of floppy disk drive installed in your system. If you do not install a floppy disk drive, set this item to **None**. Options are: None, 360K/5.25", 1.2M/5.25", 720K/3.5", 1.44M/3.5", 2.88M/3.5".

☞ Floppy 3 Mode Support

Allows you to specify whether the installed floppy disk drive is 3-mode floppy disk drive, a Japanese standard floppy disk drive. Options are: Disabled (default), Drive A.

☞ Halt On

Allows you to determine whether the system will stop for an error during the POST.

- ▶▶ All Errors Whenever the BIOS detects a non-fatal error the system boot will stop.
- ▶▶ No Errors The system boot will not stop for any error.
- ▶▶ All, But Keyboard The system boot will not stop for a keyboard error but stop for all other errors. (Default)
- ▶▶ All, But Diskette The system boot will not stop for a floppy disk drive error but stop for all other errors.
- ▶▶ All, But Disk/Key The system boot will not stop for a keyboard or a floppy disk drive error but it will stop for all other errors.

☞ Memory

These fields are read-only and are determined by the BIOS POST.

- ▶▶ Base Memory Also called conventional memory. Typically, 640 KB will be reserved for the MS-DOS operating system.
- ▶▶ Extended Memory The amount of extended memory.

2-5 Advanced BIOS Features

| CMOS Setup Utility-Copyright (C) 1984-2010 Award Software Advanced BIOS Features | | |
|---|---------------|--------------|
| | | Item Help |
| AMD C1E Support ^(Note) | [Auto] | Menu Level ▶ |
| Virtualization | [Disabled] | |
| AMD K8 Cool&Quiet control | [Auto] | |
| CPU Unlock ^(Note) | [Disabled] | |
| CPU core Control | [Auto] | |
| x CPU core 0 | Enabled | |
| x CPU core 1 | Enabled | |
| x CPU core 2/3/4/5 ^(Note) | Enabled | |
| ▶ Hard Disk Boot Priority | [Press Enter] | |
| First Boot Device | [Hard Disk] | |
| Second Boot Device | [CDROM] | |
| Third Boot Device | [Floppy] | |
| Password Check | [Setup] | |
| HDD S.M.A.R.T. Capability | [Disabled] | |
| Away Mode | [Disabled] | |
| Full Screen LOGO Show | [Enabled] | |
| Backup BIOS Image to HDD | [Disabled] | |
| Init Display First | [PCI Slot] | |

↑↓→←: Move Enter: Select +/-/PU/PD: Value F10: Save ESC: Exit F1: General Help
 F5: Previous Values F6: Fail-Safe Defaults F7: Optimized Defaults

☞ AMD C1E Support ^(Note)

Enables or disables the C1E CPU power-saving function in system halt state. When enabled, the CPU core frequency and voltage will be reduced during system halt state to decrease power consumption. (Default: Auto)

☞ Virtualization

Virtualization allows a platform to run multiple operating systems and applications in independent partitions. With virtualization, one computer system can function as multiple virtual systems. (Default: Disabled)

☞ AMD K8 Cool&Quiet control

- ▶▶ Auto Lets the AMD Cool'n'Quiet driver dynamically adjust the CPU clock and VID to reduce heat output from your computer and its power consumption. (Default)
- ▶▶ Disabled Disables this function.

☞ CPU Unlock ^(Note)

Allows you to determine whether to unlock hidden CPU cores. (Default: Disabled)

☞ CPU core Control

Allows you to determine whether to manually enable/disable CPU Core 1/2/3/4/5.

- ▶▶ Auto Lets the BIOS to enable all CPU cores (number of cores available depends on the CPU being used).
- ▶▶ Manual Allows you to individually enable/disable CPU Core 1/2/3/4/5.

☞ CPU core 0

This setting is fixed. CPU Core 0 is always enabled.

☞ CPU core 1, 2/3/4/5 ^(Note)

Enables or disables CPU Core 1/2/3/4/5. (Default: Enabled)

(Note) This item appears only when you install a CPU that supports this feature.

☞ **Hard Disk Boot Priority**

Specifies the sequence of loading the operating system from the installed hard drives. Use the up or down arrow key to select a hard drive, then press the plus key <+> (or <PageUp>) or the minus key <-> (or <PageDown>) to move it up or down on the list. Press <Esc> to exit this menu when finished.

☞ **First/Second/Third Boot Device**

Specifies the boot order from the available devices. Use the up or down arrow key to select a device and press <Enter> to accept. Options are: Floppy, LS120, Hard Disk, CDROM, ZIP, USB-FDD, USB-ZIP, USB-CDROM, USB-HDD, Legacy LAN, Disabled.

☞ **Password Check**

Specifies whether a password is required every time the system boots, or only when you enter BIOS Setup. After configuring this item, set the password(s) under the **Set Supervisor/User Password** item in the BIOS Main Menu.

- ▶▶ Setup A password is only required for entering the BIOS Setup program. (Default)
- ▶▶ System A password is required for booting the system and for entering the BIOS Setup program.

☞ **HDD S.M.A.R.T. Capability**

Enables or disables the S.M.A.R.T. (Self Monitoring and Reporting Technology) capability of your hard drive. This feature allows your system to report read/write errors of the hard drive and to issue warnings when a third party hardware monitor utility is installed. (Default: Enabled)

☞ **Away Mode**

Enables or disables Away Mode in Windows XP Media Center operating system. Away Mode allows the system to silently perform unattended tasks while in a low-power mode that appears off. (Default: Disabled)

☞ **Full Screen LOGO Show**

Allows you to determine whether to display the GIGABYTE Logo at system startup. **Disabled** displays normal POST message. (Default: Enabled)

☞ **Backup BIOS Image to HDD**

Allows the system to copy the BIOS image file to the hard drive. If the system BIOS is corrupted, it will be recovered from this image file. (Default: Disabled)

☞ **Init Display First**

Specifies the first initiation of the monitor display from the installed PCI graphics card or the PCI Express graphics card.

- ▶▶ PCI Slot Sets the PCI graphics card as the first display. (Default)
- ▶▶ PEG Sets the PCI Express graphics card on the PCIEX16 slot as the first display.
- ▶▶ PEG1 Sets the PCI Express graphics card on the PCIEX4 slot as the first display.

2-6 Integrated Peripherals

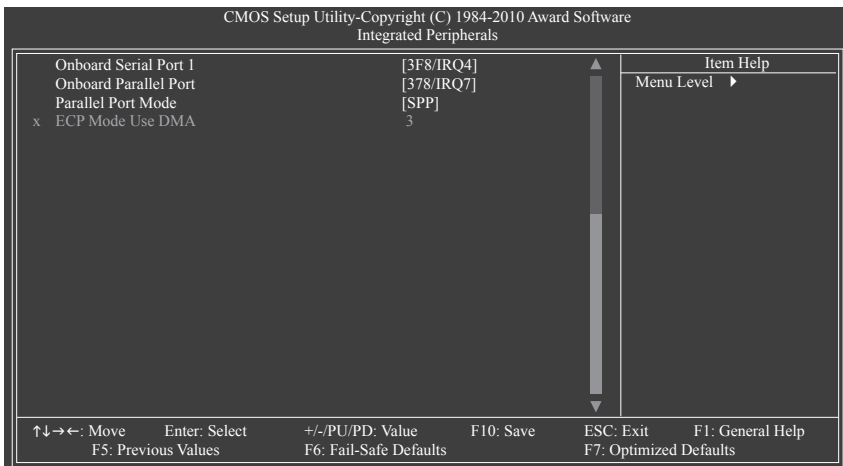
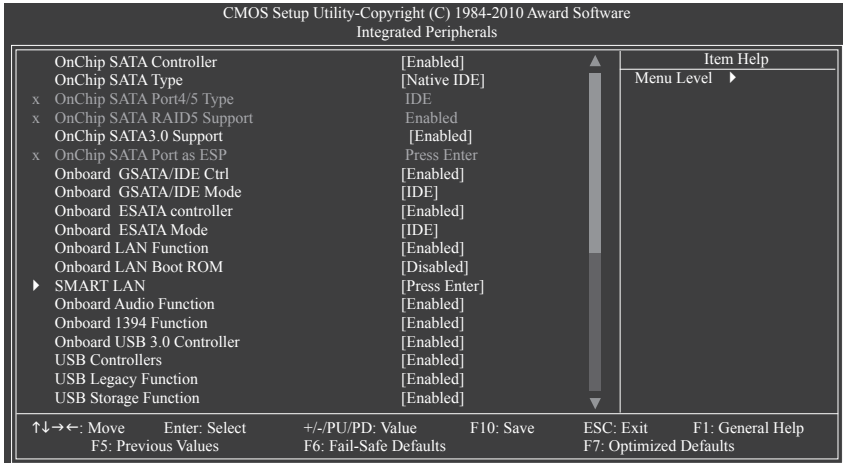

☞ OnChip SATA Controller (AMD SB850 South Bridge)

Enables or disables the SATA controller integrated in the AMD SB850 chip. (Default: Enabled)

☞ OnChip SATA Type (AMD SB850 South Bridge, SATA3_0~SATA3_3 connectors)

Configures the operating mode of the integrated SATA3_0~SATA3_3 controller.

- ▶▶ Native IDE Allows the SATA controller to operate in Native IDE mode. (Default)
Enable Native IDE mode if you wish to install operating systems that support Native mode.
- ▶▶ RAID Enables RAID for the SATA controller.
- ▶▶ AHCI Configures the SATA controllers to AHCI mode. Advanced Host Controller Interface (AHCI) is an interface specification that allows the storage driver to enable advanced Serial ATA features such as Native Command Queuing and hot plug.

- ⊞ **OnChip SATA Port4/5 Type (AMD SB850 South Bridge, SATA3_4~SATA3_5 connectors)**
This option is configurable only when **OnChip SATA Type** is set to **RAID** or **AHCI**. Configures the operating mode of the integrated SATA3_4/SATA3_5 connectors.
 - ▶▶ IDE Disables RAID for the SATA controller and configures the SATA controller to PATA mode. (Default)
 - ▶▶ As SATA Type The mode depends on the **OnChip SATA Type** settings.
- ⊞ **OnChip SATA RAID5 Support (AMD SB850 South Bridge, SATA3_0~SATA3_5 connectors)**
Enables or disables RAID 5 support for the SATA controller integrated in the AMD SB850 South Bridge. This option is configurable only when **OnChip SATA Type** is set to **RAID**.
- ⊞ **OnChip SATA3.0 Support**
Enables or disables the SATA 6Gb/s function integrated in the Chipset. When set to **Disabled**, the SATA controller will operate in SATA 3Gb/s mode. (Default: Enabled)

▶ OnChip SATA Port as ESP

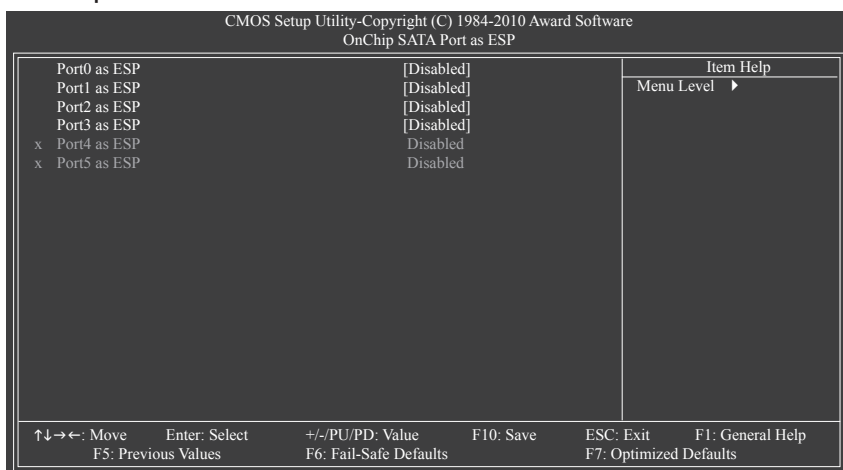

- ⊞ **Port0 as ESP/Port1 as ESP/Port2 as ESP/Port3 as ESP**
This option is configurable only when **OnChip SATA Type** is set to **AHCI**. **Enabled** will speed up the hot plug detection of the connected SATA device. (Default: Disabled)
- ⊞ **Port4 as ESP/Port5 as ESP**
This option is configurable only when **OnChip SATA Type** is set to **AHCI** and **OnChip SATA Type Port4/5** is set to **as SATA Type**. **Enabled** will speed up the hot plug detection of the connected SATA device. (Default: Disabled)
- ⊞ **Onboard GSATA/IDE Ctrl (GIGABYTE SATA2 Chip, GSATA2_6/7 Connectors)**
Enables or disables the SATA controller integrated in the GIGABYTE SATA2 chip. (Default: Enabled)
- ⊞ **Onboard GSATA/IDE Mode (GIGABYTE SATA2 Chip, GSATA2_6/7 Connectors)**
Allows you to decide whether to configure the SATA controller integrated in the GIGABYTE SATA2 chip to AHCI mode.
 - ▶▶ IDE Configures the SATA controller to IDE mode. (Default)
 - ▶▶ AHCI Configures the SATA controller to AHCI mode. Advanced Host Controller Interface (AHCI) is an interface specification that allows the storage driver to enable advanced Serial ATA features such as Native Command Queuing and hot plug.
 - ▶▶ RAID/IDE Enables RAID for the SATA controller; the IDE controller still operates in IDE mode.

- ⊞ **Onboard ESATA controller (JMicron JMB362 Chip, eSATA Connectors on the Back Panel)**
Enables or disables the SATA controller integrated in the JMicron JMB362 chip. (Default: Enabled)
- ⊞ **Onboard ESATA Mode (JMicron JMB362 Chip, eSATA Connectors on the Back Panel)**
Enables or disables RAID for the SATA controller integrated in the JMicron JMB362 chip or configures the SATA controller to AHCI mode.
 - ▶▶ IDE Disables RAID for the SATA controller and configures the SATA controller to IDE mode. (Default)
 - ▶▶ AHCI Configures the SATA controller to AHCI mode. Advanced Host Controller Interface (AHCI) is an interface specification that allows the storage driver to enable advanced Serial ATA features such as Native Command Queuing and hot plug.
 - ▶▶ RAID Enables RAID for the SATA controller.
- ⊞ **Onboard LAN Function**
Enables or disables the onboard LAN function. (Default: Enabled)
If you wish to install a 3rd party add-in network card instead of using the onboard LAN, set this item to **Disabled**.
- ⊞ **Onboard LAN Boot ROM**
Allows you to decide whether to activate the boot ROM integrated with the onboard LAN chip. (Default: Disabled)
- ⊞ **SMART LAN (LAN Cable Diagnostic Function)**

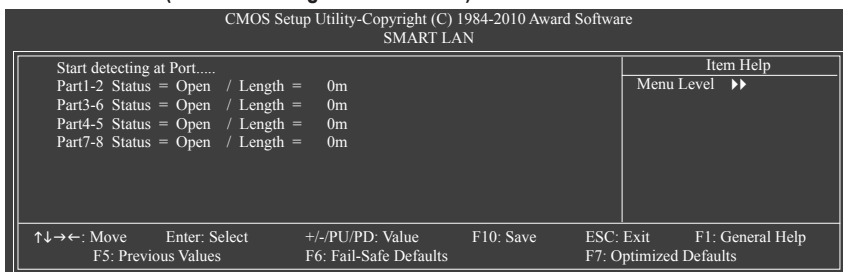

This motherboard incorporates cable diagnostic feature designed to detect the status of the attached LAN cable. This feature will detect cabling issue and report the approximate distance to the fault or short. Refer to the following information for diagnosing your LAN cable:

- ⊞ **When No LAN Cable Is Attached...**
If no LAN cable is attached to the motherboard, the **Status** fields of all four pairs of wires will show **Open** and the **Length** fields show **0m**, as shown in the figure above.
- ⊞ **When LAN Cable Is Functioning Normally...**
If no cable problem is detected on the LAN cable connected to a Gigabit hub or a 10/100 Mbps hub, the following message will appear:

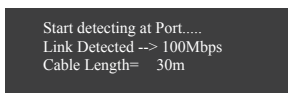

- ▶▶ **Link Detected** Displays transmission speed.
 - ▶▶ **Cable Length** Displays the approximate length of the attached LAN cable.
- Note: The Gigabit hub will only operate at a speed of 10/100 Mbps in MS-DOS mode; it will operate at a normal speed of 10/100/1000 Mbps in Windows mode or when the LAN Boot ROM is activated.

☞ **When a Cable Problem Occurs...**

If a cable problem occurs on a specified pair of wires, the **Status** field will show **Short** and then length shown will be the approximate distance to the fault or short.

Example: Part1-2 Status = Short / Length = 2m

Explanation: A fault or short might occur at about 2m on Part 1-2.

Note: Part 4-5 and Part 7-8 are not used in a 10/100 Mbps environment, so their **Status** fields will show **Open**, and the length shown is the approximate length of the attached LAN cable.

☞ **Onboard Audio Function**

Enables or disables the onboard audio function. (Default: Enabled)

If you wish to install a 3rd party add-in audio card instead of using the onboard audio, set this item to **Disabled**.

☞ **Onboard 1394 Function**

Enables or disables the onboard IEEE 1394 function. (Default: Enabled)

☞ **Onboard USB 3.0 Controller (Renesas D720200 USB Controller)**

Enables or disables the Renesas D720200 USB controller. (Default: Enabled)

☞ **USB Controllers**

Enables or disables the integrated USB controllers. (Default: Enabled)

Disabled will turn off all of the USB functionalities below.

☞ **USB Legacy Function**

Allows USB keyboard to be used in MS-DOS. (Default: Enabled)

☞ **USB Storage Function**

Determines whether to detect USB storage devices, including USB flash drives and USB hard drives during the POST. (Default: Enabled)

☞ **Onboard Serial Port 1**

Enables or disables the first serial port and specifies its base I/O address and corresponding interrupt. Options are: Auto, 2F8/IRQ3, 3F8/IRQ4(default), 3E8/IRQ4, 2E8/IRQ3, Disabled.

☞ **Onboard Parallel Port**

Enables or disables the onboard parallel port (LPT) and specifies its base I/O address and corresponding interrupt. Options are: 378/IRQ7 (default), 278/IRQ5, 3BC/IRQ7, Disabled.

☞ **Parallel Port Mode**

Selects an operating mode for the onboard parallel (LPT) port. Options are: SPP (Standard Parallel Port) (default), EPP (Enhanced Parallel Port), ECP (Extended Capabilities Port), ECP+EPP.

☞ **ECP Mode Use DMA**

Selects DMA channel for the LPT port in ECP mode. This item is configurable only when **Parallel Port Mode** is set to **ECP** or **ECP+EPP** mode. Options are: 3 (default), 1.

⌵ **HPET Support** ^(Note)

Enables or disables High Precision Event Timer (HPET) for Windows 7/Vista operating system.
(Default: Enabled)

⌵ **Power On By Mouse**

Allows the system to be turned on by a PS/2 mouse wake-up event.

Note: To use this function, you need an ATX power supply providing at least 1A on the +5VSB lead.

- ▶▶ Disabled Disables this function. (Default)
- ▶▶ Double Click Double click on left button on the PS/2 mouse to turn on the system.

⌵ **Power On By Keyboard**

Allows the system to be turned on by a PS/2 keyboard wake-up event.

Note: you need an ATX power supply providing at least 1A on the +5VSB lead.

- ▶▶ Disabled Disables this function. (Default)
- ▶▶ Password Set a password with 1~5 characters to turn on the system.
- ▶▶ Any KEY Press any key on the keyboard to turn on the system.
- ▶▶ Keyboard 98 Press POWER button on the Windows 98 keyboard to turn on the system.

⌵ **KB Power ON Password**

Set the password when **Power On by Keyboard** is set to **Password**. Press <Enter> on this item and set a password with up to 5 characters and then press <Enter> to accept. To turn on the system, enter the password and press <Enter>.

Note: To cancel the password, press <Enter> on this item. When prompted for the password, press <Enter> again without entering the password to clear the password settings.

⌵ **AC Back Function**

Determines the state of the system after the return of power from an AC power loss.

- ▶▶ Soft-Off The system stays off upon the return of the AC power. (Default)
- ▶▶ Full-On The system is turned on upon the return of the AC power.
- ▶▶ Memory The system returns to its last known awake state upon the return of the AC power.

⌵ **Power-On by Alarm**

Determines whether to power on the system at a desired time. (Default: Disabled)

If enabled, set the date and time as following:

- ▶▶ Date (of Month) Alarm: Turn on the system at a specific time on each day or on a specific day in a month.
- ▶▶ Resume Time (hh: mm: ss): Set the time at which the system will be powered on automatically.

Note: When using this function, avoid inadequate shutdown from the operating system or removal of the AC power, or the settings may not be effective.

⌵ **ErP Support**

Determines whether to let the system consume less than 1W power in S5 (shutdown) state. (Default: Disabled)

Note: When this item is set to **Enabled**, the following four functions will become unavailable:

PME event wake up, power on by mouse, power on by keyboard, and wake on LAN.

(Note) Supported on Windows 7/Vista operating system only.

- ⊞ **Current Voltage(V) Vcore/DDR3 1.5V/+3.3V/+12V**

Displays the current system voltages.
- ⊞ **Current System/CPU Temperature**

Displays current system/CPU temperature.
- ⊞ **Current CPU/SYSTEM/POWER FAN Speed (RPM)**

Displays current CPU/system/power fan speed.
- ⊞ **CPU Warning Temperature**

Sets the warning threshold for CPU temperature. When CPU temperature exceeds the threshold, BIOS will emit warning sound. Options are: Disabled (default), 60°C/140°F, 70°C/158°F, 80°C/176°F, 90°C/194°F.
- ⊞ **CPU/SYSTEM/POWER FAN Fail Warning**

Allows the system to emit warning sound if the CPU/system/power fan is not connected or fails. Check the fan condition or fan connection when this occurs. (Default: Disabled)
- ⊞ **CPU Smart FAN Control**

Enables or disables the CPU fan speed control function. **Enabled** allows the CPU fan to run at different speed according to the CPU temperature. You can adjust the fan speed with EasyTune based on system requirements. If disabled, the CPU fan runs at full speed. (Default: Enabled)
- ⊞ **CPU Smart FAN Mode**

Specifies how to control CPU fan speed. This item is configurable only when **CPU Smart FAN Control** is set to **Enabled**.

 - ▶▶ Auto Lets the BIOS automatically detect the type of CPU fan installed and sets the optimal CPU fan control mode. (Default)
 - ▶▶ Voltage Sets Voltage mode for a 3-pin CPU fan.
 - ▶▶ PWM Sets PWM mode for a 4-pin CPU fan.
- ⊞ **System Smart FAN Control**

Enables or disables the system fan speed control function. **Enabled** allows the system fan to run at different speed according to the system temperature. If disabled, system fan runs at full speed. (Default: Enabled)

2-9 Load Fail-Safe Defaults

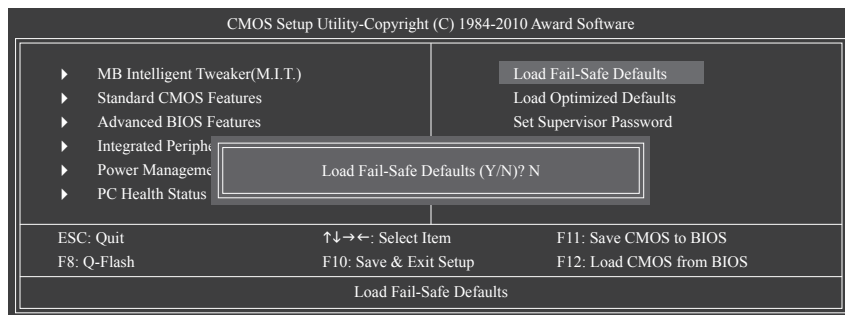

Press <Enter> on this item and then press the <Y> key to load the safest BIOS default settings. In case system instability occurs, you may try to load Fail-Safe defaults, which are the safest and most stable BIOS settings for the motherboard.

2-10 Load Optimized Defaults

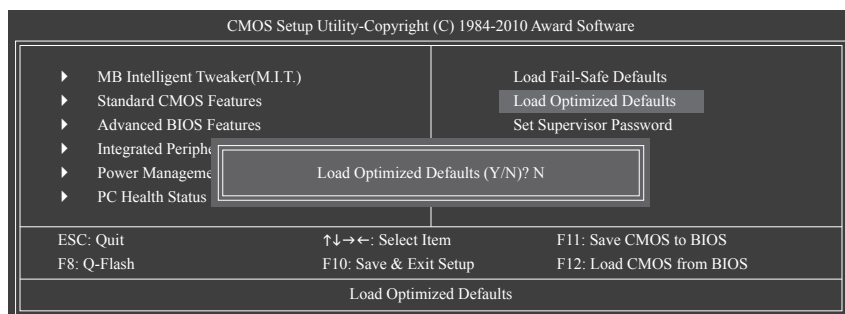

Press <Enter> on this item and then press the <Y> key to load the optimal BIOS default settings. The BIOS defaults settings help the system to operate in optimum state. Always load the Optimized defaults after updating the BIOS or after clearing the CMOS values.

2-11 Set Supervisor/User Password

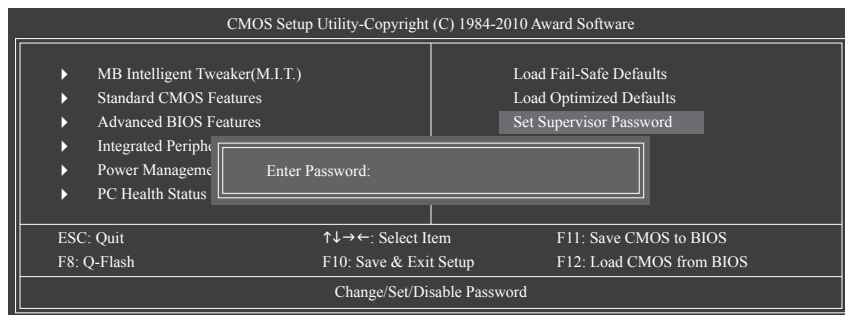

Press <Enter> on this item and type the password with up to 8 characters and then press <Enter>. You will be requested to confirm the password. Type the password again and press <Enter>.

The BIOS Setup program allows you to specify two separate passwords:

🔑 Supervisor Password

When a system password is set and the **Password Check** item in **Advanced BIOS Features** is set to **Setup**, you must enter the supervisor password for entering BIOS Setup and making BIOS changes.

When the **Password Check** item is set to **System**, you must enter the supervisor password (or user password) at system startup and when entering BIOS Setup.

🔑 User Password

When the **Password Check** item is set to **System**, you must enter the supervisor password (or user password) at system startup to continue system boot. In BIOS Setup, you must enter the supervisor password if you wish to make changes to BIOS settings. The user password only allows you to view the BIOS settings but not to make changes.

To clear the password, press <Enter> on the password item and when requested for the password, press <Enter> again. The message "PASSWORD DISABLED" will appear, indicating the password has been cancelled.

2-12 Save & Exit Setup

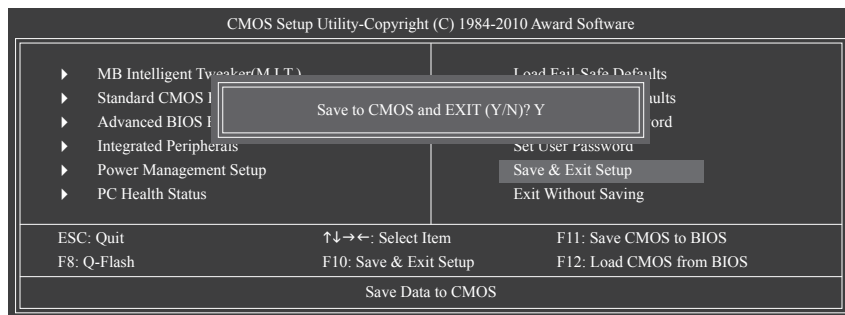

Press <Enter> on this item and press the <Y> key. This saves the changes to the CMOS and exits the BIOS Setup program. Press <N> or <Esc> to return to the BIOS Setup Main Menu.

2-13 Exit Without Saving

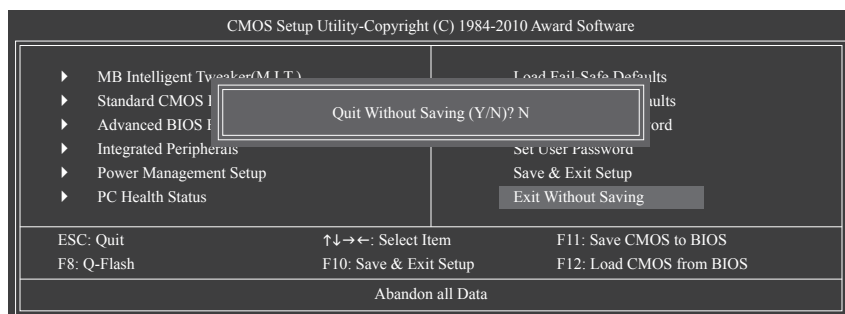

Press <Enter> on this item and press the <Y> key. This exits the BIOS Setup without saving the changes made in BIOS Setup to the CMOS. Press <N> or <Esc> to return to the BIOS Setup Main Menu.

Chapter 3 Drivers Installation



- Before installing the drivers, first install the operating system.
- After installing the operating system, insert the motherboard driver disk into your optical drive. The driver Autorun screen is automatically displayed which looks like that shown in the screen shot below. (If the driver Autorun screen does not appear automatically, go to My Computer, double-click the optical drive and execute the **Run.exe** program.)

3-1 Installing Chipset Drivers



Now Loading Please wait...

After inserting the driver disk, "Xpress Install" will automatically scan your system and then list all the drivers that are recommended to install. You can click the **Install All** button and "Xpress Install" will install all the recommended drivers. Or click **Install Single Items** to manually select the drivers you wish to install.

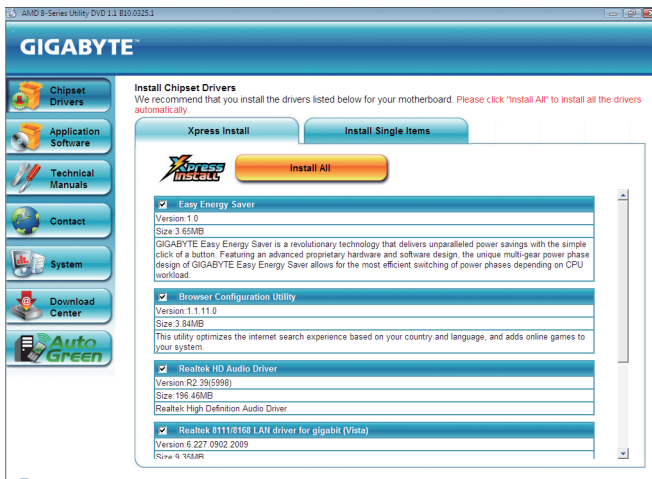

- Please ignore the popup dialog box(es) (e.g. the **Found New Hardware Wizard**) displayed when "Xpress Install" is installing the drivers. Failure to do so may affect the driver installation.
- Some device drivers will restart your system automatically during the driver installation. After the system restart, "Xpress Install" will continue to install other drivers.
- After "Xpress Install" installs all of the drivers, a dialog box will appear asking whether to install new GIGABYTE utilities. Click **Yes** to automatically install the utilities. Or click **No** if you want to manually select the utilities to install on the **Application Software** page later.
- For USB 2.0 driver support under the Windows XP operating system, please install the Windows XP Service Pack 1 or later. After installing the SP1 (or later), if a question mark still exists in **Universal Serial Bus Controller** in **Device Manager**, please remove the question mark (by right-clicking your mouse and select **Uninstall**) and restart the system. (The system will then autodetect and install the USB 2.0 driver.)

3-2 Application Software

This page displays all the utilities and applications that GIGABYTE develops and some free software. You can click the **Install** button on the right of an item to install it.

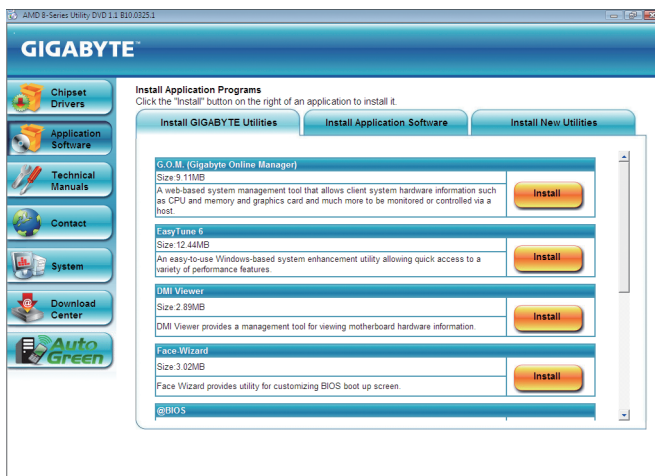

3-3 Technical Manuals

This page provides GIGABYTE's application guides, content descriptions for this driver disk, and the motherboard manuals.

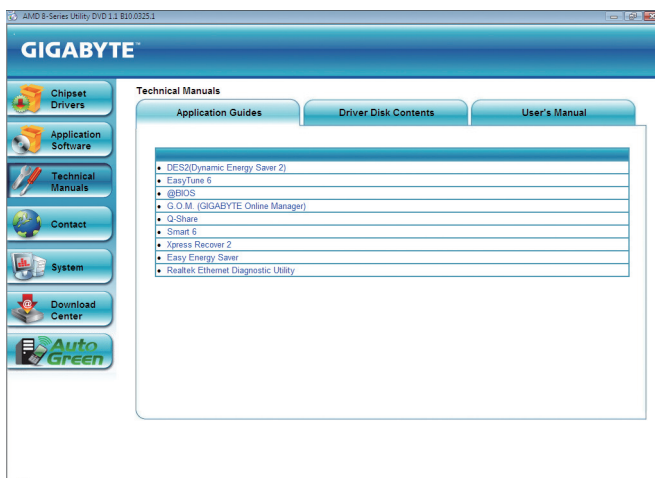

3-4 Contact

For the detailed contact information of the GIGABYTE Taiwan headquarter or worldwide branch offices, click the URL on this page to link to the GIGABYTE website.



3-5 System

This page provides the basic system information.

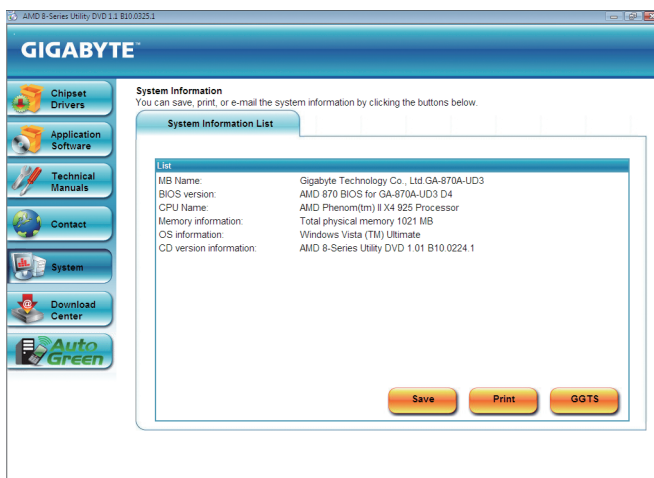

3-6 Download Center

To update the BIOS, drivers, or applications, click the **Download Center** button to link to the GIGABYTE website. The latest version of the BIOS, drivers, or applications will be displayed.

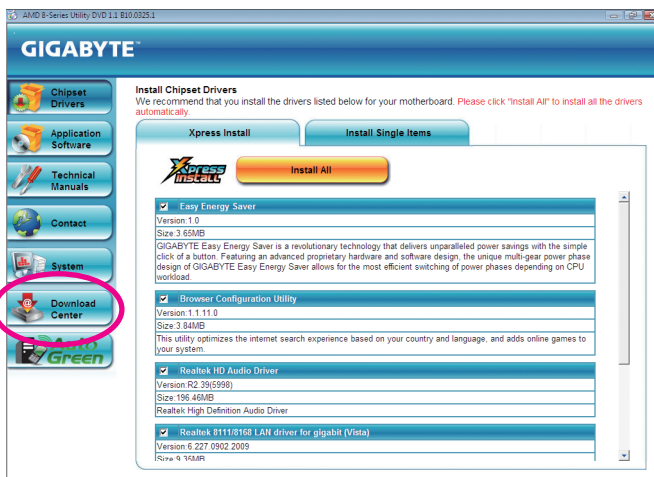

3-7 New Utilities

This page provides a quick link to GIGABYTE's lately developed utilities for users to install. You can click the **Install** button on the right of an item to install it.

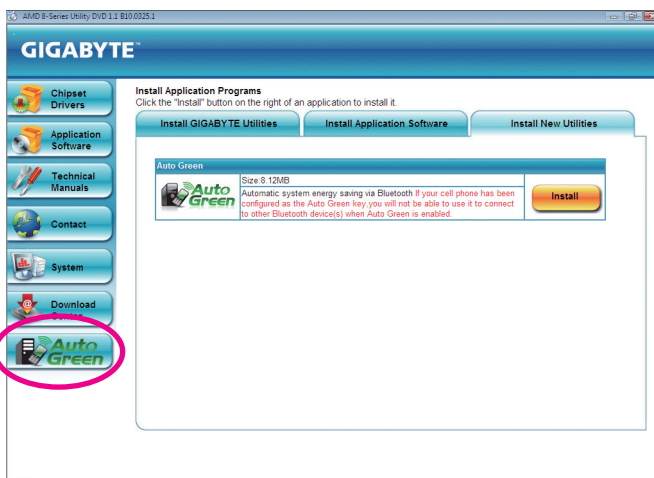

Chapter 4 Unique Features

4-1 Xpress Recovery2



Xpress Recovery2 is a utility that allows you to quickly compress and back up your system data and perform restoration of it. Supporting NTFS, FAT32, and FAT16 file systems, Xpress Recovery2 can back up data on PATA and SATA hard drives and restore it.

Before You Begin:

- Xpress Recovery2 will check the first physical hard drive ^(Note) for the operating system. Xpress Recovery2 can only back up/restore the first physical hard drive that has the operating system installed.
- As Xpress Recovery2 will save the backup file at the end of the hard drive, make sure to leave enough un-allocated space in advanced (10 GB or more is recommended; actual size requirements vary, depending on the amount of data).
- It is recommended to back up your system soon after the operating system and drivers are installed.
- The amount of data and hard drive access speed may affect the speed at which the data is backed up/ restored.
- It takes longer to back up a hard drive than to restore it.

System Requirements:

- At least 512 MB of system memory
- VESA compatible graphics card
- Windows XP with SP1 or later, Windows Vista
- Xpress Recovery and Xpress Recovery2 are different utilities. For example, a backup file created with Xpress Recovery cannot be restored using Xpress Recovery2.
- USB hard drives are not supported.
- Hard drives in RAID/AHCI mode are not supported.



Installation and Configuration:

Turn on your system to boot from the Windows Vista setup disk.

A. Installing Windows Vista and Partitioning the Hard Drive

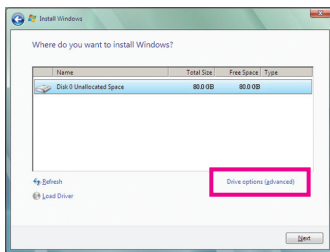

Step 1:
Click **Drive options**.

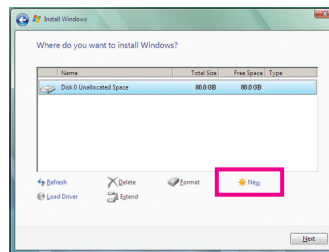

Step 2:
Click **New**.

(Note) Xpress Recovery2 checks the first physical hard drive in the following sequence: The first PATA IDE connector, the second PATA IDE connector, the first SATA connector, the second SATA connector and so forth. For example, when hard drives are attached to the first IDE and the first SATA connectors, the hard drive on the first IDE connector is the first physical drive. When hard drives are attached to the first and second SATA connectors, the hard drive on the first SATA connector is the first physical drive.

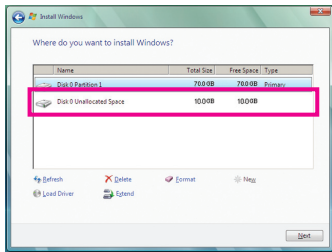

Step 3:
When partitioning your hard drive, make sure to leave unallocated space (10 GB or more is recommended; actual size requirements vary, depending on the amount of data) and begin the installation of the operating system.

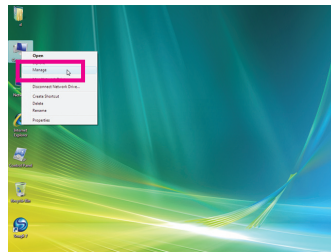

Step 4:
After the operating system is installed, right-click the **Computer** icon on your desktop and select **Manage**. Go to **Disk Management** to check disk allocation.

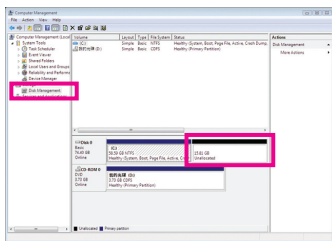

Step 5:
Xpress Recovery2 will save the backup file to the unallocated space (black stripe along the top). Please note that if there is no enough unallocated space, Xpress Recovery2 cannot save the backup file.

B. Accessing Xpress Recovery2

1. Boot from the motherboard driver disk to access Xpress Recovery2 for the first time. When you see the following message: *Press any key to startup Xpress Recovery2*, press any key to enter Xpress Recovery2.
2. After you use the backup function in Xpress Recovery2 for the first time, Xpress Recovery2 will stay permanent in your hard drive. If you wish to enter Xpress Recovery2 later, simply press <F9> during the POST.

C. Using the Backup Function in Xpress Recovery2



Step 1:
Select **BACKUP** to start backing up your hard drive data.

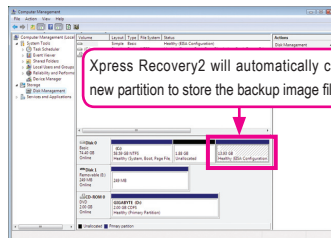

Step 2:
When finished, go to **Disk Management** to check disk allocation.

D. Using the Restore Function in Xpress Recovery2



Select **RESTORE** to restore the backup to your hard drive in case the system breaks down. The **RESTORE** option will not be present if no backup is created before.

E. Removing the Backup



Step 1:

If you wish to remove the backup file, select **REMOVE**.

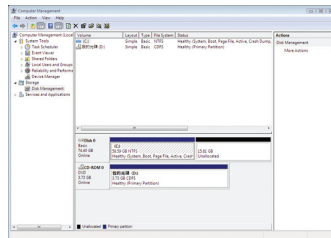

Step 2:

After the backup file is removed, no backup image file will be present in **Disk Management** and hard drive space will be freed up.

F. Exiting Xpress Recovery2



Select **REBOOT** to exit Xpress Recovery2.

4-2 BIOS Update Utilities

GIGABYTE motherboards provide two unique BIOS update tools, Q-Flash™ and @BIOS™. GIGABYTE Q-Flash and @BIOS are easy-to-use and allow you to update the BIOS without the need to enter MS-DOS mode. Additionally, this motherboard features the DualBIOS™ design, which enhances protection for the safety and stability of your computer by adding one more physical BIOS chip.



What is DualBIOS™?

Motherboards that support DualBIOS have two BIOS onboard, a main BIOS and a backup BIOS. Normally, the system works on the main BIOS. However, if the main BIOS is corrupted or damaged, the backup BIOS will take over on the next system boot and copy the BIOS file to the main BIOS to ensure normal system operation. For the sake of system safety, users cannot update the backup BIOS manually.



What is Q-Flash™?

With Q-Flash you can update the system BIOS without having to enter operating systems like MS-DOS or Window first. Embedded in the BIOS, the Q-Flash tool frees you from the hassles of going through complicated BIOS flashing process.



What is @BIOS™?

@BIOS allows you to update the system BIOS while in the Windows environment. @BIOS will download the latest BIOS file from the nearest @BIOS server site and update the BIOS.

4-2-1 Updating the BIOS with the Q-Flash Utility

A. Before You Begin

1. From GIGABYTE's website, download the latest compressed BIOS update file that matches your motherboard model.
2. Extract the file and save the new BIOS file (e.g. 870aud33.f1) to your USB flash drive or USB hard drive. Note: The USB flash drive or hard drive must use FAT32/16/12 file system.
3. Restart the system. During the POST, press the <End> key to enter Q-Flash. Note: You can access Q-Flash by either pressing the <End> key during the POST or pressing the <F8> key in BIOS Setup. However, if the BIOS update file is saved to a hard drive in RAID/AHCI mode or a hard drive attached to an independent IDE/SATA controller, use the <End> key during the POST to access Q-Flash.

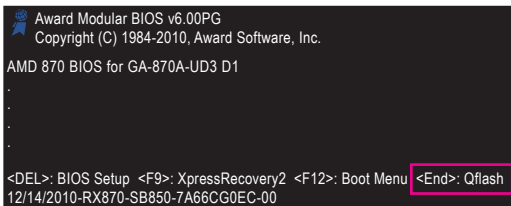

Because BIOS flashing is potentially risky, please do it with caution. Inadequate BIOS flashing may result in system malfunction.

B. Updating the BIOS

When updating the BIOS, choose the location where the BIOS file is saved. The following procedure assumes that you save the BIOS file to a USB flash drive.

Step 1:

1. Insert the USB flash drive containing the BIOS file into the computer. In the main menu of Q-Flash, use the up or down arrow key to select **Update BIOS from Drive** and press <Enter>.



- The **Save Main BIOS to Drive** option allows you to save the current BIOS file.
- Q-Flash only supports USB flash drive or hard drives using FAT32/16/12 file system.
- If the BIOS update file is saved to a hard drive in RAID/AHCI mode or a hard drive attached to an independent IDE/SATA controller, use the <End> key during the POST to access Q-Flash.

2. Select **HDD 0-0** and press <Enter>.

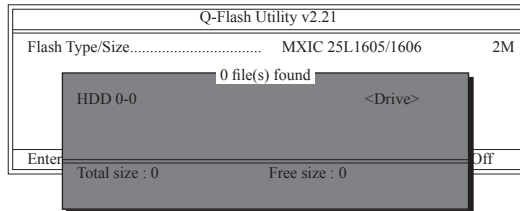

3. Select the BIOS update file and press <Enter>.



Make sure the BIOS update file matches your motherboard model.

Step 2:

The process of the system reading the BIOS file from the USB flash drive is displayed on the screen. When the message "Are you sure to update BIOS?" appears, press <Enter> to begin the BIOS update. The monitor will display the update process.



- **Do not turn off or restart the system when the system is reading/updating the BIOS.**
- **Do not remove the USB flash drive or hard drive when the system is updating the BIOS.**

Step 3:

When the update process is complete, press any key to return to the main menu.

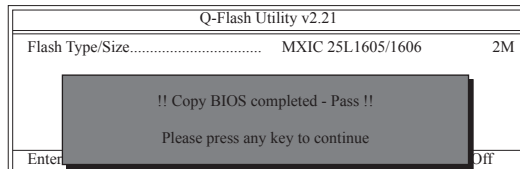

Step 4:

Press <Esc> and then <Enter> to exit Q-Flash and reboot the system. As the system boots, you should see the new BIOS version is present on the POST screen.

Step 5:

During the POST, press <Delete> to enter BIOS Setup. Select **Load Optimized Defaults** and press <Enter> to load BIOS defaults. System will re-detect all peripheral devices after a BIOS update, so we recommend that you reload BIOS defaults.

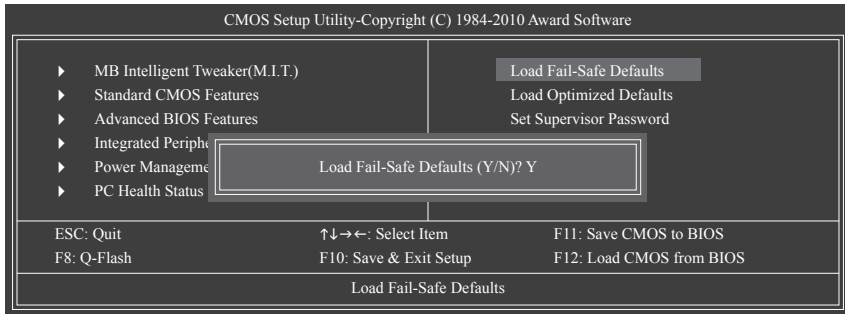

Press <Y> to load BIOS defaults

Step 6:

Select **Save & Exit Setup** and then press <Y> to save settings to CMOS and exit BIOS Setup. The procedure is complete after the system restarts.





4-2-2 Updating the BIOS with the @BIOS Utility

A. Before You Begin

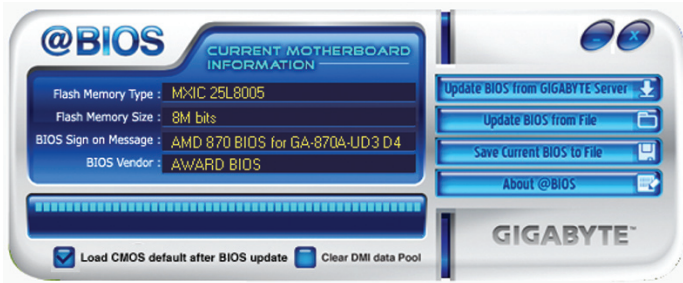
1. In Windows, close all applications and TSR (Terminate and Stay Resident) programs. This helps prevent unexpected failures when performing a BIOS update.
2. During the BIOS update process, ensure the Internet connection is stable and do NOT interrupt the Internet connection (for example, avoid a power loss or switching off the Internet). Failure to do so may result in a corrupted BIOS or a system that is unable to start.
3. Do not use the G.O.M. (GIGABYTE Online Management) function when using @BIOS.
4. GIGABYTE product warranty does not cover any BIOS damage or system failure resulting from an inadequate BIOS flashing.

B. Using @BIOS



1.  **Update the BIOS Using the Internet Update Function:**
Click **Update BIOS from GIGABYTE Server**, select the @BIOS server site closest to your location and then download the BIOS file that matches your motherboard model. Follow the on-screen instructions to complete.
 If the BIOS update file for your motherboard is not present on the @BIOS server site, please manually download the BIOS update file from GIGABYTE's website and follow the instructions in "Update the BIOS without Using the Internet Update Function" below.
2.  **Update the BIOS without Using the Internet Update Function:**
Click **Update BIOS from File**, then select the location where you save the BIOS update file obtained from the Internet or through other source. Follow the on-screen instructions to complete.
3.  **Save the Current BIOS File:**
Click **Save Current BIOS to File** to save the current BIOS file.
4.  **Load BIOS Defaults after BIOS Update:**
Select the **Load CMOS default after BIOS update** check box and then the system will automatically load BIOS defaults after BIOS update and after the system restarts.

C. After Updating the BIOS

Restart your system after updating the BIOS.



Make sure that the BIOS file to be flashed matches your motherboard model. Updating the BIOS with an incorrect BIOS file could cause your system not to boot.

4-3 EasyTune 6

GIGABYTE's EasyTune 6 is a simple and easy-to-use interface that allows users to fine-tune their system settings or do overclock/overvoltage in Windows environment. The user-friendly EasyTune 6 interface also includes tabbed pages for CPU and memory information, letting users read their system-related information without the need to install additional software.

The EasyTune 6 Interface

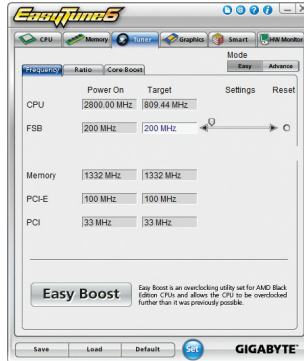

Tabs Information

| Tab | Function |
|------------|--|
| CPU | The CPU tab provides information on the installed CPU and motherboard. |
| Memory | The Memory tab provides information on the installed memory module(s). You can select memory module on a specific slot to see its information. |
| Tuner | <p>The Tuner tab allows you to change system clock settings and voltages.</p> <ul style="list-style-type: none"> • Easy mode allows you to adjust the CPU FSB only. • Advanced mode allows you to individually change system clock settings and voltages settings using the sliders. • Easy Boost is an easy-to-use auto-overclocking function ^(Note 1). When activated, the system automatically experiments all sorts of overclocking configurations till it hangs. After restart, the system will operate with the optimum configurations tested to let the CPU reach the best overclocking performance. • Core Boost is configurable only in Advanced mode. With Core Boost ^(Note 2) enabled, you can unlock hidden CPU cores or disable the cores that have been activated ^(Note 3). • Save allows you to save the current settings to a new profile (.txt file). • Load allows you to load previous settings from a profile. <p>After making changes in Easy mode/Advanced mode, be sure to click Set for these changes to take effect or click Default to restore to default values.</p> |
| Graphics | The Graphics tab allows you to change the core clock and memory clock for your ATI or NVIDIA graphics card. |
| Smart | The Smart tab allows you to specify a Smart Fan mode. Smart Fan allows the CPU fan speed to be changed linearly based on the CPU temperature thresholds you set. |
| HW Monitor | The HW Monitor tab allows you to monitor hardware temperature, voltage and fan speed and set temperature/fan speed alarm. You can choose the alert sound from the buzzer or use your own sound file (.wav file). |

(Note 1) Before enabling **Easy Boost**, right-click the EasyTune 6 icon in the notification area. Select **Auto overclock last tune on the next reboot** to allow the system to work with the optimum overclocking configuration after restart.

(Note 2) Restart the computer after enabling Core Boost for the settings to take effect.

(Note 3) The number of CPU cores that can be enabled/disabled depends on the CPU being used.

Available functions in EasyTune 6 may differ by motherboard model. Grayed-out area(s) indicates that the item is not configurable or the function is not supported.



Incorrectly doing overclock/overvoltage may result in damage to the hardware components such as CPU, chipset, and memory and reduce the useful life of these components. Before you do the overclock/overvoltage, make sure that you fully know each function of EasyTune 6, or system instability or other unexpected results may occur.

4-4 Easy Energy Saver

GIGABYTE Easy Energy Saver is a revolutionary technology that delivers unparalleled power savings with a click of the button. Featuring an advanced proprietary software design, GIGABYTE Easy Energy Saver is able to provide exceptional power savings and enhanced power efficiency without sacrificing computing performance.

The Easy Energy Saver Interface

A. Meter Mode

In Meter Mode, GIGABYTE Easy Energy Saver shows how much power they have saved in a set period of time.

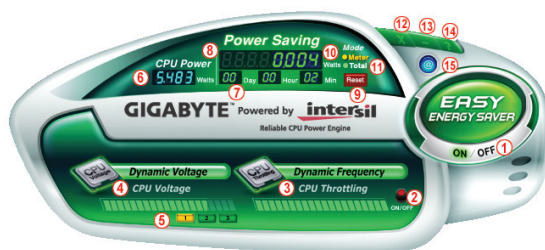

Meter Mode - Button Information Table

| Button | Button Description |
|--------|---|
| 1 | Easy Energy Saver On/Off Switch (Default: Off) |
| 2 | Dynamic CPU Frequency Function On/Off Switch (Default: Off) ^(Note 1) |
| 3 | CPU Throttling Display |
| 4 | CPU Voltage Display |
| 5 | 3-Level CPU Voltage Switch (Default:1) ^(Note 2) |
| 6 | Current CPU Power Consumption |
| 7 | Meter Time |
| 8 | Power Saving (Calculate power savings based on time) |
| 9 | Meter/Timer Reset Switch |
| 10 | Meter Mode Switch |
| 11 | Total Mode Switch |
| 12 | Close (Application will enter Stealth Mode) |
| 13 | Minimize (Application will continue to run in taskbar) |
| 14 | INFO/Help |
| 15 | Live Utility Update (Check for the latest utility version) |

- The above data is for reference only. Actual performance may vary depending on motherboard model.
- CPU Power and Power Scores are for reference only. Actual results may vary based on testing method.

B. Total Mode

In Total Mode, users are able to see how much total power savings they have accumulated in a set period of time since activating Easy Energy Saver for the first time ^(Note 3).

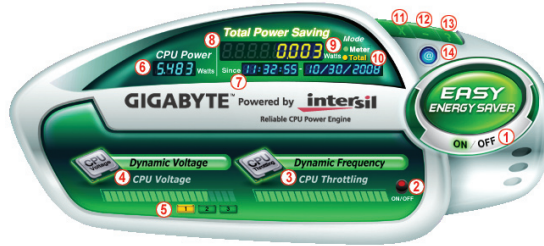

Total Mode - Button Information Table

| | Button Description |
|----|---|
| 1 | Easy Energy Saver On/Off Switch (Default: Off) |
| 2 | Dynamic CPU Frequency Function On/Off Switch (Default: Off) ^(Note 1) |
| 3 | CPU Throttling Display |
| 4 | CPU Voltage Display |
| 5 | 3-Level CPU Voltage Switch (Default:1) ^(Note 2) |
| 6 | Current CPU Power Consumption |
| 7 | Time/Date Easy Energy Saver Enabled |
| 8 | Total Power Savings (Total power saving with Easy Energy Saver enabled) ^(Note 4) |
| 9 | Meter Mode Switch |
| 10 | Total Mode Switch |
| 11 | Close (Application will enter Stealth Mode) |
| 12 | Minimize (Application will continue to run in taskbar) |
| 13 | INFO/Help |
| 14 | Live Utility Update (Check for the latest utility version) |

C. Stealth Mode

In Stealth Mode, the system continues to work with the user-defined power saving settings, even after the system is restarted. Re-enter the application only if you want to make any changes or completely close the application.

(Note 1) Maximize system power saving with Dynamic CPU Frequency Function; system performance may be affected.

(Note 2) 1: Normal Power Saving (default); 2: Advanced Power Saving; 3: Extreme Power Saving.

(Note 3) The total amount of power saved will be recorded until re-activated when only the Easy Energy Saver is under the enable status, and power savings meter is unable to reset to zero.

(Note 4) Easy Energy Saver Meter will automatically reset when the total power saving reaches 99999999 Watts.

4-5 Q-Share

Q-Share is an easy and convenient data sharing tool. After configuring your LAN connection settings and Q-Share, you are able to share your data with computers on the same network, making full use of Internet resources.



Directions for using Q-Share

After installing Q-Share from the motherboard driver disk, go to Start>All Programs>GIGABYTE>Q-Share.exe to launch the Q-Share tool. Find the **Q-Share** icon  in the notification area and right-click on this icon to configure the data sharing settings.



Figure 1. Data Sharing Disabled



Figure 2. Data Sharing Enabled

Options Descriptions

| Option | Description |
|--|--|
| Connect ... | Displays the computers with data sharing enabled |
| Enable Incoming Folder ... | Enables data sharing |
| Disable Incoming Folder ... | Disables data sharing |
| Open Incoming Folder : C:\Q-ShareFolder | Accesses the shared data folder |
| Change Incoming Folder : C:\Q-ShareFolder | Changes the data folder to be shared ^(Note) |
| Update Q-Share ... | Updates Q-Share online |
| About Q-Share ... | Displays the current Q-Share version |
| Exit... | Exits Q-Share |

(Note) This option is available only when data sharing is NOT enabled.

4-6 SMART Recovery

With SMART Recovery, users can quickly create backups of changed data files^(Note 1) or copy files from a specific backup on PATA and SATA hard drives (partitioned on NTFS file system) in Windows Vista.

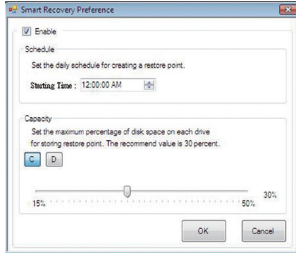

Instructions:

In the main menu, click the **Config** button to open the **Smart Recovery Preference** dialog box.

The **Smart Recovery Preference** dialog box:

| Button | Function |
|----------|---|
| Enable | Enables automatic daily backup ^(Note 2) |
| Schedule | Sets a daily backup schedule |
| Capacity | Sets the percentage of hard drive space used for saving backups ^(Note 3) |



- The hard drive must have more than 1 GB of capacity.
- Each partition can accommodate up to 64 backups (the actual limit depends on the size of each partition). When this limit is reached, the oldest backup will be overwritten.



Instructions for copying files/folders from a backup:

To browse through your backups made at different time, select a backup time using the time scroll bar on the right or at the bottom of the screen. If you want to copy back a file/folder, select the file/folder you wish to copy and click the **Copy** button.



- The files/folders listed on the screen are read-only so you cannot edit their contents.

(Note 1) The changed data refers to the data that has been modified, deleted, or newly added since the last backup.

(Note 2) The system will make an automatic backup on changed data only once everyday. If the computer is turned on for a long time, the backup will be performed at the scheduled backup time. If the computer is turned off before the scheduled backup time, the backup will be performed on the next boot.

(Note 3) We recommend that you preserve at least 25 percent of the hard drive space to optimize the storage space for the backups. The backups of the changed data will be stored in the original partition of the data.

4-7 Auto Green

Auto Green is an easy-to-use tool that provides users with simple options to enable system power savings via a Bluetooth cell phone. When the phone is out of the range of the computer's Bluetooth receiver, the system will enter the specified power saving mode.

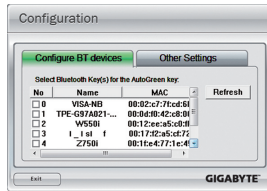

The Configuration dialog box:

First, you have to set your Bluetooth cell phone as a portable key. On the Auto Green main menu, click **Configure** and then click **Configure BT devices**. Select the Bluetooth cell phone that you want to use as the portable key^(Note 1). (If the screen doesn't display your Bluetooth cell phone, click **Refresh** to let Auto Green re-detect the device.)



Before creating a Bluetooth cell phone key, make sure your motherboard has a Bluetooth receiver and you have turned on the search and Bluetooth functions on your phone.

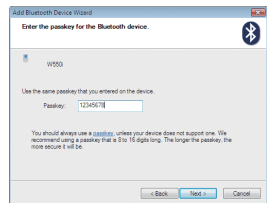

Configuring the Bluetooth cell phone key:

After you select a cell phone, the **Add Bluetooth Device Wizard** as shown on the left will appear. Enter a passkey (8~16 digits recommended) which will be used for pairing with the cell phone. Then enter the same passkey on your cell phone.

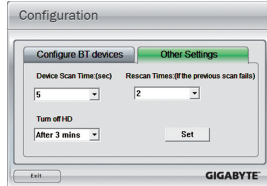

Configuring other Bluetooth settings:

On the **Other Settings** tab, you can set how much time it takes to scan your Bluetooth cell phone key, how many times to rescan the key to make sure it is in range of your computer, and when to turn off the hard drive if the system energy saving state lasts over the predetermined period of time. After completing the settings, click **Set** for the settings to take effect and then click **Exit** to quit.

- **Device Scan Time (sec.):**
Set the length of time Auto Green scans your Bluetooth cell phone key, ranging from 5 to 30 seconds in 5-second increment. Auto Green searches for the key based on the length of time you set.
- **Rescan Times:**
Set how many times Auto Green will rescan your Bluetooth cell phone key if it does not detect it, ranging from 2 to 5 times. Auto Green will keep rescanning according to the times you set. When the times limit is reached and your Bluetooth cell phone key is still not detected, the system will enter the selected energy saving mode.
- **Turn off HD:**
Set when to turn off the hard drive. If the system inactivity time exceeds the specified time limit, the hard drive will be turned off.



Selecting a system energy saving mode:

Depending on your needs, select a system power saving mode on the Auto Green main menu and click **Save** to save the settings.

| Button | Description |
|---------|------------------------------|
| Standby | Enters Power on Suspend mode |
| Suspend | Enters Suspend to RAM mode |
| Disable | Disables this function |



The Bluetooth dongle included in the motherboard package^(Note 2) allows you to wake up the system from Suspend to RAM mode without the need to press the power button first.

(Note 1) If your cell phone has been configured as the Auto Green key, you'll not be able to use it to connect to other Bluetooth device(s) when Auto Green is enabled.

(Note 2) Whether the Bluetooth dongle is included depends on the motherboard models. Before installing the Bluetooth dongle, be sure to turn off other Bluetooth receiver on your computer.

Chapter 5 Appendix

5-1 Configuring SATA Hard Drive(s)

To configure SATA hard drive(s), follow the steps below:

- A. Install SATA hard drive(s) in your computer.
- B. Configure SATA controller mode in BIOS Setup.
- C. Configure a RAID array in RAID BIOS. ^(Note 1)
- D. Make a floppy disk containing the SATA RAID/AHCI driver for Windows XP. ^(Note 2)
- E. Install the SATA RAID/AHCI driver ^(Note 2) and operating system.

Before you begin

Please prepare:

- At least two SATA hard drives (to ensure optimal performance, it is recommended that you use two hard drives with identical model and capacity). If you do not want to create RAID, you may prepare only one hard drive.
- An empty formatted floppy disk.
- Windows Vista/XP setup disk.
- Motherboard driver disk.

5-1-1 Configuring AMD SB850 SATA Controller

A. Installing SATA hard drive(s) in your computer

Attach one end of the SATA signal cable to the rear of the SATA hard drive and the other end to available SATA port on the motherboard. If there is more than one SATA controller on your motherboard, refer to "Chapter 1," "Hardware Installation," to identify the SATA controller for the SATA port. (For example, on this motherboard, the SATA3_0~SATA3_5 ports are supported by the AMD SB850 South Bridge.) Then connect the power connector from your power supply to the hard drive.

(Note 1) Skip this step if you do not want to create RAID array on the SATA controller.

(Note 2) Required when the SATA controller is set to AHCI or RAID mode.

B. Configuring SATA controller mode in BIOS Setup

Make sure to configure the SATA controller mode correctly in system BIOS Setup.

Step 1:

Turn on your computer and press <Delete> to enter BIOS Setup during the POST (Power-On Self-Test). Make sure **OnChip SATA Controller** is enabled. To enable RAID for the SATA3_0/1/2/3 connectors, set **On-Chip SATA Type** to **RAID**. To enable RAID for the SATA3_4/5 connectors, set **OnChip SATA Type** to **RAID** and set **OnChip SATA Port4/5 Type** to **As SATA Type** (Figure 1). To enable support for RAID 5, set **OnChip SATA RAID5 Support** to **Enabled**.

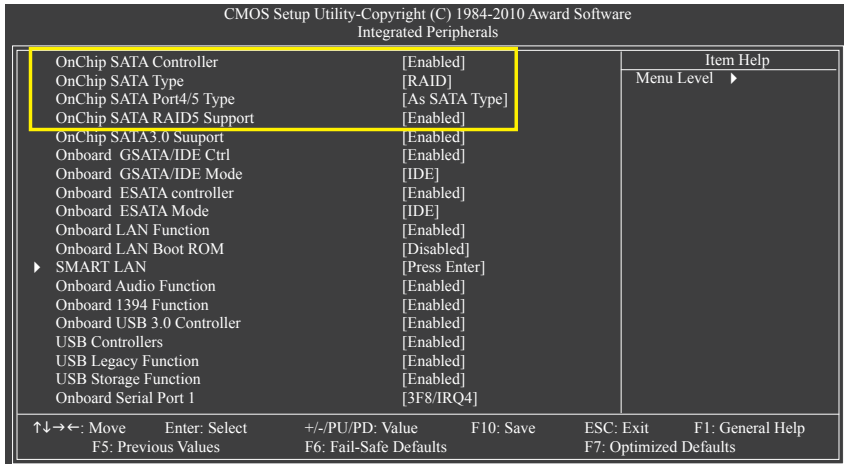

Figure 1

Step 2:

Save changes and exit BIOS Setup.



The BIOS Setup menus described in this section may differ from the exact settings for your motherboard. The actual BIOS Setup menu options you will see shall depend on the motherboard you have and the BIOS version.

C. Configuring RAID set in RAID BIOS

Enter the RAID BIOS setup utility to configure a RAID array. Skip this step and proceed with the installation of Windows operating system for a non-RAID configuration.

Step 1:

After the POST memory test begins and before the operating system boot begins, look for a message which says "Press <Ctrl-F> to enter RAID Option ROM Utility" (Figure 2). Press <Ctrl> + <F> to enter the RAID BIOS setup utility.

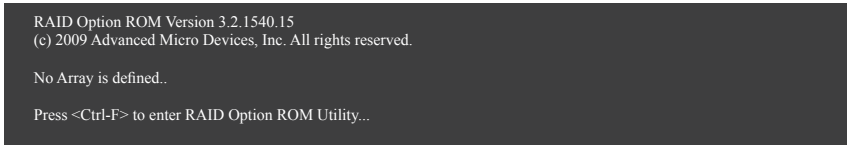

Figure 2

Step 2:

Main Menu

This is the first option screen when you enter the BIOS RAID Setup utility. (Figure 3).

To view the disk drives assigned to arrays, press <1> to enter the **View Drive Assignments** window.

To create an array, press <2> to enter the **LD View/LD Define Menu** window.

To delete an array, press <3> to enter the **Delete LD Menu** window.

To view controller settings, press <4> to enter the **Controller Configuration** window.

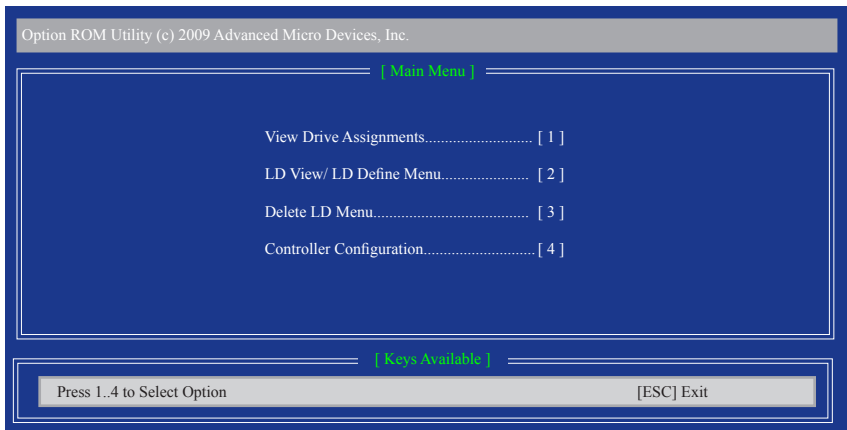

Figure 3

Create Arrays Manually

To create a new array, press <2> to enter the **LD View Menu** window (Figure 4). To create an array, press <Ctrl+C> to access the **LD Define Menu**.

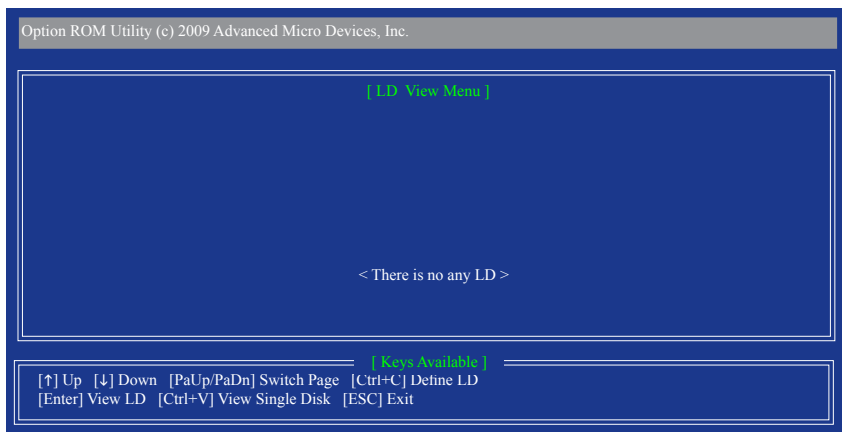

Figure 4

In the **LD Define Menu**, use the up or down arrow key to move to an item for further configuration (Figure 5).

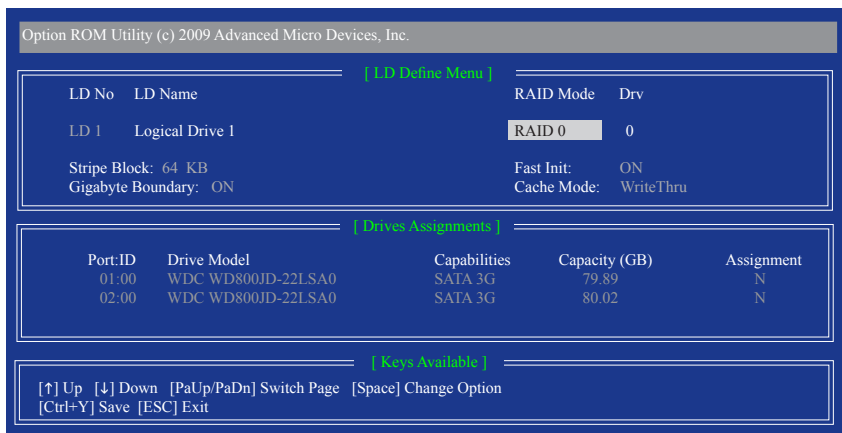
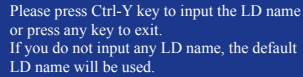

Figure 5

In the following procedure, we'll create RAID 0 as an example.

1. Under the **RAID Mode** section, press the <SPACE> key to select **RAID 0**.
2. Set the **Stripe Block** size. 64 KB is the default.
3. Under the **Drives Assignments** section, press the up or down arrow key to highlight a drive.
4. Press the <SPACE> key or <Y> to change the **Assignment** option to **Y**. This action adds the drive to the disk array. The **Drv** section will show the number of disks assigned.
5. Press <Ctrl>+<Y> keys to save the information. The message in Figure 6 will appear. Press <Ctrl>+<Y> to input the array name. If you do not input the array name, the default array name will be used.

A blue rectangular message box with white text. The text reads: "Please press Ctrl-Y key to input the LD name or press any key to exit. If you do not input any LD name, the default LD name will be used."

Please press Ctrl-Y key to input the LD name
or press any key to exit.
If you do not input any LD name, the default
LD name will be used.

Figure 6

6. When the next message appears, press <Ctrl>+<Y> to clear the MBR or press other keys to ignore this option.

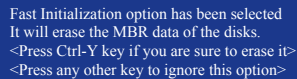
A blue rectangular message box with white text. The text reads: "Fast Initialization option has been selected. It will erase the MBR data of the disks. <Press Ctrl-Y key if you are sure to erase it> <Press any other key to ignore this option>"

Fast Initialization option has been selected
It will erase the MBR data of the disks.
<Press Ctrl-Y key if you are sure to erase it>
<Press any other key to ignore this option>

Figure 7

7. Then, the message in Figure 8 will appear. Press <Ctrl>+<Y> to set the capacity of the RAID array or press other keys to set the array to its maximum capacity.

A blue rectangular message box with white text. The text reads: "Press Ctrl-Y to Modify Array Capacity or press any other key to use maximum capacity..."

Press Ctrl-Y to Modify Array Capacity or press any
other key to use maximum capacity...

Figure 8

8. After the creation is complete, the screen will return to **LD View Menu** where you will see the newly-created array.
9. Press <Esc> to return to **Main Menu** and press <Esc> again if you want to exit the RAID BIOS utility.

View Drive Assignments

The **View Drive Assignments** option in the **Main Menu** displays whether the attached hard drives are assigned to a disk array or are unassigned. Under the **Assignment** column, drives are labeled with their assigned disk array or shown as **Free** if unassigned.

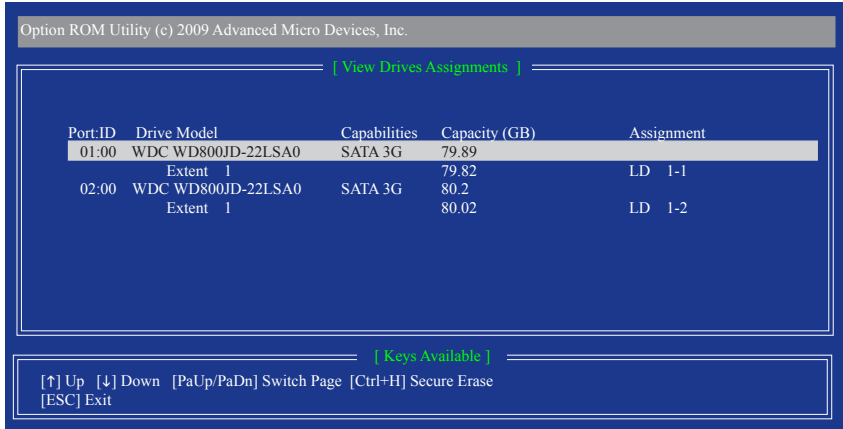

Figure 9

Delete an Array

The **Delete Array** menu option allows for deletion of disk array assignments.



Deleting an existing disk array could result in loss of data. Record all array information including the array type, the disk members, and stripe block size in case you wish to undo a deletion.

1. To delete an array, press <3> in the **Main Menu** to enter the **Delete LD Menu**. Then highlight the array you wish to delete and press the <Delete> key or the <Alt>+<D> keys.
2. The **View LD Definition Menu** will appear (as shown in Figure 10) showing which drives are assigned to this array. Press <Ctrl>+<Y> if you are sure to delete the array or other keys to abort.
3. When the array is deleted, the screen will return to **Delete LD Menu**. Press <Esc> to return to Main Menu.

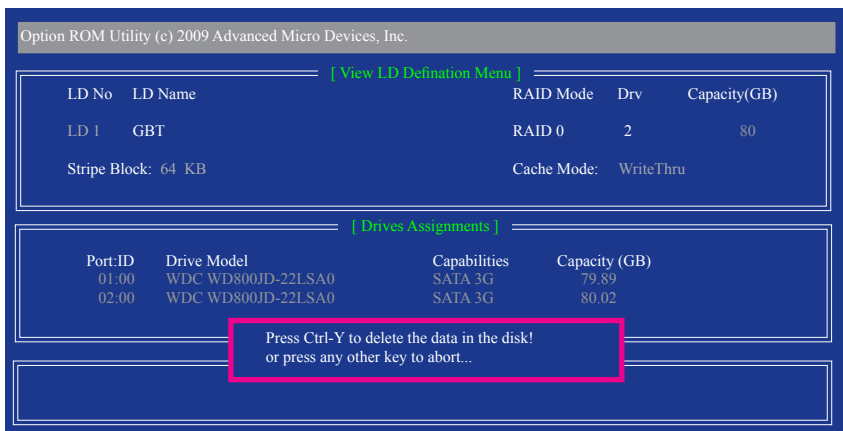

Figure 10

5-1-2 Configuring GIGABYTE SATA2/JMicron JMB362 SATA Controller

A. Installing SATA hard drive(s) in your computer

Attach one end of the SATA signal cable to the rear of the SATA hard drive and the other end to available SATA port on the motherboard. See the table below for the SATA controllers and their corresponding SATA ports. Then connect the power connector from your power supply to the hard drive.

B. Configuring SATA controller mode in BIOS Setup

Make sure to configure the SATA controller mode correctly in system BIOS Setup.

Step 1:

Turn on your computer and press <Delete> to enter BIOS Setup during the POST. In BIOS Setup, go to **Integrated Peripherals**. To enable RAID, see the table below for configuring different SATA Controllers for RAID.

| Controller | Connectors | BIOS Settings |
|-------------------|-------------|---|
| GIGABYTE SATA2 | GSATA2_6/7 | Set Onboard GSATA/IDE Ctrl to Enabled Set Onboard GSATA/IDE Mode to RAID/IDE |
| JMicron JMB362 | eSATA ports | Set Onboard ESATA controller to Enabled Set Onboard ESATA Mode to RAID |

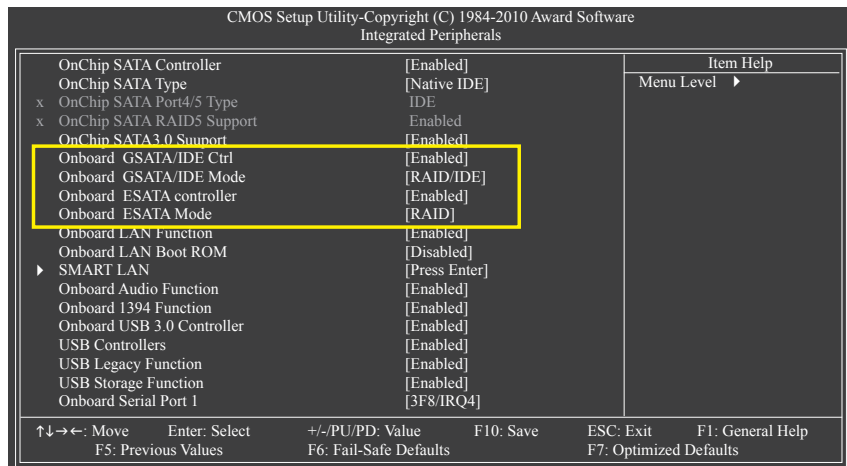

Figure 1

Step 2:

Save changes and exit BIOS Setup.



The BIOS Setup menus described in this section may differ from the exact settings for your motherboard. The actual BIOS Setup menu options you will see shall depend on the motherboard you have and the BIOS version.

C. Configuring a RAID array in RAID BIOS

Enter the RAID BIOS setup utility to configure a RAID array. Skip this step and proceed to the installation of Windows operating system for a non-RAID configuration.

After the POST memory test begins and before the operating system boot begins, look for a message which says "Press <Ctrl-G> to enter RAID Setup Utility" (Figure 2). Press <Ctrl> + <G> to enter the RAID setup utility.

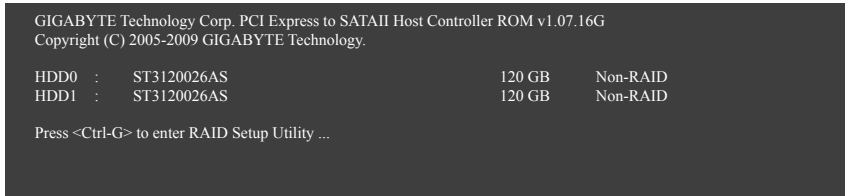

Figure 2

In the main screen of the RAID setup utility (Figure 3), use the up or down arrow key to highlight through choices in the **Main Menu** block. Highlight the item that you wish to execute and press <Enter>.

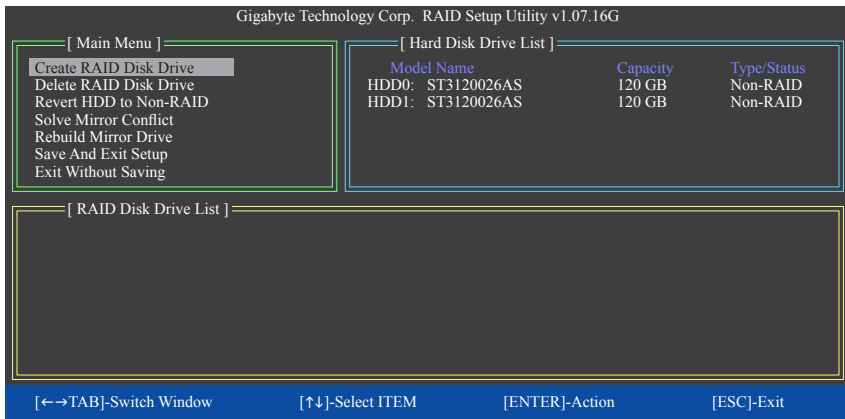

Figure 3

Note: In the main screen, you can select a hard drive in the **Hard Disk Drive List** block and press <Enter> to see detailed information about the selected hard drive.

Create a RAID Array:

In the main screen, press <Enter> on the **Create RAID Disk Drive** item. Then the **Create New RAID** screen appears (Figure 4).

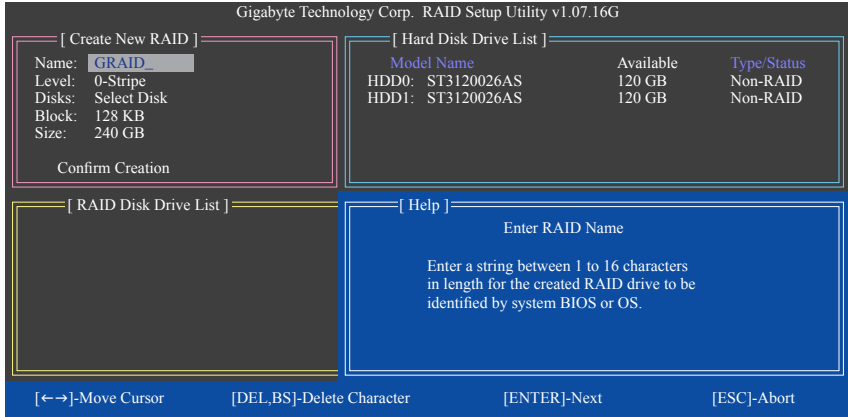

Figure 4

The **Create New RAID** block displays all the items that need to be set for creating an array (Figure 5).

Steps:

1. **Enter Array Name:** Under the **Name** item, enter an array name with 1~16 letters (letters cannot be special characters) and press <Enter>.
2. **Select RAID Mode:** Under the **Level** item, use up or down arrow key to select RAID 0 (Stripe), RAID 1 (Mirror) or JBOD (Figure 5). Then press <Enter> to move onto the next step.

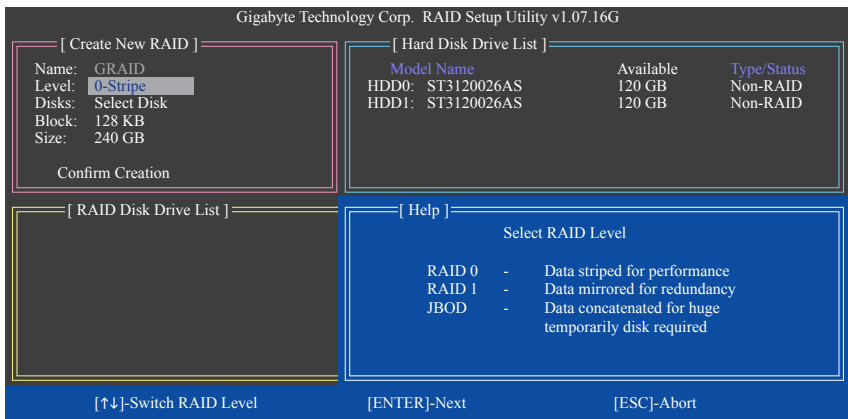

Figure 5

3. **Assign Array Disks:** After a RAID mode is selected, RAID BIOS automatically assigns the two hard drives installed as the RAID drives.
4. **Set Block Size (RAID 0 only):** Under the **Block** item, use the up or down arrow key to select the stripe block size (Figure 6), ranging from 4 KB to 128 KB. Press <Enter>.

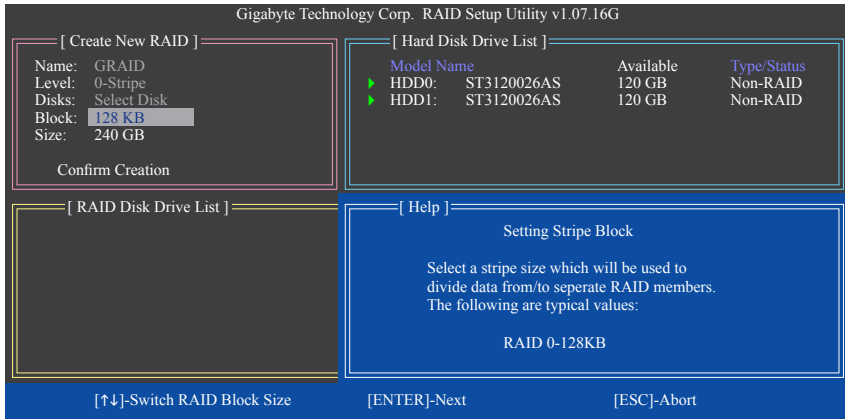

Figure 6

5. **Set Array Size:** Under the **Size** item, enter the size of the array and press <Enter>.
6. **Confirm Creation:** After all of the items above are configured, the selection bar automatically jumps to the **Confirm Creation** item. Press <Enter>. When prompted to confirm your selection (Figure 7), press <Y> to confirm or <N> to abort.

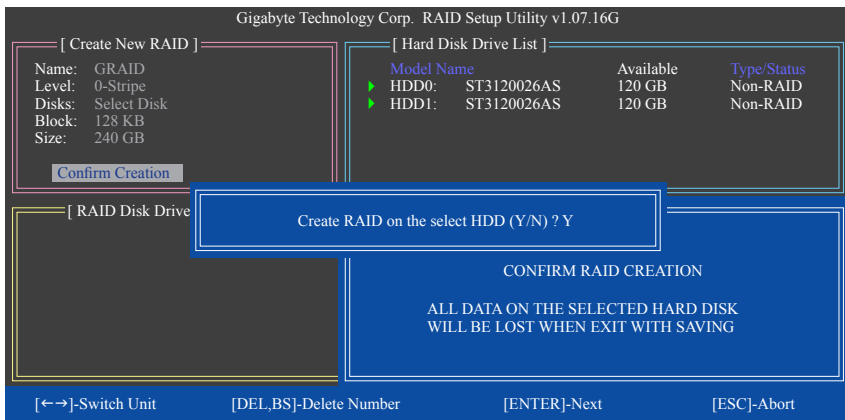

Figure 7

When finished, the new RAID array will be displayed in the **RAID Disk Drive List** block (Figure 8).

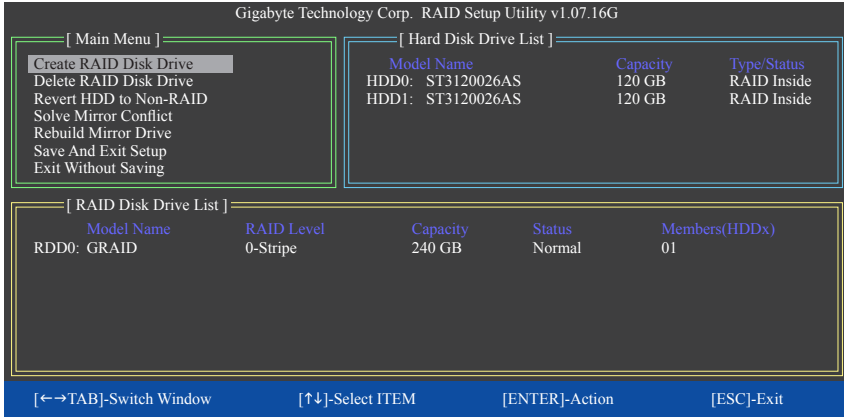

Figure 8

To check more detailed information about the array, use the <Tab> key while in the **Main Menu** block to move the selection bar to the **RAID Disk Drive List** block. Select the array and press <Enter>. A small window displaying the array information will appear in the center of the screen (Figure 9).

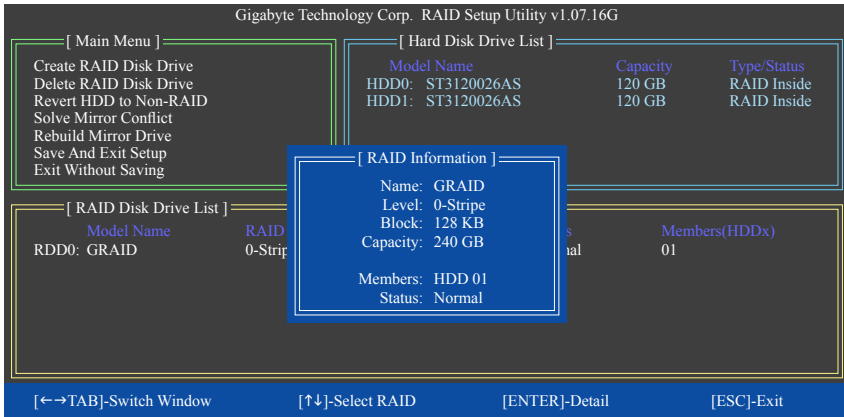

Figure 9

7. **Save and Exit Setup:** After configuring the RAID array, select the **Save And Exit Setup** item in the main screen to save your settings before exiting the RAID BIOS utility, then press <Y> (Figure 10).

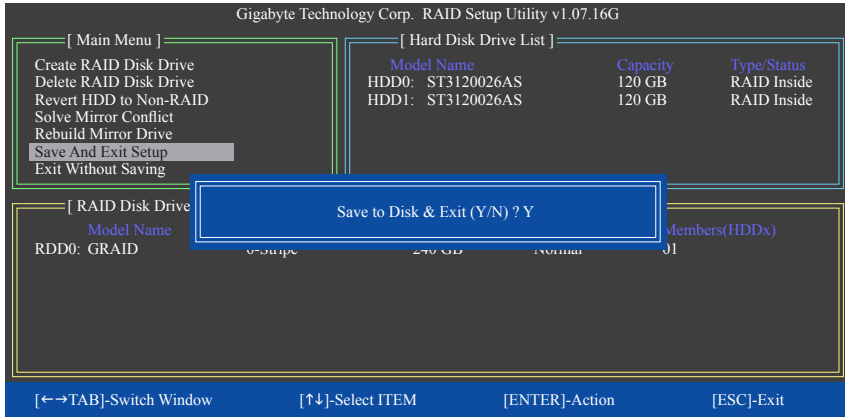

Figure 10

Now, you may proceed to create the SATA RAID/AHCI driver diskette and the installation of the SATA RAID/AHCI driver and operating system.

Delete the RAID Array:

To delete the array, select **Delete RAID Disk Drive** in the main menu and press <Enter>. The selection bar will move to the **RAID Disk Drive List** block. Press the <SPACE> key on the array to be deleted; a small triangle will appear to mark the selected array. Press <Delete>. When prompted to confirm your selection (Figure 11), press <Y> to confirm or <N> to cancel.

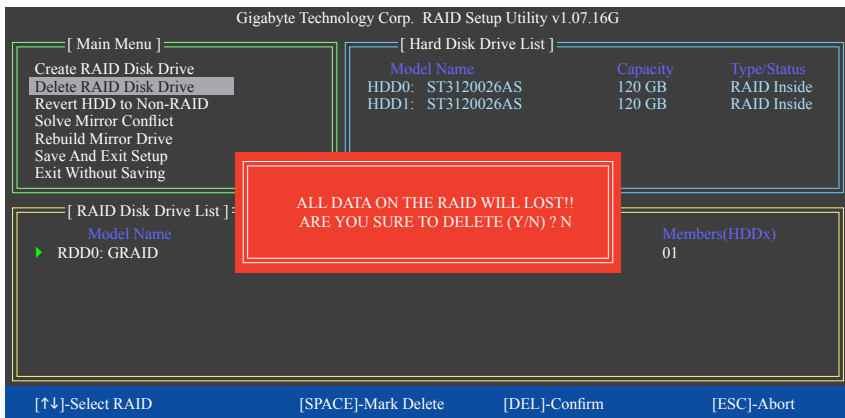

Figure 11

5-1-3 Making a SATA RAID/AHCI Driver Diskette

(Required for AHCI and RAID Mode)

To successfully install operating system onto SATA hard drive(s) that is/are configured to RAID/AHCI mode, you need to install the SATA controller driver during the OS installation. Without the driver, the hard drive may not be recognized during the Windows setup process. First of all, copy the driver for the SATA controller from the motherboard driver disk to a floppy disk. For installing Windows Vista, you also can copy the SATA controller driver from the motherboard driver disk to a USB flash drive. See the instructions below about how to copy the driver in MS-DOS and Windows mode.

In MS-DOS mode:

Prepare a startup disk that has CD-ROM support and a blank formatted floppy disk.

Steps:

- 1: Boot from the startup disk.
- 2: Remove the startup disk and insert the prepared floppy disk and the motherboard driver disk (here we assume that the drive letter for your optical drive is D:\).
- 3: At the A:\> prompt, type the following command. Press <Enter> after the command:
 - For the AMD SB850, type (Figure 1):^(Note 1)
A:\>copy d:\bootdrv\SB8xx\x86*.*
 - For the GIGABYTE SATA2/JMicron JMB362, type (Figure 2):^(Note 2)
A:\>copy d:\bootdrv\gsata\32bit*.*

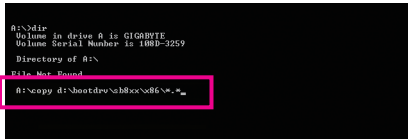

```
A:\>dir
A:\>copy d:\bootdrv\SB8xx\x86\*.*
```

Figure 1



```
A:\>dir
A:\>copy d:\bootdrv\gsata\32bit\*.*
```

Figure 2

(Note 1) Type the driver directory based on the operating system to be installed. Refer to the following table for the SATA driver directories for different Windows operating systems.

| Operating System | Directory |
|----------------------------------|-------------------------------|
| Windows XP 32-bit | Bootdrv\SB8xx\x86 |
| Windows XP 64-bit | Bootdrv\SB8xx\x64 |
| Windows Vista 32-bit (AHCI mode) | Bootdrv\SB8xx\AHCI\Hx86 |
| Windows Vista 32-bit (RAID mode) | Bootdrv\SB8xx\RAID\Hx86 |
| Windows Vista 64-bit (AHCI mode) | Bootdrv\SB8xx\AHCI\Hx64 |
| Windows Vista 64-bit (RAID mode) | Bootdrv\SB8xx\RAID\Hx64 |
| Windows 7 32-bit (AHCI mode) | Bootdrv\SB8xx\W7\AHCI\Win7x86 |
| Windows 7 32-bit (RAID mode) | Bootdrv\SB8xx\W7\RAID\W7 |
| Windows 7 64-bit (AHCI mode) | Bootdrv\SB8xx\W7\AHCI\Win7x64 |
| Windows 7 64-bit (RAID mode) | Bootdrv\SB8xx\W7\RAID\W7x64 |

(Note 2) Change the directory from **32bit** to **64bit** for copying the Windows 64-bit driver.

In Windows mode:

Steps:

- 1: Use an alternative system and insert the motherboard driver disk.
- 2: From your optical drive folder, double click the **Menu.exe** file in the **BootDrv** folder (Figure 3). A Command Prompt window will open similar to that in Figure 4.
- 3: Insert the blank formatted disk. Depending on the operating system to be installed, select the controller driver by pressing the corresponding letter from the menu and press <Enter>. For example, from the menu in Figure 4,
 - For the AMD SB850, select **3) ATi AHCI/RAID Driver for XP** for Windows XP operating system.
 - For the GIGABYTE SATA2/JMicron JMB362, select **1) GIGABYTE GSATA driver for 32bit system** for Windows 32-bit operating system.

Your system will then automatically copy the driver files to the floppy disk. Press any key to exit when finished.

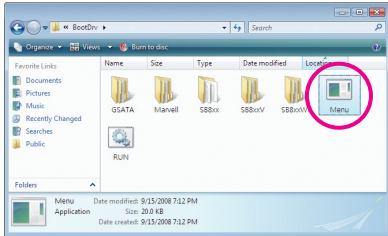

Figure 3

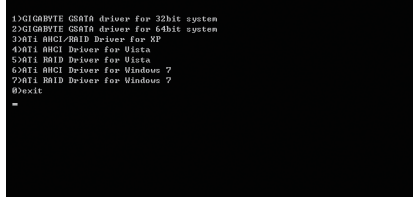

Figure 4

5-1-4 Installing the SATA RAID/AHCI Driver and Operating System

With the SATA RAID/AHCI driver diskette and correct BIOS settings, you are ready to install Windows Vista/XP onto your hard drive(s). The followings are examples of Windows XP and Vista installation.

A. Installing Windows XP

Step 1:

Restart your system to boot from the Windows XP setup disk and press <F6> as soon as you see the message "Press F6 if you need to install a 3rd party SCSI or RAID driver" (Figure 1). A screen will then appear asking you to specify additional device.

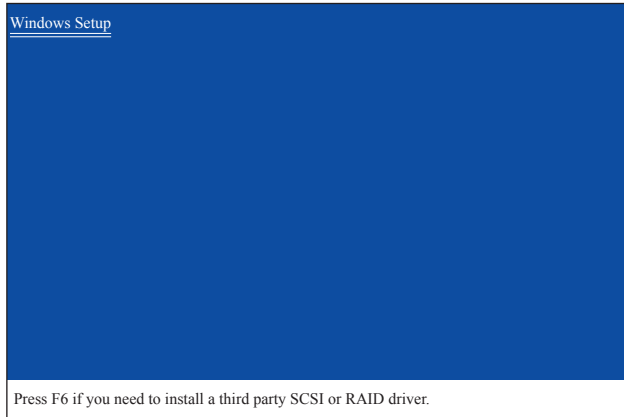

Figure 1

Step 2:

For the AMD SB850:

Insert the floppy disk containing the SATA RAID/AHCI driver and press <S>. Then a controller menu similar to Figure 2 below will appear. Select **AMD AHCI Compatible RAID Controller-x86 platform** and press <Enter>.



Figure 2

For the GIGABYTE SATA2/JMicron JMB362:

Insert the floppy disk containing the SATA RAID/AHCI driver and press <S>. Then a controller menu similar to Figure 3 below will appear. Select **RAID/AHCI Driver for GIGABYTE GBB36X Controller (x32)** and press <Enter>.

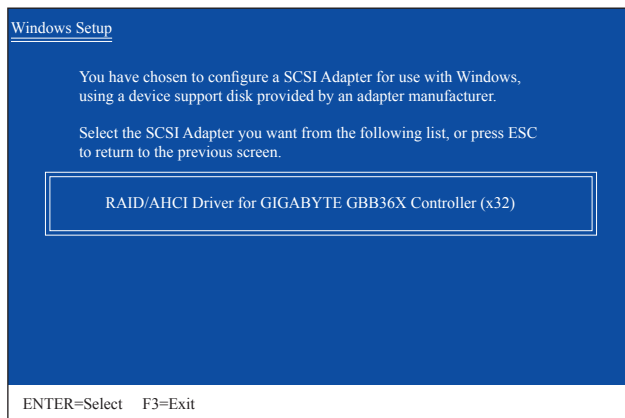

Figure 3

Step 3:

On the next screen, press <Enter> to continue the driver installation. After the driver installation, you can proceed with the Windows XP installation.

B. Installing Windows Vista

The procedure below assumes that only one RAID array exists in your system.

For the AMD SB850:

Step 1:

Restart your system to boot from the Windows Vista setup disk and perform standard OS installation steps. When a screen similar to that below appears (RAID hard drive will not be detected at this stage), select **Load Driver** (Figure 4).

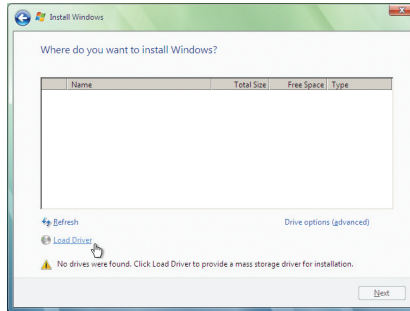

Figure 4

Step 2:

Insert the motherboard driver disk (Method A) or the removable storage device such as USB flash drive that contains the SATA RAID/AHCI driver (Method B), then specify the location of the driver (Figure 5). Note: For users using a SATA optical drive, be sure to copy the driver files from the motherboard driver disk to a USB flash drive before installing Windows Vista (go to the **BootDrv** folder and save the whole **SB8xxV** folder to the USB flash drive). Then use Method B to load the driver.

Method A:

Insert the motherboard driver disk into your system and browse to the following directory:

`\BootDrv\SB8xxV\RAID\LH`

For Windows Vista 64-bit, browse to the **LH64A** folder.

Method B:

Insert the USB flash drive containing the driver files and browse to the **LH** (for Windows Vista 32-bit) or **LH64A** (for Windows Vista 64-bit) folder.

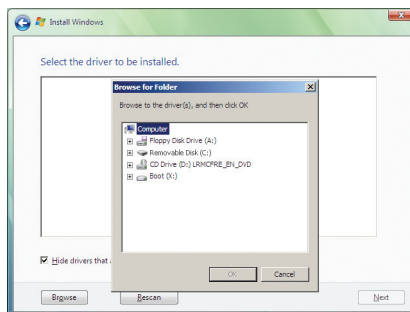

Figure 5

Step 3:

When a screen as shown in Figure 6 appears, select **AMD AHCI Compatible RAID Controller** and click **Next**.

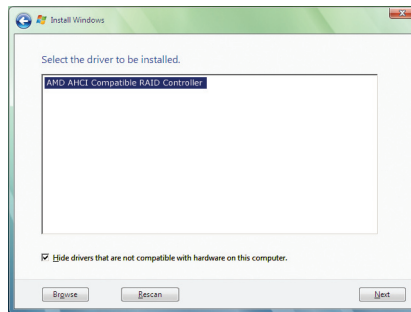

Figure 6

Step 4:

After the driver is loaded, the RAID drive will appear. Select the RAID drive and then click **Next** to continue the OS installation (Figure 7).

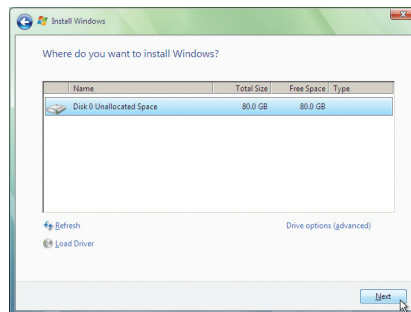

Figure 7

For the GIGABYTE SATA2/JMicron JMB362:

Step 1:

Restart your system to boot from the Windows Vista setup disk and perform standard OS installation steps. When a screen similar to that below appears (RAID/AHCI hard drive(s) will not be detected at this stage), select **Load Driver** (Figure 8).

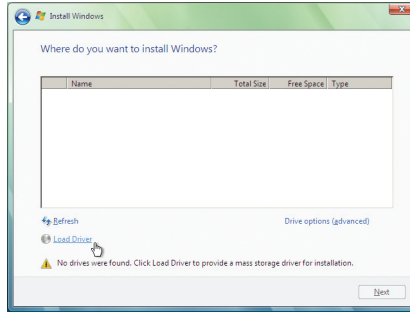

Figure 8

Step 2:

Insert the motherboard driver disk (Method A) or the floppy disk/USB flash drive that contains the SATA RAID/AHCI driver (Method B), then specify the location of the driver (Figure 9). Note: For users using a SATA optical drive, be sure to copy the driver files from the motherboard driver disk to a USB flash drive before installing Windows Vista (go to the **BootDrv** folder and save the whole **GSATA** folder to the USB flash drive). Then use Method B to load the driver.

Method A:

Insert the motherboard driver disk into your system and browse to the following directory:

\BootDrv\GSATA\32Bit

For Windows Vista 64-bit, browse to the **64Bit** folder.

Method B:

Insert the USB flash drive containing the driver files and browse to **\GSATA\32Bit** (for Windows Vista 32-bit) or **\GSATA\64Bit** (for Windows Vista 64-bit).

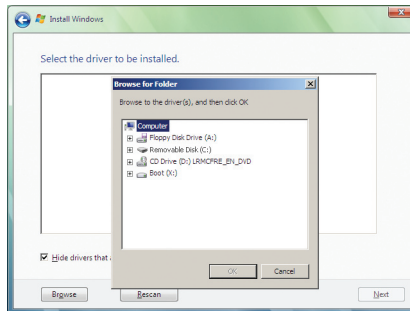

Figure 9

Step 3:

When a screen as shown in Figure 10 appears, select **GIGABYTE GBB36X Controller (A:\vraid_4.inf)** and click **Next**.

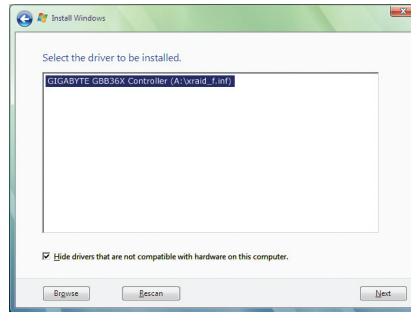

Figure 10

Step 4:

After the driver is loaded, select the RAID/AHCI drive(s) where you want to install the operating system and then click **Next** to continue the OS installation (Figure 11).

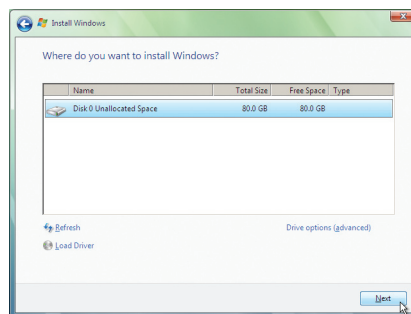

Figure 11

Rebuilding an Array:

Rebuilding is the process of restoring data to a hard drive from other drives in the array. Rebuilding applies only to fault-tolerant arrays such as RAID 1, RAID 5, or RAID 10. To replace the old drive, make sure to use a new drive of equal or greater capacity. The procedures below assume a new drive is added to replace a failed drive to rebuild a RAID 1 array.

For the AMD SB850:

While in the operating system, make sure the chipset drivers have been installed from the motherboard driver disk. Then launch the **AMD RAIDxpert** from **All Programs** in the **Start Menu**.

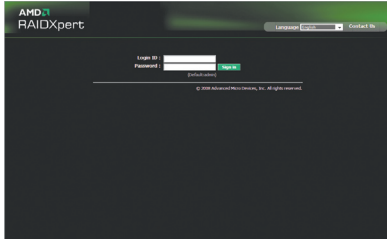

Step 1:
Enter the login ID and password (default: "admin"), and then click **Sign in** to launch **AMD RAIDxpert**.

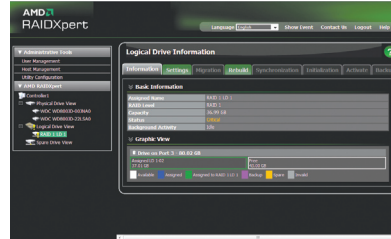

Step 2:
Select the RAID array to be rebuilt under **Logical Drive View** and click the **Rebuild** tab in the **Logical Drive Information** pane.

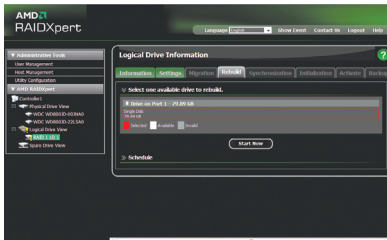

Step 3:
Select one available drive and click **Start Now** to start the rebuilding process.



Step 4:
The rebuilding progress is displayed on the screen and you can select **Pause/Resume/Abort/Restart** during the rebuilding process.

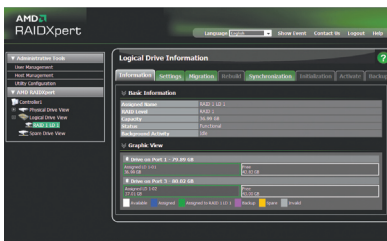

Step 5:
When done, the array's status on the **Information** page in the **Logical Drive Information** pane will display as **Functional**.

For the GIGABYTE SATA2/JMicron JMB362:

Turn off your computer and replace the failed hard drive with a new one. Use either the RAID setup utility or the GIGABYTE RAID CONFIGURER utility in the operating system to perform the rebuild.

• **Rebuilding with the RAID setup utility**

Step 1:

When the message "Press <Ctrl-G> to enter RAID Setup Utility" appears, press <Ctrl> + <G> to enter the utility. In the **Main Menu** block, select **Rebuild Mirror Drive** and press <Enter>. The selection bar will move to the degraded array. Press <Enter> again.

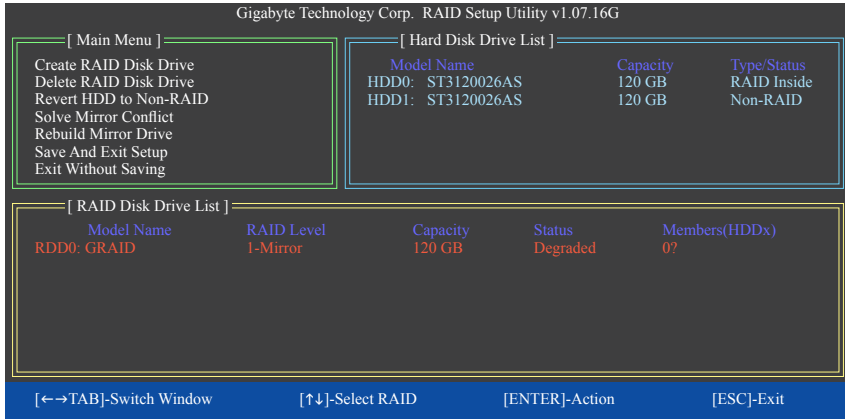

Step 2:

The selection bar will then move to new hard drive in the **Hard Disk Drive List** block. Press <Enter> to start the RAID rebuilding process. The rebuilding progress is displayed at the bottom of the screen. When done, the status of the array will display as **Normal**.

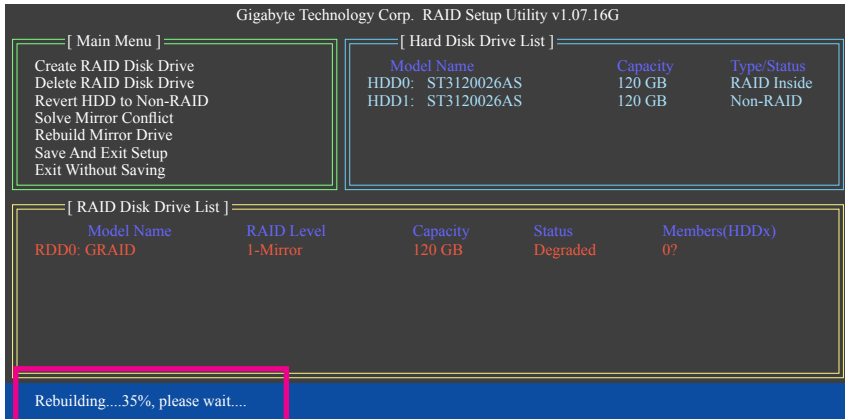

- **Rebuilding in the operating system**

Make sure the GIGABYTE SATA2/JMicron JMB362 SATA controller driver has been installed from the motherboard driver disk. Launch the GIGABYTE RAID CONFIGURER from **All Programs** in the **Start** menu.

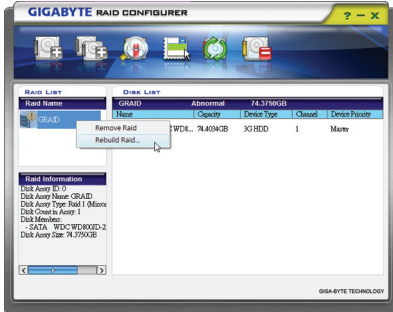

Step 1:

In the GIGABYTE RAID CONFIGURER screen, right-click on the array to be rebuilt in the **RAID LIST** block. Select **Rebuild Raid**. (Or click the **Rebuild** icon  in the tool bar.)



Step 2:

When the Rebuilding RAID Wizard appears, click **Next**.

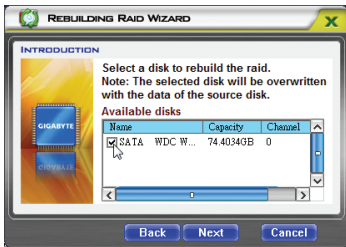

Step 3:

Select a drive to rebuild the array and click **Next**.



Step 4:

Click **Finish** to start the RAID rebuilding process.



Step 5:

The rebuilding progress is displayed at the bottom of the screen.

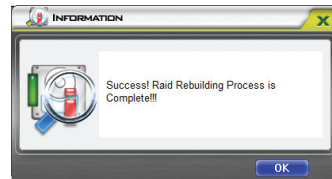

Step 6:

When finished, restart your system.

5-2 Configuring Audio Input and Output

5-2-1 Configuring 2/4/5.1/7.1-Channel Audio

The motherboard provides six audio jacks on the back panel which support 2/4/5.1/7.1-channel ^(Note) audio. The picture to the right shows the default audio jack assignments.

The integrated HD (High Definition) audio provides jack retasking capability that allows the user to change the function for each jack through the audio driver.

For example, in a 4-channel audio configuration, if a Side speaker is plugged into the default Center/Subwoofer speaker out jack, you can retask the Center/Subwoofer speaker out jack to be Side speaker out.



- To install a microphone, connect your microphone to the Mic in jack and manually configure the jack for microphone functionality.
- Audio signals will be present on both of the front and back panel audio connections simultaneously. If you want to mute the back panel audio (only supported when using an HD front panel audio module), refer to instructions on the next page.

High Definition Audio (HD Audio)

HD Audio includes multiple high quality digital-to-analog converters (DACs) that support 44.1KHz/48KHz/96KHz/192KHz sampling rate. HD Audio features multistreaming capabilities that allow multiple audio streams (in and out) to be simultaneously processed. For example, users can listen to MP3 music, have an Internet chat, make a telephone call over the Internet, and etc. all at the same time.

A. Configuring Speakers

(The following instructions use Windows Vista as the example operating system.)

Step 1:

After installing the audio driver, the **HD Audio Manager** icon  will appear in the notification area. Double-click the icon to access the **HD Audio Manager**.

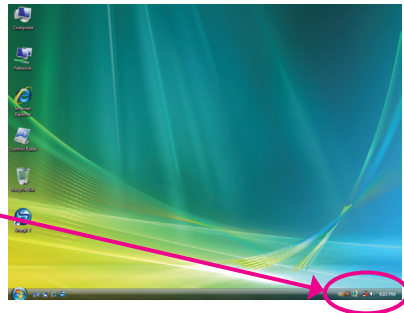

(Note) 2/4/5.1/7.1-Channel Audio Configurations:

Refer to the following for multi-channel speaker configurations.

- 2-channel audio: Headphone or Line out.
- 4-channel audio: Front speaker out and Side speaker out.
- 5.1-channel audio: Front speaker out, Side speaker out, and Center/Subwoofer speaker out.
- 7.1-channel audio: Front speaker out, Rear speaker out, Center/Subwoofer speaker out, and Side speaker out.

Step 2:

Connect an audio device to an audio jack. The **The current connected device is** dialog box appears. Select the device according to the type of device you connect. Then click **OK**.

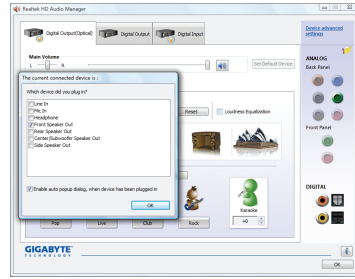

Step 3:

On the **Speakers** screen, click the **Speaker Configuration** tab. In the **Speaker Configuration** list, select **Stereo**, **Quadraphonic**, **5.1 Speaker**, or **7.1 Speaker** according to the type of speaker configuration you wish to set up. Then the speaker setup is completed.

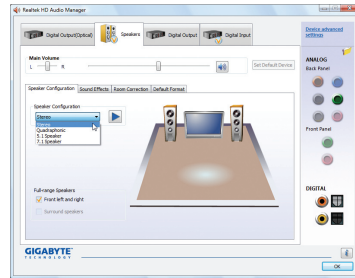

B. Configuring Sound Effect

You may configure an audio environment on the **Sound Effects** tab.

C. Activating an AC'97 Front Panel Audio Module

If your chassis provides an AC'97 front panel audio module, to activate the AC'97 functionality, click the tool icon on the **Speaker Configuration** tab. On the **Connector Settings** dialog box, select the **Disable front panel jack detection** check box. Click **OK** to complete.

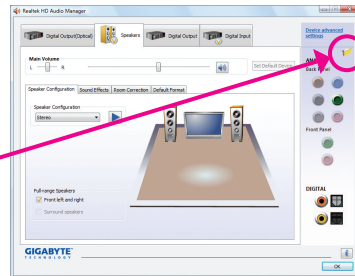
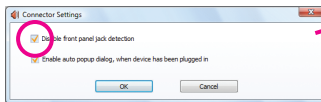

D. Muting the Back Panel Audio (For HD Audio Only)

Click **Device advanced settings** on the top right corner on the **Speaker Configuration** tab to open the **Device advanced settings** dialog box. Select the **Mute the rear output device, when a front headphone plugged in** check box. Click **OK** to complete.

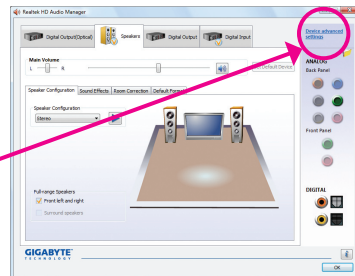
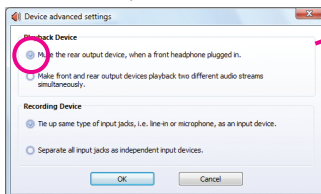

5-2-2 Configuring S/PDIF In/Out

A. S/PDIF In

The S/PDIF In cable (optional) allows you to input digital audio signals to the computer for audio processing.

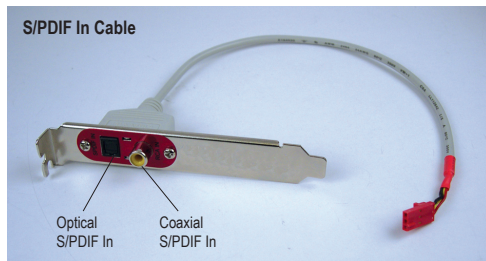

1. Installing the S/PDIF In Cable:

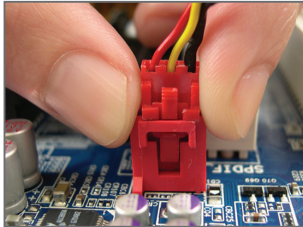

Step 1:
First, attach the connector at the end of the cable to the SPDIF_IN header on your motherboard.

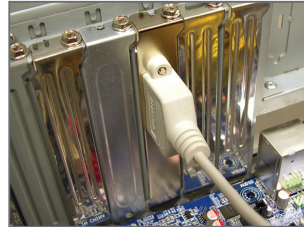

Step 2:
Secure the metal bracket to the chassis back panel with a screw.

2. Configuring S/PDIF In:

On the **Digital Input** screen, click the **Default Format** tab to select the default format. Click **OK** to complete.

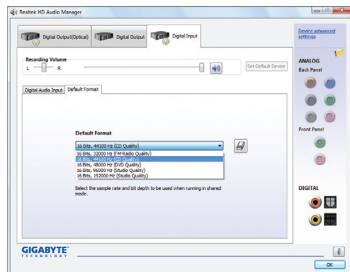

(Note) The actual locations of the S/PDIF In and S/PDIF Out connectors may differ by model.

B. S/PDIF Out

The S/PDIF Out jacks can transmit audio signals to an external decoder for decoding to get the best audio quality.

1. Connecting a S/PDIF Out Cable:

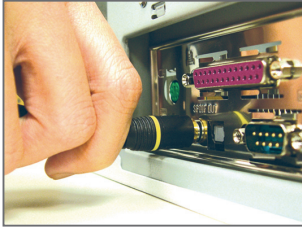

S/PDIF Coaxial Cable

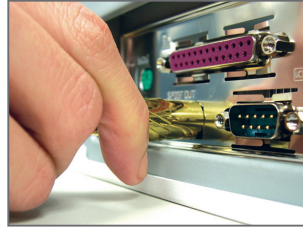

S/PDIF Optical Cable

Connect a S/PDIF coaxial cable or a S/PDIF optical cable (either one) to an external decoder for transmitting the S/PDIF digital audio signals.

2. Configuring S/PDIF Out:

On the **Digital Output(Optical)** screen ^(Note), click the **Default Format** tab and then select the sample rate and bit depth. Click **OK** to complete.

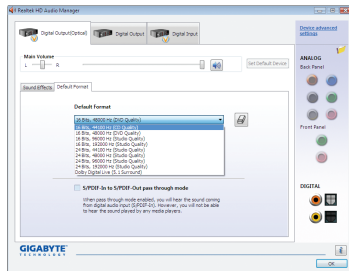

(Note) Enter the **Digital Output(Optical)** screen to configure further settings if you use the S/PDIF Out connector(s) on the back panel for digital audio output or enter the **Digital Output** screen if you use the internal S/PDIF Out connector (SPDIF_OUT) for digital audio output.

5-2-3 Enabling the Dolby Home Theater Function



Before Dolby Home Theater is enabled, you get only 2-channel playback output (from the front speakers) when playing 2-channel stereo sources. You must play 4-, 5.1-, or 7.1- channel content to get 4-, 5.1-, or 7.1- channel audio effects. With Dolby Home Theater enabled, 2-channel stereo content will be transformed into multi-channel audio, creating a virtual surround sound environment ^(Note).

Install the **Dolby GUI Software** driver from the motherboard driver disk. Click the **Start** icon . Point to **All Programs, Dolby Control Center** to access the utility.

(The following illustration demonstrates a 7.1-speaker configuration as an example.)

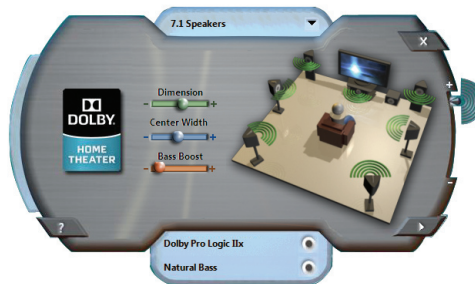

1. **Dolby Pro Logic IIx** :
Click Dolby Pro Logic IIx. The system will expand 2-channel audio for a 7.1-channel surround sound playback.
2. **Natural Bass** :
Click Natural Bass to enable speaker bass effect.

(Note) When Dolby Digital Live is enabled, only digital audio output (S/PDIF) is working, and you will not hear any sound from analog speakers or headphone.

5-2-4 Configuring Microphone Recording

Step 1:

After installing the audio driver, the **HD Audio Manager** icon  will appear in the notification area. Double-click the icon to access the **HD Audio Manager**.

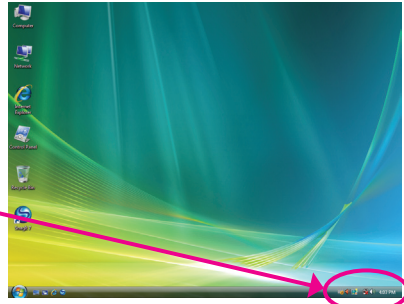

Step 2:

Connect your microphone to the Mic in jack (pink) on the back panel or the Mic in jack (pink) on the front panel. Then configure the jack for microphone functionality.

Note: The microphone functions on the front panel and back panel cannot be used at the same time.

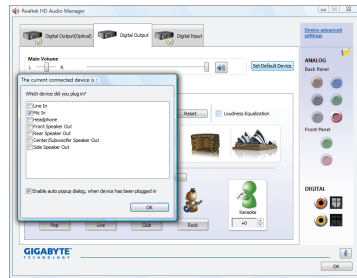

Step 3:

Go to the **Microphone** screen. Do not mute the recording volume, or you'll not be able to record the sound. To hear the sound being recorded during the recording process, do not mute the playback volume. It is recommended that you set the volumes at a middle level.

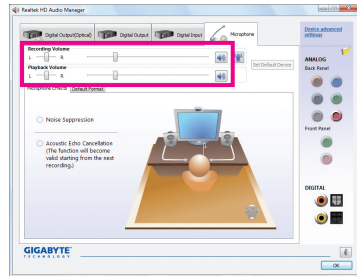

If you want to change the current sound input default device to microphone, right-click on **Microphone** and select **Set Default Device**.

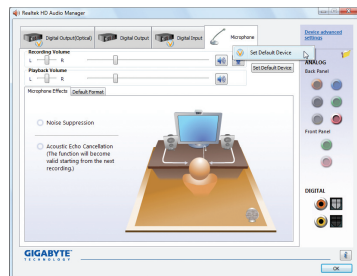

Step 4:

To raise the recording and playback volume for the microphone, click the **Microphone Boost** icon  on the right of the **Recording Volume** slider and set the Microphone Boost level.

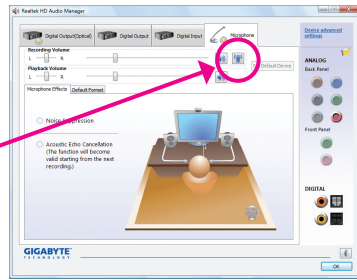

Step 5:

After completing the settings above, click **Start**, point to **All Programs**, point to **Accessories**, and then click **Sound Recorder** to begin the sound recording.

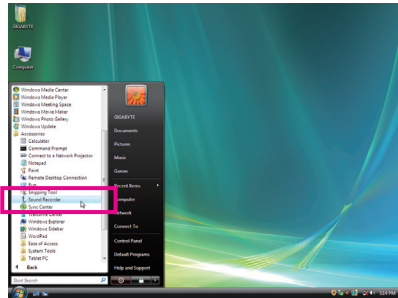

* Enabling Stereo Mix

If the HD Audio Manager does not display the recording device you wish to use, refer to the steps below. The following steps explain how to enable Stereo Mix (which may be needed when you want to record sound from your computer).

Step 1:

Locate the **Volume** icon  in the notification area and right-click on this icon. Select **Recording Devices**.

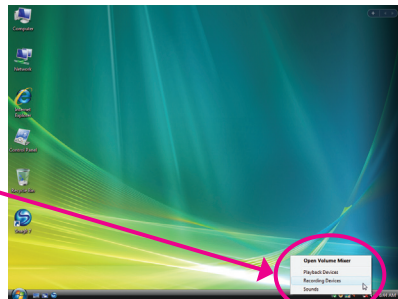

Step 2:

On the **Recording** tab, right-click on an empty space and select **Show Disabled Devices**.

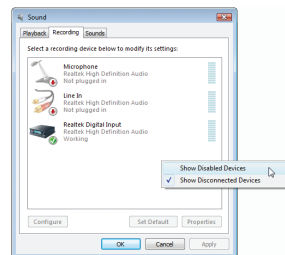

Step 3:

When the **Stereo Mix** item appears, right-click on this item and select **Enable**. Then set it as the default device.

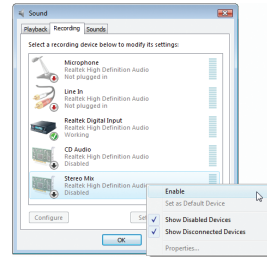

Step 4:

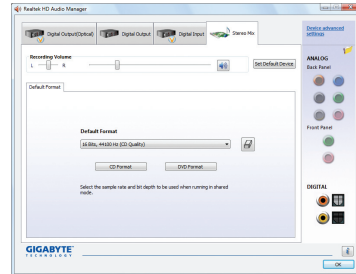

Now you can access the **HD Audio Manager** to configure **Stereo Mix** and use **Sound Recorder** to record the sound.

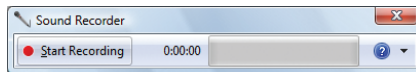

5-2-5 Using the Sound Recorder



A. Recording Sound

1. Make sure you have connected the sound input device (e.g. microphone) to the computer.
2. To record the audio, click the **Start Recording** button .
3. To stop recording audio, click the **Stop Recording** button .

Be sure to save the recorded audio file upon completion.

B. Playing the Recorded Sound

You can play your recording in a digital media player program that supports your audio file format.

5-3 Troubleshooting

5-3-1 Frequently Asked Questions

To read more FAQs for your motherboard, please go to the **Support & Downloads\FAQ** page on GIGABYTE's website.

Q: In the BIOS Setup program, why are some BIOS options missing?

A: Some advanced options are hidden in the BIOS Setup program. Press <Delete> to enter BIOS Setup during the POST. In the Main Menu, press <Ctrl>+<F1> to show the advanced options.

Q: Why is the light of my keyboard/optical mouse still on after the computer shuts down?

A: Some motherboards provide a small amount of standby power after the computer shuts down and that's why the light is still on.

Q: How do I clear the CMOS values?

A: For motherboards that have a CMOS_SW button, press this button to clear the CMOS values (before doing this, please turn off the computer and unplug the power cord). For motherboards that have a clearing CMOS jumper, refer to the instructions on the CLR_CMOS jumper in Chapter 1 to short the jumper to clear the CMOS values. If your board doesn't have this jumper, refer to the instructions on the motherboard battery in Chapter 1. You can temporarily remove the battery from the battery holder to stop supplying power to the CMOS, which will clear the CMOS values after about one minute.

Q: Why do I still get a weak sound even though I have turned my speaker to the maximum volume?

A: Make sure your speaker is equipped with an internal amplifier. If not, try a speaker with power/amplifier.

Q: Why cannot I install the onboard HD audio driver successfully? (For Windows XP only)

A: Step 1: First, make sure Service Pack 1 or Service Pack 2 has been installed (check in My Computer > Properties > General > System). If not, please update it from Microsoft's website. Then make sure the Microsoft UAA Bus Driver for High Definition Audio has been installed successfully (check in My Computer > Properties > Hardware > Device Manager > System Devices).

Step 2: Check if **Audio Device on High Definition Audio Bus** or **Unknown device** is present in **Device Manager** or **Sound, video, and game controllers**. If yes, please disable this device. (If not, skip this step.)

Step 3: Then go back to My Computer > Properties > Hardware > Device Manager > System devices and right-click on **Microsoft UAA Bus Driver for High Definition Audio** and select **Disable** and **Uninstall**.

Step 4: In **Device Manager**, right-click on the computer name and select **Scan for hardware changes**. When the **Add New Hardware Wizard** appears, click **Cancel**. Then install the onboard HD audio driver from the motherboard driver disk or download the audio driver from GIGABYTE's website to install.

For more details, go to the **Support & Downloads\FAQ** page on our website and search for "onboard HD audio driver."

Q: What do the beeps emitted during the POST mean?

A: The following Award BIOS beep code descriptions may help you identify possible computer problems.

(For reference only.)

1 short: System boots successfully

1 long, 9 short: BIOS ROM error

2 short: CMOS setting error

Continuous long beeps: Graphics card not inserted properly

1 long, 1 short: Memory or motherboard error

Continuous short beeps: Power error

1 long, 2 short: Monitor or graphics card error

1 long, 3 short: Keyboard error

5-3-2 Troubleshooting Procedure

If you encounter any troubles during system startup, follow the troubleshooting procedure below to solve the problem.

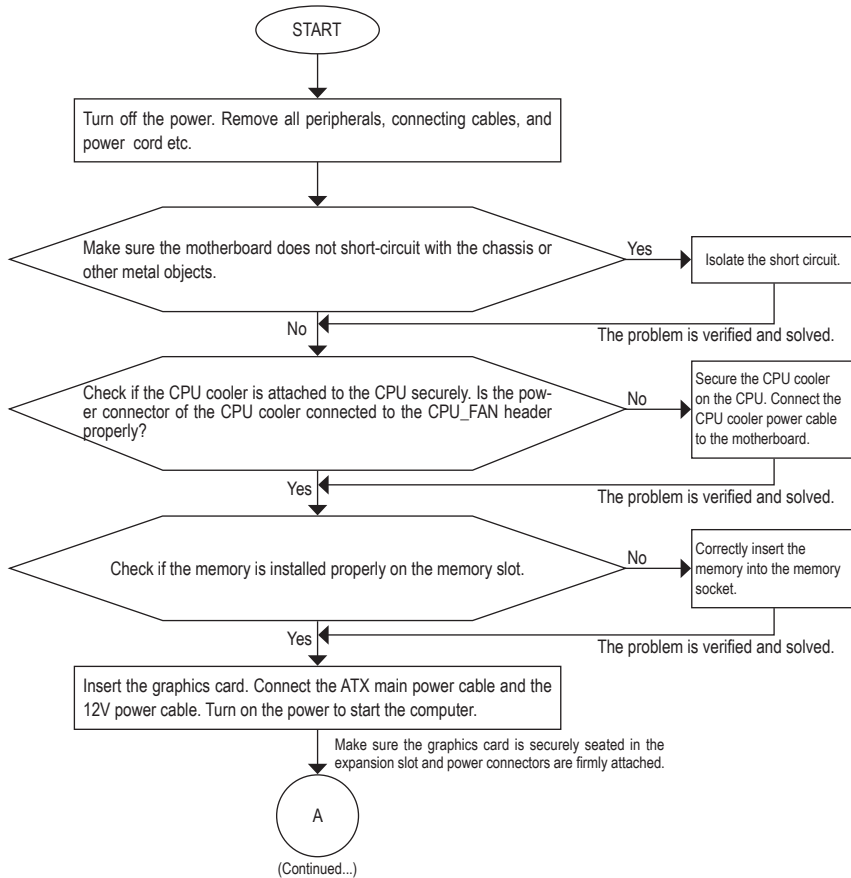

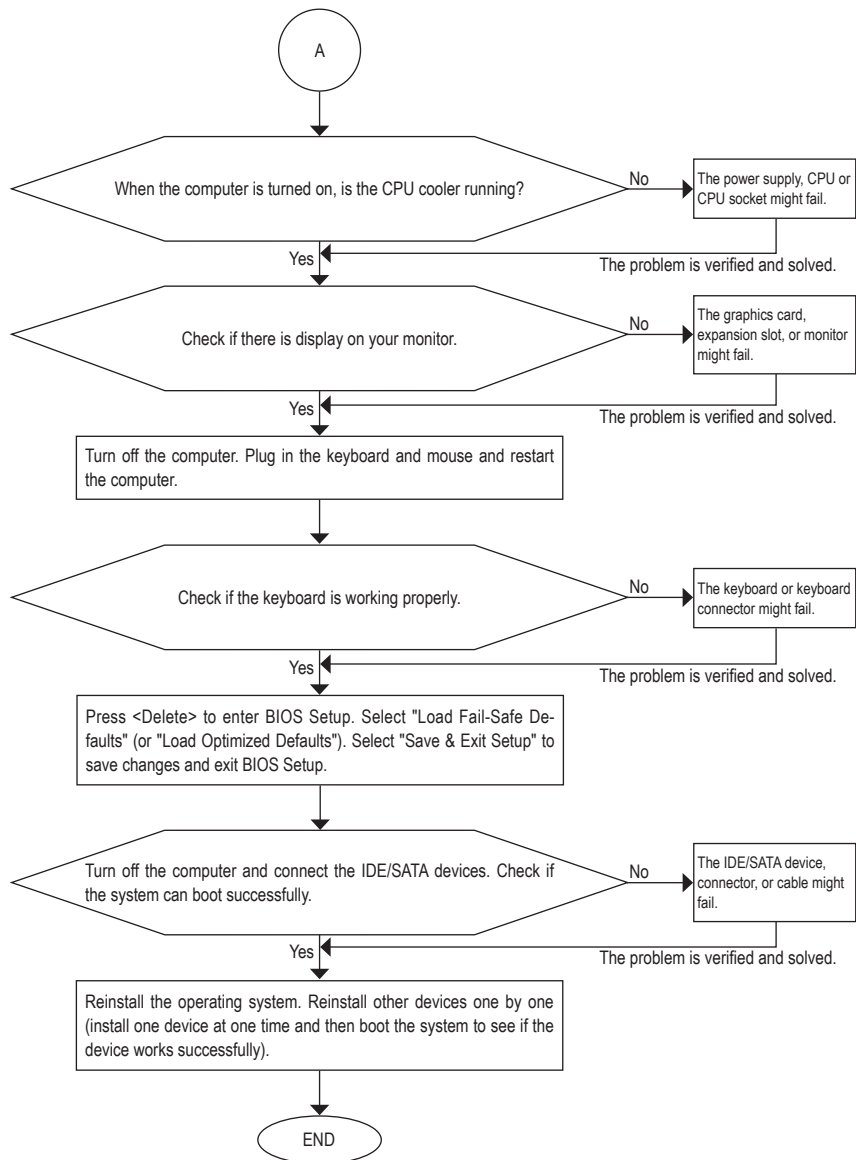

If the procedure above is unable to solve your problem, contact the place of purchase or local dealer for help. Or go to the **Support & Downloads** **Technical Support** page to submit your question. Our customer service staff will reply you as soon as possible.



Contact Us

- **GIGA-BYTE TECHNOLOGY CO., LTD.**

Address: No.6, Bau Chiang Road, Hsin-Tien,

Taipei 231, Taiwan

TEL: +886-2-8912-4000

FAX: +886-2-8912-4003

Tech. and Non-Tech. Support (Sales/Marketing) :

<http://ggts.gigabyte.com.tw>

WEB address (English): <http://www.gigabyte.com>

WEB address (Chinese): <http://www.gigabyte.tw>

- **G.B.T. INC. - U.S.A.**

TEL: +1-626-854-9338

FAX: +1-626-854-9339

Tech. Support:

<http://rma.gigabyte.us>

Web address: <http://www.gigabyte.us>

- **G.B.T. INC (USA) - Mexico**

Tel: +1-626-854-9338 x 215 (Soporte de habla hispano)

FAX: +1-626-854-9339

Correo: soporte@gigabyte-usa.com

Tech. Support:

<http://rma.gigabyte.us>

Web address: <http://atam.giga-byte.com>

- **Giga-Byte SINGAPORE PTE. LTD. - Singapore**

WEB address : <http://www.gigabyte.sg>

- **Thailand**

WEB address : <http://th.giga-byte.com>

- **Vietnam**

WEB address : <http://www.gigabyte.vn>

- **NINGBO G.B.T. TECH. TRADING CO., LTD. - China**

WEB address : <http://www.gigabyte.cn>

- Shanghai**

TEL: +86-21-63410999

FAX: +86-21-63410100

- Beijing**

TEL: +86-10-62102838

FAX: +86-10-62102848

- Wuhan**

TEL: +86-27-87851061

FAX: +86-27-87851330

- GuangZhou**

TEL: +86-20-87540700

FAX: +86-20-87544306

- Chengdu**

TEL: +86-28-85236930

FAX: +86-28-85256822

- Xian**

TEL: +86-29-85531943

FAX: +86-29-85510930

- Shenyang**

TEL: +86-24-83992901

FAX: +86-24-83992909

- **GIGABYTE TECHNOLOGY (INDIA) LIMITED - India**

WEB address : <http://www.gigabyte.in>

- **Saudi Arabia**

WEB address : <http://www.gigabyte.com.sa>

- **Gigabyte Technology Pty. Ltd. - Australia**

WEB address : <http://www.gigabyte.com.au>

- **G.B.T. TECHNOLOGY TRADING GMBH - Germany**

WEB address : <http://www.gigabyte.de>

- **G.B.T. TECH. CO., LTD. - U.K.**

WEB address : <http://www.giga-byte.co.uk>

- **Giga-Byte Technology B.V. - The Netherlands**

WEB address : <http://www.giga-byte.nl>

- **GIGABYTE TECHNOLOGY FRANCE - France**

WEB address : <http://www.gigabyte.fr>

- **Sweden**

WEB address : <http://www.gigabyte.se>

- **Italy**

WEB address : <http://www.giga-byte.it>

- **Spain**

WEB address : <http://www.giga-byte.es>

- **Greece**

WEB address : <http://www.gigabyte.com.gr>

- **Czech Republic**

WEB address : <http://www.gigabyte.cz>

- **Hungary**

WEB address : <http://www.giga-byte.hu>

- **Turkey**

WEB address : <http://www.gigabyte.com.tr>

- **Russia**

WEB address : <http://www.gigabyte.ru>

- **Poland**

WEB address : <http://www.gigabyte.pl>

- **Ukraine**

WEB address : <http://www.gigabyte.ua>

- **Romania**

WEB address : <http://www.gigabyte.com.ro>

- **Serbia**

WEB address : <http://www.gigabyte.co.rs>

- **Kazakhstan**

WEB address : <http://www.gigabyte.kz>

You may go to the GIGABYTE website, select your language in the language list on the top right corner of the website.

- **GIGABYTE Global Service System**



To submit a technical or non-technical (Sales/Marketing) question, please link to:

<http://ggts.gigabyte.com.tw>

Then select your language to enter the system.