

G1.Sniper M3

User's Manual

Rev. 1003

12ME-G1SNPM3-1003R

Declaration of Conformity

We, Manufacturer/Importer,

G.B.T. Technology Trading GmbH

Address: **Bullenkoppel 16, 22047 Hamburg, Germany**

Declare that the product

Product Type: **Motherboard**

Product Name: **G1.Sniper M3**

conforms with the essential requirements of the following directives:

2004/108/EC EMC Directive:

Conduction & Radiated Emissions: EN55022:2006+A1:2007

Immunity: EN55024:1998+A1:2001+A2:2003

Power-line Harmonics: EN61000-3-2:2006

Power-line flicker: EN61000-3-3:2008

2006/95/EC LVD Directive

Safety: EN60950-1:2006+A11:2009

2011/65/EU RoHS Directive

Restriction of use of certain substances in electronic equipment: This product does not contain any of the restricted substances listed in Annex II, in concentrations and applications banned by the directive.

CE marking



(EC conformity marking)

Signature: Timmy Huang

(Name)

Date: Mar 15, 2012

Name:

Timmy Huang

DECLARATION OF CONFORMITY

Per FCC Part 2 Section 2.1077(a)



Responsible Party Name: **G.B.T. INC. (U.S.A)**

Address: **17358 Railroad Street**

City of Industry, CA 91748

Phone/Fax No: (626) 854-9338/ (626) 854-9326

hereby declares that the product

Product Name: Motherboard

Model Number: G1.Sniper M3

Conforms to the following specifications:

FCC Part 15, Subpart B, Section 15.107(a) and Section 15.109

(a), Class B Digital Device

Supplementary Information:

This device complies with part 15 of the FCC Rules. Operation is subject to the following two conditions: (1) This device may not cause harmful and (2) this device must accept any interference received, including that may cause undesired operation.

Representative Person's Name: ERIC LU

Signature: Eric Lu

Date: Mar 15, 2012

Copyright

© 2012 GIGA-BYTE TECHNOLOGY CO., LTD. All rights reserved.

The trademarks mentioned in this manual are legally registered to their respective owners.

Disclaimer

Information in this manual is protected by copyright laws and is the property of GIGABYTE. Changes to the specifications and features in this manual may be made by GIGABYTE without prior notice. No part of this manual may be reproduced, copied, translated, transmitted, or published in any form or by any means without GIGABYTE's prior written permission.

Documentation Classifications

In order to assist in the use of this product, GIGABYTE provides the following types of documentations:

- For quick set-up of the product, read the Quick Installation Guide included with the product.
- For detailed product information, carefully read the User's Manual.

For product-related information, check on our website at: <http://www.gigabyte.com>

Identifying Your Motherboard Revision

The revision number on your motherboard looks like this: "REV: X.X." For example, "REV: 1.0" means the revision of the motherboard is 1.0. Check your motherboard revision before updating motherboard BIOS, drivers, or when looking for technical information.

Example:

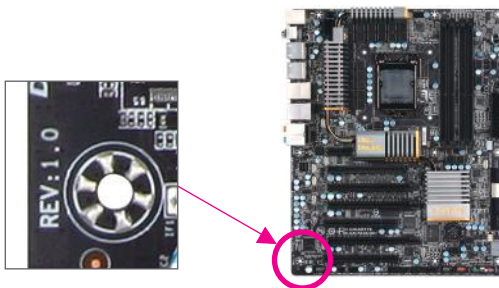

Table of Contents

Box Contents	6
Optional Items	6
G1.Sniper M3 Motherboard Layout	7
G1.Sniper M3 Motherboard Block Diagram	8
Chapter 1 Hardware Installation	9
1-1 Installation Precautions	9
1-2 Product Specifications	10
1-3 Installing the CPU and CPU Cooler.....	13
1-3-1 Installing the CPU	13
1-3-2 Installing the CPU Cooler	15
1-4 Installing the Memory	16
1-4-1 Dual Channel Memory Configuration	16
1-4-2 Installing a Memory.....	17
1-5 Installing an Expansion Card.....	18
1-6 Setting up AMD CrossFireX™/NVIDIA SLI Configuration.....	19
1-7 Back Panel Connectors	20
1-8 Internal Connectors	23
Chapter 2 BIOS Setup	31
2-1 Startup Screen.....	32
2-2 The Main Menu	33
2-3 M.I.T.	35
2-4 System	45
2-5 BIOS Features	46
2-6 Peripherals.....	48
2-7 Power Management.....	51
2-8 Save & Exit	53
Chapter 3 Drivers Installation	55
3-1 Installing Chipset Drivers.....	55
3-2 Application Software.....	56
3-3 Technical Manuals	56

3-4	Contact.....	57
3-5	System.....	57
3-6	Download Center.....	58
3-7	New Program.....	58
Chapter 4 Unique Features.....		59
4-1	Xpress Recovery2.....	59
4-2	BIOS Update Utilities.....	62
4-2-1	Updating the BIOS with the Q-Flash Utility.....	62
4-2-2	Updating the BIOS with the @BIOS Utility.....	65
4-3	EasyTune 6.....	66
4-4	Q-Share.....	67
4-5	eXtreme Hard Drive (X.H.D).....	68
4-6	Auto Green.....	69
4-7	Intel Rapid Start Technology.....	70
4-8	Intel Smart Connect Technology.....	72
4-9	Intel Smart Response.....	74
Chapter 5 Appendix.....		77
5-1	Configuring SATA Hard Drive(s).....	77
5-1-1	Configuring SATA Controllers.....	77
5-1-2	Installing the SATA RAID/AHCI Driver and Operating System.....	85
5-2	Configuring Audio Input and Output.....	88
5-2-1	Configuring 2/5.1-Channel Audio.....	88
5-2-2	Creative Software Suite.....	88
5-2-3	Configuring S/PDIF Out.....	92
5-2-4	Configuring Audio Recording.....	93
5-2-5	Using the Sound Recorder.....	95
5-3	Troubleshooting.....	96
5-3-1	Frequently Asked Questions.....	96
5-3-2	Troubleshooting Procedure.....	97
5-4	Regulatory Statements.....	99

Box Contents

- G1.Sniper M3 motherboard
- Motherboard driver disk
- User's Manual
- Quick Installation Guide
- Six SATA 6Gb/s cables
- I/O Shield
- One 2-Way SLI bridge connector

The box contents above are for reference only and the actual items shall depend on the product package you obtain. The box contents are subject to change without notice.

Optional Items

- 2-port USB 2.0 bracket (Part No. 12CR1-1UB030-5*R)
- 2-port SATA power cable (Part No. 12CF1-2SERPW-0*R)
- 3.5" Front Panel with 2 USB 3.0/2.0 ports (Part No. 12CR1-FPX582-0*R)

G1.Sniper M3 Motherboard Layout

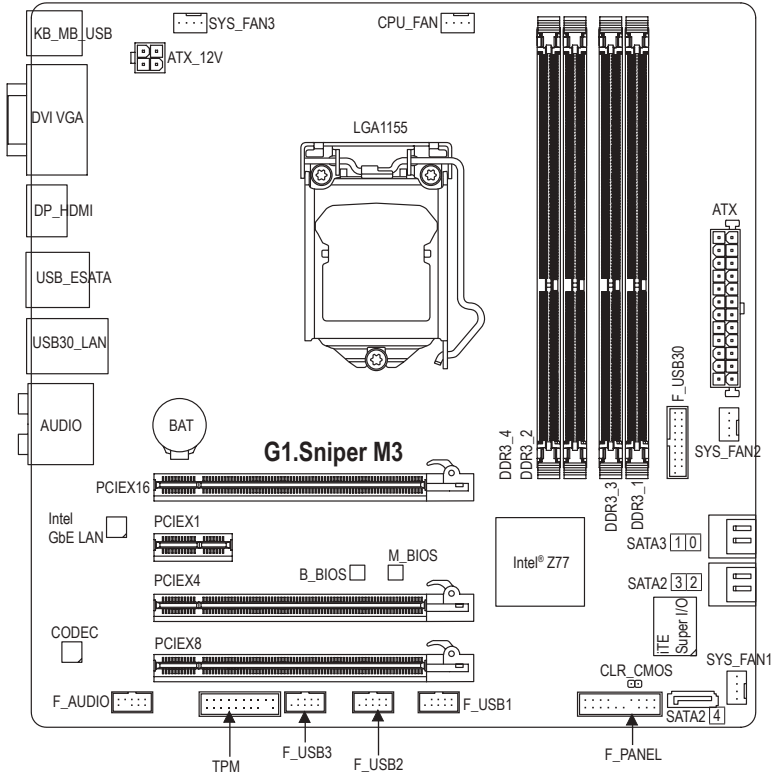

G1.Sniper M3 Motherboard Block Diagram

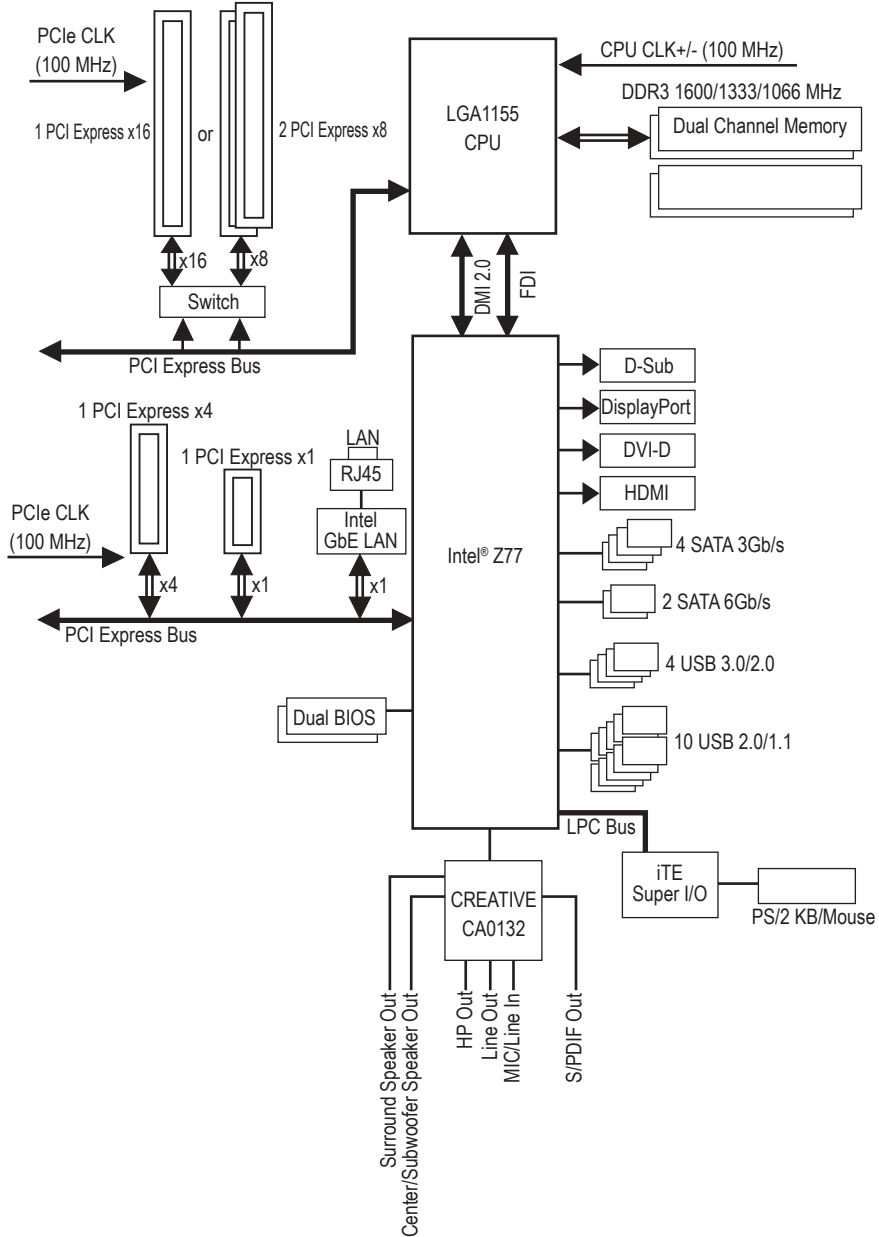

For detailed product information/limitation(s), refer to "1-2 Product Specifications."









Chapter 1 Hardware Installation





1-1 Installation Precautions







The motherboard contains numerous delicate electronic circuits and components which can become damaged as a result of electrostatic discharge (ESD). Prior to installation, carefully read the user's manual and follow these procedures:

- Prior to installation, make sure the chassis is suitable for the motherboard.
- Prior to installation, do not remove or break motherboard S/N (Serial Number) sticker or warranty sticker provided by your dealer. These stickers are required for warranty validation.
- Always remove the AC power by unplugging the power cord from the power outlet before installing or removing the motherboard or other hardware components.
- When connecting hardware components to the internal connectors on the motherboard, make sure they are connected tightly and securely.
- When handling the motherboard, avoid touching any metal leads or connectors.
- It is best to wear an electrostatic discharge (ESD) wrist strap when handling electronic components such as a motherboard, CPU or memory. If you do not have an ESD wrist strap, keep your hands dry and first touch a metal object to eliminate static electricity.
- Prior to installing the motherboard, please have it on top of an antistatic pad or within an electrostatic shielding container.
- Before unplugging the power supply cable from the motherboard, make sure the power supply has been turned off.
- Before turning on the power, make sure the power supply voltage has been set according to the local voltage standard.
- Before using the product, please verify that all cables and power connectors of your hardware components are connected.
- To prevent damage to the motherboard, do not allow screws to come in contact with the motherboard circuit or its components.
- Make sure there are no leftover screws or metal components placed on the motherboard or within the computer casing.
- Do not place the computer system on an uneven surface.
- Do not place the computer system in a high-temperature environment.
- Turning on the computer power during the installation process can lead to damage to system components as well as physical harm to the user.
- If you are uncertain about any installation steps or have a problem related to the use of the product, please consult a certified computer technician.

1-2 Product Specifications

	CPU	<ul style="list-style-type: none"> ◆ Support for Intel® Core™ i7 processors/Intel® Core™ i5 processors/Intel® Core™ i3 processors/Intel® Pentium® processors/Intel® Celeron® processors in the LGA1155 package (Go to GIGABYTE's website for the latest CPU support list.) ◆ L3 cache varies with CPU
	Chipset	<ul style="list-style-type: none"> ◆ Intel® Z77 Express Chipset
	Memory	<ul style="list-style-type: none"> ◆ 4 x 1.5V DDR3 DIMM sockets supporting up to 32 GB of system memory <ul style="list-style-type: none"> * Due to Windows 32-bit operating system limitation, when more than 4 GB of physical memory is installed, the actual memory size displayed will be less than 4 GB. ◆ Dual channel memory architecture ◆ Support for DDR3 1600/1333/1066 MHz memory modules ◆ Support for non-ECC memory modules ◆ Support for Extreme Memory Profile (XMP) memory modules (Go to GIGABYTE's website for the latest supported memory speeds and memory modules.)
	Onboard Graphics	<ul style="list-style-type: none"> ◆ Chipset: <ul style="list-style-type: none"> - 1 x D-Sub port - 1 x DVI-D port, supporting a maximum resolution of 1920x1200 <ul style="list-style-type: none"> * The DVI-D port does not support D-Sub connection by adapter. - 1 x HDMI port, supporting a maximum resolution of 1920x1200 - 1 x DisplayPort, supporting a maximum resolution of 2560x1600
	Audio	<ul style="list-style-type: none"> ◆ Creative CA0132 chip ◆ Support for Sound Blaster Recon3Di ◆ High Definition Audio ◆ 2/5.1-channel ◆ Support for S/PDIF Out
	LAN	<ul style="list-style-type: none"> ◆ Intel GbE LAN chip (10/100/1000 Mbit)
	Expansion Slots	<ul style="list-style-type: none"> ◆ 1 x PCI Express x16 slot, running at x16 (PCIEX16) <ul style="list-style-type: none"> * For optimum performance, if only one PCI Express graphics card is to be installed, be sure to install it in the PCIEX16 slot. ◆ 1 x PCI Express x16 slot, running at x8 (PCIEX8) (The PCIEX16 and PCIEX8 slots conform to PCI Express 3.0 standard.) <ul style="list-style-type: none"> * The PCIEX8 slot shares bandwidth with the PCIEX16 slot. When the PCIEX8 slot is populated, the PCIEX16 slot will operate at up to x8 mode. * To support PCI Express 3.0, you must install an Intel 22nm (Ivy Bridge) CPU. ◆ 1 x PCI Express x16 slot, running at x4 (PCIEX4) ◆ 1 x PCI Express x1 slot (PCIEX4/PCIEX1 slots conform to PCI Express 2.0 standard.)
	Multi-Graphics Technology	<ul style="list-style-type: none"> ◆ Support for 2-Way AMD CrossFireX™/NVIDIA SLI technology (PCIEX16 and PCIEX8)

	Storage Interface ♦	<ul style="list-style-type: none"> ♦ Chipset: <ul style="list-style-type: none"> - 2 x SATA 6Gb/s connectors (SATA3 0/1) supporting up to 2 SATA 6Gb/s devices - 3 x SATA 3Gb/s connectors (SATA2 2~4) supporting up to 3 SATA 3Gb/s devices - 1 x eSATA 3Gb/s connector on the back panel supporting up to 1 SATA 3Gb/s device - Support for RAID 0, RAID 1, RAID 5, and RAID 10 <ul style="list-style-type: none"> * When a RAID set is built across the SATA 6Gb/s and SATA 3Gb/s channels, the system performance of the RAID set may vary depending on the devices being connected.
	USB ♦	<ul style="list-style-type: none"> ♦ Chipset: <ul style="list-style-type: none"> - Up to 4 USB 3.0/2.0 ports (2 ports on the back panel, 2 ports available through the internal USB header) - Up to 10 USB 2.0/1.1 ports (4 ports on the back panel, 6 ports available through the internal USB headers)
	Internal Connectors ♦	<ul style="list-style-type: none"> ♦ 1 x 24-pin ATX main power connector ♦ 1 x 4-pin ATX 12V power connector ♦ 2 x SATA 6Gb/s connectors ♦ 3 x SATA 3Gb/s connectors ♦ 1 x CPU fan header ♦ 3 x System fan headers ♦ 1 x front panel header ♦ 1 x front panel audio header ♦ 1 x USB 3.0/2.0 header ♦ 3 x USB 2.0/1.1 headers ♦ 1 x Clear CMOS jumper ♦ 1 x Trusted Platform Module (TPM) header
	Back Panel Connectors ♦	<ul style="list-style-type: none"> ♦ 1 x PS/2 keyboard/mouse port ♦ 1 x D-Sub port ♦ 1 x DVI-D port ♦ 1 x HDMI port ♦ 1 x DisplayPort ♦ 1 x eSATA 3Gb/s connector ♦ 2 x USB 3.0/2.0 ports ♦ 4 x USB 2.0/1.1 ports ♦ 1 x RJ-45 port ♦ 1 x optical S/PDIF Out connector ♦ 5 x audio jacks (Center/Subwoofer Speaker Out, Rear Speaker Out, Line In/Mic In, Line Out, Headphone)

	I/O Controller	<ul style="list-style-type: none"> ◆ iTE I/O Controller Chip
	Hardware Monitor	<ul style="list-style-type: none"> ◆ System voltage detection ◆ CPU/System temperature detection ◆ CPU/System fan speed detection ◆ CPU overheating warning ◆ CPU/System fan fail warning ◆ CPU/System fan speed control <ul style="list-style-type: none"> * Whether the CPU/system fan speed control function is supported will depend on the CPU/system cooler you install.
	BIOS	<ul style="list-style-type: none"> ◆ 2 x 64 Mbit flash ◆ Use of licensed AMI EFI BIOS ◆ Support for DualBIOS™ ◆ PnP 1.0a, DMI 2.0, SM BIOS 2.6, ACPI 2.0a
	Unique Features	<ul style="list-style-type: none"> ◆ Support for @BIOS ◆ Support for Q-Flash ◆ Support for Xpress Install ◆ Support for Xpress Recovery2 ◆ Support for EasyTune <ul style="list-style-type: none"> * Available functions in EasyTune may differ by motherboard model. ◆ Support for eXtreme Hard Drive (X.H.D) ◆ Support for Auto Green ◆ Support for ON/OFF Charge ◆ Support for Q-Share ◆ Support for 3D Power ◆ Support for EZ Setup
	Bundled Software	<ul style="list-style-type: none"> ◆ Norton Internet Security (OEM version) ◆ Intel® Rapid Start Technology ◆ Intel® Smart Connect Technology ◆ Intel® Smart Response Technology ◆ LucidLogix Virtu MVP <ul style="list-style-type: none"> * Make sure the monitor cable has been connected to the integrated graphics port on the back panel. ◆ cFosSpeed
	Operating System	<ul style="list-style-type: none"> ◆ Support for Microsoft® Windows 7
	Form Factor	<ul style="list-style-type: none"> ◆ Micro ATX Form Factor; 24.4cm x 24.4cm

* GIGABYTE reserves the right to make any changes to the product specifications and product-related information without prior notice.

* Please visit GIGABYTE's website to check the supported operating system(s) for the software listed in the "Unique Features" and "Bundled Software" columns.

1-3 Installing the CPU and CPU Cooler



Read the following guidelines before you begin to install the CPU:

- Make sure that the motherboard supports the CPU.
(Go to GIGABYTE's website for the latest CPU support list.)
- Always turn off the computer and unplug the power cord from the power outlet before installing the CPU to prevent hardware damage.
- Locate the pin one of the CPU. The CPU cannot be inserted if oriented incorrectly. (Or you may locate the notches on both sides of the CPU and alignment keys on the CPU socket.)
- Apply an even and thin layer of thermal grease on the surface of the CPU.
- Do not turn on the computer if the CPU cooler is not installed, otherwise overheating and damage of the CPU may occur.
- Set the CPU host frequency in accordance with the CPU specifications. It is not recommended that the system bus frequency be set beyond hardware specifications since it does not meet the standard requirements for the peripherals. If you wish to set the frequency beyond the standard specifications, please do so according to your hardware specifications including the CPU, graphics card, memory, hard drive, etc.

1-3-1 Installing the CPU

- A. Locate the alignment keys on the motherboard CPU socket and the notches on the CPU.

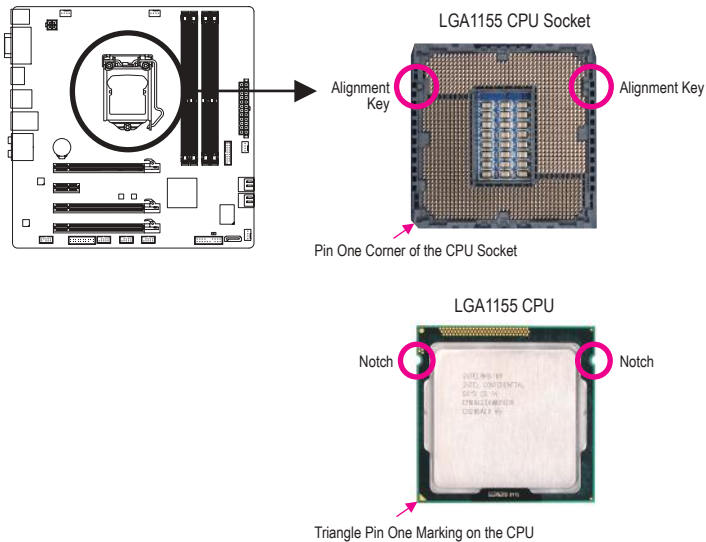

B. Follow the steps below to correctly install the CPU into the motherboard CPU socket.

! Before installing the CPU, make sure to turn off the computer and unplug the power cord from the power outlet to prevent damage to the CPU.



Step 1:
Gently press the CPU socket lever handle down and away from the socket with your finger. Then completely lift the CPU socket lever and the metal load plate will be lifted as well.



Step 2:
Remove the CPU socket cover as shown. Hold your index finger down on the rear grip of the socket cover and use your thumb to lift up the front edge (next to the "REMOVE" mark) and then remove the cover. (DO NOT touch socket contacts. To protect the CPU socket, always replace the protective socket cover when the CPU is not installed.)



Step 3:
Hold the CPU with your thumb and index fingers. Align the CPU pin one marking (triangle) with the pin one corner of the CPU socket (or you may align the CPU notches with the socket alignment keys) and gently insert the CPU into position.



Step 4:
Once the CPU is properly inserted, use one hand to hold the socket lever and use the other to lightly replace the load plate. When replacing the load plate, make sure the front end of the load plate is under the shoulder screw.



Step 5:
Push the CPU socket lever back into its locked position.

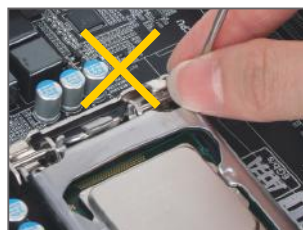

NOTE:
Hold the CPU socket lever by the handle, not the lever base portion.

1-3-2 Installing the CPU Cooler

Follow the steps below to correctly install the CPU cooler on the motherboard. (The following procedure uses Intel® boxed cooler as the example cooler.)



Step 1:
Apply an even and thin layer of thermal grease on the surface of the installed CPU.

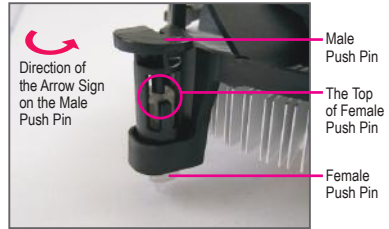

Step 2:
Before installing the cooler, note the direction of the arrow sign  on the male push pin. (Turning the push pin along the direction of arrow is to remove the cooler, on the contrary, is to install.)

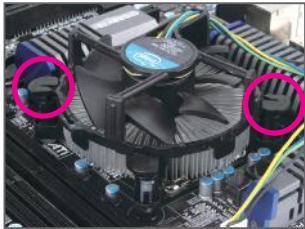

Step 3:
Place the cooler atop the CPU, aligning the four push pins through the pin holes on the motherboard. Push down on the push pins diagonally.



Step 4:
You should hear a "click" when pushing down each push pin. Check that the Male and Female push pins are joined closely. (Refer to your CPU cooler installation manual for instructions on installing the cooler.)



Step 5:
After the installation, check the back of the motherboard. If the push pin is inserted as the picture above shows, the installation is complete.



Step 6:
Finally, attach the power connector of the CPU cooler to the CPU fan header (CPU_FAN) on the motherboard.



Use extreme care when removing the CPU cooler because the thermal grease/tape between the CPU cooler and CPU may adhere to the CPU. Inadequately removing the CPU cooler may damage the CPU.

1-4 Installing the Memory



Read the following guidelines before you begin to install the memory:

- Make sure that the motherboard supports the memory. It is recommended that memory of the same capacity, brand, speed, and chips be used. (Go to GIGABYTE's website for the latest supported memory speeds and memory modules.)
- Always turn off the computer and unplug the power cord from the power outlet before installing the memory to prevent hardware damage.
- Memory modules have a foolproof design. A memory module can be installed in only one direction. If you are unable to insert the memory, switch the direction.

1-4-1 Dual Channel Memory Configuration

This motherboard provides four DDR3 memory sockets and supports Dual Channel Technology. After the memory is installed, the BIOS will automatically detect the specifications and capacity of the memory. Enabling Dual Channel memory mode will double the original memory bandwidth.

The four DDR3 memory sockets are divided into two channels and each channel has two memory sockets as following:

- ▶▶ Channel A: DDR3_2, DDR3_4
- ▶▶ Channel B: DDR3_1, DDR3_3

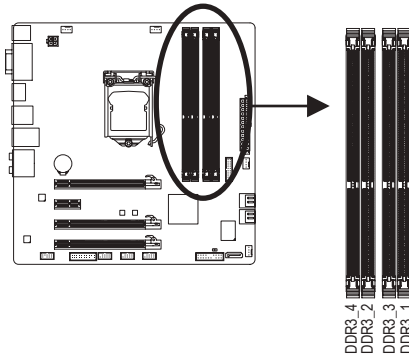

▶▶ Dual Channel Memory Configurations Table

	DDR3_4	DDR3_2	DDR3_3	DDR3_1
Two Modules	--	DS/SS	--	DS/SS
	DS/SS	--	DS/SS	--
Four Modules	DS/SS	DS/SS	DS/SS	DS/SS

(SS=Single-Sided, DS=Double-Sided, "--"=No Memory)

Due to CPU limitations, read the following guidelines before installing the memory in Dual Channel mode.

1. Dual Channel mode cannot be enabled if only one DDR3 memory module is installed.
2. When enabling Dual Channel mode with two or four memory modules, it is recommended that memory of the same capacity, brand, speed, and chips be used. For optimum performance, when enabling Dual Channel mode with two memory modules, we recommend that you install them in the DDR3_1 and DDR3_2 sockets.

1-4-2 Installing a Memory

 Before installing a memory module, make sure to turn off the computer and unplug the power cord from the power outlet to prevent damage to the memory module. DDR3 and DDR2 DIMMs are not compatible to each other or DDR DIMMs. Be sure to install DDR3 DIMMs on this motherboard.

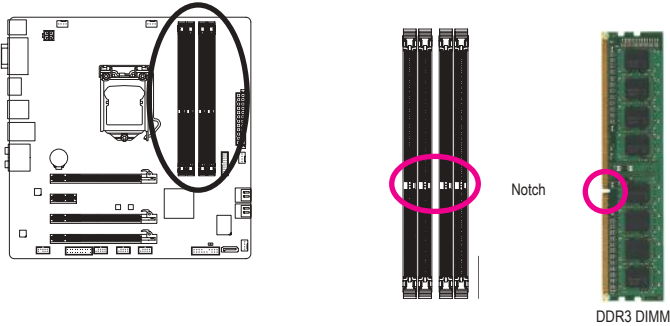

A DDR3 memory module has a notch, so it can only fit in one direction. Follow the steps below to correctly install your memory modules in the memory sockets.

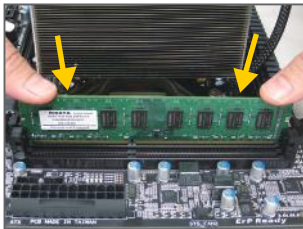

Step 1:

Note the orientation of the memory module. Spread the retaining clips at both ends of the memory socket. Place the memory module on the socket. As indicated in the picture on the left, place your fingers on the top edge of the memory, push down on the memory and insert it vertically into the memory socket.

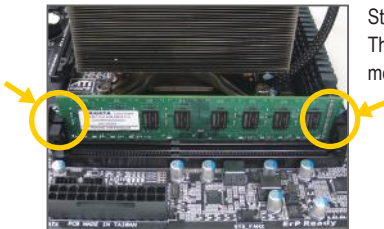

Step 2:

The clips at both ends of the socket will snap into place when the memory module is securely inserted.

1-5 Installing an Expansion Card



Read the following guidelines before you begin to install an expansion card:

- Make sure the motherboard supports the expansion card. Carefully read the manual that came with your expansion card.
- Always turn off the computer and unplug the power cord from the power outlet before installing an expansion card to prevent hardware damage.

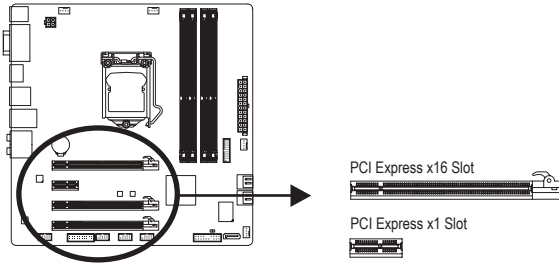

Follow the steps below to correctly install your expansion card in the expansion slot.

1. Locate an expansion slot that supports your card. Remove the metal slot cover from the chassis back panel.
2. Align the card with the slot, and press down on the card until it is fully seated in the slot.
3. Make sure the metal contacts on the card are completely inserted into the slot.
4. Secure the card's metal bracket to the chassis back panel with a screw.
5. After installing all expansion cards, replace the chassis cover(s).
6. Turn on your computer. If necessary, go to BIOS Setup to make any required BIOS changes for your expansion card(s).
7. Install the driver provided with the expansion card in your operating system.

Example: Installing and Removing a PCI Express Graphics Card:



- **Installing a Graphics Card:**
Gently push down on the top edge of the card until it is fully inserted into the PCI Express slot. Make sure the card is securely seated in the slot and does not rock.



- **Removing the Card:**
Press the latch at the end of the PCI Express slot to release the card and then pull the card straight up from the slot.

1-6 Setting up AMD CrossFireX™/NVIDIA SLI Configuration

A. System Requirements

- Windows 7 operating system
- A CrossFireX/SLI-supported motherboard with two PCI Express x16 slots and correct driver
- Two CrossFireX/SLI-ready graphics cards of identical brand and chip and correct driver
- CrossFireX^(Note)/SLI bridge connectors
- A power supply with sufficient power is recommended (Refer to the manual of your graphics cards for the power requirement)

B. Connecting the Graphics Cards

Step 1:

Observe the steps in "1-5 Installing an Expansion Card" and install two CrossFireX/SLI graphics cards on the PCIEX16 and PCIEX8 slots.

Step 2:

Insert the CrossFireX^(Note)/SLI bridge connectors in the CrossFireX/SLI gold edge connectors on top of the cards.

Step 3:

Plug the display cable into the graphics card on the PCIEX16 slot.

C. Configuring the Graphics Card Driver

C-1. To Enable CrossFireX Function

After installing the graphics card driver in the operating system, go to the **Catalyst Control Center**. Browse to **PerformanceAMD CrossFireX™ Configuration** and ensure the **Enable CrossFireX™** check box is selected, and click **Apply**.



C-2. To Enable SLI Function

After installing the graphics card driver in the operating system, go to the **NVIDIA Control Panel**. Browse to the **Set SLI and PhysX Configuration** screen and ensure **Maximize 3D performance** is enabled.

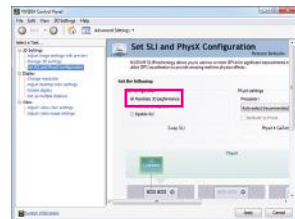

(Note) The bridge connector(s) may be needed or not depending on your graphics cards.



Procedure and driver screen for enabling CrossFireX/SLI technology may differ by graphics cards and driver version. Refer to the manual that came with your graphics cards for more information about enabling CrossFireX/SLI technology.

1-7 Back Panel Connectors

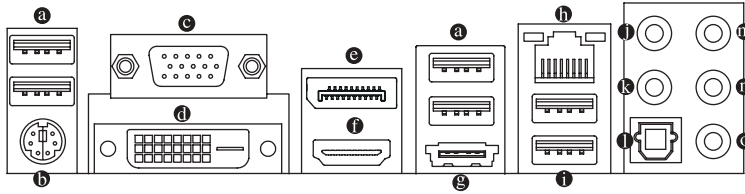

a USB 2.0/1.1 Port

The USB port supports the USB 2.0/1.1 specification. Use this port for USB devices such as a USB keyboard/mouse, USB printer, USB flash drive and etc.

b PS/2 Keyboard/Mouse Port

Use this port to connect a PS/2 mouse or keyboard.

c D-Sub Port

The D-Sub port supports a 15-pin D-Sub connector. Connect a monitor that supports D-Sub connection to this port.

d DVI-D Port (Note)

The DVI-D port conforms to the DVI-D specification and supports a maximum resolution of 1920x1200 (the actual resolutions supported depend on the monitor being used). Connect a monitor that supports DVI-D connection to this port.

e DisplayPort

DisplayPort is one of the new generation interface technologies that delivers high quality digital imaging and audio, supporting bi-directional audio transmission. DisplayPort can support both DPCP and HDCP content protection mechanisms. Connect the audio/video device that supports DisplayPort to this port. The DisplayPort Technology can support a maximum resolution of 2560x1600 but the actual resolutions supported depend on the monitor being used.



After installing the DisplayPort device, make sure the default device for sound playback is the DisplayPort device. (The item name may differ from operating system. For example, in Windows 7, go to Start>Control Panel>Hardware and Sound>Sound>Playback and set the DisplayPort device as the default playback device. Refer to the HDMI settings information on the next page for the configuration dialog box.)

(Note) The DVI-D port does not support D-Sub connection by adapter.



- When removing the cable connected to a back panel connector, first remove the cable from your device and then remove it from the motherboard.
- When removing the cable, pull it straight out from the connector. Do not rock it side to side to prevent an electrical short inside the cable connector.

HDMI Port



HDMI (High-Definition Multimedia Interface) is an all-digital audio/video interface capable of transmitting uncompressed audio/video signals. The HDMI port is HDCP compliant and supports Dolby TrueHD and DTS HD Master Audio formats. It also supports up to 192KHz/24bit 8-channel LPCM audio output. You can use this port to connect your HDMI-supported audio/video device. The maximum supported resolution is 1920x1200, but the actual resolutions supported are dependent on the monitor being used.



After installing the HDMI device, make sure to set the default sound playback device to HDMI. (The item name may differ depending on your operating system. The screenshot below is from Windows 7.)

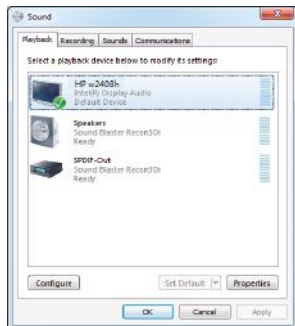

In Windows 7, select Start>Control Panel>Hardware and Sound>Sound>Playback, set Intel(R) Display Audio to the default playback device.

Dual Display Configurations for the Onboard Graphics:

This motherboard provides four video output ports: D-Sub, DVI-D, HDMI, and DisplayPort. Dual monitor configurations are supported in operating system environment only, but not during the BIOS Setup or POST process.

eSATA 3Gb/s Port

The eSATA 3Gb/s port conforms to SATA 3Gb/s standard and is compatible with SATA 1.5Gb/s standard. Use the port to connect an external SATA device. The Intel Z77 Chipset supports RAID function. Refer to Chapter 5, "Configuring SATA Hard Drive(s)," for instructions on configuring a RAID array.

RJ-45 LAN Port

The Gigabit Ethernet LAN port provides Internet connection at up to 1 Gbps data rate. The following describes the states of the LAN port LEDs.

LAN Port

Connection/Speed LED:

State	Description
Orange	1 Gbps data rate
Green	100 Mbps data rate
Off	10 Mbps data rate

Activity LED:

State	Description
Blinking	Data transmission or receiving is occurring
On	No data transmission or receiving is occurring

USB 3.0/2.0 Port

The USB 3.0 port supports the USB 3.0 specification and is compatible to the USB 2.0/1.1 specification. Use this port for USB devices such as a USB keyboard/mouse, USB printer, USB flash drive and etc.

❶ **Line In/Mic In Jack (Pink)**

The line in/Mic in jack. Use this audio jack for line in devices such as optical drive, walkman, microphone, etc.

❷ **Line Out (Light Green)**

The default line out jack. Use this audio jack for a 2-channel speaker. This jack can be used to connect front speakers in a 5.1-channel audio configuration.

❸ **Optical S/PDIF Out Connector**

This connector provides digital audio out to an external audio system that supports digital optical audio. Before using this feature, ensure that your audio system provides an optical digital audio in connector.

❹ **Center/Subwoofer Speaker Out Jack (Orange)**

Use this audio jack to connect center/subwoofer speakers in a 5.1-channel audio configuration.

❺ **Rear Speaker Out Jack (Black)**

Use this audio jack to connect rear speakers in a 5.1-channel audio configuration.

❻ **Headphone Jack (Blackish Green)**

Use this audio jack to connect a headphone. The headphone jack has a built-in amplifier and it is recommended that the headphone be connected to this jack for better sound quality.



Refer to the instructions on setting up a 2/5.1-channel audio configuration in Chapter 5, "Configuring 2/5.1-Channel Audio."

1-8 Internal Connectors

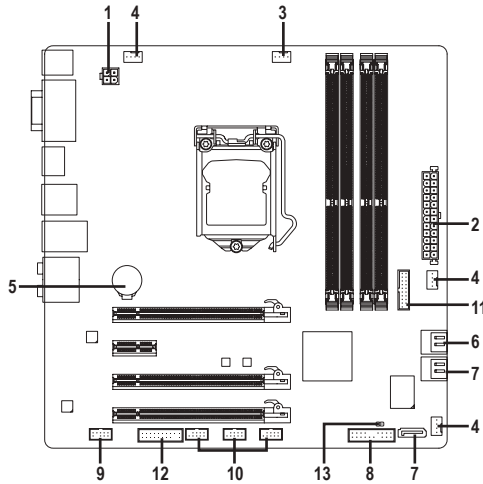

1) ATX_12V	8) F_PANEL
2) ATX	9) F_AUDIO
3) CPU_FAN	10) F_USB1/F_USB2/F_USB3
4) SYS_FAN1/2/3	11) F_USB30
5) BAT	12) TPM
6) SATA3 0/1	13) CLR_CMOS
7) SATA2 2/3/4	



Read the following guidelines before connecting external devices:

- First make sure your devices are compliant with the connectors you wish to connect.
- Before installing the devices, be sure to turn off the devices and your computer. Unplug the power cord from the power outlet to prevent damage to the devices.
- After installing the device and before turning on the computer, make sure the device cable has been securely attached to the connector on the motherboard.

1/2) ATX_12V/ATX (2x2 12V Power Connector and 2x12 Main Power Connector)

With the use of the power connector, the power supply can supply enough stable power to all the components on the motherboard. Before connecting the power connector, first make sure the power supply is turned off and all devices are properly installed. The power connector possesses a foolproof design. Connect the power supply cable to the power connector in the correct orientation.

The 12V power connector mainly supplies power to the CPU. If the 12V power connector is not connected, the computer will not start.



To meet expansion requirements, it is recommended that a power supply that can withstand high power consumption be used (500W or greater). If a power supply is used that does not provide the required power, the result can lead to an unstable or unbootable system.

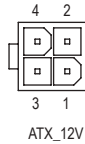
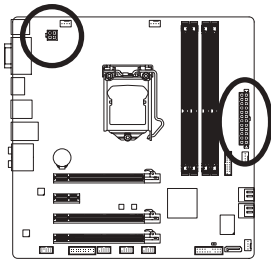

ATX_12V:

Pin No.	Definition
1	GND
2	GND
3	+12V
4	+12V

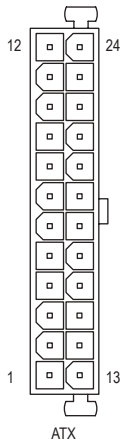

ATX:

Pin No.	Definition	Pin No.	Definition
1	3.3V	13	3.3V
2	3.3V	14	-12V
3	GND	15	GND
4	+5V	16	PS_ON (soft On/Off)
5	GND	17	GND
6	+5V	18	GND
7	GND	19	GND
8	Power Good	20	-5V
9	5VSB (stand by +5V)	21	+5V
10	+12V	22	+5V
11	+12V (Only for 2x12-pin ATX)	23	+5V (Only for 2x12-pin ATX)
12	3.3V (Only for 2x12-pin ATX)	24	GND (Only for 2x12-pin ATX)

3/4) CPU_FAN/SYS_FAN1/SYS_FAN2/SYS_FAN3 (Fan Headers)

All fan headers on this motherboard are 4-pin. Most fan headers possess a foolproof insertion design. When connecting a fan cable, be sure to connect it in the correct orientation (the black connector wire is the ground wire). The speed control function requires the use of a fan with fan speed control design. For optimum heat dissipation, it is recommended that a system fan be installed inside the chassis.

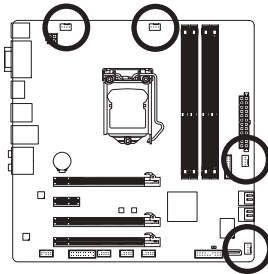

CPU_FAN:

Pin No.	Definition
1	GND
2	+12V/Speed Control
3	Sense
4	Speed Control

SYS_FAN3:

Pin No.	Definition
1	GND
2	+12V
3	Sense
4	Speed Control

SYS_FAN1/2:

Pin No.	Definition
1	GND
2	+12V/Speed Control
3	Sense
4	Reserve



- Be sure to connect fan cables to the fan headers to prevent your CPU and system from overheating. Overheating may result in damage to the CPU or the system may hang.
- These fan headers are not configuration jumper blocks. Do not place a jumper cap on the headers.

5) BAT (Battery)

The battery provides power to keep the values (such as BIOS configurations, date, and time information) in the CMOS when the computer is turned off. Replace the battery when the battery voltage drops to a low level, or the CMOS values may not be accurate or may be lost.

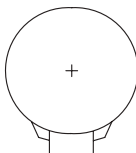
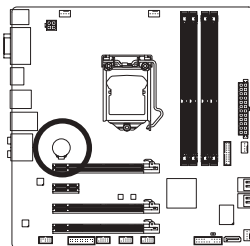

You may clear the CMOS values by removing the battery:

1. Turn off your computer and unplug the power cord.
2. Gently remove the battery from the battery holder and wait for one minute. (Or use a metal object like a screwdriver to touch the positive and negative terminals of the battery holder, making them short for 5 seconds.)
3. Replace the battery.
4. Plug in the power cord and restart your computer.



- Always turn off your computer and unplug the power cord before replacing the battery.
- Replace the battery with an equivalent one. Danger of explosion if the battery is replaced with an incorrect model.
- Contact the place of purchase or local dealer if you are not able to replace the battery by yourself or uncertain about the battery model.
- When installing the battery, note the orientation of the positive side (+) and the negative side (-) of the battery (the positive side should face up).
- Used batteries must be handled in accordance with local environmental regulations.

6) SATA3 0/1 (SATA 6Gb/s Connectors, Controlled by Intel Z77 Chipset)

The SATA connectors conform to SATA 6Gb/s standard and are compatible with SATA 3Gb/s and SATA 1.5Gb/s standard. Each SATA connector supports a single SATA device. The "SATA3 0" and "SATA3 1" connectors support RAID 0 and RAID 1. RAID 5 and RAID 10 can be implemented on the two connectors with the "SATA2 2/3/4" connector and eSATA^(Note). Refer to Chapter 5, "Configuring SATA Hard Drive(s)," for instructions on configuring a RAID array.

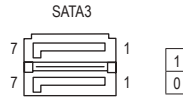
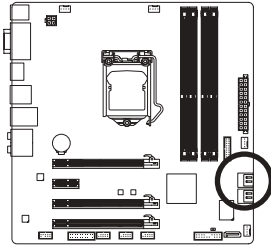

Pin No.	Definition
1	GND
2	TXP
3	TXN
4	GND
5	RXN
6	RXP
7	GND

7) SATA2 2/3/4 (SATA 3Gb/s Connectors, Controlled by Intel Z77 Chipset)

The SATA connectors conform to SATA 3Gb/s standard and are compatible with SATA 1.5Gb/s standard. Each SATA connector supports a single SATA device. The Intel Z77 Chipset supports RAID 0, RAID 1, RAID 5, and RAID 10. Refer to Chapter 5, "Configuring SATA Hard Drive(s)," for instructions on configuring a RAID array.

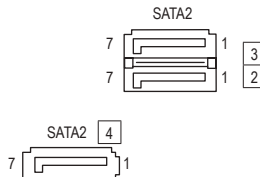
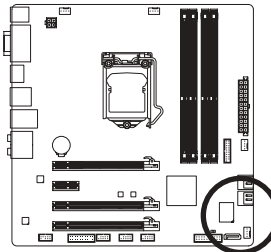

Pin No.	Definition
1	GND
2	TXP
3	TXN
4	GND
5	RXN
6	RXP
7	GND



- A RAID 0 or RAID 1 configuration requires at least two hard drives. If more than two hard drives are to be used, the total number of hard drives must be an even number.
- A RAID 5 configuration requires at least three hard drives. (The total number of hard drives does not have to be an even number.)
- A RAID 10 configuration requires four hard drives.

(Note) When a RAID set is built across the SATA 6Gb/s and SATA 3Gb/s channels, the system performance of the RAID set may vary depending on the devices being connected.

8) F_PANEL (Front Panel Header)

Connect the power switch, reset switch, speaker, chassis intrusion switch/sensor and system status indicator on the chassis to this header according to the pin assignments below. Note the positive and negative pins before connecting the cables.

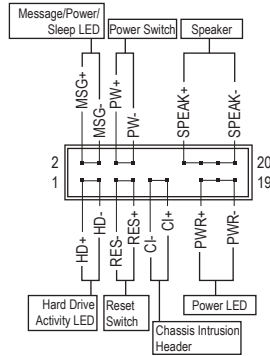
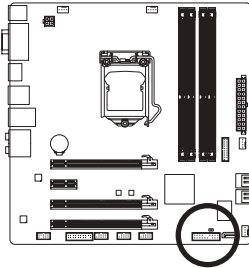

- **MSG/PWR** (Message/Power/Sleep LED, Yellow/Purple):

System Status	LED
S0	On
S3/S4/S5	Off

Connects to the power status indicator on the chassis front panel. The LED is on when the system is operating. The LED is off when the system is in S3/S4 sleep state or powered off (S5).

- **PW** (Power Switch, Red):

Connects to the power switch on the chassis front panel. You may configure the way to turn off your system using the power switch (refer to Chapter 2, "BIOS Setup," "Power Management," for more information).

- **SPEAK** (Speaker, Orange):

Connects to the speaker on the chassis front panel. The system reports system startup status by issuing a beep code. One single short beep will be heard if no problem is detected at system startup.

- **HD** (Hard Drive Activity LED, Blue):

Connects to the hard drive activity LED on the chassis front panel. The LED is on when the hard drive is reading or writing data.

- **RES** (Reset Switch, Green):

Connects to the reset switch on the chassis front panel. Press the reset switch to restart the computer if the computer freezes and fails to perform a normal restart.

- **CI** (Chassis Intrusion Header, Gray):

Connects to the chassis intrusion switch/sensor on the chassis that can detect if the chassis cover has been removed. This function requires a chassis with a chassis intrusion switch/sensor.



The front panel design may differ by chassis. A front panel module mainly consists of power switch, reset switch, power LED, hard drive activity LED, speaker and etc. When connecting your chassis front panel module to this header, make sure the wire assignments and the pin assignments are matched correctly.

9) F_AUDIO (Front Panel Audio Header)

The front panel audio header supports Intel High Definition audio (HD). You may connect your chassis front panel audio module to this header. Make sure the wire assignments of the module connector match the pin assignments of the motherboard header. Incorrect connection between the module connector and the motherboard header will make the device unable to work or even damage it.

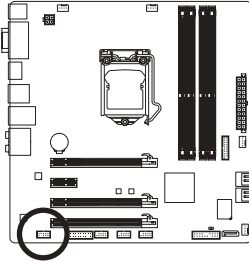

Pin No.	Definition
1	MIC2_L
2	GND
3	MIC2_R
4	-ACZ_DET
5	LINE2_R
6	GND
7	FAUDIO_JD
8	No Pin
9	LINE2_L
10	GND



Some chassis provide a front panel audio module that has separated connectors on each wire instead of a single plug. For information about connecting the front panel audio module that has different wire assignments, please contact the chassis manufacturer.

10) F_USB1/F_USB2/F_USB3 (USB 2.0/1.1 Headers)

The headers conform to USB 2.0/1.1 specification. Each USB header can provide two USB ports via an optional USB bracket. For purchasing the optional USB bracket, please contact the local dealer.

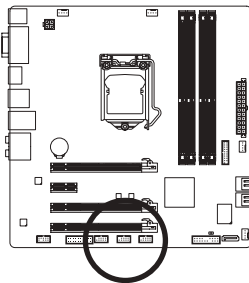

Pin No.	Definition
1	Power (5V)
2	Power (5V)
3	USB DX-
4	USB DY-
5	USB DX+
6	USB DY+
7	GND
8	GND
9	No Pin
10	NC



When the system is in S4/S5 mode, only the USB ports routed to the F_USB1 header can support the ON/OFF Charge function.



- Do not plug the IEEE 1394 bracket (2x5-pin) cable into the USB 2.0/1.1 header.
- Prior to installing the USB bracket, be sure to turn off your computer and unplug the power cord from the power outlet to prevent damage to the USB bracket.

11) F_USB30 (USB 3.0/2.0 Header)

The header conforms to USB 3.0/2.0 specification and can provide two USB ports. For purchasing the optional 3.5" front panel that provides two USB 3.0/2.0 ports, please contact the local dealer.

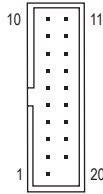
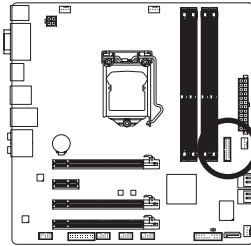

Pin No.	Definition	Pin No.	Definition
1	VBUS	11	D2+
2	SSRX1-	12	D2-
3	SSRX1+	13	GND
4	GND	14	SSTX2+
5	SSTX1-	15	SSTX2-
6	SSTX1+	16	GND
7	GND	17	SSRX2+
8	D1-	18	SSRX2-
9	D1+	19	VBUS
10	NC	20	No Pin



Prior to installing the USB front panel, be sure to turn off your computer and unplug the power cord from the power outlet to prevent damage to the USB front panel.

12) TPM (Trusted Platform Module Header)

You may connect a TPM (Trusted Platform Module) to this header.

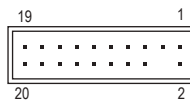
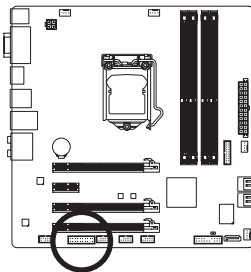

Pin No.	Definition	Pin No.	Definition
1	LCLK	11	LAD0
2	GND	12	GND
3	LFRAME	13	NC
4	No Pin	14	ID
5	LRESET	15	SB3V
6	NC	16	SERIRQ
7	LAD3	17	GND
8	LAD2	18	NC
9	VCC3	19	NC
10	LAD1	20	SUSCLK

13) CLR_CMOS (Clear CMOS Jumper)

Use this jumper to clear the CMOS values (e.g. date information and BIOS configurations) and reset the CMOS values to factory defaults. To clear the CMOS values, use a metal object like a screwdriver to touch the two pins for a few seconds.

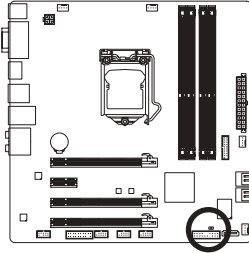

 Open: Normal

 Short: Clear CMOS Values



- Always turn off your computer and unplug the power cord from the power outlet before clearing the CMOS values.
- After system restart, go to BIOS Setup to load factory defaults (select Load Optimized Defaults) or manually configure the BIOS settings (refer to Chapter 2, "BIOS Setup," for BIOS configurations).

Chapter 2 BIOS Setup

BIOS (Basic Input and Output System) records hardware parameters of the system in the CMOS on the motherboard. Its major functions include conducting the Power-On Self-Test (POST) during system startup, saving system parameters and loading operating system, etc. BIOS includes a BIOS Setup program that allows the user to modify basic system configuration settings or to activate certain system features.

When the power is turned off, the battery on the motherboard supplies the necessary power to the CMOS to keep the configuration values in the CMOS.

To access the BIOS Setup program, press the <Delete> key during the POST when the power is turned on.

To upgrade the BIOS, use either the GIGABYTE Q-Flash or @BIOS utility.

- Q-Flash allows the user to quickly and easily upgrade or back up BIOS without entering the operating system.
- @BIOS is a Windows-based utility that searches and downloads the latest version of BIOS from the Internet and updates the BIOS.

For instructions on using the Q-Flash and @BIOS utilities, refer to Chapter 4, "BIOS Update Utilities."



- Because BIOS flashing is potentially risky, if you do not encounter problems using the current version of BIOS, it is recommended that you not flash the BIOS. To flash the BIOS, do it with caution. Inadequate BIOS flashing may result in system malfunction.
- It is recommended that you not alter the default settings (unless you need to) to prevent system instability or other unexpected results. Inadequately altering the settings may result in system's failure to boot. If this occurs, try to clear the CMOS values and reset the board to default values. (Refer to the "Load Optimized Defaults" section in this chapter or introductions of the battery/clear CMOS jumper in Chapter 1 for how to clear the CMOS values.)

2-1 Startup Screen

The following startup Logo screen will appear when the computer boots.



Function Keys:

: BIOS SETUP/Q-FLASH

Press the <Delete> key to enter BIOS Setup or to access the Q-Flash utility in BIOS Setup.

<F9>: SYSTEM INFORMATION

Press the <F9> key to display your system information.

<F12>: BOOT MENU

Boot Menu allows you to set the first boot device without entering BIOS Setup. In Boot Menu, use the up arrow key <↑> or the down arrow key <↓> to select the first boot device, then press <Enter> to accept. The system will boot from the device immediately.

Note: The setting in Boot Menu is effective for one time only. After system restart, the device boot order will still be based on BIOS Setup settings.

<END>: Q-FLASH

Press the <End> key to access the Q-Flash utility directly without having to enter BIOS Setup first.

2-2 The Main Menu

A. The 3D BIOS Screen (Default)

On GIGABYTE's uniquely designed 3D BIOS screen, you can use your mouse to move through the motherboard image and click to enter the function menu in each area for quick configuration. For example, pass your mouse arrow over the CPU and memory sockets and enter the **System Tuning** menu to configure CPU/memory frequency, memory timings, and voltage settings. For more detailed configuration items, you can click the function menu icons at the bottom of the screen or press <F1> to switch to the main menu of the BIOS Setup program. (If a mouse is not connected, the 3D BIOS screen will automatically switch to the main menu of the BIOS Setup Program.)



B. The Main Menu of the BIOS Setup Program

On the main menu of the BIOS Setup program, press arrow keys to move among the items and press <Enter> to accept or enter a sub-menu. Or you can use your mouse to select the item you want.

(Sample BIOS Version: D13)



Configuration Items

Current Settings

BIOS Setup Program Function Keys

<<-><->>	Move the selection bar to select a setup menu
<↑><↓>	Move the selection bar to select an configuration item on a menu
<Enter>	Execute command or enter a menu
<+>/<Page Up>	Increase the numeric value or make changes
<->/<Page Down>	Decrease the numeric value or make changes
<F1>	Switch to 3D BIOS screen
<F5>	Restore the previous BIOS settings for the current submenus
<F7>	Load the Optimized BIOS default settings for the current submenus
<F8>	Access the Q-Flash utility
<F9>	Display system information
<F10>	Save all the changes and exit the BIOS Setup program
<F12>	Capture the current screen as an image and save it to your USB drive
<Esc>	Main Menu: Exit the BIOS Setup program Submenus: Exit current submenu

BIOS Setup Menus

■ M.I.T.

Use this menu to configure the clock, frequency, and voltages of your CPU and memory, etc. Or check the system/CPU temperatures, voltages, and fan speeds.

■ System

Use this menu to configure the default language used by the BIOS and system time and date. This menu also displays information on the devices connected to the SATA ports.

■ BIOS Features

Use this menu to configure the device boot order, advanced features available on the CPU, and the primary display adapter.

■ Peripherals

Use this menu to configure all peripheral devices, such as SATA, USB, integrated audio, and integrated LAN, etc.

■ Power Management

Use this menu to configure all the power-saving functions.

■ Save & Exit

Save all the changes made in the BIOS Setup program to the CMOS and exit BIOS Setup. You can save the current BIOS settings to a profile or load optimized defaults for optimal-performance system operations.



- When the system is not stable as usual, select the **Load Optimized Defaults** item to set your system to its defaults.
- The BIOS Setup menus described in this chapter are for reference only and may differ by BIOS version.

2-3 M.I.T.



Whether the system will work stably with the overclock/overvoltage settings you made is dependent on your overall system configurations. Incorrectly doing overclock/overvoltage may result in damage to CPU, chipset, or memory and reduce the useful life of these components. This page is for advanced users only and we recommend you not to alter the default settings to prevent system instability or other unexpected results. (Inadequately altering the settings may result in system's failure to boot. If this occurs, clear the CMOS values and reset the board to default values.)



This section provides information on the BIOS version, CPU base clock, CPU frequency, memory frequency, total memory size, CPU temperature, Vcore, and memory voltage.

► **M.I.T. Current Status**

This screen provides information on CPU/memory frequencies/parameters.

► **Advanced Frequency Settings**



☞ **CPU/PCIe Base Clock**

Allows you to manually set the CPU base clock and PCIe bus frequency in 0.01 MHz increments.

(Default: Auto)

Important: It is highly recommended that the CPU frequency be set in accordance with the CPU specifications.

☞ **Processor Graphics Clock**

Allows you to set the onboard graphics clock. The adjustable range is from 400 MHz to 3200 MHz.

(Default: Auto)

☞ **CPU Clock Ratio**

Allows you to alter the clock ratio for the installed CPU. The adjustable range is dependent on the CPU being installed.

☞ **CPU Frequency**

Displays the current operating CPU frequency.

▶ Advanced CPU Core Features



- ☞ **CPU Clock Ratio, CPU Frequency**
The settings under the two items above are synchronous to those under the same items on the **Advanced Frequency Settings** menu.
- ☞ **Intel(R) Turbo Boost Technology** ^(Note)
Allows you to determine whether to enable the Intel CPU Turbo Boost technology. **Auto** lets the BIOS automatically configure this setting. (Default: Auto)
- ☞ **Turbo Ratio (1-Core Active~4-Core Active)** ^(Note)
Allows you to set the CPU Turbo ratios for different number of active cores. **Auto** sets the CPU Turbo ratios according to the CPU specifications. (Default: Auto)
- ☞ **Turbo Power Limit (Watts)**
Allows you to set a power limit for CPU Turbo mode. When the CPU power consumption exceeds the specified power limit, the CPU will automatically reduce the core frequency in order to reduce the power. **Auto** sets the power limit according to the CPU specifications. (Default: Auto)
- ☞ **Core Current Limit (Amps)**
Allows you to set a current limit for CPU Turbo mode. When the CPU current exceeds the specified current limit, the CPU will automatically reduce the core frequency in order to reduce the current. **Auto** sets the power limit according to the CPU specifications. (Default: Auto)
- ☞ **CPU Core Enabled** ^(Note)
Allows you to determine whether to enable all CPU cores. **Auto** lets the BIOS automatically configure this setting. (Default: Auto)
- ☞ **Hyper-Threading Technology** ^(Note)
Allows you to determine whether to enable multi-threading technology when using an Intel CPU that supports this function. This feature only works for operating systems that support multi-processor mode. **Auto** lets the BIOS automatically configure this setting. (Default: Auto)

(Note) This item is present only when you install a CPU that supports this feature. For more information about Intel CPUs' unique features, please visit Intel's website.

- ☞ **CPU Enhanced Halt (C1E)** ^(Note 1)

Enables or disables Intel CPU Enhanced Halt (C1E) function, a CPU power-saving function in system halt state. When enabled, the CPU core frequency and voltage will be reduced during system halt state to decrease power consumption. **Auto** lets the BIOS automatically configure this setting. (Default: Auto)
- ☞ **C3/C6 State Support** ^(Note 1)

Allows you to determine whether to let the CPU enter C3/C6 mode in system halt state. When enabled, the CPU core frequency and voltage will be reduced during system halt state to decrease power consumption. The C3/C6 state is a more enhanced power-saving state than C1. **Auto** lets the BIOS automatically configure this setting. (Default: Auto)
- ☞ **CPU Thermal Monitor** ^(Note 1)

Enables or disables Intel CPU Thermal Monitor function, a CPU overheating protection function. When enabled, the CPU core frequency and voltage will be reduced when the CPU is overheated. **Auto** lets the BIOS automatically configure this setting. (Default: Auto)
- ☞ **CPU EIST Function** ^(Note 1)

Enables or disables Enhanced Intel SpeedStep Technology (EIST). Depending on CPU loading, Intel EIST technology can dynamically and effectively lower the CPU voltage and core frequency to decrease average power consumption and heat production. **Auto** lets the BIOS automatically configure this setting. (Default: Auto)
- ☞ **Bi-Directional PROCHOT** ^(Note 1)

 - ▶▶ Auto Lets BIOS automatically configure this setting. (Default)
 - ▶▶ Enabled When the CPU or chipset detects that an overheating is occurring, PROCHOT signals will be emitted to lower CPU performance to decrease heat production.
 - ▶▶ Disabled Only allows the CPU to detect whether an overheating is occurring to emit PROCHOT signals.
- ☞ **Extreme Memory Profile (X.M.P.)** ^(Note 2)

Allows the BIOS to read the SPD data on XMP memory module(s) to enhance memory performance when enabled.

 - ▶▶ Disabled Disables this function. (Default)
 - ▶▶ Profile1 Uses Profile 1 settings.
 - ▶▶ Profile2 ^(Note 2) Uses Profile 2 settings.
- ☞ **System Memory Multiplier (SPD)**

Allows you to set the system memory multiplier. **Auto** sets memory multiplier according to memory SPD data. (Default: Auto)
- ☞ **Memory Frequency (MHz)**

The first memory frequency value is the normal operating frequency of the memory being used; the second is the memory frequency that is automatically adjusted according to the **System Memory Multiplier** settings.

(Note 1) This item is present only when you install a CPU that supports this feature. For more information about Intel CPUs' unique features, please visit Intel's website.

(Note 2) This item is present only when you install a CPU and a memory module that support this feature.

▶ Advanced Memory Settings



☞ **Extreme Memory Profile (X.M.P.)** (Note), **System Memory Multiplier (SPD)**, **Memory Frequency (Mhz)**

The settings under the three items above are synchronous to those under the same items on the **Advanced Frequency Settings** menu.

☞ **Performance Enhance**

Allows the system to operate at three different performance levels.

- ▶▶ Normal Lets the system operate at its basic performance level.
- ▶▶ Turbo Lets the system operate at its good performance level. (Default)
- ▶▶ Extreme Lets the system operate at its best performance level.

☞ **DRAM Timing Selectable**

Quick and **Expert** allows the **Channel Interleaving**, **Rank Interleaving**, and memory timing settings below to be configurable. Options are: Auto (default), Quick, Expert.

☞ **Profile DDR Voltage**

When using a non-XMP memory module or **Extreme Memory Profile (X.M.P.)** is set to **Disabled**, this item will display as **1.50V**. When **Extreme Memory Profile (X.M.P.)** is set to **Profile1** or **Profile2**, this item will display the value based on the SPD data on the XMP memory.

☞ **Profile VTT Voltage**

The value displayed here is dependent on the CPU being used.

☞ **Channel Interleaving**

Enables or disables memory channel interleaving. **Enabled** allows the system to simultaneously access different channels of the memory to increase memory performance and stability. **Auto** lets the BIOS automatically configure this setting. (Default: Auto)

☞ **Rank Interleaving**

Enables or disables memory rank interleaving. **Enabled** allows the system to simultaneously access different ranks of the memory to increase memory performance and stability. **Auto** lets the BIOS automatically configure this setting. (Default: Auto)

(Note) This item is present only when you install a CPU and a memory module that support this feature.

► Channel A/B Timing Settings



This sub-menu provides memory timing settings for each channel of memory. The respective timing setting screens are configurable only when **DRAM Timing Selectable** is set to **Quick** or **Expert**. Note: Your system may become unstable or fail to boot after you make changes on the memory timings. If this occurs, please reset the board to default values by loading optimized defaults or clearing the CMOS values.

► Advanced Voltage Settings



▶ 3D Power Control



⊞ PWM Phase Control

Allows you to automatically change the PWM phase according to the CPU load. The power-saving levels are (from lowest to highest): eXm Perf (Extreme Performance), High Perf (High Performance), Perf (Performance), Balanced, Mid PWR (Mid Power), and Lite PWR (Light Power). **Auto** lets the BIOS automatically configure this setting. (Default: Auto)

⊞ Vcore Voltage Response

Allows you to configure the response time for Vcore changes using four preset levels.

- ▶▶ Auto Lets BIOS automatically configure this setting. (Default)
- ▶▶ Standard-Fast Selects Standard or Fast which represents different levels of the response time for Vcore changes.

⊞ Vcore Loadline Calibration (mΩ)

Allows you to set the Load-Line Calibration level for the Vcore. The levels are (from highest to lowest): Extreme, Turbo, High, Medium, Low, and Standard. Selecting a higher level keeps the Vcore more consistent with what is set in BIOS under heavy load. **Auto** lets the BIOS automatically configure this setting and sets the voltage following Intel's specifications. (Default: Auto)

⊞ GFX Voltage Loadline Calibration

Allows you to set the Load-Line Calibration level for the GFX voltage. The levels are (from highest to lowest): Extreme, Turbo, High, Medium, Low, and Standard. Selecting a higher level keeps the GFX voltage more consistent with what is set in BIOS under heavy load. **Auto** lets the BIOS automatically configure this setting and sets the voltage following Intel's specifications. (Default: Auto)

☞ **Vcore Protection**

Allows you to set the voltage limit on the Vcore for over-voltage protection. The adjustable range is from 150.0mV to 300.0mV. **Auto** lets the BIOS automatically configure this setting. (Default: Auto)

☞ **Vcore Current Protection**

Allows you to set the over-current protection level for the Vcore.

- ▶▶ Auto Lets BIOS automatically configure this setting. (Default)
- ▶▶ Standard~Extreme Selects Standard, Low, Medium, High, Turbo, or Extreme which represents different level of over-current protection for the Vcore.

☞ **GFX Current Protection**

Allows you to set the over-current protection level for the GFX voltage.

- ▶▶ Auto Lets BIOS automatically configure this setting. (Default)
- ▶▶ Standard~Extreme Selects Standard, Low, Medium, High, Turbo, or Extreme which represents different level of over-current protection for the GFX voltage.

☞ **Vcore PWM Thermal Protection**

Allows you to set the PWM thermal protection threshold for the Vcore area. Options are 130.0°C and 135.0°C. **Auto** lets the BIOS automatically configure this setting. (Default: Auto)

▶ **CPU Core Voltage Control**

This section provides CPU voltage control options.

▶ **DRAM Voltage Control**

This section provides memory voltage control options.

▶ PC Health Status



⌘ Reset Case Open Status

- ▶ Disabled Keeps or clears the record of previous chassis intrusion status. (Default)
- ▶ Enabled Clears the record of previous chassis intrusion status and the **Case Open** field will show "No" at next boot.

⌘ Case Open

Displays the detection status of the chassis intrusion detection device attached to the motherboard CI header. If the system chassis cover is removed, this field will show "Yes", otherwise it will show "No". To clear the chassis intrusion status record, set **Reset Case Open Status** to **Enabled**, save the settings to the CMOS, and then restart your system.

- ☞ **CPU Vcore/Dram Voltage/+3.3V/+12V**
Displays the current system voltages.
- ☞ **CPU/PCH/System Temperature**
Displays current CPU/Chipset/System temperature.
- ☞ **CPU/System FAN Speed**
Displays current CPU/system fan speeds.
- ☞ **CPU Warning Temperature**
Sets the warning threshold for CPU temperature. When CPU temperature exceeds the threshold, BIOS will emit warning sound. Options are: Disabled (default), 60°C/140°F, 70°C/158°F, 80°C/176°F, 90°C/194°F.
- ☞ **CPU/System Fan Fail Warning**
Allows the system to emit warning sound if the CPU fan or system fan are not connected or fail. Check the fan condition or fan connection when this occurs. (Default: Disabled)
- ☞ **CPU Fan Control mode**
 - ▶▶ Auto Lets the BIOS automatically detect the type of CPU fan installed and sets the optimal CPU fan control mode. (Default)
 - ▶▶ Voltage Sets Voltage mode for a 3-pin CPU fan.
 - ▶▶ PWM Sets PWM mode for a 4-pin CPU fan.

Note: The Voltage mode can be set for a 3-pin CPU fan or a 4-pin CPU fan. However, for a 4-pin CPU fan that is not designed following Intel PWM fan specifications, selecting PWM mode may not effectively reduce the fan speed.
- ☞ **CPU Fan Speed Control**
Allows you to determine whether to enable the CPU fan speed control function and adjust the fan speed.
 - ▶▶ Normal Allows the CPU fan to run at different speeds according to the CPU temperature. You can adjust the fan speed with EasyTune based on your system requirements. (Default)
 - ▶▶ Silent Allows the CPU fan to run at slow speeds.
 - ▶▶ Manual Allows you to control the CPU fan speed under the **Slope PWM** item.
 - ▶▶ Disabled Allows the CPU fan to run at full speeds.
- ☞ **Slope PWM**
Allows you to control the CPU fan speed. This item is configurable only when **CPU Fan Speed Control** is set to **Manual**. Options are: 0.75 PWM value /°C ~ 2.50 PWM value /°C.
- ☞ **1st/2nd/3rd System Fan Speed Control**
Allows you to determine whether to enable the system fan speed control function and adjust the fan speed.
 - ▶▶ Normal Allows the system fans to run at different speeds according to the system temperature. You can adjust the fan speed with EasyTune based on your system requirements. (Default)
 - ▶▶ Silent Allows the system fans to run at slow speeds.
 - ▶▶ Manual Allows you to control the system fan speed under the **Slope PWM** item.
 - ▶▶ Disabled Allows the system fans to run at full speeds.
- ☞ **Slope PWM**
Allows you to control the system fan speed. This item is configurable only when **1st/2nd/3rd System FAN Speed Control** is set to **Manual**. Options are: 0.75 PWM value /°C ~ 2.50 PWM value /°C.

2-4 System



This section provides information on your CPU, memory, motherboard model, and BIOS version. You can also select the default language used by the BIOS and manually set the system time.

System Language

Selects the default language used by the BIOS.

System Date

Sets the system date. The date format is week (read-only), month, date, and year. Use <Enter> to switch between the Month, Date, and Year fields and use the <Page Up> or <Page Down> key to set the desired value.

System Time

Sets the system time. The time format is hour, minute, and second. For example, 1 p.m. is 13:0:0. Use <Enter> to switch between the Hour, Minute, and Second fields and use the <Page Up> or <Page Down> key to set the desired value.

Access Level

Displays the current access level depending on the type of password protection used. (If no password is set, the default will display as Administrator.) The Administrator level allows you to make changes to all BIOS settings; the User level only allows you to make changes to certain BIOS settings but not all.

ATA Port Information

This section provides information on the device connected to each SATA port controlled by Intel Z77 Chipset. You can enable/disable each SATA port or enable/disable the hot plug capability.

2-5 BIOS Features



☞ **Boot Option Priorities**

Specifies the overall boot order from the available devices. For example, you can set hard drive as the first priority (**Boot Option #1**) and DVD ROM drive as the second priority (**Boot Option #2**). The list only displays the device with the highest priority for a specific type. For example, only hard drive defined as the first priority on the **Hard Drive BBS Priorities** submenu will be presented here.

Removable storage devices that support GPT format will be prefixed with "UEFI:" string on the boot device list. To boot from an operating system that supports GPT partitioning, select the device prefixed with "UEFI:" string.

Or if you want to install an operating system that supports GPT partitioning such as Windows 7 64-bit, select the optical drive that contains the Windows 7 64-bit installation disk and is prefixed with "UEFI:" string.

☞ **Hard Drive/CD/DVD ROM Drive/Floppy Drive/Network Device BBS Priorities**

Specifies the boot order for a specific device type, such as hard drives, optical drives, floppy disk drives, and devices that support Boot from LAN function, etc. Press <Enter> on this item to enter the submenu that presents the devices of the same type that are connected. This item is present only if at least one device for this type is installed.

☞ **Bootup NumLock State**

Enables or disables Numlock feature on the numeric keypad of the keyboard after the POST. (Default: Enabled)

☞ **Full Screen LOGO Show**

Allows you to determine whether to display the GIGABYTE Logo at system startup. **Disabled** skips the GIGABYTE Logo when the system starts up. (Default: Enabled)

☞ **PCI ROM Priority**

Allows you to determine which Option ROM to launch. Options are Legacy ROM and EFI Compatible ROM. (Default: EFI Compatible ROM)

☞ **Limit CPUID Maximum** ^(Note)

Allows you to determine whether to limit CPUID maximum value. Set this item to **Disabled** for Windows XP operating system; set this item to **Enabled** for legacy operating system such as Windows NT4.0. (Default: Disabled)

☞ **Execute Disable Bit** ^(Note)

Enables or disables Intel Execute Disable Bit function. This function may enhance protection for the computer, reducing exposure to viruses and malicious buffer overflow attacks when working with its supporting software and system. (Default: Enabled)

☞ **Intel Virtualization Technology** ^(Note)

Enables or disables Intel Virtualization Technology. Virtualization enhanced by Intel Virtualization Technology will allow a platform to run multiple operating systems and applications in independent partitions. With virtualization, one computer system can function as multiple virtual systems. (Default: Disabled)

☞ **Administrator Password**

Allows you to configure an administrator password. Press <Enter> on this item, type the password, and then press <Enter>. You will be requested to confirm the password. Type the password again and press <Enter>. You must enter the administrator password (or user password) at system startup and when entering BIOS Setup. Differing from the user password, the administrator password allows you to make changes to all BIOS settings.

☞ **User Password**

Allows you to configure a user password. Press <Enter> on this item, type the password, and then press <Enter>. You will be requested to confirm the password. Type the password again and press <Enter>. You must enter the administrator password (or user password) at system startup and when entering BIOS Setup. However, the user password only allows you to make changes to certain BIOS settings but not all.

To cancel the password, press <Enter> on the password item and when requested for the password, enter the correct one first. When prompted for a new password, press <Enter> without entering any password. Press <Enter> again when prompted to confirm.

(Note) This item is present only when you install a CPU that supports this feature. For more information about Intel CPUs' unique features, please visit Intel's website.

2-6 Peripherals



☞ LAN PXE Boot Option ROM

Allows you to decide whether to activate the boot ROM integrated with the onboard LAN chip. (Default: Disabled)

☞ SATA Controller(s)

Enables or disables the integrated SATA controllers. (Default: Enabled)

☞ SATA Mode Selection

Enables or disables RAID for the SATA controllers integrated in the Intel Z77 Chipset or configures the SATA controllers to AHCI mode.

 ▶▶ IDE Configures the SATA controller to IDE mode.

- ▶▶ RAID Enables RAID for the SATA controller.
 - ▶▶ AHCI Configures the SATA controllers to AHCI mode. Advanced Host Controller Interface (AHCI) is an interface specification that allows the storage driver to enable advanced Serial ATA features such as Native Command Queuing and hot plug. (Default)
- ☞ **xHCI Pre-Boot Driver**
- ▶▶ Enabled The USB 3.0 ports are routed to the xHCI controller before booting to OS. (Default)
 - ▶▶ Disabled The USB 3.0 ports are routed to the EHCI controller before booting to OS.
- When this item is set to **Enabled**, the **xHCI Mode** below will be automatically set to **Smart Auto**; when this item is set to **Disabled**, the **xHCI Mode** below will be automatically set to **Auto**.
- ☞ **xHCI Mode**
- Allows you to determine the operating mode for the xHCI controller in OS.
- ▶▶ Smart Auto This mode is available only when the BIOS supports the xHCI controller in the pre-boot environment. This mode is similar to **Auto**, but it adds the capability to route the ports to xHCI or EHCI according to setting used in previous boots (for non-G3 boot) in the pre-boot environment. This allows the use of USB 3.0 devices prior to OS boot. xHCI controller enabling and rerouting should follow the steps in **Auto**, when previous boot routes ports to EHCI. Note: This is the recommended mode when BIOS has xHCI pre-boot support. (Default)
 - ▶▶ Auto BIOS routes the sharable ports to EHCI controller. Then it uses ACPI protocols to provide an option to enable the xHCI controller and reroute the sharable ports. Note: This is the recommended mode when BIOS does NOT have xHCI pre-boot support.
 - ▶▶ Enabled All shared ports are eventually routed to the xHCI controller during the BIOS boot process. If BIOS does not have pre-boot support for the xHCI controller, it should initially route the sharable ports to the EHCI controller and then prior to OS boot it should route the ports to xHCI controller. Note: OS has to provide support for the xHCI controller in this mode. If the OS does not provide support, all sharable ports won't work.
 - ▶▶ Disabled The USB 3.0 ports are routed to the EHCI controller and the xHCI controller is turned off. All USB 3.0 devices function as High Speed devices regardless of xHCI software support/availability. If this item is set to **Disabled**, the **HS Port #1/2/3/4 Switchable** and **xHCI Streams** items below will become unconfigurable.
- ☞ **HS Port #1 Switchable~HS Port #4 Switchable**
- ▶▶ Enabled Corresponding USB 3.0 port is routed to xHCI. The USB 3.0 device attached on this port with Super-Speed capability is visible to xHCI controller. (Default)
 - ▶▶ Disabled Corresponding USB 3.0 port is routed to EHCI. The USB 3.0 device attached on this port with Super-Speed capability will function as High-Speed.
- ☞ **xHCI Streams**
- Enables or disables multi-stream data transfer. Note: For Windows 7 USB 3.0 Streams support, devices may require UASP class driver updates from UASP driver vendors to be fully compatible with Intel USB 3.0 Streams Support. (Default: Enabled)
- ☞ **USB2.0 Controller**
- Enables or disables the integrated USB 2.0 controller. (Default: Enabled)
- ☞ **Audio Controller**
- Enables or disables the onboard audio function. (Default: Enabled)
- If you wish to install a 3rd party add-in audio card instead of using the onboard audio, set this item to **Disabled**.

- ☞ **PCH LAN Controller**
 Enables or disables the onboard LAN function. (Default: Enabled)
 If you wish to install a 3rd party add-in network card instead of using the onboard LAN, set this item to **Disabled**.
- ☞ **Init Display First**
 Specifies the first initiation of the monitor display from the installed PCI Express graphics card or the onboard graphics.

 - ▶▶ Auto Lets BIOS automatically configure this setting. (Default)
 - ▶▶ IGFX Sets the onboard graphics as the first display.
 - ▶▶ PEG Sets the PCI Express graphics card on the PCIEX16 slot as the first display.
- ☞ **Internal Graphics**
 Enables or disables the onboard graphics function. (Default: Auto)
- ☞ **Internal Graphics Memory Size**
 Allows you to set the onboard graphics memory size. Options are: 32M~1024M. (Default: 64M)
- ☞ **DVMT Total Memory Size**
 Allows you to allocate the DVMT memory size of the onboard graphics. Options are: 128M, 256M, MAX. (Default: MAX)
- ☞ **Intel(R) Rapid Start Technology**
 Enables or disables Intel Rapid Start Technology. This item is configurable only when an SSD is installed. (Default: Disabled)
- ☞ **Legacy USB Support**
 Allows USB keyboard/mouse to be used in MS-DOS. (Default: Enabled)
- ☞ **XHCI Hand-off**
 Determines whether to enable XHCI Hand-off feature for an operating system without XHCI Hand-off support. (Default: Enabled)
- ☞ **EHCI Hand-off**
 Determines whether to enable EHCI Hand-off feature for an operating system without EHCI Hand-off support. (Default: Disabled)
- ☞ **Port 60/64 Emulation**
 Enables or disables emulation of I/O ports 64h and 60h. This should be enabled for full legacy support for USB keyboards/mice in MS-DOS or in operating system that does not natively support USB devices. (Default: Disabled)
- ☞ **USB Storage Devices**
 Displays a list of connected USB mass storage devices. This item appears only when a USB storage device is installed.
- ▶ **Trusted Computing**
- ☞ **TPM SUPPORT**
 Enables or disables Trusted Platform Module (TPM). Set this item to **Enable** when a TPM device is installed. (Default: Disable)
- ▶ **Intel(R) Smart Connect Technology**
- ☞ **ISCT Configuration**
 Enables or disables Intel Smart Connect Technology. (Default: Disabled)

2-7 Power Management



AC BACK

Determines the state of the system after the return of power from an AC power loss.

- ▶▶ Always Off The system stays off upon the return of the AC power. (Default)
- ▶▶ Always On The system is turned on upon the return of the AC power.
- ▶▶ Memory The system returns to its last known awake state upon the return of the AC power.

Power On By Keyboard

Allows the system to be turned on by a PS/2 keyboard wake-up event.

Note: To use this function, you need an ATX power supply providing at least 1A on the +5VSB lead.

- ▶▶ Disabled Disables this function. (Default)
- ▶▶ Any Key Press any key to turn on the system.
- ▶▶ Keyboard 98 Press POWER button on the Windows 98 keyboard to turn on the system.

Resume by Alarm

Determines whether to power on the system at a desired time. (Default: Disabled)

If enabled, set the date and time as following:

- ▶▶ Wake up day: Turn on the system at a specific time on each day or on a specific day in a month.
- ▶▶ Wake up hour/minute/second: Set the time at which the system will be powered on automatically.

Note: When using this function, avoid inadequate shutdown from the operating system or removal of the AC power, or the settings may not be effective.

Wake on LAN

Enables or disables the wake on LAN function. (Default: Enabled)

ErP

Determines whether to let the system consume less than 1W power in S5 (shutdown) state. (Default: Disabled)

Note: When this item is set to **Enabled**, the following functions will become unavailable: PME event wake up, power on by mouse, power on by keyboard, and wake on LAN.

☞ **High Precision Event Timer** ^(Note)

Enables or disables High Precision Event Timer (HPET) for Windows 7 operating system. (Default: Enabled)

☞ **Soft-Off by PWR-BTTN**

Configures the way to turn off the computer in MS-DOS mode using the power button.

- ▶▶ Instant-Off Press the power button and then the system will be turned off instantly. (Default)
- ▶▶ Delay 4 Sec Press and hold the power button for 4 seconds to turn off the system. If the power button is pressed for less than 4 seconds, the system will enter suspend mode.

☞ **Internal Graphics Standby Mode**

Allows you to determine whether to let the onboard graphics enter standby mode to decrease power consumption. (Default: Enabled)

☞ **Internal Graphics Deep Standby Mode**

Allows you to determine whether to let the onboard graphics enter deeper standby mode. (Default: Enabled)

(Note) Supported on Windows 7 operating system only.

2-8 Save & Exit



Save & Exit Setup

Press <Enter> on this item and select **Yes**. This saves the changes to the CMOS and exits the BIOS Setup program. Select **No** or press <Esc> to return to the BIOS Setup Main Menu.

Exit Without Saving

Press <Enter> on this item and select **Yes**. This exits the BIOS Setup without saving the changes made in BIOS Setup to the CMOS. Select **No** or press <Esc> to return to the BIOS Setup Main Menu.

Load Optimized Defaults

Press <Enter> on this item and select **Yes** to load the optimal BIOS default settings. The BIOS default settings help the system to operate in optimum state. Always load the Optimized defaults after updating the BIOS or after clearing the CMOS values.

Boot Override

Allows you to select a device to boot immediately. Press <Enter> on the device you select and select **Yes** to confirm. Your system will restart automatically and boot from that device.

Save Profiles

This function allows you to save the current BIOS settings to a profile. You can create up to 4 profiles and save as Setup Profile 1~ Setup Profile 4. Press <Enter> to complete.

Load Profiles

If your system becomes unstable and you have loaded the BIOS default settings, you can use this function to load the BIOS settings from a profile created before, without the hassles of reconfiguring the BIOS settings. First select the profile you wish to load and then press <Enter> to complete.

Chapter 3 Drivers Installation



- Before installing the drivers, first install the operating system.
- After installing the operating system, insert the motherboard driver disk into your optical drive. The driver Autorun screen is automatically displayed which looks like that shown in the screen shot below. (If the driver Autorun screen does not appear automatically, go to My Computer, double-click the optical drive and execute the **Run.exe** program.)

3-1 Installing Chipset Drivers



Now Loading Please wait...

After inserting the driver disk, "Xpress Install" will automatically scan your system and then list all the drivers that are recommended to install. You can click the **Install All** button and "Xpress Install" will install all the recommended drivers. Or click **Install Single Items** to manually select the drivers you wish to install.

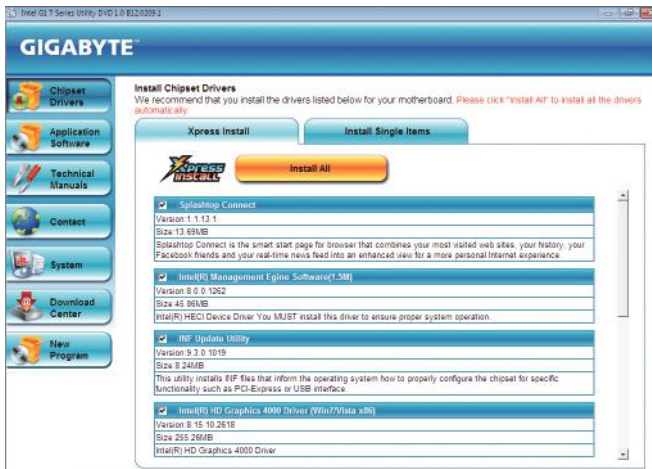

- Please ignore the popup dialog box(es) (e.g. the **Found New Hardware Wizard**) displayed when "Xpress Install" is installing the drivers. Failure to do so may affect the driver installation.
- Some device drivers will restart your system automatically during the driver installation. After the system restart, "Xpress Install" will continue to install other drivers.
- After "Xpress Install" installs all of the drivers, a dialog box will appear asking whether to install new GIGABYTE utilities. Click **Yes** to automatically install the utilities. Or click **No** if you want to manually select the utilities to install on the **Application Software** page later.

3-2 Application Software

This page displays all the utilities and applications that GIGABYTE develops and some free software. You can click the **Install** button on the right of an item to install it.

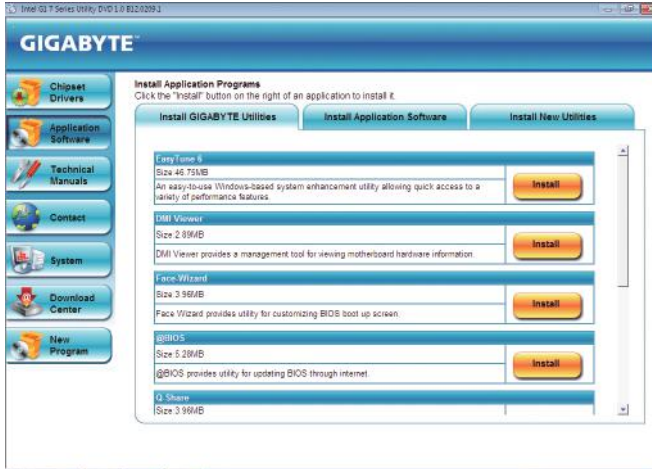

3-3 Technical Manuals

This page provides the content descriptions for this driver disk.

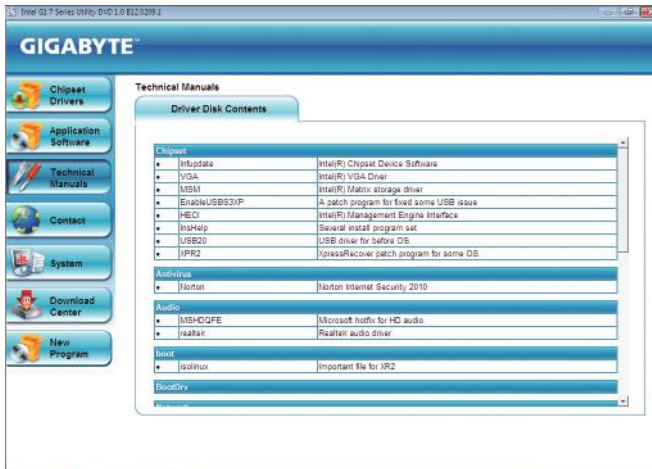

3-4 Contact

For the detailed contact information of the GIGABYTE Taiwan headquarter or worldwide branch offices, click the URL on this page to link to the GIGABYTE website.



3-5 System

This page provides the basic system information.

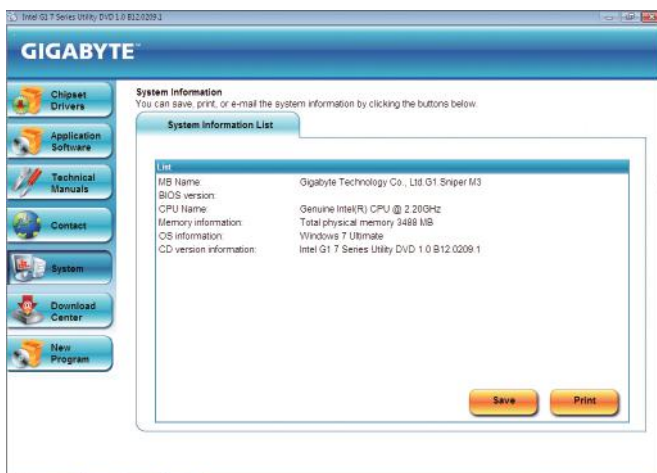

3-6 Download Center

To update the BIOS, drivers, or applications, click the **Download Center** button to link to the GIGABYTE website. The latest version of the BIOS, drivers, or applications will be displayed.

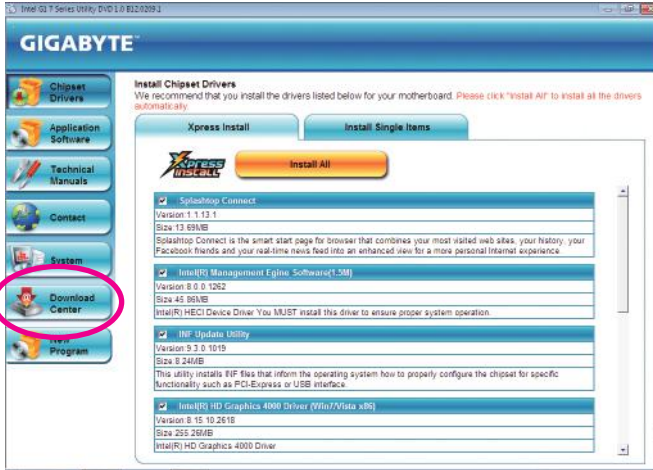

3-7 New Program

This page provides a quick link to GIGABYTE's lately developed utilities for users to install. You can click the **Install** button on the right of an item to install it.

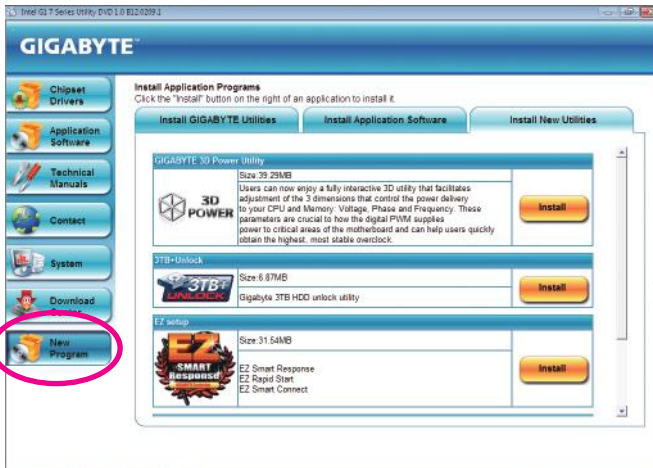

Chapter 4 Unique Features

4-1 Xpress Recovery2



Xpress Recovery2 is a utility that allows you to quickly compress and back up your system data and perform restoration of it. Supporting NTFS, FAT32, and FAT16 file systems, Xpress Recovery2 can back up data on PATA and SATA hard drives and restore it.

Before You Begin:

- Xpress Recovery2 will check the first physical hard drive ^(Note) for the operating system. Xpress Recovery2 can only back up/restore the first physical hard drive that has the operating system installed.
- As Xpress Recovery2 will save the backup file at the end of the hard drive, make sure to leave enough unallocated space in advanced (10 GB or more is recommended; actual size requirements vary, depending on the amount of data).
- It is recommended to back up your system soon after the operating system and drivers are installed.
- The amount of data and hard drive access speed may affect the speed at which the data is backed up/restored.
- It takes longer to back up a hard drive than to restore it.

System Requirements:

- At least 512 MB of system memory
- VESA compatible graphics card
- Windows 7



- Xpress Recovery and Xpress Recovery2 are different utilities. For example, a backup file created with Xpress Recovery cannot be restored using Xpress Recovery2.
- USB hard drives are not supported.
- RAID drives are not supported.
- GPT partitions are not supported.
- Hard drives larger than 2.2 TB are not supported.

Installation and Configuration:

Turn on your system to boot from the Windows 7 setup disk.

A. Installing Windows 7 and Partitioning the Hard Drive

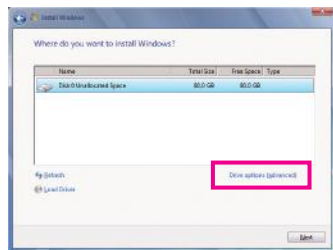

Step 1:
Click **Drive options**.

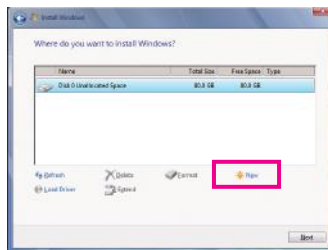

Step 2:
Click **New**.

(Note) Xpress Recovery2 checks the first physical hard drive in the following sequence: The first SATA connector, the second SATA connector and so forth. For example, When hard drives are attached to the first and third SATA connectors, the hard drive on the first SATA connector is the first physical drive.

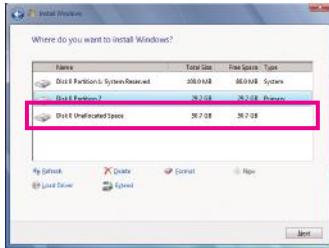

Step 3:
When partitioning your hard drive, make sure to leave unallocated space (10 GB or more is recommended; actual size requirements vary, depending on the amount of data) and begin the installation of the operating system.

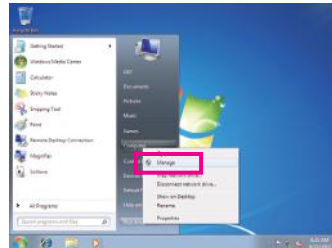

Step 4:
After the operating system is installed, click **Start**, right-click the **Computer** and select **Manage**. Go to **Disk Management** to check disk allocation.

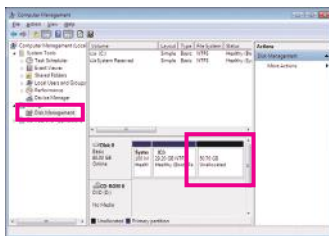

Step 5:
Xpress Recovery2 will save the backup file to the unallocated space (black stripe along the top). Please note that if there is no enough unallocated space, Xpress Recovery2 cannot save the backup file.

B. Accessing Xpress Recovery2

Boot from the motherboard driver disk to access Xpress Recovery2. When you see the following message: Press any key to startup Xpress Recovery2, press any key to enter Xpress Recovery2.

C. Using the Backup Function in Xpress Recovery2

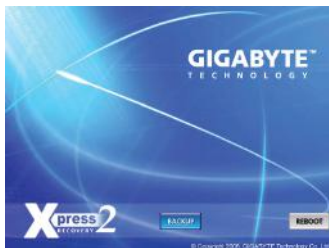

Step 1:
Select **BACKUP** to start backing up your hard drive data.

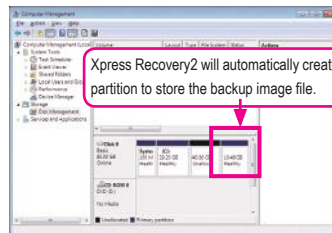

Step 2:
When finished, go to **Disk Management** to check disk allocation.

D. Using the Restore Function in Xpress Recovery2



Select **RESTORE** to restore the backup to your hard drive in case the system breaks down. The **RESTORE** option will not be present if no backup is created before.

E. Removing the Backup



Step 1:

If you wish to remove the backup file, select **REMOVE**.



Step 2:

After the backup file is removed, no backup image file will be present in **Disk Management** and hard drive space will be freed up.

F. Exiting Xpress Recovery2



Select **REBOOT** to exit Xpress Recovery2.

4-2 BIOS Update Utilities

GIGABYTE motherboards provide two unique BIOS update tools, Q-Flash™ and @BIOS™. GIGABYTE Q-Flash and @BIOS are easy-to-use and allow you to update the BIOS without the need to enter MS-DOS mode. Additionally, this motherboard features the DualBIOS™ design, which enhances protection for the safety and stability of your computer by adding one more physical BIOS chip.



What is DualBIOS™?

Motherboards that support DualBIOS have two BIOS onboard, a main BIOS and a backup BIOS. Normally, the system works on the main BIOS. However, if the main BIOS is corrupted or damaged, the backup BIOS will take over on the next system boot and copy the BIOS file to the main BIOS to ensure normal system operation. For the sake of system safety, users cannot update the backup BIOS manually.



What is Q-Flash™?

With Q-Flash you can update the system BIOS without having to enter operating systems like MS-DOS or Windows first. Embedded in the BIOS, the Q-Flash tool frees you from the hassles of going through complicated BIOS flashing process.



What is @BIOS™?

@BIOS allows you to update the system BIOS while in the Windows environment. @BIOS will download the latest BIOS file from the nearest @BIOS server site and update the BIOS.

4-2-1 Updating the BIOS with the Q-Flash Utility

A. Before You Begin

1. From GIGABYTE's website, download the latest compressed BIOS update file that matches your motherboard model.
2. Extract the file and save the new BIOS file (e.g. SNIPERM3.F1) to your USB flash drive or hard drive. Note: The USB flash drive or hard drive must use FAT32/16/12 file system.
3. Restart the system. During the POST, press the <End> key to enter Q-Flash. Note: You can access Q-Flash by either pressing the <End> key during the POST or pressing the <F8> key in BIOS Setup. However, if the BIOS update file is saved to a hard drive in RAID/AHCI mode or a hard drive attached to an independent SATA controller, use the <End> key during the POST to access Q-Flash.



Because BIOS flashing is potentially risky, please do it with caution. Inadequate BIOS flashing may result in system malfunction.

B. Updating the BIOS

In the main menu of Q-Flash, use the keyboard or mouse to select an item to execute. When updating the BIOS, choose the location where the BIOS file is saved. The following procedure assumes that you save the BIOS file to a USB flash drive.

Step 1:

1. Insert the USB flash drive containing the BIOS file into the computer. In the main menu of Q-Flash, select **Update BIOS From Drive**.



- The **Save BIOS to Drive** option allows you to save the current BIOS file.
- Q-Flash only supports USB flash drive or hard drives using FAT32/16/12 file system.
- If the BIOS update file is saved to a hard drive in RAID/AHCI mode or a hard drive attached to an independent SATA controller, use the <End> key during the POST to access Q-Flash.

2. Select **Flash Disk**.

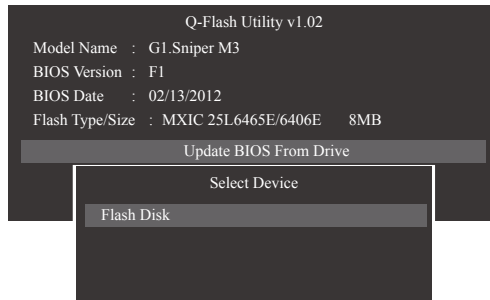

3. Select the BIOS update file.



Make sure the BIOS update file matches your motherboard model.

Step 2:

The process of the system reading the BIOS file from the USB flash drive is displayed on the screen. When the message "Are you sure to update BIOS?" appears, select **Yes** to begin the BIOS update. The monitor will display the update process.



- **Do not turn off or restart the system when the system is reading/updating the BIOS.**
- **Do not remove the USB flash drive or hard drive when the system is updating the BIOS.**

Step 3:

When the update process is complete, select **Reboot** to reboot the system.

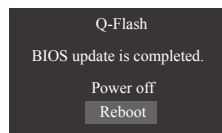

Step 4:

During the POST, press <Delete> to enter BIOS Setup. Select **Load Optimized Defaults** on the **Save & Exit** screen and press <Enter> to load BIOS defaults. System will re-detect all peripheral devices after a BIOS update, so we recommend that you reload BIOS defaults.



Select **Yes** to load BIOS defaults

Step 5:

Select **Save & Exit Setup** and press <Enter>. And then select **Yes** to save settings to CMOS and exit BIOS Setup. The procedure is complete after the system restarts.





4-2-2 Updating the BIOS with the @BIOS Utility

A. Before You Begin

1. In Windows, close all applications and TSR (Terminate and Stay Resident) programs. This helps prevent unexpected failures when performing a BIOS update.
2. During the BIOS update process, ensure the Internet connection is stable and do NOT interrupt the Internet connection (for example, avoid a power loss or switching off the Internet). Failure to do so may result in a corrupted BIOS or a system that is unable to start.
3. Do not use the G.O.M. (GIGABYTE Online Management) function when using @BIOS.
4. GIGABYTE product warranty does not cover any BIOS damage or system failure resulting from an inadequate BIOS flashing.

B. Using @BIOS



1.  **Update the BIOS Using the Internet Update Function:**
Click **Update BIOS from GIGABYTE Server**, select the @BIOS server site closest to your location and then download the BIOS file that matches your motherboard model. Follow the on-screen instructions to complete.
 If the BIOS update file for your motherboard is not present on the @BIOS server site, please manually download the BIOS update file from GIGABYTE's website and follow the instructions in "Update the BIOS without Using the Internet Update Function" below.
2.  **Update the BIOS without Using the Internet Update Function:**
Click **Update BIOS from File**, then select the location where you save the BIOS update file obtained from the Internet or through other source. Follow the on-screen instructions to complete.
3.  **Save the Current BIOS File:**
Click **Save Current BIOS to File** to save the current BIOS file.
4.  **Load BIOS Defaults after BIOS Update:**
Select the **Load CMOS default after BIOS update** check box and then the system will automatically load BIOS defaults after BIOS update and after the system restarts.

C. After Updating the BIOS

Restart your system after updating the BIOS.



Make sure that the BIOS file to be flashed matches your motherboard model. Updating the BIOS with an incorrect BIOS file could cause your system not to boot.







4-3 EasyTune 6

GIGABYTE's EasyTune 6 is a simple and easy-to-use interface that allows users to fine-tune their system settings or do overclock/overvoltage in Windows environment. The user-friendly EasyTune 6 interface also includes tabbed pages for CPU and memory information, letting users read their system-related information without the need to install additional software.

The EasyTune 6 Interface



Tabs Information

Tab	Function
	The CPU tab provides information on the installed CPU and motherboard.
	The Memory tab provides information on the installed memory module(s). You can select memory module on a specific slot to see its information.
	<p>The Tuner tab allows you to change memory settings and voltages.</p> <ul style="list-style-type: none"> • Quick Boost mode provides you with 3 levels of CPU frequency/base clock to choose to achieve desired system performance. After making changes in Quick Boost mode or clicking Default to restore to default values, be sure to restart your system for these changes to take effect. • Easy mode provides information on CPU/memory. • Advanced mode allows you to individually change system clock settings and voltages settings using the sliders. • Save allows you to save the current settings to a new profile (.txt file). • Load allows you to load previous settings from a profile. <p>After making changes in Easy mode/Advanced mode, be sure to click Set for these changes to take effect or click Default to restore to default values.</p> <p>The Auto-Tuning button automatically provides you with the fastest and most stable frequency to enhance system performance.</p>
	The Graphics tab allows you to change the core clock and memory clock for your AMD or NVIDIA graphics card.
	The Smart tab allows you to specify a Smart Fan mode. Smart Fan Advanced mode allows the fan speed to be changed linearly based on the temperature thresholds you set.
	The HW Monitor tab allows you to monitor hardware temperature, voltage and fan speed and set temperature/fan speed alarm. You can choose the alert sound from the buzzer or use your own sound file (.wav file).



Available functions in EasyTune 6 may differ by motherboard model. Grayed-out area(s) indicates that the item is not configurable or the function is not supported.



Incorrectly doing overclock/overvoltage may result in damage to the hardware components such as CPU, chipset, and memory and reduce the useful life of these components. Before you do the overclock/overvoltage, make sure that you fully know each function of EasyTune 6, or system instability or other unexpected results may occur.

4-4 Q-Share

Q-Share is an easy and convenient data sharing tool. After configuring your LAN connection settings and Q-Share, you are able to share your data with computers on the same network, making full use of Internet resources.

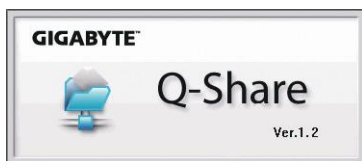

Directions for using Q-Share

After installing Q-Share from the motherboard driver disk, go to Start>All Programs>GIGABYTE>Q-Share.exe to launch the Q-Share tool. Find the **Q-Share** icon  in the notification area and right-click on this icon to configure the data sharing settings.

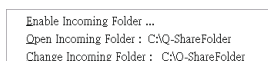

Figure 1. Data Sharing Disabled



Figure 2. Data Sharing Enabled

Options Descriptions

Option	Description
Connect ...	Displays the computers with data sharing enabled
Enable Incoming Folder ...	Enables data sharing
Disable Incoming Folder ...	Disables data sharing
Open Incoming Folder : C:\Q-ShareFolder	Accesses the shared data folder
Change Incoming Folder : C:\Q-ShareFolder	Changes the data folder to be shared <small>(Note)</small>
Update Q-Share ...	Updates Q-Share online
About Q-Share ...	Displays the current Q-Share version
Exit...	Exits Q-Share

(Note) This option is available only when data sharing is NOT enabled.

4-5 eXtreme Hard Drive (X.H.D)



With GIGABYTE eXtreme Hard Drive (X.H.D) ^(Note 1), users can quickly configure a RAID-ready system for RAID 0 when a new SATA drive is added. For a RAID 0 array that already exists, users also can use X.H.D to easily add a hard drive into the array to expand its capacity. All with a simple click of a button, X.H.D helps to enhance your hard drive read/write performance without the need for complex and time-consuming configurations. The following procedure details the steps to set up a RAID-ready system and configure it for RAID 0.

A. Setting Up a RAID-Ready System

Step 1: Configure the system BIOS

Enter the system BIOS Setup program to enable RAID for the Intel SATA controllers.

Step 2: Install the RAID driver and operating system

The X.H.D utility supports Windows 7. Before installing the operating system, you have to load the SATA controller driver first. Without the driver, the hard drive may not be recognized during the Windows setup process. (For more details, refer to Chapter 5, "Installing the SATA RAID/AHCI Driver and Operating System.")

Step 3: Install the motherboard drivers and the X.H.D utility

After installing the operating system, insert the motherboard driver disk. You can click the **Xpress Install All** button to automatically install all motherboard drivers, including the X.H.D utility. Or you can go to the **Application Software** screen to individually install the X.H.D utility later.

B. Using GIGABYTE eXtreme Hard Drive (X.H.D)



Instructions ^(Note 2):

Before launching X.H.D, make sure the newly added harddrive has equal or greater capacity than the RAID-ready system drive. (To add a new hard drive into a RAID 0 array that's been created earlier, make sure the new drive is greater than or equal to the biggest drive in the array.)

1. **Auto** **To automatically set up a RAID 0 array:**
Click **Auto** to automatically and quickly set up a RAID 0 array.
2. **Manual** **To manually set up a RAID array ^(Note 3):**
Click **Manual** to access the Intel Rapid Storage Technology, with which you can build a RAID 0, RAID 1, or other supported RAID array depending on your needs and hardware components.
3. **Cancel** **Exits the X.H.D utility:**
Click **Cancel** to exit the X.H.D utility.

(Note 1) The X.H.D utility only supports the SATA controllers integrated in the Intel Chipset.

(Note 2) It is recommended that before you run the X.H.D utility, back up all of your data to avoid risk of hardware damage or lost of data.

(Note 3) If you manually build a non-RAID 0 array, you'll not be able to automatically set up a RAID 0 array later using the **Auto** function.

4-6 Auto Green

Auto Green is an easy-to-use tool that provides users with simple options to enable system power savings via a Bluetooth cell phone. When the phone is out of the range of the computer's Bluetooth receiver, the system will enter the specified power saving mode.

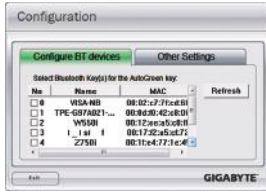

The Configuration dialog box:

First, you have to set your Bluetooth cell phone as a portable key. On the Auto Green main menu, click **Configure** and then click **Configure BT devices**. Select the Bluetooth cell phone that you want to use as the portable key (Note 1). (If the screen doesn't display your Bluetooth cell phone, click **Refresh** to let Auto Green re-detect the device.)



Before creating a Bluetooth cell phone key, make sure your motherboard has a Bluetooth receiver and you have turned on the search and Bluetooth functions on your phone.



Configuring the Bluetooth cell phone key:

After you select a cell phone, the **Add device** as shown on the left will appear. Enter a passkey (8~16 digits recommended) which will be used for pairing with the cell phone. Then enter the same passkey on your cell phone.



Configuring other Bluetooth settings:

On the **Other Settings** tab, you can set how much time it takes to scan your Bluetooth cell phone key, how many times to rescan the key to make sure it is in range of your computer, and when to turn off the hard drive if the system energy saving state lasts over the predetermined period of time. After completing the settings, click **Set** for the settings to take effect and then click **Exit** to quit.

- **Device Scan Time (sec.):**
Set the length of time Auto Green scans your Bluetooth cell phone key, ranging from 5 to 30 seconds in 5-second increment. Auto Green searches for the key based on the length of time you set.
- **Rescan Times:**
Set how many times Auto Green will rescan your Bluetooth cell phone key if it does not detect it, ranging from 2 to 5 times. Auto Green will keep rescanning according to the times you set. When the times limit is reached and your Bluetooth cell phone key is still not detected, the system will enter the selected energy saving mode.
- **Turn off HD:**
Set when to turn off the hard drive. If the system inactivity time exceeds the specified time limit, the hard drive will be turned off.



Selecting a system energy saving mode:

Depending on your needs, select a system power saving mode on the Auto Green main menu and click **Save** to save the settings.

Button	Description
Standby	Enters Power on Suspend mode
Suspend	Enters Suspend to RAM mode
Disable	Disables this function



The Bluetooth dongle included in the motherboard package (Note 2) allows you to wake up the system from Suspend to RAM mode without the need to press the power button first.

(Note 1) If your cell phone has been configured as the Auto Green key, you'll not be able to use it to connect to other Bluetooth device(s) when Auto Green is enabled.

(Note 2) Whether the Bluetooth dongle is included depends on the motherboard models. Before installing the Bluetooth dongle, be sure to turn off other Bluetooth receiver on your computer.

4-7 Intel Rapid Start Technology

A. System Requirements

1. Windows 7 with SP1
2. An SSD with size larger than the total system memory
3. Intel Rapid Start Technology enabled in BIOS Setup
4. AHCI/RAID mode supported (please note if the SSD has been assigned as a member of a RAID array, it cannot be used to set up Intel Rapid Start store partition); IDE mode not supported
5. All motherboard drivers correctly installed

B. Creating a Primary Store Partition

Below it is assumed Windows 7 is already installed on the SATA hard drive.

Open Disk Management Tool

Step 1: Go to Control Panel > System and Security > Administrative Tools > Computer Management > Storage > Disk Management.

Step 2: Select the SSD on which you want to create the store partition (if the SSD is unallocated, create a new partition first), and right-click on the partition you select and select **Shrink Volume**. (Figure 1)

Step 3: Enter the size of the required partition (it should be at least equal to the size of the memory currently installed on the system. (1 GB=1024 MB. For example, to set 8 GB, enter 8192 MB). The recommendation is to create a partition equal to the maximum memory capacity supported on the system, in order to take care of future memory upgrade scenarios.)

Step 4: When completed, click **Shrink**. (Figure 2)

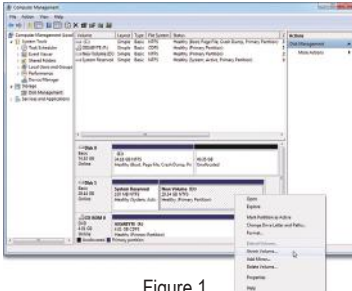

Figure 1

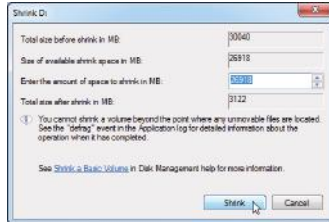

Figure 2

C. Launching DiskPart Disk Partitioning Tool to Set up Intel Rapid Start Store Partition

Open the command prompt window and run diskpart.exe (enter "diskpart" at the C:\> command prompt and press <Enter>). At the diskpart prompt, type the following commands in sequence. Note: The commands for MBR format and GPT format are different. Refer to the commands below. After entering all of the commands, be sure to restart your computer.

MBR format:

```
DISKPART>list disk  
DISKPART>select disk X
```

(Lists the disks and information about them)
(Selects a disk. "X" is the disk number where you want to create the store partition. Refer to results from "list disk" for the exact disk number)

```
DISKPART>create partition primary
```

(Create the primary store partition)

DISKPART>detail disk (Displays the properties of the selected disk and the volumes on that disk)

DISKPART>select volume X (Selects the specified volume. "X" is volume of your store partition. Refer to the results from "detail disk" for exact volume number)

DISKPART>set id=84 override (Change the partition type) (Figure 3)

GPT format:

Follow the commands for MBR format. When you execute the last command where you change the partition type (set id="XXX"), enter the following command instead (Figure 4):

DISKPART>set id=D3BFE2DE-3DAF-11DF-BA40-E3A556D89593

You have created the Intel Rapid Start Technology store partition after completing the commands above. Restart your computer.

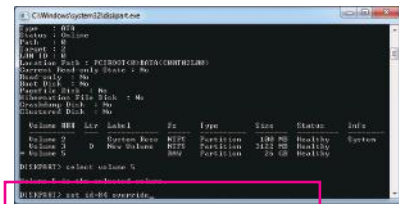

Figure 3

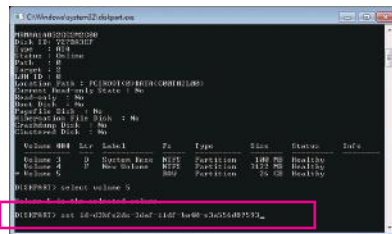



Figure 4

D. Enabling the Intel Rapid Start Technology in BIOS Setup

1. When the system restarts, press <Delete> to enter the BIOS Setup program. Go to the **Peripherals** menu and set **Intel Rapid Start Technology** to **Enabled**.
2. Save the settings and exit BIOS Setup.

E. Installing and Configuring the Intel Rapid Start Application

1. While in the operating system, insert the motherboard driver disk, go to Application Software\Install Application Software, and select **Intel Rapid Start Technology** to install. After the installation is complete, we recommend that you restart the system.
2. Launch the **Intel Rapid Start Technology Manager** application from Start\All Programs\Intel or click the  icon in the notification area.



Instructions:

The Intel Rapid Start application allows you to enable or disable the Intel Rapid Start Technology. The **Timer** slider in **Advanced Settings** allows you to set when to copy and move the data from the memory to the SSD after entering S3 mode.

4-8 Intel Smart Connect Technology

Intel Smart Connect Technology^(Note) allows user's computer to automatically update programs designed to work with the Internet to obtain their data while your system is suspended (sleeping). The user can obtain the latest data when the computer is waked up.

A. System Requirements

1. Intel Smart Connect Technology enabled in BIOS Setup
2. Windows 7 with SP1
3. Normal network connection

B. Configuring Intel Smart Connect Technology

Step 1:

After installing the operating system and motherboard drivers, install the Intel Smart Connect Technology application. Restart your computer when completed.

Step 2:

As shown in the left screenshot below, click the **Start** button and type `regedit` in the search field to open the registry editor. Look for the following directory in the registry editor:

Computer\HKEY_LOCAL_MACHINE\SOFTWARE\Intel\Intel Smart Connect Technology

Right-click on **Intel Smart Connect Technology** and select **New > Key**. Type `OEM`.

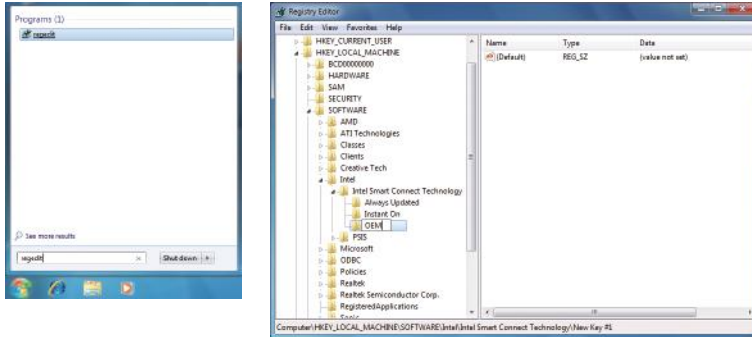

(Note) Intel Smart Connect Technology is for S3 mode only. During the updating process, the monitor will not light up and no sound will be output from the speaker. This feature works best with programs designed to work automatically with the Internet to obtain their data such as Microsoft Outlook®, Microsoft Windows Live™ Mail, and Seesmic®.

Step 3:

As shown in the left screenshot below, right-click on **OEM**, select **New > Multi-String Value**, and type `WhiteList`. Double-click `WhiteList` and type the application name to be added in **Edit Multi-String**. For example, to add Microsoft Outlook, type `outlook.exe`; to add Microsoft Windows Live, type `wlmail.exe`. Restart your computer when completed.

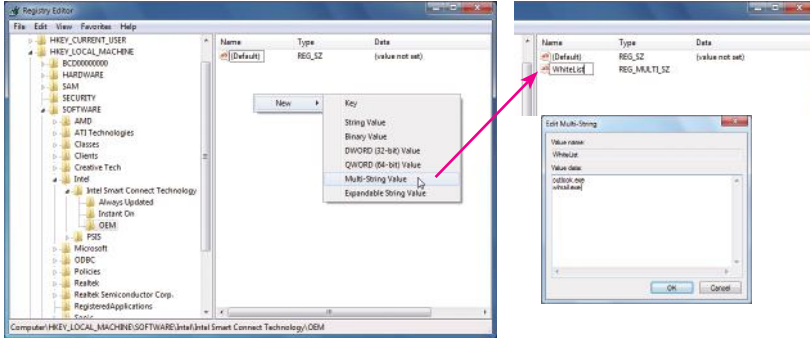

Step 4:

After completing the steps above, go to Start\All Programs\Intel and launch **Intel(R) Smart Connect Technology**. On the **Intel® Smart Connect Technology Configuration** menu, click **Enable Updating** on the **Basic** tab. (The **Enable Updating** button has now changed to **Disable Updating**.)



On this menu, the user can set the update frequency to 5 to 60 minutes. (Default: 15 minutes)

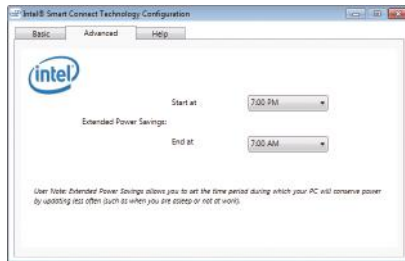

The **Advanced** tab allows you to set the time period during which the updates will be performed only every two hours (such as when you are asleep).

4-9 Intel Smart Response

A. System Requirements

1. An Intel Chipset-based motherboard
2. An Intel Core series processor
3. RAID enabled for the Intel SATA controllers in BIOS Setup
4. A conventional SATA disk and an SSD ^(Note 1)
5. Windows 7 with SP1 ^(Note 2)
6. All motherboard drivers correctly installed



If you have installed the operating system before configuring the Smart Response Technology, all original data on the hard disk will be lost once you enable RAID mode. It is recommended that you back up the hard disk before enabling the Smart Response Technology.

B. Configuring Intel Smart Response Technology

Step 1:

While in the operating system, use the "Xpress Install" function of the motherboard driver disk to install all motherboard drivers, including the Intel Rapid Storage Technology driver. Restart your computer when completed.



Make sure the Intel Rapid Storage Technology driver version is 11.0 or above.

Step 2:

Find the IRST icon  in the notification area and double-click it to open the Intel Rapid Storage Technology utility.

Step 3:

On the main screen, click the **Accelerate** button and then click **Enable acceleration**.



(Note 1) The SSD works as a cache of the hard disk. The maximum cache memory size is 64 GB. If you use an SSD larger than 64 GB, the space beyond 64 GB can still be used for storing your data.

(Note 2) The operating system must be installed to the SATA disk.

Step 4:

After selecting the SSD you want to use, the size of the SSD allocated for the cache memory, the hard disk/volume to accelerate, and the acceleration mode, click **OK** to complete the configuration of the Intel Smart Response Technology.

The "Enable Acceleration" Dialog Box:

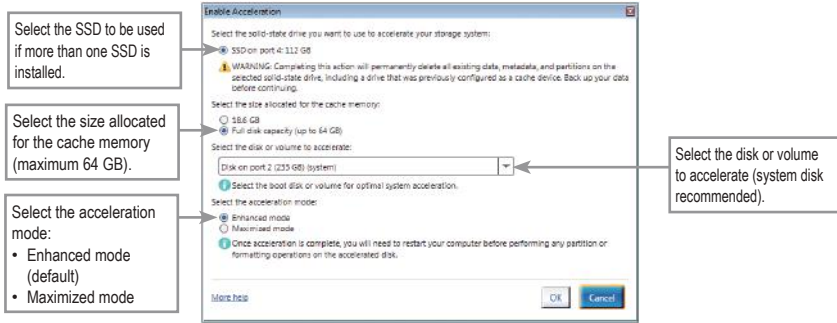

• **Enhanced mode (default)**

In this mode, data is written to the cache memory and the disk simultaneously. In the event that the accelerated disk or volume is disconnected, there is no risk of data loss because data on the disk is always synchronized with the data in the cache memory.

• **Maximized mode**

In this mode, cached data is written to the accelerated disk or volume at intervals to increase performance. If the cache device is reported as missing or failed and it contained data that had not yet been written to the accelerated disk or volume, then that data will be lost.

Chapter 5 Appendix

5-1 Configuring SATA Hard Drive(s)

RAID Levels

	RAID 0	RAID 1	RAID 5	RAID 10
Minimum Number of Hard Drives	≥2	2	≥3	≥4
Array Capacity	Number of hard drives * Size of the smallest drive	Size of the smallest drive	(Number of hard drives - 1) * Size of the smallest drive	(Number of hard drives/2) * Size of the smallest drive
Fault Tolerance	No	Yes	Yes	Yes

To configure SATA hard drive(s), follow the steps below:

- A. Install SATA hard drive(s) in your computer.
- B. Configure SATA controller mode in BIOS Setup.
- C. Configure a RAID array in RAID BIOS. (Note 1)
- D. Install the SATA RAID/AHCI driver and operating system. (Note 2)

Before you begin

Please prepare:

- At least two SATA hard drives (to ensure optimal performance, it is recommended that you use two hard drives with identical model and capacity). If you do not want to create RAID, you may prepare only one hard drive.
- Windows 7 setup disk.
- Motherboard driver disk.

5-1-1 Configuring SATA Controllers

A. Installing SATA hard drive(s) in your computer

Attach one end of the SATA signal cable to the rear of the SATA hard drive and the other end to available SATA port^(Note 3) on the motherboard. Then connect the power connector from your power supply to the hard drive.

(Note 1) Skip this step if you do not want to create RAID array on the SATA controller.

(Note 2) Required when the SATA controller is set to AHCI or RAID mode.

(Note 3) When a RAID set is built across the SATA 6Gb/s and SATA 3Gb/s channels, the system performance of the RAID set may vary depending on the devices being connected.

B. Configuring SATA controller mode in BIOS Setup

Make sure to configure the SATA controller mode correctly in system BIOS Setup.

Step 1:

Turn on your computer and press <Delete> to enter BIOS Setup during the POST (Power-On Self-Test). To create RAID, set **SATA Mode Selection** under the **Peripherals** menu to **RAID** (Figure 1). If you do not want to create RAID, set this item to **IDE** or **AHCI**.



Figure 1

Step 2:

Save changes and exit BIOS Setup.



The BIOS Setup menus described in this section may differ from the exact settings for your motherboard. The actual BIOS Setup menu options you will see shall depend on the motherboard you have and the BIOS version.

C. Configuring a RAID array in RAID BIOS

Enter the RAID BIOS setup utility to configure a RAID array. Skip this step and proceed with the installation of Windows operating system for a non-RAID configuration.

Step 1:

After the POST memory test begins and before the operating system boot begins, look for a message which says "Press <Ctrl-I> to enter Configuration Utility" (Figure 2). Press <Ctrl> + <I> to enter the RAID Configuration Utility.

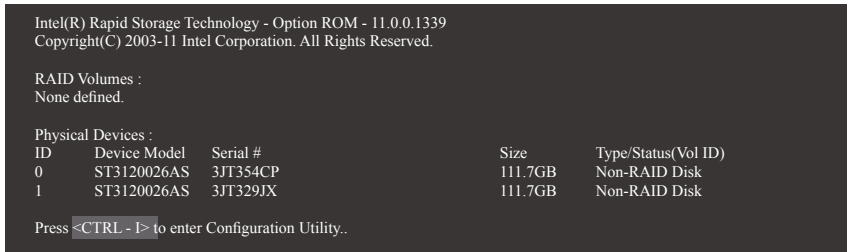

Figure 2

Step 2:

After you press <Ctrl> + <I>, the **MAIN MENU** screen will appear (Figure 3).

Create RAID Volume

If you want to create a RAID array, select **Create RAID Volume** in **MAIN MENU** and press <Enter>.

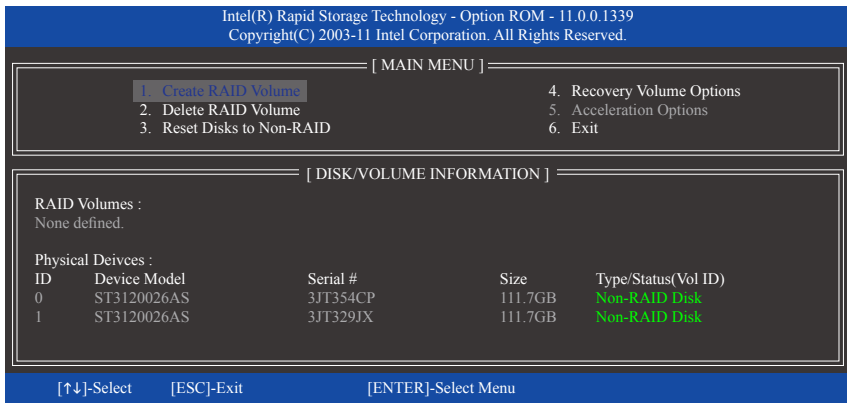

Figure 3

Step 3:

After entering the **CREATE VOLUME MENU** screen, enter a volume name with 1~16 letters (letters cannot be special characters) under the **Name** item and press <Enter>. Then, select a RAID level (Figure 4). RAID levels supported include RAID 0, RAID 1, RAID 10, and RAID 5 (the selections available depend on the number of the hard drives being installed). Press <Enter> to proceed.

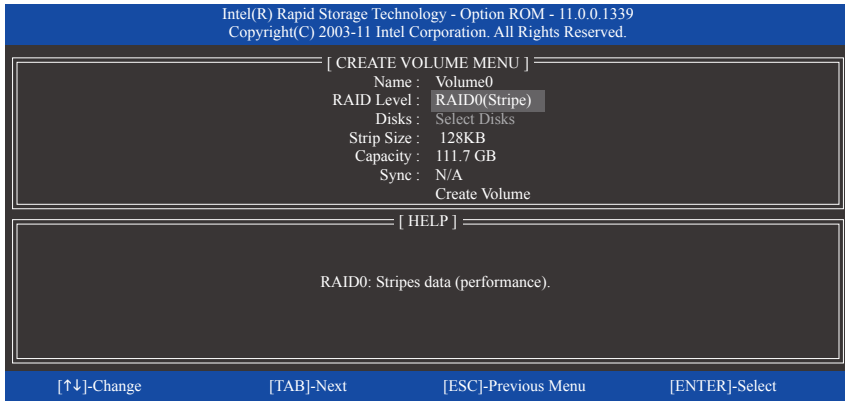

Figure 4

Step 4:

Under **Disks** item, select the hard drives to be included in the RAID array. If only two hard drives are installed, they will be automatically assigned to the array. Set the stripe block size (Figure 5) if necessary. The stripe block size can be set from 4 KB to 128 KB. Once you have selected the stripe block size, press <Enter>.

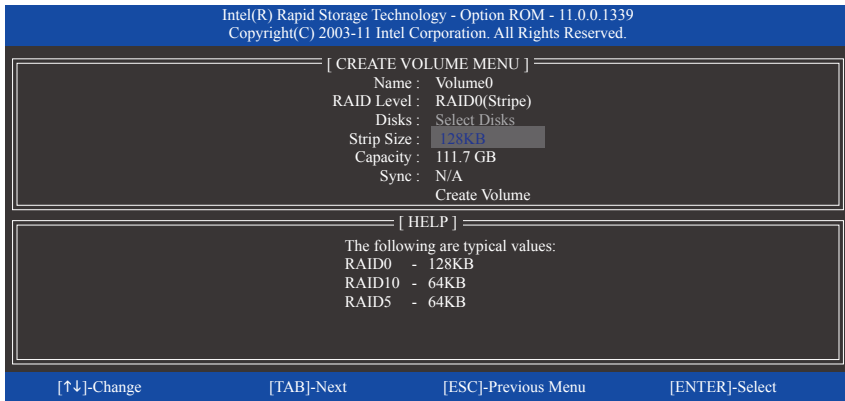

Figure 5

Step 5:

Enter the array capacity and press <Enter>. Finally press <Enter> on the **Create Volume** item to begin creating the RAID array. When prompted to confirm whether to create this volume, press <Y> to confirm or <N> to cancel (Figure 6).

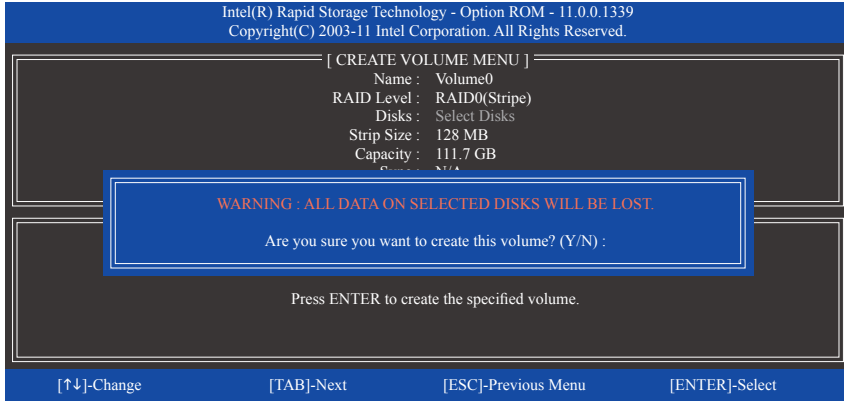

Figure 6

When completed, you can see detailed information about the RAID array in the **DISK/VOLUME INFORMATION** section, including the RAID level, stripe block size, array name, and array capacity, etc. (Figure 7)

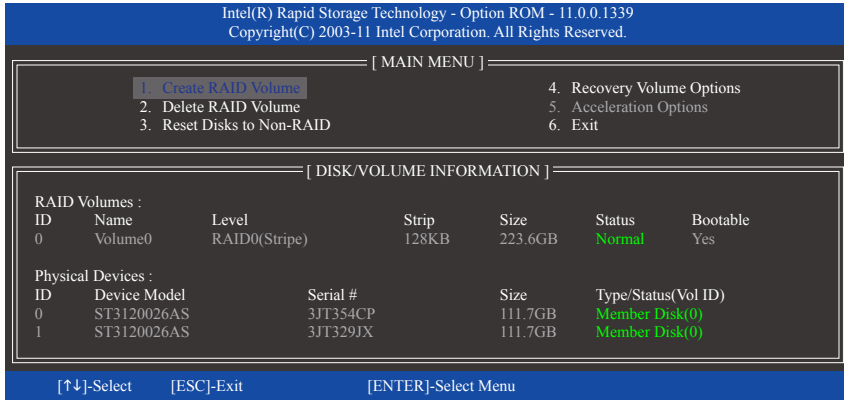

Figure 7

To exit the RAID BIOS utility, press <Esc> or select **6. Exit** in **MAIN MENU**.

Now, you can proceed to install the SATA RAID/AHCI driver and operating system.

Recovery Volume Options

Intel Rapid Recover Technology provides data protection by allowing users to easily restore data and system operation using a designated recovery drive. With the Rapid Recovery Technology, which employs RAID 1 functionality, users can copy the data from the master drive to the recovery drive; if needed, the data on the recovery drive can be restored back to the master drive.

Before you begin:

- The recovery drive must have equal or greater capacity than the master drive.
- A recovery volume can be created with two hard drives only. A recovery volume and a RAID array cannot co-exist in the system at the same time, that is, if you have already created a recovery volume, you are unable to create a RAID array.
- By default, only the master drive can be viewed in the operating system; the recovery drive is hidden.

Step 1:

Select **Create RAID Volume** in **MAIN MENU** and press <Enter> (Figure 8).

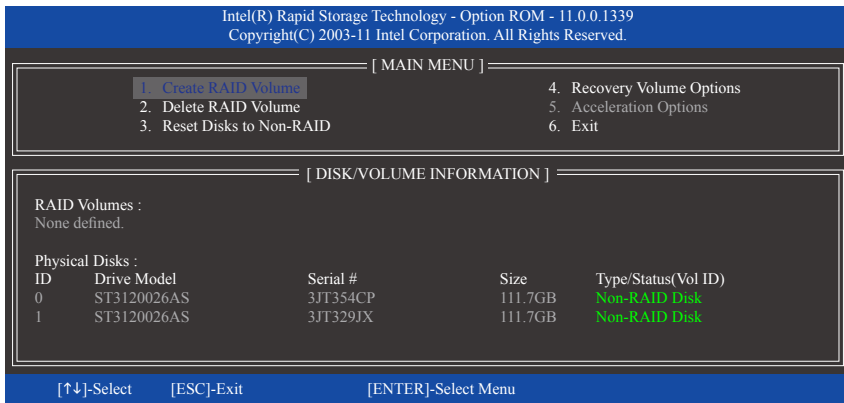

Figure 8

Step 2:

After entering the volume name, select **Recovery** under the **RAID Level** item and press <Enter> (Figure 9).

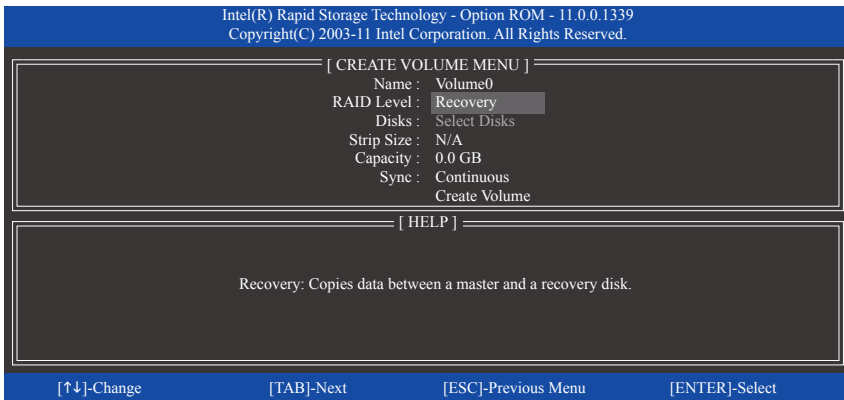

Figure 9

Step 3:

Press <Enter> under the **Select Disks** item. In the **SELECT DISKS** box, press <Tab> on the hard drive you want to use for the master drive and press <Space> on the hard drive you want to use for the recovery drive. (Make sure the recovery drive has equal or larger capacity than the master drive.) Then press <Enter> to confirm (Figure 10).

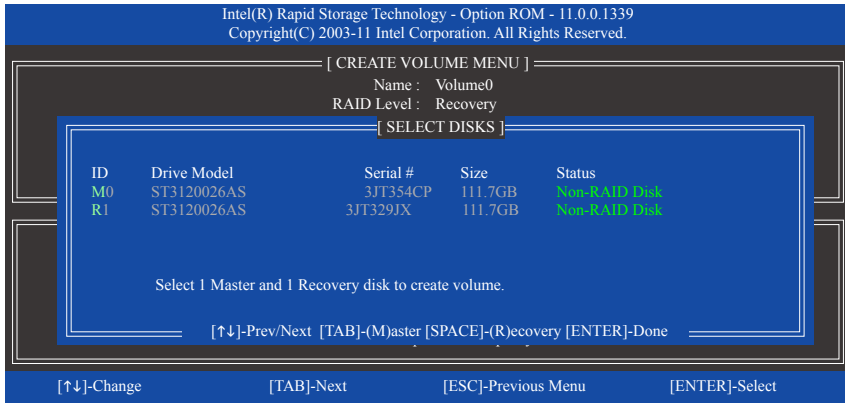

Figure 10

Step 4:

Under **Sync**, select **Continuous** or **On Request** (Figure 11). When set to **Continuous**, changes made to the data on the master drive will be automatically and continuously copied to the recovery drive when both hard drives are installed in the system. **On Request** allows users to update data from the master drive to the recovery drive manually using the Intel Rapid Storage Technology utility in the operating system. **On Request** also allows users to restore the master drive to a previous state.

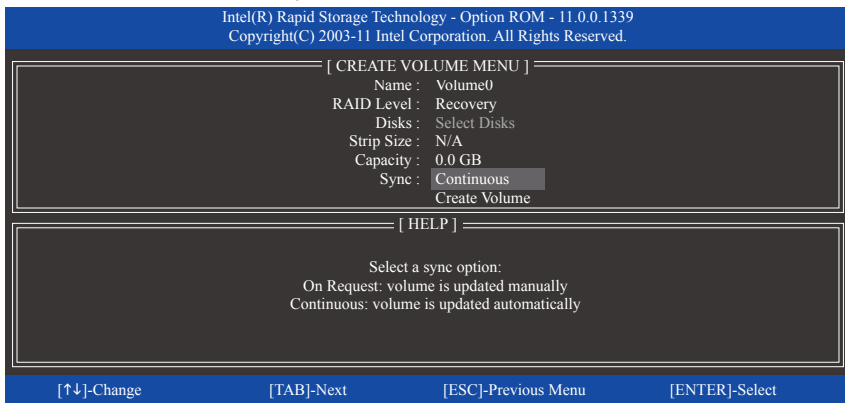

Figure 11

Step 5:

Finally press <Enter> on the **Create Volume** item to begin creating the Recovery Volume and follow the on-screen instructions to complete.

Delete RAID Volume

To delete a RAID array, select **Delete RAID Volume** in **MAIN MENU** and press <Enter>. In the **DELETE VOLUME MENU** section, use the up or down arrow key to select the array to be deleted and press <Delete>. When prompted to confirm your selection (Figure 12), press <Y> to confirm or <N> to abort.

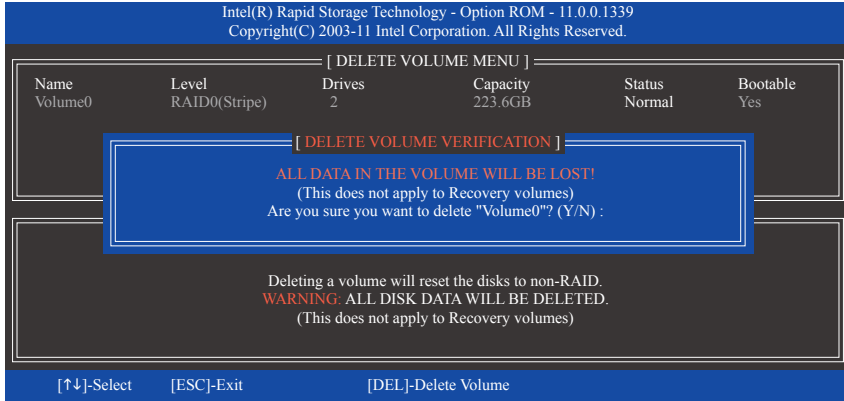

Figure 12

Acceleration Options

This option allows you to view the status of your accelerated drive/volume (Figure 13) created using the Intel IRST utility. In case you are unable to run the Intel IRST utility due to an application error or operating system issue, you will need to remove acceleration or manually enable synchronization (Maximized mode only) using this option in the RAID ROM utility.

Steps:

Select **Acceleration Options** in **MAIN MENU** and press <Enter>.

To remove the acceleration, select the accelerated drive/volume, press <R>, and press <Y> to confirm.

To synchronize data from the cache device to the accelerated drive/volume, press <S> and press <Y> to confirm.

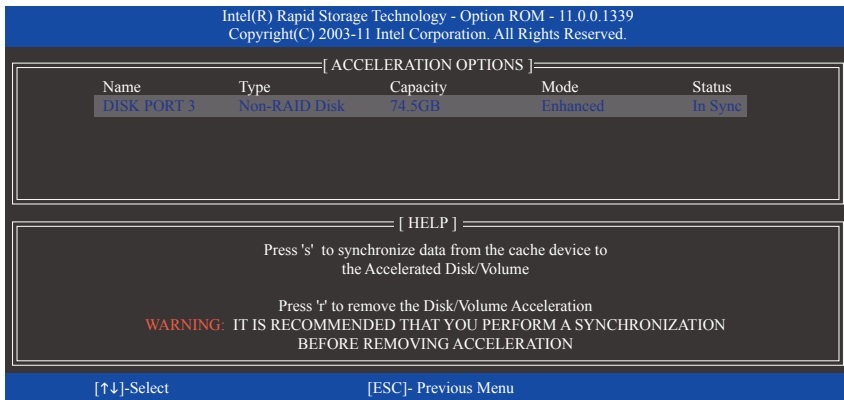

Figure 13

5-1-2 Installing the SATA RAID/AHCI Driver and Operating System

With the correct BIOS settings, you are ready to install Windows 7.

A. Installing Windows 7

As Windows 7 already include Intel SATA RAID/AHCI driver, you do not need to install separate RAID/AHCI driver during the Windows installation process. After the operating system is installed, we recommend that you install all required drivers from the motherboard driver disk using "Xpress Install" to ensure system performance and compatibility.

B. Rebuilding an Array

Rebuilding is the process of restoring data to a hard drive from other drives in the array. Rebuilding applies only to fault-tolerant arrays such as RAID 1, RAID 5 or RAID 10 arrays. The procedures below assume a new drive is added to replace a failed drive to rebuild a RAID 1 array. (Note: The new drive must have equal or greater capacity than the old one.)

Turn off your computer and replace the failed hard drive with a new one. Restart your computer.

• Enabling Automatic Rebuild

Step 1:

When the message "Press <Ctrl-> to enter Configuration Utility" appears, press <Ctrl> + <I> to enter the RAID Configuration Utility. The following screen appears after you enter the RAID Configuration Utility.

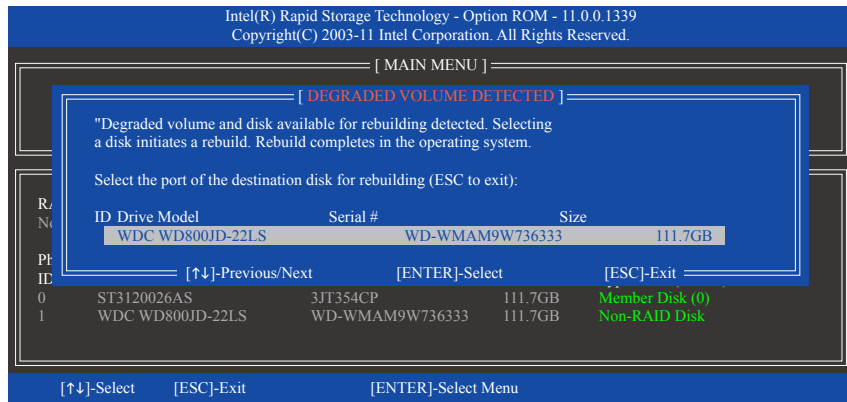

Step 2:

Select the new hard drive to add into the array to be rebuilt and press <Enter>. The following screen appears, indicating that an automatic rebuild will be performed after you enter the operating system (look for the **Intel Rapid Storage Technology** icon  in the notification area, which will show that a RAID volume is being rebuilt). If you do not enable automatic rebuild on this stage, you have to manually rebuild the array in the operating system (see the next page for more details).

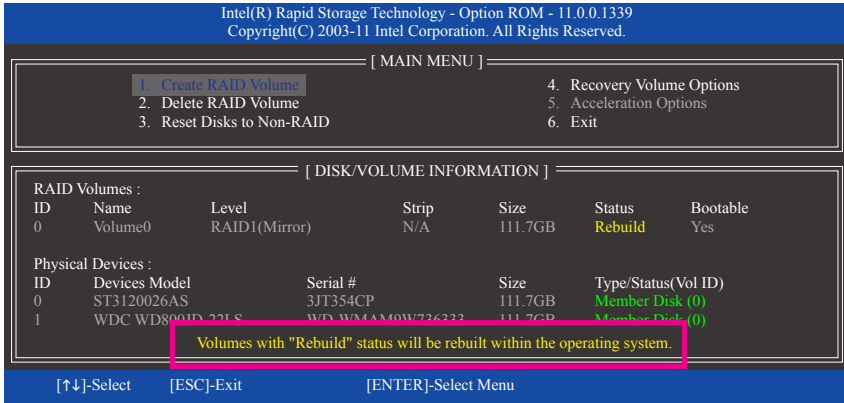

• **Performing the Rebuild in the Operating System**

While in the operating system, make sure the chipset driver has been installed from the motherboard driver disk. Then launch the Intel Rapid Storage Technology utility from **All Programs** in the **Start** menu.

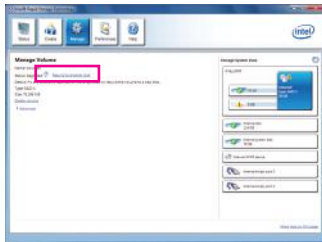

Step 1:

Go to the **Manage** menu and click **Rebuild to another disk** in **Manage Volume**.

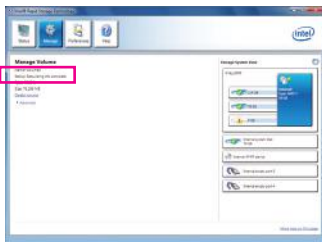

The **Status** item on the left of the screen displays the rebuild progress.



Step 2:

Select a new drive to rebuild the RAID and click **Rebuild**.

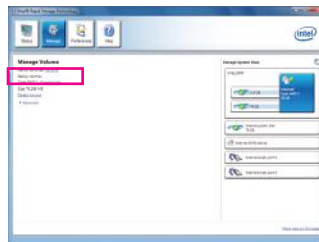

Step 3:

After the RAID 1 volume rebuilding, the **Status** will display as **Normal**.

- **Restoring the Master Drive to a Previous State (for Recovery Volume only)**

When two hard drives are set to Recovery Volume in Update on Request mode, you can restore the master drive data to the last backup state when needed. For example, in case the master drive detects a virus, you can restore the recovery drive data to the master drive.

Step 1:

Select **4. Recovery Volume Options** in the **MAIN MENU** of the Intel RAID Configuration Utility. On the **RECOVERY VOLUMES OPTIONS** menu, select **Enable Only Recovery Disk** to show the recovery drive in the operating system. Follow the on-screen instructions to complete and exit the RAID Configuration Utility.

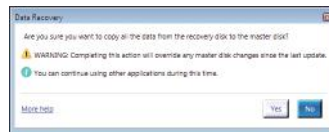
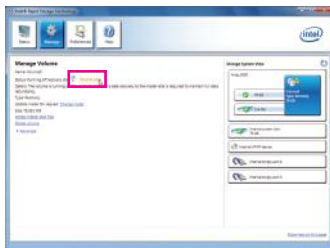
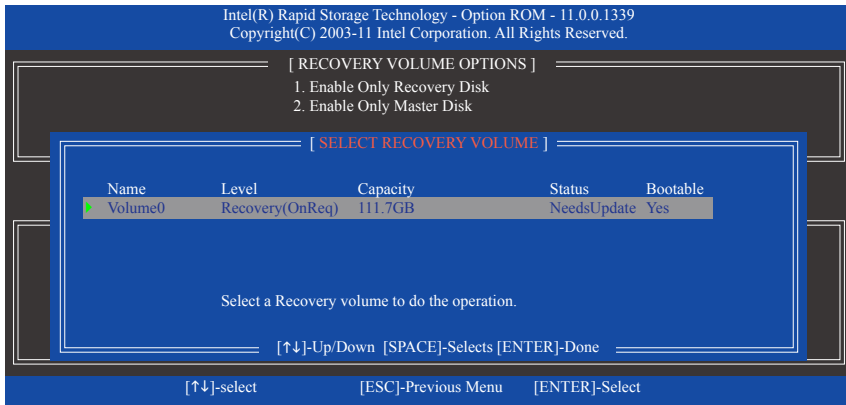

Step 3:
Click **Yes** to begin the data recovery.

Step 2:

Go to the **Manage** menu of the Intel Rapid Storage Technology utility and click **Recover data** in **Manage Volume**.

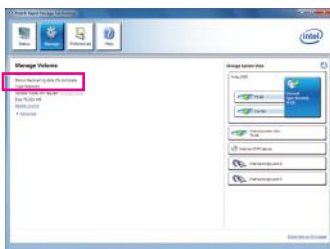

The **Status** item on the left of the screen displays the rebuild progress.

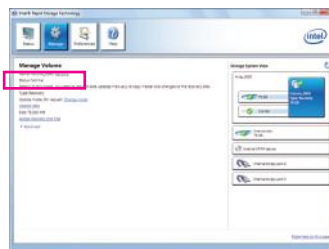

Step 4:
After the recovery volume is completed, the **Status** will display as **Normal**.

5-2 Configuring Audio Input and Output

5-2-1 Configuring 2/5.1-Channel Audio

The motherboard supports 2/5.1-channel audio. Refer to the following for speaker configurations.

- 2-channel audio: Headphone or Line out.
- 5.1-channel audio: Front speaker out, Rear speaker out, and Center/Subwoofer speaker out.



5-2-2 Creative Software Suite

After installing the audio driver, you can find the Creative Software Suite in Start\All Programs\Creative.

The Creative Software Suite includes Creative Alchemy and Sound Blaster Recon3Di.

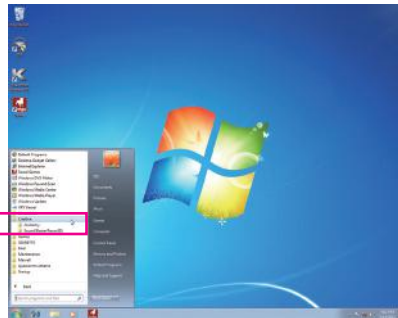

Creative Alchemy

Through the Creative Alchemy, you can enable EAX effects for your games to obtain the most realistic gaming experience.

Step:

Go to Start\All Programs\Creative\Alchemy to launch Creative Alchemy. On the left panel, select the game for which you want to enable the EAX effects and add it to the right panel. You will see the EAX effects are enabled when the game is launched.

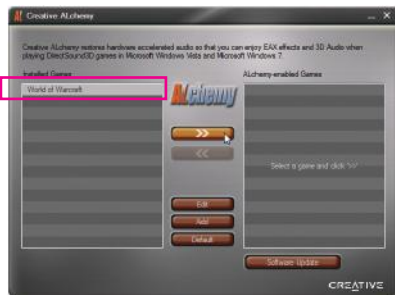

Sound Blaster Recon3Di

To launch the Sound Blaster Recon3Di Control Panel, go to Start\All Programs\Creative and select **Sound Blaster Recon3Di** or click the  icon in the notification area and select **Open**.

THX TRUSTUDIO PRO:

Click the THX TruStudio Pro icon to enable or disable it. The sliders on the right side allow you to adjust the enhancement level for each feature.

- **Surround:**
Provides immersion control to enhance the natural sense of audio depth and spaciousness by creating virtual surround sound channels.
- **Crystalizer:**
Makes the music sound as good as the artist originally intended and adds an enhanced level of realism for movies and games.
- **Bass:**
This feature is available only when a stereo speaker or headphone is installed. It fills in the missing low frequency tones and gives the extra impact for a better entertainment experience. The Crossover Frequency feature is available only when a 2-channel stereo speaker system is installed.
- **Smart Volume:**
Addresses the problem of abrupt volume level changes during playback and between songs by automatically and continuously measuring volume, and intelligently applying gain and attenuation to compensate for those changes.
- **Dialog Plus:**
Enhances the voices in movies for clearer dialog, allowing the listener to hear the dialog over the rest of the soundtrack and over ambient noise in the listening environment.



CRYSTALVOICE:

This page allows you to select a recording device and adjust microphone volume/boost and related settings. It also allows you to configure CrystalVoice features.

- **FX:**
Morphs your voice into different characters and accents.
- **Smart Volume:**
Automatically adjusts the loudness of the speaker's voice to maintain a consistent volume level.
- **Noise Reduction:**
Eliminates unwanted background noise in your conversations.
- **Acoustic Echo Cancellation:**
Eliminates echoes that interfere with your conversation.



SCOUT MODE:

This page allows you to enable or disable Scout Mode. This feature enables you to hear your opponents from further away in FPS games, giving you a distinct tactical advantage in combat. You can set hot keys which can be used enable or disable this feature during games.



SPEAKERS/HEADPHONES:

This page allows you to set the output device to speakers or headphones and set up your speaker/headphone configurations. (Note: Speakers and headphones cannot be used at the same time. When the headphone function is selected, the sound will come out only from the front line out or rear headphone jack.)



Speaker/Headphone Configurations:

Depending on the connected devices, you can select **5.1 Surround**, **Stereo**, or **Headphones**. If a 5.1-channel configuration is set, you can cancel or open a specific speaker manually.

MIXER:

This page allows you to increase or decrease the playback and recording volumes for your input/output device.



EQUALIZER:

This panel allows you to adjust the strength of certain frequencies for your audio signals.



ADVANCED FEATURES:

This page allows you to play stereo mix to digital output. You can output the mixed audio signals simultaneously to the speakers and S/PDIF out to obtain 2-channel sound.

(Note: When using this feature, the default playback device must be set to **Speaker**, not **SPDIF Out** in Windows Control Panel.



Other Features:

The **Profile** button allows you to save your settings on the **SPEAKERS/HEADPHONES**, **MIXER**, or **ADVANCED FEATURES** page to a profile. You can export your custom settings and share them with others or import others' custom settings.



(Note) For more information on Sound Blaster Recon3Di, please visit the CREATIVE website.

5-2-3 Configuring S/PDIF Out

The S/PDIF Out jack can transmit audio signals to an external decoder for decoding to get the best audio quality.

1. Connecting a S/PDIF Out Cable:

Connect a S/PDIF optical cable to an external decoder for transmitting the S/PDIF digital audio signals.

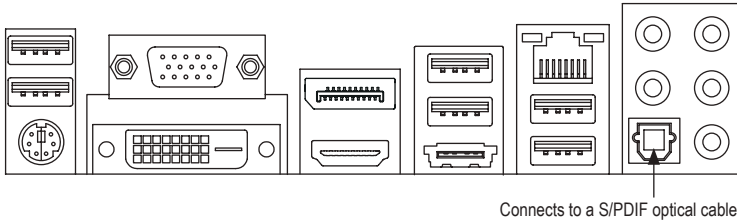

2. Configuring S/PDIF Out:

Step 1:

While in the operating system, right-click on the  icon in the notification area and select **Playback devices**.

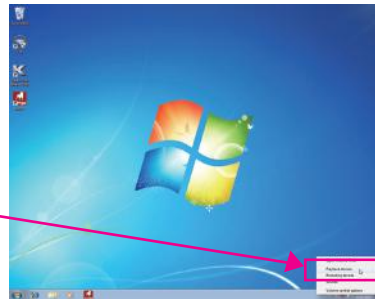

Step 2:

On the **Playback** tab, right-click on **SPDIF Out**, select **Set as Default Device**, and then open the **Properties** dialog box.

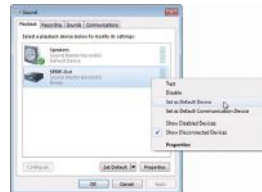

Step 3:

You can go to the **Supported Formats** tab to select the formats to be decoded or the **Advanced** tab to select the sample rate and bit depth.

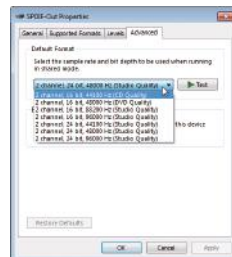

5-2-4 Configuring Audio Recording

You can record the sound from the microphone or Line in device or record the sound from your computer.

1. Configuring your microphone:

Step 1:

Connect your microphone to the Mic in jack (pink) on the back panel or the Mic in jack (pink) on the front panel.

Note: The microphone functions on the front panel and back panel cannot be used at the same time.

Open the Sound Blaster Recon3Di Control Panel and go to the **CRYSTALVOICE** page. Make sure your microphone is correctly connected.



Step 2:

To hear the sound being recorded during the recording process, it is recommended that you set the **Mic volume** at a middle level. Do not mute the recording volume, or you'll not be able to record the sound. To raise the recording and playback volume for the microphone, use the **Mic Boost** slider and set the microphone boost level.

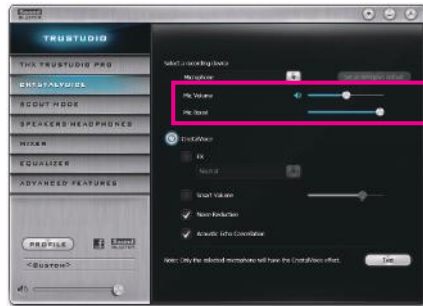

2. Configuring your Line in device:

Step 1:

Open the Sound Blaster Recon3Di Control Panel and go to the **Mixer** page. In the **REC** section, click the **Input Device** icon and select **Rear Line In**. Later you can use the **Line-In** slider to set the volume.



Step 2:

Right-click on the  icon in the notification area and select **Recording devices**.

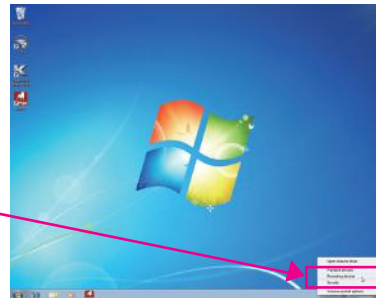

Step 3:

On the **Recording** tab, right-click on **Line-In**, and select **Set as Default Device**.

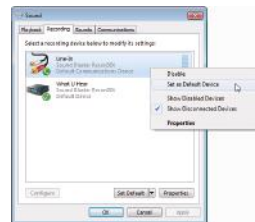

3. Recording the sound from your computer:

Step 1:

While in the operating system, right-click on the  icon in the notification area and select **Recording devices**.

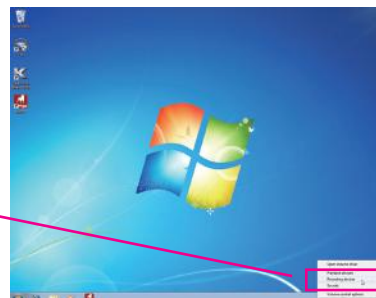

Step 2:

On the **Recording** tab, right-click on **What U Hear** and select **Set as Default Device**.

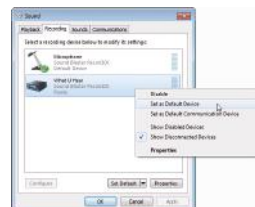

Step 3:

Open the Sound Blaster Recon3Di Control Panel and go to the **Mixer** page. In the **REC** section, you can use the **What U Hear** slider to set the volume.



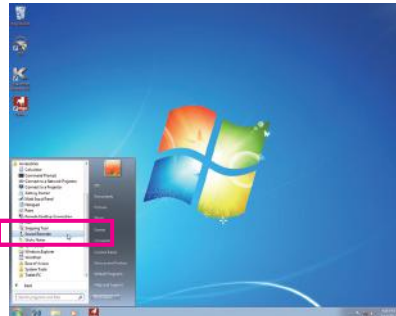

After setting up your recording device, click **Start**, point to **All Programs**, point to **Accessories**, and then click **Sound Recorder** to begin the sound recording.

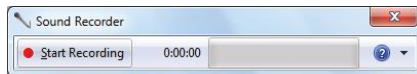

5-2-5 Using the Sound Recorder



A. Recording Sound

1. Make sure you have connected the sound input device (e.g. microphone) to the computer.
2. To record the audio, click the **Start Recording** button .
3. To stop recording audio, click the **Stop Recording** button .

Be sure to save the recorded audio file upon completion.

B. Playing the Recorded Sound

You can play your recording in a digital media player program that supports your audio file format.

5-3 Troubleshooting

5-3-1 Frequently Asked Questions

To read more FAQs for your motherboard, please go to the **Support & Downloads\FAQ** page on GIGABYTE's website.

Q: Why is the light of my keyboard/optical mouse still on after the computer shuts down?

A: Some motherboards provide a small amount of standby power after the computer shuts down and that's why the light is still on.

Q: How do I clear the CMOS values?

A: For motherboards that have a Clear CMOS button, press this button to clear the CMOS values (before doing this, please turn off the computer and unplug the power cord). For motherboards that have a Clear CMOS jumper, refer to the instructions in Chapter 1 to short the jumper to clear the CMOS values. If your board doesn't have this jumper/button, refer to the instructions on the motherboard battery in Chapter 1. You can temporarily remove the battery from the battery holder to stop supplying power to the CMOS, which will clear the CMOS values after about one minute.

Q: Why do I still get a weak sound even though I have turned my speaker to the maximum volume?

A: Make sure your speaker is equipped with an internal amplifier. If not, try a speaker with power/amplifier.

5-3-2 Troubleshooting Procedure

If you encounter any troubles during system startup, follow the troubleshooting procedure below to solve the problem.

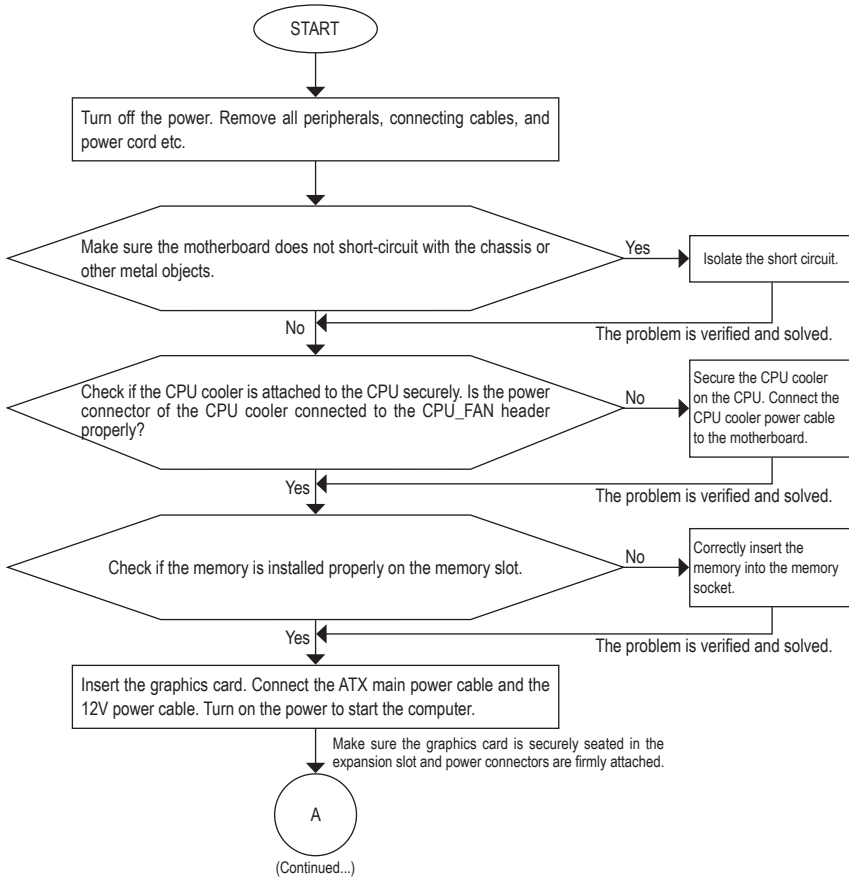

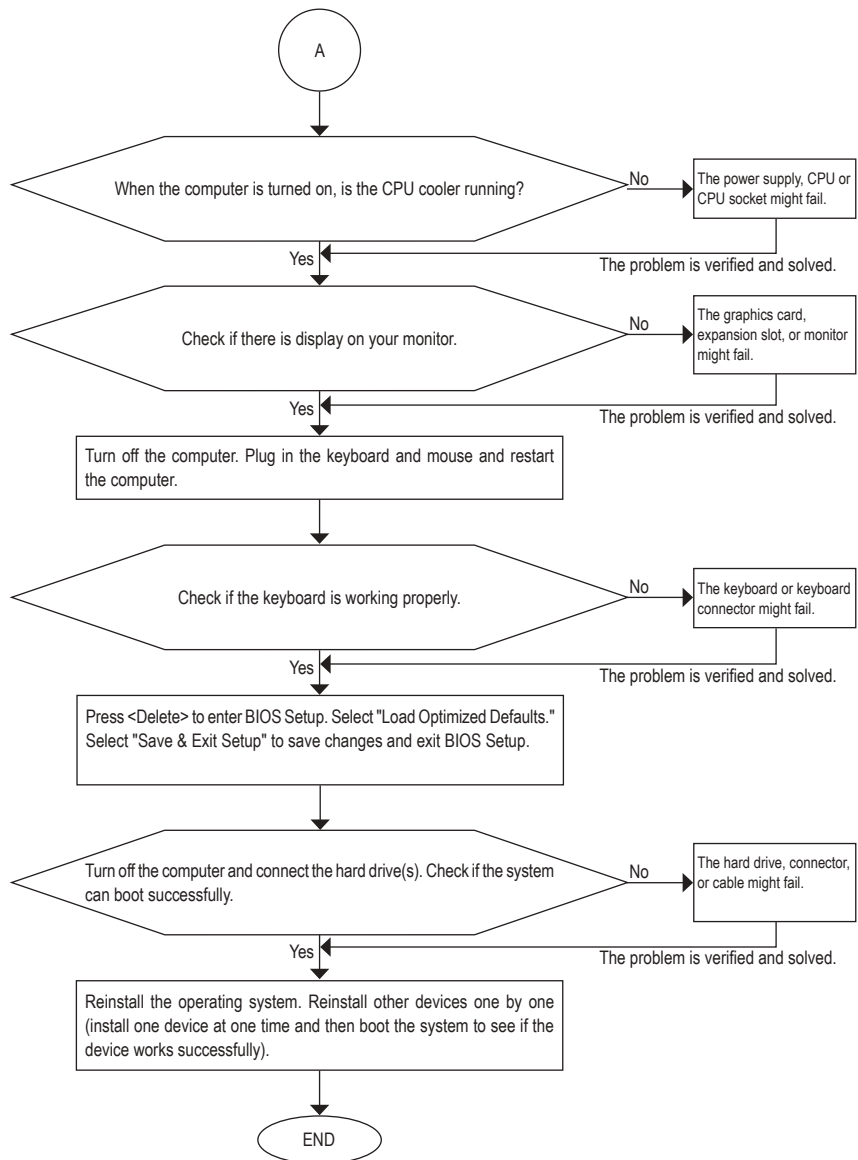

If the procedure above is unable to solve your problem, contact the place of purchase or local dealer for help. Or go to the **Support & Downloads\Technical Support** page to submit your question. Our customer service staff will reply you as soon as possible.

5-4 Regulatory Statements

Regulatory Notices

This document must not be copied without our written permission, and the contents there of must not be imparted to a third party nor be used for any unauthorized purpose. Contravention will be prosecuted. We believe that the information contained herein was accurate in all respects at the time of printing. GIGABYTE cannot, however, assume any responsibility for errors or omissions in this text. Also note that the information in this document is subject to change without notice and should not be construed as a commitment by GIGABYTE.

Our Commitment to Preserving the Environment

In addition to high-efficiency performance, all GIGABYTE motherboards fulfill European Union regulations for RoHS (Restriction of Certain Hazardous Substances in Electrical and Electronic Equipment) and WEEE (Waste Electrical and Electronic Equipment) environmental directives, as well as most major worldwide safety requirements. To prevent releases of harmful substances into the environment and to maximize the use of our natural resources, GIGABYTE provides the following information on how you can responsibly recycle or reuse most of the materials in your "end of life" product.

Restriction of Hazardous Substances (RoHS) Directive Statement

GIGABYTE products have not intended to add and safe from hazardous substances (Cd, Pb, Hg, Cr+6, PBDE and PBB). The parts and components have been carefully selected to meet RoHS requirement. Moreover, we at GIGABYTE are continuing our efforts to develop products that do not use internationally banned toxic chemicals.

Waste Electrical & Electronic Equipment (WEEE) Directive Statement

GIGABYTE will fulfill the national laws as interpreted from the 2002/96/EC WEEE (Waste Electrical and Electronic Equipment) directive. The WEEE Directive specifies the treatment, collection, recycling and disposal of electric and electronic devices and their components. Under the Directive, used equipment must be marked, collected separately, and disposed of properly.

WEEE Symbol Statement



The symbol shown below is on the product or on its packaging, which indicates that this product must not be disposed of with other waste. Instead, the device should be taken to the waste collection centers for activation of the treatment, collection, recycling and disposal procedure. The separate collection and recycling of your waste equipment at the time of disposal will help to conserve natural resources and ensure that it is recycled in a manner that protects human health and the environment.

For more information about where you can drop off your waste equipment for recycling, please contact your local government office, your household waste disposal service or where you purchased the product for details of environmentally safe recycling.

- ◆ When your electrical or electronic equipment is no longer useful to you, "take it back" to your local or regional waste collection administration for recycling.
- ◆ If you need further assistance in recycling, reusing in your "end of life" product, you may contact us at the Customer Care number listed in your product's user's manual and we will be glad to help you with your effort.

Finally, we suggest that you practice other environmentally friendly actions by understanding and using the energy-saving features of this product (where applicable), recycling the inner and outer packaging (including shipping containers) this product was delivered in, and by disposing of or recycling used batteries properly. With your help, we can reduce the amount of natural resources needed to produce electrical and electronic equipment, minimize the use of landfills for the disposal of "end of life" products, and generally improve our quality of life by ensuring that potentially hazardous substances are not released into the environment and are disposed of properly.



Contact Us

- **GIGA-BYTE TECHNOLOGY CO., LTD.**

Address: No.6, Bao Chiang Road, Hsin-Tien Dist.,

New Taipei City 231, Taiwan

TEL: +886-2-8912-4000

FAX: +886-2-8912-4003

Tech. and Non-Tech. Support (Sales/Marketing) :

<http://ggts.gigabyte.com.tw>

WEB address (English): <http://www.gigabyte.com>

WEB address (Chinese): <http://www.gigabyte.tw>

- **G.B.T. INC. - U.S.A.**

TEL: +1-626-854-9338

FAX: +1-626-854-9326

Tech. Support: <http://ggts.gigabyte.com.tw>

Warranty Info: <http://rma.gigabyte.us>

Web address: <http://www.gigabyte.us>

- **G.B.T. INC (USA) - Mexico**

Tel: +1-626-854-9338 x 215 (Soporte de habla hispano)

FAX: +1-626-854-9326

Correo: soporte@gigabyte-usa.com

Tech. Support: <http://rma.gigabyte.us>

Web address: <http://latam.giga-byte.com>

- **Giga-Byte SINGAPORE PTE. LTD. - Singapore**

WEB address : <http://www.gigabyte.sg>

- **Thailand**

WEB address : <http://th.giga-byte.com>

- **Vietnam**

WEB address : <http://www.gigabyte.vn>

- **NINGBO G.B.T. TECH. TRADING CO., LTD. - China**

WEB address : <http://www.gigabyte.cn>

- Shanghai**

TEL: +86-21-63410999

FAX: +86-21-63410100

- Beijing**

TEL: +86-10-62102838

FAX: +86-10-62102848

- Wuhan**

TEL: +86-27-87851061

FAX: +86-27-87851330

- GuangZhou**

TEL: +86-20-87540700

FAX: +86-20-87544306

- Chengdu**

TEL: +86-28-85236930

FAX: +86-28-85256822

- Xian**

TEL: +86-29-85531943

FAX: +86-29-85510930

- Shenyang**

TEL: +86-24-83992901

FAX: +86-24-83992909

- **GIGABYTE TECHNOLOGY (INDIA) LIMITED - India**

WEB address : <http://www.gigabyte.in>

- **Saudi Arabia**

WEB address : <http://www.gigabyte.com.sa>

- **Gigabyte Technology Pty. Ltd. - Australia**

WEB address : <http://www.gigabyte.com.au>

- **G.B.T. TECHNOLOGY TRADING GMBH - Germany**

WEB address : <http://www.gigabyte.de>

- **G.B.T. TECH. CO., LTD. - U.K.**

WEB address : <http://www.giga-byte.co.uk>

- **Giga-Byte Technology B.V. - The Netherlands**

WEB address : <http://www.giga-byte.nl>

- **GIGABYTE TECHNOLOGY FRANCE - France**

WEB address : <http://www.gigabyte.fr>

- **Sweden**

WEB address : <http://www.gigabyte.se>

- **Italy**

WEB address : <http://www.giga-byte.it>

- **Spain**

WEB address : <http://www.giga-byte.es>

- **Greece**

WEB address : <http://www.gigabyte.com.gr>

- **Czech Republic**

WEB address : <http://www.gigabyte.cz>

- **Hungary**

WEB address : <http://www.giga-byte.hu>

- **Turkey**

WEB address : <http://www.gigabyte.com.tr>

- **Russia**

WEB address : <http://www.gigabyte.ru>

- **Poland**

WEB address : <http://www.gigabyte.pl>

- **Ukraine**

WEB address : <http://www.gigabyte.ua>

- **Romania**

WEB address : <http://www.gigabyte.com.ro>

- **Serbia**

WEB address : <http://www.gigabyte.co.rs>

- **Kazakhstan**

WEB address : <http://www.gigabyte.kz>

You may go to the GIGABYTE website, select your language in the language list on the top right corner of the website.

- **GIGABYTE Global Service System**



To submit a technical or non-technical (Sales/Marketing) question, please link to:

<http://gts.gigabyte.com.tw>

Then select your language to enter the system.