

# Presario 2200/4200

Processor Boards	Assembly	Spare Part	System
Board, Proc, 166MGX		292535-001 (LA) 292536-001 (Dom)	2200, 12ES
Board, Proc, 180MGX		292536-001	2200, 10, 12
Board, Proc, 200MGX		292538-001	2230, 32
Board, Proc, 586		292598-001	4220, 12ES, 22
Board, Proc, 686, 512K	310128-101	311009-001	4230ES
Board, Proc, w/ 16 MB RAM/ 2MB VRAM	327068-101	327149-001	2240, 44ES
Board, Proc, w/ 16 MB RAM/ 1MB VRAM	327068-102	327149-002	2240, 46 (US, LA, Brazil only)
Board, Proc, w/ 32 MB, w/ 2 MB	310198-101	319208-001	2253, 54, 55, 56
Board, Proc, ES		319277-001	4240ES
Board, Processor, w/o Processor		337362-001	2256, 57, 58, 60, 62, 64, 66, 68, 70, 74, 75, 76, 78
Board, Processor, w/o Processor		387610-001	2281, 82, 83, 84, 85V, 86, 88, 89, 90, 92, 93, 94, 95, 97

## Jumper Settings, Presario 2200

CPU Clock Multiplier	JP1	JP2	JP2	JP3	JP4
233	OPEN	2-3	1-2	5-6 (3.2V)	OPEN
266	1-2, 5-6	2-3	1-2	OPEN (3.2V)	3-4
Configuration Jumper	Clear				
	1 – 2	Keep configuration info (CMOS) when power is off			
	2 – 3	Clear config info when power is off			

## Jumper Settings, Presario 4200

CPU Clock Multiplier	Freq 1	Freq 2	Processor
3.5x	1 – 2	1 – 2	233
3x	1 – 2	2 – 3	200
2.5x	2 – 3	2 – 3	150, 166
2x	2 – 3	1 – 2	120, 133
Clock Speed	CLK1	CLK2	Processor
66	2 – 3	2 – 3	133, 166, 200, 233
60	1 – 2	1 – 2	120, 150
Configuration Jumper	Clear 1		
	1 – 2	Keep configuration info (CMOS) when power is off	
	2 – 3	Clear config. info when power is off	

## Jumper Settings, Presario 4230ES

CPU Clock Multiplier	JP1	JP2	JP3
233	OFF	ON	ON
266	ON	OFF	OFF
300	ON	OFF	ON
333	ON	ON	OFF
Configuration Jumper	Settings	Description	
J17	1 – 2	Keep configuration info (CMOS) when power is off	
	2 – 3	Clear config. info when power is off	

# Presario 2200/4200

## Jumper Settings, Presario 4240ES

CPU Clock Multiplier	JP1	JP2	JP2	JP3	JP4
233	OPEN	2-3	1-2	5-6 (3.2V)	OPEN
266	1-2, 5-6	2-3	1-2	OPEN (3.2V)	3-4

Configuration Codes	System Board or Processor Board Spare Part	Model
BP72	292536-001	2200
BP73	292536-001	2200
BP82	292536-001	2210
BP83	292536-001	2210
BP6N	292598-001	4212ES
BP8C	292536-001	2212
BP8M	292536-001	2210
BP62	292598-001	4220
BP63	292598-001	4220
BP64	292598-001	4222
BP65	292598-001	4220
BQQ2	311009-001	4230ES
BTF2	319277-001	4240ES
BTS2	327149-002	2246
BTT6	327149-001	2240
BTT7	327149-001	2240
BTT8	327149-001	2240
BTT9	327149-001	2240
BTTCC	327149-001	2244ES
BTTD	327149-002	2240
BTTF	327149-001	2240
BTTG	327149-002	2240
BTTT	327149-001	2240
BTTJ	327149-001	2240
BXRB	319208-001	2254
BXRJ	319208-001	2254
BXRF	319208-001	2253
BXRF	319208-001	2254
BXRG	319208-001	2255
BXRH	319208-001	2255
BXRJ	319208-001	2255
BXR2	319208-001	2254
BXR4	319208-001	2254
BXR6	319208-001	2254
BXR7	319208-001	2254
BXR8	319208-001	2254
BXR9	319208-001	2253
BXS2	319208-001	2256
BXS3	319208-001	2255
BXT2	337362-001	2276
BXT3	337362-001	2274

Continued

# Presario 2200/4200

Configuration Codes	System Board or Processor Board Spare Part	Model
BXT4	337362-001	2270, 75
BXT5	337362-001	2270, 75
BXT6	337362-001	2270, 78
BXT7	337362-001	2274, 75
BXTB	337362-001	2274
BXTC	337362-001	2274
BXTD	337362-001	2278
CDQB	337362-001	2262
CDQC	337362-001	2264
CDQD	337362-001	2260
CDQ2	337362-001	2262
CDQ3	337362-001	2262
CDQ5	337362-001	2260
CDQ6	337362-001	2268
CDQ7	337362-001	2262
CDQ8	337362-001	2262
CDQ9	337362-001	2266
CFH2	387610-001	2288
CFH4	387610-001	2289
CFH5	387610-001	2288
CFJ2	387610-001	2292
CFJ3	387610-001	2297
CFJ6	387610-001	2294
CGV2	387610-001	2282
CGV4	387610-001	2280
CGV5	387610-001	2282
CGV6	387610-001	2284
CGV7	387610-001	2284
CGV9	387610-001	2280
CGVB	387610-001	2286
CGVC	387610-001	2285V
CGW2	387610-001	2294
CGW3	387610-001	2294
CGW4	387610-001	2293
CGW6	387610-001	2290

Microprocessors	Assembly	Spare Part	System
166 MHz		235229-001	4200, 4220, 4222
166 MHz		240181-001	4212ES
200 MHz		327169-001	2240, 2244ES
233 MHz		170724-001	2246
266 MHz		286275-001	4230ES
Heat Sink w/ Clip		327170-001	2240 Series
Heat Sink w/ Clip		337369-001	2281, 82, 83, 84, 85V, 86, 88, 89; 2290 Series
Heat Sink w/ Clip		317216-001	4230ES
Heat Sink		292644-001	4220, 4222, 4212ES
233X	296576-003	319281-001	2253, 54
266X	296576-005	319236-001	2254, 55

Continued

# Presario 2200/4200

Microprocessors	Assembly	Spare Part	System
333	278308-002	320666-001	4240ES
333/100, MHz, w/ Heat Sink		337364-001	2275, 76, 78
300/66 (MX2)		337375-001	2260, 62
300, w/ Heat Sink	320471-002	337374-001	2270, 74
300X	320471-004	319336-001	2255, 2256
300/75 (MX-2)		386217-001	2262, 64, 66
P333, M2		388239-001	2281, 82, 83, 84, 85V, 86
P350, M2		388240-001	2288, 89
333/100, MHz, K6S-2		401555-001	2290, 92, 94
350, K6S-2		388241-001	2293, 94, 97
400, K6S-2	330631-001	320668-001	2295, 97

Memory	Assembly	Spare Part	System
8 MB, 60ns, SDRAM	278029-002	288438-001	2240, 2244ES
16 MB, 60ns, SDRAM	271108-002	271117-001	4200
16 MB, 60ns, SDRAM	278030-002	278066-001	2240, 2244ES, 2246, 2255, 2256
16 MB, 60ns, SDRAM	320759-101	319327-001	4240ES
16 MB, 100 MHz, SDRAM	323010-001	166969-001	2274, 76, 78, 82, 84, 85V, 86, 89, 93, 94, 95
32 MB, 60ns, SDRAM	271109-002	271118-001	4200
32 MB, 60ns, SDRAM	286548-001	304287-001	4230ES
32 MB, 60ns, SDRAM	320767-101	319326-001	2260, 62, 64, 70; 4240ES
32 MB, 100 MHz, DIMM	323029-001	337372-001	2281, 82, 84, 85V, 86, 89, 93, 94, 95, 97
64 MB, 100 MHz, DIMM	323012-001	179190-001	2262, 66, 74, 75, 78, 83, 88, 89, 90, 92, 94, 97
1 MB VRAM	210257-004	327265-001	2240 Series, 2253, 54, 55, 56
256K Cache	237716-001	243117-001	2240 Series, 2253, 2254, 2255, 2256
512K Cache	240108-001	243117-002	4230ES

Miscellaneous	Assembly	Spare Part	System
Bezel		319207-001	2253, 54, 55, 2256,
Bezel, ES		319279-001	4240ES
Bezel		337358-001	2280 Series, 2290 Series
Bezel Button Board w/ Cable		292562-001	Prior to 2240 Series and 4230ES
Bezel Button Board w/ Cable		298468-001	2240 Series, 4230ES
Bezel Button Board w/ Cable		319206-001	2250 Series; 4240ES
Button/Headphone Board w/ Cable		337357-001	2260 Series, 2270 Series, 2280 Series, 2290 Series
Bezel, Front w/ Buttons		292561-001	Prior to 2240 Series and 4230ES
Bezel, Front w/ Buttons		298470-001	2240 Series, 4230ES

Continued

## Presario 2200/4200

<b>Miscellaneous</b>	<b>Assembly</b>	<b>Spare Part</b>	<b>System</b>
Backplane Board, w/o NIC, w/o ISA		386216-001	2260, 64, 66, 70, 74, 75
Backplane Board, w/ NIC, w/o ISA		337360-001	2262, 74, 78, 83, 84, 89, 94
Backplane Board, w/o NIC, w/ ISA		337359-001	2262, 74, 76
Backplane Board, w/o NIC		387611-001	2281, 82, 85V, 86, 88, 90, 92, 93, 94, 95, 97
Hard Drive Mounting Bracket		243231-001	2240 Series, 2253, 54, 55, 56, 4230 Series for 3.5 inch drive in 5.25 inch bay,
Fan, System		298474-001	4230ES
Fan, System		292617-001	4212ES, 20, 22
Headphone Board		298469-001	2244ES, 4230ES, 4240ES
Keyboard, US English, Sunset		286241-005	2200; 4212ES
Keyboard, US English, Education	286220-003	304286-003	2240, 46, 85V, 86; 2244ES; 4230ES, 4240ES
Keyboard, Ivory – US/CAN English	340740-003	340869-003	2254, 55, 56, 64, 66, 75, 81, 85V, 86, 92, 94
Modem		293020-001	4212ES (Teacher buy program)
Modem, 33.6/56K	007201-003	317296-001	2254, 55, 62, 74, 76
Modem, 56K, Controllerless – Z(3C)	337550-001	337559-001	2262, 64, 66, 74, 75, 78, 84, 85V, 86, 89, 94, 97
Modem, 56K		292269-003	2253, 54, 55, 56
Modem, Diamond - Spain		170762-073	2254
Modem, Diamond - Spain	334790-021	334808-021	2282, 88, 92, 93, 94, 95, 97
Mouse, KYE Shielded	149998-006	199181-401	2240 Series, 2250 Series
Mouse, Ivory	141649-008	337416-001	2260 Series, 2270 Series; 2281, 82, 83, 84, 85V, 86, 88, 89; 2290 Series
Mouse, Scroll	334684-001	334689-001	2290, 94, 97
Speaker, Left		292612-001	Prior to 2240 Series and 4230ES
Speaker, Left		298479-001	2240 Series, 4230ES, 4240ES
Speaker, Right w/ Enclosure		292611-001	Prior to 2240 Series and 4230ES
Speaker, Right w/ Enclosure		298480-001	2240 Series, 4230ES, 4240ES
Misc Hardware Kit		298592-001	2240 Series; 4240ES
Misc Hardware/Plastic Kit		337368-001	2260 Series, 2270 Series; 2281, 82, 83, 84, 85V, 86, 88, 89; 2290 Series

# Presario 2200/4200

<b>Modem Cable Kits</b>	<b>Assembly</b>	<b>Spare Part</b>	<b>System</b>
Cable Kit, Modem		165224-001	2240
Cable Kit, Modem, UK	165227-033	165224-032	2282, 90, 92
Cable Kit, Modem, UK	165227-003	165224-033	2240, 54, 55, 56, 57, 58, 62, 74
Cable Kit, Modem, US, PR, Can, Caribbean, LA, Brazil, APD, Prc, Taiwan, Japan, Spain	112666-003	137256-001	2240, 2240ES, 2254, 55, 56, 57, 58, 62, 64, 75, 78, 82, 83, 84, 85V, 86, 88, 89, 93, 94, 95, 97
Cable Kit, Modem w/ Adapter, Aus, NZ	112666-005	304398-011	2254, 57, 62, 82, 94, 97
Cable Kit, Modem w/ Adapter, Belgium	112666-005	304398-181	2254, 57, 62, 92
Cable Kit, Modem w/ Adapter, Denmark	112666-005	304398-081	2254, 57, 92
Cable Kit, Modem w/ Adapter, France	112666-005	304398-051	2254, 55, 56, 57, 58, 60, 62, 92
Cable Kit, Modem w/ Adapter, Finland	112666-005	304398-351	2254, 57, 92
Cable Kit, Modem w/ Adapter, Italy	112666-005	304398-061	2254, 57, 62, 92
Cable Kit, Modem w/ Adapter, Netherlands	112666-005	304398-331	2254, 55, 57, 58, 62, 74, 92
Cable Kit, Modem w/ Adapter, Sweden	112666-005	304398-101	2254, 57, 92
Cable Kit, Modem w/ Adapter, Switzerland	112666-005	304398-111	2254, 57, 92

<b>Controller Boards</b>	<b>Assembly</b>	<b>Spare Part</b>	<b>System</b>
PCI, 10/100, w/ TX	317607-001	317606-001	4240ES
NIC PCI 10/100		169849-001	4230ES, 2244ES

<b>Hard Drives</b>	<b>Assembly</b>	<b>Spare Part</b>	<b>System</b>
1.6 GB, IDE, 3.5"		292542-001	2200, 10, 12
2.1 GB, IDE		292541-001	4212ES, 20, 22
2.1 GB, IDE	328285-001 166820-001	337366-001	2260, 62
2.1 GB, IDE, 3.5"		327213-001	2240, 2244ES, 2246
3.2 GB, IDE		337564-001	2253, 54, 55
3.2 GB, IDE		388237-001	2282
4.0 GB, IDE		286248-001	2253, 2254, 55, 56, 4230ES
4.0 GB, IDE	328287-001 320783-001	337379-001	2262, 64, 66, 70, 74, 75, 76, 81, 82, 83, 84, 85V, 88, 90, 92, 93, 94, 95
6.0 GB, IDE	241139-001	271127-001	2255
6.0 GB, IDE		166973-001	2275
6.0 GB, IDE		387612-001	2284, 86, 88, 89, 94, 97
8.0 GB, IDE	334180-001	337419-001	2258
8.0 GB, IDE		298464-001	4240ES

<b>CD-ROM Drive</b>	<b>Assembly</b>	<b>Spare Part</b>	<b>System</b>
CD-ROM, IDE, 8X		292540-001	2200, 10, 12
CD-ROM, IDE, 16X		292569-001	4212ES, 20, 22
CD-ROM, IDE, 20X		317210-001	2240, 2244ES, 2246
CD-ROM, IDE, 32X	310185-002	317212-001	2200 Series; 2281, 83, 84, 85V, 86, 88, 89, 94
DVD2	286466-408	317213-001	4230ES, 4240ES

# Presario 2200/4200

Diskette Drives	Spare Part	System
1.44 MB	292549-001	All except 2240 Series and 4230ES
1.44 MB	239612-401	2240, 2244ES, 2253, 54, 55, 56, 58, 2260 Series, 2270 Series, 2281, 82, 83, 84, 85V, 86, 88, 89, 2290 Series; 4240ES, 4230ES

## 33.6 Kb/s Modem, Upgradable to 56 Kb/s (Presario 2240, 2246, 2254, 2255)

Country	Cable/Adapter	Spare Part	Cable Spare Part
Australia	304398-011	317296-001	165224-001
Belgium	304398-181	317296-001	165224-001
Denmark	304398-081	317296-001	165224-001
Finland	304398-351	317296-001	165224-001
France	304398-051	317296-001	165224-001
Italy	304398-061	317296-001	165224-001
Netherlands	304398-331	317296-001	165224-001
New Zealand	304398-011	317296-001	165224-001
Norway	304398-091	317296-001	165224-091
Singapore		317296-001	165224-001
Sweden	304398-101	317296-001	165224-001
Switzerland	304398-111	317296-001	165224-001
U Kingdom		317296-001	165224-033

## 33.6 Kb/s Modem, Upgradable to 56 Kb/s (all except Presario 2240, 2246)

Country	Spare Part	Cable Spare Part
APD	293020-371	165224-001
Australia	293020-012	165224-012
Belgium	293020-181	304398-181
Brazil	293020-001	165224-001
Canada	293020-001	165224-001
Caribbean		165224-001
Denmark	293020-001	304398-081
France	293020-051	304398-051
Germany	293020-041	286241-045
Italy	293020-161	165224-062
Japan	293020-291	165224-001
Korea		165224-001
Latin America	293020-001	
Mexico	293020-001	165224-001
Netherlands	293020-331	304398-331
New Zealand	293020-012	165224-033
Norway	317296-001	304398-091
Portugal		165224-131
PRC/Thailand	293020-001	165224-001
Puerto Rico		165224-001
Singapore	293020-AF1	165224-001
Spain		165224-071
Sweden	293020-101	304398-101
Switzerland	293020-111	304398-111
Taiwan	293020-AB1	165224-001
U Kingdom	293020-031	165224-033
US	293020-001	165224-001
US 4212ES	293020-001	165224-001

## Daughter Cards to Upgrade to 56 Kb/s

Country	Spare Part
One part supports all countries	292614-001

# Presario 2200/4200

## 56 Kb/s DSVD (Presario 2240, 2246, 2253, 2254, 2255, 2256, 2257)

Country	Modem		Cable
	PCA	Spare Part	Spare Part
APD English (Malaysia, Hong Kong, Vietnam, Indonesia, Philippines)	292256-003	292269-003	137256-001
Brazil	292256-003	292269-003	137256-001
Caribbean	292256-003	292269-003	137256-001
Japan	292256-003	292269-003	137256-001
Latin America	292256-003	292269-003	137256-001
Mexico	292256-003	292269-003	137256-001
PRC/Thailand	292256-003	292269-003	137256-001
Puerto Rico	292256-003	292269-003	137256-001
Spain	170740-001	170762-073	137256-001
Taiwan	292256-003	292269-003	137256-001
US /Canada	292256-003	292269-003	137256-001

Cables	Assembly	Spare Part	System
Cable Kit		292568-001	All except 2240 and 4230ES Series
Cable Kit, Miscellaneous		170720-001	2240 Series, 2253, 54, 55, 56, 4230ES
Cable Kit, Miscellaneous		337361-001	2260 Series, 2270 Series, 2281, 82, 83, 84, 85V, 86, 88, 89, 2290 Series
Cable Kit, Miscellaneous	298486-001 310188-003 349006-001 320558-001	337562-001	4240ES

Power Supply/Battery	Spare Part	System
Power Supply, 51W, Auto-Detect	293814-001	All except 2240 and 4230ES Series
Power Supply, 75W, w/ Baffle	319234-001	2250 Series
Power Supply, 75W	337373-001	2260 Series, 2270 Series, 2280 Series, 2290 Series
Power Supply, 75W, w/ Baffle	298471-001	2240, 2244ES
Power Supply, 110W, w/ Baffle	319235-001	4240ES
Power Supply, 110W	317218-001	4230ES
Battery, Replaceable	234556-001	All



# Presario 2200/4200

## Presario 2200 Series Memory Upgrade Chart

I/O BOARD

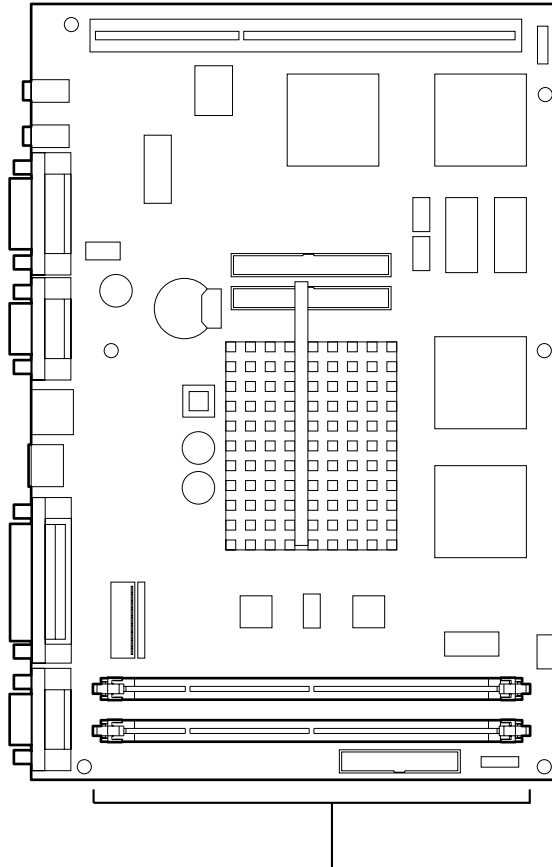

A MAXIMUM OF 80 MB TOTAL MEMORY

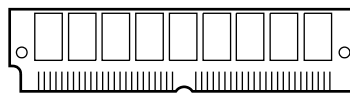

NO OPTIONS

NO SPARES, ALL MEMORY DOWN

# Presario 2200/4200

## Presario 2240 Series Memory Upgrade Chart

I/O BOARD 16 MB  
327149-001

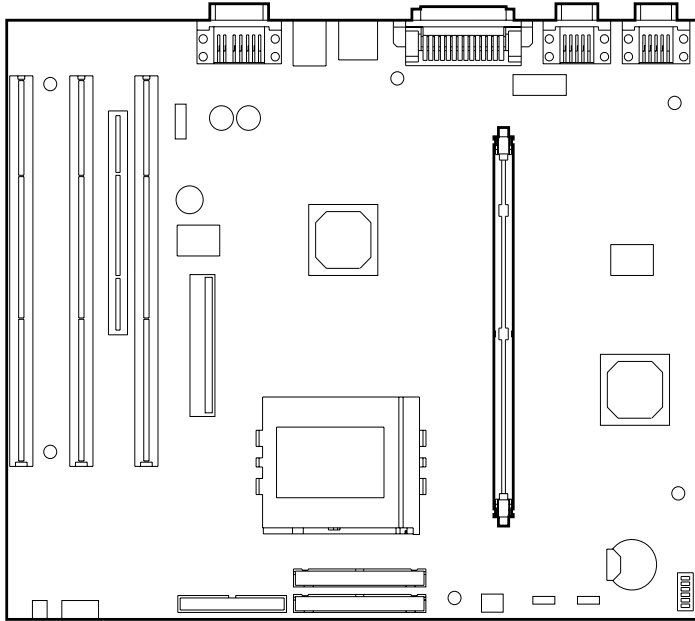

A MAXIMUM OF 48MB TOTAL MEMORY  
16 MB STANDARD .

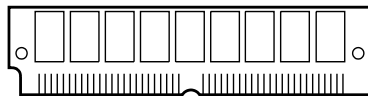

32-MB SDRAM DIMMS, - OPTION PN 271434-001

# Presario 2200/4200

## Presario 2253, 2254, 2255, 2256 Memory Upgrade Chart

PROCESSOR BOARD  
310198-001  
(32 MB)

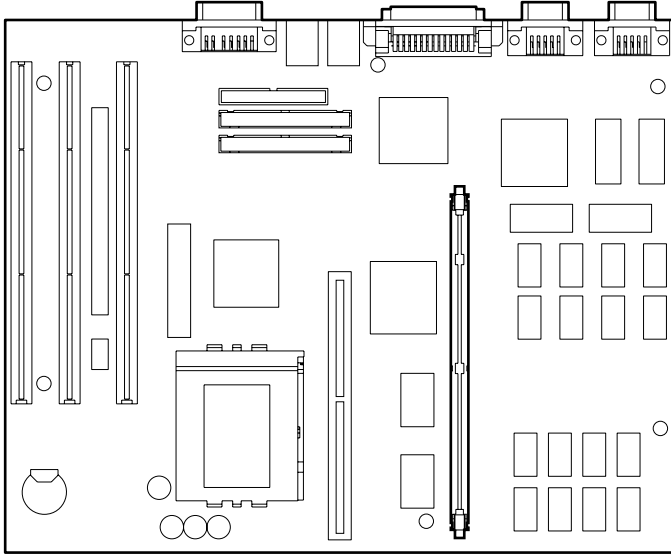

A MAXIMUM OF 48 OR 64 MB TOTAL MEMORY  
32 MB STANDARD MEMORY SOLDERED  
ON SYSTEM BOARD.

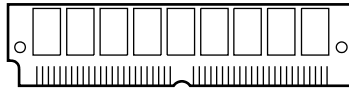

MEMORY OPTIONS ARE NOT AVAILABLE FOR THE  
PRESARIO 2250 SERIES, 2510, AND 2410ES

# Presario 2200/4200

Presario 2260, 2262,  
2264, 2266, 2270, 2274, 2275, 2276, 2278  
Memory Upgrade Chart

## PROCESSOR BOARD

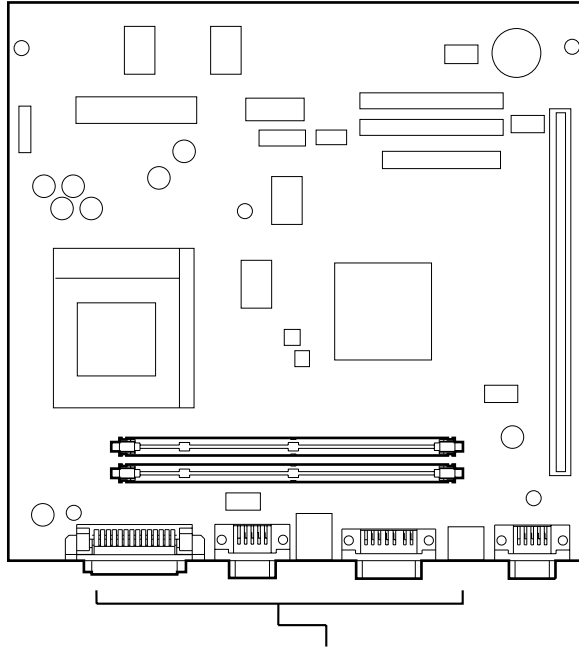

A MAXIMUM OF 256 MB TOTAL MEMORY  
USE 16, 32, OR 64 MB 100 MHz DIMMs

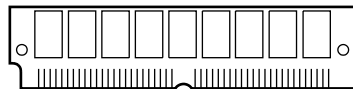

MEMORY OPTIONS ARE NOT AVAILABLE

# Presario 2200/4200

## Presario 2285V Series Memory Upgrade Chart

SYSTEM BOARD  
(96MB)

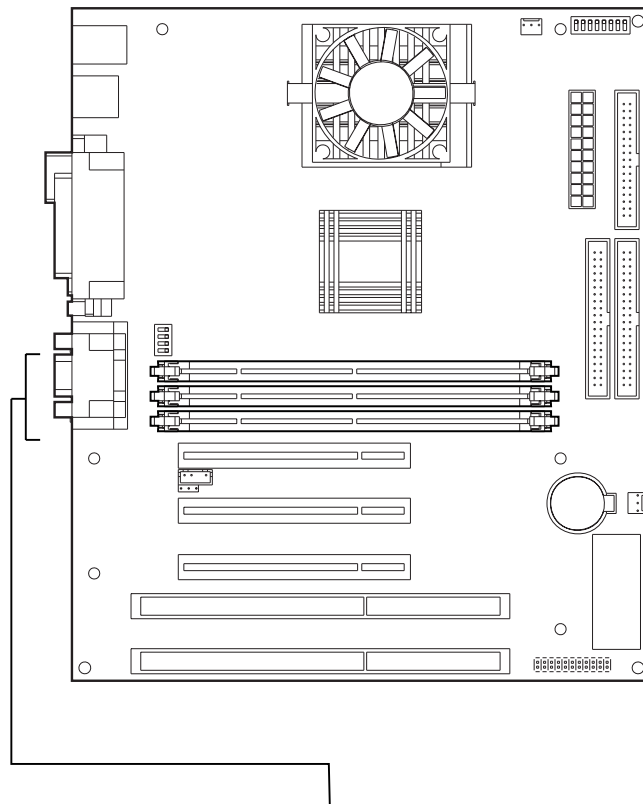

MAXIMUM MEMORY 384MB

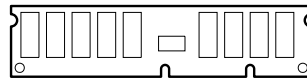

32-MB 100MHz SDRAM DIMM - OPTION PN 308875-001

64-MB 100MHz SDRAM DIMM - OPTION PN 308877-001

128-MB 100MHz SDRAM DIMM - OPTION PN 308878-001

# Presario 2200/4200

## Presario 4200 Series Memory Upgrade Chart

I/O BOARD

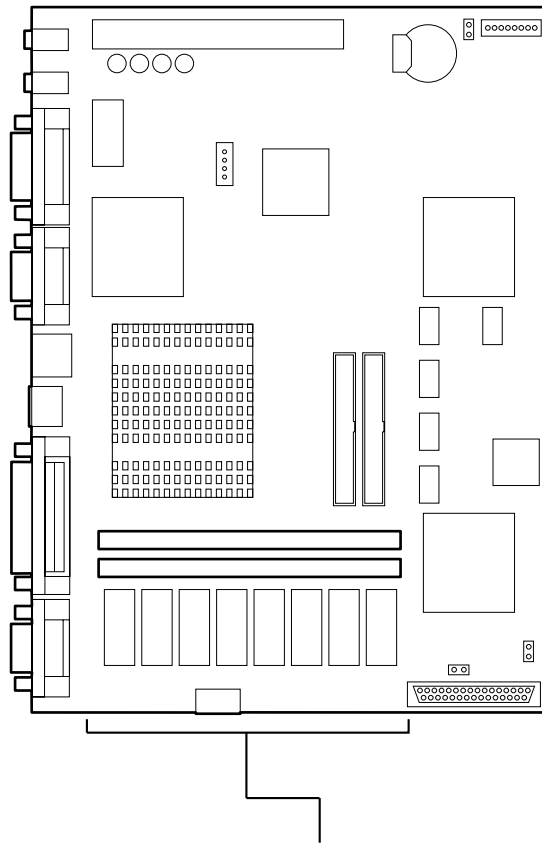

A MAXIMUM OF 80 MB TOTAL MEMORY

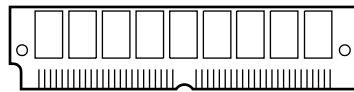

NO MEMORY OPTIONS

16-MB SDRAM DIMM - SPARE PN 271117-001

32-MB SDRAM DIMM - SPARE PN 271118-001

# Presario 2200/4200

## Presario 4230 Series Memory Upgrade Chart

I/O BOARD 32 MB EDO  
311009-001

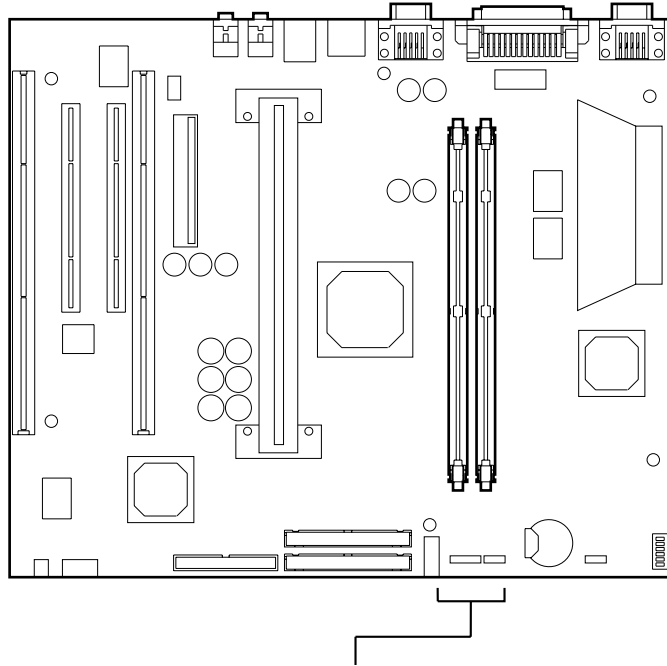

A MAXIMUM OF 256 MB TOTAL MEMORY

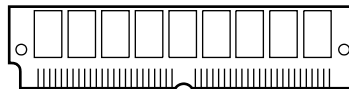

16-MB DIMMS, - OPTION PN 271433-001

32-MB DIMMS, - OPTION PN 271434-001

64-MB DIMMS, - OPTION PN 309081-001

128-MB DIMMS, - OPTION PN 309082-001

# Presario 2200/4200

## Presario 4240ES Series Memory Upgrade Chart

PROCESSOR BOARD  
SPARE PART # 319277-001

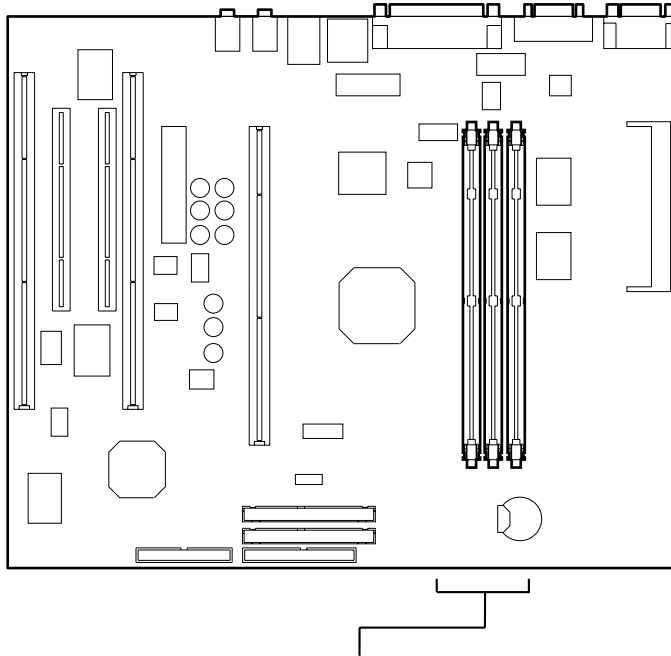

A MAXIMUM OF 384 MB TOTAL MEMORY

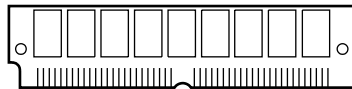

16-MB SDRAM DIMMs - OPTION PN 271433-001

32-MB SDRAM DIMMs - OPTION PN 271434-001

64-MB SDRAM DIMMs - OPTION PN 309081-001

128-MB SDRAM DIMMs - OPTION PN 309082-001