

## **Mainboard User's Manual**

This publication, including all photographs, illustrations and software, is protected under international copyright laws, with all rights reserved. Neither this manual, nor any of the material contained herein, may be reproduced without the express written consent of the manufacturer.

The information in this document is subject to change without notice. The manufacturer makes no representations or warranties with respect to the contents hereof and specifically disclaims any implied warranties of merchantability or fitness for any particular purpose. Further, the manufacturer reserves the right to revise this publication and to make changes from time to time in the content hereof without obligation of the manufacturer to notify any person of such revision or changes.

### **Trademarks**

IBM, VGA, and PS/2 are registered trademarks of International Business Machines.

Intel, Pentium/II/III/IV, Celeron and MMX are registered trademarks of Intel Corporation.

Microsoft, MS-DOS and Windows NT/95/98/ME/2000 are registered trademarks of Microsoft Corporation.

PC-cillin is a registered trademark of Trend Micro Inc.

AMI is a registered trademark of American Megatrends Inc.

A3D is a registered trademark of Aureal Inc.

MediaRing Talk is a registered trademark of MediaRing Inc.

3Deep is a registered trademark of E-Color Inc.

SiS is a trademark of Silicon Integrated System Corporation.

Other names used in this publication may be trademarks and are acknowledged.

**Copyright © 2001  
All Rights Reserved  
M930 Series, V1.5  
S645/November 2001**

## Mainboard User's Manual

### Notice:

1. Owing to Microsoft's certifying schedule is various to every supplier, we might have some drivers not certified yet by Microsoft. Therefore, it might happen under Windows XP that a dialogue box (shown as below) pop out warning you this software has not passed Windows Logo testing to verify its compatibility with Windows XP. Please rest assured that our RD department has already tested and verified these drivers. Just click the "Continue Anyway" button and go ahead the installation.

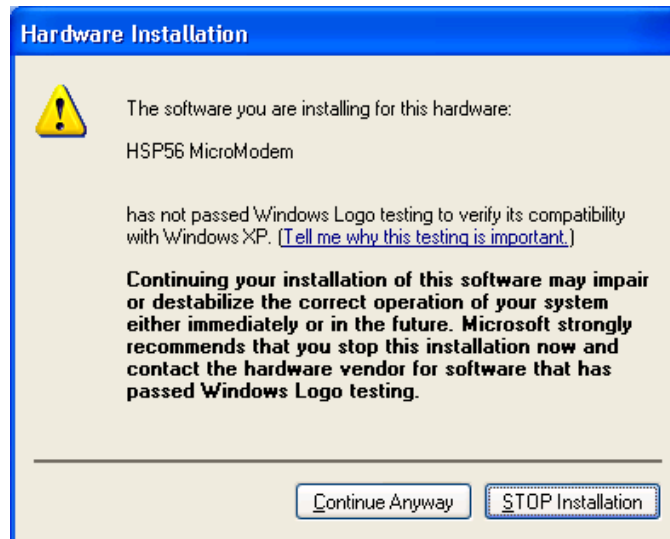

### 2. DDR333 SUPPORT LIST

Type	Brand	Chip	Total	Result	Note
DDR	NANYA	NT5DS16MBAT-6	128MB	PASS	
	NANYA	NT5DS16MBAT-6	256MB	PASS	
	KINGMAX	KDL684T4A2A-06	128MB	PASS	
	KINGMAX	KDL684T4A2A-06	256MB	PASS	
	Twin MOS	Hynix HY5DU28822AT-K	256MB	PASS	

## Mainboard User's Manual

### Table of Contents

Chapter 1: Introduction.....	1
Key Features.....	2
Package Contents.....	5
Static Electricity Precautions.....	6
Pre-Installation Inspection.....	6
Chapter 2: Mainboard Installation.....	7
Mainboard Components.....	8
I/O Ports.....	9
Install A CPU.....	10
Installing Memory Modules.....	11
Setting Jumper Switches.....	13
Install the Mainboard.....	13
Optional Extension Brackets.....	15
Install Other Devices.....	16
Expansion Slots .....	18
Chapter 3: BIOS Setup Utility.....	19
Introduction.....	19
Running the Setup Utility.....	20
Standard CMOS Setup Page.....	21
Advanced Setup Page.....	22
Power Management Setup Page.....	24
PCI/Plug and Play Setup Page.....	25
Load Optimal Settings.....	26
Load Best Performance Settings.....	26
Features Setup Page.....	27
CPU PnP Setup Page.....	29
Hardware Monitor Page.....	30
Change Password.....	38
Exit.....	31
Chapter 4: Software & Applications.....	33
Introduction.....	33
Installing Support Software.....	33
Auto-installing under Windows 98.....	35

**Mainboard User's Manual**

---

## Chapter 1

### Introduction

---

This mainboard has a **Socket-478** processor socket for **Intel Pentium 4** type of processors supporting front side bus (FSB) speeds up to **400 MHz**.

This mainboard uses the **XP4** chipset which supports built-in **AC97 Codec**, **2 DDR + 2 SDR** modules up to 2GB system memory, and provides **Ultra DMA 33/66/100** function. This mainboard has one **4X AGP** slot for highly graphics display, one **AMR** (Audio Modem Riser) slot to support Audio and Modem application, and built-in **10BaseT/100BaseTX Network Interface**. In addition, this mainboard has a full set of I/O ports including two PS/2 ports for mouse and keyboard, two serial ports, one parallel port, one MIDI/game port and four USB ports (two backpanel ports, onboard USB headers providing two extra ports). By means of the Extended USB Module connected to the mainboard, you can make two extra USB ports.

This mainboard is an ATX mainboard that uses a 4-layer printed circuit board and measures 305 x 244mm.

## Mainboard User's Manual

### Key Features

The key features of this mainboard include:

#### Socket-478 Processor

- ◆ The PGA Socket 478
- ◆ Supports **Intel Pentium 4 series** CPUs
- ◆ Supports up to 400 MHz Front-Side Bus

#### Memory Support

- ◆ Two 168-pin DIMM slots for SDRAM memory modules
- ◆ Two 184-pin DIMM slots for DDR memory modules
- ◆ Support SDRAM up to 133 MHz /DDR up to 333 MHz memory bus
- ◆ Maximum installed memory is 2GB

*Notice: You can NOT use SDRAM and DDR simultaneously.*

#### Expansion Slots

- ◆ One AMR slot for a special audio/modem riser card
- ◆ One 4xAGP slot for AGP 2.0-compliant interface
- ◆ Five 32-bit PCI slots for PCI 2.2-compliant bus interface

#### Onboard IDE channels

- ◆ Primary and Secondary PCI IDE channels
- ◆ Support for PIO (programmable input/output) modes
- ◆ Support for Multiword DMA modes
- ◆ Support for Bus Mastering and Ultra DMA 33/**66/100** modes

#### Power Supply and Power Management

- ◆ ATX power supply connector
- ◆ Meets ACPI 1.0b and APM 1.2 requirements, keyboard power on/off
- ◆ Supports RTC Alarm, Wake On Modem, AC97 Wake-Up and USB Wake-Up

## 1: Introduction

### VGA

- ◆ This mainboard includes a 4xAGP slot that provides eight times the bandwidth of the original AGP specification. AGP technology provides a direct connection between the graphics sub-system and memory so that the graphics do not have to compete for processor time with other devices on the PCI bus.

### AC97 Audio Codec

- ◆ Compliant AC97 2.2 specification
- ◆ Supports 18-bit ADC (Analog Digital Converter) and DAC (Digital Analog Converter) as well as 18-bit stereo full-duplex codec

### Built-in Ethernet LAN

- ◆ Built-in **10BaseT/100BaseTX Ethernet LAN**
- ◆ SiS961 Embedded Fast Ethernet MAC and onboard Realtek RTL8201 LAN PHY compliant with IEEE802.3u 100BASE-TX, 10BASE-T and ANSI X3.263 TP-PMD standards
- ◆ Compliant with ACPI 1.0 and the Network Device Class Power Management 1.0
- ◆ High Performance provided by 100Mbps clock generator and data recovery circuit for 100Mbps receiver

### Onboard I/O Ports

The mainboard has a full set of I/O ports and connectors:

- ◆ Two PS/2 ports for mouse and keyboard
- ◆ Two serial ports
- ◆ One parallel port
- ◆ One MIDI/game port
- ◆ Four USB ports (two backpanel ports, onboard USB headers providing two extra ports)
- ◆ Audio jacks for microphone, line-in and line-out

### Hardware Monitoring

- ◆ Built-in hardware monitoring for CPU & System temperatures, fan speeds and mainboard voltages.

## Mainboard User's Manual

### Onboard Flash ROM

- ◆ Supports Plug and Play configuration of peripheral devices and expansion cards

### Bundled Software

- ◆ **PC-Cillin2000** provides automatic virus protection under Windows 95/98/NT/2000
- ◆ **MediaRing Talk** provides PC to PC or PC to Phone internet phone communication
- ◆ **3Deep** delivers the precise imagery and displays accurate color in your monitor
- ◆ **WinDVD2000** is a DVD playback application (optional)
- ◆ **Recovery Genius 21<sup>st</sup> V5.0** provides the function to recover, reserve and transfer hard disk data.
- ◆ **CD Ghost** is the software stimulating a real CD-ROM to perform equivalent function.
- ◆ **Language Genius 21<sup>st</sup>** is the software to provides learning tools of language and singing.

### Dimensions

- ◆ ATX form factor 305 x 244mm



## 1: Introduction

### Package Contents

**Attention** : This mainboard serial has two models, M930LR(LAN Ready) and M930(without LAN). Please contact your local supplier for more information about your purchased model. Each model will support different specification listed as below:

Model	Specification
M930LR	Onboard LAN PHY chip (U12,U4), USB + RJ-45 LAN connector
M930	USB connector only

Your mainboard package contains the following items:

- The mainboard
- The User's Manual
- One diskette drive ribbon cable and bracket
- One IDE drive ribbon cable and bracket
- Software support CD
- Module Retention damp

### Optional Accessories

You can purchase the following optional accessories for this mainboard.

- Extended USB module
- AMR v.90 56K Fax/Modem card

## **Mainboard User's Manual**

### **Static Electricity Precautions**

Components on this mainboard can be damaged by static electricity. Take the following precautions when unpacking the mainboard and installing it in a system.

1. Keep the mainboard and other components in their original static-proof packaging until you are ready to install them.
2. During installation, wear a grounded wrist strap if possible. If you don't have a wrist strap, discharge static electricity by touching the bare metal of the system chassis.
3. Handle the mainboard carefully by the edges. Avoid touching the components unless it is absolutely necessary. During installation put the mainboard on top of the static-protection packaging it came in with the component side facing up.

### **Pre-Installation Inspection**

1. Inspect the mainboard for damage to the components and connectors on the board.
2. If you suspect that the mainboard has been damaged, do not connect power to the system. Contact your mainboard vendor and report the damage.

## Chapter 2

# Mainboard Installation

---

To install this mainboard in a system, please follow the instructions in this chapter:

- ❑ Identify the mainboard components
- ❑ Install a CPU
- ❑ Install one or more system memory modules
- ❑ Verify that all jumpers or switches are set correctly
- ❑ Install the mainboard in a system chassis (case)
- ❑ Connect any extension brackets or cables to connecting headers on the mainboard
- ❑ Install other devices and make the appropriate connections to the mainboard connecting headers.

**Note:**

1. Before installing this mainboard, make sure jumper JP4 is under Normal setting. See this chapter for information about locating JP4 and the setting options.
2. Never connect power to the system during installation; otherwise, it may damage the mainboard.

## Mainboard User's Manual

### Mainboard Components

Use the diagram below to identify the major components on the mainboard.

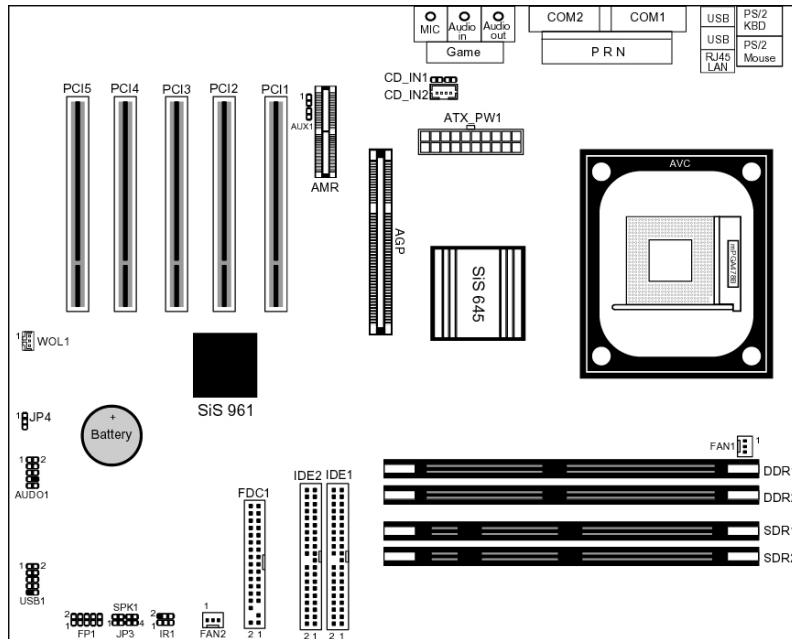

**Note:** Any jumpers on your mainboard that do not appear in the illustration above are for testing only.

## 2: Mainboard Installation

### I/O Ports

The illustration below shows a side view of the built-in I/O ports on the mainboard.

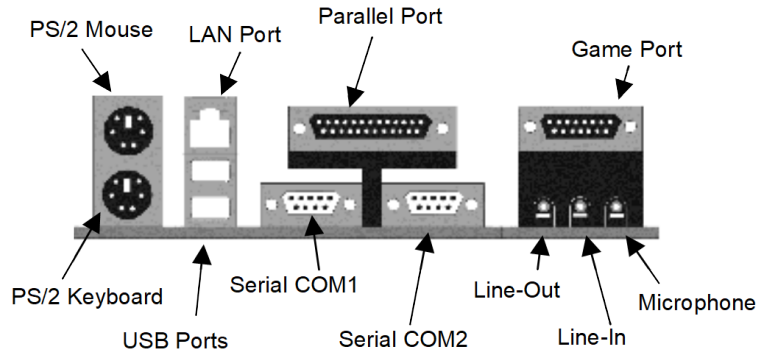

1. Use the upper PS/2 port to connect a PS/2 pointing device.
2. Use the lower PS/2 port to connect a PS/2 keyboard.
3. Use the USB ports to connect USB devices.
4. Use LPT1 to connect printers or other parallel communications devices.
5. Use the COM ports to connect serial devices such as mice or fax/modems. COM1 is identified by the system as COM1/3. COM2 is identified by the system as COM2/4.
6. Use the game port to connect a joystick or a MIDI device.
7. Use the three audio ports to connect audio devices. The left side jack is for a stereo line-out signal. The middle jack is for a stereo line-in signal. The right side jack is for a microphone.
8. Use this port to connect to the network.

## Mainboard User's Manual

### Install A CPU

This mainboard has a Socket-478 which supports Intel Pentium 4 series processors.

**To ensure reliability, ensure that your processor has a heatsink/cooling fan assembly.**

Do neither try to install a Socket 370 processor nor a Socket423 in the Socket-478. A Socket 370 processor such as the Pentium III, or Celeron , does not fit in the Socket 478.

The following processor is currently supported by this mainboard.

**Intel P4 478:** 1.4GHz ~ 2.2GHz, FSB: 400MHz

### Installing a Socket-478 Processor

A processor installs into the ZIF (Zero Insertion Force) Socket-478 on the mainboard.

1. Locate the Socket-478 and CPU FAN1. Pull the locking lever out slightly from the socket and raise it to the upright position.

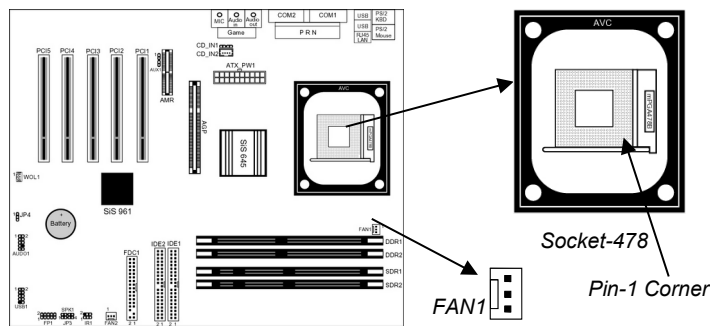

2. On the processor, identify the Pin-1 corner by its beveled edge.
3. On the Socket-478, identify the Pin-1 corner. The Pin-1 corner is at the top of the locking lever when it is locked.
4. Match the Pin-1 corners and insert the processor into the socket. No force is required and the processor should drop into place freely.

## 2: Mainboard Installation

5. Swing the locking lever down and hook it under the catch on the side of the socket. This secures the CPU in the socket.
6. All processors should be installed with a combination heatsink/cooling fan, connect the cable from the fan to the CPU fan power connector CPU FAN1.

### Installing Memory Modules

This mainboard accommodates 168-pin 3.3V/184-pin 2.5V unbuffered SDRAM memory modules. The memory chips must be standard or registered SDRAM (Synchronous Dynamic Random Access Memory).

The CPU supports 100MHz system bus. The SDRAM DIMMs and DDRs can synchronously work with 100 MHz or operates over a 333 MHz system bus.

You must install at least one memory module in order to use the mainboard, **either SDRAM or DDR SDRAM, but you can not use them simultaneously.**

DDR SDRAM provides 800 MBps or 1 GBps data transfer depending on whether the bus is 100 MHz or 333 MHz. It doubles the rate to 1.0 GBps and 2.1 GBps by transferring data on both the rising and falling edges of the clock. DDR SDRAM uses additional power and ground lines and requires 184-pin 2.5V unbuffered DIMM module rather than the 168-pin 3.3V unbuffered DIMMs used by SDRAM.

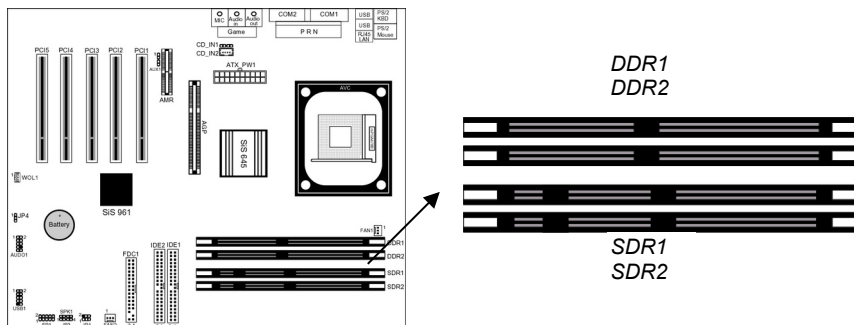

## Mainboard User's Manual

### Installation Procedure

The mainboard accommodates two memory modules. You must install at least one module in any of the three slots. Each module can be installed with up to 2GB system memory.

Refer to the following to install the memory modules.

1. Push the latches on each side of the DIMM slot down.
2. Align the memory module with the slot. The DIMM slots are keyed with notches and the DIMMs are keyed with cutouts so that they can only be installed correctly.
3. Check that the cutouts on the DIMM module edge connector match the notches in the DIMM slot.
4. Install the DIMM module into the slot and press it firmly down until it seats correctly. The slot latches are levered upwards and latch on to the edges of the DIMM.
5. Install any remaining DIMM modules.



## 2: Mainboard Installation

### Setting Jumper Switches

Jumpers are sets of pins connected together with jumper caps. The jumper caps change the way the mainboard operates by changing the electronic circuits on the mainboard. If a jumper cap connects two pins, we say the pins are SHORT. If a jumper cap is removed from two pins, the pins are OPEN.

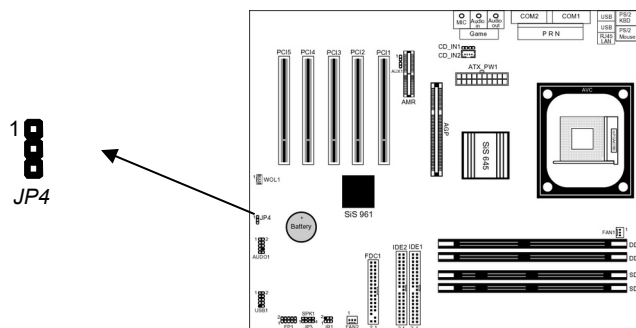

### Jumper JP4: Clear CMOS Memory

Use this jumper to clear the contents of the CMOS memory. You may need to clear the CMOS memory if the settings in the Setup Utility are incorrect and prevent your mainboard from operating. To clear the CMOS memory, disconnect all the power cables from the mainboard and then move the jumper cap into the CLEAR setting for a few seconds.

Function	Jumper Setting
Clear CMOS	Short Pins 1-2
Normal Mode	Short Pins 2-3

### Install the Mainboard

Install the mainboard in a system chassis (case). The board is an ATX size mainboard with a twin-tier of I/O ports. You can install this mainboard in an ATX case. Ensure that your case has an I/O cover plate that matches the ports on this mainboard.

## Mainboard User's Manual

Install the mainboard in a case. Follow the instructions provided by the case manufacturer using the hardware and internal mounting points on the chassis.

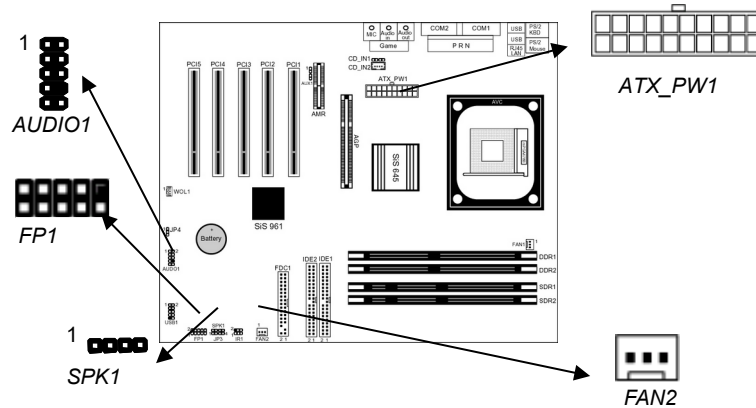

Connect the power connector from the power supply to the **ATX\_PW1** connector on the mainboard.

If there is a cooling fan installed in the system chassis, connect the cable from the cooling fan to the **FAN2** fan power connector on the mainboard.

Connect the cable from the PC speaker to the **SPK1** header on the mainboard.

Connect the case switches and indicator LEDs to the **FP1** header.

If there are a headphone jack or/and a microphone jack on the front panel, connect the cables to the **AUDIO1** header on the mainboard. See the illustrations below for the guide to the FP1 and AUDIO1 headers pin assignments.

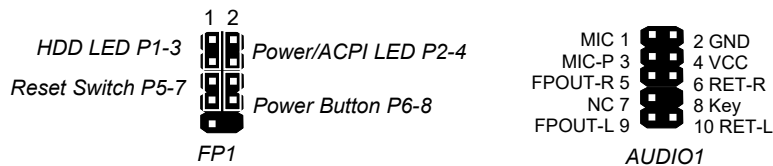

## 2: Mainboard Installation

### Optional Extension Brackets

For this mainboard, you can also obtain a USB module extension bracket for more USB ports. Install them by following the steps below.

*Note: All the ribbon cables used on the extension brackets have a red stripe on the Pin-1 side of the cable.*

### Extended USB Module

This module bracket has two USB ports for more USB devices (USB port 3-4).

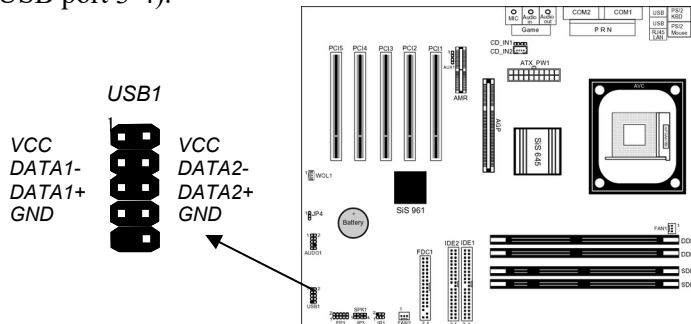

1. Locate the USB1 header on the mainboard.
2. Plug the bracket cable onto the USB1 header.
3. In the system chassis, remove a slot cover from one of the expansion slots and install the extension bracket in the opening. Use the screw that held the slot cover in place to secure the extension bracket to the chassis.

## Mainboard User's Manual

### Install Other Devices

Install and connect other devices in the system as steps below.

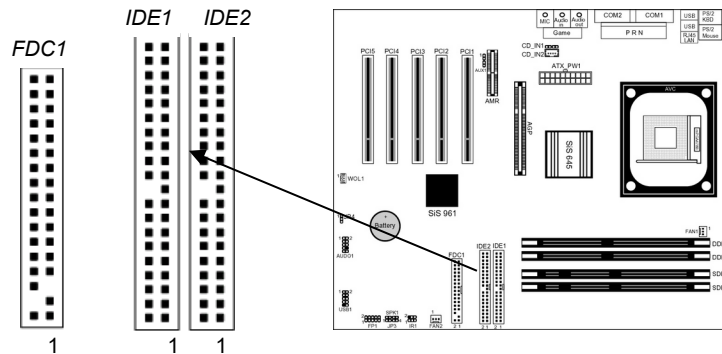

#### Floppy Disk Drive

The mainboard ships with a floppy disk drive cable that can support one or two drives. Drives can be 3.5" or 5.25" wide, with capacities of 360K, 720K, 1.2MB, 1.44MB, or 2.88MB.

Install your drives and connect power from the system power supply. Use the cable provided to connect the drives to the floppy disk drive connector **FDC1**.

#### IDE Devices

IDE devices include hard disk drives, high-density diskette drives, and CD-ROM or DVD-ROM drives, among others.

The mainboard ships with an IDE cable that can support one or two IDE devices. If you connect two devices to a single cable, you must configure one of the drives as Master and one of the drives as Slave. The documentation of the IDE device will tell you how to configure the device as a Master or Slave device. The Master device connects to the end of the cable.

Install the device(s) and connect power from the system power supply. Use the cable provided to connect the device(s) to the Primary IDE channel connector **IDE1** on the mainboard.

If you want to install more IDE devices, you can purchase a second IDE cable and connect one or two devices to the Secondary IDE channel connector **IDE2** on the mainboard. If you have two devices on the cable, one must be Master and one must be Slave.

## 2: Mainboard Installation

### Internal Sound Connections

If you have installed a CD-ROM drive or DVD-ROM drive, you can connect the drive audio cable to the onboard sound system.

On the mainboard, locate the two 4-pin connectors **CD\_IN1** and **CD\_IN2**. There are two kinds of connector because different brands of CD-ROM drive have different kinds of audio cable connectors. Connect the cable to the appropriate connector.

If you have installed a secondary CD-ROM drive or DVD-ROM drive, you can connect the drive audio cable to the onboard sound system. On the mainboard, locate the 4-pin Aux-In header **AUX1**, connect the cable to the connector.

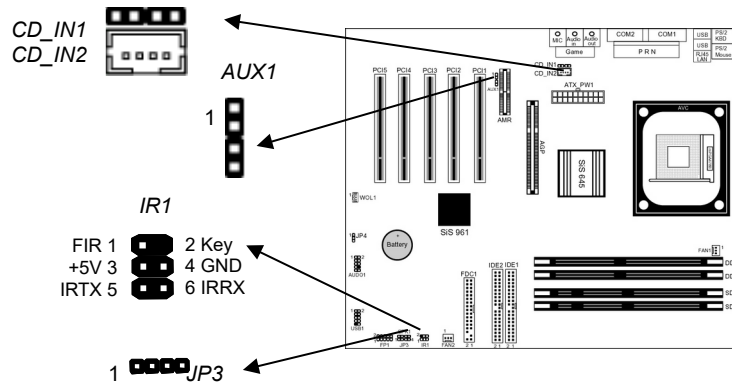

### Infrared Port

You can connect an infrared port to the mainboard. You can purchase this option from third-party vendors.

1. Locate the infrared port **IR1** header on the mainboard.
2. If you are adding an infrared port, connect the ribbon cable from the port to the IR header and then secure the port to an appropriate place in your system chassis.

### Onboard LAN LED Connections

If you have a set indicator LEDs for the onboard LAN communication, you can connect the LED cable to the header **JP3**. Pins 1-2 are for Link LED. Pins 3-4 are for 10/100 Mbps mode LED, the onboard LAN run in 100 Mbps mode when the LED lit.

## Mainboard User's Manual

### Expansion Slots

This mainboard has five 32-bit PCI slots, one AGP slot and one AMR slot.

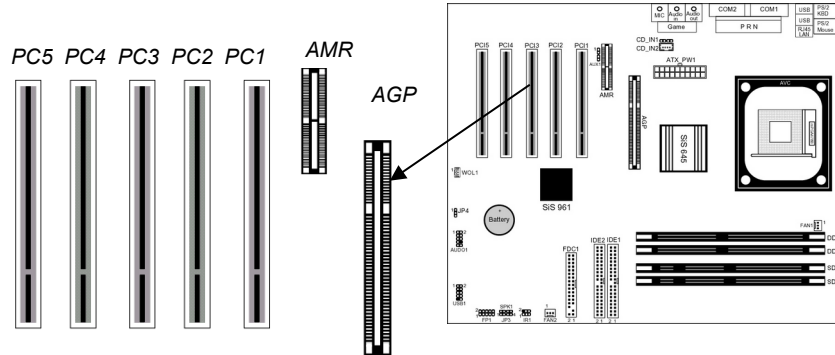

Follow the steps below to install a PCI/AGP/AMR expansion card.

1. Locate the AMR, AGP or PCI slots on the mainboard.
2. Remove the slot cover for this slot from the system chassis.
3. Insert the expansion card edge connector into the slot and press it firmly down into it so that it is fully inserted.
4. Secure the expansion card bracket to the system chassis using the screw that held the slot cover in place.

#### AMR Slot

The AMR (Audio Modem Riser) slot is an industry standard slot that allows for the installation of a special audio/modem riser card. Different territories have different regulations regarding the specifications of a modem card. You can purchase an AMR card that is approved in your area and install it directly into the AMR slot.

## Chapter 3

# BIOS Setup Utility

---

### Introduction

The BIOS Setup Utility records settings and information about your computer such as the date and time, the kind of hardware installed, and various configuration settings. Your computer uses this information to initialize all the components when booting up and functions as the basis for coordination between system components.

If the Setup Utility configuration is incorrect, it may cause the system to malfunction. It can even stop your computer from booting properly. If this happens, you can use the clear CMOS jumper to clear the CMOS memory used to store the configuration information.

You can run the setup utility and manually make changes to the configuration. You might need to do this to configure some of the hardware that you install on or connect to the mainboard, such as the CPU, system memory, disk drives, etc.

## Mainboard User's Manual

### Running the Setup Utility

Each time your computer starts, before the operating system loads, a message appears on the screen that prompts you to “Hit <DEL> if you want to run SETUP”. When you see this message, press the **Delete** key and the Main menu page of the Setup Utility appears on your monitor.

AMIBIOS SIMPLE SETUP UTILITY – VERSION 1.21.06  
(C) 2000 American Megatrends, Inc. All Rights Reserved

<b>Standard CMOS Setup</b>	<b>Features Setup</b>
Advanced Setup	CPU PnP Setup
Power Management Setup	Hardware Monitor
PCI / Plug and Play Setup	Change Password
Load Optimal Settings	Exit
Load Best Performance Settings	
Esc : Quit    ↑ ↓ ← →: Select Item (Shift)F2 : Change Color    F5 : Old Values F6 : Optimal values                      F7 : Best performance values    F10 : Save&Exit	
Standards CMOS setup for changing time, date, hard disk type, etc.	

You can use the cursor arrow keys to highlight any of the options on the main menu page. Press **Enter** to select the highlighted option. To leave the setup utility, press the **Escape** key. To cycle through the Setup Utility's optional color schemes hold down the **Shift** key and press **F2**.

Some of the options on the main menu page lead to tables of items with installed values. In these pages, use the cursor arrow keys to highlight the items, and then use the **PgUp** and **PgDn** keys to cycle through the alternate values for each of the items. Other options on the main menu page lead to dialog boxes which require you to answer Yes or No by hitting the **Y** or **N** keys.

If you have already made changes to the setup utility, press **F10** to save those changes and exit the utility. Press **F5** to reset the changes to the original values. Press **F6** to install the setup utility with a set of default values. Press **F7** to install the setup utility with a set of high-performance values.



### 3: BIOS Setup Utility

#### Standard CMOS Setup Page

Use this page to set basic information such as the date, the time, the IDE devices, and the diskette drives. If you press the F3 key, the system will automatically detect and configure the hard disks on the IDE channels.

AMIBIOS SETUP – STANDARD CMOS SETUP										
(C) 2000 American Megatrends, Inc. All Rights Reserved										
Date (mm/dd/yy) : Wed Sep.19, 2001										
Time (hh/mm/ss) : 17:01:35										
	Type	Size	Cyln	Head	WPcom	Sec	LBA Mode	Blk Mode	PIO Mode	32Bit Mode
Pri Master	: Auto									On
Pri Slave	: Auto									On
Sec Master	: Auto									On
Sec Slave	: Auto									On
Floppy Drive A : 1.44 MB 3 1/2										
Floppy Drive B : Not Installed										
Month : Jan – Dec							ESC : Exit			
Day : 01 – 31							↑↓ : Select Item			
Year : 1901 – 2099							PU/PD/+/- : Modify			
							(Shift)F2 : Color			
							F3 : Detect All HDD			

<b>Date &amp; Time</b>	Use these items to set the system date and time
<b>Pri Master</b>	Use these items to configure devices connected to the Primary and Secondary IDE channels. To configure an IDE hard disk drive, choose <i>Auto</i> . If the <i>Auto</i> setting fails to find a hard disk drive, set it to <i>User</i> , and then fill in the hard disk characteristics (Size, Cyls, etc.) manually. If you have a CD-ROM drive, select the setting <i>CDROM</i> . If you have an ATAPI device with removable media (e.g. a ZIP drive or an LS-120) select <i>Floptical</i> .
<b>Pri Slave</b>	
<b>Sec Master</b>	
<b>Sec Slave</b>	
<b>Floppy Drive A</b>	Use these items to set the size and capacity of the floppy diskette drive(s) installed in the system.
<b>Floppy Drive B</b>	

## Mainboard User's Manual

### Advanced Setup Page

Use this page to set more advanced information about your system. Take some care with this page. Making changes can affect the operation of your computer.

AMIBIOS SETUP – ADVANCED SETUP		
(C) 2000 American Megatrends, Inc. All Rights Reserved		
Quick Boot	Enabled	
1 <sup>st</sup> Boot Device	IDE-0	
2 <sup>nd</sup> Boot Device	Floppy	
3 <sup>rd</sup> Boot Device	CDROM	
Try Other Boot Devices	Yes	
S.M.A.R.T. for Hard Disks	Disabled	
BootUp Num-Lock	On	
Floppy Drive Swap	Disabled	
Floppy Drive Seek	Disabled	
Password Check	Setup	ESC : Quit      ↑↓←→ : Select Item
Boot To OS/2 > 64MB	No	F1 : Help      PU/PD/+/- : Modify
L2 Cache	Enabled	F5 : Old Values (Shift)F2 : Color
System BIOS Cacheable	Disabled	F6 : Load BIOS Defaults
Graphic Win Size	4M	F7 : Load Setup Defaults
DRAM CAS# Latency	3T	
Timing Setting Mode	Normal	
MA 1T/2T Select	Auto	
Advanced Read Prefetch	Enabled	
Auto Detect DIMM/PCI Clk	Enabled	
Spread Spectrum	Disabled	

### 3: BIOS Setup Utility

<b>Quick Boot</b>	If you enable this item, the system starts up more quickly by elimination of some of the power on test routines.
<b>1<sup>st</sup> Boot Device</b> <b>2<sup>nd</sup> Boot Device</b> <b>3<sup>rd</sup> Boot Device</b>	Use these items to determine the device order the computer uses to look for an operating system to load at start-up time.
<b>Try Other Boot Device</b>	If you enable this item, the system will also search for other boot devices if it fails to find an operating system from the first two locations.
<b>S.M.A.R.T. for Hard Disks</b>	Enable this item if any IDE hard disks support the S.M.A.R.T. (Self-Monitoring, Analysis and Reporting Technology) feature.
<b>BootUp Num-Lock</b>	This item determines if the Num Lock key is active or inactive at system start-up time.
<b>Floppy Drive Swap</b>	If you have two diskette drives installed and you enable this item, drive A becomes drive B and drive B becomes drive A.
<b>Floppy Drive Seek</b>	If you enable this item, your system will check all floppy disk drives at start up. Disable this item unless you are using an old 360KB drive.
<b>Password Check</b>	If you have entered a password for the system, use this item to determine, if the password is required to enter the Setup Utility ( <i>Setup</i> ) or required both at start-up and to enter the Setup Utility ( <i>Always</i> ).
<b>Boot to OS/2 &gt; 64MB</b>	Enable this item if you are booting the OS/2 operating system and you have more than 64MB of system memory installed.
<b>L2 Cache</b>	Leave these items enabled since all the processors that can be installed on this board have internal L2 cache memory.
<b>System BIOS Cacheable</b>	If you enable this item, a segment of the system BIOS will be copied to main memory for faster execution.
<b>Graphic Win Size</b>	This item defines the size of aperture if you use a graphic adapter.

## Mainboard User's Manual

<b>DRAM CAS# Latency</b>	This item determines the operation of DRAM memory CAS (column address strobe). It is recommended that you leave this item at the default value. The 3T setting requires faster memory that specifically supports this mode.
<b>Timing Setting Mode</b>	This item determines the timing setting mode of the memory. We recommend you leave this item at the default value.
<b>MA 1T/2T Select</b>	This item adjusts timing 1T/2T latency. We recommend you to leave this item at the default value.
<b>Advanced Read Prefetch</b>	This item enables prefetching for reading data. We recommend you to leave this item at the default value.
<b>Auto detect DIMM/PCI Clk</b>	When this item is enabled, BIOS will disable the clock signal of free DIMM/PCI slots.
<b>Spread Spectrum</b>	If you enable spread spectrum, it can significantly reduce the EMI(Electro-Magnetic Interference) generated by the system.

### 3: BIOS Setup Utility

## Power Management Setup Page

This page sets some of the parameters for system power management operation.

AMIBIOS SETUP – POWER MANAGEMENT SETUP (C) 2000 American Megatrends, Inc. All Rights Reserved		
ACPI Aware O/S	Yes	
Power Management	Enabled	
Suspend Time out	Disabled	
Hard Disk Time out	Disabled	
Resume On RTC Alarm	Disabled	
RTC Alarm Date	15	ESC : Quit      ↑↓←→ : Select Item
RTC Alarm Hour	12	F1 : Help      PU/PD/+/- : Modify
RTC Alarm Minute	30	F5 : Old Values (Shift)F2 : Color
RTC Alarm Second	30	
LAN/Ring Power On	Disabled	F6 : Load BIOS Defaults
Keyboard Power On	Disabled	F7 : Load Setup Defaults

<b>ACPI Aware O/S</b>	Enable this item if you are using an O/S that supports ACPI function such as Windows 98/ME / 2000.
<b>Power Management</b>	Use this item to select a power management scheme. Both APM and ACPI are supported.
<b>Suspend Time Out</b>	This sets the timeout for Suspend mode in minutes. If the time selected passes without any system activity, the computer will enter power-saving Suspend mode.
<b>Hard Disk Time Out</b>	This sets the timeout to power down the hard disk drive, if the time selected passes without any hard disk activity.
<b>Resume On RTC Alarm Date / Hour / Minute / Second</b>	The system can be turned off with a software command. If you enable this item, the system can automatically resume at a fixed time based on the system's RTC (realtime clock). Use the items below this one to set the date and time of the wake-up alarm. You must use an ATX power supply in order to use this feature.
<b>LAN/Ring Power On</b>	The system can be turned off with a software command. If you enable this item, the system can automatically resume if there is an incoming call on the Modem. You must use an ATX power supply in order to use this feature.

## Mainboard User's Manual

---

<b>Keyboard Power On</b>	If you enable this item, you can turn the system on and off by pressing hot keys on the keyboard. You must enable the Keyboard Power On jumper and use an ATX power supply in order to use this feature.
--------------------------	--

---

## PCI / Plug and Play Setup Page

This page sets some of the parameters for devices installed on the PCI bus and devices that use the system plug and play capability.

AMIBIOS SETUP – PCI / PLUG AND PLAY SETUP (C) 2000 American Megatrends, Inc. All Rights Reserved	
Plug and Play Aware O/S	Yes
Primary Graphics Adapter	PCI
Allocate IRQ for PCI VGA	Yes
ESC : Quit      ↑↓←→ : Select Item F1 : Help      PU/PD/+/- : Modify F5 : Old Values (Shift) F2 : Color F6 : Load BIOS Defaults F7 : Load Setup Defaults	

---

<b>Plug and Play Aware O/S</b>	Enable this item if you are using an O/S that supports Plug and Play such as Windows 95/98/ME.
<b>Primary Graphics Adapter</b>	This item indicates if the primary graphics adapter uses the PCI or the AGP bus. The default PCI setting still lets the onboard display work and allows the use of a second display card installed in a PCI slot.
<b>Allocate IRQ to PCI VGA</b>	If this item is enabled, an IRQ will be assigned to the PCI VGA graphics system. You set this value to No to free up an IRQ.

---

### 3: BIOS Setup Utility

#### **Load Optimal Settings**

If you select this item and press **Enter** a dialog box appears. If you press **Y**, and then **Enter**, the Setup Utility loads a set of fail-safe default values. These default values are not very demanding and they should allow your system to function with most kinds of hardware and memory chips.

*Note: It is highly recommended that users enter this option to load optimal values for accessing the best performance.*

#### **Load Best Performance Settings**

If you select this item and press **Enter** a dialog box appears. If you press **Y**, and then **Enter**, the Setup Utility loads a set of best-performance default values. These default values are quite demanding and your system might not function properly if you are using slower memory chips or other low-performance components.

## Mainboard User's Manual

### Features Setup Page

This page sets some of the parameters for peripheral devices connected to the system.

AMIBIOS SETUP – FEATURES SETUP (C) 2000 American Megatrends, Inc. All Rights Reserved		
OnBoard FDC	Enabled	ESC : Quit      ↑↓←→ : Select Item F1 : Help      PU/PD/+/- : Modify F5 : Old Values (Shift) F2 : Color F6 : Load BIOS Defaults F7 : Load Setup Defaults
OnBoard Serial PortA	3F8h/COM1	
OnBoard Serial PortB	2F8h/COM2	
Serial Port2 Mode	Normal	
OnBoard Parallel Port	378h	
Parallel Port Mode	ECP	
Parallel Port IRQ	7	
Parallel Port DMA	3	
OnBoard Game Port	201h	
OnBoard MIDI Port	300h	
MIDI Port IRQ	10	
OnBoard PCI IDE	Both	
Audio Device	Enabled	
Modem Device	Enabled	
Ethernet Device	Enabled	
Onboard USB Function	Enabled	
USB Function for DOS	Disabled	

<b>OnBoard FDC</b>	Use this item to enable or disable the onboard floppy disk drive interface.
<b>OnBoard Serial PortA/B</b>	Use these items to enable or disable the onboard COM1/2 serial port, and to assign a port address.
<b>Serial Port2 Mode</b>	Use this item to allocate the resources of the second serial port. Under Normal, the resources are allocated to the onboard serial port. Under ASKIR or IrDA, the resources are allocated to the onboard IR port.
<b>Onboard Parallel Port</b>	Use this item to enable or disable the onboard LPT1 parallel port, and to assign a port address. The Auto setting will detect and available address.



### 3: BIOS Setup Utility

<b>Parallel Port Mode</b>	Use this item to set the parallel port mode. You can select SPP (Standard Parallel Port), ECP (Extended Capabilities Port), EPP (Enhanced Parallel Port), or ECP + EPP.
<b>Parallel Port IRQ</b>	Use this item to assign either IRQ 5 or 7 to the parallel port.
<b>Parallel Port DMA</b>	Use this item to assign a DMA channel to the parallel port. The options are 0, 1 and 3.
<b>OnBoard Game Port</b>	Use this item to enable or disable the onboard Game port.
<b>OnBoard MIDI Port</b>	Use this item to enable or disable the onboard MIDI port, and to assign a port address.
<b>MIDI Port IRQ</b>	Use this item to assign an IRQ to the MIDI port.
<b>Onboard PCI IDE</b>	Use this item to enable or disable either or both of the onboard Primary and Secondary IDE channels.
<b>Audio Device</b>	This item enables or disables the onboard AC'97 audio chip.
<b>Modem Device</b>	This item enables or disables the onboard AC'97 modem chip.
<b>Ethernet Device</b>	This item enables or disables the onboard Ethernet LAN.
<b>Onboard USB Function</b>	Enable this item if you plan to use the USB ports on this mainboard.
<b>USB Function for DOS</b>	Enable this item if you plan to use the USB ports on this mainboard in a DOS environment.

## Mainboard User's Manual

### CPU PnP Setup Page

This page lets you manually configure the mainboard for the CPU. The system will automatically detect the kind of CPU that you have installed and make the appropriate adjustments to the items on this page.

AMIBIOS SETUP – CPU PnP SETUP	
©2000 American Megatrends, Inc. All Rights Reserved	
CPU Type	Intel P4
CPU/DRAM Speed	100/100 MHz
CPU Core Voltage	1.616V
CPU Ratio	H/W Trap
CPU Frequency	100 MHz
DRAM Frequency	100 MHz
ESC : Quit      ↑↓←→ : Select Item F1 : Help      PU/PD/+/- : Modify F5 : Old Values (Shift)F2 : Color F6 : Load Optimal values F7 : Load Best performance values	

---

<b>CPU Type/Core Voltage/Ratio/Frequency</b>	These items show the type, core voltage, ratio and frequency of CPU installed in your system.
--	---

---

<b>CPU/DRAM Speed/Frequency</b>	These items decide CPU/DRAM speed/frequency installed in your system.
---------------------------------	---

---

### 3: BIOS Setup Utility

#### Hardware Monitor Page

This page sets some of the parameters for the hardware monitoring function of this mainboard.

AMIBIOS SETUP – HARDWARE MONITOR		
(C) 2000 American Megatrends, Inc. All Rights Reserved		
*** System Hardware ***		
Vcore	1.632V	
Vcc 2.5V/Vcc3.3V	2.496V	
Vcc 3.3V	3.392V	
Vcc	4.972V	
+12V	11.968V	
SB3V	3.264V	
-12V	-0.907V	
SB5V	5.053V	
VBAT	3.488V	ESC : Quit      ↑↓←→ : Select Item
SYSTEM Fan Speed	0 RPM	F1 : Help      PU/PD/+/- : Modify
CPU Fan Speed	5400 RPM	F5 : Old Values (Shift)F2 : Color
Power Temperature	33°C/91°F	F6 : Load BIOS Defaults
SYSTEM Temperature	40°C/104°F	F7 : Load Setup Defaults
CPU Temperature	35°C/95°F	

<b>CPU / System Temperature</b>	These items display CPU and system temperature measurement.
<b>FANs &amp; Voltage Measurements</b>	These items indicate cooling fan speeds in RPM and the various system voltage measurements.

## Mainboard User's Manual

### **Change Password**

If you highlight this item and press **Enter**, a dialog box appears which lets you enter a Supervisor password. You can enter no more than six letters or numbers. Press **Enter** after you have typed in the password. A second dialog box asks you to retype the password for confirmation. Press **Enter** after you have retyped it correctly. The password is then required to access the Setup Utility or for that and at start-up, depending on the setting of the Password Check item in Advanced Setup.

### **Change or Remove the Password**

Highlight this item, press **Enter** and type in the current password. At the next dialog box, type in the new password, or just press **Enter** to disable password protection.

### **Exit**

Highlight this item and press **Enter** to save the changes that you have made in the Setup Utility configuration and exit the program. When the Save and Exit dialog box appears, press **Y** to save and exit, or press **N** to exit without saving.

### 3: BIOS Setup Utility

## Chapter 4

# Software & Applications

---

### Introduction

The support software CD-ROM attached to this mainboard package contains all necessary drivers and utility programs for properly running our products. You can find out a brief description of each software program and the location for your mainboard version as below. More information on some programs is available in a README file located in the same directory as the software.

**If the operating system of your system is Windows 98, it will automatically install all drivers and utilities for your board.**

See the Auto-Installing under Windows 98 section.

### Installing Support Software

The software on this support CD-ROM is for Windows 95/NT/2000 and Windows 98. The installation procedure differs depending on which Operating System you have, but the automatic installation is now for Win98/WinME/Win2000.

### Installing under Windows 95/NT

To install support software for Windows 95/NT follow this general procedure:

1. Insert the support CD-ROM disc in the CD-ROM drive.  
(The system might get an error message from the PnP function. Don't care the message. You don't really need that file to install the drivers)
2. Use My Computer or Windows Explorer to look at the directory structure. You must use the Open command in the right-button menu. Double-clicking on the drive icon will result in an error message because the disc's AutoRun feature doesn't work in Windows 95/NT.
3. Execute the EXE file name given in the description below.

## 4: Software & Applications

*Note: The correct path name for each software driver is provided, where **D:** identifies the CD-ROM drive letter – modify if necessary.*

### **AGP Driver**

The AGP Drivers allows the system to properly manage the AGP slot on the mainboard. Find the driver here:

- ◆ D:\VGA\AGP\SiS645\

### **Audio Driver**

The Audio driver allows the system to use the onboard audio circuitry. Find the driver and audio application here:

- ◆ D:\SOUND\Driver\SiS645\

### **Network Adapter Driver**

Find the network adapter driver here:

- ◆ D:\LAN\SiS900\

### **AMR Modem Driver**

Find the driver here:

- ◆ D:\Modem\Driver\AMR\SiS645\
- ◆ D:\Modem\SuperVoice\ [Telecom management software]
- ◆ D:\Modem\MediaRingTalk\

### **USB Driver**

The USB Driver allows the system to recognize the USB ports on the mainboard. You need to install this driver if you are running Windows 95. Windows 95 OSR2 does not require this driver.

This driver is available for:

- ◆ Win95 – D:\USB\EUSBSUPP\USBSUPP.EXE
- ◆ Win95 (Chinese) – D:\USB\CUSBSUPP\CUSBSUPP.EXE

### **3Deep Software**

Find the software here:

- ◆ D:\3Deep\3Deep 3.3\Setup.EXE

## Mainboard User's Manual

### BIOS Update Utility

The BIOS Update utility allows you to update the BIOS file on the mainboard to a newer version. You can download the latest version of the BIOS setup available for your mainboard from the website.

- ◆ D:\UTILITY\AMINFxxx.EXE

### PC-Cillin Software

The PC-cillin software program provides anti-virus protection for your system. Find this program here:

- ◆ D:\PC-CILLIN\

### Auto-installing under Windows 98

The support software CD-ROM disc loads automatically under Windows 98. When you insert the CD-ROM disc in the system CD-ROM drive the Autorun feature will automatically bring up the install screen. The screen has three buttons on it, Setup, Browse CD and Exit. See the following screen illustration.

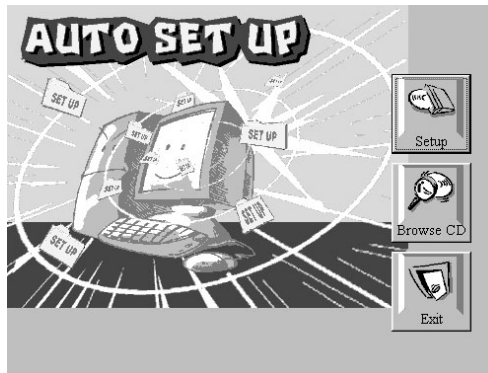

When you click on the **Setup** button the software installation program will run and you can select what kind of installation you want to do, as explained later in this section.

The **Browse CD** button is the standard Windows command that allows you to examine the contents of the disc using the Windows 98 file browsing interface.

The **Exit** button closes the Auto Setup window. To run the program again, reinsert the CD-ROM disc in the drive or click on AutoRun in the context sensitive menu for the CD-ROM drive icon in a file browser window.



## 4: Software & Applications

### Installing Software with Auto Setup

To install support software for the system board follow this procedure:

1. Click on the **Setup** button. The install program will load and display the following screen. Click the **Next** button.



2. Select the items that you want to setup by clicking on it (the default options are recommended). Click the **Next** button to proceed.

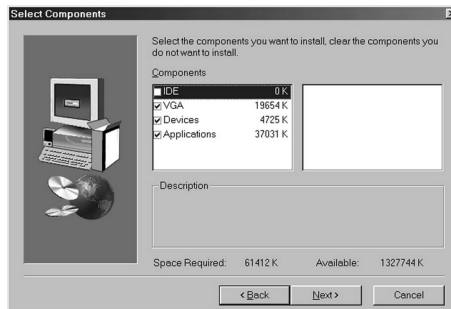

3. The support software will automatically install. Once any of the installation procedures start, software is automatically installed in sequence. You will need to follow the onscreen instructions, confirm commands and allow the computer to restart as few times as is needed to complete installing whatever software you selected to install. When the process is finished, all the support software will be installed and working. There are some utilities that you have to manually install if you need, check to the above section.