

FCC Information and Copyright

This equipment has been tested and found to comply with the limits of a Class B digital device, pursuant to Part 15 of the FCC Rules. These limits are designed to provide reasonable protection against harmful interference in a residential installation. This equipment generates, uses and can radiate radio frequency energy and, if not installed and used in accordance with the instructions, may cause harmful interference to radio communications. There is no guarantee that interference will not occur in a particular installation.

The vendor makes no representations or warranties with respect to the contents here of and specially disclaims any implied warranties of merchantability or fitness for any purpose. Further the vendor reserves the right to revise this publication and to make changes to the contents here of without obligation to notify any party beforehand.

Duplication of this publication, in part or in whole, is not allowed without first obtaining the vendor's approval in writing.

The content of this user's manual is subject to be changed without notice and we will not be responsible for any mistakes found in this user's manual. All the brand and product names are trademarks of their respective companies.

Content

LAYOUT OF M7VIZ	1
COMPONENT INDEX	2
ENGLISH	3
M7VIZ Features	3
Package contents	4
How to set up Jumper	5
CPU Installation	5
DDR DIMM Modules: DDR1, DDR2	6
Installing DDR Module.....	6
Jumpers, Headers, Connectors & Slots.....	7
DEUTSCH.....	14
Spezifikationen von M7VIZ.....	14
Verpackungsinhalt.....	15
Einstellung der Jumper	16
Installation der CPU.....	16
DDR DIMM Modules: DDR1, DDR2	17
Installation von DDR-Modul	17
Jumpers, Headers, Anschlüsse & Steckplätze.....	18
FRANÇAIS.....	25
Caractéristiques de la M7VIZ	25
Contenu du carton.....	26
STUDIOFUN!	27
Introduction.....	27
Hardware Requirements.....	27
Installation Procedure	27
Bootling to StudioFun!	29
Media control	30
Control Panel	31
Software Details.....	33
Select Region	35
Screensaver	36
Display Settings.....	37
File Manager.....	38
WARPSPEEDER	40
Introduction.....	40
System Requirement	40
Installation.....	41
Usage.....	42

Content

TROUBLE SHOOTING50
PROBLEMLÖSUNG51

Layout of M7VIZ

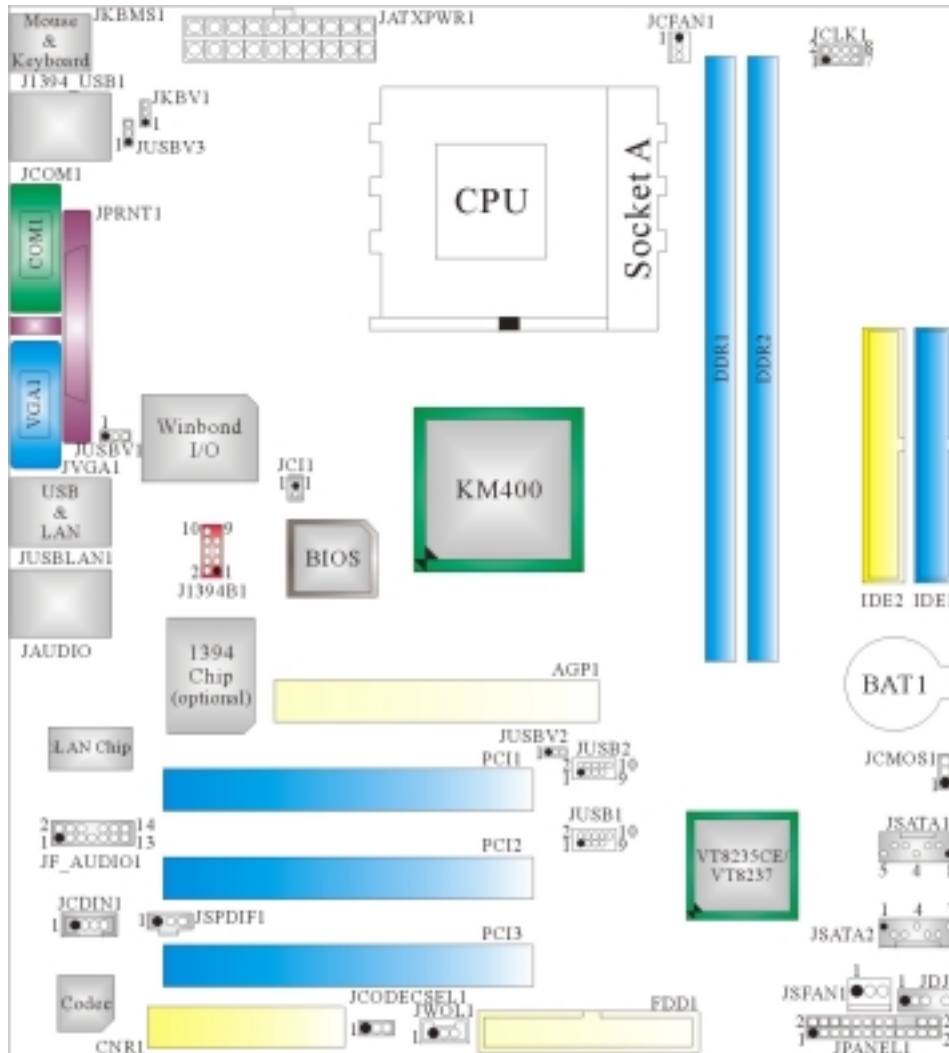

NOTE: ● represents the first pin.

Component Index

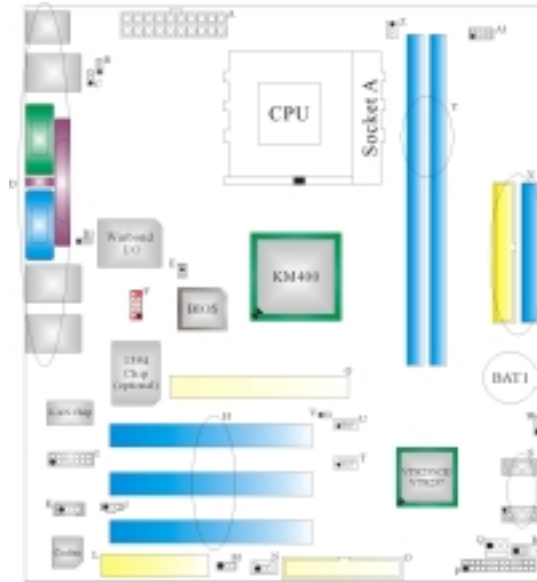

- | | |
|--|--|
| A. ATX Power Connector (JATXPWR1) | N. Wake On LAN Header (JWOL1) |
| B. Power Source Selection for Keyboard and Mouse (JKBV1) | O. Floppy Disk Connector (FDD1) |
| C. Power Source Selection for USB (JUSBV3) | P. Front Panel Connector (JPANEL1) |
| D. Back Panel Connector | Q. System FAN Header (JSFAN1) |
| E. Case Open Connector (JCI1) | R. Audio DJ (JDJ1) |
| F. Front 1394 Header(J1394B1) * | S. Serial ATA Connector (JSATA1-2) © |
| G. Accelerated Graphics Port Slot (AGP1) | T. Front USB Header (JUSB1) © |
| H. PCI BUS Slots (PCI1-3) | U. Front USB Header (JUSB2) |
| I. Front Audio Header (JF_AUDIO1) | V. Power Source Selection for USB (JUSBV2) |
| J. Digital Audio Connector (JSPDIF1) | W. Clear CMOS Function (JCMOS1) |
| K. CD-ROM Audio-In Header (JCDIN1) | X. IDE Connectors (IDE1-2) |
| L. Communication Network Riser Slot (CNR1) | Y. DDR Modules (DDR1-2) |
| M. CNR Codec/ Onboard Selection (JCODECSEL1) | Z. CPU Fan Connector (JCFAN1) |
| | A1 Frequency Selection (JCLK1) |
| | B1 Power Source Selection for USB (JUSBV1) |

* optional

© only support with South Bridge VT8237

English

M7VIZ Features

A. Hardware

CPU

- Provides Socket A.
- Supports single AMD® Athlon/ Duron Family processor.
- Front Side Bus at 200/266/333 MHz.

Chipset

- North Bridge: VIA KM400.
- South Bridge: VIA VT8235CE/ VT8237.(optional)

Main Memory

- Supports up to 2 DDR devices.
- Supports 200/266/333 MHz (without ECC) DDR devices.
- Maximum memory size is 2GB.

Super I/O

- Chip: Winbond W83697HF.

Slots

- Three 32-bit PCI bus master slots.
- One CNR slot. (only Type B)
- One AGP 8X slot.

On Board IDE

- Supports four IDE disk drives.
- Supports PIO Mode 4, Master Mode and Ultra DMA 33/66/100/133 Bus Master Mode.

LAN

- Chip: VIA VT6103.
- Supports 10 Mb/s and 100 Mb/s auto-negotiation
- Half/Full duplex capability.

IEEE 1394 Chip (optional)

- Chip: VIA VT6307.
- Supports 2 IEEE 1394 ports.
- Detects connected device types and automatically configure data speed to 100, 200 or 400 Mbps.

On Board AC'97 Sound Codec

- Chip: CMI9739A.
- Compliant with AC'97 specification.

-
- Supports 6 channels.

On Board Peripherals

a. Rear side

- 1 serial port.
- 1 VGA port.
- 1 parallel port. (SPP/EPP/ECP mode)
- Audio ports in vertical position.
- 1 RJ-45 LAN jack.
- PS/2 mouse and PS/2 keyboard.
- 4 USB2.0 ports.
- 1 1394A Firewire ports. (optional)

b. Front Side

- 1 floppy port supports 2 FDDs with 360K, 720K, 1.2M, 1.44M and 2.88Mbytes.
- 2 USB2.0 ports. (4 USB2.0 ports only support with South Bridge VT8237)
- 1 front audio header.
- 1 S/PDIF header.
- 1 1394A Firewire ports. (optional)

Dimensions

- ATX Form Factor: 22.1 X 24.5cm (W X L)

B. BIOS & Software

BIOS

- Award legal BIOS.
- Supports APM1.2.
- Supports ACPI.
- Supports USB Function.

Software

- Supports Warpspeeder™, 9th Touch™, FLASHER™ and StudioFun!™ (optional).
- Offers the highest performance for Windows 98 SE, Windows 2000, Windows Me, Windows XP, SCO UNIX etc.

Package contents

- HDD Cable X 1
- FDD Cable X 1
- User's Manual X 1
- Fully Setup Driver CD X 1
- StudioFun! Application CD X 1 (optional)
- USB 2.0 Cable X 1 (optional)
- S/PDIF Cable X 1 (optional)
- Rear I/O Panel for Micro ATX Case X 1 (optional)
- IEEE 1394 Cable X 1 (optional)

How to set up Jumper

The illustration shows to how set up jumper. When the Jumper cap is placed on pins, the jumper is "close". If no jumper cap is placed on the pins, the jumper is "open". The illustration shows a 3-pin jumper whose pin1 and 2 are "close" when jumper cap is placed on these 2 pins.



Jumper open



Jumper close

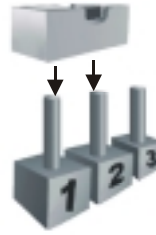

Pin1-2 close

CPU Installation

Step1: Pull the lever sideways away from the socket and then raise the lever up to a 90-degree angle.

Step2: Look for the white dot/cut edge. The white dot/cut edge should point wards the lever pivot. The CPU will fit only in the correct orientation.

Step3: Hold the CPU down firmly, and then close the lever to complete the installation.

Step4: Put the CPU Fan on the CPU and buckle it. Connect the CPU fan power cable to the JCFAN1. This completes the installation.



Step1



Step2



Step3



Step4

CPU Fan Header: JCFAN1

 JCFAN1	Pin	Assignment
	1	Ground
	2	+12V
	3	FAN RPM rate Sense

System Fan Header: JSFAN1

 JSFAN1	Pin	Assignment
	1	Ground
	2	+12V
	3	FAN RPM rate Sense

DDR DIMM Modules: DDR1, DDR2

DRAM Access Time: 2.5V Unbuffered/ Registered DDR 200 MHz (PC1600)/
 DDR 266 MHz (PC2100)/ DDR 333 MHz (PC2700) Type required.

DRAM Type: 64MB/ 128MB/ 256MB/ 512MB/ 1GB DIMM Module (184 pin)

DIMM Socket Location	DDR Module	Total Memory Size (MB)
DDR 1	64MB/128MB/256MB/512MB/1GB *1	Max is 2GB
DDR 2	64MB/128MB/256MB/512MB/1GB *1	

Only for reference

Installing DDR Module

1. Unlock a DIMM slot by pressing the retaining clips outward. Align a DIMM on the slot such that the notch on the DIMM matches the break on the slot.
2. Insert the DIMM vertically and firmly into the slot until the retaining chip snap back in place and the DIMM is properly seated.



Jumpers, Headers, Connectors & Slots

Floppy Disk Connector: FDD1

The motherboard provides a standard floppy disk connector that supports 360K, 720K, 1.2M, 1.44M and 2.88M floppy disk types. This connector supports the provided floppy drive ribbon cables.

Hard Disk Connectors: IDE1/ IDE2

The motherboard has a 32-bit Enhanced PCI IDE Controller that provides PIO Mode 0~5, Bus Master, and Ultra DMA 33/ 66/ 100/ 133 functionality. It has two HDD connectors IDE1 (primary) and IDE2 (secondary).

The IDE connectors can connect a master and a slave drive, so you can connect up to four hard disk drives. The first hard drive should always be connected to IDE1.

Peripheral Component Interconnect Slots: PCI 1-3

This motherboard is equipped with 3 standard PCI slots. PCI stands for Peripheral Component Interconnect, and it is a bus standard for expansion cards. This PCI slot is designated as 32 bits.

Accelerated Graphics Port Slot: AGP1

Your monitor will attach directly to that video card. This motherboard supports video cards for PCI slots, but it is also equipped with an Accelerated Graphics Port (AGP). An AGP card will take advantage of AGP technology for improved video efficiency and performance, especially with 3D graphics.

Communication Network Riser Slot: CNR1

The CNR specification is an open Industry Standard Architecture, and it defines a hardware scalable riser card interface, which supports modem only.

Serial ATA Connector: JSATA1/ JSATA2 (only support with South Bridge VT8237)

The motherboard has a PCI to SATA Controller with 2 channels SATA interface, it satisfies the SATA 1.0 spec and can transfer data with 1.5 Gb/s speed.

Front Panel Connector: JPANEL1

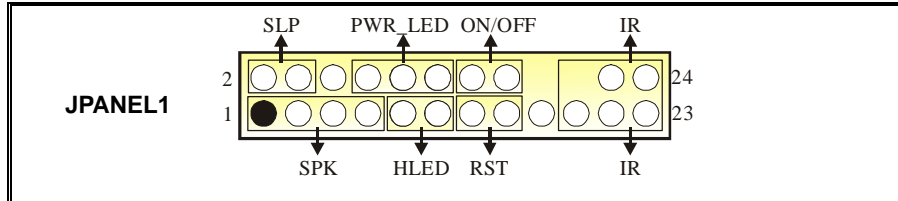

Pin	Assignment	Function	Pin	Assignment	Function
1	+5V	Speaker Connector	2	Sleep Control	Sleep Button
3	NA		4	Ground	
5	NA		6	NA	NA
7	Speaker		8	Power LED (+)	POWER LED
9	HDD LED (+)	Hard Drive LED	10	Power LED (+)	
11	HDD LED (-)		12	Power LED (-)	
13	Ground	Reset Button	14	Power Button	Power-on Button
15	Reset Control		16	Ground	
17	NA		18	KEY	
19	NA	IrDA Connector	20	KEY	IrDA Connector
21	+5V		22	Ground	
23	IRTX		24	IRRX	

Power Connectors: JATXPWR1

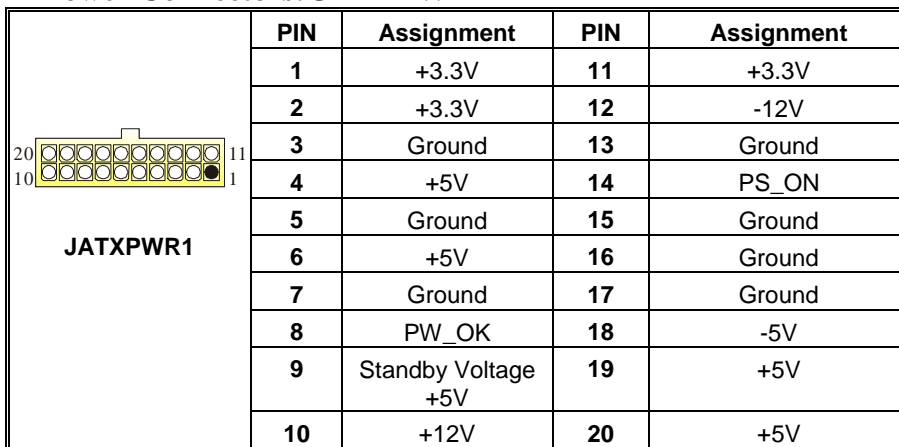

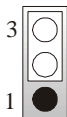

PIN	Assignment	PIN	Assignment
1	+3.3V	11	+3.3V
2	+3.3V	12	-12V
3	Ground	13	Ground
4	+5V	14	PS_ON
5	Ground	15	Ground
6	+5V	16	Ground
7	Ground	17	Ground
8	PW_OK	18	-5V
9	Standby Voltage +5V	19	+5V
10	+12V	20	+5V

Power Source Selection for Keyboard/ Mouse: JKBV1

JKBV1	Assignment	Description
 <p>Pin 1-2 close</p>	+5V	+5V for keyboard and mouse
 <p>Pin 2-3 close</p>	+5V Standby Voltage	PS/2 Mouse and PS/2 Keyboard are powered with +5V standby voltage

Note: In order to support the function “power-on the system via keyboard and mouse function, “JKBV1” jumper cap should be placed on pin 2-3.

Power Source Selection for USB: JUSBV1/ JUSBV2/ JUSBV3

JUSBV1/JUSBV2/ JUSBV3	Assignment	Description
 <p>Pin 1-2 close</p>	+5V	JUSBV3: 5V for USB at the 1394_USB1 port connector JUSBV2: 5V for USB at the JUSB2 port connector JUSBV1: 5V for USB at the JUSBLAN1 port connector
 <p>Pin 2-3 close</p>	+5V Standby Voltage	JUSBV3: J1394_USB1 port is powered with standby voltage of 5V JUSBV2: JUSB2 port is powered with standby voltage of 5V JUSBV1: JUSBLAN1 port is powered with standby voltage of 5V

Note: In order to support the function “power-on the system via USB devices function, “JUSBV1/JUSBV2/ JUSBV3” jumper cap should be placed on pin 2-3 respectively.

Clear CMOS Jumper: JCMOS1

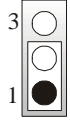
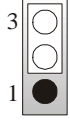
JCMOS1	Assignment
 Pin 1-2 Close	Normal Operation (default)
 Pin 2-3 Close	Clear CMOS Data

※ Clear CMOS Procedures:

1. Remove AC power line.
2. Set the jumper to "Pin 2-3 Close".
3. Wait for five seconds.
4. Set the jumper to "Pin 1-2 Close".
5. Power on the AC.
6. Reset your desired password or clear the CMOS data.

Case Open Connector: JCI1

 JCI1	Pin	Assignment
	1	Case Open Signal
	2	Ground

Serial ATA Connector: JSATA1/ JSATA2 (only support with South Bridge VT8237)

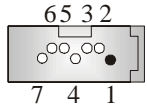
 JSATA1/ JSATA2	Pin	Assignment	Pin	Assignment
	1	Ground	2	TX+
	3	TX-	4	Ground
	5	RX-	6	RX+
	7	Ground		

CD-ROM Audio-In Header: JCDIN1

 JCDIN1	Pin	Assignment
	1	Left Channel Input
	2	Ground
	3	Ground
	4	Right Channel Input

Front Panel Audio Header: JF_AUDIO1

			
Pin	Assignment	Pin	Assignment
1	Mic In/ Center	2	Ground
3	Mic Power/ Bass	4	Audio Power
5	Right Line Out/ Speaker Out Right	6	Right Line Out/ Speaker Out Right
7	Reserved	8	Key
9	Left Line Out/ Speaker Out Left	10	Left Line Out/ Speaker Out Left
11	Right Line In/ Rear Speaker Right	12	Right Line In/ Rear Speaker Right
13	Left Line In/ Rear Speaker Left	14	Left Line In/ Rear Speaker Left

Digital Audio Connector: JSPDIF1

		Pin	Assignment
JSPDIF1		1	+5V
		2	SPDIF_OUT
		3	Ground

Wake On LAN Header: JWOL1

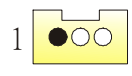
		Pin	Assignment
JWOL1		1	+5V_SB
		2	Ground
		3	Wake up

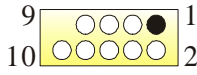

Front USB Header: JUSB2, (JUSB1=>only support with South Bridge VT8237)

			
Pin	Assignment	Pin	Assignment
1	+5V(fused)	2	+5V(fused)
3	USB-	4	USB-
5	USB+	6	USB+
7	Ground	8	Ground
9	KEY	10	NC

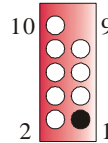
Front 1394 Header: J1394B1

 <p>J1394B1</p>	Pin	Assignment	Pin	Assignment
	1	A+	2	A-
	3	Ground	4	Ground
	5	B+	6	B-
	7	+12V	8	+12V
9	KEY	10	Ground	

CNR Codec/ Onboard Selection: JCODECSEL1

JCODECSEL1	Assignment
 <p>Pin 1-2 Close</p>	Onboard Codec is used (default)
 <p>Pin 2-3 Close</p>	CNR Codec is used

Frequency Selection: JCLK1

Pin	100 MHz	133 MHz	166 MHz
1-2	Open	Open	Open
3-4	Close	Open	Open
5-6	Open	Open	Close
7-8	Open	Open	Open

Audio DJ: JDJ1

 <p>JDJ1</p>	Pin	Assignment	Pin	Assignment
	1	SMBDT	2	SMBCK
	3	-INTR_B	4	NA
	5	PWRGD		

Back Panel Connectors

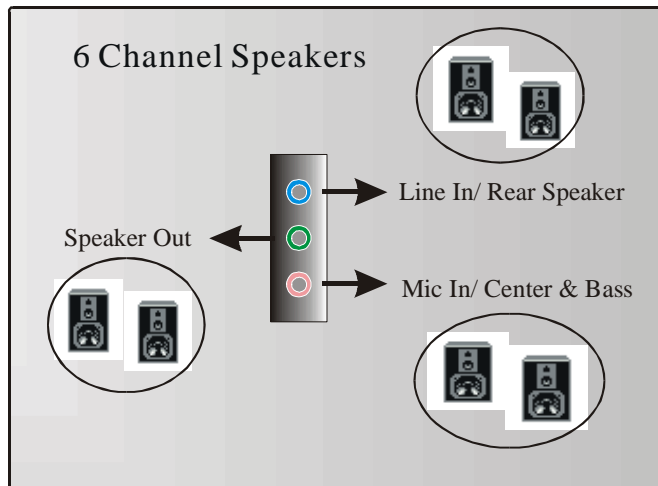
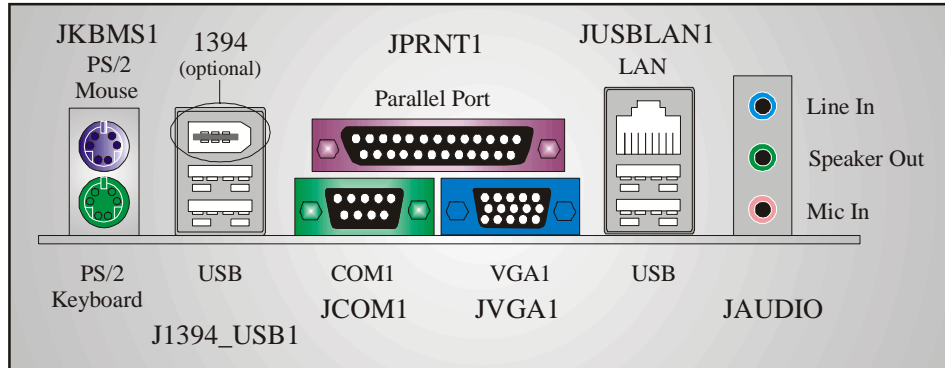

Deutsch

Spezifikationen von M7VIZ

A. Hardware

CPU

- Unterstützung für Sockel A.
- Unterstützung für die AMD® Athlon/ Duron-Familie Prozessor.
- FSB mit 200/266/333 MHz.

Chipsatz

- Northbridge: VIA KM400.
- Southbridge: VIA VT8235CE/ VT8237.(optional)

Hauptspeicher

- Unterstützung für 2 DDR Geräte.
- Unterstützung für 200/266/333 MHz (ohne ECC) DDR Geräte.
- Die maximale Speichergröße ist 2GB.

Super I/O

- Chip: Winbond W83697HF.

Steckplätze

- Drei 32-bit PCI-Bus-Slots.
- Ein CNR-Slot. (nur für Typ B)
- Ein 8X AGP-Slot.

Onboard-IDE

- Unterstützung für vier IDE Diskettenlaufwerke.
- Unterstützung für PIO Modus 4, Bride Modus und Ultra DMA 33/66/100/133 Bus Master Modus.

LAN

- Chip: VIA VT6103.
- Unterstützung für 10 Mb/s und 100 Mb/s Auto-Negotiation
- Halb/Voll-Duplex.

IEEE 1394 Chip (optional)

- Chip: VIA VT6307.
- Unterstützung für 2 IEEE 1394 Ports.
- Ermöglicht die Entdeckung von Typen der verbrauchten Geräte, und die automatische Konfiguration von Datentransferraten zu 100, 200, oder 400 Mbps.

Onboard AC'97 Sound Codec

- Chip: CMI9739A.

-
- Entspricht die Spezifikation von AC'97.
 - Unterstützung für 6-Kanal.

Onboard-Peripheriegeräte

a. Für Rückwand

- 1 serielle Schnittstelle.
- 1 VGA-Schnittstelle.
- 1 parallele Schnittstelle. (SPP/EPP/ECP-Modus)
- Audio-Ports.
- 1 RJ-45 LAN-Buchse (optional)
- Unterstützung für PS/2-Maus und PS/2-Tastatur.
- 4 USB 2.0-Ports.
- 1 1394A-Port. (optional)

b. Für Vorderseite

- 1 Floppy-Port mit Unterstützung für 2 Diskettenlaufwerke.(360KB, 720KB, 1.2MB, 1.44MB und 2.88MB)
- 2 USB2.0-Ports. (4 USB2.0-Ports sind für Southbridge VT8237)
- 1 Front-Audio-Header.
- 1 S/PDIF-Header.
- 1 1394A Firewire ports. (optional)

Abmessungen

- ATX Form-Factor: 22.1 X 24.5cm (W X L)

B. BIOS & Software

BIOS

- Award legal Bios.
- Unterstützung für APM1.2.
- Unterstützung für ACPI.
- Unterstützung für USB Funktion.

Software

- Unterstützung für Warpspeeder™, 9th Touch™, FLASHER™ und StudioFun!™ (optional).
- Unterstützung für die am meisten verbreiteten Betriebssysteme wie Windows 98SE, Windows 2000, Windows ME, Windows XP and SCO UNIX usw.

Verpackungsinhalt

- Kabel für HDD X 1
- Kabel für FDD X 1
- Benutzer Handbuch X 1
- Treiber CD für Installation X 1
- StudioFun! Anwendung CD X 1 (optional)
- USB 2.0 Kable X 1 (optional)
- S/PDIF Kable X 1 (optional)

-
- I/O-Rückwand für ATX Gehäuse X1 (optional)
 - IEEE 1394 Kable X 1 (optional)

Einstellung der Jumper

Die Abbildung verdeutlicht, wie Jumper eingestellt werden. Pins werden durch die Jumper-Kappe verdeckt, ist der Jumper "geschlossen". Keine Pins werden durch die Jumper-Kappe verdeckt, ist der Jumper "geöffnet". Die Abbildung zeigt einen 3-Pin Jumper dessen Pin1 und Pin2 "geschlossen" sind, bzw. es befindet sich eine Jumper-Kappe auf diesen beiden Pins.



Jumper geöffnet



Jumper geschlossen

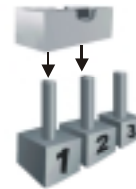

Pin1-2 geschlossen

Installation der CPU

- Schritt 1:** Ziehen Sie den Hebel seitlich vom Sockel weg. Heben Sie den Hebel dann in 90-Grad-Winkel nach oben.
- Schritt 2:** Suchen Sie nach der scharfen Kante, die auf Drehpunkt des Hebels weisen muss. Die CPU passt nur, wenn sie richtig ausgerichtet ist.
- Schritt 3:** Drücken Sie die CPU fest in den Sockel und schließen Sie den Hebel.
- Schritt 4:** Stecken Sie Ihren CPU-Lüfter auf die CPU. Schließen Sie die Stromversorgungsstecker für CPU-Lüfter an JCFAN1 an. Dann beenden Sie die Installation.



Schritt 1



Schritt 2



Schritt 3



Schritt 4

CPU-Lüfter Headers: JCFAN1

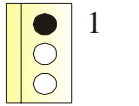
 JCFAN1	Pin	Beschreibung
	1	Masse
	2	+12V
	3	FAN RPM Geschwindigkeit Sensor

System-Lüfter Headers: JSFAN1

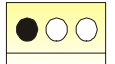
 JSFAN1	Pin	Beschreibung
	1	Masse
	2	+12V
	3	FAN RPM Geschwindigkeit Sensor

DDR DIMM Modules: DDR1, DDR2

DRAM-Zugriffszeit: 2.5V unbuffered DDR/Registered DDR 200 MHz (PC1600)/
DDR 266 MHz (PC2100)/ DDR 333 MHz (PC2700) Typ erforderlich.
DRAM-Typ: 64MB/ 128MB/ 256MB/ 512MB/ 1GB DIMM-Module(184-Pin)

DIMM-Sockel Standort	DDR-Modul	Speichergroße (MB)
DDR 1	64MB/128MB/256MB/512MB/1GB *1	Maximal ist 2GB
DDR 2	64MB/128MB/256MB/512MB/1GB *1	

Nur als Referenz*

Installation von DDR-Modul

1. Öffnen Sie einen DIMM-Slots, indem Sie die seitlich Chips nach außen drücken. Richten Sie das DIMM-Modul so über dem Slot aus, dass das Modul mit der Kerbe in den Slot passt.
2. Drücken Sie das DIMM-Modul in den Slot, bis die seitlichen Clips zuschnappen und das Modul fest sitzt.



Jumpers, Headers, Anschlüsse & Steckplätze

Diskettenanschluss: FDD1

Das Motherboard enthält einen standardmäßigen Diskettenanschluss, der 360K-, 720K-, 1.2M-, 1.44M- und 2.88M-Disketten unterstützt. Dieser Anschluss unterstützt die mitgelieferte Bandkabel des Diskettenlaufwerks.

Festplattenanschlüsse: IDE1 und IDE2

Das Mainboard hat einen 32-bit Enhanced PCI IDE-Controller, der die Modi PIO0~4, Bus Master sowie die Ultra DMA/33/66/100/133- Funktion zur Verfügung stellt. Dieser ist mit zwei HDD-Anschlüssen versehen IDE1 (primär) und IDE2 (sekundär).

Die IDE-Anschlüsse können eine Master- und eine Slave-Festplatte verbinden, so dass bis zu 4 Festplatten angeschlossen werden können. Die erste Festplatte sollte immer an IDE1 angeschlossen werden.

Peripheral Component Interconnect Slots: PCI 1-3

Dieses Motherboard ist mit 3 standardmäßigen PCI-Slots ausgestattet. PCI steht für Peripheral Component Interconnect und bezieht sich auf einem Busstandard für Erweiterungskarten, der den älteren ISA-Busstandard in den meisten Schnittstellen ersetzt hat. Dieser PCI-Slot ist für 32 bits vorgesehen.

Accelerated Graphics Port Slot: AGP1

Ihr Monitor wird direkt an die Grafikkarte angeschlossen. Dieses Motherboard unterstützt Grafikkarten für PCI-Slots, aber es ist auch mit einem Accelerated Graphics Port ausgestattet. AGP-Karten verwenden die AGP-Technologie, um die Wirksamkeit und Leistung von Videosignalen zu verbessern, besonders wenn es sich um 3D-Grafiken handelt.

Communication Network Riser Slot: CNR1

Die CNR-Angaben entsprechen einer offenen Industry Standard Architecture, und sie definieren eine Hardware-skalierbare Riser-Card-Schnittstelle, welche nur Audio, Netzwerk und Modem unterstützt.

Serial ATA Connector: JSATA1/ JSATA2 (nur für Southbridge VT8237)

Auf diesem Motherboard gibt es ein PCI-to-SATA Controller mit 2-Kanal Interface, die der Spezifikation von SATA 1.0 entspricht. (Datenübertragung mit 1.5Gb/s)

Anschlüsse für die Vorderseite: JPANEL1

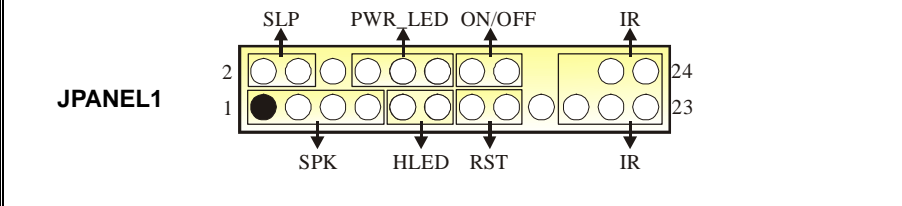

Pin	Belegung	Funktion	Pin	Belegung	Funktion
1	+5V	Lautsprecher-Anschluss	2	Schlaf- Kontroll	Schlaf-Knopf
3	Kein		4	Masse	
5	Kein		6	Kein	POWER LED
7	Lautsprecher		8	Power LED (+)	
9	HDD LED (+)	10	Power LED (+)		
11	HDD LED (-)	Festplatte LED	12	Power LED (-)	
13	Masse	Rückstell-knopf	14	Power-Knopf	Power-On Knopf
15	Reset-Kontroll		16	Masse	
17	Kein		18	Schlüsse	
19	Kein	IrDA-Anschluss	20	Schlüsse	IrDA Anschluss
21	+5V		22	Masse	
23	IRTX		24	IRRX	

Stromversorgungsanschluss: JATXPWR1



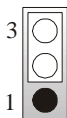

PIN	Beschreibung	PIN	Beschreibung
1	+3.3V	11	+3.3V
2	+3.3V	12	-12V
3	Masse	13	Masse
4	+5V	14	PS_ON
5	Masse	15	Masse
6	+5V	16	Masse
7	Masse	17	Masse
8	PW_OK	18	-5V
9	5V reservierte Spannung	19	+5V
10	+12V	20	+5V

Auswahl von Stromsmodi für Tastatur/ Maus: JKBV1

JKBV1	Pin-Belegung	Beschreibung
 Pin 1-2 geschlossen	+5V	+5V für Tastatur und Maus
 Pin 2-3 geschlossen	+5V reservierte Spannung	Durch +5V reservierte Spannung für PS/2-Maus und PS/2-Tastatur zum Erwecken vom System

⚠ Anmerkung: Um die Funktion —“Erwecken durch Tastatur/Maus“ — zu aktivieren, müssen Pins 2-3 von JKBV1 durch die Jumperkappe verdeckt werden.

Auswahl von Stromsmodi für USB: JUSBV1/ JUSBV2/ JUSBV3

JUSBV1/JUSBV2	Pin-Belegung	Beschreibung
 Pin 1-2 geschlossen	+5V	JUSBV3: 5V für USB-Port von J1394_USB1 JUSBV2: 5V für USB-Port von JUSB2 JUSBV1: 5V für USB-Port von JUSBLAN1
 Pin 2-3 geschlossen	+5V reservierte Spannung	JUSBV3: 5V reservierte Spannung für J1394_USB1 zum Erwecken JUSBV2: 5V reservierte Spannung für JUSB2 zum Erwecken JUSBV1: 5V reservierte Spannung für JUSBLAN1 zum Erwecken

⚠ Anmerkung: Um die Funktion —“Erwecken durch USB-Geräte“ — zu aktivieren, müssen Pins 2-3 von JUSBV1/JUSBV2/ JUSBV3 durch die Jumperkappe verdeckt werden.

Jumper zum Löschen des CMOS: JCMOS1

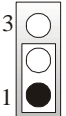
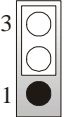
JCMOS1	Beschreibung
 <p>Pin 1-2 geschlossen</p>	Normale Operation (Default)
 <p>Pin 2-3 geschlossen</p>	CMOS-Daten Löschen

※ Prozeduren zum Löschen des CMOS:

1. Ausschalten Sie das System.
2. Lassen Sie Pin 2-3 von JCOMS1 geschlossen sein.
3. Bitte warten Sie 15 Sekunden.
4. Lassen Sie Pin 1-2 von JCOMS1 geschlossen sein.
5. Einschalten Sie das System wieder.
6. Zurücksetzen Sie ihr gewünschtes Kennwort oder löschen Sie die CMOS-Daten.

Warnmeldung für Chassis-Öffnen Anschluss: JCI1

 <p>JCI1</p>	Pin	Belegung
	1	Warnmeldung für Chassis-Öffnen
	2	Masse

Serial ATA Anschlüsse: JSATA1/ JSATA2 (nur für Southbridge VT8237)

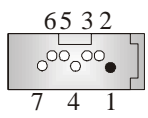
 <p>JSATA1/ JSATA2</p>	Pin	Belegung	Pin	Belegung
	1	Masse	2	TX+
	3	TX-	4	Masse
	5	RX-	6	RX+
	7	Masse		

CD-ROM Audio-In Header: JCDIN1

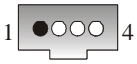
 <p>JCDIN1</p>	Pin	Belegung
	1	Eingabe von linken Kanal
	2	Masse
	3	Masse
	4	Eingabe von rechten Kanal

Digital Audio Anschluss: JSPDIF1

 <p>JSPDIF1</p>	Pin	Belegung
	1	+5V
	2	SPDIF_Ausgang
	3	Masse

Audio Header für Vorderseite: JF_AUDIO1

 <p>JF_AUDIO1</p>			
Pin	Belegung	Pin	Belegung
1	Mikrofon-Eingang	2	Masse
3	Mikrofon-Betriebsspannung	4	Audio-Betriebsspannung
5	Audio-Signal des rechten Kanals zur Vorderseite	6	Audio-Signal des rechten Kanals zur Vorderseite
7	Reserviert für spät. Verwendung durch Kopfhörer-Verstärker	8	Kein Pin
9	Audio-Signal des linken Kanals zur Vorderseite	10	Audio-Signal des linken Kanals zur Vorderseite
11	Audio-Signal des rechten Kanals von der Vorderseite	12	Audio-Signal des rechten Kanals von der Vorderseite
13	Audio-Signal des linken Kanals von der Vorderseite	14	Audio-Signal des linken Kanals von der Vorderseite

Wake On LAN Header: JWOL1

 <p>JWOL1</p>	Pin	Belegung
	1	+5V_SB
	2	Masse
	3	Aufwecken

Front USB Header: JUSB2/ (JUSB1=>nur für Southbridge VT8237

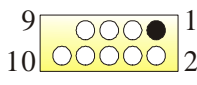
 <p>JUSB1/2</p>	Pin	Belegung	Pin	Belegung
	1	+5V(geschmolzt)	2	+5V(geschmolzt)
	3	USB-	4	USB-
	5	USB+	6	USB+
	7	Masse	8	Masse
	9	Kein Pin	10	Kein

Front 1394 Header: J1394B1

 <p>J1394B1</p>	Pin	Belegung	Pin	Belegung
	1	A+	2	A-
	3	Masse	4	Masse
	5	B+	6	B-
	7	+12V	8	+12V
	9	Kein Pin	10	Masse

Auswahl Onboard/CNR-Codec: JCODECSEL1

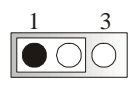
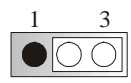
JCMOS1	Beschreibung
 <p>Pin 1-2 geschlossen</p>	Verwendung von Onboard-Codec (Default)
 <p>Pin 2-3 geschlossen</p>	Verwendung von CNR-Codec

Frequenz Auswahl: JCLK1

Pin	100 MHz	133 MHz	166 MHz
1-2	öffnen	öffnen	öffnen
3-4	schließen	öffnen	öffnen
5-6	öffnen	öffnen	schließen
7-8	öffnen	öffnen	öffnen

Audio DJ: JDJ1

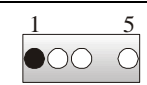
 <p>JDJ1</p>	Pin	Belegung	Pin	Belegung
	1	SMBDT	2	SMBCK
	3	-INTR_B	4	Kein Pin
	5	PWRGD		

Anschlüsse für die Rückwand

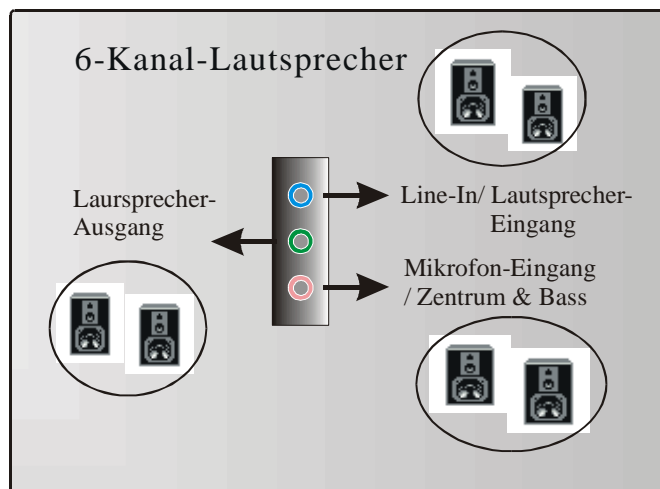
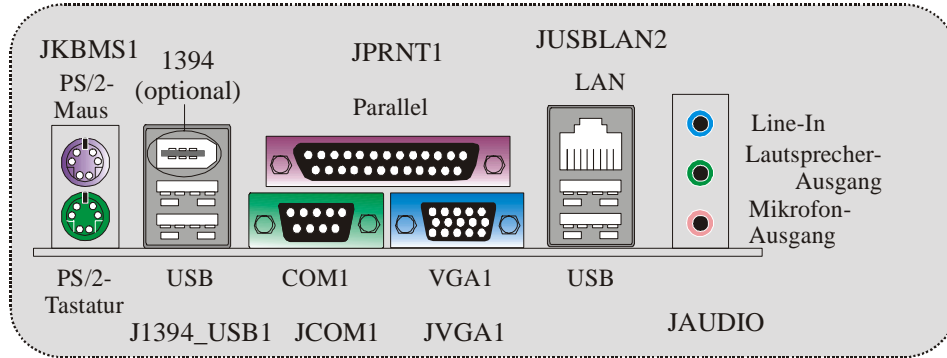

Français

Caractéristiques de la M7VIZ

A. Matériel

Processeur

- Fournit un support Socket A.
- Prend en charge un unique processeur AMD® de la famille Athlon/ Duron.
- Bus face avant à 200/266/333 MHz.

Chipset

- Pont nord : VIA KM400.
- Pont sud : VIA VT8235CE/ VT8237.(option)

Mémoire principale

- Prend en charge 2 barrettes DDR.
- Prend en charge la mémoire DDR (sans ECC) à 200/266/333 MHz.
- Taille maximale de mémoire : 2 Go.

Super E/S

- Puce : Winbond W83697HF.

Expansion

- Trois emplacements PCI 32 bits bus maître.
- Un emplacement CNR. (Type B uniquement)
- Un emplacement AGP 8X.

IDE intégré

- Prend en charge quatre lecteurs de disques IDE.
- Prend en charge les modes PIO 4, Maître et bus maître Ultra DMA 33/66/100/133.

Réseau

- Puce : VIA VT6103.
- Prend en charge la négociation automatique 10 Mb/s et 100 Mb/s
- Capacité semi duplex/duplex complet.

Puce IEEE 1394 (option)

- Puce : VIA VT6307.
- Prend en charge 2 ports IEEE 1394.
- Détecte les périphériques connectés et configure automatique la vitesse de transfert des données à 100, 200 ou 400 Mb/s.

Codec son AC'97 intégré

- Puce : CMI9739A.
- Conforme à la spécification AC'97.
- Prend en charge 6 canaux.

Périphériques intégrés

a. Face arrière

- 1 port série.
- 1 port VGA.
- 1 port parallèle. (mode SPP/EPP/ECP)
- Ports audio en position verticale.
- 1 prise réseau RJ-45.
- Souris et clavier PS/2.
- 4 ports USB2.0.
- 1 port 1394A Firewire. (option)

b. Face avant

- 1 port pour lecteur de disquettes prend en charge deux lecteurs de disquettes avec 360K, 720K, 1,2M, 1,44M et 2,88 Mo.
- 2 ports USB2.0. (4 ports USB2.0 uniquement avec le pont sud VT8237)
- 1 connecteur audio avant.
- 1 connecteur S/PDIF.
- 1 port 1394A Firewire. (option)

Dimensions

- Facteur de forme ATX: 22,1 X 24,5cm (l X L)

B. BIOS et logiciel

BIOS

- BIOS Award.
- Prend en charge APM1.2.
- Prend en charge ACPI.
- Prend en charge la fonction USB.

Logiciel

- Prend en charge Warpspeeder™, 9th Touch™, FLASHER™ et StudioFun!™ (option).
- Offre la meilleure performance sous Windows 98 SE, Windows 2000, Windows Me, Windows XP, SCO UNIX etc.

Contenu du carton

- Câble pour disque dur X1
- Câble pour lecteur de disquette X1
- Manuel de l'utilisateur X1
- CD complet d'installation des pilotes X 1
- CD d'application StudioFun! X 1 (option)
- Câble USB 2.0 X1 (option)
- Câble S/PDIF X 1(option)
- Panneau d'E/S arrière pour châssis ATX X 1 (option)
- Câble IEEE 1394 X 1 (option)

StudioFun!

Introduction

StudioFun! is a media-player based on optimized GNU/Linux distribution. It plays DVD, VCD, MP3, Audio CD and various other known file formats. You can take snapshots of video and customize the saved images as screensavers. You can also store the images on USB mass storage devices like flash disks and USB floppy disks.

Hardware Requirements

The supported hardware list of StudioFun! grows up every day. So please check the hwreq.txt located in the root of StudioFun! Installation CD to get the most updated information.

Installation Procedure

Insert the StudioFun! Installation CD in a CD/DVD ROM drive and let the system boot through the CD. The disk will boot and bring up the grub boot loader installation menu. Two options are specified.

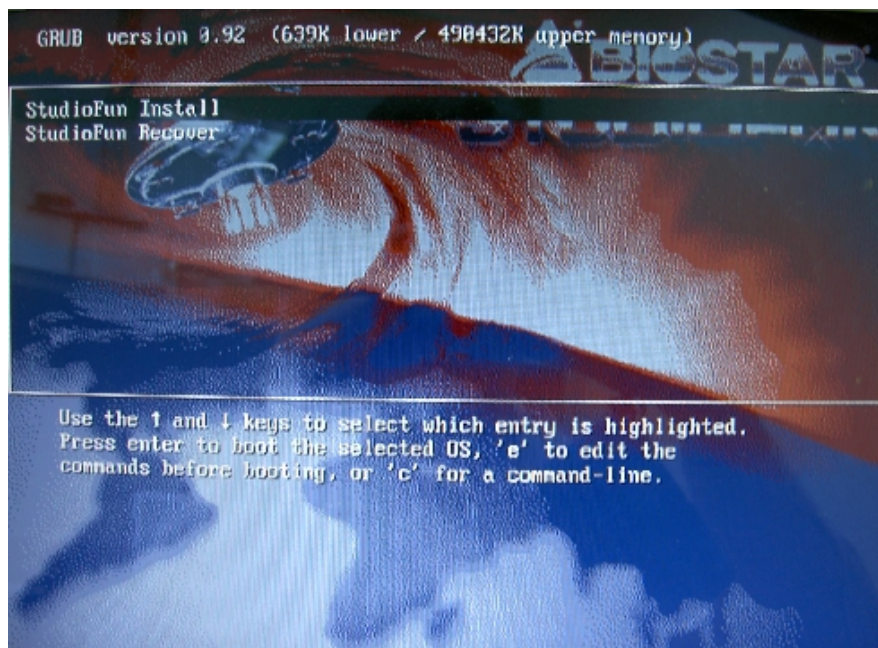

Installation

This option will do the basic installation of the distribution. The installation works on pre-installed windows or GNU/Linux distribution.

On selecting the 'installation' option the installer boots and displays a dialog box indicating the space required and waits for a confirmation. Selecting Ok will continue the installation while selecting Cancel will terminate the installation and reboot the machine.

If Windows or GNU/Linux is the only OS installed on the hard disk with no free space, it will resize the partition, either NTFS or FAT32 or ext2, and install StudioFun!. In case the hard disk has a 128MB of free space available, the installation will use the free space.

After installing the base system you will be prompted to select the resolution from the following choices

1. 1024x768 (recommended)
2. 800x600
3. 640x480

Select the desired resolution. The default is 1024x768 for high-end graphics.

Next you will be prompted to choose the DVD area/region selection code. Choose this based on the type of DVDs you will be playing.

The installation procedure will then probe for the type of mouse installed. The distribution currently supports PS/2, USB and Serial mice. In case of serial mouse you will have to move the mouse when prompted. The other two are probed and installed automatically.

The installation procedure will now finish, the CD is ejected and a dialog box prompting to reboot the machine is displayed. Press OK button and enjoy StudioFun!.

3.1.1 Error Messages

1. Media corrupted!! Please check the media! The CD-ROM is corrupted.
2. Extraction of base system failed!! Please try again later!! The CD-ROM is corrupted.
3. Unsupported hardware found, Aborting... If you try to install StudioFun! on an unsupported and undocumented hardware the above error message is popped.
4. No device found! This error message is given if there is no hard disk in the system.

Recovery

In case of a MBR corruption, this option should be used. It will automatically probe the hard disk master boot record and find out the installed operating system(s). On success it will re-install the boot loader with correct options in the MBR. Any custom boot loader option specified from other GNU/Linux installations will get over written by the newly probed one.

Booting to StudioFun!

After Installation is over, remove the CD from the CD-ROM and restart the machine. After the machine reboots, you will get the GRUB boot loader menu screen. Select the StudioFun option to boot to the StudioFun! partition.



After complete boot up, you get to the main Desktop screen. The following section is a complete description of the Desktop application.

Desktop



This is the main shell of the StudioFun software. It basically comprises of two categories, one is the main "media control" part and the other is the "control panel".

Media control

The media control part of the Desktop has the following controls:

1. VCD

This control will glow whenever a VCD is detected in a DVD/CD-ROM drive. The VCD will be auto-played only when it is put in to the drive when the Desktop (StudioFun! shell) is up and running, otherwise, the control will simply glow to inform the user about a VCD

present in the DVD/CD-ROM drive.

2. DVD

This control will glow whenever a DVD is detected in a DVD drive. The DVD will be auto-played only when it is put in to the drive when the Desktop (StudioFun! shell) is up and running, otherwise, the control will simply glow to inform the user about a DVD present in the DVD/CD-ROM.

3. MP3

This control will glow whenever a MP3 is detected in a DVD/CD-ROM drive. The MP3 will be auto-played only when it is put in to the drive when the Desktop (StudioFun! shell) is up and running, otherwise, the control will simply glow to inform the user about a MP3 present in the DVD/CD-ROM drive.

4. AUDIO

This control will glow whenever a AUDIO is detected in a DVD/CD-ROM drive. The AUDIO will be auto-played only when it is put in to the drive when the Desktop (StudioFun! shell) is up and running, otherwise, the control will simply glow to inform the user about a AUDIO present in the DVD/CD-ROM drive.

5. FILE

This control will glow whenever a File CD (CDs with other media type files) is detected in a DVD/CD-ROM drive. The File CD will be auto-played only when it is put in to the drive when the Desktop (StudioFun! shell) is up and running, otherwise, the control will simply glow to inform the user about a File CD present in the DVD/CD-ROM drive.

6. EJECT MEDIA

This control when clicked will eject any MP3 or File CDs from any of the DVD/CDROM drives. In case there were no MP3 or File CDs it will eject the default medium, (i.e.), the CD-ROM drive in case if the user has both DVD/CD-ROM drive or else it will eject the default DVD/CD-ROM drive.

7. EXIT

This is the "Power on/off" control of the Desktop (StudioFun! shell).

Control Panel

Control panel part has five icons, which are shortcuts to other applications present in the StudioFun software. Tool tips are provided on the icons when the mouse is rolled over them.

1. Select Region

Clicking this icon will invoke the application for selection DVD region settings. Refer to section 5.2 Select DVD Region application for more details.

2. Screensaver

Clicking this icon will invoke the screensaver application. Refer to section 5.3 **Screensaver** for more details.

3. Display Settings

Clicking this icon will invoke the application for changing the screen resolutions. Refer to section 5.4, **Display Settings** for more details.

4. File Manager

Clicking this icon will invoke the file manager. Refer to section 5.6 **File manager** for more details.

When user has a DVD and a CD-ROM Drive:

If user has both DVD and a CD-ROM drive, DVD drive will be given the preference when both the drives hold valid media in them, i.e., if the CD-ROM drive has a media and a DVD drive also has a media, and the StudioFun! is started, then the media inside the DVD drive will be played.

If in case the media in CD-ROM takes a longer time to get recognized than the media inside the DVD drive, the media in the CD-ROM will be played, once if it is recognized.

Other general user scenarios

When a user clicks on any of the media-controls when it is not glowing, except eject media and exit, the media-player will just come up and wait for user input.

NO DUPLICATE INSTANCE OF ANY APPLICATION WILL BE ALLOWED TO RUN.

Software Details

XINE



XINE is a multimedia player. It plays back Audio CD, DVD, and VCD. It also decodes multimedia files like AVI, MOV, WMV, and MP3 from local disk drives. It interprets many of the most common multimedia formats available - and some of the uncommon formats, too.

• Features of Xine

- a. Skinnable GUI
- b. Navigation controls (seeking, pause, fast, slow, next chapter, etc)
- c. On Screen Display (OSD) features
- d. DVD and external subtitles
- e. DVD/VCD menus (requires external plugin)
- f. Audio and subtitle channel selection
- g. Closed Caption support
- h. Brightness, contrast, audio volume, hue, saturation adjusting requires hardware/driver support)
- i. Playlists
- j. Image snapshot
- k. Audio resampling
- l. Software de-interlacing algorithms
- m. Configuration dialog
- n. Aspect ratio changing
- o. Fullscreen display

• Supported File formats

- a. Video CD
- b. MPEG program streams (.mpg, .mpeg)
- c. ogg (.ogg) avi (.avi)
- d. asf (.asf, .wmv)
- e. QuickTime (.mov)
- f. MPEG-Video (.mpv, .m2v)

-
-
- g. MPEG-Audio (.mp2, .mp3)
 - h. WAV (.wav) Video Codecs
 - i. MPEG 1/2
 - j. MPEG 4 (aka OpenDivX)
 - k. MS MPEG 4
 - a. Chapter 5: Software Details 10
 - l. Windows Media Video 7
 - m. Motion JPEG

- **Remote Control support.**

- a. Infrared interface
- b. User-friendly

- **Usage of StudioFun! with CelomaChrome skin**

- a. Select VCD button to play a VCD disc
- b. Select DVD button to play a DVD disc
- c. Select CDDA button to play a Audio cd
- d. Select next chapter or MRL (>>|) button to play next track in Audio CD, VCD and MP3 songs and to play next chapter in DVD
- e. Select previous chapter or MRL (|<<) button to play previous track in Audio CD, VCD and MP3 songs and to play previous chapter in DVD
- f. Select slow motion (<<) button to play the video / audio in slow motion (Select play button after reaching the required position)
- g. Select fast motion (>>) button to play the video / audio in fast motion (Select play button after reaching the required position)
- h. Select subs + / - button to select the appropriate subtitle (Usable while playing)
- i. Select audio + / - button to select the appropriate audio track (For example when
- j. The DVD contains one audio track in English and the other with some other language,
- k. Usable while playing DVD's)
- l. j. Select hide button to hide the control panel of the player

-
-
- m. k. Select menu button to use menu's while playing DVD
 - n. l. Select control button to adjust brightness / color
 - o. Select setup button to modify the settings of the player
 - p. Select f.scr button to show the video output of the player in full screen mode
 - q. Select snap button to take a snapshot of the currently playing video
 - r. Select plist button to add / remove / manage playlist
 - s. Select mrl button to add new file to play

Error Messages

- ✧ The following error message is given if an unknown file format is selected through Xine MRL browser and played.
- ✧ While playing mp3 files, if the user stops playing and tries to select the DVD button, then the following error message is shown

Select Region

Overview

Select region is a utility to set a DVD region. With the help of this application user can set or change a DVD region. Only one region can be set at a time.

About Select Region

With the help of this application you can set a region for DVD. Only one region can be set at a time. If you keep the mouse pointer on any region, you can view the countries, which comes under that region.

Ok - Click to set the selected region.

Cancel - Click to quit the application.

How to select DVD region

You can select only one region at a time. You can change your selection by clicking on any other region.

- A snapshot of the application is shown below:

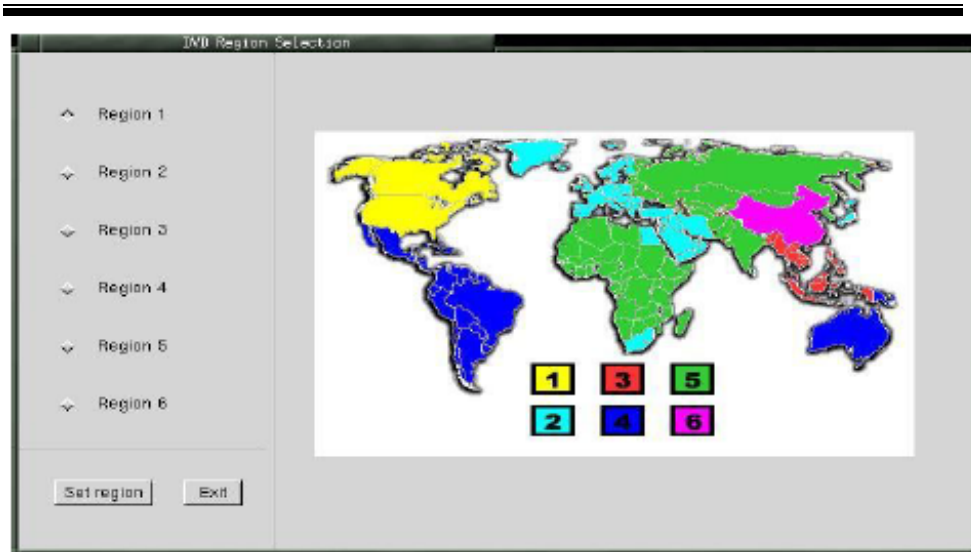

Screensaver

Screensaver

The xscreensaver daemon waits until the keyboard and mouse have been idle for a period, and then runs a graphics demo chosen at random. The demo is terminated as soon as there is any mouse or keyboard activity.

The xscreensaver-demo program is the graphical user interface to xscreensaver. It lets you tune the various parameters used by the xscreensaver daemon, and browse through the graphics demos.

StudioFun! comes with xscreensaver when you click on the screensaver icon the application comes up. Then user can choose various graphics demos like chbg,halo,hypercube or hyperball.

Screensaver comes with various options

- **Preview Option:** When a user selects a particular graphics demo and clicks on preview button the demo comes up.
- **Blank After Option:** The screensaver will blank the screen after the keyboard and mouse have been idle default time is 1minute and user can change the settings.
- **Cycle After Option:** When screensaver is running this cycle time defines the time limit for each screensaver.
- **Mode Screensaver comes with various modes:**
 1. **Random Screen Saver:** When user chooses this option, Screensaver cycles through various graphics demos randomly

-
2. Only one Screen Saver: When user chooses this option, screensaver displays only one graphics demo.
 3. Blank Screen Only: When user chooses this option, screensaver only blanks the screen instead of displaying the graphics demo.
 4. Disable Screen Saver: When user chooses this option, screensaver is disabled.

- Various Graphics Demos

XScreensaver comes with various screensaver

Chbg: This screensaver displays the images stored in StudioFun! the time gap between images is 5 seconds.

Hyperball

Hypercube

Halo

Strange

- A snapshot of the application is shown below:

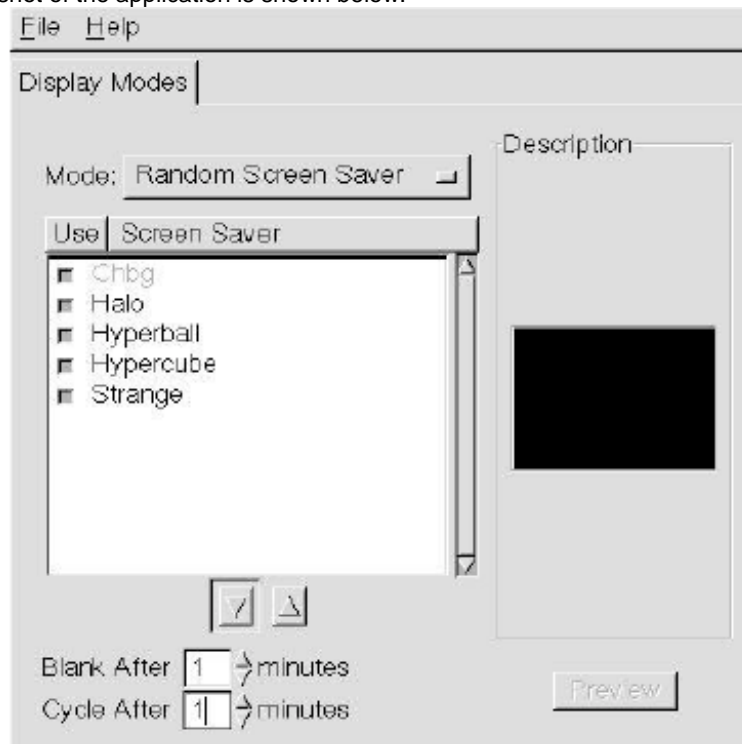

Display Settings

Display Settings

Display setting is a program to change the current resolution settings of the Display.

By default user of StudioFun will be given a choice to select between any of the following

three resolutions.

- 640x480
- 800x600
- 1024x768

The current resolution of the Display will be selected by default. It requires restart of the StudioFun to reflect the changes made.

File Manager

Overview

File manger is an utility to copy files from deferent devices to hard disk and vice versa. User can copy files from devices such as, floppy, cdrom and flashdisk to hard disk. And also from hard disk to floppy and flashdisk.

About File manager

The hard disk files are stored in a directory called “/studiofun” on the hard disk. You can also delete files from hard disk, but you cannot delete files from any device.

- ✧ Select device - Contains the device names /floppy, /cdrom and /flashdisk. Select a device from/to which you want to copy files. **Please double click the device option twice to mount the device.**
- ✧ List Directories - Shows the list of directories of the selected device after double clicking it.
- ✧ Floppy/cdrom/Flashdisk - Shows the contents of the selected directory from the “List directories” field after double clicking it.
- ✧ Hard disk - Shows the contents of a directory called “/studiofun”.
- ✧ Add (>>) - Click to copy selected files from a device to hard disk.
- ✧ Add (<<) - Click to copy selected files from hard disk to a device.
- ✧ Remove - Click to delete files from hard disk.
- ✧ Exit - Click to quit the application.

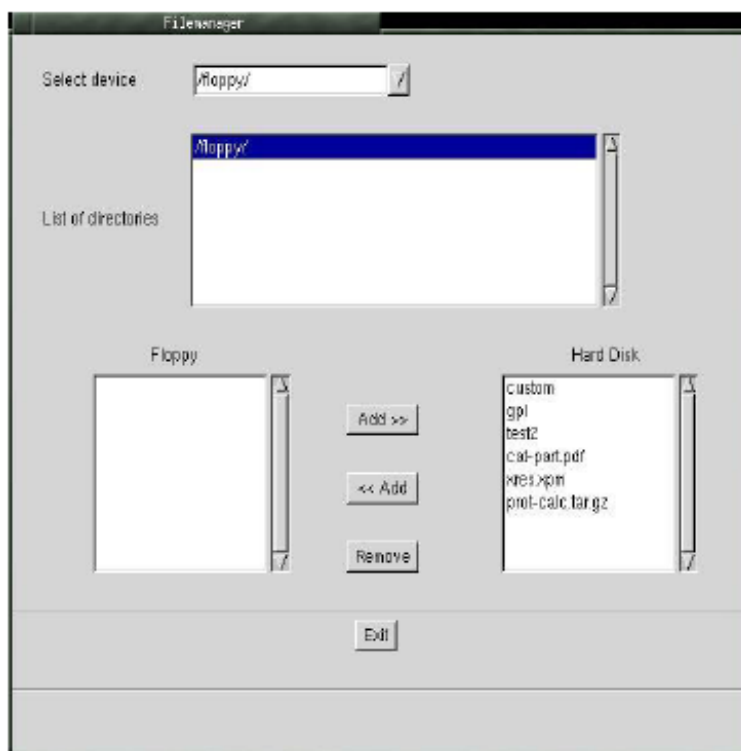

WarpSpeeder



Introduction

[WarpSpeeder™], a new powerful control utility, features three user-friendly functions including Overclock Manager, Overvoltage Manager, and Hardware Monitor.

With the Overclock Manager, users can easily adjust the frequency they prefer or they can get the best CPU performance with just one click. The Overvoltage Manager, on the other hand, helps to power up CPU core voltage and Memory voltage. The cool Hardware Monitor smartly indicates the temperatures, voltage and CPU fan speed as well as the chipset information. Also, in the About panel, you can get detail descriptions about BIOS model and chipsets. In addition, the frequency status of CPU, memory, AGP and PCI along with the CPU speed are synchronically shown on our main panel.

Moreover, to protect users' computer systems if the setting is not appropriate when testing and results in system fail or hang, [WarpSpeeder™] technology assures the system stability by automatically rebooting the computer and then restart to a speed that is either the original system speed or a suitable one.

System Requirement

OS Support: Windows 98 SE, Windows Me, Windows 2000, Windows XP

DirectX: DirectX 8.1 or above. (The Windows XP operating system includes DirectX 8.1. If you use Windows XP, you do not need to install DirectX 8.1.)

Installation

1. Execute the setup execution file, and then the following dialog will pop up. Please click “Next” button and follow the default procedure to install.

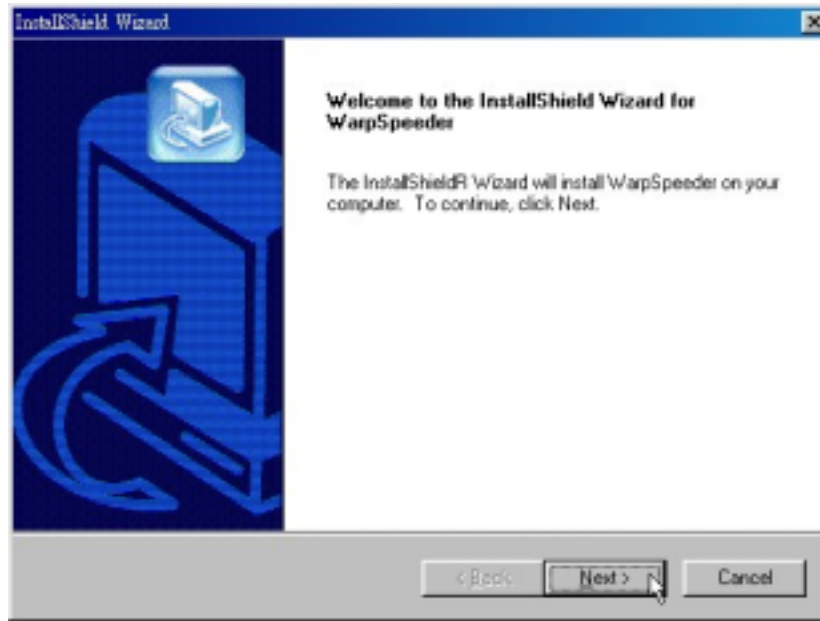

2. When you see the following dialog in setup procedure, it means setup is completed. If the “Launch the WarpSpeeder Tray Utility” checkbox is checked, the Tray Icon utility and [WarpSpeeder™] utility will be automatically and immediately launched after you click “Finish” button.

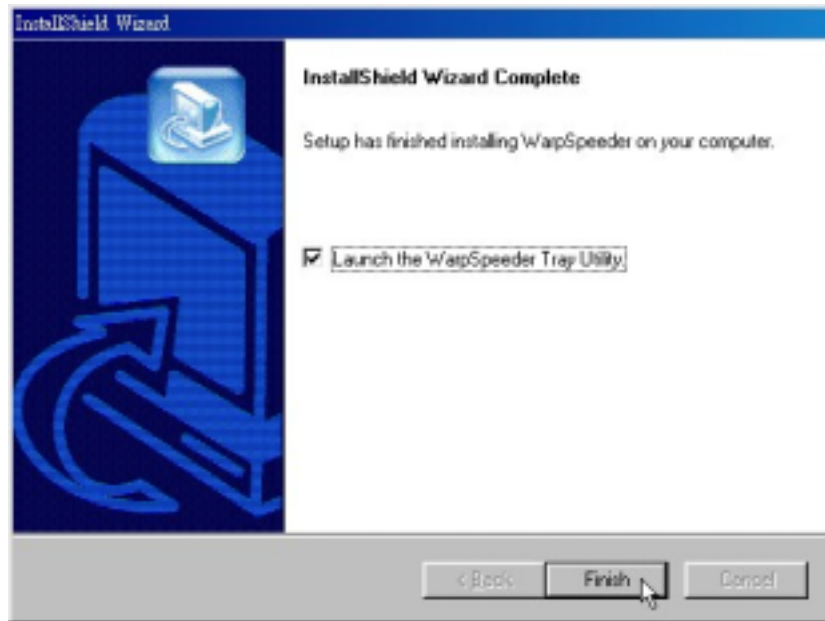

Usage

The following figures are just only for reference, the screen printed in this user manual will change according to your motherboard on hand.

[WarpSpeeder™] includes 1 tray icon and 5 panels:

1. Tray Icon:

Whenever the Tray Icon utility is launched, it will display a little tray icon on the right side of Windows Taskbar.



This utility is responsible for conveniently invoking [WarpSpeeder™] Utility. You can use the mouse by clicking the left button in order to invoke [WarpSpeeder™] directly from the little tray icon or you can right-click the little tray icon to pop up a popup menu as following figure. The “Launch Utility” item in the popup menu has the same function as mouse left-click on tray icon and “Exit” item will close Tray Icon utility if selected.

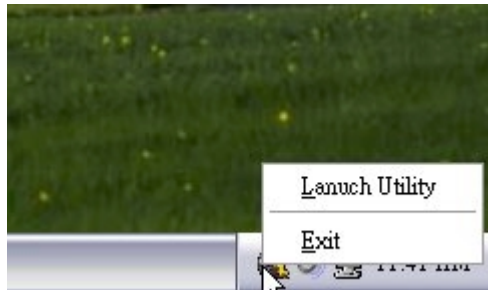

2. Main Panel

If you click the tray icon, [WarpSpeeder™] utility will be invoked. Please refer to the following figure; the utility's first window you will see is Main Panel.

Main Panel contains features as follows:

- a. Display the CPU Speed, CPU external clock, Memory clock, AGP clock, and PCI clock information.
- b. Contains About, Voltage, Overclock, and Hardware Monitor Buttons for invoking respective panels.
- c. With a user-friendly Status Animation, it can represent 3 overclock percentage stages:

Man walking => overclock percentage from 100% ~ 110 %

Panther running => overclock percentage from 110% ~ 120%

Car racing => overclock percentage from 120% ~ above

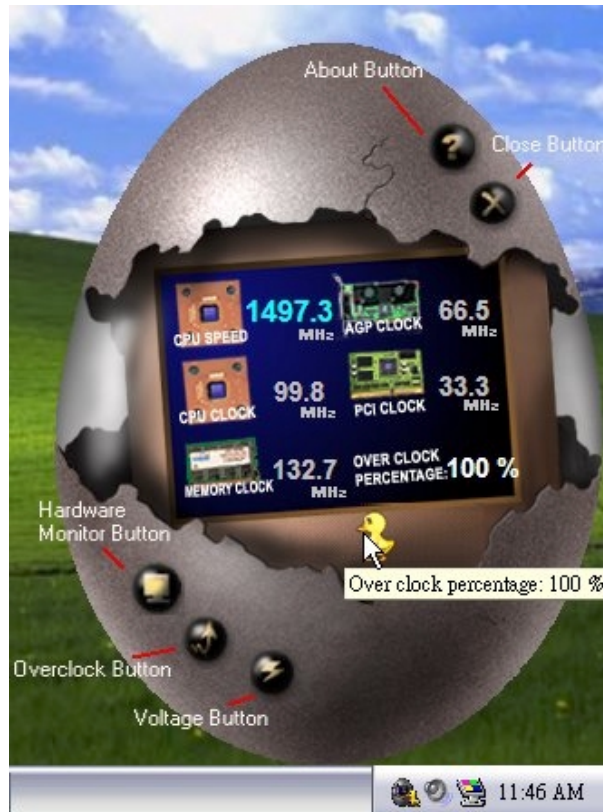

3. Voltage Panel

Click the Voltage button in Main Panel, the button will be highlighted and the Voltage Panel will slide out to up as the following figure.

In this panel, you can decide to increase CPU core voltage and Memory voltage or not. The default setting is "No". If you want to get the best performance of overclocking, we recommend you click the option "Yes".



4. Overclock Panel

Click the Overclock button in Main Panel, the button will be highlighted and the Overclock Panel will slide out to left as the following figure.



Overclock Panel contains the these features:

- a. “-3MHz button”, “-1MHz button”, “+1MHz button”, and “+3MHz button”: provide user the ability to do real-time overclock adjustment.

Warning: Manually overclock is potentially dangerous, especially when the overclocking percentage is over 110 %. We strongly recommend you verify every speed you overclock by click the Verify button. Or, you can just click Auto overclock button and let [WarpSpeeder™] automatically gets the best result for you.

- b. “Recovery Dialog button”: Pop up the following dialog. Let user select a restoring way if system need to do a fail-safe reboot.

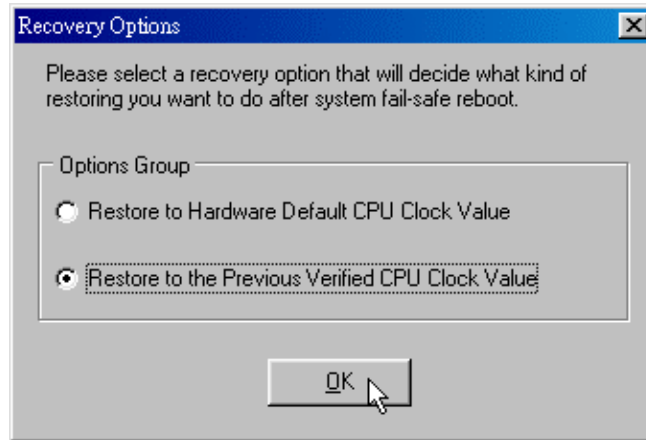

- d. “Auto-overclock button”: User can click this button and [WarpSpeeder™] will set the best and stable performance and frequency automatically. [WarpSpeeder™] utility will execute a series of testing until system fail. Then system will do fail-safe reboot by using Watchdog function. After reboot, the [WarpSpeeder™] utility will restore to the hardware default setting or load the verified best and stable frequency according to the Recovery Dialog's setting.
- e. “Verify button”: User can click this button and [WarpSpeeder™] will proceed a testing for current frequency. If the testing is ok, then the current frequency will be saved into system registry. If the testing fail, system will do a fail-safe rebooting. After reboot, the [WarpSpeeder™] utility will restore to the hardware default setting or load the verified best and stable frequency according to the Recovery Dialog's setting.

Note: Because the testing programs, invoked in Auto-overclock and Verify, include DirectDraw, Direct3D and DirectShow tests, the DirectX 8.1 or newer runtime library is required. And please make sure your display card's color depth is High color (16 bit) or True color(24/32 bit) that is required for Direct3D rendering.

5. Hardware Monitor Panel

Click the Hardware Monitor button in Main Panel, the button will be highlighted and the Hardware Monitor panel will slide out to left as the following figure.

In this panel, you can get the real-time status information of your system. The information will be refreshed every 1 second.



6. About Panel

Click the About button in Main Panel, the button will be highlighted and the About Panel will slide out to up as the following figure.

In this panel, you can get model name and detail information in hints of all the chipset that are related to overclocking. You can also get the mainboard's BIOS model and the Version number of [WarpSpeeder™] utility.

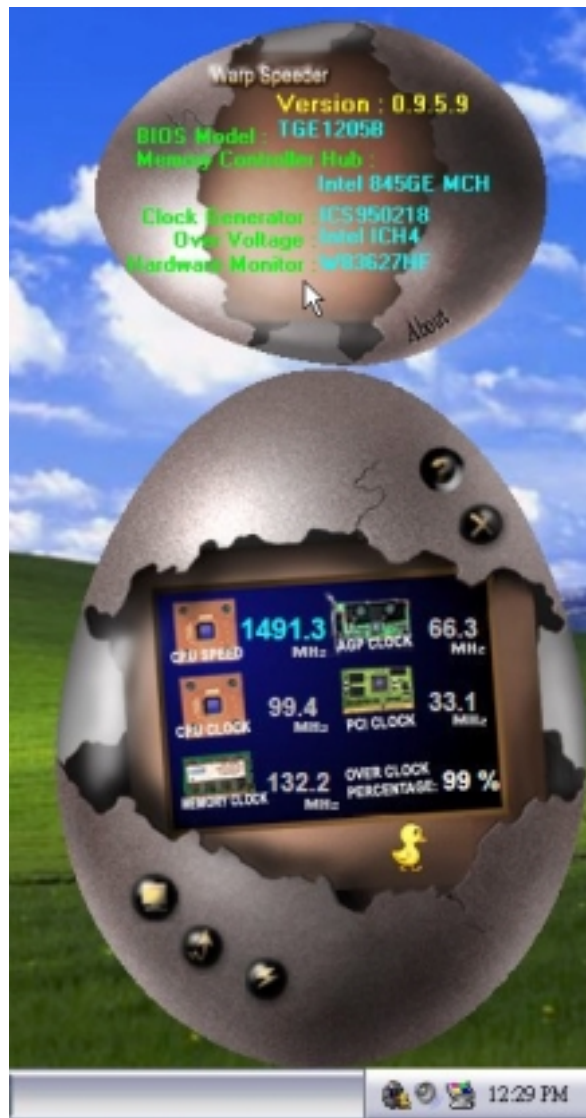

Note: Because the overclock, overvoltage, and hardware monitor features are controlled by several separate chipset, [WarpSpeeder™] divide these features to separate panels. If one chipset is not on board, the correlative button in Main panel will be disabled, but will not interfere other panels' functions. This property can make [WarpSpeeder™] utility more robust.

Trouble Shooting

PROBABLE	SOLUTION
No power to the system at all Power light don't illuminate, fan inside power supply does not turn on. Indicator light on keyboard does not turn on	<ul style="list-style-type: none"> * Make sure power cable is securely plugged in * Replace cable * Contact technical support
PROBABLE	SOLUTION
System inoperative. Keyboard lights are on, power indicator lights are lit, hard drive is spinning.	<ul style="list-style-type: none"> * Using even pressure on both ends of the DIMM, press down firmly until the module snaps into place.
PROBABLE	SOLUTION
System does not boot from hard disk drive, can be booted from CD-ROM drive.	<ul style="list-style-type: none"> * Check cable running from disk to disk controller board. Make sure both ends are securely plugged in; check the drive type in the standard CMOS setup. * Backing up the hard drive is extremely important. All hard disks are capable of breaking down at any time.
PROBABLE	SOLUTION
System only boots from CD-ROM. Hard disk can be read and applications can be used but booting from hard disk is impossible.	<ul style="list-style-type: none"> * Back up data and applications files. Reformat the hard drive. Re-install applications and data using backup disks.
PROBABLE	SOLUTION
Screen message says "Invalid Configuration" or "CMOS Failure."	<ul style="list-style-type: none"> * Review system's equipment . Make sure correct information is in setup.
PROBABLE	SOLUTION
Cannot boot system after installing second hard drive.	<ul style="list-style-type: none"> * Set master/slave jumpers correctly. * Run SETUP program and select correct drive types. Call drive manufacturers for compatibility with other drives.

Problemlösung

MÖGLICHE URSACHE	LÖSUNG
Das System hat keine Spannungsversorgung. Die Stromanzeige leuchtet nicht, der Lüfter im Inneren der Stromversorgung wird nicht eingeschaltet. Tastaturleuchten sind nicht an.	<ul style="list-style-type: none"> * Versichern Sie sich, dass das Stromkabel richtig angebracht ist * Ersetzen Sie das Stromkabel * Wenden Sie sich an Ihre Kundendienststelle
Das System funktioniert nicht. Die Tastaturleuchten sind an, die Stromanzeige leuchtet, die Festplatte dreht sich.	<ul style="list-style-type: none"> * Drücken Sie das DIMM-Modul bei gleichem Druck an beide Seiten, bis es einrastet.
Das System wird von der Festplatte nicht hochgefahren, vom CD-ROM-Treiber aber ja.	<ul style="list-style-type: none"> * Überprüfen Sie das Kabel zwischen Festplatte und Festplatten-Controller. Versichern Sie sich, dass beide Enden richtig angebracht sind; überprüfen Sie den Laufwerktyp in der standardmäßigen CMOS-Einrichtung. * Ein Backup der Festplatte ist sehr wichtig. Alle Festplatten können irgendwann beschädigt werden.
Das System wird nur von der CD-ROM hochgefahren. Die Festplatte wird gelesen und die Anwendungen sind funktionsfähig, aber es ist nicht möglich, das System von der Festplatte zu starten.	<ul style="list-style-type: none"> * Machen Sie eine Sicherungskopie von allen Daten und Anwendungsdateien. Formatieren Sie die Festplatte und reinstallieren Sie die Anwendungen und Daten mit Hilfe von Backup-Disks.
Auf dem Bildschirm erscheint die Meldung "Ungültige Konfiguration" oder "CMOS Fehler."	<ul style="list-style-type: none"> * Überprüfen Sie die Systemkomponenten und versichern Sie sich, dass diese richtig eingerichtet sind.
Das System kann nach der Installation einer zweiten Festplatte nicht hochgefahren werden.	<ul style="list-style-type: none"> * Setzen Sie die Master/Slave-Jumper richtig ein. * Führen Sie das SETUP-Programm aus und wählen Sie die richtigen Laufwerktypen. Wenden Sie sich an den Laufwerkhersteller, um die Kompatibilität mit anderen Laufwerken zu überprüfen.

06/20/2003