

M7VIQ

FCC Statement and Copyright

This equipment has been tested and found to comply with the limits of a Class B digital device, pursuant to Part 15 of the FCC Rules. These limits are designed to provide reasonable protection against harmful interference in a residential installation. This equipment generates, uses and can radiate radio frequency energy and, if not installed and used in accordance with the instructions, may cause harmful interference to radio communications. There is no guarantee that interference will not occur in a particular installation.

The vendor makes no representations or warranties with respect to the contents here of and specially disclaims any implied warranties of merchantability or fitness for any purpose. Further the vendor reserves the right to revise this publication and to make changes to the contents here of without obligation to notify any party beforehand.

Duplication of this publication, in part or in whole is not allowed without first obtaining the vendor's approval in writing.

The content of this user's is subject to be changed without notice and we will not be responsible for any mistakes found in this user's manual. All the brand and product names are trademarks of their respective companies.

Contents

ENGLISH	1
M7VIQ Features	1
Package contents	1
Layout of M7VIQ	2
CPU Installation	3
DDR DIMM Modules: DDR1-2	4
Jumpers, Headers, Connectors & Slots	5
ESPAÑOL	12
Características del M7VIQ	12
Contenido del Paquete.....	12
Disposición del M7VIQ.....	13
Instalación del CPU	14
Módulos DDR DIMM: DDR1-2	15
Conectores, Cabezales, Puentes y Ranuras.....	16
TROUBLE SHOOTING	23
SOLUCIÓN DE PROBLEMAS	24

Motherboard Description

English

M7VIQ Features

- ✦ Use Via KM266/ VT8235 Chipset, W83697HF, LAN Chip (optional).
- ✦ Contains on board I/O facilities, which include one serial port, one VGA port, a parallel port, a PS/2 mouse port, a PS/2 keyboard port, audio ports, USB ports, a LAN port (optional) and a game port.
- ✦ Supports the single AMD Socket A for Athlon™ (Thunderbird™) / Athlon XP™ / Duron™ processors running at 200/266 MHz Front Side Bus (FSB).
- ✦ Supports Ultra 133/100/66/33, PIO modes, Ide hard disk drives, LBA mode.
- ✦ Supports 2 DDR 200/266 MHz (without ECC) devices
- ✦ Supports one CNR Slot (Type B only), three 32-bit PCI Bus slots, and one AGP Slot.
- ✦ Complies with PC Micro-ATX form factor specifications.
- ✦ Supports popular operating systems such as Windows NT, Windows 2000, Windows ME, Windows XP, LINUX and SCO UNIX.
- ✦ Via® AC'97 2.2 compatible.
- ✦ High S/N ratio meets PC 99 requirements.
- ✦ 4CH DAC, applicable for leading motherboard chipsets.
- ✦ Line-in phonejack share with rear out.

Package contents

- ✦ HDD Cable X 1, FDD Cable X 1, Fully Setup Driver CD X 1
- ✦ Flash Memory Writer for BIOS update X 1
- ✦ USB Cable X 2 (Optional)
- ✦ Rear I/O Panel for ATX Case X 1 (Optional)

Motherboard Description

Layout of M7VIQ

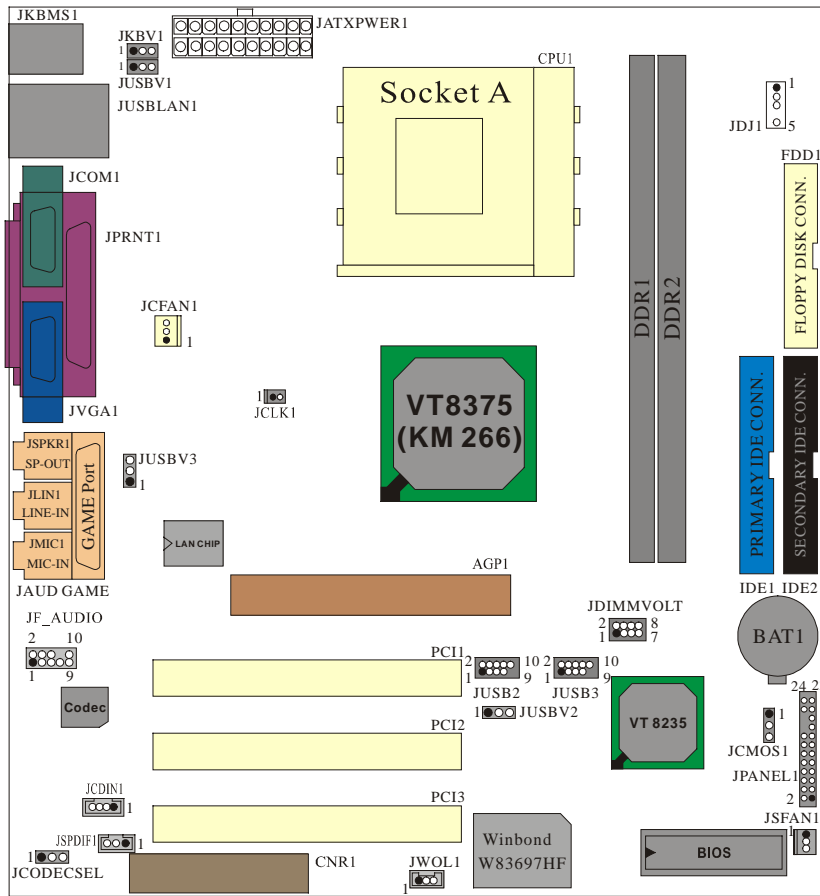

Motherboard Description

CPU Installation

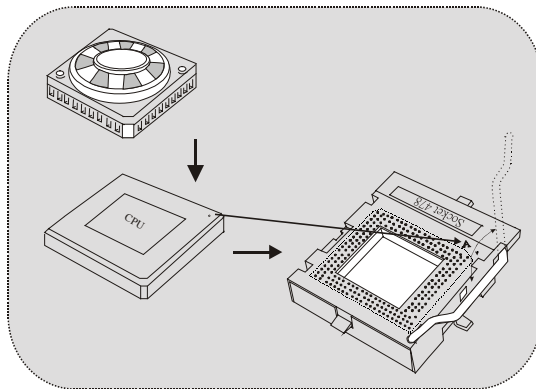

1. Pull the lever sideways away from the socket then raise the lever up to 90-degree angle.
2. Locate Pin A in the socket and lock for the white dot or cut edge in the CPU. Match Pin A with the white dot/cut edge then insert the CPU.
3. Press the lever down. Then Put the fan on the CPU and buckle it and put the fan's power port into the JCFAN1, then to complete the installation.

CPU/ System Fan Headers: JCFAN1/ JSFAN1

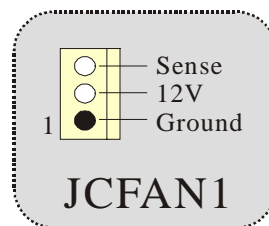
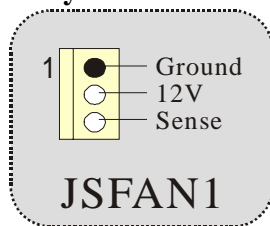

Motherboard Description

DDR DIMM Modules: DDR1-2

DRAM Access Time: 2.5V Unbuffered DDR 200/266 MHz Type required.

DRAM Type: 64MB/ 128MB/ 256MB/ 512MB/ 1GB DIMM Module (184 pin)

DIMM Socket Location	DDR Module	Total Memory Size (MB)
DDR 1	64MB/128MB/256MB/512MB/1GB *1	Max is 2GB
DDR 2	64MB/128MB/256MB/512MB/1GB *1	

* The list shown above for DRAM configuration is only for reference.

How to install a DIMM Module

1. The DIMM socket has a “ Plastic Safety Tab”, and the DIMM memory module has an “Asymmetrical notch”, so the DIMM memory module can only fit into the slot in one direction.

2. Push the tabs out. Insert the DIMM memory modules into the socket at a 90-degree angle, then push down vertically so that it will fit into the place.

3. The Mounting Holes and plastic tabs should fit over the edge and hold the DIMM memory modules in place.

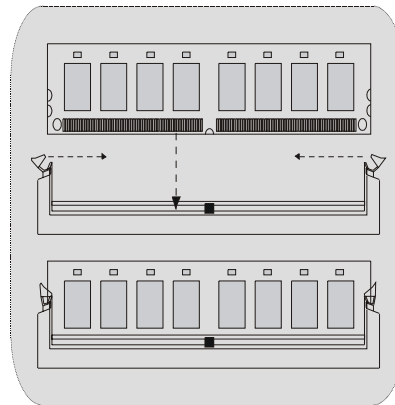

Motherboard Description

Jumpers, Headers, Connectors & Slots

Hard Disk Connectors: IDE1/ IDE2

The motherboard has a 32-bit Enhanced PCI IDE Controller that provides PIO Mode 0~4, Bus Master, and Ultra DMA / 33/ 66/ 100/ 133 functionality. It has two HDD connectors IDE1 (primary) and IDE2 (secondary).

The IDE connectors can connect a master and a slave drive, so you can connect up to four hard disk drives. The first hard drive should always be connected to IDE1.

Floppy Disk Connector: FDD1

The motherboard provides a standard floppy disk connector that supports 360K, 720K, 1.2M, 1.44M and 2.88M floppy disk types. This connector supports the provided floppy drive ribbon cables.

Communication Network Riser Slot: CNR1

The CNR specification is an open Industry Standard Architecture, and it defines a hardware scalable riser card interface, which supports modem only.

Peripheral Component Interconnect Slots: PCI1-3

This motherboard is equipped with 3 standard PCI slots. PCI stands for Peripheral Component Interconnect, and it is a bus standard for expansion cards. This PCI slot is designated as 32 bits.

Accelerated Graphics Port Slot: AGP1

Unlike the mouse ports, keyboard ports and printer ports, this motherboard does not have built in video facilities; and therefore, requires a video card for one of the expansion slots. Your monitor will attach directly to that video card. This motherboard supports video cards for PCI, but is also equipped with an Accelerated Graphics Port (AGP). An AGP card will take advantage of AGP technology for improved video efficiency and performance, especially with 3D graphics.

Motherboard Description

Power Connectors: JATXPWR1

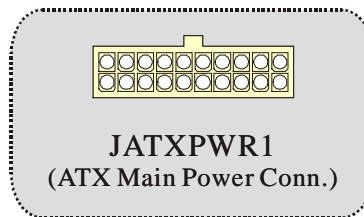

DIMM Power Selection Connector: JDIMMVOLT

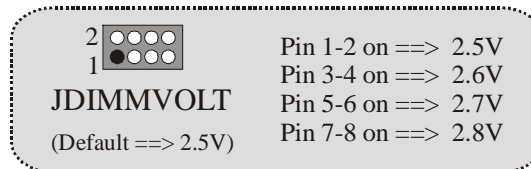

- It strongly recommended to set DDR DIMM voltage in default setting 2.5V, and it for over voltage function.

Wake On LAN Header: WOL1

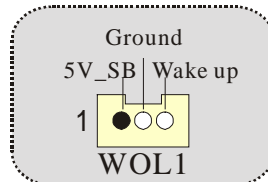

Clear CMOS Jumper: JCMOS

JCMOS1	Assignment
<p>1 Pin 1-2 on</p>	Normal Operation (default)
<p>1 Pin 2-3 on</p>	Clear CMOS Data

Motherboard Description

Front USB Header: JUSB2/ JUSB3

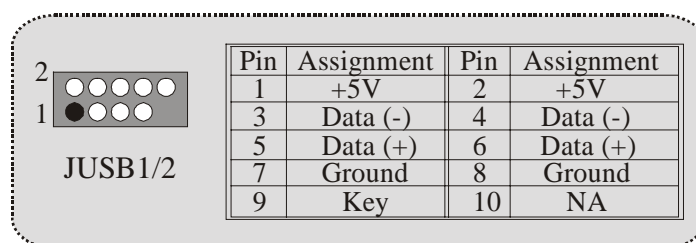

5V/ 5VSB Selection for USB: JUSBV1/2/3

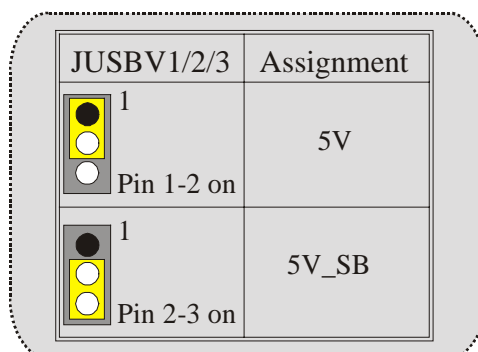

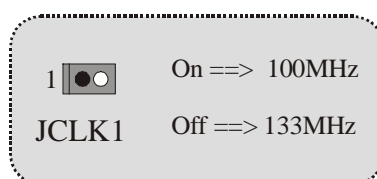

CPU Frequency Selection: JCLK1





Motherboard Description

5V/ 5VSB Selection for Keyboard: JKBV1

JKBV1	Assignment
1  Pin 1-2 on	5V
1  Pin 2-3 on	5V_SB

CNR Codec Primary/ Secondary Selection: JCODECSEL

J_CODECSEL	Assignment
 Pin 1-2 1	On-board Primary Codec (Default).
 Pin 2-3 1	CNR Primary Codec.

Motherboard Description

Front Panel Connector: JPANEL1

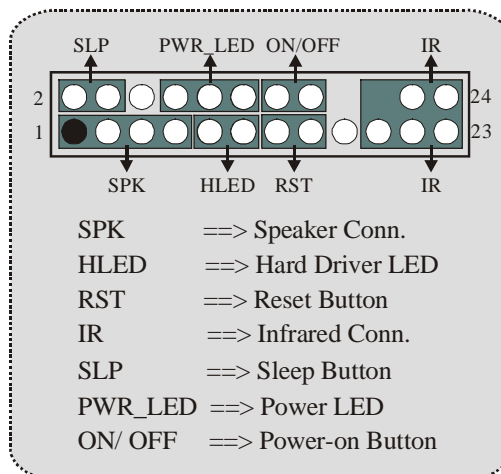

Audio DJ: JDJ1

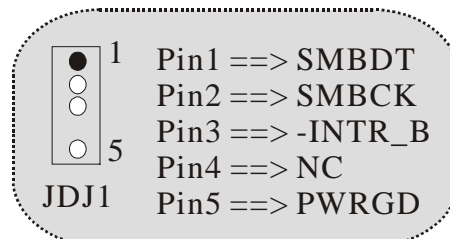

Digital Audio Connector: JSPDIF1 (Optional)

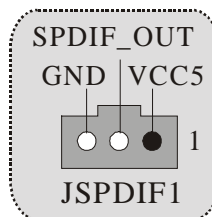

Motherboard Description

Audio Subsystem: JF_AUDIO/JCDIN1

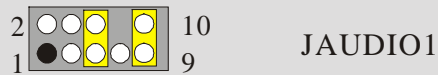

Pin	Assignment	Pin	Assignment
1	Mic In	2	Ground
3	Mic Power	4	Audio Power
5	RT Line Out	6	RT Line Out
7	Reserved	8	NC
9	LFT Line Out	10	LFT Line Out

Pin 5 and 9 are routed to Front Panel Audio Out.
Pin 6 and 10 are routed from Front Panel Audio Out.

Front Panel Audio Connector/ Jumper Block

Jumper Setting	Configuration
<p>Pin 5 and 6 Pin 9 and 10</p>	Audio line out signals are routed to the back panel audio line out connector.
<p>No jumpers installed</p>	Audio line out and mic in signals are available for front panel audio connectors.

Motherboard Description

Back Panel Connectors

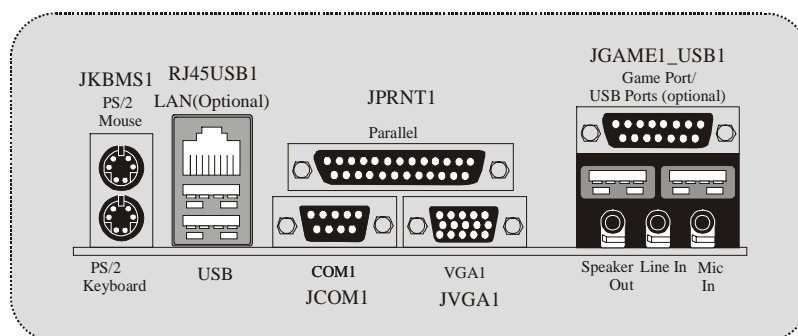

Motherboard Description

Español

Características del M7VIQ

- ✦ Usa Chipset Via KM266/ VT8235, W83697HF, LAN Chip (opcional).
- ✦ Contiene facilidades I/O integrados en la placa madre en el que incluye un puerto en serie, un puerto paralelo, un puerto de ratón PS/2, un puerto de teclado PS/2, puerto de audio, puertos USB, un puerto LAN (opcional), un puerto de juego, y un puerto para el monitor.
- ✦ Soporta single AMD Socket A para procesadores Athlon™ (Thunderbird™) / Athlon XP™ / Duron™ corriendo a 200/266 MHz Front Side Bus (FSB).
- ✦ Soporta Ultra 133/100/66/33, modos PIO, discos duros IDE, modo LBA.
- ✦ Soporta 2 dispositivos DDR 200/266 MHz (sin ECC).
- ✦ Soporta una ranura CNR (solamente de Tipo B), tres ranuras PCI Bus de 32-bit, y una ranura AGP.
- ✦ Conformar con las especificaciones del factor de forma de tamaño PC Micro-ATX.
- ✦ Soporta sistemas operativos populares tales como Windows NT, Windows 2000, Windows ME, Windows XP, LINUX y SCO UNIX.
- ✦ Compatible con Via® AC'97 2.2.
- ✦ High S/N ratio reúne los requisitos del PC 99.
- ✦ 4CH DAC, aplicables para chipsets de principales placas madres.
- ✦ Entrada de Línea phonejack compartido con el rear out.

Contenido del Paquete

- ✦ Cable HDD X 1, Cable FDD X 1, Configuración Completa del Driver CD X 1
- ✦ Flash Memory Writer para actualización del BIOS X 1

Motherboard Description

- ✪ Cable USB X 2 (Opcional)
- ✪ Panel Trasero I/O para Caja ATX X 1 (Opcional)

Disposición del M7VIQ

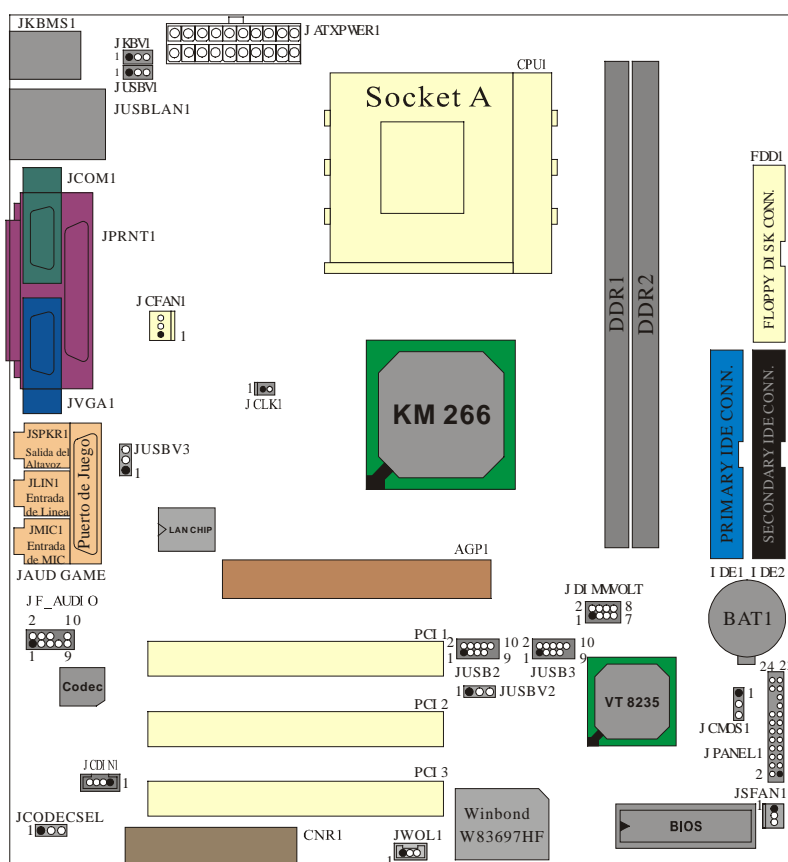

Motherboard Description

Instalación del CPU

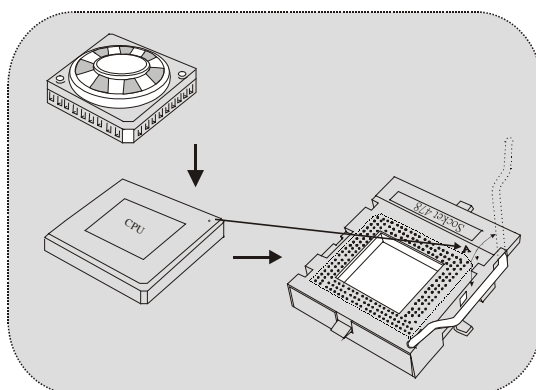

1. Tire de la palanca del lado del zócalo, luego levante la palanca hasta un ángulo de 90 grados.
2. Sitúe el contacto A del zócalo y busque el punto blanco o corte el borde en la CPU. Empareje el contacto A con el punto blanco/corte del borde, luego inserte la CPU.
3. Presione la palanca para abajo. Ponga el ventilador en la CPU y abróchelo. Luego ponga el puerto de corriente del ventilador en el JCFAN1. Y ya habrá completado su instalación.

CPU/ Cabezales del Sistema de Ventilación: JCFAN1/ JSFAN1

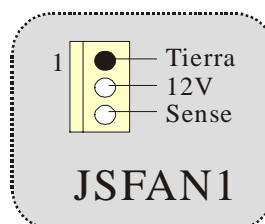
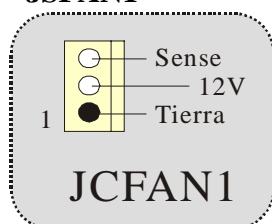

Motherboard Description

Módulos DDR DIMM: DDR1-2

DRAM Tiempo de Acceso: 2.5V Unbuffered DDR 200/266 MHz Tipo requerido.

DRAM Tipo: 64MB/ 128MB/ 256MB/ 512MB/ 1GB Módulo DIMM (184 pin)

Localización del Módulo DIMM	Módulo DDR	Total del Tamaño de Memoria (MB)
DDR 1	64MB/128MB/256MB/512MB/1GB *1	Máximo de 2GB
DDR 2	64MB/128MB/256MB/512MB/1GB *1	

* La lista de arriba para la configuración DRAM es solamente para referencia.

Cómo instalar un Módulo DIMM

1. El zócalo DIMM tiene una lengüeta plástica de seguridad y el módulo de memoria DIMM tiene una muesca asimétrica, así el módulo de memoria DIMM puede caber solamente en la ranura de una sola dirección.

2. Tire la lengüeta hacia afuera. Inserte los módulos de memoria DIMM en el zócalo a los 90 grados, luego empuje hacia abajo verticalmente de modo que encaje en el lugar.

3. Los agujeros de montaje y las lengüetas plásticas deben caber por sobre el borde y sostenga los módulos de memoria DIMM en el lugar.

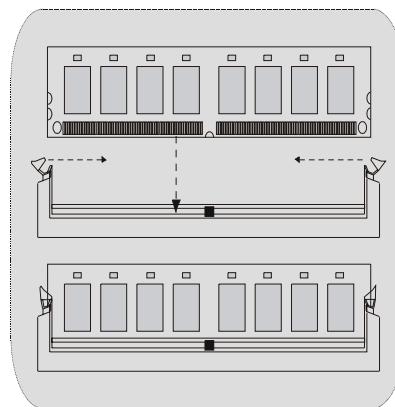

Motherboard Description

Conectores, Cabezales, Puentes y Ranuras

Conectores del Disco Duro: IDE1/ IDE2

La placa madre tiene un controlador de 32-bit PCI IDE que proporciona Modo PIO 0-4, Bus Master, y funcionalidad Ultra DMA / 33/ 66/ 100. Tiene dos conectores HDD IDE1 (primario) y IDE2 (secundario).

El conector IDE puede conectar a un master y un drive esclavo, así puede conectar hasta cuatro discos rígidos. El primer disco duro debe estar siempre conectado al IDE1.

Conector para el Disquete: FDD1

La placa madre proporciona un conector estándar del disquete (FDC) que soporta 360K, 720K, 1.2M, 1.44M y 2.88M tipos de disquete. Éste conector utiliza los cables de cinta proporcionados por el disquete.

Banda de Suspensión de Comunicación y Red: CNR1

La especificación CNR es una abierta Industria de Arquitectura Estándar, que define una tarjeta de interface escalable del hardware en el que soporta solamente modem.

Ranura de Interconexión del Componente Periférico:

PCI1-3

Ésta placa madre está equipada con 3 ranuras estándar PCI. PCI es la sigla para Interconexión del Componente Periférico, y es un bus estándar para tarjetas de expansión en el que suplanta a la antigua bus estándar ISA, en su mayoría de las partes. Ésta ranura PCI está diseñado con 32 bits.

Ranura del Puerto Acelerado para Gráficos: AGP1

Su monitor se fijará directamente a la tarjeta de video. Ésta placa madre soporta tarjetas de video para ranuras PCI, y también está equipado con un Puerto Acelerado para Gráficos (AGP/ solamente soporta 1.5V y 4X tarjeta AGP). Ésta tarjeta AGP tomará ventaja de la tecnología del AGP para el mejoramiento de la eficiencia y funcionamiento del video, especialmente con gráficos 3D.

Motherboard Description

Conectores de Corriente: JATXPWR1

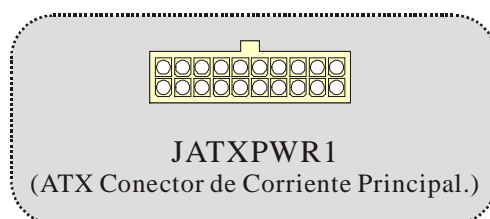

Conector de Selección de la Corriente DIMM: JDIMMVOLT

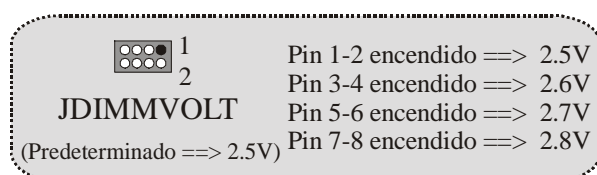

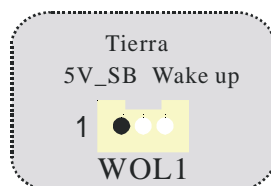

- Ésta fuertemente recomendado fijar el voltaje del DDR DIMM en su voltaje predeterminado 2.5V, and it for over voltage function.

Cabezal Wake On LAN: WOL1



Motherboard Description

Puente de Borrar CMOS: JCMOS1

JCMOS1	Asignación
 1 Contacto 1-2 on	Operación Normal (default)
 1 Contacto 2-3 on	Borrar Datos CMOS

Cabezal Frontal USB: JUSB2/ JUSB3

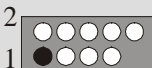
JUSB2/ 3

Contactos	Asignación	Contactos	Asignación
1	+5V	2	+5V
3	Data (-)	4	Data (-)
5	Data (+)	6	Data (+)
7	Tierra	8	Ground
9	Key	10	NA

5V/ 5VSB Selección para USB: JUSBV1/2/3

JUSBV1/ 2/ 3	Asignación
 1 Contactos 1-2 on	5V
 1 Contactos 2-3 on	5V_SB

Motherboard Description

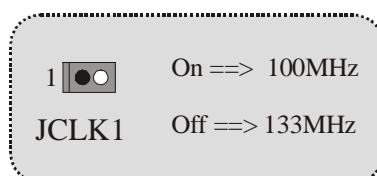

Selección de Frecuencia del CPU: JCLK1



5V/ 5VSB Selección para Teclado: JKBV1

JKBV1	Asignación
1  Contactos 1-2 on	5V
1  Contactos 2-3 on	5V_SB

CNR Codec de Selección Primario/ Secundario: JCODECSEL

J_CODECSEL	Assignment
 Contacto 1-2 1	Codec Primario integrado en la placa madre.
 Contacto 2-3 1	CNR Codec Primario.

Motherboard Description

Conector del Panel Frontal: JPANEL1

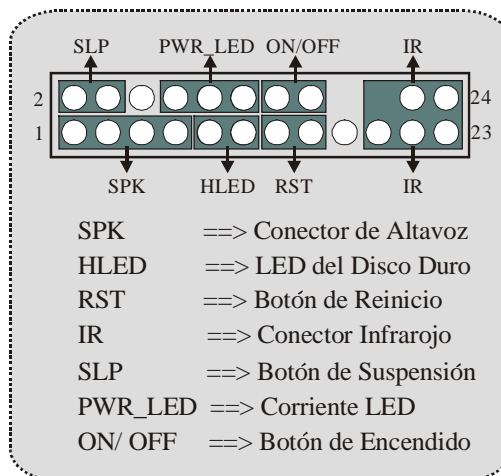

Audio DJ: JDJ1



Conector Digital de Audio: JSPDIF1 (Optional)

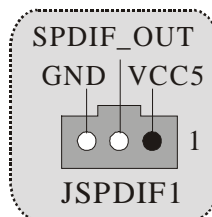

Motherboard Description

Subsistema de Audio: JF_AUDIO/JCDIN1

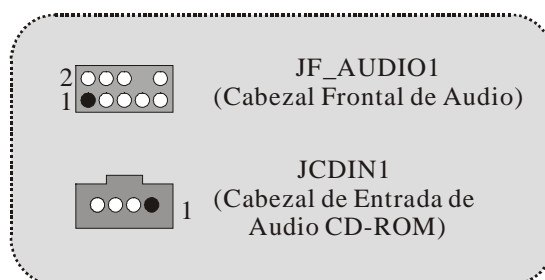

JAUDIO1

Contactos	Asignacion	Contactos	Asignacion
1	Entrada del MIC	2	Tierra
3	Corriente del MIC	4	Corriente de Audio
5	RT Salida de Linea	6	RT Salida de Linea
7	Reservado	8	Key
9	LFT Salida de Linea	10	LFT Salida de Linea

Contactos 5 y 9 son encaminados a la Salida de Audio del Panel Frontal.
 Contactos 6 y 10 son encaminados desde la Salida de Audio del Panel Frontal.

Motherboard Description

Conector del Panel Frontal de Audio/ Jumper Block

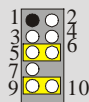
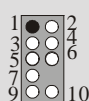
Jumper Setting	Configuración
 <p>1 2 3 4 5 6 7 8 9 10</p> <p> Contacto 5 & 6 Contacto 9 & 10</p>	<p>La señal de salida de línea del Audio encamina al conector de la salida de línea del Audio ubicado en el panel trasero.</p>
 <p>1 2 3 4 5 6 7 8 9 10</p> <p> No jumpers installed</p>	<p>La señal de salida de línea del Audio y la señal del entrada del mic estan disponibles desde el conector de Audio del panel frontal.</p>

Conectores del Panel Trasero

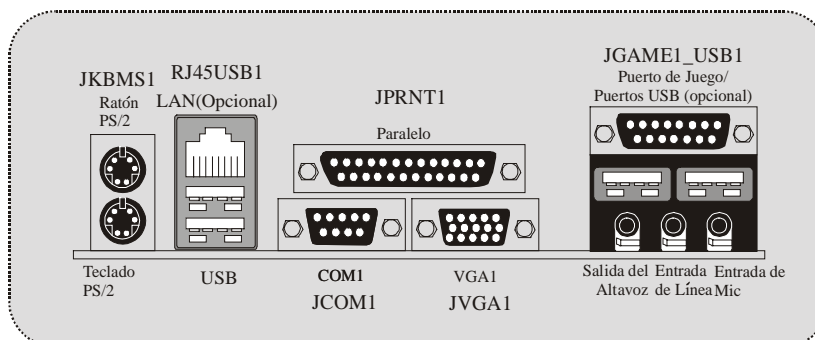

Trouble Shooting

PROBABLE	SOLUTION
No power to the system at all Power light don't illuminate, fan inside power supply does not turn on. Indicator light on keyboard does not turn on	<ul style="list-style-type: none"> * Make sure power cable is securely plugged in * Replace cable * Contact technical support
PROBABLE	SOLUTION
System inoperative. Keyboard lights are on, power indicator lights are lit, hard drive is spinning.	<ul style="list-style-type: none"> * Using even pressure on both ends of the DIMM, press down firmly until the module snaps into place.
PROBABLE	SOLUTION
System does not boot from hard disk drive, can be booted from CD-ROM drive.	<ul style="list-style-type: none"> * Check cable running from disk to disk controller board. Make sure both ends are securely plugged in; check the drive type in the standard CMOS setup. * Backing up the hard drive is extremely important. All hard disks are capable of breaking down at any time.
PROBABLE	SOLUTION
System only boots from CD-ROM. Hard disk can be read and applications can be used but booting from hard disk is impossible.	<ul style="list-style-type: none"> * Back up data and applications files. Reformat the hard drive. Re-install applications and data using backup disks.
PROBABLE	SOLUTION
Screen message says "Invalid Configuration" or "CMOS Failure."	<ul style="list-style-type: none"> * Review system's equipment . Make sure correct information is in setup.
PROBABLE	SOLUTION
Cannot boot system after installing second hard drive.	<ul style="list-style-type: none"> * Set master/slave jumpers correctly. * Run SETUP program and select correct drive types. Call drive manufacturers for compatibility with other drives.

Solución de Problemas

CAUSA PROBABLE	SOLUCIÓN
No hay corriente en el sistema. La luz de corriente no ilumina, ventilador dentro de la fuente de alimentación apagada. Indicador de luz del teclado apagado.	* Asegúrese que el cable de transmisión esté seguramente enchufado. * Reemplace el cable. * Contacte ayuda técnica.
Sistema inoperativo. Luz del teclado encendido, luz de indicador de corriente iluminado, disco rígido está girando.	* Presione los dos extremos del DIMM, presione para abajo firmemente hasta que el módulo encaje en el lugar.
Sistema no arranca desde el disco rígido, puede ser arrancado desde el CD-ROM drive.	* Controle el cable de ejecución desde el disco hasta el disco del controlador. Asegúrese de que ambos lados estén enchufados con seguridad; controle el tipo de disco en la configuración estándar CMOS. * Copiando el disco rígido es extremadamente importante. Todos los discos rígidos son capaces de dañarse en cualquier momento.
Sistema solamente arranca desde el CD-ROM. Disco rígido puede leer y aplicaciones pueden ser usados pero el arranque desde el disco rígido es imposible.	* Copie datos y documentos de aplicación. Vuelva a formatear el disco rígido. Vuelva a instalar las aplicaciones y datos usando el disco de copiado.
Mensaje de pantalla "Invalid Configuration" o "CMOS Failure."	* Revise el equipo del sistema. Asegúrese de que la información configurada sea correcta.
No puede arrancar después de instalar el segundo disco rígido.	* Fije correctamente el puente master/esclavo. * Ejecute el programa SETUP y seleccione el tipo de disco correcto. Llame a una manufacturación del disco para compatibilidad con otros discos.



12/04/2002

