M6TWG

Federal Communications Commission (F.C.C) Statement

This device complies with Part 15 of the FCC Rules. Operation of this device is subject to the following two conditions: (1) this device may not cause harmful interference, and (2) this device must accept any interference received, including interference that may cause undesired operation.

Accessories: This device has been tested and found to comply with the limits of a Class B digital device, the accessories associated with this equipment are as follows:

1. Shielded serial cable. (Can be obtained from multiple retail outlets)
2. Shielded printer cable. (Can be obtained from multiple retail outlets)
3. Shielded video cable. (Can be obtained from multiple retail outlets)
4. Shielded power cord. (Provided by manufacturer)

These accessories are required to ensure compliance with FCC Rules. It is the responsibility of the user to provide and use these accessories properly.

This equipment has been tested and found to comply with the limits of a Class B digital device, pursuant to Part 15 of the FCC Rules. These limits are designed to provide reasonable protection against harmful interference in a residential installation. This equipment generates, uses and can radiate radio frequency energy and, if not installed and used in accordance with the instructions, may cause harmful interference to radio communications. there is no guarantee that interference will not occur in a particular installation. If this equipment does cause harmful interference to radio or television reception, which can be determined by turning the equipment off and on, you are encouraged to try to correct the interference by one or more of the following measures:

-
1. Reorient / relocate the receiving antenna.
 2. Increase the separation between the equipment and receiver.
 3. Connect the equipment into an outlet on a circuit different from that to which the receiver is connected.
-

4. Consult the dealer or an experienced radio/TV technician for help.

Caution: Changes or modifications not expressly approved by the manufacturer could void the user's authority to operate the equipment.

Disclaimer

The vendor makes no representations or warranties with respect to the contents here of and specially disclaims any implied warranties of merchantability or fitness for any purpose. Further, the vendor reserves the right to revise this publication and to make changes to the contents here of without obligation to notify any party beforehand.

Duplication of this publication, in part or in whole, is not allowed without first obtaining the vendor's approval in writing.

Trademarks and Remarks

MS-DOS, Windows, Windows NT, Windows 9x and Windows 2000 are products of Microsoft Corp, with its ownership of trademark, and are distributed by the Vendor under a license agreement.

All trademarks used in this manual are the property of their respective owners.

Copyright© 1999

All Rights Reserved

Canadian D.O.C. Statement

This digital apparatus does not exceed the Class B limits for radio noise emissions from digital apparatus as set out in the radio interference regulations of the Canadian Department of Communications.

Cet appareil numérique n'émet pas de bruits radioélectriques dépassant les limites appliqués aux appareils numériques de Class B prescrits dans le règlement du brouillage radioélectrique édicté par le ministère Des Communications du Canada.

Introduction	1-1
1 Motherboard Description	1-2
1.1 Features	1-2
1.1.1 Hardware	1-2
1.1.2 Software	1-6
1.1.3 Accessories	1-6
1.2 Motherboard Installation.....	1-7
1.2.1 Layout of Motherboard	1-7
1.3 Motherboard Connectors.....	1-8
1.3.1 Front Panel Connectors: J20.....	1-9
1.3.2 ATX 20-pin Power Connector : J4.....	1-12
1.3.3 Hard Disk Connectors : J10 / J11	1-13
1.3.4 Floppy Disk Connector : J12.....	1-13
1.4 Back Panel Connectors	1-14
1.4.1 PS/2 Mouse / Keyboard Connector: J2	1-14
1.4.2 USB Connectors: J5	1-15
1.5 Serial and Parallel Interface Ports	1-16
1.6 CPU Installation.....	1-21
1.6.1 CPU Installation Procedure: Socket 370	1-21
1.6.2 CPU Installation Procedure : Slot 1	1-22
1.7 Jumper Settings	1-26
1.7.1 CPU Fan Connector: J1	1-26

1.7.2 Sound AC'97 CODEC Selection: J19	1-27
1.7.3 System Fan Connector: J21 (Optional).....	1-27
1.7.4 Keyboard/Mouse Power Selection: J25.....	1-27
1.7.5 Manufacture Setting: JP4 (Ver: 1.1A / 1.2 /1.3).....	1-28
1.7.6 Wake-On-LAN Connector: JP14.....	1-28
1.7.7 FWH (BIOS) Lock/Unlock Connector: JP17.....	1-28
1.7.8 Wake-On-Ring Connector: JP18	1-28
1.7.9 CMOS Function Selection: JP20.....	1-29
1.7.10 Socket 370 & Slot 1 Selection: JP22.....	1-29
1.7.11 USB Jumper Block: JUSB (Optional, Ver1.2).....	1-29
1.7.12 Front Panel USB: FPUSB (Optional, Ver1.2).....	1-30
1.8 DRAM Installation.....	1-31
1.8.1 DIMM	1-31
1.9 Audio Subsystem.....	1-32
1.9.1 CD Audio-In Connectors: CD_IN1/JCD_IN2.....	1-33
1.9.2 Telephony Connector: JP11	1-33
1.9.3 AUX Audio in Connector : AUX_IN (Optional)	1-34
1.9.4 Digital Speaker Out Connector : J22 (Optional)	1-34
2. BIOS Setup.....	2-1
2.1 Main Menu.....	2-3
2.2 Standard CMOS Features.....	2-6
2.3 Advanced BIOS Features.....	2-9
2.4 Advanced Chipset Features.....	2-13

2.5 Integrated Peripherals	2-16
2.6 Power Management Setup.....	2-20
2.7 PnP/PCI Configurations	2-25
2.8 Frequency Control.....	2-28
2.9 M/B Diagnosis (Optional).....	2-29
2.10 Load Fail-Safe Defaults	2-30
2.11 Load Optimized Defaults	2-31
2.12 Set Supervisor/User Password	2-32
2.13 Save & Exit Setup	2-33
2.14 Exit Without Saving.....	2-34
3. Software.....	3-1
3.1 Software List.....	3-1
3.2 Software Installation	3-2
3.3 Software Usage	3-4
4. Trouble shooting.....	4-1

Introduction

System Overview

Thanks for buying this product! This manual was written to help you start using this product as quickly and smoothly as possible. Inside you will find adequate explanations to solve most problems. For help in finding topics of interest, refer to Table of Contents.

This board incorporates the all new Intel® 810 serial chipset, built_in , LPC I/O, and PCI IDE and UMA AGP VGA into one board that provides a total PC solution. The motherboard, a Celeron® / Pentium®II & Pentium®!!!, processor based PC/Micro ATX system, supports 128KB or 256KB or 512KB cache on CPU, PCI Local Bus to support upgrades to your system performance. On-Board Sound Subsystem to support high 3D soma quality the AMR Slot to support the solution of high performance, low cost modem. It is ideal for multi-tasking and fully supports MS-DOS, Windows 3x, Windows NT, Windows 2000, Novell, OS/2, Windows9x, UNIX, SCO UNIX etc. This manual also explains how to install the motherboard for operation, and how to setup your CMOS configuration with the BIOS setup program.

1 Motherboard Description

1.1 Features

1.1.1 Hardware

CPU

- The Celeron[®] processor (PPGA), Coppermine Processor (FC-PGA) and the Pentium[®] II or Pentium[®]!!! Micro-Processor provides the new generation power for high-end workstations and servers.
- Provides Socket 370 and Slot 1.
- Running at 66, 100 MHz Front Side Bus frequency.

Note: Only 1.2 or afterward version able to support Coppermine Slot-1 CPU & FC-PGA Socket 370 CPU.

Speed

- Supports from 300MHz to 1GHz CPU core speeds.
- Supports 33MHz PCI Bus speed.

DRAM Memory

- Supports two 8/16/32/64/128/256MB DIMM module sockets.
- Supports Synchronous DRAM (3.3V).
- Supports a maximum memory size of 512 MB with SDRAM.
- 100MHz Bus frequency.

Shadow RAM

- A memory controller that provides shadow RAM.

Green PC Power Management Functionality

- Supports power management operation via BIOS.
- Power down timer from 1 min to 1 hour.
- Wakes up by any key pressed or mouse activity.
- Wake On LAN connector.
- Wake On MODEM header.

- S3 (suspend to RAM) support (STR) (Optional).
- Wake On AMR supported.

BUS Slots

- Provides one AMR Slot and three PCI Bus slots.

PCI Enhanced IDE Built-in Onboard

- Supports 4 IDE hard disk drives.
- Supports PIO mode 4, Master Mode high performance hard disk drives.
- Supports Ultra DMA/33 and Ultra DMA/66 (Optional) Bus Master Mode.
- Supports IDE interface with CD-ROM.
- Supports high capacity hard disk drives.
- Supports LBA mode.
- Driver detected by BIOS.

PCI-based AC 97 Digital Audio Processor (Optional)

- AC 97 2.1 interface w/ multi-codec and docking support.
- 16 channels of scatter/ gather DMA.
- 16 channels of high-quality sample rate conversion.
- 16x8 channel digital mixer.
- Stereo 10 band graphic equalizer.
- Sound Blaster[®] and Sound Blaster Pro emulation.
- S/PDIF output (allows standard interface to consumer electronics).
- 64-voice wavetable.
- PC99 compliant and WHQL certified.

AC'97 Sound Codec Onboard

- AC'97 2.1 FEATURES.
- Variable Sample Rate.
- True Line-Level Output.
- Multibit Converter Architecture for Improved S/N Ratio greater than 90dB.
- 16-Bit stereo Full-Duplex Codec.
 - Four Analog Line-Level Stereo Inputs for Connection from LINE, CD, AUX and TAD.

- Two Analog Line-Level Mono Inputs for Speakerphone and PC BEEP.
- Mono MIC Input.
- High Quality CD Input with Ground Sense.
- Stereo Line Level Output.
- Mono Output for speakerphone.
- Mobile Low Power Mixer Mode.
- Digital Audio Mixer Mode.
- DSP 16-Bit Serial Port Format, Slot 16 Mode.
- Full Duplex Variable 7 KHz to 48 KHz Sampling Rate with 1 Hz Resolution.
- Phat™ Stereo Chancement.

LPC I/O Built-in Onboard

- LPC Interface.
- PC98, PC99 Compliant.
- Game Port Interface.
- MPU-401 MDI Support.
- Intelligent Auto Power Management.
- 2.88MB Super I/O Floppy Disk Controller.
- Floppy Disk Available on Parallel Port Pins.
 - Supports 360KB, 720KB, 1.2MB, 1.44MB, and 2.88MB floppy disk drives.
- Enhanced Digital Data Separator.
- Serial Ports.
 - Two full Function Serial Ports.
 - Supports 230K and 460K Baud Programmable Baud Rate Generator Modem Control Circuitry.
- Infrared Port.
- Multi-Mode™ Parallel Port with ChipProtect™.

Integrated 2D/3D graphics accelerator

- Integrated 24-bit 230MHz RAM DAC.
- H/W Motion Compensation Assistance for S/W MPEG2 Decode.
- Optional 4MB Display Cache.

Hardware Monitor Subsystem (optional)

The hardware monitor subsystem provides low-cost instrumentation capabilities. The features of the hardware monitor subsystem include:

- Management Level 4 functionality.
- Microprocessor System Hardware Monitor:
 - Integrated temperature and voltage monitoring to detect levels above or below acceptable values (+12V, -12V, +5V, +3.3V, VCCORE). When suggested ratings for temperature, fan speed, or voltage are exceeded, an interrupt is activated.
 - One fan speed sensor.
- Access through the SMBus.
- Remote reset capabilities from a remote peer or server.

System speed selection

- Front side bus frequency may be selected by both Jumper setting and the BIOS.

Universal Serial Bus

- Supports two Universal Serial Bus (USB) Ports.
- Supports 48MHz USB.

Dimension (Micro ATX form-factor)

- 20.8cm X 24.4 cm (W x L)

1.1.2 Software

BIOS

- AWARD BIOS.
- ACPI Supported.
- Supports APM1.2.
- Supports USB Function.
- Setting the CPU Host frequency/Ratio.

Operating Systems

- Offers the highest performance for MS-DOS, OS/2, Windows 3x, Windows NT, Windows 9x, Windows 2000, Novell, UNIX, SCO UNIX etc.

1.1.3 Accessories

- HDD cable.
- FDD cable.
- Rear I/O Panel for ATX Case (Optional).
- COM2 cable (Optional).
- CD for Sound, VGA, IDE drivers.

1.3 Motherboard Connectors

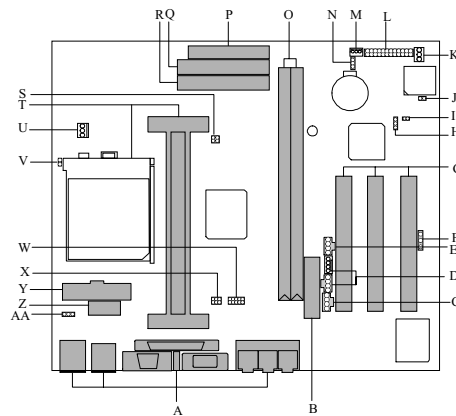

- | | |
|--|---|
| A. Back panel I/O connectors | O. DIMMs (DIMM1-2) |
| B. AMR Slot (J17) | P. FDC connector (J12) |
| C. Telephony connector (JP11) | Q. PRIMARY IDE CONN (J11) |
| D. CD Audio-In connector
(CD_IN1/JCD_IN2) | R. SECONDARY IDE CONN(J10) |
| E. AUX_In connector (AUX_IN) (Option) | S. Manufacture Setting (JP4) |
| F. Digital Speaker Out Connector (J22) | T. CPU Slot (SLOT1 & Socket 370) |
| G. PCI BUS Slots (PCI1-3) | U. CPU Fan Connector (J1) |
| H. CMOS Function Selection (JP20) | V. Socket 370 & Slot 1 Selection (JP22) |
| I. Wake On Modem (JP18) | W. Front Panel USB (FPUSB)
(Optional, Ver:1.2) |
| J. FWH (BIOS) Lock / Unlock CONN
(JP17) | X. USB Jump Block (JUSB)
(Optional, Ver:1.2) |
| K. System Fan connector (J21) (Optional) | Y. ATX Power connector (J4) |
| L. Front Panel connector (J20) | Z. COM2 connector (J7) |
| M. Wake On LAN (JP14) | AA. Keyboard / Mouse Power Selection
(J25) |
| N. AC'97 CODEC Selection (J19) | |

1.3.1 Front Panel Connectors: J20

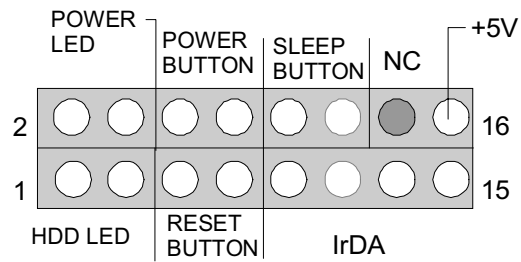

Pin No.	Assignment	Function	Pin No.	Assignment	Function
1	HDD LED (+)	Hard Drive LED	2	Power LED (+)	Power LED
3	HDD LED (-)		4	Power LED (-)	
5	Ground	Reset button	6	Power Button	Power Button
7	Reset control		8	Ground	
9	+5V	IrDA Connector	10	Sleep Control	Sleep Button
11	Ir-IN		12	Ground	
13	Ground		14	No Connection	No Connection
15	Ir-out		16	+5V	

PC Speaker (Optional)

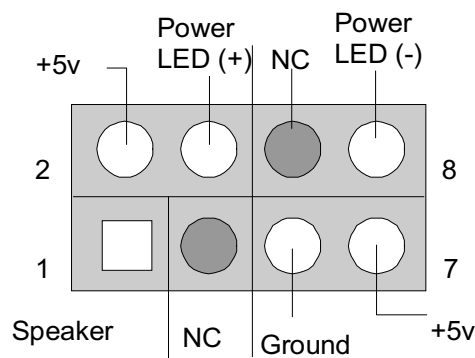

Pin No.	Assignment	Function	Pin No.	Assignment	Function
1	Speaker	PC Speaker Connector	2	+5V	VCC
3	NC		4	Power LED(+)	Power LED
5	Ground		6	NC	No Connection
7	+5V		8	Power LED(-)	Power LED

Speaker Connector

An offboard speaker can be installed on the motherboard as a manufacturing option. An offboard speaker can be connected to the motherboard at the front panel connector. The speaker (onboard or offboard) provides error beep code information during the Power On Self-Test when the computer cannot use the video interface. The speaker is not connected to the audio subsystem and does not receive output from the audio subsystem.

Reset Button

This connector can be connected to a momentary SPST type switch that is normally open. When the switch is closed, the motherboard resets and runs the POST.

Power LED Connector

This connector can be connected to an LED that will light when the computer is powered on.

Hard Drive LED Connector

This connector can be connected to an LED to provide a visual indicator that data is being read from or written to a hard drive. For the LED to function properly, an IDE drive must be connected to the onboard hard drive controller.

Infrared Connector

After the IrDA interface is configured, files can be transferred from or to portable devices such as laptops, PDAs, and printers using application software.

Sleep Button

When APM is enabled in the system BIOS, and the operating system's APM driver is loaded, the system can enter sleep (standby) mode in one of the following ways:

Power On Button

This connector can be connected to a front panel power switch. The switch must pull the Power Button pin to ground for at least 50 ms to signal the power supply to switch on or off. (The time requirement is due to internal denounce circuitry on the motherboard.) At least two seconds must pass before the power supply will recognize another on/off signal.

1.3.2 ATX 20-pin Power Connector : J4

This connector supports the power button on-board. Using the ATX power supply, functions such as Modem Ring Wake-Up and Soft Power Off are supported on this motherboard. This power connector supports instant power-on functionality, which means that the system will boot up instantly when the power connector is inserted on the board.

PIN	VOLTAGE	PIN	VOLTAGE
1	3.3 V	11	3.3 V
2	3.3 V	12	-12 V
3	GND	13	GND
4	5 V	14	PS_ON
5	GND	15	GND
6	5 V	16	GND
7	GND	17	GND
8	PW_OK	18	-5 V (Optional)
9	5V_SB	19	5 V
10	12 V	20	5 V

Warning: Since the motherboard has the instant power on function, make sure that all components are installed properly before inserting the power connector to ensure that no damage will be done.

1.3.3 Hard Disk Connectors : J10 / J11

The motherboard has a 32-bit enhanced PCI IDE controller that provides PIO mode 0~4, bus master, and ultra DMA 33/66 functionality. It has two HDD connectors IDE1 (primary) and IDE2 (secondary). You can connect up to four drives, including hard drives, CD-ROMs, or LS120Mbyte floppy drives (reserved for future BIOS) or any other IDE compatible devices to IDE1 and IDE2. These connectors support the IDE hard disk cable provided.

- **J11 (Primary IDE Connector)**

The first hard drive should always be connected to IDE1. IDE1 can connect a master and a slave drive. You must configure a second hard drive on IDE1 to slave mode by setting the jumper on the drive accordingly.

- **J10 (Secondary IDE Connector)**

The IDE2 controller can also support a master and a slave drive. The configuration is similar to IDE1. The second drive on this controller must be set to slave mode.

1.3.4 Floppy Disk Connector : J12

The motherboard provides a standard floppy disk connector (FDC) that supports 360K, 720K, 1.2M, 1.44M and 2.88M floppy disk types. This connector supports the provided floppy drive ribbon cables.

1.4 Back Panel Connectors

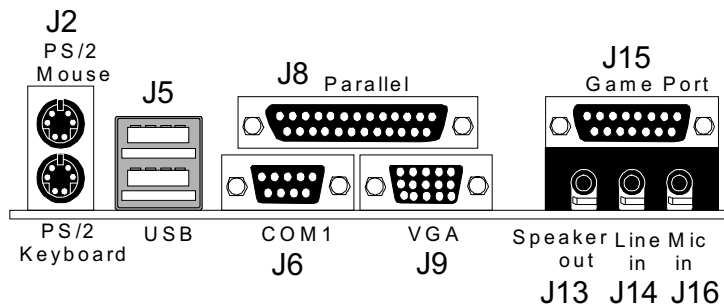

1.4.1 PS/2 Mouse / Keyboard Connector: J2

The motherboard provides a standard PS/2 mouse / Keyboard mini DIN connector for attaching a PS/2 mouse. You can plug a PS/2 mouse / Keyboard directly into this connector. The connector location and pin definition are shown below:

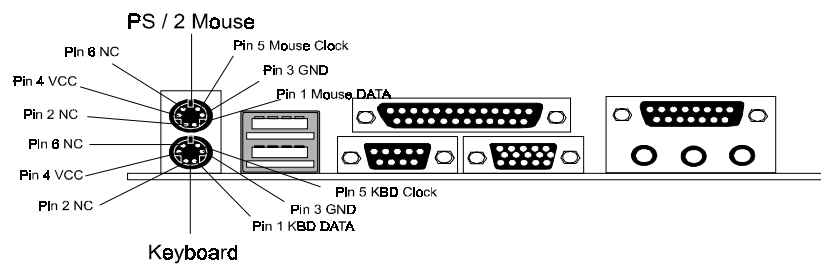

PS/2 Mouse / Keyboard Connectors

Pin	Signal Name
1	Data
2	No connect
3	Ground
4	+5 V (fused)
5	Clock
6	No connect

1.4.2 USB Connectors: J5

The motherboard provides a **UHCI (Universal Host Controller Interface) Universal Serial Bus roots** for attaching USB devices such as: keyboard, mouse and other USB devices. You can plug the USB Devices directly into this onnector.

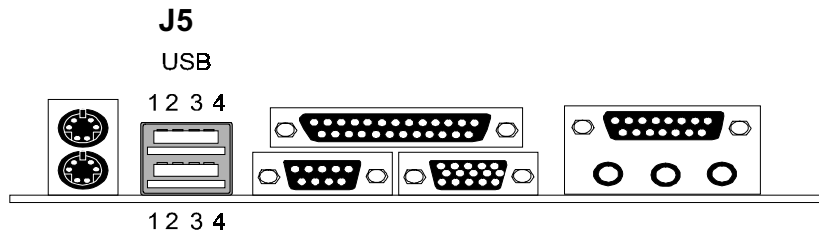
**Stacked USB Connectors**

Pin	Signal Name
1	+5 V (fused)
2	USBP0- [USBP1-]
3	USBP0+ [USBP1+]
4	Ground

Note: (1) Signal names in brackets ([]) are for USB port 1.

1.5 Serial and Parallel Interface Ports

This system comes equipped with two serial ports and one parallel port. Both types of interface ports will be explained in this chapter.

The Serial Interface Port-I : COM1

The serial interface port is sometimes referred to as an RS-232 port or an asynchronous communications port. Mice, printers, modems and other peripheral devices can be connected to a serial port. The serial port can also be used to connect your computer with another computer system. If you wish to transfer the contents of your hard disk to another system it can be accomplished by using each machine's serial port.

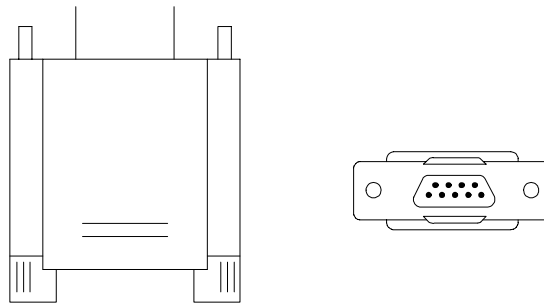

The serial ports on this system have two 9-pin connector. Some older computer systems and peripherals used to be equipped with only one 25-pin connector. Should you need to connect your 9-pin serial port to an older 25-pin serial port, you can purchase a 9-to-25 pin adapter.

Connectivity

The serial port can be used many ways, and it may be necessary to become familiar with the pin-out diagram. The following chart gives you the function of each pin on the 9-pin connector and some of the 25-pin connector. This information can be used when configuring certain software programs to work with the serial port.

Signal	Name	DB9 PIN	DB25 PIN
DCD	Data Carrier Detect	1	8
RX	Receive Data	2	3
TX	Transmit Data	3	2
DTR	Data Terminal Ready	4	20
GND	Signal Ground	5	7
DSR	Data Set Ready	6	6
RTS	Request to Send	7	4
CTS	Clear to Send	8	5
RI	Ring Indicator	9	22

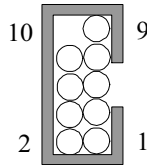
The Serial Interface Port-II : COM2

Signal	Name	IDC PIN
DCD	Data Carrier Detect	1
RX	Receive Data	2
TX	Transmit Data	3
DTR	Data Terminal Ready	4
GND	Signal Ground	5
DSR	Data Set Ready	6
RTS	Request to Send	7
CTS	Clear to Send	8
RI	Ring Indicator	9

Special Applications

There are two types of serial devices that can be connected to a serial port. One of the devices is called “DTE” (Data Terminal Equipment) and the other device is called “DCE” (Data Communications Equipment). If a modem is connected to a computer, for example, the modem is called the DCE and the computer is called the DTE. In situations such as this, the pins on the serial ports can be connected straight through.

In instances when there are two DTE devices connected together, such as a computer and a printer, a special adapter called a “Null Modem” is needed to make communication between the two devices possible.

When using the serial port to communicate between devices, one problem in particular may arise. Some manufacturers use one set of signals to begin communication with another device and other manufacturers do not use these

signals to initiate communication. If you encounter a communication problem that cannot be resolved using a null modem, it can generally be assumed that one device is using the initialization signals and the other device is not. This can usually be resolved by wiring the RTS, CTS, and DCD pins together.

Serial Ports/COM Ports

The two serial ports on the computer are called COM1 and COM2, respectively. If you wish, two more serial ports can be added onto the computer using optional hardware. Should you choose to add the extra Serial ports (COM ports) they would be called COM3 and COM4.

When using serial ports to communicate with a peripheral device, be sure to assign only one COM port number to each device. For example, if a printer and a scanner are both connected to your computer through serial ports, the printer must be assigned one COM port (i.e. COM1) and the scanner must be assigned the other COM port (i.e. COM2). No two devices can be assigned to one COM port. Each peripheral must have its own COM port.

NOTE: Four serial ports may be installed on the computer. However, no more than two ports can be used simultaneously.

*If you have installed an internal modem, be careful not to assign a COM port number that has already been assigned to another device. This error is common.

When installing a device that is going to require the use of a serial port, use a diagnostic program to find out which ports are available. It may be necessary to remove expansion cards that have serial ports in order to check their jumper settings. The jumper settings will indicate which COM port the card has been assigned. Checking the expansion card will eliminate mistakes in overlapping COM ports. Once you have completed the installation of peripheral devices using the serial ports, be sure that the communication parameters such as baud rate, parity bit, etc. are matching. If your computer is set for a baud rate of 9600 and your modem is set for a baud rate of 2400 you will not be able to send messages. The manuals that accompany the peripheral devices will inform you on the procedure for setting their parameters. Software manuals also have instructions on setting parameters.

Parallel Interface Port : J8

Unlike the serial port, parallel interface ports have been standardized and should not present any difficulty interfacing peripherals to your system. Sometimes called a Centronics port, the parallel port is almost exclusively used with printers. The parallel port on your system has a 25-pin, DB25 connector (see picture below). The pin-out for the parallel port are shown in the table below.

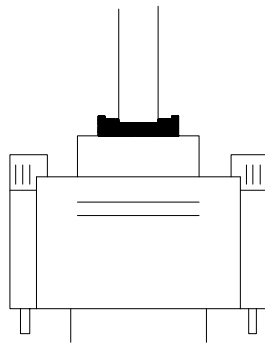
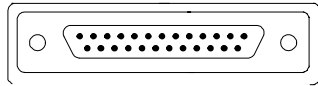

Signal	Pin
-Strobe	1
Data 0	2
Data 1	3
Data 2	4
Data 3	5
Data 4	6
Data 5	7
Data 6	8
Data 7	9
-Ack	10
Busy	11
Paper Empty	12
+Select	13
-Auto FDXT	14
-Error	15
-Init	16
-SLCTN	17
Ground	18
Ground	19
Ground	20
Ground	21
Ground	22
Ground	23
Ground	24
Ground	25

1.6 CPU Installation

1.6.1 CPU Installation Procedure: Socket 370

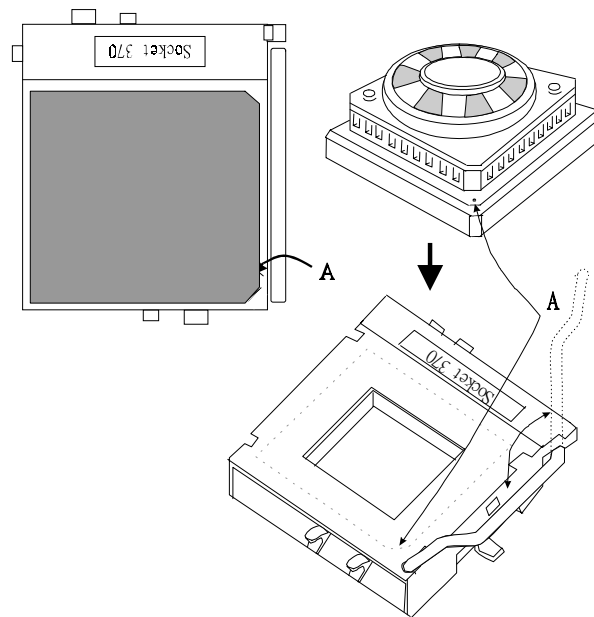

1. Pull the lever sideways away from the socket then raise the lever up to a 90-degree angle.
2. Locate Pin A in the socket and look for the white dot or cut edge in the CPU. Match Pin A with the white dot/cut edge then insert the CPU.
3. Press the lever down to complete the installation.

1.6.2 CPU Installation Procedure : Slot 1

Motherboard

The M6TWG motherboard provides one Single Edge Contact (SEC) slot. This slot allows you to install a Pentium® II / Pentium® !!! CPU.

Before you use:

Please look on your motherboard and locate the CPU fan and CPU fan power supply. Please verify that this fan is directly used to cool the CPU and its heat sink, as well as to cool the motherboard and circulate the air.

WARNING : If air circulation is insufficient, the CPU will overheat, which may damage the CPU, CPU slot, and the motherboard.

Please inspect your motherboard to see if it has the Celeron® and Pentium® II / Pentium® !!! CPU retention kit components. (ATTENTION: The CPU installation component color and shape may vary slightly based on kits coming from different suppliers.)

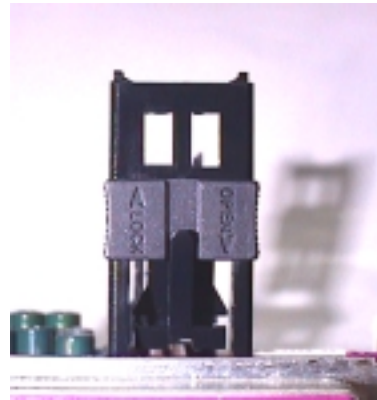

M6TWG CPU Special Installation and Setup :**Install Pentium® II / Pentium® !!! / Celeron® :****1 · Installing the Heat Sink Support Frame :**

The Heat Sink Support Base can only be inserted one-way. Please match the leg sizes on the Heat Sink Support Base to the holes on the motherboard. Please insert the screws from the bottom of the motherboard and tighten into the rounded screw covers.

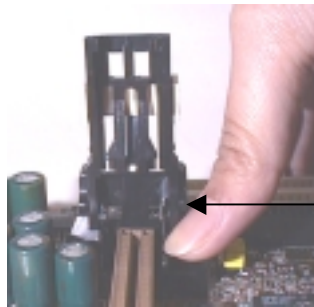

Lock in

2 · Installing the CPU Heat sink :

Take the smooth side of the Heat Sink and bind it closely together with the CPU. Next, at the ends of the Heat Sink, clip the CPU together with the Heat Sink. Please verify that there is no space between the Heat Sink and CPU unit. **WARNING:** If there is any space between the CPU and Heat Sink, the CPU will over-heat severely and may be damaged.

Attach the metal clips at ends of the CPU unit

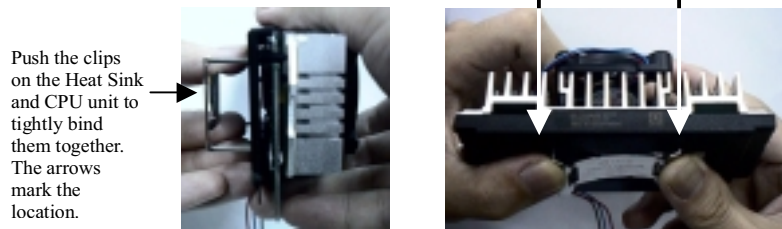

3 · Insert the CPU into the SEC Solt :

- (1) First, press the CPU unit into the Frame until it fits snugly into the notch holes. Then, clip the Heat Sink and CPU together with the Heat Sink Support Frame.

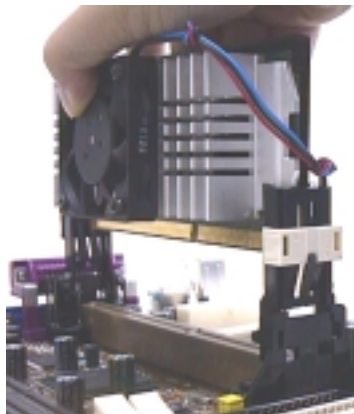

The correct direction to insert the Heat Sink and CPU into the Heat Sink Support Frame should allow you to easily insert them.

- (2) Pushing the CPU unit into the frame, wait until the CPU unit is firmly in position before securing. The notches are pushed out. They will fit ightly into the H at Sink Frame Notch holes.

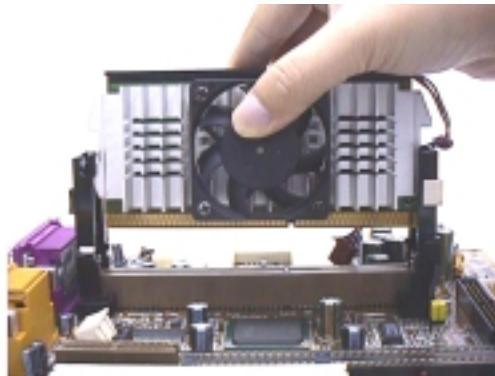

← The notches on the CPU unit are

- (2) Firmly secure the Heat Sink by attaching the Heat Sink Frame TOP-Bar. Please verify that the Heat Sink and CPU are tightly pressed together. Please check that the entire Frame, Heat Sink, and CPU unit are tightly installed and that there is no possible movement or looseness in the assembly.

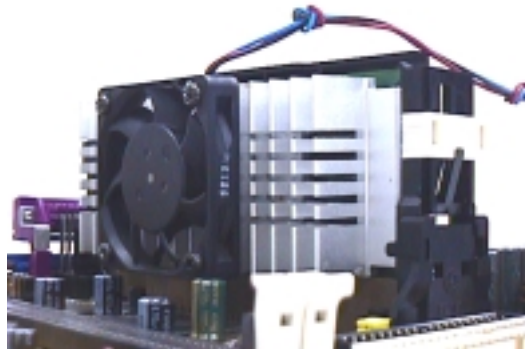

1.7 Jumper Settings

The jumper has two or more pins that can be covered by a plastic jumper cap, enabling you to select different system options.

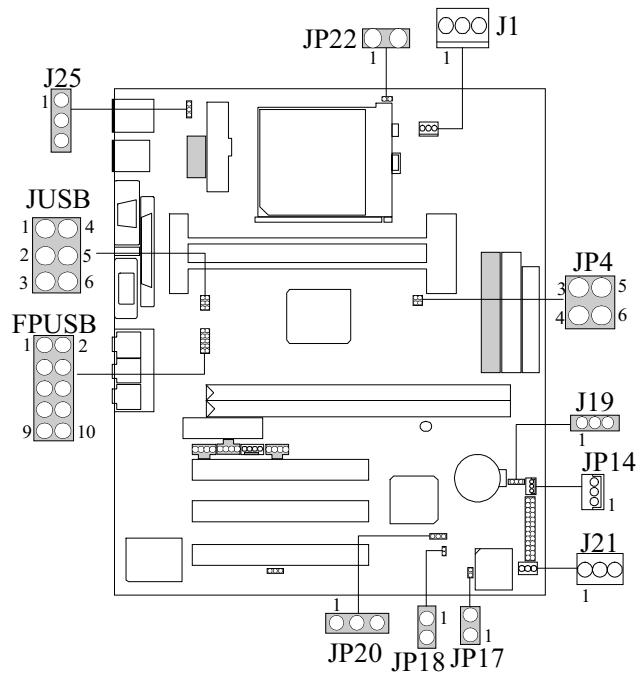

1.7.1 CPU Fan Connector: J1

Pin No.	Assignment
1	Control Pin
2	+12V
3	Sense

1.7.2 Sound AC'97 CODEC Selection: J19

Pin No.	Signal Name
1-2	On-Board CODEC Selected
2-3	On Riser card CODEC Selected
OPEN	When U23 Mounted with AU8810

Note: Please also setting the CODEC device on AMR card to "Primary" when U23 is mounted with AU8810.

1.7.3 System Fan Connector: J21 (Optional)

Pin No.	Assignment
1	Control Signal
2	+12V
3	Senser Input

1.7.4 Keyboard/Mouse Power Selection: J25 (Optional)

Pin No.	Assignment
1-2	+5VSB
2-3	+5V

1.7.5 Manufacture Setting: JP4 (Ver: 1.1A / 1.2 /1.3)

Frequency	JP4 (Pin3-4)	JP4 (Pin5-6)
66MHz	CLOSE	CLOSE
100MHz	OPEN	CLOSE

Note : Please setting the Front Side Bus Frequency when U10 is mounted with ICS9248BF-96.

Frequency	JP4 (Pin1-2)	JP4 (Pin3-4)
66MHz	OPEN	OPEN
100MHz	CLOSE	CLOSE

Note : Please setting the Front Side Bus Frequency when U10 is mounted with ICS9248BF-73.

1.7.6 Wake-On-LAN Connector: JP14

Pin No.	Assignment
1	+ 5V Standby Voltage
2	Ground
3	Wakeup Signal Input

1.7.7 FWH (BIOS) Lock/Unlock Connector: JP17

Pin No.	Assignment
Open	BIOS Boot Block write Inhibited
Closed	BIOS Boot Block Writeable

1.7.8 Wake-On-Ring Connector: JP18

Pin No.	Assignment
1	Ring-In Signal
2	GND

1.7.9 CMOS Function Selection: JP20

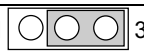
JP20	Assignment
 1-2 Closed	Normal operation (default)
 2-3 Closed	Clear CMOS data

1.7.10 Socket 370 & Slot 1 Selection: JP22

Pin No.	Assignment
Open	Socket 370 CPU
Close	Slot 1 CPU

1.7.11 USB Jumper Block: JUSB (Optional, Ver1.2)

Pin	Signal Name	Pin	Signal Name
1	FNT_USB0#	4	FNT_USB0
2	USB0H#	5	USB0H
3	BCK_USB0#	6	BCK_USB0

1.7.12 Front Panel USB: FPUSB (Optional, Ver1.2)

Pin	Signal Name	Pin	Signal Name
1	N/C	2	+5V
3	GROUND	4	N/C
5	N/C	6	FNT_USBP0
7	GROUND	8	FNT_USBP0#
9	GROUND	10	Pin Removed as keyed pin

1.8 DRAM Installation

1.8.1 DIMM

DRAM Access Time: 3.3V unbuffered PC 100 SDRAM required.

DRAMType: 8MB/16MB/32MB/64MB/128MB/256MB DIMM Module (168pin)

Total Memory Size (MB)	Bank 0 DIMM 1	Bank 1 DIMM 2
8 M	8M x 1 pc	----
16 M	16M x 1 pc	----
32 M	32M x 1 pc	----
64 M	64M x 1 pc	----
128 M	128M X 1pc	----
256 M	256M X 1pc	----
16 M	8M x 1 pc	8M x 1 pc
24 M	16M x 1 pc	8M x 1 pc
40 M	32M x 1 pc	8M x 1 pc
72 M	64M x 1 pc	8M x 1 pc
136 M	128M x 1 pc	8M x 1 pc
256 M	256M x 1 pc	8M x 1 pc
24 M	8M x 1 pc	16M x 1 pc
32 M	16M x 1 pc	16M x 1 pc
48 M	32M x 1 pc	16M x 1 pc
80 M	64M x 1 pc	16M x 1 pc
144 M	128M x 1 pc	16M x 1pc
256 M	256M x 1 pc	16M x 1pc
40 M	8M x 1 pc	32M x 1 pc
48 M	16M x 1 pc	32M x 1 pc
64 M	32M x 1 pc	32M x 1 pc
96 M	64M x 1 pc	32M x 1 pc
160 M	128M x 1 pc	32M x 1pc
256 M	256M x 1 pc	32M x 1pc
72 M	8M x 1 pc	64M x 1 pc
80 M	16M x 1 pc	64M x 1 pc
96 M	32M x 1 pc	64M x 1 pc
128 M	64M x 1 pc	64M x 1 pc
192 M	128M x 1 pc	64M x 1pc
256 M	256M x 1 pc	64M x 1pc
256 M	128M x 1 pc	128M x 1pc
512 M	256M x 1 pc	256M x 1pc

Note: Don't stuff or remove the DIMM memory, If the LED1 is lighting.

1.9 Audio Subsystem

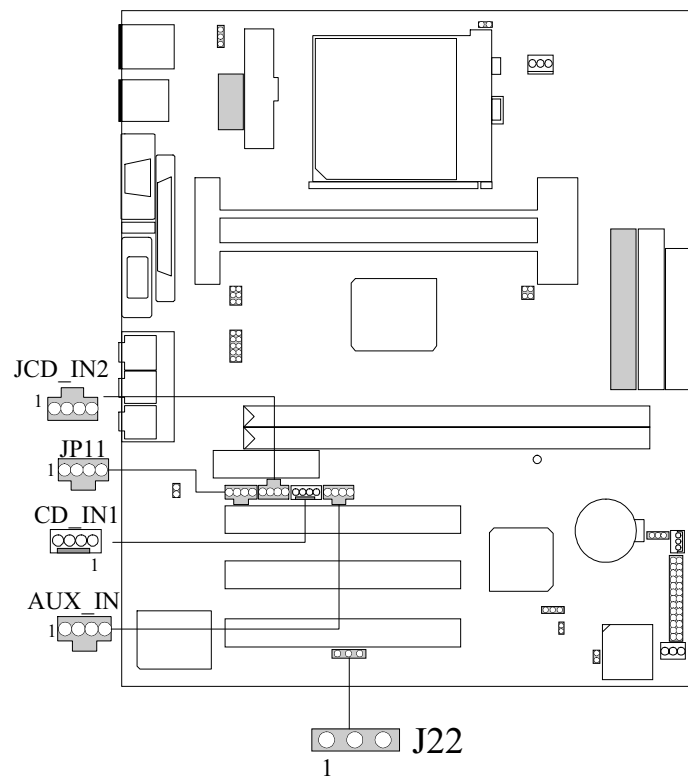

1.9.1 CD Audio-In Connectors: CD_IN1/JCD_IN2

Pin No. of JCD_IN2	Assignment
1	Right Channel Input
2	GND
3	GND
4	Left Channel Input

Pin No. of CD_IN1	Assignment
1	Left Channel Input
2	GND
3	Right Channel Input
4	GND

1.9.2 Telephony Connector: JP11

Pin No.	TAD
1	MONO_IN
2	GND
3	GND
4	MONO_OUT

1.9.3 AUX Audio in Connector : AUX_IN (Optional)

Pin No.	Signal Name
1	Left channel AUX_IN
2	GND
3	GND
4	Right channel AUX_IN

1.9.4 Digital Speaker Out Connector : J22 (Optional)

Pin No.	Signal Name
1	Digital Speaker Signal
2	+5v
3	GND

2. BIOS Setup

Introduction

This manual discussed Award™ Setup program built into the ROM BIOS. The Setup program allows users to modify the basic system configuration. This special information is then store in battery-backed RAM so that it retains the Setup information when the power is turned off.

The Award BIOS™ installed in your computer system's ROM (Read Only Memory) is a custom version of an industry standard BIOS. This means that it supports Intel processors input/output system. The BIOS provides critical low-level support for standard devices such as disk drives and serial and parallel ports.

Adding important has customized the Award BIOS™, but nonstandard, features such as virus and password protection as well as special support for detailed fine-tuning of the chipset controlling the entire system.

The rest of this manual is intended to guide you through the process of configuring your system using Setup.

Plug and Play Support

These AWARD BIOS supports the Plug and Play Version 1.0A specification. ESCD (Extended System Configuration Data) write is supported.

EPA Green PC Support

This AWARD BIOS supports Version 1.03 of the EPA Green PC specification.

APM Support

These AWARD BIOS supports Version 1.1&1.2 of the Advanced Power Management (APM) specification. Power management features are implemented via the System Management Interrupt (SMI). Sleep and Suspend power management modes are supported. Power to the hard disk drives and video monitors can be managed by this AWARD BIOS.

PCI Bus Support

This AWARD BIOS also supports Version 2.1 of the Intel PCI (Peripheral Component Interconnect) local bus specification. Please see the Intel technical documentation for additional information.

DRAM Support

SDRAM (Synchronous DRAM) are supported.

Supported CPUs

This AWARD BIOS supports a single Intel Celeron™ CPU. Dual CPUs are not supported.

Using Setup

In general, you use the arrow keys to highlight items, press <Enter> to select, use the PageUp and PageDown keys to change entries, press <F1> for help and press <Esc> to quit. The following table provides more detail about how to navigate in the Setup program using the keyboard.

Keystroke	Function
Up arrow	Move to previous item
Down arrow	Move to next item
Left arrow	Move to the item on the left (menu bar)
Right arrow	Move to the item on the right (menu bar)
Esc	Main Menu: Quit without saving changes Submenus: Exit Current page to the next higher level menu
Move Enter	Move to the item you desired
PgUp key	Increase the numeric value or make changes
PgDn key	Decrease the numeric value or make changes
+ Key	Increase the numeric value or make changes
- Key	Decrease the numeric value or make changes
Esc key	Main Menu – Quit and not save changes into CMOS Status Page Setup Menu and Option Page Setup Menu – Exit Current page and return to Main Menu
F1 key	General help on Setup navigation kdys
F5 key	Load previous values from CMOS
F6 key	Load the fail-safe defaults from BIOS default table
F7 key	Load the optimized defaults
F10 key	Save all the CMOS changes and exit

2.1 Main Menu

Once you enter Award BIOS™ CMOS Setup Utility, the Main Menu will appear on the screen. The Main Menu allows you to select from several setup functions and two exit choices. Use the arrow keys to select among the items and press <Enter> to accept and enter the sub-menu.

!! WARNING !!

The information about BIOS defaults on manual (**Figure 1,2,3,4,5,6,7,8**) is just for reference, please refer to the BIOS installed on board, for update information.

■ **Figure 1. Main Menu**

CMOS Setup Utility-Copyright (C) 1984-2000 Award Software

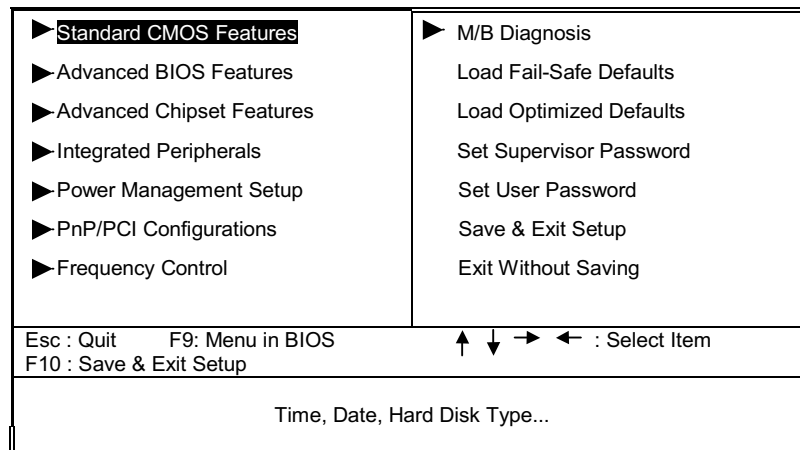

Standard CMOS Features

This setup page includes all the items in a standard compatible BIOS.

Advanced CMOS Features

This setup page includes all the items of BIOS special enhanced features.

Advanced Chipset Features

This setup page includes all the items of chipset special features.

Integrated Peripherals

This section page includes all the items of IDE hard drive and Programmed Input/Output features.

Power Management Setup

This setup page includes all the items of power management features.

PnP/PCI Configurations

This setup page includes IRQ Setting by user define or default.

Frequency Control

This setup page includes the CPU Host frequency and CPU Ratio.

M/B Diagnosis (Optional)

This setup page induces the several system diag functions.

Load Fail-Safe Defaults

Use this menu to load the BIOS default values for the minimal/stable performance for your system to operate.

Load Optimized Defaults

These settings are more likely to configure a workable computer when something is wrong. If you cannot boot the computer successfully, select the BIOS Setup options and try to diagnose the problem after the computer boots. These settings do not provide optimal performance.

Set Supervisor Password

Change, set, or disable password. It allows you to limit access to the system and Setup, or just to Setup.

Set User Password

You can specify both a User and a Supervisor password. When you select either password option, you are prompted for a 1-6-character password. Enter the password and then retype the password when prompted.

Save & Exit Setup

Save CMOS value changes to CMOS and exit setup.

Exit Without Saving

Abandon all CMOS value changes and exit setup.

2.2 Standard CMOS Features

The items in Standard CMOS Setup Menu are divided into 10 categories. Each category includes no, one or more than one setup items. Use the arrow keys to highlight the item and then use the <PgUp> or <PgDn> keys to select the value you want in each item.

■ Figure 2. Standard CMOS Setup

CMOS Setup Utility-Copyright (C) 1984-2000 Award Software
Standard CMOS Features

Date (mm:dd:yy)	Tue, Apr 27 1999	Item Help
Time (hh:mm:ss)	11 : 37 : 30	Menu Level ▶
▶ IDE Primary Master	Press Enter None	Change the day, month year and century.
▶ IDE Primary Slave	Press Enter None	
▶ IDE Secondary Master	Press Enter None	
▶ IDE Secondary Slave	Press Enter None	
Drive A	1.44M, 3.5 in	
Drive B	None	
Video	EGA/VGA	
Halt On	All, But Keyboard	
Base Memory	XXXX	
Extended Memory	XXXX	
Total Memory	XXXX	

↑ ↓ → ← : Move Enter :Select +/-/PU/PD :Value F10 :Save ESC :Exit F1 :General Help
F5 :Previous Values F6 :Fail-Safe Defaults F7 : Optimized Defaults

Main Menu Selections

This table shows the selections that you can make on the Main Menu.

Item	Options	Description
Date	MoTh DD YYYY	Set the system date. Note That the 'Day' automatically changes when you set the date.
IDE Primary Master	Options are in its sub menu.	Press <Enter> to enter the sub menu of detailed options
IDE Primary Slave	Options are in its sub menu.	Press <Enter> to enter the sub menu of detailed options.
IDE Secondary Master	Options are in its sub menu.	Press <Enter> to enter the sub menu of detailed options.
IDE Secondary Slave	Options are in its sub menu.	Press <Enter> to enter the sub menu of detailed options.
Drive A Drive B	None 360K, 5.25 in 1.2M, 5.25 in 720K, 3.5 in 1.44M, 3.5 in 2.88M, 3.5 in	Select the type of floppy disk drive installed in your system.
Video	EGA/VGA CGA 40 CGA 80 MONO	Select the default video device.

Item	Options	Description
Halt On	All Errors No Errors All, but Keyboard All, but Diskette All, but Disk/Key	Select the situation in which you want the BIOS to stop the POST process and notify you.
Base Memory	N/A	Displays the amount of conventional memory detected during boot up.
Extended Memory	N/A	Displays the amount of extended memory detected during boot up.
Total Memory	N/A	Display the total memory available in the system.

Virus Warning

Allows you to choose the VIRUS Warning feature for IDE Hard Disk boot sector protection. If this function is enabled and someone attempts to write data into this area, BIOS will show a warning message on screen and alarm beep.

Disabled (default)	No warning message appears when anything attempts to access the boot sector or hard disk partition table.
Enabled	Activates automatically when the system boots up causing a warning message to appear when anything attempts to access the boot sector of hard disk partition table.

CPU Internal /External Cache

These two categories speed up memory access. However, it depends on CPU/chipset design.

Enabled (default)	Enable cache
Disabled	Disable cache

CPU L2 Cache ECC Checking

This item allows you to enable/disable CPU L2 Cache ECC checking.

The Choices: Enabled (default), Disabled.

Quick Power On Self Test

This category speeds up Power on Self-Test (POST) after you power up the computer. If it is set to Enable, BIOS will shorten or skip some check items during POST.

Enabled (default)	Enable quick POST
Disabled	Normal POST

First /Second/Third/Other Boot Device

These BIOS attempts to load the operating system from the devices in the sequence selected in these items.

The Choices: Floppy, LS/ZIP, HDD SCSI, CDROM, Enabled.

Swap Floppy Drive

If the system has two floppy drives, you can swap the logical drive name assignments.

The Choices: Enabled, Disabled (default).

Boot Up Floppy Seek

Seeks disk drives during boot up. Disabling speeds boot up.

The Choices: Enabled (default), Disabled.

Boot Up NumLock Status

Select power on state for NumLock.

On (default) Numpad is number keys.

Off Numpad is arrow keys.

Gate A20 Option

Select if chipset or keyboard controller should control GateA20.

Normal A pin in the keyboard controller controls GateA20.

Fast (default) Lets chipset control GateA20.

Typematic Rate Setting

Keystroke repeat at a rate determined by the keyboard controller. When enabled, the typematic rate and typematic delay can be selected.

The Choices: Enabled, Disabled (default).

Typematic Rate (Chars/Sec)

Sets the number of times a second to repeat a keystroke when you hold the key down.

The Choices: 6 (default), 8, 10, 12, 15, 20, 24, 30.

Typematic Delay (Msec)

Sets the delay time after the key is held down before it begins to repeat the keystroke.

The Choices: 250 (default), 500, 750, 1000.

Security Option

Select whether the password is required every time the system boots or only when you enter setup.

System

The system will not boot and access to Setup will be denied if the correct password is not entered at the prompt.

Setup (default)

The system will boot, but access to Setup will be denied if the correct password is not entered at the prompt.

***Note:** To disable security, select **PASSWORD SETTING** at Main Menu and then you will be asked to enter password. Do not type anything and just press <Enter>, it will disable security. Once the security is disabled, the system will boot and you can enter Setup freely.*

OS Selection for DRAM > 64MB

Select the operating system that is running with greater than 64MB of RAM on the system.

The Choices: Non-OS2 (default), OS2.

Report No FDD For WIN 95

Whether report no FDD for Win 95 or not.

The Choices: Yes, No (default).

2.4 Advanced Chipset Features

This section allows you to configure the system based on the specific features of the installed chipset. This chipset manages bus speeds and access to system memory resources, such as DRAM and the external cache. It also coordinates communications between the conventional PCI bus. It must be stated that these items should never need to be altered. The default settings have been chosen because they provide the best operating conditions for your system. The only time you might consider making any changes would be if you discovered that data was being lost while using your system.

■ Figure 4. Advanced Chipset Setup

CMOS Setup Utility-Copyright (C) 1984-2000 Award Software
Advanced Chipset Features

SDRAM CAS Latency Time	3	Item Help
SDRAM Cycle Time Tras/Trc	6/8	
SDRAM RAS-to-CAS Delay	3	Menu Level ▶
SDRAM RAS Precharge Time	3	
System BIOS Cacheable	Enabled	
Video BIOS Cacheable	Enabled	
Memory Hole At 15M-16M	Disabled	
Delayed Transaction	Enabled	
On-Chip Video Window Size	64MB	
* Onboard Display Cache Setting *		
CAS# Latency	3	
Paging Mode Control	Close	
RAS-to -CAS Override	by CAS# LT	
RAS# Timing	Slow	
RAS# Precharge Timing	Slow	

↑ ↓ → ← : Move Enter :Select +/-/PU/PD :Value F10 :Save ESC :Exit F1 :General Help
 F5 :Previous Values F6 :Fail-Safe Defaults F7 : Optimized Defaults

SDRAM CAS Latency Time

When synchronous DRAM is installed, the number of clock cycles of CAS latency depends on the DRAM timing.

The Choices: 2, 3 (default)

SDRAM Cycle Time Tras/Trc

Select the number of SCLKs for an access cycle.

The Choices: 5/7, 6/8 (default).

SDRAM RAS-to-CAS Delay

This field lets you insert a timing delay between the CAS and RAS strobe signals, used when DRAM is written to, read from, or refreshed. *Fast* gives faster performance; and *Slow* gives more stable performance. This field applies only when synchronous DRAM is installed in the system.

The Choices: 2, 3 (default)

SDRAM RAS Precharge Time

If an insufficient number of cycles is allowed for RAS to accumulate its charge before DRAM refresh, the refresh may be incomplete and the DRAM may fail to retain data. *Fast* gives faster performance; and *Slow* gives more stable performance. This field applies only when synchronous DRAM is installed in the system.

The Choices: 2, 3 (default)

System BIOS Cacheable

Selecting *Enabled* allows caching of the system BIOS ROM at F0000h-FFFFFh, resulting in better system performance. However, if any program writes to this memory area, a system error may result.

The Choices: *Enabled* (default), *Disabled*.

Video BIOS Cacheable

Select *Enabled* allows caching of the video BIOS, resulting in better system performance. However, if any program writes to this memory area, a system error may result.

The Choices: *Enabled* (default), *Disabled*.

Memory Hole At 15M-16M

You can reserve this area of system memory for ISA adapter ROM. When this area is reserved, it cannot be cached. The user information of peripherals that need to use this area of system memory usually discusses their memory requirements.

The Choices: Enabled, Disabled (default)

Delayed Transaction

The chipset has an embedded 32-bit posted write buffer to support delay transactions cycles. Select *Enabled* to support compliance with PCI specification version 2.1.

The Choices: Enabled (default), Disabled

On-Chip Video Window Size

Select the on-chip video window size for VGA drive use.

The Choices: 32MB, 64MB(default), Disabled.

CAS# Latency (Optional)

Select the local memory clock periods.

The Choices: 2, 3 (default)

Paging Mode Control (Optional)

Select the paging mode control.

Open

In this mode the GMCH memory controller tends to leave pages open.

Close (default)

In this mode the GMCH memory controller tends to leave pages closed.

RAS-to-CAS Override (Optional)

Select the display cache clock periods control.

By CAS# LT (default)

RAS# Timing (Optional)

This item controls RAS# active to Protegra, and refresh to RAS# active delay (in local memory clock).

Slow (default)

RAS# Precharge Timing (Optional)

This item controls RAS# precharge (in local memory clocks).

Slow (default)

2.5 Integrated Peripherals

■ Figure 5. Integrated Peripherals

CMOS Setup Utility-Copyright (C) 1984-2000 Award Software
Integrated Peripherals

On-Chip Primary PCI IDE	Enabled	▲ ▼	Item Help
On-Chip Secondary PCI IDE	Enabled		Menu Level ►
IDE Primary Master PIO	Auto		
IDE Primary Slave PIO	Auto		
IDE Secondary Master PIO	Auto		
IDE Secondary Slave PIO	Auto		
IDE Primary Master UDMA	Auto		
IDE Primary Slave UDMA	Auto		
IDE Secondary Master UDMA	Auto		
IDE Secondary Slave UDMA	Auto		
USB Controller	Enabled		
USB Keyboard Support	Disabled		
Init Display First	PCI Slot		
AC97 Audio	Enabled		
AC97 Modem	Disabled		
IDE HDD Block Mode	Enabled		
Onboard FDC Controller	Enabled		
Onboard Serial Port 1	3F8/IRQ4		
Onboard Serial Port 2	2F8/IRQ3		
UART Mode Select	Normal		
X UR2 Duplex Mode	Half		
X TxD, RxD Polarity Active	Lo, Lo		
X Use IR Pins	IR-Rx2Tx2		
Onboard Parallel Port	378/IRQ7		
Parallel Port Mode	EPP1.9+SPP		
X ECP Mode Use DMA	3		
Game Port Address	201		
Midi Port Address	330		
X Midi Port IRQ	5		

▲ : Move Enter : Select +/-/PU/PD : Value F10 : Save ESC : Exit F1 : General Help
 F5 : Previous Values F6 : Fail-Safe Defaults F7 : Optimized Defaults

On-Chip Primary /Secondary PCI IDE

The integrated peripheral controller contains an IDE interface with support for two IDE channels. Select Enabled to activate each channel separately.

The Choices: Enabled (default), Disabled

IDE Primary / Secondary Master / Slave PIO

The IDE PIO (Programmed Input / Output) fields let you set a PIO mode (0-4) for each of the IDE devices that the onboard IDE interface supports. Modes 0 through 4 provide successively increased performance. In Auto mode, the system automatically determines the best mode for each device.

The Choices: Auto (default), Mode0, Mode1, Mode2, Mode3, Mode4.

IDE Primary / Secondary Master / Slave UDMA

Ultra DMA /33 implementation is possible only if your IDE hard drive supports it and the operating environment includes a DMA drive (Windows 95 OSR2 or a third party IDE bus master driver). If your hard drive and your system software both support Ultra DMA/33 & DMA/66, select Auto to enable BIOS support.

The Choices: Auto (default), Disabled.

USB Controller

Select *Enabled* if your system contains a Universal Serial Bus (USB) controller and you have USB peripherals.

The Choices: Enabled (default), Disabled.

USB Keyboard Support

The default value is Disabled.

Enabled	Enable USB Keyboard Support.
Disable (default)	Disable USB Keyboard Support.

Init Display First

This item allows you to decide to active whether PCI Slot or on-chip VGA first.

The Choices: PCI Slot (default), AGP.

AC97 Audio/Modem

This item allows you to decide to enable/disable the 810-chipset family to support AC97 Audio/Modem.

The Choices: Enabled, Disabled.

IDE HDD Block Mode

Block mode is also called block transfer, multiple commands, or multiple sector read/write. If your IDE hard drive supports block mode (most new drives do), select Enabled for automatic detection of the optimal number of block mode (most new drives do), select Enabled for automatic detection of the optimal number of block read/writes per sector the drive can support.

The Choices: Enabled (default), Disabled.

Onboard FDC Controller

Select Enabled if your system has a floppy disk controller (FDC) installed on the system board and you wish to use it. If install and FDC or the system has no floppy drive, select Disabled in this field.

The Choices: Enabled (default), Disabled.

Onboard Serial Port 1/Port 2

Select an address and corresponding interrupt for the first and second serial ports.

The Choices: Disabled, Auto, (3F8/IRQ4), (2F8/IRQ3), (3E8/ IRQ4), (2E8 / IRQ3)

UART Mode Select

This item allows you to determine which Infra Red (IR) function of onboard I/O chip.

The Choices: Normal (default), AS KIR, IrDA.

UR2 Duplex Mode

Select the value required by the IR device connected to the IR port. Full-duplex mode permits simultaneous two-direction transmission. Half-duplex mode permits transmission in one direction only at a time.

The Choices: Half (default), Full.

TxD, RxD Polarity Active

This item allows you to determine the active of RxD, TxD

The Choices: “Hi, Hi”, “Lo, Lo” (default) , “Lo, Hi”, “Hi, Lo”.

Use IR Pins

Consult your IR peripheral documentation to select the correct setting of the TxD and RxD signals.

The Choices: IR-Rx2Tx2 (default), RxD2 TxD2.

Onboard Parallel Port

This item allows you to determine access onboard parallel port controller with which I/O Address.

The Choices: 378/IRQ7 (default), 278/IRQ5, 3BC/IRQ7, Disabled.

Parallel Port Mode

The default value is EPP1.9+SPP.

SPP	Using Parallel port as Standard Printer Port.
EPP1.9+SPP (default)	Using Parallel Port as Enhanced Parallel Port.
ECP	Using Parallel port as Extended Capabilities Port.
EPP1.9 +ECP	Using Parallel port as ECP & EPP mode.
PRINTER	Printer Mode.
EPP1.7+SPP	Using Parallel Port as Enhanced Parallel Port.
EPP1.7+ECP	Using Parallel port as ECP & EPP mode.

ECP Mode Use DMA

Select a DMA Channel for the port.

The Choices: 3 (default), 1.

Game Port Address

Game Port I/O Address.

Disable
201 (default)
209

Midi Port Address

Midi Port Base I/O Address.

Disabled
330 (default)
300

Midi Port IRQ

This determines the IRQ in which the Midi Port can use.

The Choices: 7, 5 (default).

2.6 Power Management Setup

The Power Management Setup allows you to configure your system to most effectively save energy while operating in a manner consistent with your own style of computer use.

■ Figure 6. Power Management Setup

CMOS Setup Utility-Copyright (C) 1984-2000 Award Software
Power Management Setup

ACPI Function	Enabled	Item Help
ACPI Suspend Type	S1 (POS)	
Power Management	User Define	Menu Level ▶
Video Off Method	DPMS	
Video Off In Suspend	Yes	
Suspend Type	Stop Grant	
MODEM Use IRQ	3	
Suspend Mode	Disabled	
HDD Power Down	Disabled	
Soft-Off by PWR-BTTN	Instant-Off	
Wake-Up by PCI card	Disabled	
Power On by Ring	Disabled	
Wake Up On LAN	Disabled	
CPU Thermal-Throttling	50.0 %	
Resume by Alarm	Disabled	
X Date (of Month) Alarm	0	
X Time (hh:mm:ss) Alarm	0 0 0	
** Reload Global Timer Events **		
Primary IDE 0	Enabled	
Primary IDE 1	Enabled	
Secondary IDE 0	Disabled	
Secondary IDE 1	Disabled	
FDD, COM, LPT Port	Enabled	
PCI PIRQ [A-D] #	Enabled	

↑ ↓ → ← : Move Enter :Select +/-/PU/PD :Value F10 :Save ESC :Exit F1 :General Help
 F5 :Previous Values F6 :Fail-Safe Defaults F7 : Optimized Defaults

ACPI Function

This item allows you to enable/disable the Advanced Configuration and Power Management (ACPI).

The Choices: Enabled (default), Disabled.

ACPI Suspend Type

The item allows you to select the suspend type under ACPI operating system.

S1 (POS) (default)	Power on Suspend
S3 (STR)	Suspend to RAM

Power Management

This category allows you to select the type (or degree) of power saving and is directly related to the following modes:

- 1.HDD Power Down.
- 2.Doze Mode.
- 3.Suspend Mode.

There are four selections for Power Management, three of which have fixed mode settings

Disabled	No power management. Disables all four modes.
Min. Power Saving	Minimum power management. Doze Mode = 1 hr. Standby Mode = 1 hr., Suspend Mode = 1 hr., and HDD Power Down = 15 min.
Max. Power Saving	Maximum power management—ONLY AVAILABLE FOR SL CPU's. Doze Mode = 1 min., Standby Mode = 1 min., Suspend Mode = 1 min., and HDD Power Down = 1 min.
User Define (default)	Allows you to set each mode individually. When not disabled, each of the ranges are from 1 min. to 1 hr. except for HDD Power Down which ranges from 1 min. to 15 min. and disable.

Video Off Method

This determines the manner in which the monitor is blanked.

V/H SYNC+Blank	This selection will cause the system to turn off the vertical and horizontal synchronization ports and write blanks to the video buffer.
Blank Screen	This option only writes blanks to the video buffer.
DPMS (default)	Initial display power management signaling.

Video Off In Suspend

This determines the manner in which the monitor is blanked.

The Choices: Yes (default), No.

Suspend Type

Select the Suspend Type.

The Choices: PWRON Suspend, Stop Grant (default).

MODEM Use IRQ

This determines the IRQ in which the MODEM can use.

The Choices: 1, 3 (default), 4, 5, 7, 9, 10, 11, NA.

Suspend Mode

When enabled and after the set time of system inactivity, all devices except the CPU will be shut off.

Disabled (default)

Enabled

HDD Power Down

When enabled and after the set time of system inactivity, the hard disk drive will be powered down while all other devices remain active.

Disabled (default)

Enabled

Soft-Off by PWR-BTTN

Pressing the power button for more than 4 seconds forces the system to enter the Soft-Off state when the system has "hung."

The Choices: Delay 4 Sec, Instant-Off (default)

Wake-Up by PCI card

When you select Enabled, a PME signal from PCI card returns the system to Full On state.

The Choice: Enabled, Disabled (default).

Power On by Ring

An input signal on the serial Ring Indicator (RI) line (in other words, an incoming call on the modem) awakens the system from a soft off state.

Disabled (default)

Wake Up On LAN

To use this function, you need a LAN add-on card which support power on functions. It should also support the wake-up on LAN jumper.

Disabled (default) Wake up on LAN not supported.

CPU Thermal-Throttling

Select the CPU THRM-Throttling rate.

The Choices: 25.0%, 37.5%, 50.0% (default), 62.5%, 75.0%, 87.5%.

Resume by Alarm

This function is for setting date and time for your computer to boot up. During Disabled, you cannot use this function. During Enabled, Choose the Date and Time Alarm:

Date (of month) Alarm You can choose which month the system will boot up.

Time (hh:mm:ss) Alarm You can choose what hour, minute and second the system will boot up.

***Note:** If you have change the setting, you must let the system boot up until it goes to the operating system, before this function will work.*

PM Events

PM events are I/O events whose occurrence can prevent the system from entering a power saving mode or can awaken the system from such a mode. In effect, the system remains alert for anything, which occurs to a device, which is configured as *Enabled*, even when the system is in a power down mode.

Primary IDE 0/1

Secondary IDE 0/1

FDD, COM, LPT Port

PCI PIRQ [A-D]#

2.7 PnP/PCI Configurations

This section describes configuring the PCI bus system. PCI, or Personal Computer Interconnect, is a system which allows I/O devices to operate at speeds nearing the speed the CPU itself uses when communicating with its own special components. This section covers some very technical items and it is strongly recommended that only experienced users should make any changes to the default settings.

■ Figure 7. PnP/PCI Configurations

CMOS Setup Utility-Copyright (C) 1984-2000 Award Software
Pnp/PCI Configurations

Reset Configuration Data	Disabled	Item Help
Resources Controlled By	Auto (ESCD)	Menu Level ►
X IRQ Resources	Press Enter	
X Memory Resources	Press Enter	
PCI/VGA Palette Snoop	Disabled	
		Default is Disabled. Select Enabled to reset Extended System Configuration Data (ESCD) when you exit Setup if you have installed a new add-on and the system reconfiguration has caused such a serious conflict that the OS cannot boot.

↑ ↓ → ← : Move Enter :Select +/-/PU/PD :Value F10 :Save ESC :Exit F1 :General Help
 F5 :Previous Values F6 :Fail-Safe Defaults F7 : Optimized Defaults

Reset Configuration Data

The system BIOS supports the PnP feature so the system needs to record which resource is assigned and proceeds resources from conflict. Every peripheral device has a node, which is called ESCD. This node records which resources are assigned to it. The system needs to record and update ESCD to the memory locations. These locations (4K) are reserved at the system BIOS.

If Disabled (default) is chosen, the system's ESCD will update only when the new configuration varies from the last one.

If Enabled is chosen, the system is forced to update ESCDs and then is automatically set to the "Disabled" mode.

IRQ-3	assigned to: PCI / ISA PnP
IRQ-4	assigned to: PCI / ISA PnP
IRQ-5	assigned to: PCI / ISA PnP
IRQ-7	assigned to: PCI / ISA PnP
IRQ-9	assigned to: PCI / ISA PnP
IRQ-10	assigned to: PCI / ISA PnP
IRQ-11	assigned to: PCI / ISA PnP
IRQ-12	assigned to: PCI / ISA PnP
IRQ-14	assigned to: PCI / ISA PnP
IRQ-15	assigned to: PCI / ISA PnP
DMA-0	assigned to: PCI / ISA PnP
DMA-1	assigned to: PCI / ISA PnP
DMA-3	assigned to: PCI / ISA PnP
DMA-5	assigned to: PCI / ISA PnP
DMA-6	assigned to: PCI / ISA PnP
DMA-7	assigned to: PCI / ISA PnP

The above settings will be shown on the screen only if "Manual" is chosen for the Resources Controlled By function.

Legacy is the term, which signifies that a resource is assigned to the ISA Bus and provides for non-PnP ISA add-on cards. PCI / ISA PnP signifies that a resource is assigned to the PCI Bus or provides for ISA PnP add-on cards and peripherals.

Resources Controlled By

By Choosing "Auto" the system BIOS will detect the system resources and automatically assign the relative IRQ and DMA channel for each peripheral.

By Choosing "Manual", the user will need to assign IRQ & DMA for add-on cards. Be sure that there are no IRQ/DMA and I/O port conflicts.

IRQ Resources

When resources are controlled manually, assign each system interrupt a type,

depending on the type of device using the interrupt.

Memory Resources

This sub menu can let you control the memory resource.

PCI / VGA Palette Snoop

Choose Disabled or Enabled. Some graphic controllers which are not VGA compatible take the output from a VGA controller and map it to their display as a way to provide boot information and VGA compatibility.

However, the color information coming from the VGA controller is drawn from the palette table inside the VGA controller to generate the proper colors, and the graphic controller needs to know what is in the palette of the VGA controller. To do this, the non-VGA graphic controller watches for the Write access to the VGA palette and registers the snoop data. In PCI based systems, where the VGA controller is on the PCI bus and a non-VGA graphic controller is on an ISA bus, the Write Access to the palette will not show up on the ISA bus if the PCI VGA controller responds to the Write.

In this case, the PCI VGA controller should not respond to the Write, it should only snoop the data and permit the access to be forwarded to the ISA bus. The non-VGA ISA graphic controller can then snoop the data on the ISA bus. Unless you have the above situation, you should disable this option.

Disabled (default)	Disables the function.
Enabled	Enables the function.

2.8 Frequency Control

■ Figure 8. Frequency/Voltage Control

CMOS Setup Utility-Copyright (C) 1984-2000 Award Software
Frequency/ Voltage Control

CPU Host/ PCI Clock	Default	Item Help
CPU Ratio	X 3	Menu Level ▶

↑ ↓ → ← : Move Enter :Select +/-/PU/PD :Value F10 :Save ESC :Exit F1 :General Help
 F5 :Previous Values F6 :Fail-Safe Defaults F7 : Optimized Defaults

CPU Host/PCI Clock

The item allows you select CPU Host/PCI clock.

CPU Ratio

This item allows you to select the CPU ratio.

2.9 M/B Diagnosis (Optional)

■ Figure 9. M/B Diagnosis

CMOS Setup Utility-Copyright (C) 1984-2000 Award Software
M/B Diagnosis

CPU Function Test	Press Enter	Item Help
Memory Test	Press Enter	Menu Level ►
FDC Test	Press Enter	
PnP/PCI Device	Press Enter	

↑ ↓ → ← : Move Enter :Select +/-/PU/PD :Value F10 :Save ESC :Exit F1 :General Help
 F5 :Previous Values F6 :Fail-Safe Defaults F7 : Optimized Defaults

CPU Function Test

This item allows you to test CPU basic function

Memory Test

This item allows you to test RAM.

FDC Test

The item allows you to test floppy controller.

PnP/PCI Device

The item allows you to check the PnP/PCI device.

2.10 Load Fail-Safe Defaults

When you press <Enter> on this item you get a confirmation dialog box with a message similar to:

■ **Figure 10. Load Fail-Safe Defaults**

CMOS Setup Utility-Copyright (C) 1984-2000 Award Software

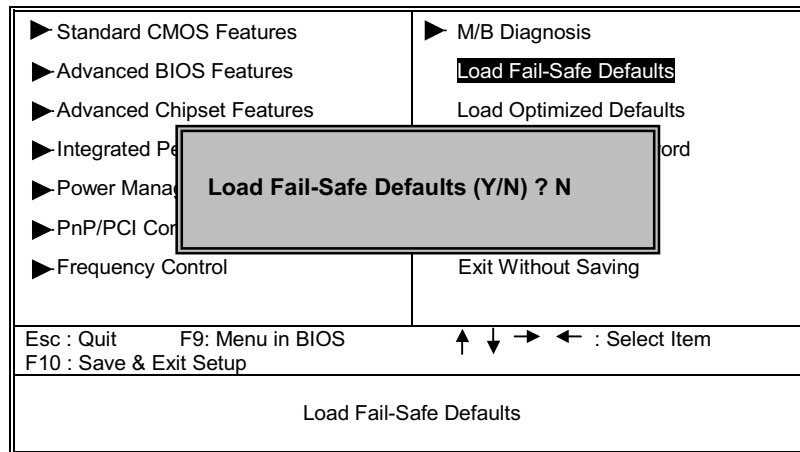

Pressing 'Y' loads the BIOS default values for the most stable, minimal-performance system operations.

2.11 Load Optimized Defaults

When you press <Enter> on this item you get a confirmation dialog box with a message similar to:

■ Figure 11. Load Optimized Defaults

CMOS Setup Utility-Copyright (C) 1984-2000 Award Software

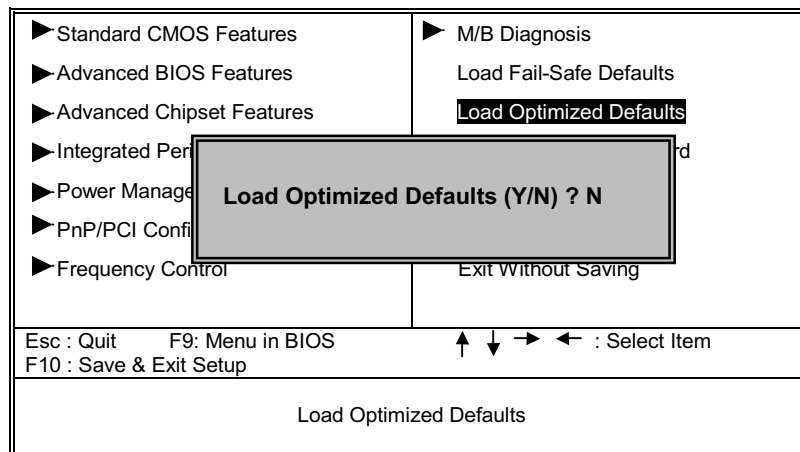

Pressing 'Y' loads the default values that are factory settings for optimal performance system operations.

2.12 Set Supervisor/User Password

■ Figure 12. Set Supervisor/User Password

CMOS Setup Utility-Copyright (C) 1984-2000 Award Software

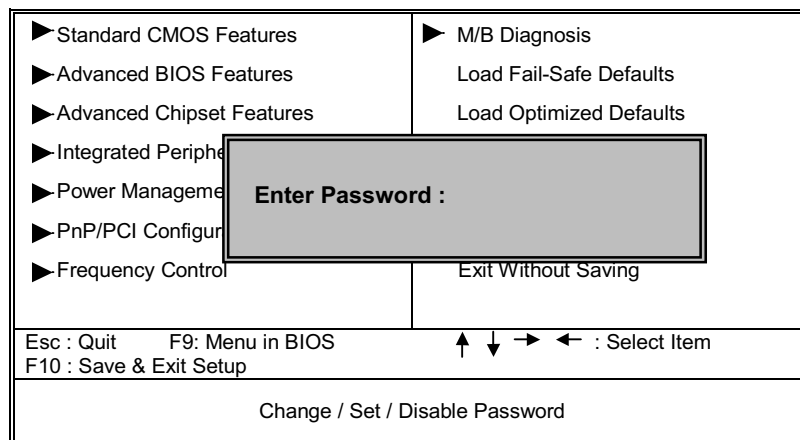

When you select this function, the following message will appear at the center of the screen to assist you in creating a password.

ENTER PASSWORD

Type the password, up to eight characters, and press <Enter>. The password you type now will clear any previously entered password from CMOS memory. You will be asked to confirm the password. Type the password again and press <Enter>. You may also press <ESC> to abort the selection and not enter a password. To disable password, just press <Enter> when you are prompted to enter password. A message will confirm that you wish to disable the password. Once the password is disabled, the system will boot and you can enter setup freely.

PASSWORD DISABLED

If you select "System" at the Security Option of BIOS Features Setup Menu, you will be prompted for the password every time the system is rebooted or any time you try to enter Setup. If you select "Setup" at Security Option of BIOS Feature Setup Menu, you will be prompted only when you try to enter Setup.

2.13 Save & Exit Setup

■ Figure 13. Save & Exit Setup

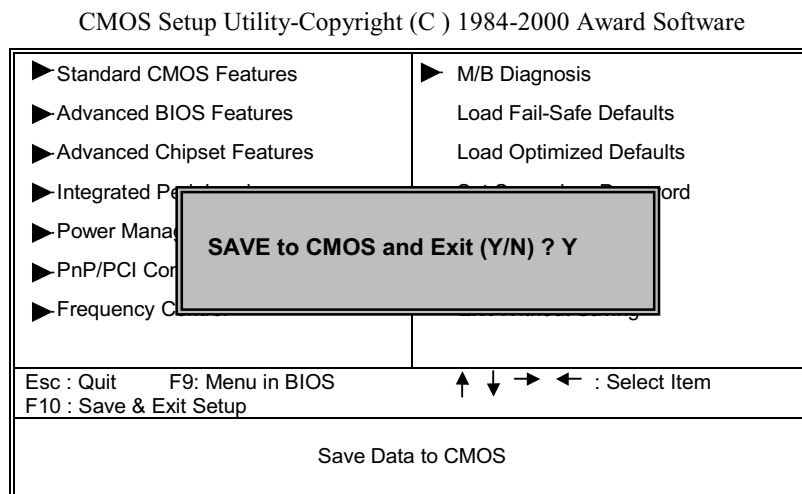

Type "Y" will quit the Setup Utility and save the user setup value to RTC CMOS RAM.
Type "N" will return to Setup Utility.

2.14 Exit Without Saving

■ Figure 14. Exit Without Saving

CMOS Setup Utility-Copyright (C) 1984-2000 Award Software

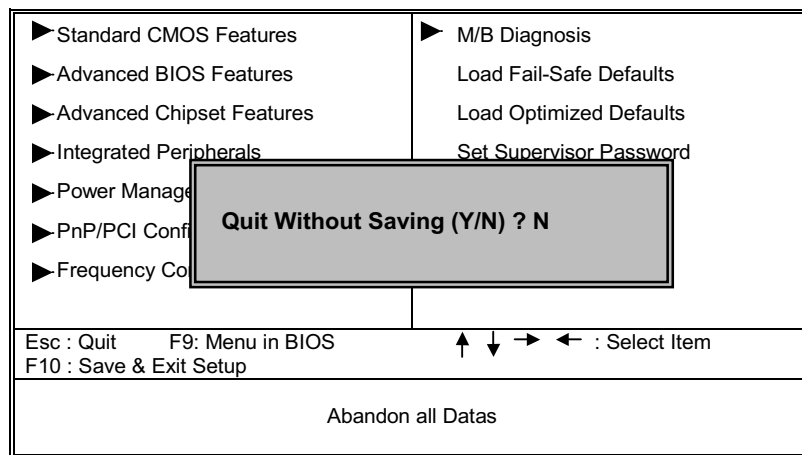

Type "Y" will quit the Setup Utility without saving to RTC CMOS RAM.
Type "N" will return to Setup Utility.

3. Software

3.1 Software List

Category	Description	Platform
Windows 9x Inf Patch Utility Driver	The INF Update Utility for Intel Chipsets installs to the target system the Windows* 95 or Windows* 98 INF files that outline to the operating system how the chipset components shall be configured.	Windows 95/98
HighPoint XStore Pro	Drivers that support Ultra DMA mode Hard Drive.	Windows 95/98
Award Flash Utility	Used for updating BIOS. (Please refer to chapter - Application Software.)	Need to be run under DOS environment.
Intel 810 Chipset Graphics	Drivers and Control Panel Utility for Intel 810 Chipset Graphics.	Windows 95/98/NT4.0/2000
SoundMax Integrated Digital Audio (Optional)	Drivers for AC97 Audio.	Windows 95/98/NT4.0/2000
Aureal Vortex AU8810 PCI Audio(Optional)	Drivers for AC97 Audio	Windows 95/98
Microsoft DirectX	Microsoft DirectX runtime library	Windows 95/98

3.2 Software Installation

We provide a Wizard with User Interface, Driver CD Installation Utility (START.EXE), located in the root of Driver CD to let you install drivers conveniently.

The Wizard can automatically detect OS and switch to the proper page, so you don't need to worry about installing the wrong drivers.

You can simply put Driver CD into CD-ROM drive and the Installation Utility will autorun or you can launch the Driver CD Installation Utility manually.



There are two kinds of Installation Procedure:

- **Automatically Install drivers from CD by using CD Installation Utility:**

Use mouse cursor to click the proper option on the page. Utility will invoke other applications to complete the rest of installation.

- **When the drivers CAN NOT be installed directly from CD by using CD Installation Utility, please do the following procedure :**

Please read the README.TXT located in the root directory on Multimedia CD to get drivers' location and then refer to the INSTALL.TXT or README.TXT files located in each driver directory on the Driver CD to install drivers.

3.3 Software Usage

- **Note:** In general, you can get more detailed information in the on-line help or readme for the softwares.

- **Using Intel 810 Chipset Graphics Control Panel Utility:**

Note: Move the mouse cursor to the background of screen and right-click the mouse and then **Display Properties dialog** will pop-up.

- ✧ Select **Color** properties sheet in the Display Properties dialog, you can do Gamma Correction of Red, Green and Blue Color Channels in this page.

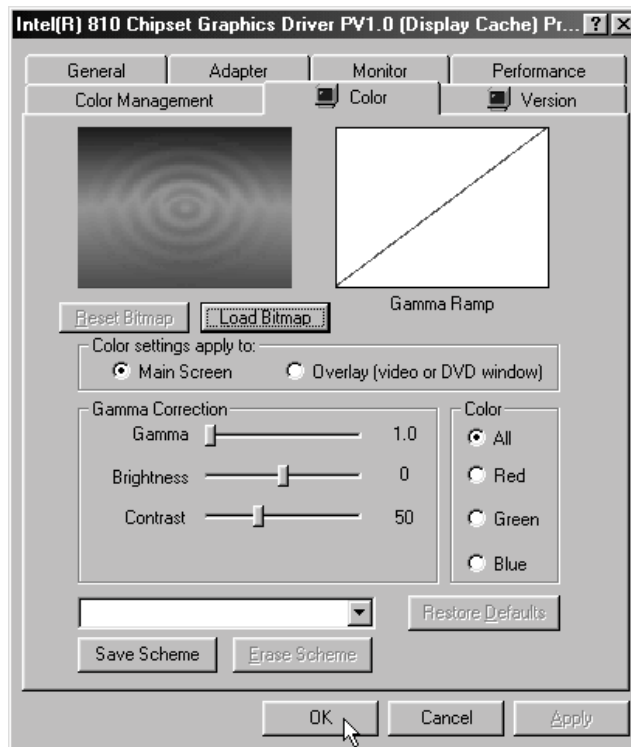

- ✧ Select **Version** property sheet in the Display Properties dialog, you can get the display driver information, VGA BIOS information, Memory Size and DirectX version.

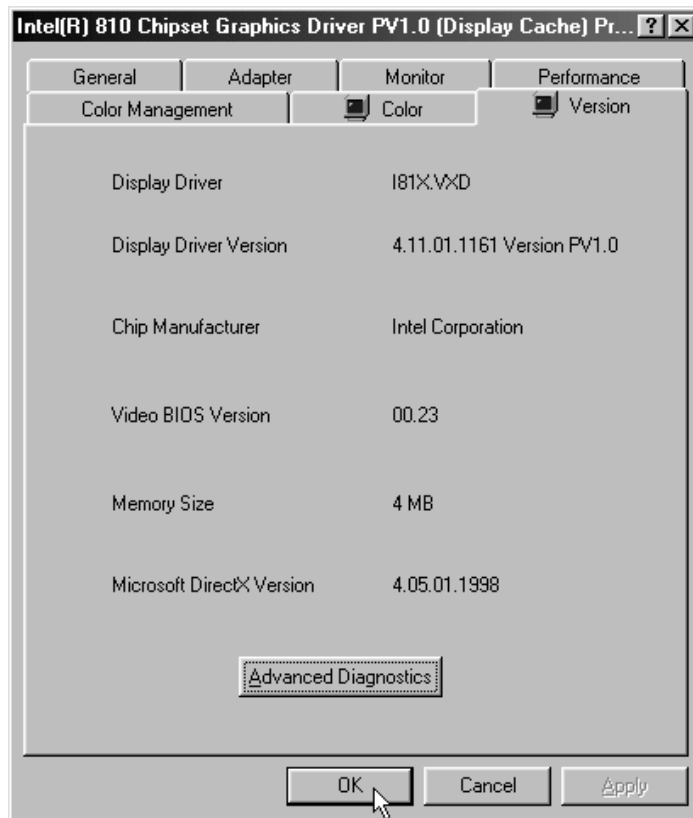

- ✧ In the above page, click the **Advanced Diagnostics** button and then **Intel® Graphics Diagnostic Utility** will be launched.

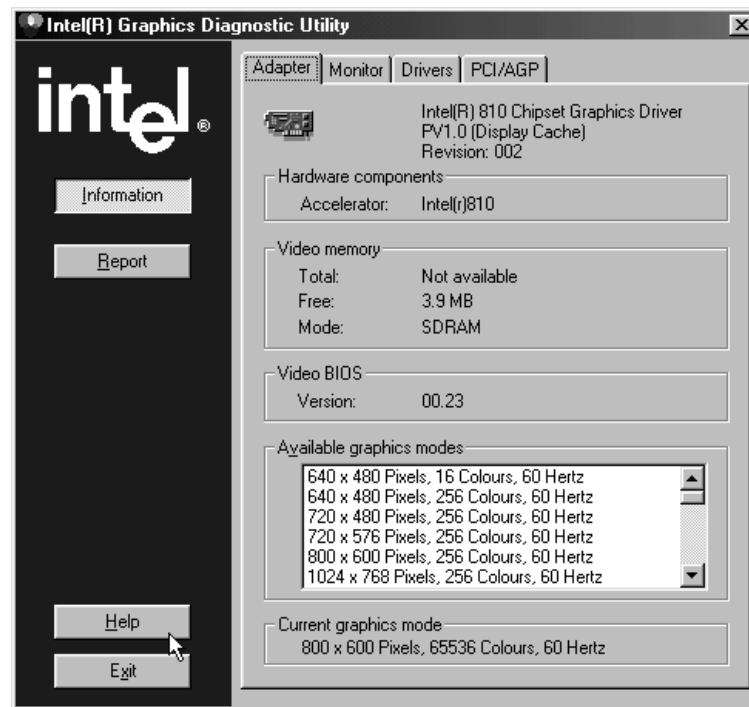

The Intel® Graphics Diagnostic Utility was developed to give you a single source for collecting information about the graphics setup of your computer.

The interface allows you easily to create a report of the graphics setup of your computer, which you can use in troubleshooting technical issues with the system or send to customer support.

For assistance in using the diagnostic utility, click the Help button at the bottom of the blue left-hand column.

➤ **Using Areal Vortex AU8810 PCI Windows 95/98 Audio Control Panel: (Optional: Visible only when the Areal Vortex AU8810 PCI Audio chipset included in your hardware.)**

❖ Launch the Control Panel:

1. Double-click the **Areal Vortex** icon on the Windows taskbar.



2. Or, you can double-click the **Areal Vortex Audio** icon in the Control Panel window.

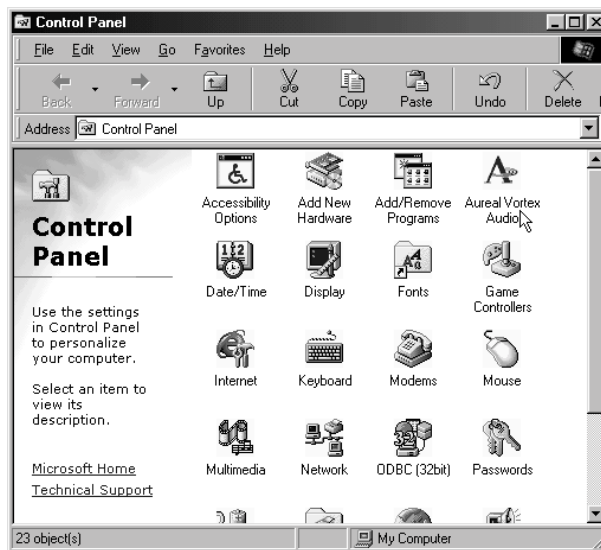

❖ Aural Vortex Control Panel Tab:

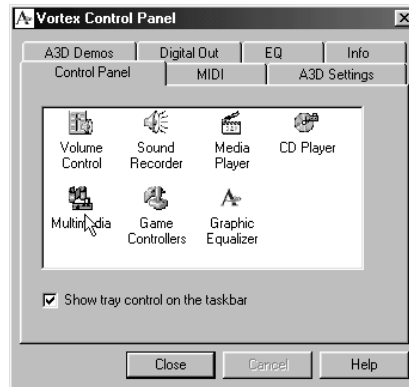
**Other Control Panels**

This window lets you access other sound-related control panels and system applets, such as Volume Control and Sound Recorder.

The Graphic Equalizer applet provides control for a multi band graphic equalizer.

Show Tray Control in the Taskbar

When Tray Control is shown, clicking on the Aural logo in the taskbar can open the Vortex Control Panel. The taskbar icon can be removed using this checkbox.

Taskbar Menu

Right-click on the Aural logo in the Windows taskbar to see the tray control menu.

Headphones/Speakers - Select between headphone and speaker output using the two top options. This setting only affects output from applications using Aural's A3D Interactive positional audio technology.

Adjust Audio Properties - Selecting this menu option has the same affect as double-clicking the taskbar icon, launching the Vortex Control Panel applet.

Remove tray control - This removes the icon from the taskbar.

❖ Aural Vortex MIDI Tab:

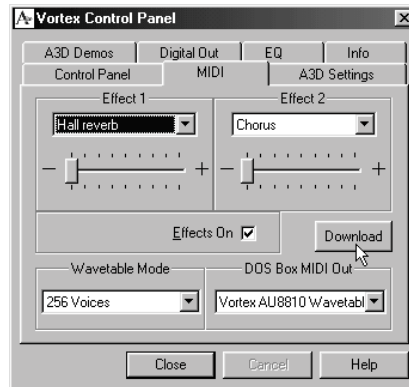
**Destination for DOS Box MIDI Out**

In Windows, this list box selects how MIDI is handled by programs running in DOS boxes. In Windows NT, this list box is not available.

Vortex AU8810 MPU-401 - This sends MIDI to an external synthesizer attached to the MIDI port.

Vortex AU8810 Wavetable - This sends MIDI to the Vortex music synthesizer.

If you do not have an external synthesizer connected, select "Vortex AU8810 Wavetable."

Physical Modeling

This feature is not enabled in this version of the software.

Wavetable Mode

Use this list box to select the total number of wavetable voices made available for internal wavetable processing. More voices require more CPU power. This option has no effect on a MIDI stream that is sent out the MPU-401 port.

Wavetable Effects

When some MIDI songs start, they request particular amounts of effects in the sound, such as chorus and reverb. There are nine possible effects to choose from: Delay, Room reverb, Chamber reverb, Hall reverb, Cabinet, Chorus, Flange, Distortion, and Wah-Wah. The same effect can not be selected twice.

Effects Checkbox - You can disable wavetable effects with this checkbox. If effects are disabled, no effects are heard, even if songs request it. This checkbox overrides the slider settings.

Effect 1 and Effect 2 Sliders - These sliders increase the amount of effects over the levels set by the MIDI file using controllers 91 and 93 respectively. You can change these settings while a song is playing. A zero setting selects the same amount of effect as set in the song. Moving the sliders up increases the effects level until the effect reaches its maximum possible level. If the song sets the maximum possible effect levels, the sliders have no effect.

Download

This button opens a file browser for selecting an alternate instrument set. Press "Open" to download the instruments to the wavetable. The wavetable file must be in DLS format.

After downloading, the new instruments are used instead of the previous instruments. To reload the factory presets, download the file "au10gm.arl" located in the System folder of your Windows directory.

- ❖ **Aureal Vortex A3D Settings Tab:**
This tab is only visible if your computer supports A3D Interactive real-time positional audio.

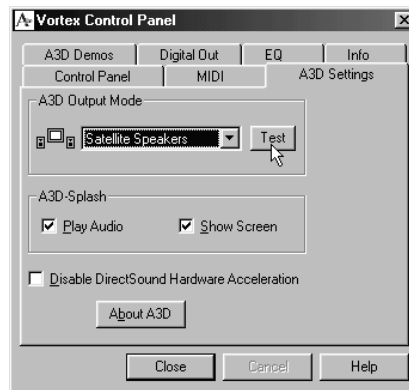

A3D Output Mode

Select between speaker and headphone output in the list box. This setting only affects output from applications using Aureal's A3D Interactive positional audio technology.

A3D Splash

By default, when an A3D-enabled application starts up, the A3D audio signature plays and the A3D logo displays. You can deactivate the audio signature and A3D logo at startup using these checkboxes. (Do not change the splash settings while an A3D application is open.)

About A3D

Click on this button for more information on Aureal's A3D Technology.

Disable DirectSound Hardware Accelerator

Some games using DirectSound do not check the hardware resources correctly. If no sound is audible, you can disable hardware acceleration of DirectSound with this checkbox. Applications will then use the generic, slower and lower-quality software DirectSound drivers supplied within DirectX5.0.

- ❖ Aureal Vortex A3D Demos Tab:

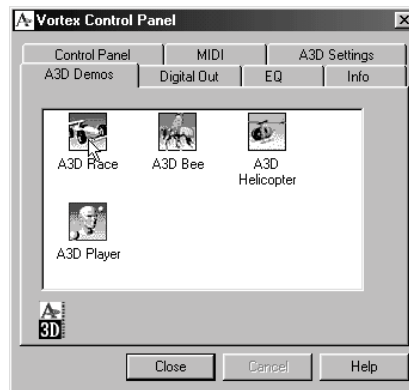

A3D Demos

Click on the icons in this window to launch A3D demo programs.

- ❖ Aureal Vortex Digital Out Tab:

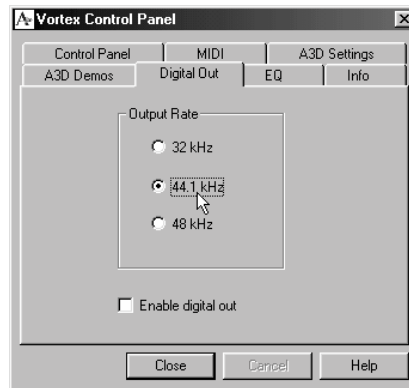

Output Rate

This window allows you to select the sample rate of the S/PDIF output port. When you select a new sample rate, the S/PDIF port uses the new rate

immediately.

❖ Aureal Vortex EQ Tab:

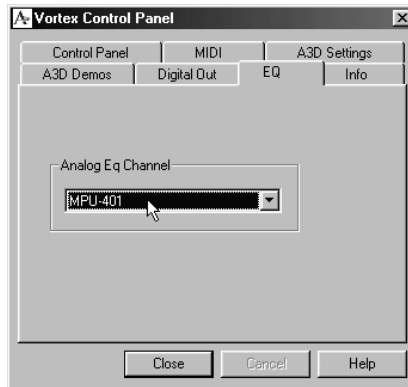

Analog Eq Channel

Use this control to select the analog input source for which Tone Controls will be applied.

❖ Aureal Vortex Info Tab:



Vortex Information

This tab provides information about the Vortex hardware and software capabilities in your system.

4. Trouble shooting

PROBLEM

No power to the system at all. Power light does not illuminate, fan inside power supply does not turn on. Indicator light on keyboard does not turn on.

PROBABLE CAUSE	DIAGNOSIS	SOLUTION
Power cable is unplugged.	Visually inspect power cable.	Make sure power cable is securely plugged in.
Defective power cable.	Visually inspect the cable; try another cable.	Replace cable.
Power supply failure.	Power cable and wall socket are OK, but system is still dead.	Contact technical support.
Faulty wall outlet; circuit Breaker or fuse blown.	Plug in device known to work in socket and test.	Use different socket, repair outlet, reset circuit breaker, or replace fuse.

PROBLEM

System inoperative. Keyboard lights are on, power indicator lights are lit, hard drive is spinning.

PROBABLE CAUSE	DIAGNOSIS	SOLUTION
Memory DIMM is partially dislodged from the slot on the motherboard.	Turn off computer. Take cover off system unit. Check the DIMM to ensure it is securely seated in the slots.	Using even pressure on both ends of the DIMM, press down firmly until the module snaps into place.

PROBLEM

System does not boot from hard disk drive, can be booted from CD ROM drive.

PROBABLE CAUSE	DIAGNOSIS	SOLUTION
Connector between hard drive and system board unplugged.	When attempting to run the FDISK utility you get a message, INVALID DRIVE SPECIFICATION.	Check cable running from disk to disk controller board. Make sure both ends are securely plugged in; check the drive type in the standard CMOS setup.
Damaged hard disk or disk controller.	Format hard disk; if unable to do so the hard disk may be defective.	Contact technical support.
Hard Disk directory or FAT is scrambled.	Run the FDISK program, format the hard drive (see HARD DRIVE section of manual). Copy data that was backed up onto Hard Drive.	Backing up the hard drive is extremely important. All Hard Disk are capable of breaking down at any time.

PROBLEM

System only boots from CD-ROM. Hard disk can be read and applications can be used but booting from hard disk is impossible.

PROBABLE CAUSE	DIAGNOSIS	SOLUTION
Hard disk boot program has been destroyed.	A number of causes could be behind this.	Back up data and applications files. Reformat the hard drive . Re-install applications and data using backup disks.

PROBLEM

Error message reading “SECTOR NOT FOUND” or other error messages not allowing certain data to be retrieved.

PROBABLE CAUSE	DIAGNOSIS	SOLUTION
A number of causes could be behind this.	Use a file by file backup instead of an image backup to backup the hard disk.	Back up any salvageable data. Then low level format, partition, and high level format the hard drive (see Hard Disk section of this manual for instructions). Re-install all saved data when completed.

PROBLEM

Screen message says “Invalid Configuration” or “CMOS Failure.”

PROBABLE CAUSE	DIAGNOSIS	SOLUTION
Incorrect information entered into the configuration (setup) program.	Check the configuration program. Replace any incorrect information.	Review system’s equipment . Make sure correct information is in setup.

PROBLEM

Screen is blank.

PROBABLE CAUSE	DIAGNOSIS	SOLUTION
No power to monitor.		Check the power connectors to monitor and to system. Make sure monitor is connected to display card.
Monitor not connected to computer.		See instructions above.

PROBLEM

PROBABLE CAUSE	DIAGNOSIS	SOLUTION
Memory problem.		Reboot computer. Reinstall memory, make sure that all memory modules are installed in correct sockets.
Computer virus.		Use anti-virus programs to detect and clean viruses.

PROBLEM

Screen goes blank periodically.

PROBABLE CAUSE	DIAGNOSIS	SOLUTION
Screen saver is enabled.		Disable screen saver.

PROBLEM

Keyboard failure.

PROBABLE CAUSE	DIAGNOSIS	SOLUTION
Keyboard is disconnected.		Reconnect keyboard. Check keys again, if no improvement replace keyboard.

PROBLEM

No color on screen.

PROBABLE CAUSE	DIAGNOSIS	SOLUTION
Faulty Monitor.		If possible, connect monitor to another system. If no color replace monitor.
CMOS incorrectly set up.		Call technical support.

PROBLEM

C: drive failure.

PROBABLE CAUSE	DIAGNOSIS	SOLUTION
Hard drive cable not connected properly.		Check hard drive cable.

PROBLEM

Cannot boot system after installing second hard drive.

PROBABLE CAUSE	DIAGNOSIS	SOLUTION
Master/slave jumpers not set correctly.		Set master/slave jumpers correctly.
Hard drives not compatible / different manufacturers.		Run SETUP program and select correct drive types. Call Drive manufacturers for compatibility with other drives.

PROBLEM

Missing operating system on hard drive.

PROBABLE CAUSE	DIAGNOSIS	SOLUTION
CMOS setup has been changed.		Run setup and select correct drive type.

PROBLEM

Certain keys do not function.

PROBABLE CAUSE	DIAGNOSIS	SOLUTION
Keys jammed or defective.		Replace keyboard.

PROBLEM

Keyboard is locked, no keys function.

PROBABLE CAUSE	DIAGNOSIS	SOLUTION
Keyboard is locked.		Unlock keyboard.

10/31/2000
MADE IN TAIWAN
R.O.C